

Quick reference guide
Kurzanleitung
Guide de référence rapide
Beknopte bedieningsgids
Guida di riferimento rapido
Guía de referencia rápida
Краткий справочник
Guia de referência rápida

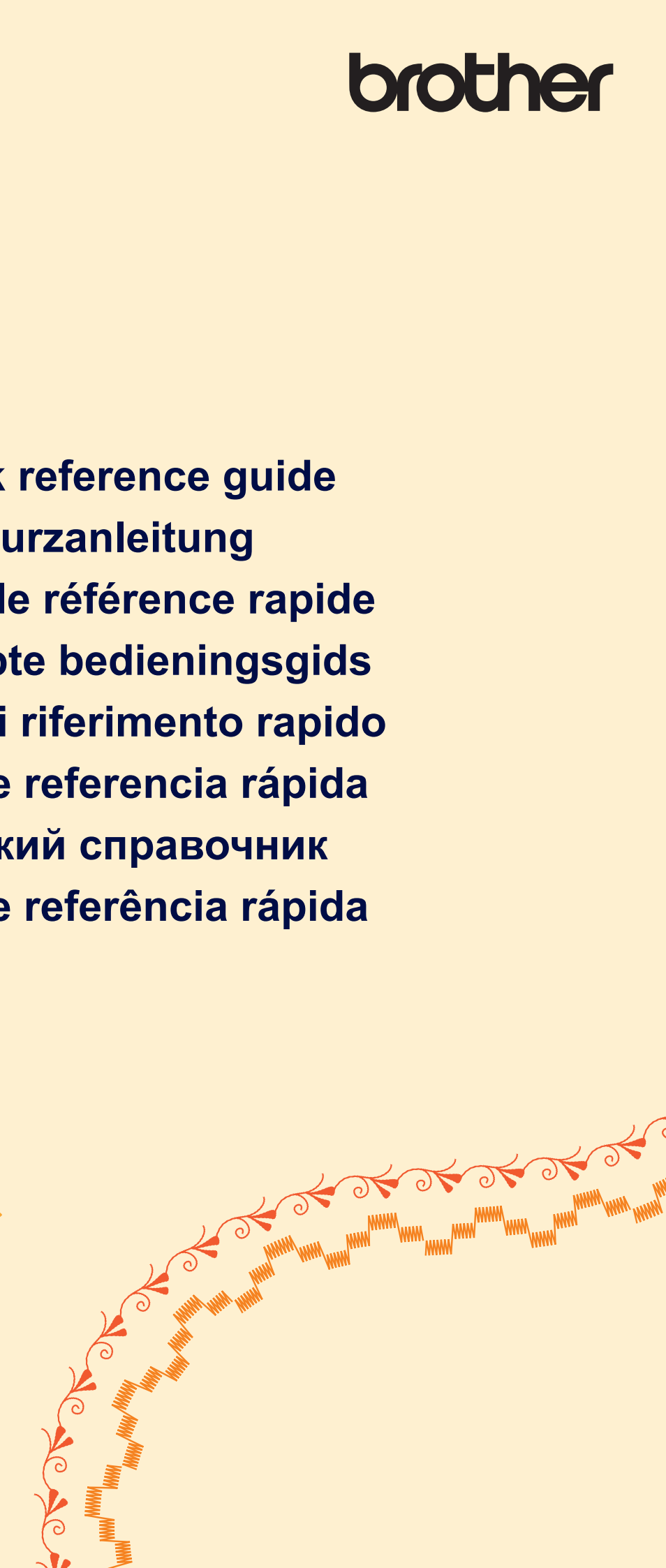

Refer to the operation manual for detailed instruction.

The screen display and machine illustration may vary slightly, depending on the countries or regions. Also, there are differences in the keys and screens depending on the display language. In this guide, English screens are used for basic explanations.

Einzelheiten entnehmen Sie bitte der Bedienungsanleitung.

Die Bildschirmanzeige und Maschinenabbildungen können je nach Land oder Region etwas variieren. Je nachdem, welche Sprache für die Bildschirmanzeigen gewählt wurde, ergeben sich im Hinblick auf Bildschirmbilder eventuell Unterschiede. Die grundlegende Bedienung der Maschine ist in dieser Anleitung am Beispiel von Bildschirmbildern mit englischem Text erklärt.

Pour les instructions détaillées, voir le mode d'emploi.

Les écrans et illustrations de la machine peuvent varier légèrement, en fonction du pays ou de la région. Par ailleurs, il y a des différences dans les touches et les écrans en fonction de la langue d'affichage. Dans ce guide, les explications de base utilisent les écrans anglais.

Zie de gebruiksaanwijzing voor gedetailleerde instructies.

De display en machine-illustratie kunnen iets afwijken naargelang het land of de regio. Er zijn verschillen in de toetsen en schermen afhankelijk van de ingestelde taal. In de beschrijvingen in deze beknopte handleiding worden de Engelse schermen gebruikt.

Fare riferimento al manuale di impiego per istruzioni dettagliate.

Le schermate e l'illustrazione della macchina possono variare a seconda dei paesi o delle regioni. Inoltre, ci sono differenze nei tasti e nelle schermate a seconda della lingua visualizzata. In questa guida, le schermate in inglese sono usate per le spiegazioni basilari.

Consulte el manual de instrucciones para ver más detalles.

La pantalla y la imagen de la máquina puede variar ligeramente, según los países o regiones. Además, dependiendo del idioma visualizado algunos botones y pantallas podrán ser diferentes. En esta guía, para las explicaciones básicas se emplean pantallas en inglés.

Более подробная информация представлена в руководстве по эксплуатации.

Снимки экранов и изображения машины могут немного различаться в зависимости от стран и регионов приобретения.

Кроме того, в зависимости от языка сообщений на ЖК-дисплее названия кнопок и другая информация на экранах могут иметь некоторые различия. В настоящем справочнике основные пояснения даются на примере экранов с информацией на английском языке.

Consulte o manual de operações para saber as instruções detalhadas.

A exibição na tela e a ilustração da máquina podem apresentar pequenas diferenças, dependendo do país ou região.

Além disso, há diferenças nas teclas e telas dependendo do idioma de exibição.

Neste guia, as telas em inglês são usadas para as explicações básicas.

<English display>
<Englische Anzeige>
<Affichage en anglais>
<Engels scherm>
<Schermata in inglese>
<Visualización en inglés>
<Экран: английский язык>
<Display em inglês>

<Example: German>
<Beispiel: Deutsch>
<Exemple : allemand>
<Voorbeeld: Duits>
<Esempio: Tedesco>
<Ejemplo: Alemán>
<Пример: немецкий язык>
<Exemplo: alemão>

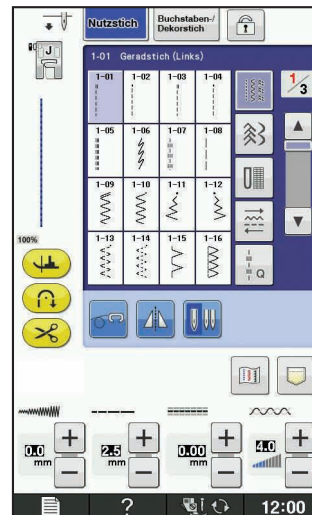
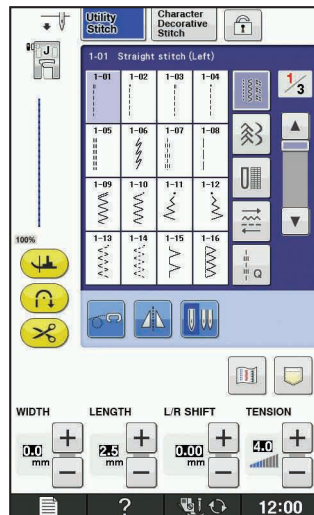

Contents

| | |
|----------------------------------|----|
| Winding the Bobbin | 2 |
| Setting the Bobbin | 4 |
| Upper Threading | 5 |
| Selecting Stitch Patterns | 6 |
| Summary of Stitch Patterns | 10 |

Table des matières

| | |
|---------------------------------------------|----|
| Bobinage de la canette | 2 |
| Mise en place de la canette | 4 |
| Enfilage supérieur | 5 |
| Sélection des configurations de point | 6 |
| Sommaire des motifs de point | 10 |

Sommario

| | |
|------------------------------------|----|
| Avvolgimento della spolina | 2 |
| Impostazione della spolina | 4 |
| Infilatura superiore | 5 |
| Selezione degli schemi punto | 6 |
| Sommario degli schemi punto | 10 |

Содержание

| | |
|-----------------------------|----|
| Намотка шпульки | 2 |
| Установка шпульки | 4 |
| Заправка верхней нити | 5 |
| Выбор строчки | 6 |
| Виды строчек | 10 |

Inhalt

| | |
|---------------------------------|----|
| Aufspulen des Unterfadens | 2 |
| Einsetzen der Spule | 4 |
| Einfädeln des Oberfadens | 5 |
| Wahl des Nähmusters | 6 |
| Nähmuster-Übersicht | 10 |

Inhoudsopgave

| | |
|--------------------------------------|----|
| Spoel opwinden | 2 |
| Aanbrengen van het spoeltje | 4 |
| Inrijgen van de bovendraad | 5 |
| Kiezen van de steekpatronen | 6 |
| Overzicht van de steekpatronen | 10 |

Contenido

| | |
|-------------------------------------|----|
| Devanado de la bobina | 2 |
| Colocación de la bobina | 4 |
| Hilo superior | 5 |
| Selección de tipos de puntada | 6 |
| Resumen de tipos de puntada | 10 |

Índice

| | |
|--------------------------------------|----|
| Enrolando a bobina | 2 |
| Colocando a bobina | 4 |
| Como passar a linha superior | 5 |
| Selecionando padrões de pontos | 6 |
| Resumo de padrões de pontos | 10 |

Winding the Bobbin

Bobinage de la canette

Avvolgimento della spolina

Намотка шпульки

Aufspulen des Unterfadens

Spoel opwinden

Devanado de la bobina

Enrolando a bobina

Follow the numbered steps below in order. Refer to the operation manual for detailed instruction.

Führen Sie die folgenden Schritte in der angegebenen Reihenfolge aus. Ausführliche Hinweise finden Sie in der Bedienungsanleitung.

Suivez les étapes numérotées ci-dessous dans l'ordre. Consultez le manuel d'instructions pour des procédures détaillées.

Voer de genummerde stappen uit in de juiste volgorde. Uitvoerige aanwijzingen vindt u in de bedieningshandleiding.

Seguire i passaggi numerati nell'ordine riportato di seguito. Fare riferimento al manuale d'istruzioni per le istruzioni dettagliate.

Realice los siguientes pasos numerados en el orden indicado. Para obtener instrucciones detalladas, consulte el manual de instrucciones.

Выполните приведенные ниже операции в порядке их нумерации. Более подробная информация представлена в руководстве по эксплуатации.

Siga os passos numerados a seguir em ordem. Consulte o manual de operações para saber as instruções detalhadas.

Use only the enclosed bobbin or bobbins of the same type.

Verwenden Sie nur die im Lieferumfang enthaltene Spule oder Spulen vom selben Typ.

N'utilisez que la canette fournie ou des canettes du même type.

Gebruik alleen de bijgeleverde spoel of spoelen van hetzelfde type.

Utilizzare solo la spolina inclusa o spoline dello stesso tipo.

Utilice sólo la bobina incluida o bobinas del mismo tipo.

Применяйте только прилагаемые к машине шпульки или шпульки того же типа.

Use somente a bobina inclusa ou bobinas do mesmo tipo.

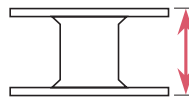

11.5 mm (approx. 7/16 inch)
(ca. 7/16 Zoll)

(env. 7/16 po)

11,5 mm (ca. 7/16 inch)

(circa 7/16 in.)

(aprox. 7/16 pulg.)

(прим. 7/16 дюйма)

(aprox. 7/16 pol.)

◆ Using the Supplemental Spool Pin

You can wind the bobbin during sewing.

◆ Utilisation du porte-bobine supplémentaire

Vous pouvez bobiner la canette pendant la couture.

◆ Utilizzo del portarocchetto supplementare

È possibile avvolgere la spolina durante la cucitura.

◆ Использование дополнительного стержня для катушки

Можно наматывать нить на шпульку во время шитья.

◆ Verwendung des zusätzlichen Garnrollenstifts

Sie können den Unterfaden während des Nähens aufspulen.

◆ Gebruik van de klospen

U kunt de spoel opwinden tijdens het naaien.

◆ Uso del portacarrete suplementario

Puede devanar la bobina mientras está cosiendo.

◆ Usando o pino do carretel complementar

Você pode enrolar a bobina durante a costura.

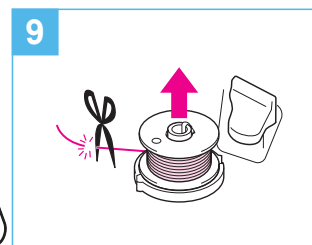
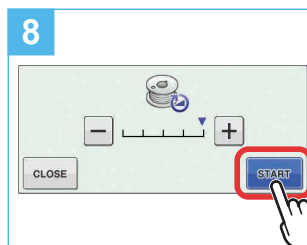
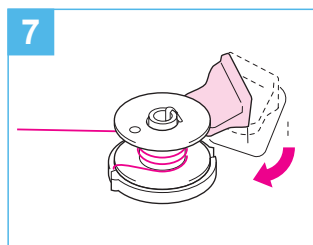
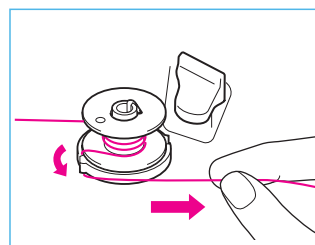
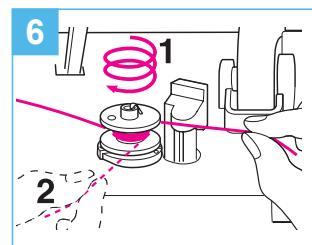
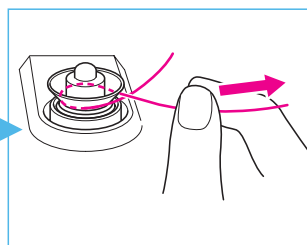
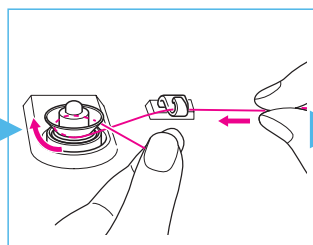
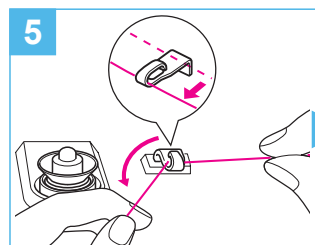
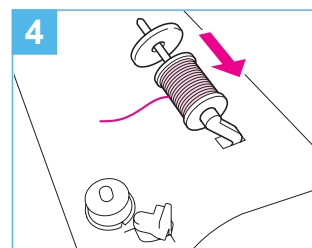
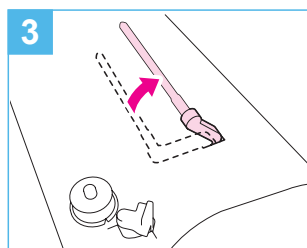
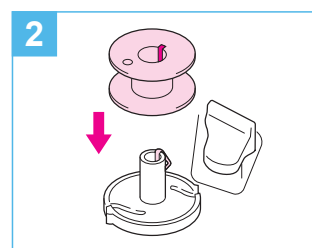
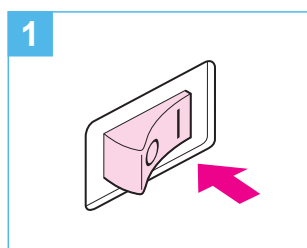
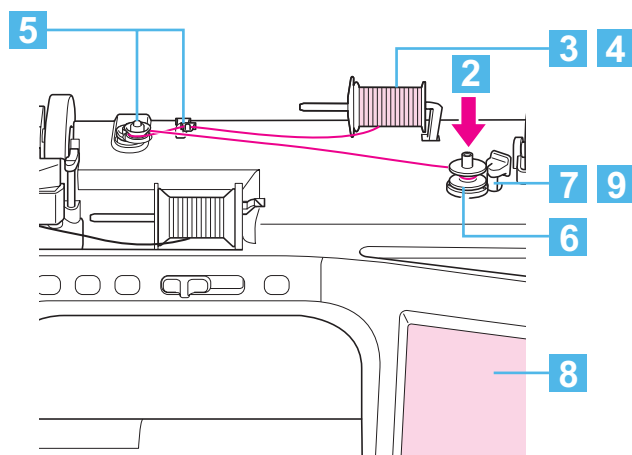

◆ Using the Spool Pin

You can use the main spool pin to wind the bobbin before sewing.

◆ Utilisation du porte-bobine

Vous pouvez bobiner la canette avant de coudre à l'aide du porte-bobine principal.

◆ Utilizzo del portarocchetto

È possibile utilizzare il portarocchetto principale per avvolgere la spolina prima di cucire.

◆ Использование основного стержня для катушки

Для намотки шпульки перед шитьем можно использовать главный стержень для катушки.

◆ Verwendung des Garnrollenstifts

Mit dem Hauptgarnrollenstift können Sie vor dem Nähen den Unterfaden aufspulen.

◆ Gebruik van de kloopen

Voordat u gaat naaien kunt u met de hoofdkloopen de spoel opwinden.

◆ Uso del portacarrete

Puede utilizar el portacarrete principal para devanar la bobina antes de coser.

◆ Usando o pino do carretel

Você pode usar o pino do carretel principal para enrolar a bobina antes de costurar.

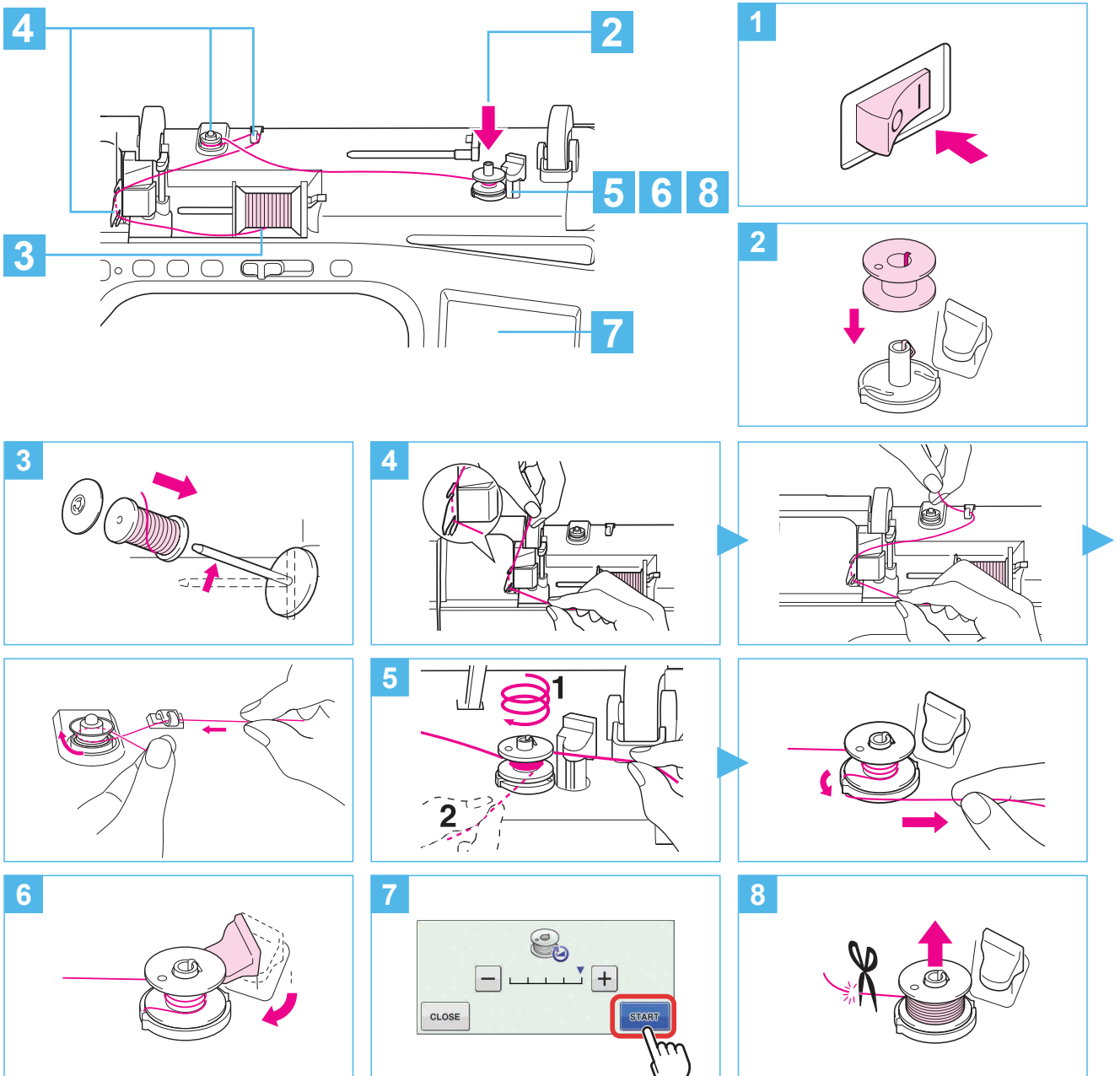

Setting the Bobbin

Mise en place de la canette

Impostazione della spolina

Установка шпульки

Einsetzen der Spule

Aanbrengen van het spoeltje

Colocación de la bobina

Colocando a bobina

Refer to the operation manual for detailed instruction.
Pour les instructions détaillées, voir le mode d'emploi.
Fare riferimento al manuale di impiego per istruzioni dettagliate.
Подробная информация: см. в руководстве по эксплуатации

Einzelheiten hierzu entnehmen Sie bitte der Bedienungsanleitung.
Zie de gebruiksaanwijzing voor gedetailleerde instructies.
Consulte el manual de instrucciones para ver más detalles.
Consulte o manual de operações para saber as instruções detalha-

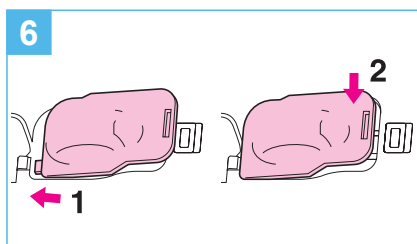
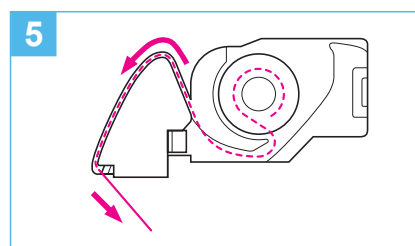
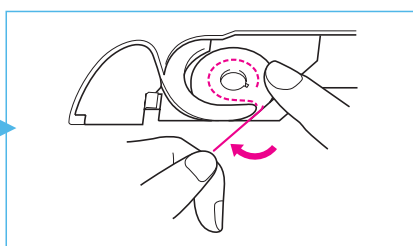
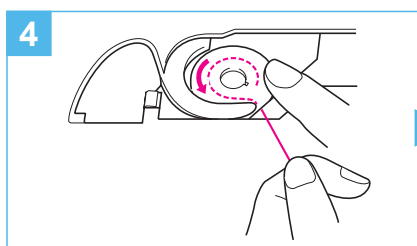
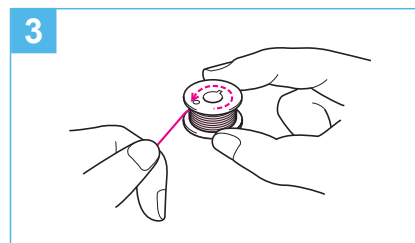
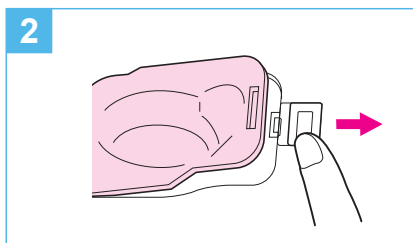

Upper Threading
 Enfilage supérieur
 Infilatura superiore
 Заправка верхней нити

Einfädeln des Oberfadens
 Inrijgen van de bovendraad
 Hilo superior
 Como passar a linha superior

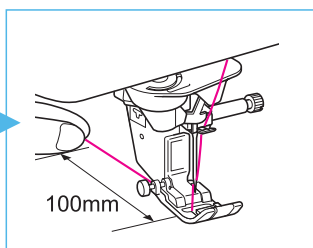
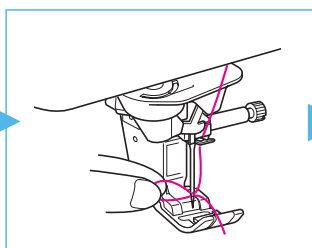
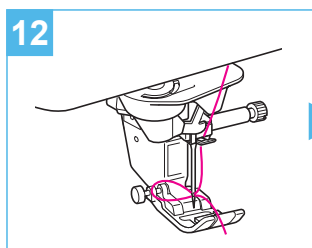
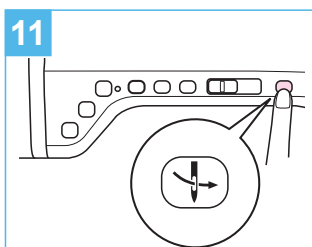
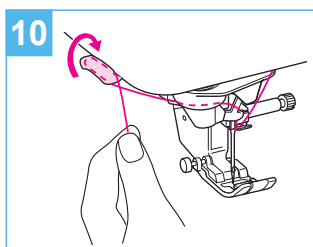
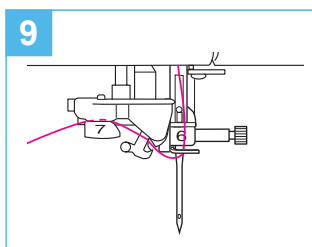
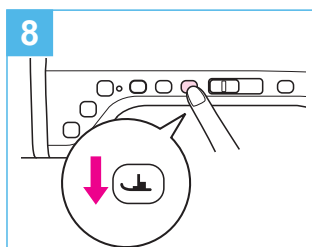
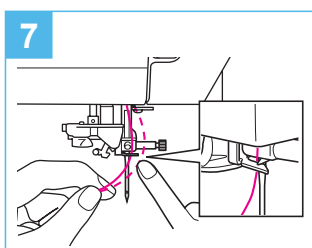
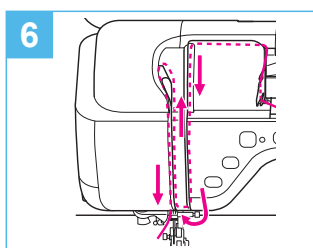
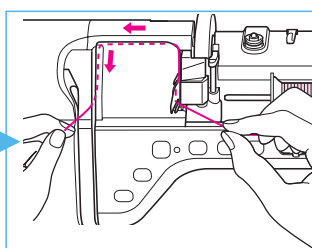
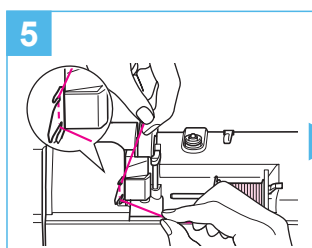
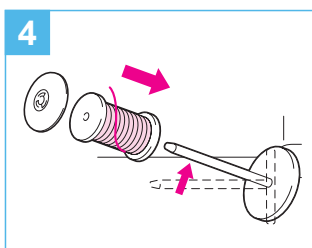
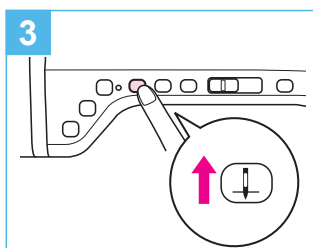
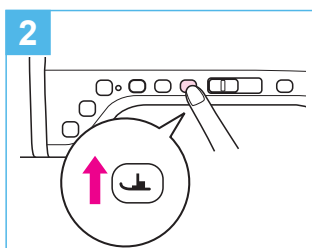
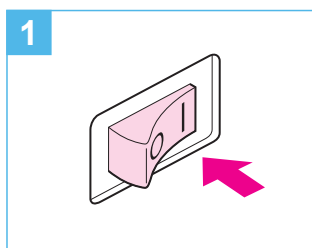
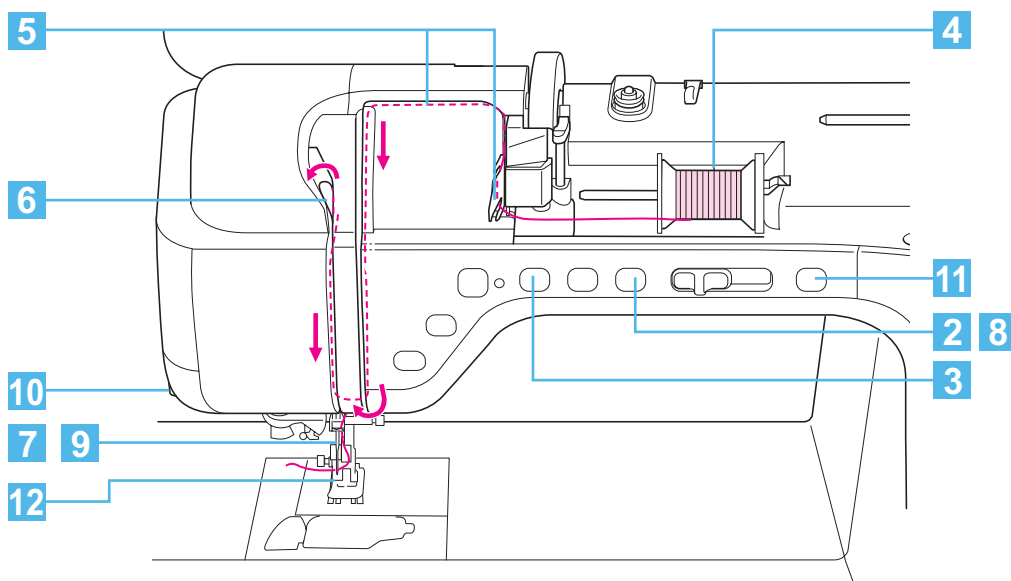

Selecting Stitch Patterns

Sélection des configurations de point
 Selezione degli schemi punto
 Выбор строчки

Wahl des Nähmusters

Kiezen van de steekpatronen
 Selección de tipos de puntada
 Selecionando padrões de pontos

- ◆ LCD Flow Chart
- ◆ Organigramme de l'écran à cristaux liquides
- ◆ Schema di flusso LCD
- ◆ Схема действий на LCD дисплее

- ◆ LCD-Übersichtsdiagramm
- ◆ LCD-stroomschema
- ◆ Diagrama de flujo del LCD
- ◆ Fluxograma do display LCD

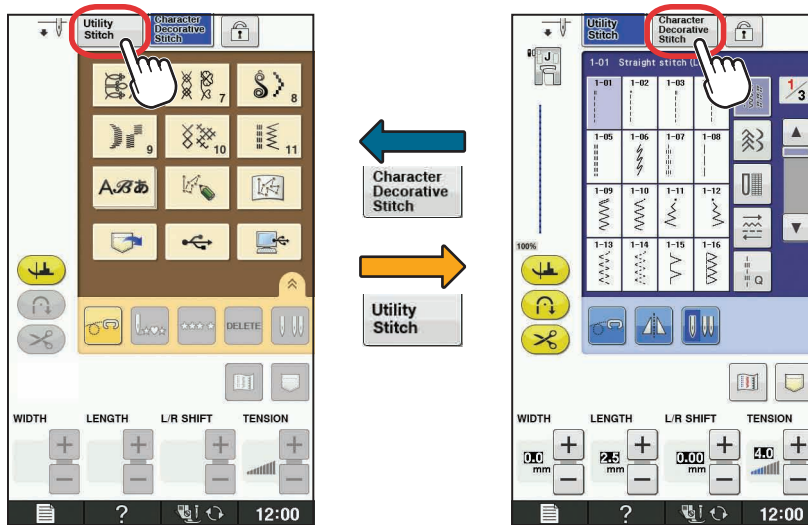

◆ Utility Stitches

When the machine is turned on, the opening movie is played. Touch the screen to display the Utility Stitch selection screen. Either "1-01 Straight stitch (Left)" or "1-03 Straight stitch (Middle)" is selected, depending on the setting selected in the settings screen.

◆ Points utiles

Quand la machine est mise sous tension, la vidéo de démarrage commence. Touchez l'écran pour afficher l'écran de sélection Point utile. Soit « 1-01 Point droit (Gauche) », soit « 1-03 Point droit (Milieu) » est sélectionné, selon le réglage sélectionné sur l'écran de réglage.

◆ Punti utili

All'accensione della macchina, viene riprodotto il filmato di apertura. Toccare lo schermo per visualizzare la schermata di selezione del punto utile. Viene selezionato "1-01 Punto diritto (Sinistra)" o "1-03 Punto diritto (Centro)", a seconda dell'impostazione selezionata nella schermata delle impostazioni.

◆ Основные строчки

После включения машины воспроизводится вступительный видеоролик. Прикоснитесь к экрану, чтобы отобразить экран выбора основной строчки. В зависимости от настройки, выбранной на экране настроек, будет выбрана строчка "1-01: Прямая строчка Игла слева" или "1-03: Прямая строчка Игла по центру".

◆ Nutzstiche

Nach dem Einschalten der Maschine wird der Eingangsfilm angezeigt. Berühren Sie den Bildschirm zur Anzeige des Auswahlbildschirms für den Nutzstich. Je nach Einstellung im Einstellungsbildschirm ist „1-01 Geradstich (Links)“ oder „1-03 Geradstich (Mitte)“ ausgewählt.

◆ Naaisteken

Wanneer u de machine aanzet, wordt de openingsfilm afgespeeld. Raak het scherm aan om het naaistekenoverzicht weer te geven. Afhankelijk van de geselecteerde instelling in het instellingenschermbord wordt ofwel "1-01 Rechte steek (links)" of "1-03 Rechte steek (midden)" geselecteerd.

◆ Puntadas utiles

Quando se activa la máquina, se reproduce el vídeo de presentación. Toque la pantalla para visualizar la pantalla de selección de puntada con aplicaciones. Se seleccionará la "Puntada recta 1-01 (izquierda)" o la "Puntada recta 1-03 (medio)", según el ajuste seleccionado en la pantalla de ajustes.

◆ Pontos utilitários

Quando a máquina estiver ligada, o vídeo de abertura será reproduzido. Toque na tela para exibir a tela de seleção do Ponto Utilitário. Dependendo da configuração selecionada na tela de configurações, estará selecionado "1-01 Ponto reto (Esquerda)" ou "1-03 Ponto reto (Centro)".

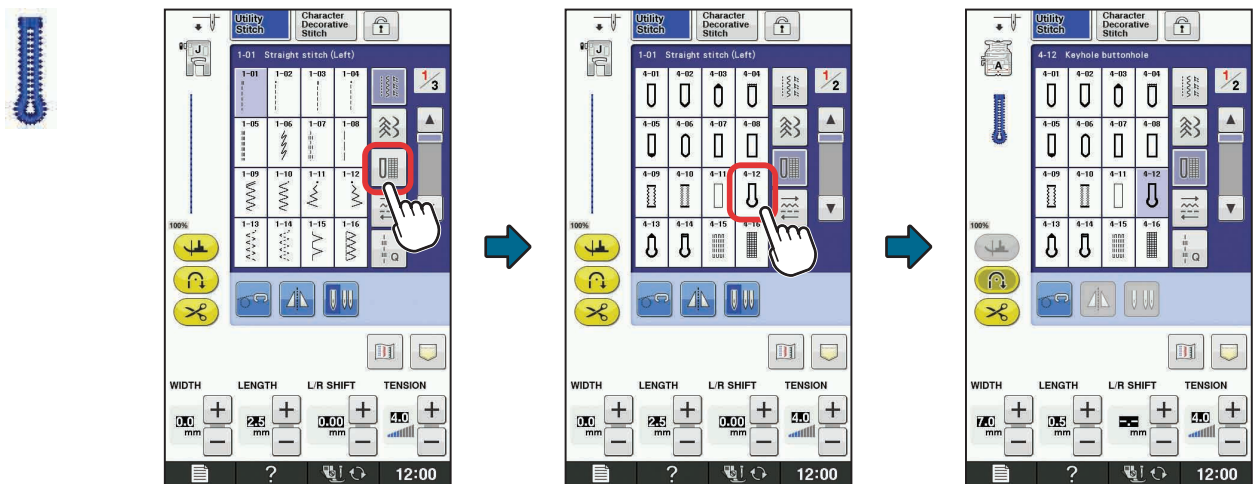

- ◆ Character/Decorative Stitches
- ◆ Caractères/points décoratifs
- ◆ Puntis per caratteri/decorazioni
- ◆ Знаки алфавита/декоративные строчки
- ◆ Buchstaben/Dekorative Stichmuster
- ◆ Letter/decoratieve steken
- ◆ Puntadas de letras/decorativas
- ◆ Letras e pontos decorativos

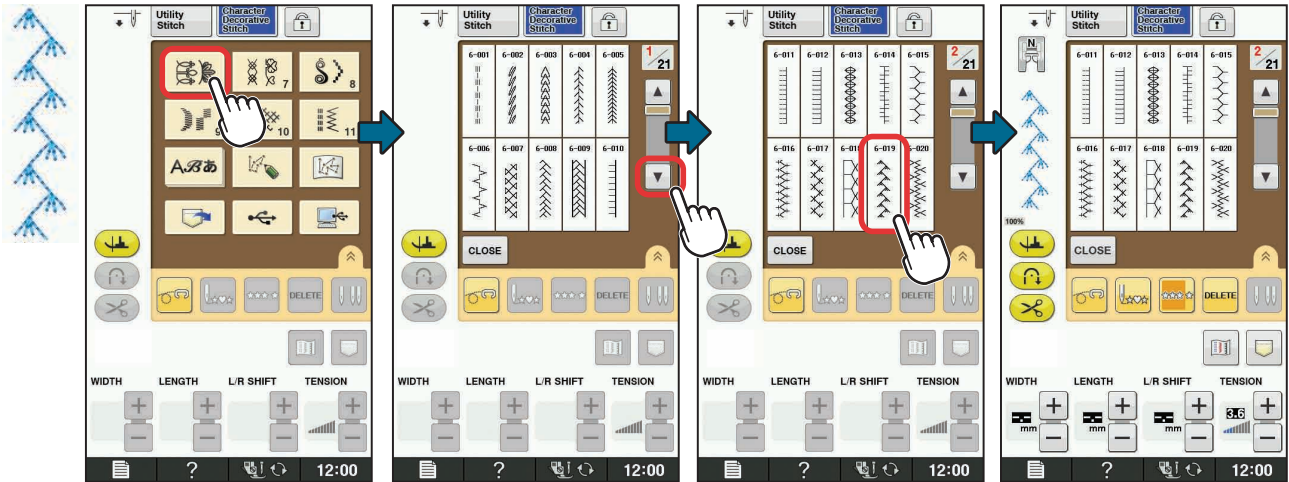

- ◆ Settings
- ◆ Réglages
- ◆ Impostazioni
- ◆ Настройки

- ◆ Einstellungen
- ◆ Instellingen
- ◆ Ajustes
- ◆ Configurações

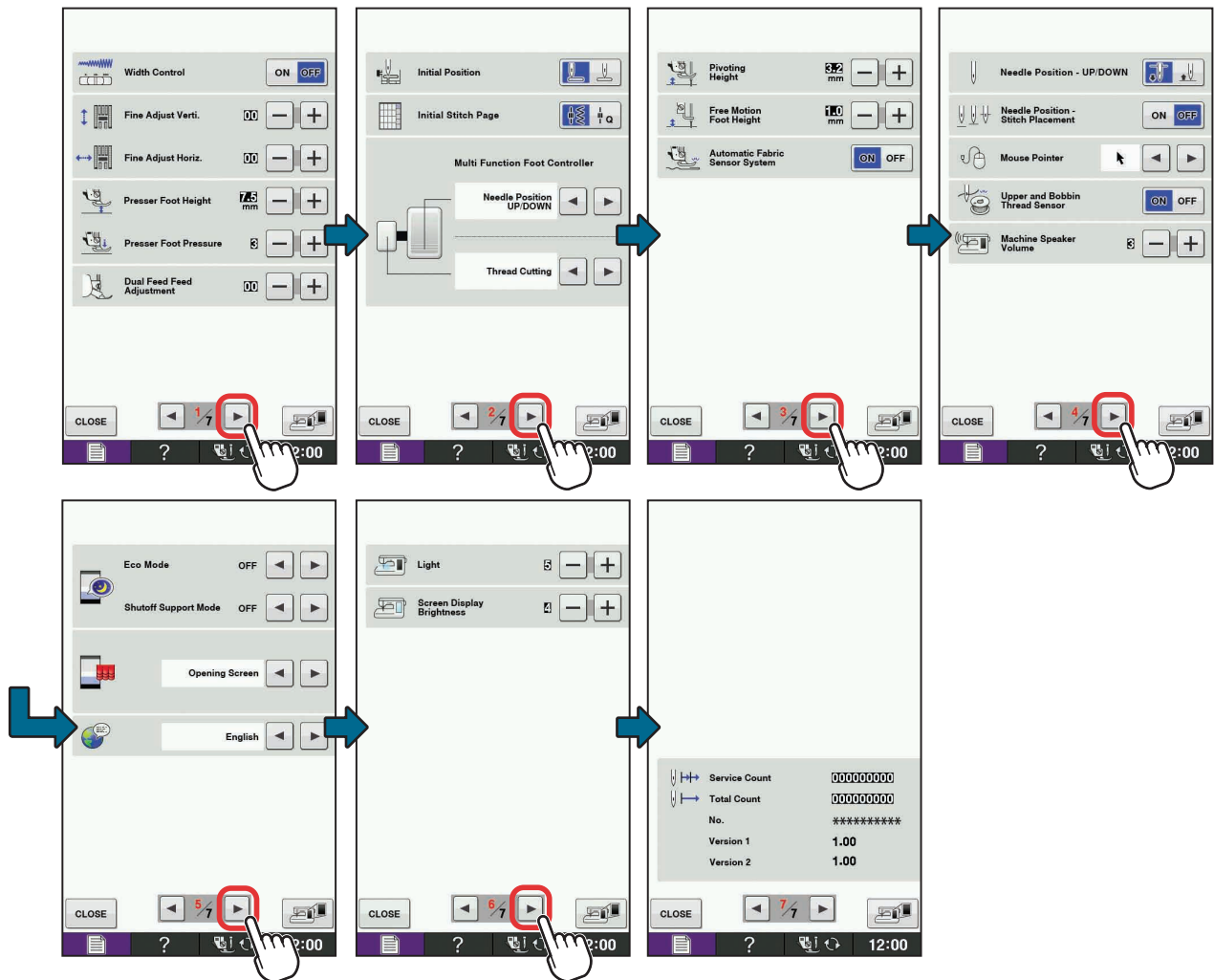

Summary of Stitch Patterns
 Sommaire des motifs de point
 Sommario degli schemi punto
 Виды строчек

Nähmuster-Übersicht
 Overzicht van de steekpatronen
 Resumen de tipos de puntada
 Resumo de padrões de pontos

◆ Utility Stitches

◆ Points utilitaires

◆ Punti utili

◆ Основные строчки

◆ Nutzstiche

◆ Naaisteken

◆ Puntadas utiles

◆ Pontos utilitários

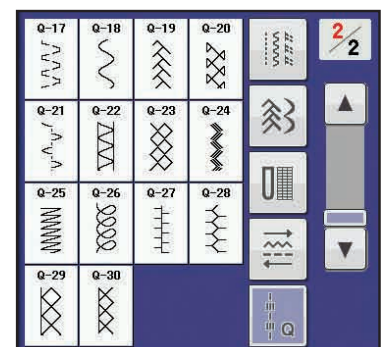
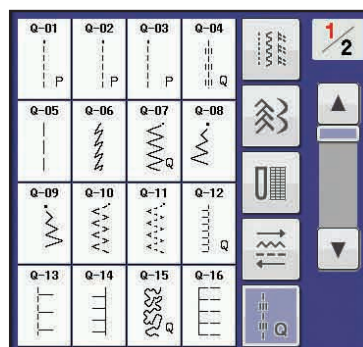
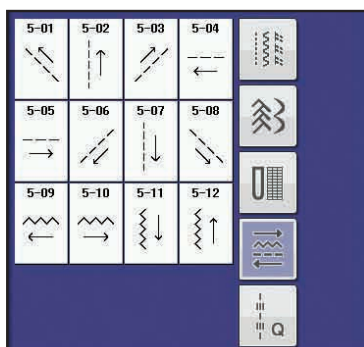
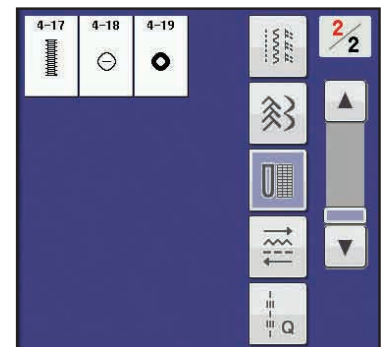
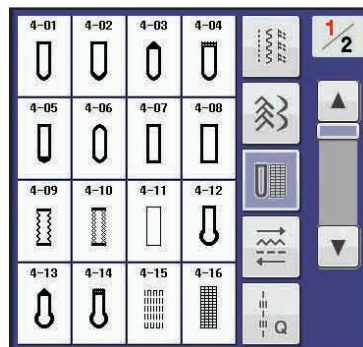
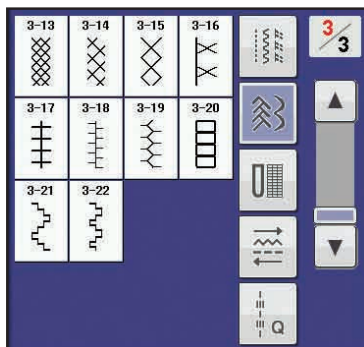
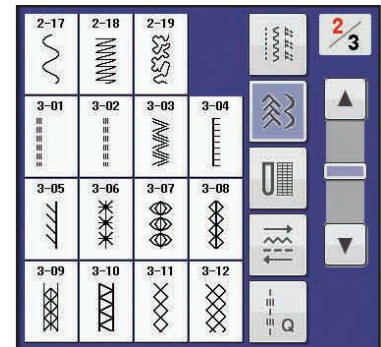
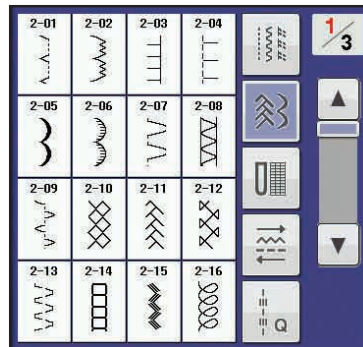
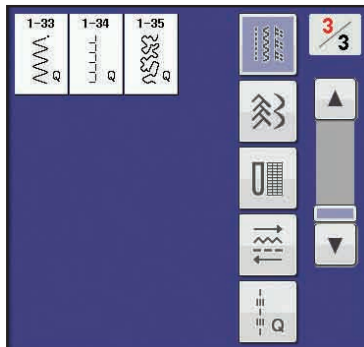
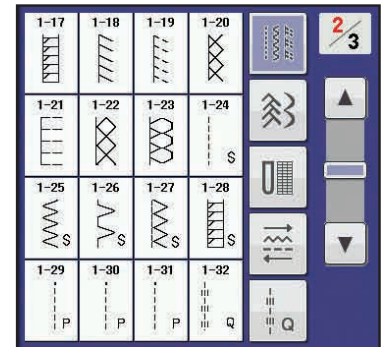
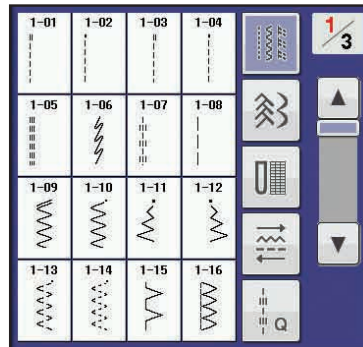
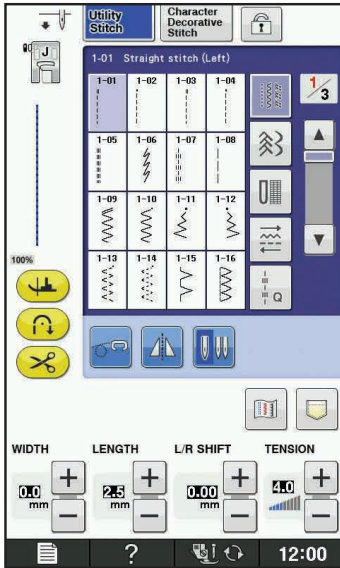

◆ Character/Decorative Stitches

◆ Caractères/points décoratifs

◆ Punti per caratteri/decorazioni

◆ Знаки алфавита/декоративные строчки

◆ Buchstaben/Dekorative Stichmuster

◆ Letter/decoratieve steken

◆ Puntadas de letras/decorativas

◆ Letras e pontos decorativos

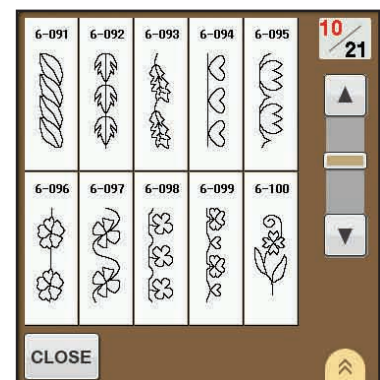
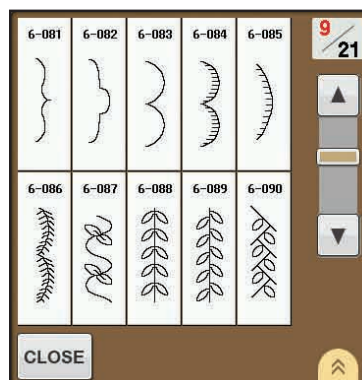
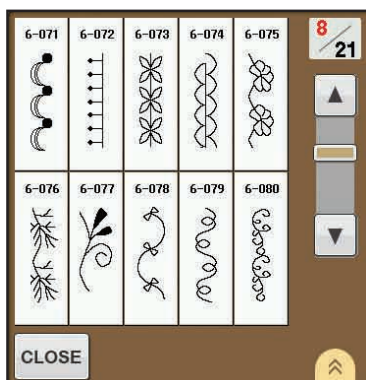
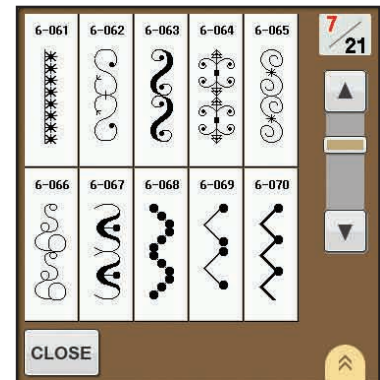
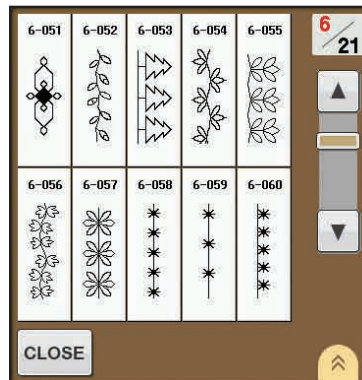
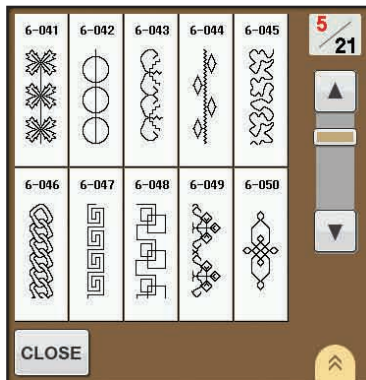
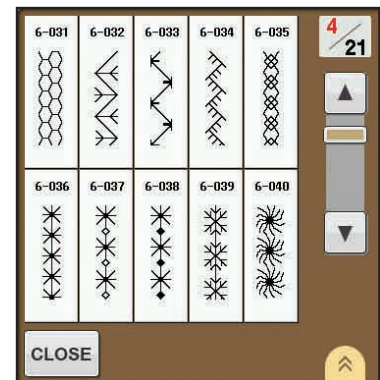
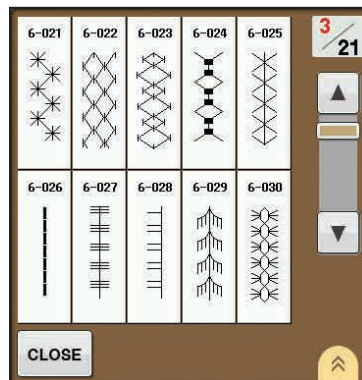
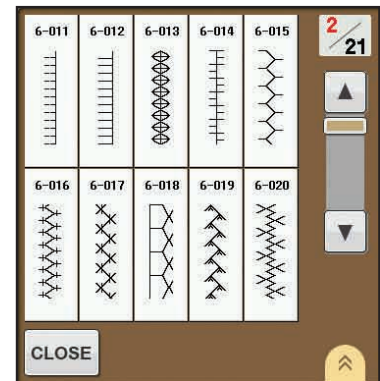
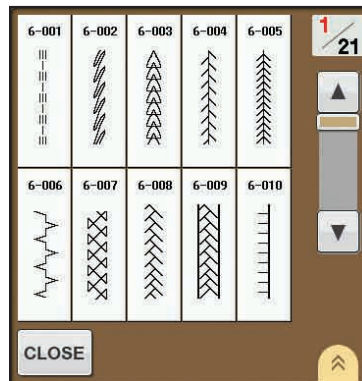
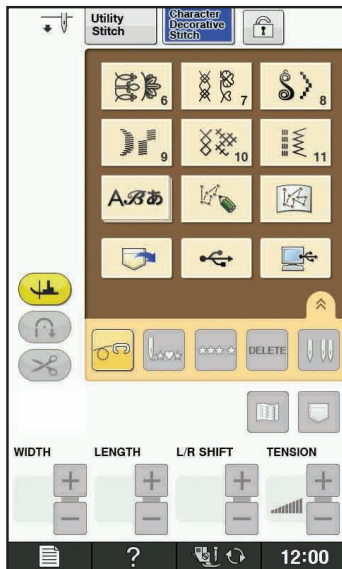

| | | | | | |
|-------|-------|-------|-------|-------|---------|
| 6-101 | 6-102 | 6-103 | 6-104 | 6-105 | 11 / 21 |
| | | | | | |
| 6-106 | 6-107 | 6-108 | 6-109 | 6-110 | |
| | | | | | |
| CLOSE | | | | | >> |

| | | | | | |
|-------|-------|-------|-------|-------|---------|
| 6-111 | 6-112 | 6-113 | 6-114 | 6-115 | 12 / 21 |
| | | | | | |
| 6-116 | 6-117 | 6-118 | 6-119 | 6-120 | |
| | | | | | |
| CLOSE | | | | | >> |

| | | | | | |
|-------|-------|-------|-------|-------|---------|
| 6-121 | 6-122 | 6-123 | 6-124 | 6-125 | 13 / 21 |
| | | | | | |
| 6-126 | 6-127 | 6-128 | 6-129 | 6-130 | |
| | | | | | |
| CLOSE | | | | | >> |

| | | | | | |
|-------|-------|-------|-------|-------|---------|
| 6-131 | 6-132 | 6-133 | 6-134 | 6-135 | 14 / 21 |
| | | | | | |
| 6-136 | 6-137 | 6-138 | 6-139 | 6-140 | |
| | | | | | |
| CLOSE | | | | | >> |

| | | | | | |
|-------|-------|-------|-------|-------|---------|
| 6-141 | 6-142 | 6-143 | 6-144 | 6-145 | 15 / 21 |
| | | | | | |
| 6-146 | 6-147 | 6-148 | 6-149 | 6-150 | |
| | | | | | |
| CLOSE | | | | | >> |

| | | | | | |
|-------|-------|-------|-------|-------|---------|
| 6-151 | 6-152 | 6-153 | 6-154 | 6-155 | 16 / 21 |
| | | | | | |
| 6-156 | 6-157 | 6-158 | 6-159 | 6-160 | |
| | | | | | |
| CLOSE | | | | | >> |

| | | | | | |
|-------|-------|-------|-------|-------|---------|
| 6-161 | 6-162 | 6-163 | 6-164 | 6-165 | 17 / 21 |
| | | | | | |
| 6-166 | 6-167 | 6-168 | 6-169 | 6-170 | |
| | | | | | |
| CLOSE | | | | | >> |

| | | | | | |
|-------|-------|-------|-------|-------|---------|
| 6-171 | 6-172 | 6-173 | 6-174 | 6-175 | 18 / 21 |
| | | | | | |
| 6-176 | | | | | |
| | | | | | |
| CLOSE | | | | | >> |

| | | | | | |
|-------|-------|-------|--|--|---------|
| 6-177 | 6-178 | 6-179 | | | 19 / 21 |
| | | | | | |
| | | | | | |
| | | | | | |
| CLOSE | | | | | >> |

Summary of Stitch Patterns
 Nähmuster-Übersicht
 Sommaire des motifs de point
 Overzicht van de steekpatronen
 Sommario degli schemi punto
 Resumen de tipos de puntada
 Виды строчек
 Resumo de padrões de pontos

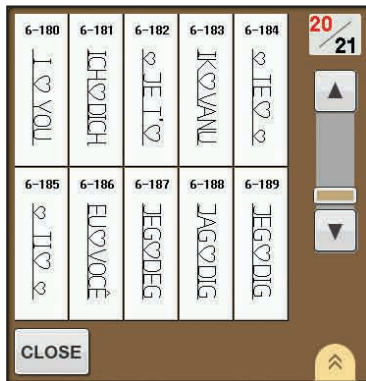

6-180: English
 6-181: German
 6-182: French
 6-183: Dutch
 6-184: Spanish
 6-185: Italian
 6-186: Portuguese
 6-187: Norwegian
 6-188: Swedish
 6-189: Danish
 6-190: Finnish
 6-191: Russian
 6-192: Thai
 6-193: Simplified Chinese
 6-194: Japanese

6-180: Englisch
 6-181: Deutsch
 6-182: Französisch
 6-183: Niederländisch
 6-184: Spanisch
 6-185: Italienisch
 6-186: Portugiesisch
 6-187: Norwegisch
 6-188: Schwedisch
 6-189: Dänisch
 6-190: Finnisch
 6-191: Russisch
 6-192: Thailändisch
 6-193: Vereinfachtes Chinesisch
 6-194: Japanisch

6-180 : anglais
 6-181 : allemand
 6-182 : français
 6-183 : néerlandais
 6-184 : espagnol
 6-185 : italien
 6-186 : portugais
 6-187 : norvégien
 6-188 : suédois
 6-189 : danois
 6-190 : finnois
 6-191 : russe
 6-192 : thaïlandais
 6-193 : chinois simplifié
 6-194 : japonais

6-180: Engels
 6-181: Duits
 6-182: Frans
 6-183: Nederlands
 6-184: Spaans
 6-185: Italiaans
 6-186: Portugees
 6-187: Noors
 6-188: Zweeds
 6-189: Deens
 6-190: Fins
 6-191: Russisch
 6-192: Thais
 6-193: Vereenvoudigd Chinees
 6-194: Japans

6-180: Inglese
 6-181: Tedesco
 6-182: Francese
 6-183: Olandese
 6-184: Spagnolo
 6-185: Italiano
 6-186: Portoghese
 6-187: Norvegese
 6-188: Svedese
 6-189: Danese
 6-190: Finlandese
 6-191: Russo
 6-192: Tailandese
 6-193: Cinese semplificato
 6-194: Giapponese

6-180: Inglés
 6-181: Alemán
 6-182: Francés
 6-183: Holandés
 6-184: Español
 6-185: Italiano
 6-186: Portugués
 6-187: Noruego
 6-188: Sueco
 6-189: Danés
 6-190: Finés
 6-191: Ruso
 6-192: Tailandés
 6-193: Chino simplificado
 6-194: Japonés

6-180: Английский
 6-181: Немецкий
 6-182: Французский
 6-183: Нидерландский
 6-184: Испанский
 6-185: Итальянский
 6-186: Португальский
 6-187: Норвежский
 6-188: Шведский
 6-189: Датский
 6-190: Финский
 6-191: Русский
 6-192: Тайский
 6-193: Китайский (упрощенный)
 6-194: Японский

6-180: Inglês
 6-181: Alemão
 6-182: Francês
 6-183: Holandês
 6-184: Espanhol
 6-185: Italiano
 6-186: Português
 6-187: Norueguês
 6-188: Sueco
 6-189: Dinamarquês
 6-190: Finlandês
 6-191: Russo
 6-192: Tailandês
 6-193: Chinês Simplificado
 6-194: Japonês

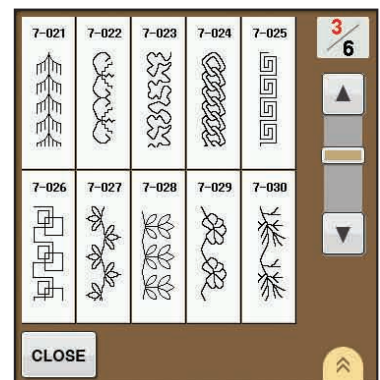
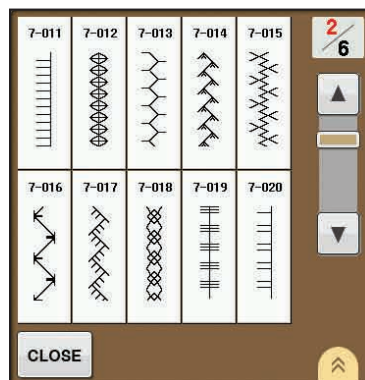
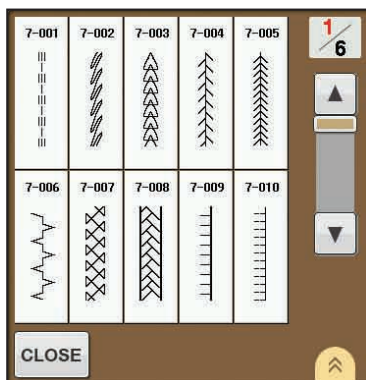

| | | | | | | | | | |
|-------|-------|-------|-------|-------|-----|---|---|---|---|
| 7-031 | 7-032 | 7-033 | 7-034 | 7-035 | 4/6 | ▲ | ▼ | ⏪ | ⏩ |
| 7-036 | 7-037 | 7-038 | 7-039 | 7-040 | | | | | |
| CLOSE | | | | | | | | | |

| | | | | | | | | | |
|-------|-------|-------|-------|-------|-----|---|---|---|---|
| 7-041 | 7-042 | 7-043 | 7-044 | 7-045 | 5/6 | ▲ | ▼ | ⏪ | ⏩ |
| 7-046 | 7-047 | 7-048 | 7-049 | 7-050 | | | | | |
| CLOSE | | | | | | | | | |

| | | | | | | |
|-------|-------|-----|---|---|---|---|
| 7-051 | 7-052 | 6/6 | ▲ | ▼ | ⏪ | ⏩ |
| | | | | | | |
| CLOSE | | | | | | |



| | | | | | | | | | |
|-------|------|------|------|------|-----|---|---|---|---|
| 8-01 | 8-02 | 8-03 | 8-04 | 8-05 | 1/6 | ▲ | ▼ | ⏪ | ⏩ |
| 8-06 | 8-07 | 8-08 | 8-09 | 8-10 | | | | | |
| CLOSE | | | | | | | | | |

| | | | | | | | | | |
|-------|------|------|------|------|-----|---|---|---|---|
| 8-11 | 8-12 | 8-13 | 8-14 | 8-15 | 2/6 | ▲ | ▼ | ⏪ | ⏩ |
| 8-16 | 8-17 | 8-18 | 8-19 | 8-20 | | | | | |
| CLOSE | | | | | | | | | |

| | | | | | | | | | |
|-------|------|------|------|------|-----|---|---|---|---|
| 8-21 | 8-22 | 8-23 | 8-24 | 8-25 | 3/6 | ▲ | ▼ | ⏪ | ⏩ |
| 8-26 | 8-27 | 8-28 | 8-29 | 8-30 | | | | | |
| CLOSE | | | | | | | | | |

| | | | | | | | | | |
|-------|------|------|------|------|-----|---|---|---|---|
| 8-31 | 8-32 | 8-33 | 8-34 | 8-35 | 4/6 | ▲ | ▼ | ⏪ | ⏩ |
| 8-36 | 8-37 | 8-38 | 8-39 | 8-40 | | | | | |
| CLOSE | | | | | | | | | |

| | | | | | | | | | |
|-------|------|------|------|------|-----|---|---|---|---|
| 8-41 | 8-42 | 8-43 | 8-44 | 8-45 | 5/6 | ▲ | ▼ | ⏪ | ⏩ |
| 8-46 | 8-47 | 8-48 | 8-49 | 8-50 | | | | | |
| CLOSE | | | | | | | | | |

| | | | | | | | | | |
|-------|------|------|------|------|-----|---|---|---|---|
| 8-51 | 8-52 | 8-53 | 8-54 | 8-55 | 6/6 | ▲ | ▼ | ⏪ | ⏩ |
| 8-56 | | | | | | | | | |
| CLOSE | | | | | | | | | |



| | | | | | | | | | | |
|------|------|------|------|------|------|-------|---|---|---|---|
| 9-01 | 9-02 | 9-03 | 9-04 | 9-05 | 9-06 | CLOSE | ⏪ | ⏩ | ⏪ | ⏩ |
| 9-07 | 9-08 | 9-09 | 9-10 | 9-11 | 9-12 | | | | | |
| 9-13 | 9-14 | 9-15 | 9-16 | 9-17 | 9-18 | | | | | |
| 9-19 | 9-20 | | | | | | | | | |



| | | | | | | | | |
|-------|-------|-------|-------|-------|-------|-------|---|---|
| 10-01 | 10-02 | 10-03 | 10-04 | 10-05 | 10-06 | CLOSE | ⏪ | ⏩ |
| 10-07 | 10-08 | 10-09 | 10-10 | 10-11 | 10-12 | | | |
| 10-13 | 10-14 | | | | | | | |
| | | | | | | | | |

Summary of Stitch Patterns
 Nähmuster-Übersicht
 Sommaire des motifs de point
 Overzicht van de steekpatronen
 Sommario degli schemi punto
 Resumen de tipos de puntada
 Виды строчек
 Resumo de padrões de pontos

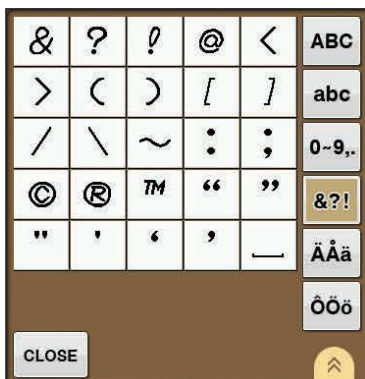
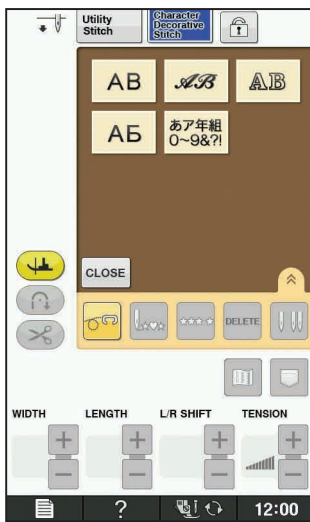
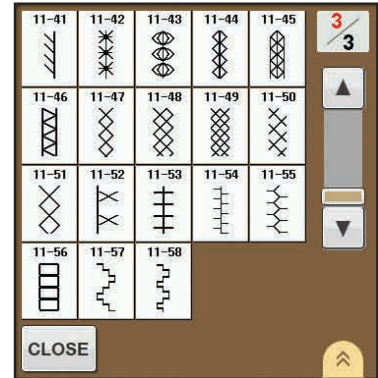
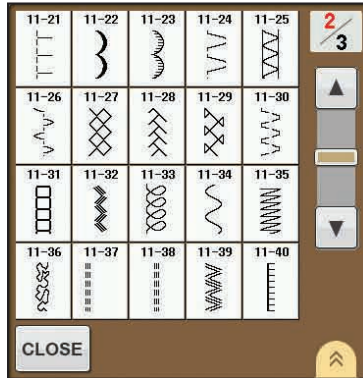
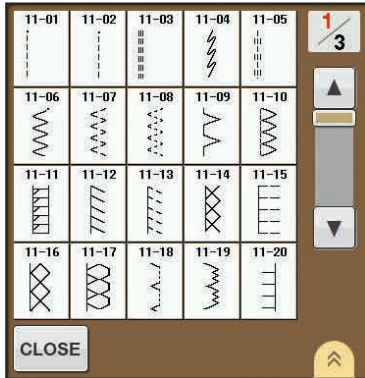
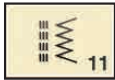

AB

| | | | | | |
|---|---|---|---|---|-------|
| A | B | C | D | E | ABC |
| F | G | H | I | J | abc |
| K | L | M | N | O | 0-9,. |
| P | Q | R | S | T | &?! |
| U | V | W | X | Y | ÄÄä |
| Z | ' | _ | | | ÖÖö |

CLOSE

| | | | | | |
|---|---|---|---|---|-------|
| a | b | c | d | e | ABC |
| f | g | h | i | j | abc |
| k | l | m | n | o | 0-9,. |
| p | q | r | s | t | &?! |
| u | v | w | x | y | ÄÄä |
| z | ' | _ | | | ÖÖö |

CLOSE

| | | | | | |
|---|---|----|---|---|-------|
| 0 | 1 | 2 | 3 | 4 | ABC |
| 5 | 6 | 7 | 8 | 9 | abc |
| # | % | \$ | £ | € | 0-9,. |
| ¥ | - | + | × | ÷ | &?! |
| = | * | . | , | ' | ÄÄä |
| _ | | | | | ÖÖö |

CLOSE

| | | | | | |
|---|---|---|---|---|-------|
| & | ? | ! | @ | < | ABC |
| > | (|) | [|] | abc |
| / | \ | ~ | : | ; | 0-9,. |
| © | ® | ™ | “ | ” | &?! |
| ” | ' | ' | ' | _ | ÄÄä |
| | | | | | ÖÖö |

CLOSE

| | | | | | |
|---|---|---|---|---|-------|
| À | Á | Â | à | á | ABC |
| ä | ã | ä | å | Æ | abc |
| æ | Ç | ç | È | É | 0-9,. |
| Ê | Ë | è | é | ê | &?! |
| ë | Ï | ì | í | Ð | ÄÄä |
| Ñ | ñ | Î | í | _ | ÖÖö |

CLOSE

| | | | | | |
|---|---|---|---|---|-------|
| Ô | Ö | Ø | ò | ó | ABC |
| ô | ö | ø | û | ü | abc |
| ù | ú | û | ü | Þ | 0-9,. |
| ƒ | ß | ı | İ | Ń | &?! |
| Ő | ő | Œ | œ | Ŕ | ÄÄä |
| Ť | ž | ' | _ | | ÖÖö |

CLOSE

AB

| | | | | | |
|---|---|---|---|---|-------|
| A | B | C | D | E | ABC |
| F | G | H | I | J | abc |
| K | L | M | N | O | 0-9,. |
| P | Q | R | S | T | &?! |
| U | V | W | X | Y | ÄÄä |
| Z | ' | _ | | | ÖÖö |

CLOSE

| | | | | | |
|---|---|---|---|---|-------|
| a | b | c | d | e | ABC |
| f | g | h | i | j | abc |
| k | l | m | n | o | 0-9,. |
| p | q | r | s | t | &?! |
| u | v | w | x | y | ÄÄä |
| z | ' | _ | | | ÖÖö |

CLOSE

| | | | | | |
|---|---|----|---|---|-------|
| 0 | 1 | 2 | 3 | 4 | ABC |
| 5 | 6 | 7 | 8 | 9 | abc |
| # | % | \$ | £ | € | 0-9,. |
| ¥ | - | + | × | ÷ | &?! |
| = | * | . | , | ' | ÄÄä |
| _ | | | | | ÖÖö |

CLOSE

| | | | | | |
|---|---|---|---|---|-------|
| & | ? | ! | @ | < | ABC |
| > | (|) | [|] | abc |
| / | \ | ~ | : | ; | 0-9,. |
| © | ® | ™ | “ | ” | &?! |
| ” | ' | ' | ' | _ | ÄÄä |
| | | | | | ÖÖö |

CLOSE

| | | | | | |
|---|---|---|---|---|-------|
| Â | Ä | Å | à | á | ABC |
| â | ã | ä | å | Æ | abc |
| æ | Ç | ç | È | É | 0-9,. |
| Ê | Ë | è | é | ê | &?! |
| ë | Ï | ì | í | Ð | ÄÄä |
| Ñ | ñ | Î | í | _ | ÖÖö |

CLOSE

| | | | | | |
|---|---|---|---|---|-------|
| Ô | Ö | Ø | ò | ó | ABC |
| ô | ö | ø | û | ü | abc |
| ù | ú | û | ü | Þ | 0-9,. |
| ƒ | ß | ı | İ | Ń | &?! |
| Ő | ő | Œ | œ | Ŕ | ÄÄä |
| Ť | ž | ' | _ | | ÖÖö |

CLOSE

АБ

| | | | | | |
|---|---|---|---|---|-------|
| А | Б | В | Г | Д | АБВ |
| Е | Ё | Ж | З | И | ЧШЩ |
| Й | К | Л | М | Н | абв |
| О | П | Р | С | Т | чшщ |
| У | Ф | Х | Ц | — | 0-9,. |

CLOSE 

| | | | | | |
|---|---|----|---|---|-------|
| Ч | Ш | Щ | Ь | Ы | АБВ |
| Ь | Э | Ю | Я | Г | ЧШЩ |
| Е | І | Ї | Ў | Ѓ | абв |
| Ѓ | Ј | ЈЬ | Њ | Ц | чшщ |
| Ѓ | Ѕ | Ѓ | — | | 0-9,. |

CLOSE 

| | | | | | |
|---|---|---|---|---|-------|
| а | б | в | г | д | АБВ |
| е | ё | ж | з | и | ЧШЩ |
| й | к | л | м | н | абв |
| о | п | р | с | т | чшщ |
| у | ф | х | ц | — | 0-9,. |

CLOSE 

| | | | | | |
|---|---|----|---|---|-------|
| Ч | Ш | Щ | Ь | Ы | АБВ |
| Ь | Э | Ю | Я | Г | ЧШЩ |
| Е | І | Ї | Ў | Ѓ | абв |
| Ѓ | Ј | ЈЬ | Њ | Ц | чшщ |
| Ѓ | Ѕ | Ѓ | — | | 0-9,. |

CLOSE 

| | | | | | |
|---|---|---|---|---|-------|
| 0 | 1 | 2 | 3 | 4 | АБВ |
| 5 | 6 | 7 | 8 | 9 | ЧШЩ |
| — | . | , | & | ? | абв |
| ! | (|) | / | ' | чшщ |
| — | | | | | 0-9,. |

CLOSE 

Summary of Stitch Patterns
 Nähmuster-Übersicht
 Sommaire des motifs de point
 Overzicht van de steekpatronen
 Sommario degli schemi punto
 Resumen de tipos de puntada
 Виды строчек
 Resumo de padrões de pontos

あア年組
 0~9&?!

* Hiragana characters: One of the character sets of Japanese.
 Hiragana-Zeichen: Einer der Zeichensätze für Japanisch.
 Caractères Hiragana : l'un des jeux de caractères japonais.
 Hiragana-tekens: een van de tekensets van Japans.
 Caratteri Hiragana: uno dei set di caratteri della lingua giapponese.
 Caracteres Hiragana: uno de los grupos de caracteres del japonés.
 Хирагана: один из наборов символов (азбука) в японском языке.
 Caracteres hiragana: um dos sistemas de caracteres do alfabeto japonês.

Katakana characters: One of the character sets of Japanese.
 Katakana-Zeichen: Einer der Zeichensätze für Japanisch.
 Caractères Katakana : l'un des jeux de caractères japonais.
 Katakana-tekens: een van de tekensets van Japans.
 Caratteri Katakana: uno dei set di caratteri della lingua giapponese.
 Caracteres Katakana: uno de los grupos de caracteres del japonés.
 Катакана: один из наборов символов (азбука) в японском языке.
 Caracteres katakana: um dos sistemas de caracteres do alfabeto japonês.



Arabic numerals, Japanese Kanji numerals
 Arabische Ziffern, japanische Kanji-Ziffern
 Chiffres arabes, chiffres Kanji japonais
 Arabische cijfers, Japanse Kanji-cijfers
 Numeri arabi, numeri Kanji giapponesi
 Números arábigos, números Kanji japoneses
 Арабские цифры и иероглифы кандзи
 Numerais arábicos, numerais japoneses em kanji

Kanji characters often used in daily life / symbols.
 Im Alltag häufig verwendete Kanji-Zeichen / Symbole.
 Les caractères Kanji sont souvent utilisés dans la vie de tous les jours / symboles.
 Kanji-tekens worden vaak gebruikt in het dagelijks leven / symbolen.
 Caratteri Kanji spesso utilizzati nella vita quotidiana / simboli.
 Los caracteres Kanji se utilizan a menudo en la vida diaria / como símbolos.
 Иероглифы кандзи часто используются в повседневной жизни или как символы.
 Caracteres kanji utilizados frequentemente no cotidiano/símbolos.

Horizontal
 Horizontal
 Horizontal
 Horizontal
 Horizontaal
 Orizzontale
 Horizontal
 По горизонтали
 Horizontal

Vertical
 Vertikal
 Vertical
 Verticaal
 Verticale
 Vertical
 По вертикали
 Vertical



* Japanese characters
 * Japanse tekens
 * Японские иероглифы

* Japanische Zeichen
 * Caratteri giapponesi
 * Caracteres do alfabeto japonês

* Caractères japonais
 * Caracteres japoneses

English
 German
 French
 Dutch
 Italian
 Spanish
 Russian
 Portuguese-BR
 882-D10
 Printed in Taiwan



XF6509-101①