

Operation Manual

Cutting Machine

Product Code: 891-Z01

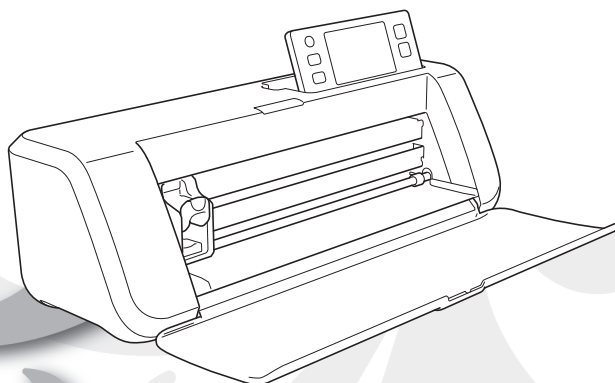

Be sure to read this document before using the machine.
We recommend that you keep this document nearby for future reference.

TRADEMARKS

IMPORTANT:

READ BEFORE DOWNLOADING, COPYING, INSTALLING OR USING.

By downloading, copying, installing or using the software, you agree to this license. If you do not agree to this license, do not download, install, copy or use the software.

Intel License Agreement For Open Source Computer Vision Library

Copyright © 2000, Intel Corporation, all rights reserved. Third-party copyrights are the property of their respective owners.

Redistribution and use in source and binary forms, with or without modification, are permitted provided that the following conditions are met:

- Redistribution of source code must retain the above copyright notice, this list of conditions and the following disclaimer.
- Redistribution in binary form must reproduce the above copyright notice, this list of conditions and the following disclaimer in the documentation and/or other materials provided with the distribution.
- The name of Intel Corporation may not be used to endorse or promote products derived from this software without specific prior written permission.

This software is provided by the copyright holders and contributors “as is” and any express or implied warranties, including, but not limited to, the implied warranties of merchantability and fitness for a particular purpose are disclaimed. In no event shall Intel or contributors be liable for any direct, indirect, incidental, special, exemplary, or consequential damages (including, but not limited to, procurement of substitute goods or services; loss of use, data, or profits; or business interruption) however caused and on any theory of liability, whether in contract, strict liability, or tort (including negligence or otherwise) arising in any way out of the use of this software, even if advised of the possibility of such damage.

All information provided related to future Intel products and plans is preliminary and subject to change at any time, without notice.

The Brother logo is a registered trademark of Brother Industries, Ltd.

INTRODUCTION

Thank you for purchasing this machine.

Before using this machine or attempting any maintenance, carefully read the "IMPORTANT SAFETY INSTRUCTIONS" on this page, and then study this safety manual for the correct operation of the various functions. In addition, after you have finished reading this safety manual, store it where it can quickly be accessed for future reference. Failure to follow these instructions may result in an increased risk of personal injury or damage to property, including through fire, electrical shock, burns or suffocation.



IMPORTANT NOTICE





- This machine is intended for household use.
- This machine is approved for use in the country of purchase only.
- Due to product quality improvements, the specifications or appearance of this machine may change without notice.
- The contents of this document are subject to change without notice.
- The contents of this document may not be duplicated or reproduced, partially or in full, without permission.
- We assume no responsibility for damages arising from earthquakes, fire, other disasters, actions of third parties, the user's intentional or negligent operation, misuse or operation under other special conditions.
- For additional product information, visit our web site at www.brother.com

IMPORTANT SAFETY INSTRUCTIONS

Symbols Used in This Document

The following symbols are used in this document.































 WARNING	Failure to observe instructions with this marking may result in fatal or critical injuries.
 CAUTION	Failure to observe instructions with this marking may result in serious injuries.
IMPORTANT	Failure to observe instructions with this marking may result in property damage.

	This symbol indicates that there is a possibility of fire under specific conditions.
	This symbol indicates that there is a possibility of electric shock under specific conditions.
	This symbol indicates a prohibited action, which must not be performed.
	This symbol indicates a required action, which must be performed.

Important Safety Instructions

The following precautions should be observed for safe use of the machine.

Power Supply and AC Adapter

 WARNING	
 	Place the AC adapter and power cord in a safe location, where they will not be stepped on, while they are being both used and stored. Do not perform any of the following actions that may damage the AC adapter or power cord. Otherwise, a fire, electric shock or damage to the machine may result: Damaging, modifying, forcefully bending, exposing to heat, pulling, twisting, bundling, placing objects on, pinching, exposing to metal, repeatedly bending and folding, hanging in the air, or squeezing against a wall.
 	Do not use any AC adapter or power cord other than the AC adapter and power cord designed specifically for this machine. Otherwise, a fire, electric shock or damage to the machine may result. Do not use the AC adapter and power cord designed specifically for this machine with any other device.
 	Use the AC adapter only with a household electrical outlet (AC 100–240V, 50/60Hz). Otherwise, a fire, electric shock or damage to the machine may result.
 	Never connect a DC power supply or inverter (DC-AC inverter). Otherwise, a fire or electric shock may result. If it is unknown whether the electrical outlet to be used to connect this machine is an AC or DC power supply, consult a licensed electrician.
 	Fully insert the power cord plug into the outlet. Otherwise, a fire, electric shock or damage to the machine may result.
	Do not place the machine on the power cord. Otherwise, a fire or damage to the power cord may result.
 	Do not expose to a flame or heater. Otherwise, the cover of the AC adapter may melt, and a fire or electric shock may result.
	If the machine is not to be used for a long period of time, be sure to unplug the AC adapter from the machine and the electrical outlet for safety reasons.
	When performing maintenance (such as cleaning), unplug the AC adapter from the electrical outlet. Otherwise, an electric shock may result.
 	When disconnecting the power cord plug from the electrical outlet, grasp the non-metal part of the plug, not the cord, to pull it out. Otherwise, a fire, electric shock or damage to the machine may result.
 	Do not use a damaged power cord or plug, or loose electrical outlet. Otherwise, a fire, electric shock or damage to the machine may result.
 	Do not use an extension cord and multi-plug adapters. Otherwise, a fire, electric shock or damage to the machine may result.
 	Do not insert foreign objects into the AC adapter inlet. Otherwise, a fire, electric shock, physical injuries or damage to the machine and AC adapter may result.
	Do not touch the AC adapter or power cord plug with wet hands. Otherwise, an electric shock may result.
 	Do not allow liquids, metal objects or dust to come into contact with the power cord plug while it is being both plugged in and stored. In addition, never use the machine in a location where it may be exposed to water. Otherwise, a fire, electric shock or damage to the machine may result.
 	Do not disassemble, alter or attempt to repair the AC adapter. Otherwise, a fire, electric shock or injuries may result. For servicing, adjustments and repairs, contact the retailer who sold you this machine or the nearest authorized service center.
	If the power cord plug becomes dusty, disconnect it from the electrical outlet, and then wipe it with a dry cloth. Using the machine with a dusty plug may result in a fire.

CAUTION



Do not place objects around the power cord or block access to the power cord. Otherwise, the power cord cannot be unplugged in an emergency.

IMPORTANT



Take precautions when sharing the electrical outlet with other device. Avoid using the same electrical outlet used by chargers for portable phones or high-voltage devices such as copiers. Otherwise, interference or machine malfunctions may occur.



Turn off the machine before unplugging the AC adapter. Unplugging the power cord while the machine is operating may result in damage to the machine.

Installation Location

Put your machine on a flat, level, stable surface that is free of vibration and shocks.

Use this machine in an environment that meets the following specifications.

Temperature: 5 °C to 35 °C (41 °F to 95 °F)

Humidity: 20 % to 80 %

WARNING



Do not install the machine in a location exposed to direct sunlight, sudden temperature or humidity changes, high humidity or water (such as near a kitchen, bathroom or humidifier), condensation or extreme amounts of dust. Avoid using or storing the machine in a location exposed to high temperatures or high humidity. Otherwise, a short circuit may result, which may cause a fire, electric shock, or damage to the machine.



Do not install the machine near a flame, heater, volatile combustibles or other source of extreme heat. Otherwise, a fire, electric shock or damage to the machine may result. Do not use the machine in a room where flammable sprays are used. Otherwise, a fire or physical injuries may result.



Do not use the machine near medical electrical equipment. Otherwise, the medical electrical equipment may be affected by the electrical waves from this machine and malfunction, resulting in an accident.



Avoid using this machine outdoors. Otherwise, the machine may become wet possibly resulting in an electric shock. If the machine becomes wet, contact the retailer who sold you this machine or the nearest authorized service center.



In order to prevent metal or liquids from entering the machine, do not place any of the following objects on or above the machine. Otherwise, a fire, electric shock or damage to the machine may result.

- Metal objects such as paper clips and staples
- Precious metal objects such as necklaces and rings
- Containers filled with liquid, such as cups, vases and plant pots

In addition, do not allow pets near the machine.

If anything accidentally enters the machine, unplug the power cord, and then contact the retailer who sold you this machine or the nearest authorized service center.

CAUTION



Do not place the machine on an unstable surface, such as an unsteady table or an angled surface. In addition, do not position the machine so that any part of it extends off the surface's edge. If the machine falls or is dropped, injuries or damage to the machine may result.



Place the machine on a flat, even surface. The mat will catch on an uneven surface, causing improper operation.







IMPORTANT











Do not use the machine in a location exposed to severe vibrations or strong electrical interference or static electricity. Otherwise, the machine may not operate properly.

For Safe Operation





WARNING



















	If the machine malfunctions or is dropped or damaged or if water or a foreign object enters it, immediately unplug the AC adapter from the machine and electrical outlet, and then contact the retailer who sold you this machine or the nearest authorized service center. Continuing to use the machine in this condition may result in a fire or electric shock.
	If a power outage occurs or thunder is heard while the machine is being used, disconnect the power cord plug from the electrical outlet. Otherwise, a fire, electric shock or damage to the machine may result.
	If, while the machine is being used or stored, an unusual odor is produced, the machine produces heat or smoke or becomes discolored or deformed, or any other unusual occurrence is observed, stop using the machine, and then unplug the AC adapter from the machine and electrical outlet. Continuing to use the machine in this condition may result in a fire or electric shock. In addition, repairs must never be performed by the user; it is too dangerous.
	Do not disassemble, repair or alter the machine by yourself. Otherwise, a fire, electric shock or injuries may result. For servicing, adjustment, cleaning or repair of internal parts other than those specified, contact the retailer who sold you this machine or the nearest authorized service center.
	The plastic bag that this machine was supplied in should be kept out of the reach of children or disposed of. Never allow children to play with the bag due to the danger of suffocation.
	Before performing any maintenance procedures described in this manual, unplug the power cord. Otherwise, a fire, electric shock or damage to the machine may result.

CAUTION

	While the machine is operating, make sure that shirt sleeves, neckties, hair or jewelry do not become pulled in. Otherwise, injuries may result. If anything is pulled in, immediately unplug the power cord to stop the machine.
	Do not touch the sharp edge of the blade. Otherwise, injuries may result.
	Pay close attention to the carriage movements while the machine is operating. Keep your hands away from all moving parts, such as the rollers, carriage and holders. Do not place your fingers under the blade holder. In addition, keep your fingers away from moving parts such as under the tray, in the front cover or under the operation panel. Otherwise, injuries may result.
	In order to prevent injuries, do not trace or rub your hand or fingers along the end of the blade holder while the blade tip is extended. Store the blade tip within the holder when the blade holder is not being used.
	In order to prevent injuries, do not trace or rub your hand or fingers along the edge of the mat.
	Do not allow this machine to be used as a toy. Pay close attention when the machine is used near children.
	When moving the machine, be sure to grasp its handles. If any other part is grasped, the machine may be damaged or fall, possibly resulting in injuries.
	When lifting the machine, be careful not to make any sudden or careless movements. Otherwise, injuries to your back or knees may result.
	Only use the genuine parts specified in this manual. Use of any other parts may result in injuries or damage to the machine.

IMPORTANT

	When cutting, be sure to adjust the blade extension according to the material that will be cut. If too much of the blade is extended, the blade may break or the mat may be cut.
	Do not use a broken blade. Otherwise, cutting cannot be performed correctly. If the blade breaks, remove the broken piece of blade from the cut material. When removing the broken piece of blade from the cut material, use tweezers; do not touch it with your fingers.
	Do not place the AC adapter, power cord and foreign objects within the range of the mat's movements (feed area). Otherwise, operations cannot be completed correctly.
	Do not place large objects on the mat.

	Do not fold or stretch the mat with extreme force. If the mat is damaged, it may no longer be possible to cut, draw or scan.
	Do not use a damaged mat.
	Make sure that the edges of the mat do not become dirty. Otherwise, the mat type cannot be detected, which will interfere with the proper operation of the machine. If the edges become dirty, wipe them with a dry cloth.
 	Use a mat designed specifically for this machine. In addition, do not use hard materials, such as metal sheets, which are incompatible with this machine. Otherwise, damage to the machine may result.
	Avoid using craft paper or fabric covered with decorative layer (that can easily separate), such as lamé or foil. The separate layer may stick to the machine's scanning device or feed rollers during operation, resulting in damage to the machine. It may also damage the cutting blade.
	While the machine is operating, do not pull out or push in the mat with extreme force. Otherwise, the blade or holder may be damaged.
	Do not leave material attached to the mat for a long period of time; otherwise, the adhesive will permeate the material.
	Store the mat at room temperature and in a location not exposed to high temperatures, high humidity or direct sunlight.
	If the carriage must be moved by hand in an emergency, move it slowly. Otherwise, damage to the machine may result.
	Before replacing the holder, check that the holder is not moving.
	While the machine is operating, do not unplug the power cord or remove the USB flash drive. Otherwise, the USB flash drive may be damaged or the data may be corrupted.
	Do not insert foreign objects into the DC power jack or USB port on the machine. Be sure to make space available around them.
	Only connect a USB flash drive to the USB port. Otherwise, damage to the machine may result.
	Do not touch the screen while the machine is cutting, drawing or scanning.
	Do not oil the machine. Otherwise, damage to the machine may result.
	Do not use organic solvents, such as thinner, benzene or alcohol, to clean the machine. Otherwise, the finish may peel off or other damage to the machine may result. Clean the machine by wiping it with a soft, dry cloth.
	Do not peel off any labels (for example, the serial number label) affixed to the machine.

Unlawful Use of Scanning Equipment

It is an offence to make reproductions of certain items or documents with the intent to commit fraud. The following is a non-exhaustive list of documents which it may be unlawful to produce copies of. We suggest you check with your legal adviser and/or the relevant legal authorities if in doubt about a particular item or document:

- Currency
- Bonds or other certificates of debt
- Certificates of Deposit
- Armed forces service or draft papers
- Passports
- Postage stamps (cancelled or uncanceled)
- Immigration papers
- Welfare documents
- Cheques or drafts drawn by governmental agencies
- Identifying badges or insignias

Copyrighted works cannot be copied lawfully, subject to the "fair dealing" exception relating to sections of a copyrighted work. Multiple copies would indicate improper use. Works of art should be considered the equivalent of copyrighted works.

Precautions for Scanning

After using the machine to scan an original, check that the scan data meets the requirements for precision and quality.

Since some parts of the scan data may be missing or deficient, observe the following precautions.

- Depending on the condition of the original, cracks, skewing, smearing or loss may occur, and some or all of the scan data may be missing.
 - ▶ Make sure that there are not wrinkles or folds in the original. In addition, correctly attach the original to the mat.
- If an original is scanned while the inside of the machine is dirty, cracks, skewing, smearing or loss may occur, and some or all of the scan data may be missing.
 - ▶ Carefully clean the inside of the machine.
- Depending on the scan settings (scan size and resolution), originals may be scanned as described below.
 - With an insufficient resolution, the image may be blurry.
 - A part of the image may be missing, or the size may be reduced.
 - Scan data from midway of the original to the end may be missing.
 - Margins may be added to the edges of the scan data.
- Do not scan the following types of originals.
 - Paper clips or staples attached
 - Ink that is not dry
 - Metal or overhead projector transparencies
 - Glossy sheets or having a mirror-like finish
 - Plastic cards that have been embossed
 - Originals that exceed the recommended thickness
- With non-standard originals or even in the case of standard originals, the original may become jammed depending on its condition (for example, wrinkled, folded or incorrectly loaded) or the condition of the consumables and the feeding mechanism in the machine. In this case, some or all of the scan data may be missing. (The original may be damaged if it becomes jammed.)
- If a fluorescent marker has been used on the original, the color may not be scanned, depending on the marker color and thickness, or the hue may not be faithfully reproduced.

REGULATION

Federal Communications Commission (FCC) Compliance Notice (For USA Only)

This equipment has been tested and found to comply with the limits for a Class B digital device, pursuant to Part 15 of the FCC Rules. These limits are designed to provide reasonable protection against harmful interference in a residential installation. This equipment generates, uses, and can radiate radio frequency energy and, if not installed and used in accordance with the instructions, may cause harmful interference to radio communications. However, there is no guarantee that interference will not occur in a particular installation. If this equipment does cause harmful interference to radio or television reception, which can be determined by turning the equipment off and on, the user is encouraged to try to correct the interference by one or more of the following measures:

- Reorient or relocate the receiving antenna.
- Increase the separation between the equipment and receiver.
- Connect the equipment into an outlet on a circuit different from that to which the receiver is connected.
- Consult the dealer or an experienced radio/TV technician for help.

IMPORTANT

Changes or modifications not expressly approved by Brother Industries, Ltd. could void the user's authority to operate the equipment.

Industry Canada Compliance Statement (For Canada Only)

This Class B digital apparatus complies with Canadian ICES-003.

CONTENTS

INTRODUCTION	1
IMPORTANT NOTICE	1
IMPORTANT SAFETY INSTRUCTIONS	1
Symbols Used in This Document.....	1
Important Safety Instructions.....	2
REGULATION	6
FEATURES.....	8
Patterns (“Pattern” mode).....	8
Scanning (“Scan” mode).....	8
1 GETTING STARTED.....	9
PARTS AND FUNCTIONS	9
Unit Descriptions - Front.....	9
Unit Descriptions - Rear.....	9
Unit Descriptions - Operation Panel	9
FIRST STEPS.....	10
Removing the Transport Packing Materials	10
Adjusting the Angle of the Operation Panel	10
Turning On/Off the Machine.....	10
Operation of LCD Panel	11
Preparation of Craft Paper/Fabric	11
Mat and Cutting Blade Combinations.....	12
Adjusting the Blade Extension	18
Installing and Uninstalling the Holder.....	19
Trial Cutting.....	19
MACHINE SETTINGS	23
Settings Screen	23
Auto Shutdown.....	24
2 BASIC OPERATIONS.....	25
PATTERN CUTTING	25
Tutorial 1 - Cutting Patterns.....	25
Tutorial 2 - Cutting Advanced Patterns.....	27
PATTERN SELECTION	31
Selecting a Single Pattern	31
Selecting Multiple Patterns	31
3 ADVANCED OPERATIONS ...	33
CUTTING AND EDITING FUNCTIONS.....	33
Pattern Editing Functions.....	33
Pattern Editing Functions - Advanced Patterns...	34
Pattern Layout Screen.....	35
Layout Editing Functions.....	35
Welding	
(Merging the Outlines of Multiple Patterns).....	36
Auto Layout Functions	38
Scanning a Background Image.....	38
Character Input Functions.....	40
MEMORY FUNCTIONS	41
Saving.....	41

Recalling.....	41
DRAWING FUNCTIONS	43
Drawing	43
Cutting Around Drawings.....	44

4 SCANNING FUNCTIONS ... 47

SCANNING FOR CUTTING (Direct Cut).....	47
Tutorial 3 - Scanning and Cutting	47
Advanced Cutting Functions.....	49
CREATING CUTTING DATA (Scan to Cut	
Data).....	50
Tutorial 4- Creating Cutting Data	50
Editing Pictures	52
SCANNING IMAGES (Scan to USB).....	54
Notes on Scanning.....	54
Tutorial 5- Scanning to USB	54

5 APPENDIX 56

CONSUMABLES.....	56
Replacement Criteria.....	56
Replacing the Blade	56
CARE AND MAINTENANCE	58
Cleaning	58
Cleaning the Scanner Glass.....	59
Adjusting the Screen	60
TROUBLESHOOTING	61
ERROR MESSAGES.....	64
UPGRADING THE SOFTWARE.....	66
OPTIONAL ACCESSORIES.....	66
INDEX.....	67

FEATURES

Patterns (“Pattern” mode)

Select a pattern and edit it to create your own design. By simply loading craft paper or fabric, you can quickly create precision paper and fabric cutouts.



The variety of built-in patterns can easily be edited to create designs.

Scanning (“Scan” mode)

Scan an illustration, photo or your own drawing to create personalized cut designs. The design can then be cut out or saved as data.

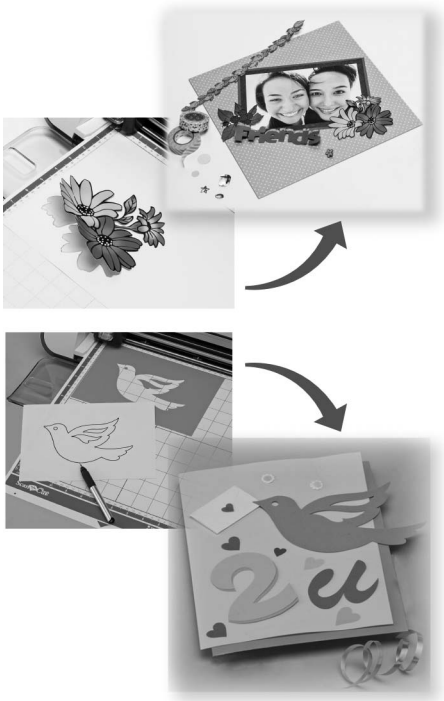

The many editing functions allow you to easily process the scanned design. The laid-out design can be saved and recalled at any time.

Home screen

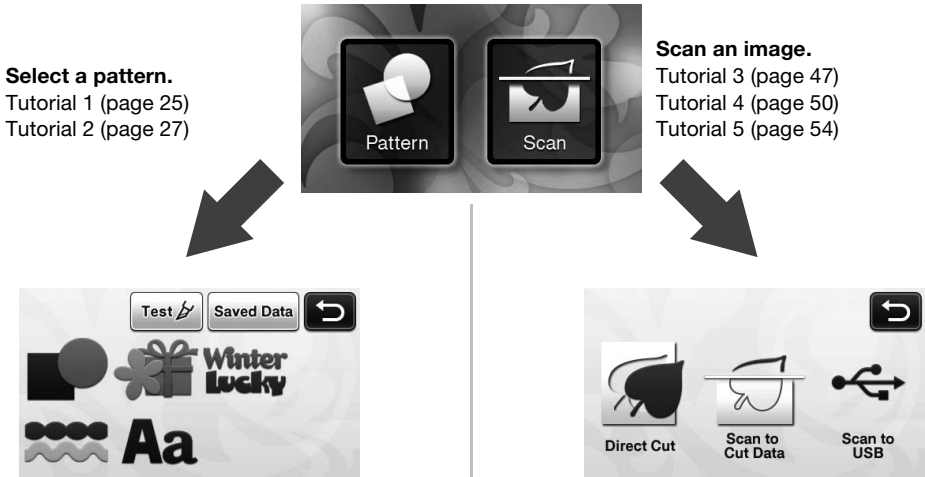

Chapter 1 GETTING STARTED

PARTS AND FUNCTIONS

Unit Descriptions - Front

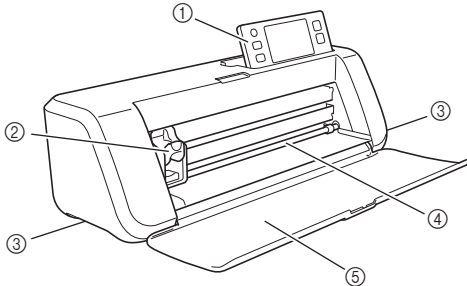

① **Operation Panel**

Allows you to control the unit and specify settings with the LCD panel and operating buttons. The angle of the operation panel can be adjusted to one of three levels. For details, see “Adjusting the Angle of the Operation Panel” on page 10.

② **Carriage**

Moves the installed holder for cutting or drawing.

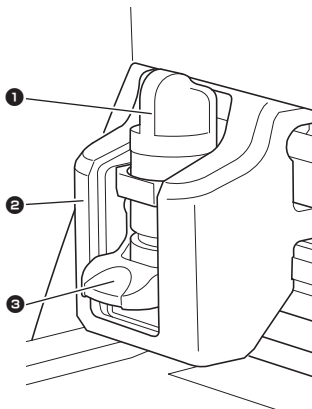

① **Holder**

Installs in the carriage to cut or draw on craft paper or fabric. Use the holder designed specifically for cutting or drawing.

② **Holder Guide**

The guide secures the holder.

③ **Holder Lock Lever**

Releases the holder when the lever is raised. Locks the holder when the lever is lowered.

③ **Handles**

Grasped when moving the machine.

④ **Feed Slot**

Feeds in or out a cutting/scanning mat. The mat is fed by the feed rollers on both sides.

⑤ **Front Tray Cover**

Protects the feed rollers, carriage and holder. Open the cover while the machine is operating.

Unit Descriptions - Rear

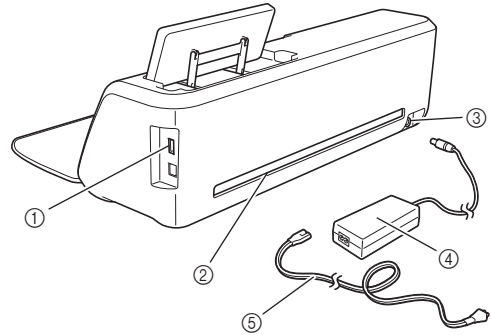

① **USB Port**

Allows a USB flash drive to be connected for saving and recalling data.

② **Slot**

Allows a mat to be fed back and forth during an operation. Do not place any objects near the slot that would prevent the mat from being fed out.

③ **DC Power Jack**

④ **AC Adapter**

⑤ **AC Power Cord**

Unit Descriptions - Operation Panel

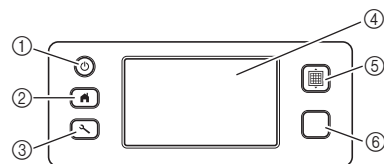

① **Power Button**

Turns the machine on/off.

② **Home Button**

Displays the home screen (starting screen for operating this machine).

③ **Settings Button**

Displays the settings screen for specifying various settings. For details, see “Settings Screen” on page 23.

④ **LCD Panel**

Displays operation screens, preview images of patterns and error messages.

⑤ **Feed Button**

Feeds the loaded mat in to or out from the feed slot. Be sure to press this button to feed the mat when loading or unloading it.

⑥ **Start/Stop Button**

Starts or stops cutting, drawing or scanning. When the button function is available, it lights up in green.

FIRST STEPS

The following procedures describe basic operations, from preparing the material to performing trial cutting.

Removing the Transport Packing Materials

Before turning on the machine, remove the shipping tape and the cardboard shock-absorbing material.

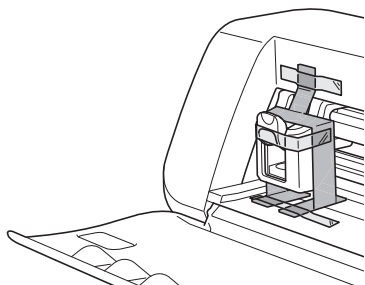

Note

- If the packing materials were removed after the machine was turned on, turn the machine off, then on again. Continuing to use the machine without restarting it may result in incorrect operation.

Adjusting the Angle of the Operation Panel

The angle of the operation panel can be adjusted to one of three levels.

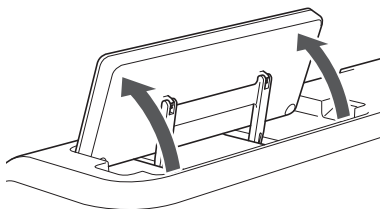

To store away the operation panel, first raise it until it is vertical, and then it can be lowered and stored away. If you wish to decrease the angle of the operation panel, raise it until it is vertical, and then adjust the angle again.

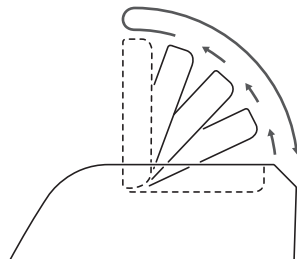

Note

- Follow the instructions provided above to lower the panel. Lowering it forcibly may cause damage to the panel.

Turning On/Off the Machine

- 1 Connect the power cord to the AC adapter, and then connect the AC adapter to the machine.

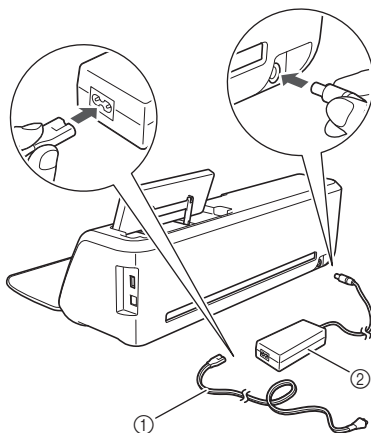

- 1 Power cord
- 2 AC adapter



Memo

- When using the AC adapter, untie the bundled cord.

- 2 Plug the power cord into an electrical outlet.

3 Press in the operation panel.

When the opening screen appears, touch anywhere on the display.

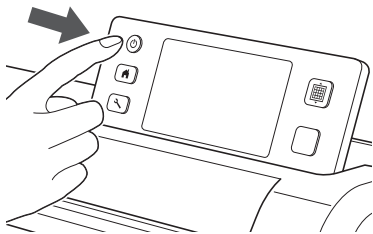

- ▶ When the following message appears, touch the "OK" key.

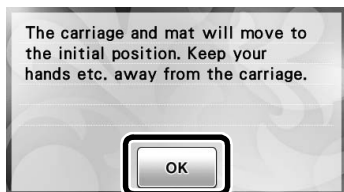

- ▶ The home screen appears.

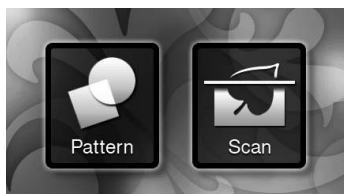

Memo

- LCD panels commonly have bright spots (permanently lit dots) and dark spots (unlit dots). It may cause some unexpected luminous spots to appear and tiny picture elements to be missed in the screen. Please note that this is not a sign of malfunction.

4 To turn off the machine, press in the operation panel.

5 Disconnect the power cord from the AC adapter, and then disconnect the AC adapter from the machine.

Note

- Do not wind the AC adapter cable around the adapter or bend the cable, otherwise the cable may be damaged.



Operation of LCD Panel

After the machine is turned on, the operation screens appear in the touch panel. To perform operations in the screens, use the included touch pen.

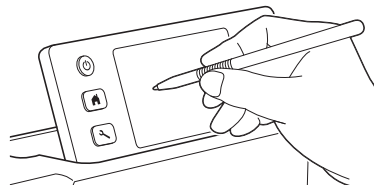

Note

- Never use a hard or pointed object, such as a mechanical pencil or screwdriver, to make a selection in the screens. Otherwise, damage to the machine may result.

Preparation of Craft Paper/Fabric

Prepare the material for cutting, drawing and scanning (Direct Cut), based on the following conditions.

Required Material Condition	Paper	Fabric
Size	(When using a 12" × 12" (305 mm × 305 mm) mat.) Max: 305 mm × 305 mm (12" × 12") The work area for cutting/drawing is 296 mm × 298 mm (11 3/4" × 11 3/4").	
Thickness*	0.1 mm to 0.3 mm	0.2 mm to 1.5 mm
Type	scrapbook paper, cardstock, vellum	cotton fabric, felt

* Recommended thickness varies depending on the type of material used.

Note

- Avoid using craft paper or fabric covered with decorative layer (that can easily separate), such as lamé or foil. The separate layer may stick to the machine's scanning device or feed rollers during operation, resulting in damage to the machine. It may also damage the cutting blade. If such media is used or tested it is recommended to clean the scanner glass at the bottom of the machine after every use (page 59).

Memo

- When using an optional 12" × 24" (305 mm × 610 mm) mat, the maximum work area for cutting/drawing is 296 mm × 603 mm (11 3/4" × 23 3/4").
- Some fabrics with uneven surfaces can be cut if turned upside down.

Mat and Cutting Blade Combinations

Use the following chart to select the correct combination of accessories for the material to be cut or drawn on. Depending on the machine model, some accessories listed in the chart may not be included. In that case, they must be purchased separately.

	Cutting blade	Mat	Sheet	Recommended Combination
Lightweight paper (vellum)	Standard cut blade (turquoise)	Low tack adhesive mat (turquoise)	–	① (page 12)
Medium weight paper (scrapbook paper)			–	② (page 13)
Lightweight fabric (for quilt piecing)		Standard mat (turquoise and purple)	High tack adhesive fabric support sheet (light blue backing)	③ (page 13)
Lightweight fabric (for any use other than quilt piecing)			Iron-on fabric appliqué contact sheet (white backing)	④ (page 15)
Medium weight fabric (for any use other than quilt piecing)	*Deep cut blade (purple)			⑤ (page 17)

* Use the deep cut blade with heavy weight fabrics (0.5 to 1.5 mm), such as felt and denim.

■ ① Lightweight Paper

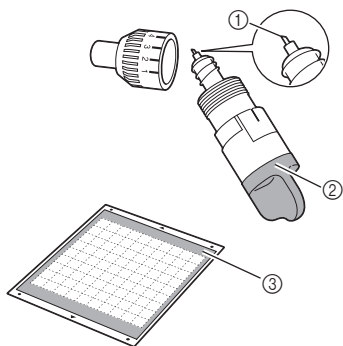

- ① Standard cut blade
- ② Standard cut blade holder (turquoise)
- ③ Low tack adhesive mat (turquoise)

Attaching the Material (Lightweight Paper)

- ① Peel off the protective sheet from the adhesive side of the mat.

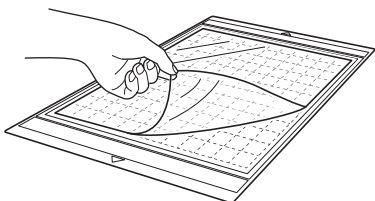

Note

- Do not discard the protective sheet peeled off the mat; save it for later use.
- When the mat is not being used, clean the adhesive side and affix the protective sheet before storing it. For details, see “Cleaning the Mat” on page 58.

② Test attaching the material.

Before attaching the material to the mat, use a corner of the adhesive side of the mat to test attaching it. Check for the following when testing attaching the material.

- The color does not come off the material when it is peeled off.
- The material is not torn or deformed when it is peeled off.

If any problems occur when testing attaching, use different material.

③ Attach the material to the mat's adhesive side.

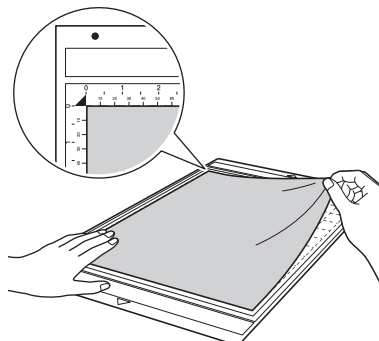



Note

- Place the material within the attaching area (grid area) on the adhesive side. If the material extends from the attaching area, it may be damaged by the feed rollers when the mat is fed.



Memo

- The mat does not have a top and bottom. It can be inserted into the feed slot from either end.

4 Firmly attach all of the material to the mat so that there are no wrinkles and no part can curl off.

- Otherwise, curls in the material may become caught when the mat is inserted.

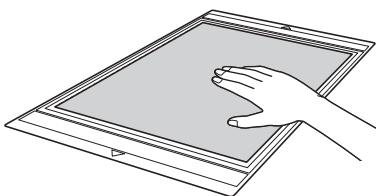

Note

- If the mat is dirty, clean it. For details, see "Cleaning the Mat" on page 58.

Peeling Off the Material (Lightweight Paper)

Follow the steps in adjusting the blade extension (page 18), installing the blade holder (page 19) and trial cutting (page 19) to set up your machine. After cutting the material, use a spatula to slowly peel off the paper.

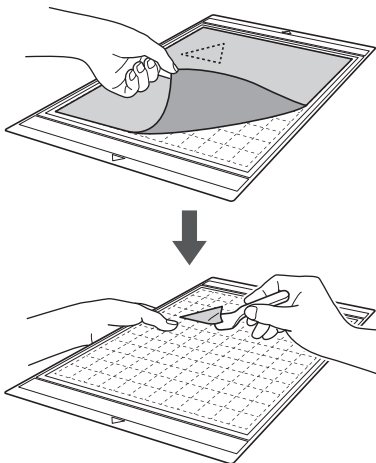

2 Medium Weight Paper

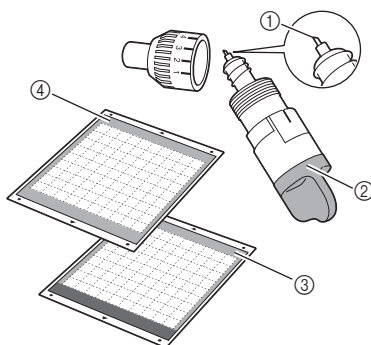

- Standard cut blade
- Standard cut blade holder (turquoise)
- Standard mat (turquoise and purple)
- Low tack adhesive mat (turquoise) (When cutting slick paper)

Attaching the Material (Medium Weight Paper)

Follow the steps in "Attaching the Material (Lightweight Paper)" on page 12.

Peeling Off the Material (Medium Weight Paper)

Follow the instructions in "Peeling Off the Material (Lightweight Paper)" on page 13.

3 Lightweight Fabric for Quilt Piecing

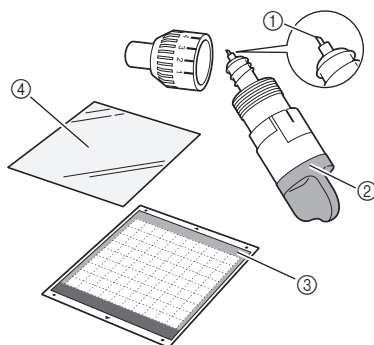

- Standard cut blade
- Standard cut blade holder (turquoise)
- Standard mat (turquoise and purple)
- High tack adhesive fabric support sheet (light blue backing)

Attaching the Material (Lightweight Fabric for Quilt Piecing)

Use the specially designed adhesive sheet to attach lightweight fabrics for quilt piecing to the standard mat. The high-tack adhesive fabric support sheet is perfect for quilt piecing since it will not leave adhesive on the surface of fabric. Support sheets can be repeatedly used unless they are peeled off the mat. They should only be used with patterns that have a seam allowance. When cutting patterns without a seam allowance, use the iron-on fabric appliqué contact sheet.

- 1** Peel off the protective sheet from the adhesive side of the standard mat.

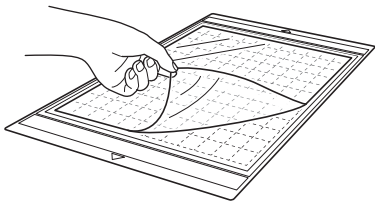

Note

- Do not discard the protective sheet peeled off the mat; save it for later use.

- 2** With the glossy side of the support sheet facing down, attach it to the mat's adhesive side.

Slowly attach the support sheet from its edges so that no air is trapped between the mat and the sheet.

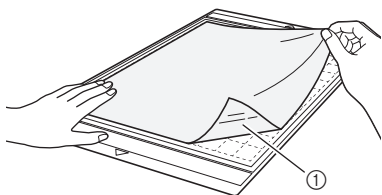

- ① Glossy side of support sheet



Note

- Place the support sheet within the attaching area (grid area) on the adhesive side of the mat. If the sheet extends from the attaching area, it may be damaged by the feed rollers when the mat is fed.

- 3** Peel off the backing from the top of the support sheet.

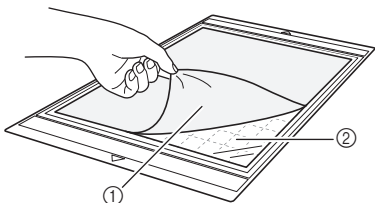

- ① Backing (light blue)
② Adhesive

- 4** Test attaching the material.

Before attaching the material to the mat, use a corner of the adhesive side of the mat to test attaching it. If any problems occur when testing attaching, use different material.

- 5** From its edges, attach the material to the adhesive side of the mat so that there are no wrinkles in the material.

Be sure to first iron the fabric to remove any wrinkles.

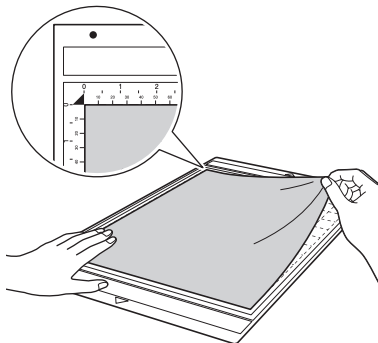

Note

- Place the material within the attaching area (grid area) on the adhesive side. If the material extends from the attaching area, it may be damaged by the feed rollers when the mat is fed.



Memo

- The mat does not have a top and bottom. It can be inserted into the feed slot from either end.
- Be sure that the vertical grain of the attached fabric runs straight up and down. The built-in patterns are automatically arranged suitable for fabric with vertical grain.
- When drawing a seam allowance, attach the fabric to the mat with its wrong side facing up.

- 6** Firmly move the spatula handle across the surface of the fabric to remove any wrinkles and firmly attach the fabric to the mat.

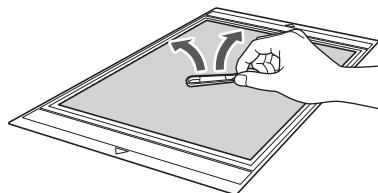

Peeling Off the Material (Lightweight Fabric for Quilt Piecing)

Follow the steps in adjusting the blade extension (page 18), installing the blade holder (page 19) and trial cutting (page 19) to set up your machine. After cutting the material, use a spatula to slowly peel off just the fabric. Try not to peel off the support sheet.

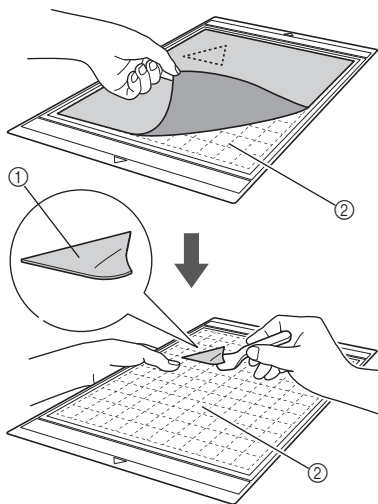

- ① Fabric cut out
- ② Support sheet remaining on mat



Note

- The support sheet may be unintentionally peeled off while you are removing the fabric from the mat under the following conditions:
 - The adhesive between the mat and support sheet is becoming weak after repeated uses.
 - The support sheet tends to be strongly attached to a certain types of fabrics.
 In this case, use the included spatula to hold the support sheet on the mat and remove the fabric using your hand.
- After cutting, carefully remove any fibers remaining on the support sheet.
- When attaching fabric with an iron-on sheet attached or paper to the mat, cleanly peel off the support sheet from the mat, or attach the material to a different standard mat without a support sheet attached.
- Do not leave material attached to a mat with a support sheet attached for a long period of time; otherwise, the adhesive will permeate the material.

Notice on Use of Support Sheet

- When the sheet's adhesive strength decreases or fabric becomes twisted while being cut, replace the sheet with a new one.
- When peeling the sheet off the mat or replacing the sheet, use the spatula to carefully remove the old sheet.
- Store the mat in between uses with the protective sheet affixed to the support sheet.

- If a mat with a support sheet attached is not to be used for a certain length of time, peel the support sheet off the mat and affix the protective sheet on the adhesive side of the mat before storing it.
- Do not reuse a support sheet that has been attached to the mat.
- Attach a stabilizer to fabric when not using a support sheet for cutting.
- Store the support sheet at room temperature and in a location not exposed to high temperatures, high humidity or direct sunlight.
- Do not bend the support sheet to store it.

④ Lightweight Fabric for Any Use Other Than Quilt Piecing

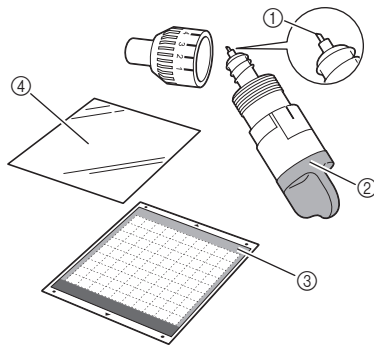

- ① Standard cut blade
- ② Standard cut blade holder (turquoise)
- ③ Standard mat (turquoise and purple)
- ④ Iron-on fabric appliqué contact sheet (white backing)

Attaching the Material (Lightweight Fabric for Any Use Other Than Quilt Piecing)

Iron the specially designed contact sheet to the back of fabrics for any use other than quilt piecing, and then attach them to the standard mat.

The double-faced adhesive type of the iron-on fabric appliqué contact sheet reinforces the fabric and enables any pattern to be cut easily, including appliqués.

The sheet cannot be removed once it has been attached to the back of fabrics. For quilt piecing, use the high-tack adhesive fabric support sheet and avoid using the iron-on fabric appliqué contact sheet.



Note

- The contact sheet may not adhere to a fabric surface that is so rough that the two surfaces cannot be heat-set to adhere to each other.

- 1 Peel off the protective sheet from the adhesive side of the standard mat.**

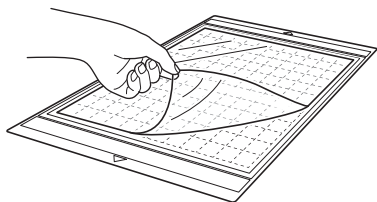

Note

- Do not discard the protective sheet peeled off the mat; save it for later use.
- When the mat is not being used, clean the adhesive side and affix the protective sheet before storing it. For details, see “Cleaning the Mat” on page 58.

- 2 Cut the contact sheet to a size 2 cm or more larger than the outline of the pattern to be cut.**

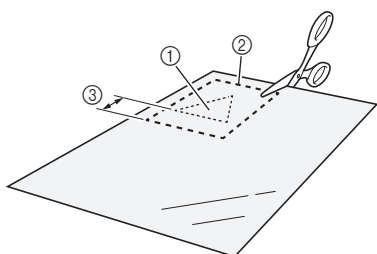

- ① Pattern to be cut
- ② Cutting line of sheet
- ③ Margin of 2 cm or more

- 3 With the glossy side of the contact sheet facing down, place it on the wrong side of the fabric.**

Be sure to first iron the fabric to remove any wrinkles. Before placing the contact sheet on the fabric, make sure that the fabric has been allowed to cool after ironing.

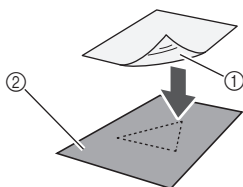

- ① Glossy side of contact sheet
- ② Wrong side of fabric

- 4 Evenly iron the entire contact sheet to affix it to the wrong side of the fabric.**

With the iron on a medium temperature setting (140 to 160 °C (284 °F to 320 °F)), press each part of the sheet for about 20 seconds (the length of time differs depending on the material).

Be sure to apply pressure on the top of the backing and push out any air between the sheet and fabric.

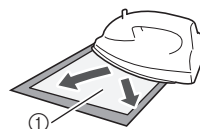

- ① Backing



Note

- Before attaching the contact sheet to the fabric, use a piece of the sheet to test attaching it. If any problems occur when testing attaching, use different material.
- Leaving the iron in the same place for too long may scorch or melt the material.

- 5 Peel off the backing from the contact sheet.**

Before peeling off the backing, allow all parts to cool.

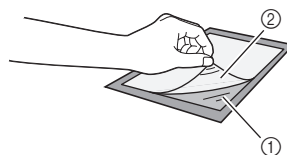

- ① Contact sheet
- ② Backing

- 6 With the side of the fabric that the contact sheet is attached to facing down, attach the material to the mat from its edges.**

Slowly attach the material from its edges so that no air is trapped between it and the mat.

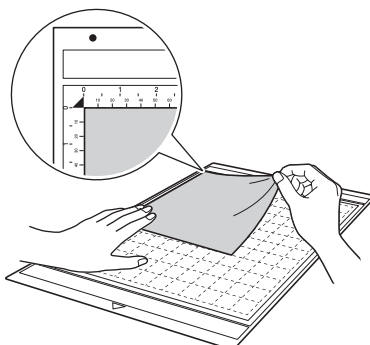



Note

- Place the material within the attaching area (grid area) on the adhesive side. If the material extends from the attaching area, it may be damaged by the feed rollers when the mat is fed.



Memo

- The mat does not have a top and bottom. It can be inserted into the feed slot from either end.
- Be sure that the vertical grain of the attached fabric runs straight up and down. The built-in patterns are automatically arranged suitable for fabric with vertical grain.

7 Firmly attach all of the material to the mat so that there are no wrinkles and no part can curl off.

- Otherwise, curls in the material may become caught when the mat is inserted.

Peeling Off the Material (Lightweight Fabric for Any Use Other Than Quilt Piecing)

Follow the steps in adjusting the blade extension (page 18), installing the blade holder (page 19) and trial cutting (page 19) to set up your machine. After cutting the material, use a spatula to peel off the fabric together with the attached contact sheet.

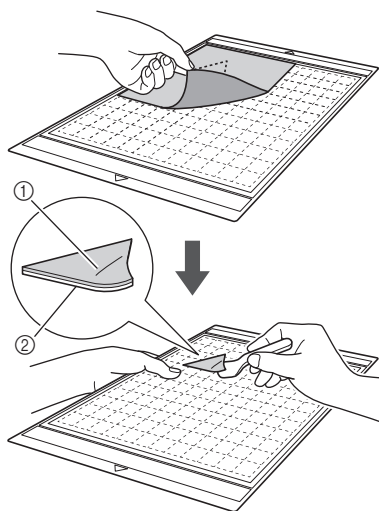

- Pattern that was cut out
- Contact sheet



Note

- Do not place anything heated on the fabric attached with a contact sheet. Adhesive will permeate any other pieces of fabric around.

Attaching Fabrics With the Double-Sided Adhesive

Place a cutout on a base fabric and apply pressure on the top of the cutout using an iron. (The contact sheet may not adhere well to some fabrics.) Hand or machine stitch to ensure that the cutout stays in place.

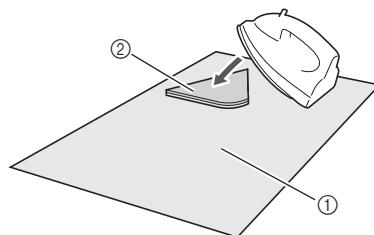

- Base fabric
- Cutout with a contact sheet



Note

- Do not wash fabrics attached together with a double-sided adhesive contact sheet.
- When attaching fabrics with the double-sided adhesive, iron carefully, being sure that the material and adhesive surfaces are properly heat-set.
- When attaching fabrics of different weights with the double-sided adhesive, first iron the lighter-weight fabric to affix the contact sheet.

Notice on Use of Contact Sheet

- Store the contact sheet at room temperature and in a location not exposed to high temperatures, high humidity or direct sunlight.

5 Medium Weight Fabric for Any Use Other Than Quilt Piecing

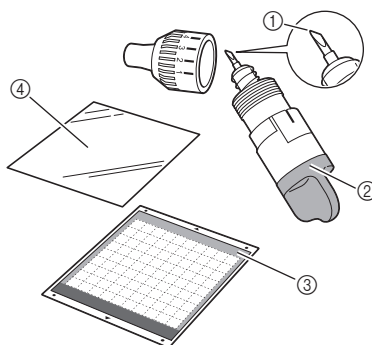

- Deep cut blade
- Deep cut blade holder (purple)
- Standard mat (turquoise and purple)
- Iron-on fabric appliqué contact sheet (white backing)

Attaching the Material (Medium Weight Fabric for Any Use Other Than Quilt Piecing)

Follow the steps in “Attaching the Material (Lightweight Fabric for Any Use Other Than Quilt Piecing)” on page 15.

Peeling Off the Material (Medium Weight Fabric for Any Use Other Than Quilt Piecing)

Follow the instructions in “Peeling Off the Material (Lightweight Fabric for Any Use Other Than Quilt Piecing)” on page 17.

Adjusting the Blade Extension

The appropriate blade extension differs depending on the material type and thickness. Before installing the holder in the carriage, turn the holder cap to adjust the blade extension, and then perform trial cutting. For details on trial cutting, see “Trial Cutting” on page 19.

■ Appropriate Blade Extension

Adjust the blade extension to slightly exceed the thickness of the material that will be cut. Use the markings on the holder to make the adjustment.

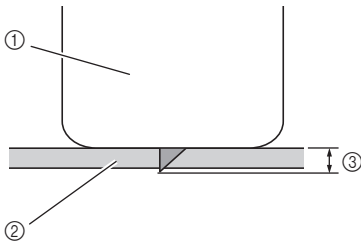

- ① End of holder cap
- ② Material that will be cut
- ③ Length of blade tip



Note

- Be careful that the blade does not extend too much. If there is too much of a blade extension, the material may not be cut cleanly and the mat will deteriorate quicker.
-

Cutting Settings

Use the following table to select the appropriate settings according to the material that will be cut.

Material Type	Blade	Scale Setting	Pressure Setting
Lightweight paper (vellum)	Standard	3	0
Heavy weight paper (cardstock)	Standard	4	0
Lightweight fabric (cotton fabric)	Standard	4	4
Heavy weight fabric (1-mm-thick felt)	Deep-cut	5	5

- * Adjust the setting for “Cut Pressure” in the settings screen (page 23).
- * Use a support sheet or contact sheet when you cut a piece of fabric out. For details, see “Mat and Cutting Blade Combinations” on page 12.



Note

- The settings indicated in the table are approximations. The setting will differ depending on the type and thickness of the material to be cut. Be sure to perform a trial cutting first.
-

■ Adjusting the Cutting Blade

- ① With the reference line on the holder facing toward you, fully turn the cap to the right to extend the blade tip to its maximum.

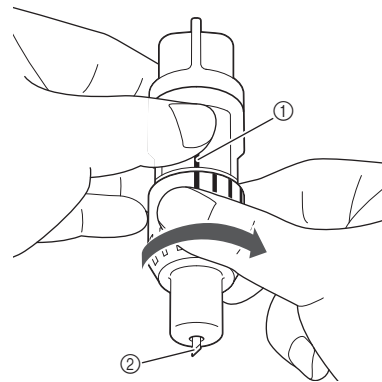

- ① Reference line
- ② Extend the blade tip to its maximum.

- 2** Check the thickness of the material, and then adjust the blade extension. See “Appropriate Blade Extension” on page 18.

The larger the holder scale setting, the further the blade extends.

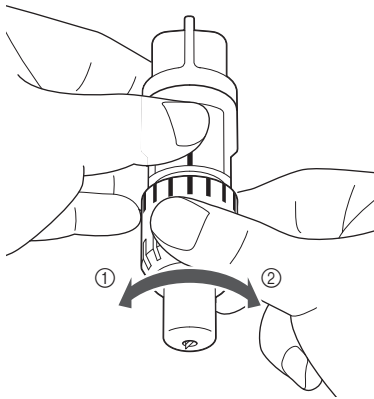

- ① Turn to the left to decrease the blade extension.
② Turn to the right to increase the blade extension.

Installing and Uninstalling the Holder

Install the holder in the machine.

- 1** Press  in the operation panel to turn on the machine.

For details, see “Turning On/Off the Machine” on page 10.

- 2** If the holder lock lever is not raised, raise it.

The holder cannot be installed if the lever is lowered.

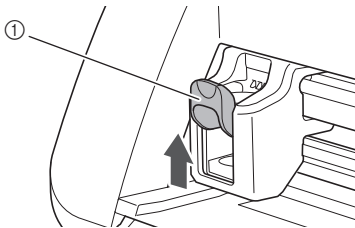

- ① Holder lock lever

- 3** Grasp the holder grip, and then insert the holder into the carriage.

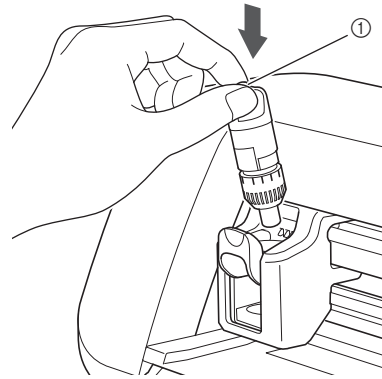

- ① Grip

- 4** Push down on the holder lock lever.

Firmly push down until the holder is locked in place.

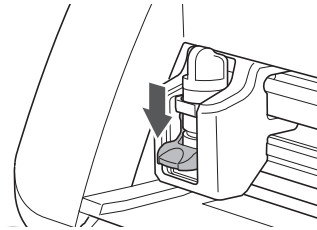

- 5** Reverse the installation procedure to uninstall the holder.



Note

- After removing the blade holder from the machine or when storing it, store the blade tip within the holder.

Trial Cutting

Make sure that the blade extension is appropriate for the material. Using the same material to cut or draw on in your project, perform trial cutting.

Turning On the Machine

Press  in the operation panel to turn on the machine.

- For details, see “Turning On/Off the Machine” on page 10.

Setting the Holder

Install the cutting blade holder into the carriage of the machine.

- For details, see “Installing and Uninstalling the Holder” on page 19.

■ Selecting the Test Pattern

Cut out a test pattern from paper.



Memo _____

- The language setting can be specified in the settings screen (see “Language” on page 23).

1 Select “Pattern” in the home screen.

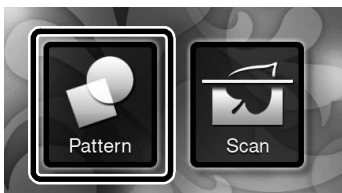

2 Touch the “Test” key in the pattern category selection screen.



3 Select a pattern in the pattern selection screen.

- We recommend using pattern “T-02” when cutting paper and pattern “T-03” when cutting fabric.

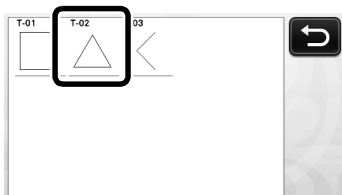

4 Touch the “Set” key.

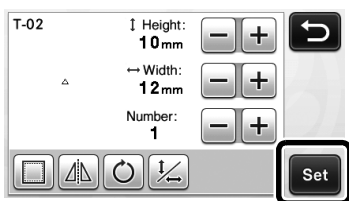

5 Check the pattern arrangement, and then touch the “OK” key.

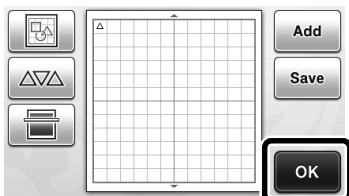

- For details on changing the pattern arrangement, see “Pattern Layout Screen” on page 35.
- Press to cancel the pattern selection, and then select the pattern again.

■ Loading the Mat

1 Attach the material that will be cut to the mat.

- For details on attaching material to the mat, see “Mat and Cutting Blade Combinations” on page 12.

2 While holding the mat level and lightly

inserting it into the feed slot, press in the operation panel.

Lightly insert the mat so that it aligns with the guides on the left and right sides of the feed slot and is tucked under the feed rollers.

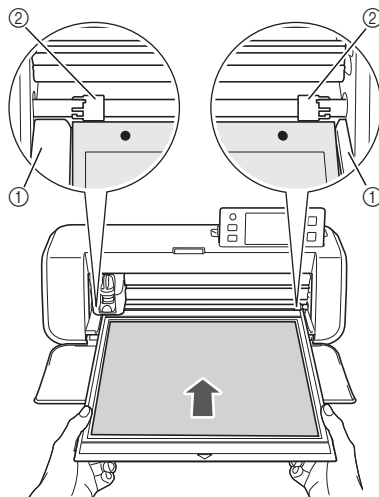

- ① Guides
- ② Feed rollers

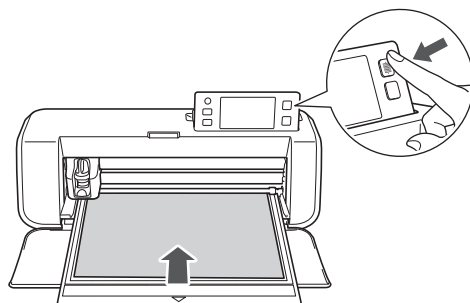

- ▶ The mat is fed in to complete the preparations for cutting.

■ Cutting

- 1 Select “Cut” in the draw/cut selection screen.

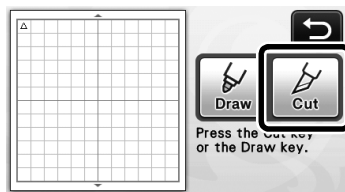



- ▶ The “Start/Stop” button in the operation panel lights up.





Note

- Make sure that patterns that will be cut out are arranged in the cutting area corresponding to the size of the material attached before continuing operation.

- 2 Adjust the cutting speed and pressure.

Before cutting the pattern, adjust the cutting speed and pressure. These adjustments can be made from the settings screen. Press  in the operation panel and touch  to display the second page of the settings screen.

- ▶ Touch  or  to change the settings and then touch the “OK” key.

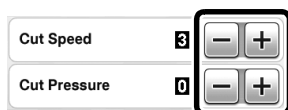

Note

- Depending on the fabric being used, it may not be cut cleanly if the cutting pressure is not correctly adjusted. For the appropriate cutting pressure, see “Cutting Settings” on page 18.

- 3 Press the “Start/Stop” button to start cutting.

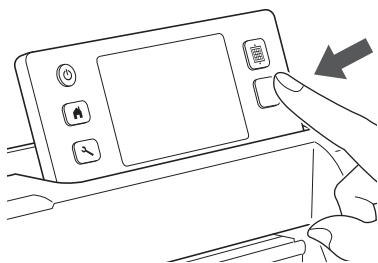

- ▶ When cutting is finished, the message “Finished cutting.” appears on the display. Touch the “OK” key to return to the draw/cut selection screen.

■ Unloading the Mat

- 1 Press  in the operation panel to feed out the mat.

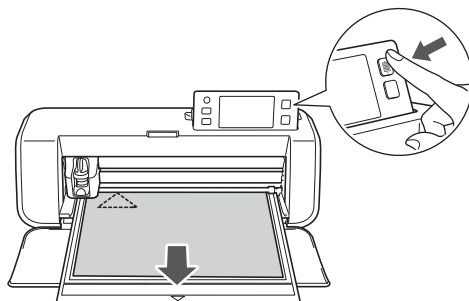

- 2 Peel off the material from an area that is easily removable, such as a corner, and then slowly peel while maintaining an even pressure.

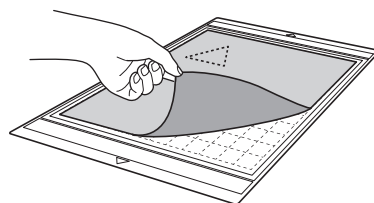

- 3 Holding the mat with your hand, use the included spatula to carefully peel off the cut-out patterns.

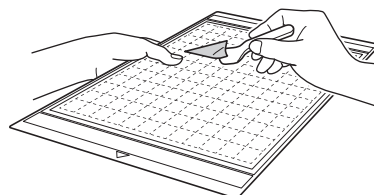

Note

- For instructions on how to peel off the material, see also “Mat and Cutting Blade Combinations” on page 12.

■ Checking the Trial Cutting Results

Adjust the blade extension according to the trial cutting results.

Repeatedly perform trial cutting and adjust the blade extension until the material is cut cleanly.

With an Appropriate Blade Extension

When the material is peeled off, a faint trace of the cut remains on the mat surface.

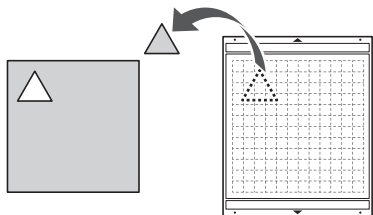

With a Blade Extension That Needs to be Adjusted

Trial cutting results	Tips for adjustment
Part of the cut material remains when it is peeled off.	Too Little of a Blade Extension: Turn the holder cap half a marking to the right. (②)
The material is not clearly cut.	Too Little of a Blade Extension: Turn the holder cap one marking to the right. (②)
There are deep cuts completely through the mat.	Too Much of a Blade Extension: Turn the holder cap one marking to the left. (①)

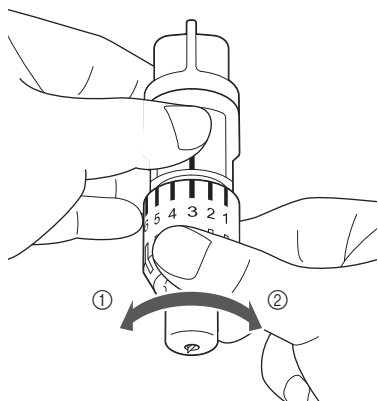

Note

- Be careful that the blade does not extend too much. If there is too much of a blade extension, the material may not be cut cleanly and the mat will deteriorate quicker.

Settings Screen

From the LCD panel, the settings for specific functions can be selected and settings can be adjusted. To display the settings screen, press  in the operation panel.

■ Page 1

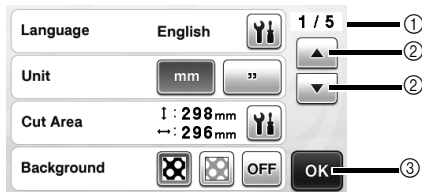

- ① Settings screen page number
- ② Touch to display a different page.
- ③ Touch to finish specifying settings.

Language

Select the display language. Touch , select the desired display language, and then touch the "OK" key.

Unit

Select either millimeters or inches as the displayed measurement units.

Cut Area

Specify the area for cutting/drawing according to the size of material to be used. Touch , and then touch and drag the area resizing keys to specify the area. When using a 12" × 24" (305 mm × 610 mm) mat, touch the mat size key to select a larger mat size, and then specify the area size.

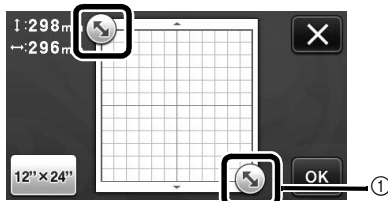

- ① Area resizing key (Using the touch pen, touch the key, and then drag it around the screen to specify the area.)

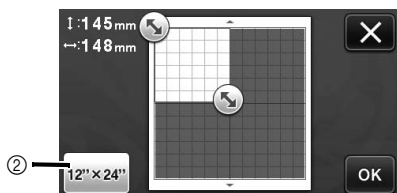

- ② Mat size key (Touching the key switches between the mat size 12" × 12" (305 mm × 305 mm) and 12" × 24" (305 mm × 610 mm).

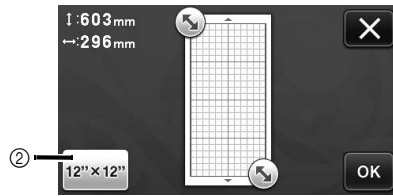

- Touch the "OK" key to apply the settings.

Touch  to return to the previous screen without applying the settings.

Background

Adjust the contrast of a background image scanned with the background scanning function. For details, see "Scanning a Background Image" on page 38.

■ Page 2

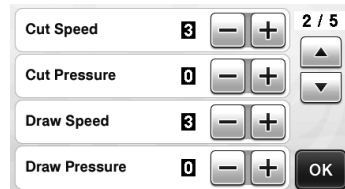

Cut Speed

Adjust the cutting speed.

Cut Pressure

Adjust the cutting pressure. For the appropriate cutting pressure, see "Cutting Settings" on page 18.

Draw Speed

Adjust the drawing speed.

Draw Pressure

Adjust the drawing pressure. Adjustments to the drawing pressure will affect the finished product. Use the same material that the pattern will be drawn on to make the adjustments in advance. If the pressure is too high, the pen tip may be damaged. Adjust the pressure appropriately.

■ Page 3

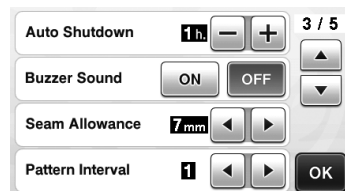

Auto Shutdown

Specify the length of time for the auto shutdown function. The setting can be specified in 1-hour increments. For details, see "Auto Shutdown" on page 24.

Buzzer Sound

Select whether or not an operation sound is produced, for example, when a key is touched.

Seam Allowance

Specify the seam allowance. This is applied when drawing on fabric, then cutting it, for example, when making quilt pieces. For details, see “Cutting Around Drawings” on page 44.



Memo

- When multiple patterns are cut at the same time, the setting specified in this screen is applied to all patterns.
- If cutting line data saved with a different seam allowance is imported and used, the setting specified in this screen will have priority over the saved setting.

Pattern Interval

Specify the spacing between patterns as well as white space around the edges of cutting area when patterns in the pattern layout screen are automatically arranged. The larger the number setting, the further spacing between patterns. For details on the auto layout function, see “Auto Layout Functions” on page 38.



Note

- Set the number to “3” or higher when lightweight fabric is attached to the mat with a high tack adhesive fabric support sheet.

Page 4

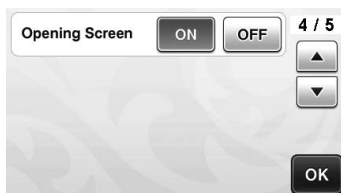

Opening Screen

Select whether the opening slide show is displayed after the machine is turned on. If the slide show is displayed, touch the screen to display the home screen.

Page 5

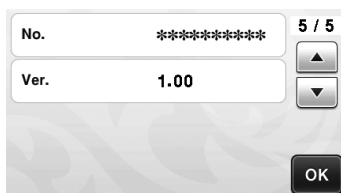

No.

Displays the serial number specific for this machine.

Ver.

Displays the version information for this software.

Auto Shutdown

If the machine is not used for a specified length of time, it will automatically turn off. The length of time until the machine turns off can be specified in the settings screen.

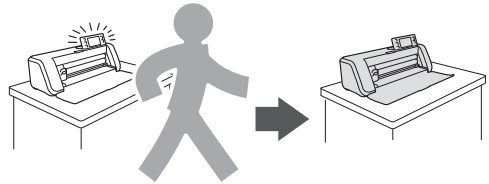

If the machine is automatically turned off after you reach the pattern layout screen, the stored information can be recalled when the machine is turned on again. Following the instructions in the message screen that appear when the machine is turned on again, touch the “OK” key to display the pattern layout screen or touch the “Cancel” key to return to the home screen.

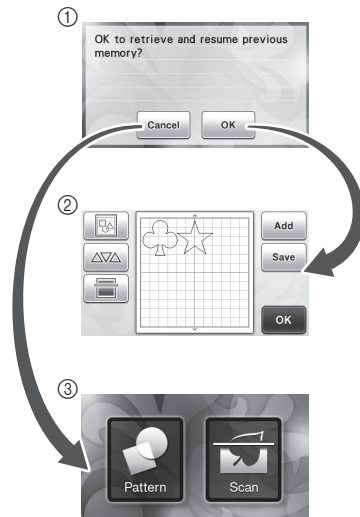

- ① Message screen
- ② Pattern layout screen
- ③ Home screen

If the machine is automatically turned off before you reach the pattern layout screen, the home screen will be displayed when the machine is turned on again.

Chapter 2 BASIC OPERATIONS

PATTERN CUTTING

The following procedures use built-in patterns to describe the entire series of operations, from selecting a pattern and editing it to cutting.

Tutorial 1 - Cutting Patterns

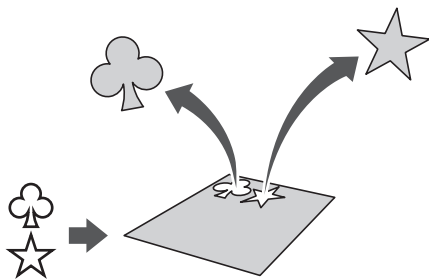

In this tutorial, we will cut two built-in patterns.

■ Turning On the Machine

Press to turn on the machine.

- For details, see “Turning On/Off the Machine” on page 10.

■ Setting the Holder

Install the cutting blade holder into the carriage of the machine.

- For details, see “Installing and Uninstalling the Holder” on page 19.

■ Selecting and Editing the First Pattern

1 Select “Pattern” in the home screen.



2 Select the category for the pattern to be cut out in the pattern category selection screen.

For this example, select .

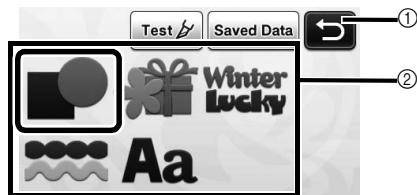

- ① Touch to return to the previous screen.
- ② Pattern categories

Memo

- The pattern categories and built-in patterns that appear in the operation screens differ depending on the machine model. For details on the built-in patterns, refer to the included pattern list.

3 Select the first pattern to be used in the pattern selection screen.

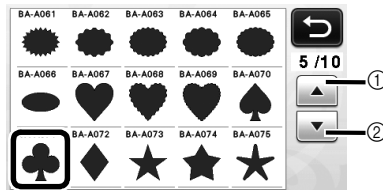

- ① Touch to scroll up.
- ② Touch to scroll down.

4 Edit the pattern using the pattern editing screen.

After editing is finished, touch the “Set” key.

- For details on the editing functions, see “Pattern Editing Functions” on page 33.

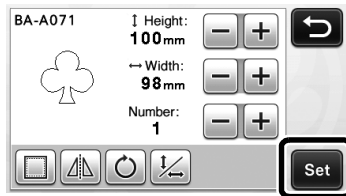

■ Selecting and Editing the Second Pattern

- 1 Touch the “Add” key in the pattern layout screen.

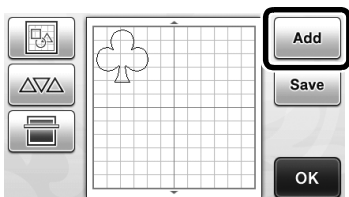

- ▶ The pattern category selection screen appears.
- Press  to cancel the pattern selection, and then select the pattern again.

- 2 Select the category for the pattern to be cut out.



- ① Touch to return to the previous screen.

- 3 Select the second pattern to be used.

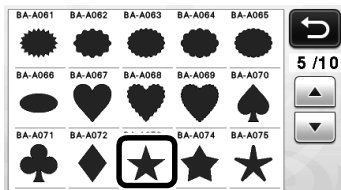

- 4 Edit the pattern.

After editing is finished, touch the “Set” key.

- For details on the editing functions, see “Pattern Editing Functions” on page 33.

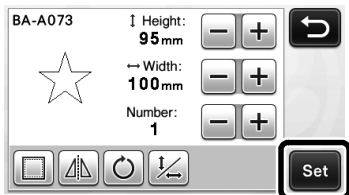

- 5 Check the pattern arrangement.

The two patterns that will be cut out appear in the pattern layout screen. After checking the arrangement, touch the “OK” key.

- From this screen, an individual pattern can be edited, moved or deleted. For details on the functions that can be used in the pattern layout screen, see “Layout Editing Functions” on page 35.
- By using the auto layout function, the arrangement of the patterns can easily be adjusted. For details, see “Auto Layout Functions” on page 38.

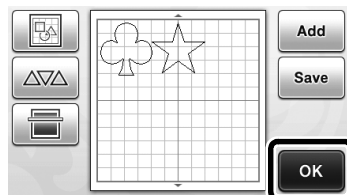

- ▶ The draw/cut selection screen appears.



Note

- Depending on the pattern type and material to be cut, the patterns may not be cleanly cut if their spacing is too small. In that case, rearrange the patterns to separate them.



Memo

- To move a pattern within the cutting/drawing area, touch the pattern on the screen and drag it to the desired position.

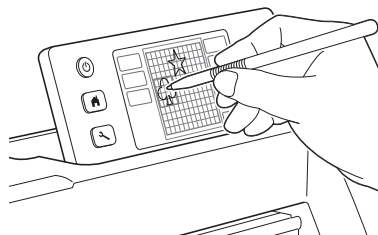

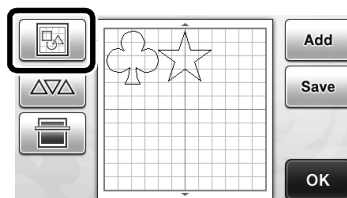

- To delete a pattern from the arrangement, select the pattern in the layout editing screen, and then use the function for deleting.

- ▶ Touch  in the pattern layout screen.

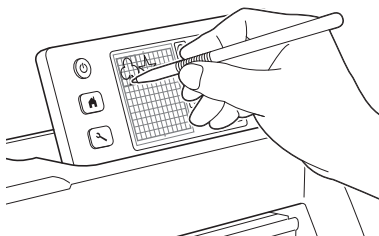

- ▶ Touch the pattern to be deleted in the screen. To delete multiple patterns, use the function for selecting multiple patterns. For details, see “Selecting Multiple Patterns” on page 31.



- ▶ Touch  in the layout editing screen to delete the selected pattern(s).

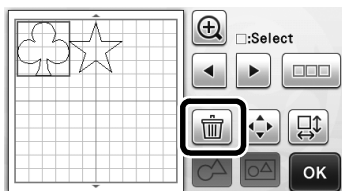

■ Loading the Mat

While holding the mat level and lightly inserting it into

the feed slot, press  in the operation panel.

- For details, see “Loading the Mat” on page 20.

■ Cutting

1 Select “Cut” in the draw/cut selection screen.

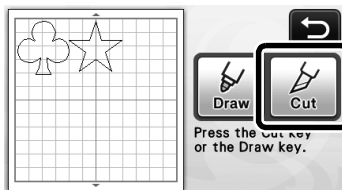

- ▶ The “Start/Stop” button in the operation panel lights up.
- Before cutting your project, adjust the blade extension appropriately. For details, see “Adjusting the Blade Extension” on page 18.



Note

- Before continuing operation, make sure that patterns that will be cut out are arranged in the cutting area corresponding to the size of the material to be used.

2 Adjust the cutting speed and pressure.

Before cutting the pattern, adjust the cutting speed and pressure. These adjustments can be made from the settings screen. Press  in the operation panel.

- ▶ Touch  or  to change the settings.

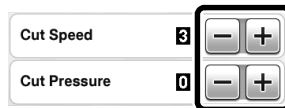

Note

- Depending on the fabric being used, it may not be cut cleanly if the cutting pressure is not correctly adjusted. For the appropriate cutting pressure, see “Cutting Settings” on page 18.

3 Press the “Start/Stop” button to start cutting.

- ▶ When cutting is finished, the draw/cut selection screen appears again.

■ Unloading the Mat

Feed out the mat, and then use the included spatula to peel off the patterns.

For details, see “Unloading the Mat” on page 21.

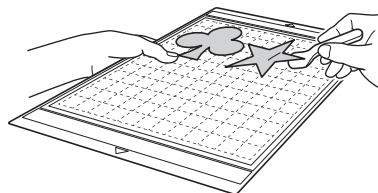

Tutorial 2 - Cutting Advanced Patterns

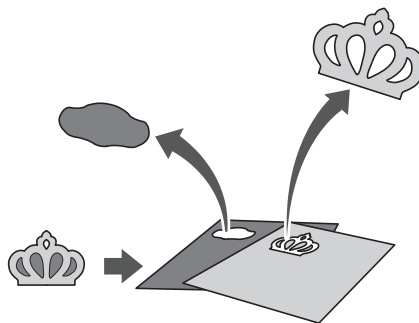

In this tutorial, we will cut a built-in pattern in the



category.

■ Selecting and Editing the First Pattern Piece

- 1 Select "Pattern" in the home screen.

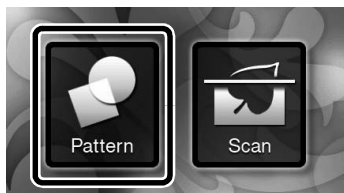

- 2 Select the category in the pattern category selection screen.



- 1 Touch to return to the previous screen.
- 2 Pattern categories

Memo

- The pattern categories and built-in patterns that appear in the operation screens differ depending on the machine model. For details on the built-in patterns, refer to the included pattern list.

- 3 Select the sub-category in the pattern sub-category selection screen.

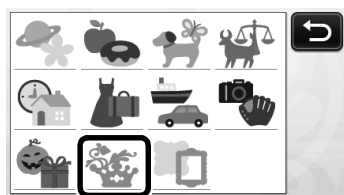

- 4 Select the pattern to be cut out in the pattern selection screen.

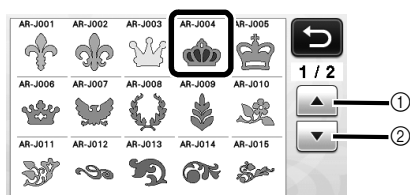

- 1 Touch to scroll up.
- 2 Touch to scroll down.

- 5 Edit the size of the entire pattern using the pattern sizing screen.

After editing is finished, touch the "OK" key.

- For details on the pattern sizing screen, see "Pattern Sizing" on page 34.

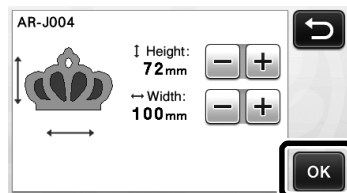

- 6 Select the piece to be edited first in the pattern piece list screen, and then touch the "OK" key.

From the pattern piece list that appears in the screen, touch a pattern piece to edit it individually.

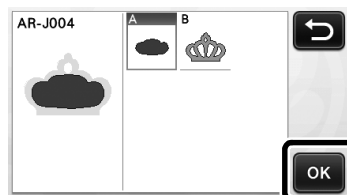
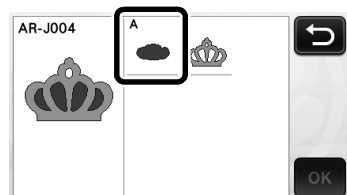

Memo

- The pattern pieces displayed in the pattern piece list screen are automatically arranged so that the grain is vertical when fabric is used as the material for cutting. Therefore, the angle at which the pattern appears in the pattern piece list may differ from the actual angle of the pattern piece to be cut out.

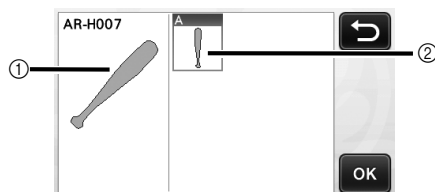

- 1 Appearance in pattern piece list
 - 2 Actual arrangement of the pattern piece to be cut out
- Change the angle of pattern piece using the rotating function according to your project. For details, see "Editing the Pattern Piece" on page 34.

7 Edit the pattern piece using the pattern piece editing screen.

After editing is finished, touch the “Set” key.

- For details on the editing functions, see “Editing the Pattern Piece” on page 34.

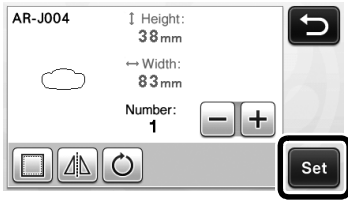

8 Check the pattern piece arrangement using the pattern layout screen.

The pattern piece to be cut out appears in the screen. After checking the arrangement, touch the “OK” key.

- From this screen, an individual pattern piece can be edited, moved, deleted or saved. For details on the editing functions in the pattern layout screen, see “Pattern Layout Screen” on page 35.

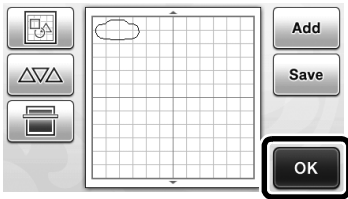

▶ The draw/cut selection screen appears.

■ Loading the Mat

Attach the material that the first pattern piece will be cut out of to the mat, and then feed in the mat from the feed slot.

When cutting a pattern consisting of multiple pieces in different colors, edit the pattern piece for each color, and then change the material to cut out each piece.

- For details on preparing the material and loading the mat, see “Loading the Mat” on page 20.

■ Cutting the First Pattern

1 Select “Cut” in the draw/cut selection screen.

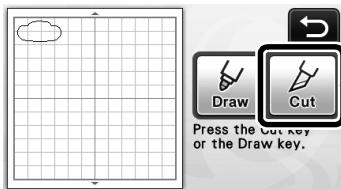

▶ The “Start/Stop” button in the operation panel lights up.



Note

- Before continuing operation, make sure that patterns that will be cut out are arranged in the cutting area corresponding to the size of the material to be used.

2 Press the “Start/Stop” button to start cutting.

- ▶ After the first pattern piece has been cut out, the following message appears. In order to cut out the second pattern piece, touch the “Select the next part” key.



- ▶ Touching the “Select the next part” key erases all editing information for the first pattern piece and displays the pattern piece list screen again.

■ Unloading the Mat

1 Press  in the operation panel to feed out the mat.

In order to replace the material with one of a different color, the material used for the first pattern piece must be fed out.

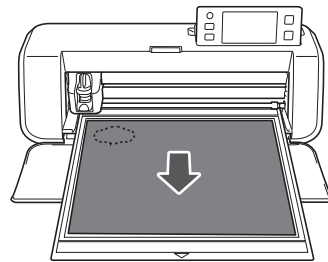

2 Peel from the mat the pattern piece that was cut out.

For details on peeling the material from the mat, see “Unloading the Mat” on page 21.

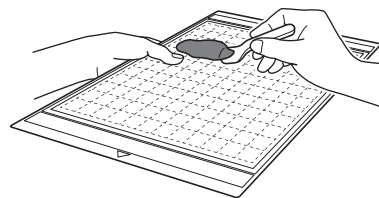

■ Editing and Cutting the Second Pattern Piece

- 1 Select and edit the second pattern piece, and then touch the “OK” key.

For details on editing the pattern, follow steps 6-B (page 29) in “Selecting and Editing the First Pattern Piece”.

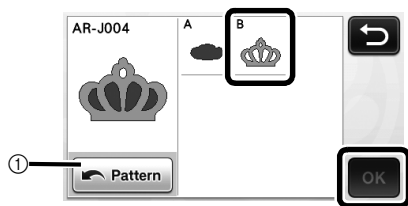

- 1 Touch to return to the pattern category selection screen for selecting another pattern.

- 2 Follow the procedures described in “Loading the Mat” (page 20) and “Cutting” (page 21) to load the material to be used for the second pattern piece and cut it out.

► When cutting is finished, a message appears.

- 3 After all pattern pieces have been cut out, touch the “Finish” key.

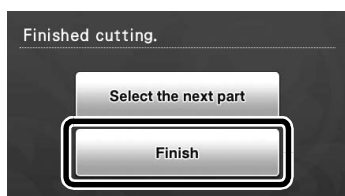

► The draw/cut selection screen appears again.

■ Unloading the Mat

Peel from the mat the pattern piece that was cut out. For details on peeling the material from the mat, see “Unloading the Mat” on page 21.

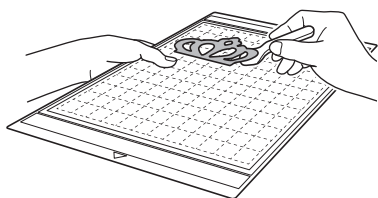



PATTERN SELECTION

Four pattern selection functions are available in the layout editing screen depending on your preference.

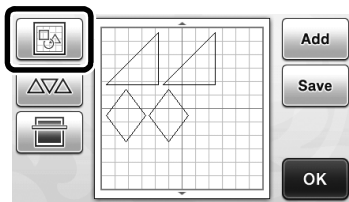
- ▶ Touch  in the pattern layout screen to use the pattern selection functions.



Selecting a Single Pattern

Select an individual pattern to be edited by either touching it in the editing screen or using  and , and then touch the "OK" key. The selected pattern is surrounded with a red box.

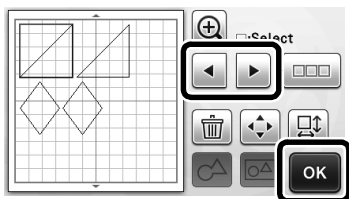

Selecting Multiple Patterns

■ Selecting Desired Patterns

- 1 Touch  in the layout editing screen for making multiple pattern selection.

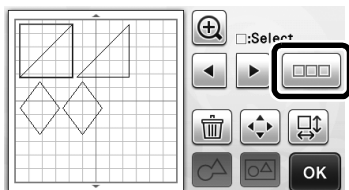

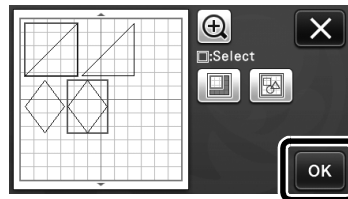

- 2 Individually touch all the patterns you want to select in the screen, and then touch the "OK" key.



📖 Memo

- Touching a selected (surrounded with a red box) pattern again clears its multiple selection.
- Touching any blank space in the screen clears all the pattern selections.

■ Selecting All Patterns

- 1 Touch  in the layout editing screen for making multiple pattern selection.
- 2 Touch  to select all the patterns on the screen.

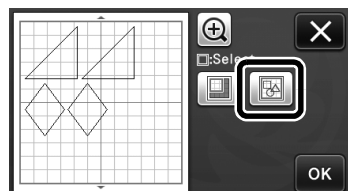

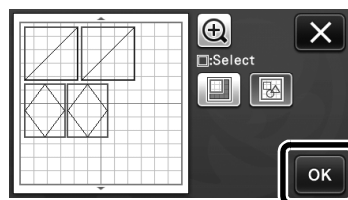

- 3 Check the selection, and then touch the "OK" key.

- ▶ All the selected patterns are surrounded with a red box.



■ Specifying the Selection Area

- 1 Touch  in the layout editing screen for making multiple pattern selection.
- 2 Touch  for specifying an area to select the patterns.

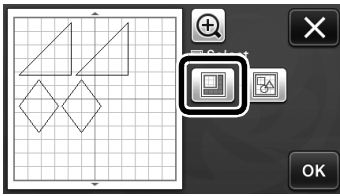

- 3 Touch and drag the area resizing keys to specify the area, and then touch the "OK" key.

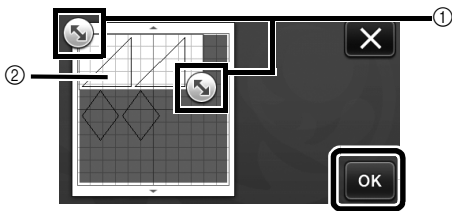

- ① Keys for specifying the area
- ② Patterns to be selected



Note

- This method of selecting patterns within a specified area is useful for welding or unifying patterns and deleting unwanted images when scanning (page 52).

Chapter 3 ADVANCED OPERATIONS

CUTTING AND EDITING FUNCTIONS

Pattern Editing Functions

The pattern editing functions available may differ depending on the pattern you select. Follow the instructions in either this section or "Pattern Editing Functions - Advanced Patterns" on page 34.

Available in the following screen

Pattern editing screen	→Tutorial 1; Step 4 (page 25) in "Selecting and Editing the First Pattern"
-------------------------------	--

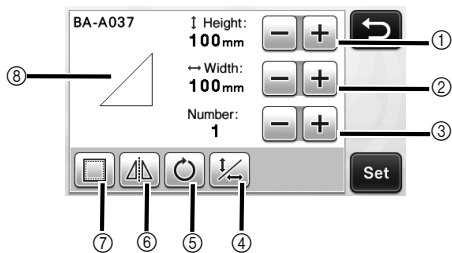

① Sizing (Height)

Edit the pattern height while maintaining the aspect ratio. Touch **+** or **-** to adjust the setting. Touch  to edit only the height.

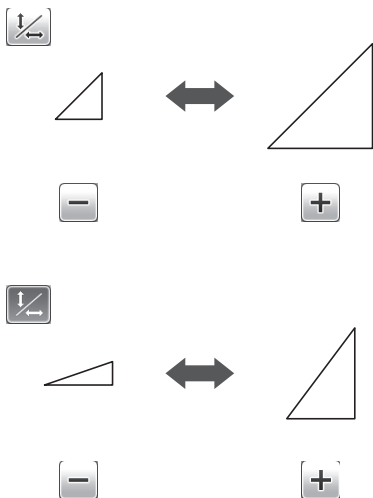

② Sizing (Width)

Edit the pattern width while maintaining the aspect ratio. Touch **+** or **-** to adjust the setting. Touch  to edit only the width.

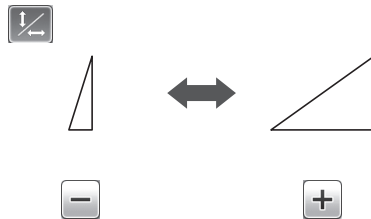

③ Duplicating

Create a duplicate of the pattern. Touch **+** or **-** to specify the number of pattern duplicates to be created.

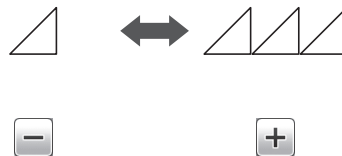

④ Unlocking the Aspect Ratio

Touch  to edit the pattern size without maintaining the aspect ratio. The function is available depending on the pattern you select. If the key is not available, the aspect ratio is locked and the pattern can only be edited while maintaining the aspect ratio.

⑤ Rotating

Rotate the pattern.

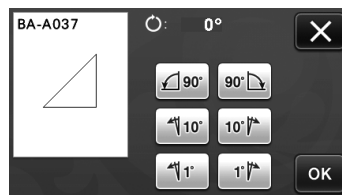

Touch the key for the desired angle.

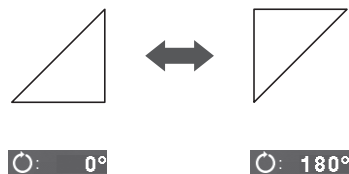

⑥ Mirroring

Flip the pattern along a vertical axis.

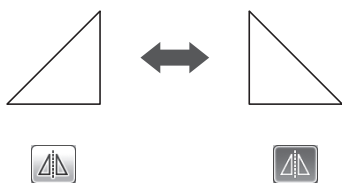

⑦ Seam Allowance

Apply the seam allowance setting. Apply this setting when cutting around a drawn pattern, such as when making appliqué or quilt pieces. When applied, the drawing line (blue) and cutting line (black) appear.

- For details on the seam allowance function, see “Cutting Around Drawings” on page 44.

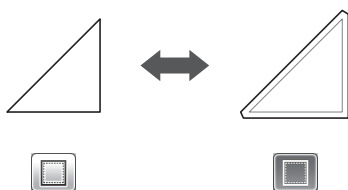

Memo

- Depending on the pattern, the seam allowance may be applied as a default. Check the setting.

⑧ Previewing

Display a preview of the edited pattern.

Pattern Editing Functions - Advanced Patterns

The pattern editing functions available may differ depending on the pattern you select. Follow the instructions in either this section or “Pattern Editing Functions” on page 33.

■ Pattern Sizing

Available in the following screen

Pattern sizing screen

→Tutorial 2; Step ⑤ (page 28)
in “Selecting and Editing the First Pattern Piece”

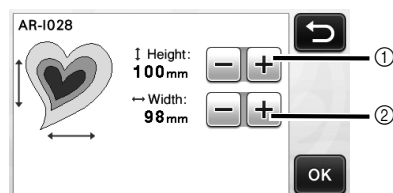

- ① Touch to edit the pattern height (while maintaining the aspect ratio).
- ② Touch to edit the pattern width (while maintaining the aspect ratio).

Memo

- All the pattern pieces displayed on the pattern sizing screen can be resized while maintaining the aspect ratio.

■ Editing the Pattern Piece

Available in the following screen

Pattern piece editing screen

→Tutorial 2; Step ⑦ (page 29)
in “Selecting and Editing the First Pattern Piece”

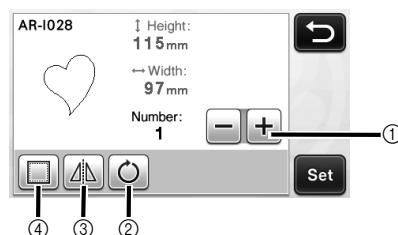

- ① Duplicating
- ② Rotating
- ③ Mirroring
- ④ Seam Allowance

- For details on using each key, see “Pattern Editing Functions” on page 33.

Pattern Layout Screen

The arrangement of the patterns can be edited. The cutting/drawing area specified with the “Cut Area” setting (page 23) in the settings screen is displayed in the preview screen. Edit the pattern arrangement so that the patterns fit within the specified area.

Available in the following screen

Pattern layout screen

→Tutorial 1; Step 5 (page 26) in “Selecting and Editing the Second Pattern”

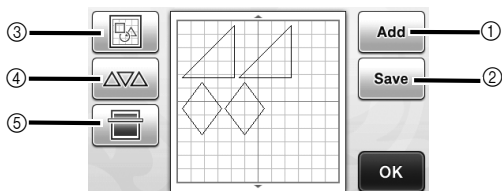

① Adding Patterns

Add a pattern to the layout.

- ▶ Touching this key displays the pattern category selection screen. From that screen, select the pattern to be added.

② Saving

Save the pattern arrangement as data. For details, see “Saving” on page 41.

③ Editing

The patterns in the layout can be edited, moved or deleted. For details, see “Layout Editing Functions” on page 35.

④ Auto Layout

Automatically arrange the patterns to reduce their spacing. For details, see “Auto Layout Functions” on page 38.

⑤ Background Scanning

Scan the material for cutting/drawing to be displayed in the background of the pattern layout screen. You can use specific areas of the material to cut out/draw patterns, or display the material that has already been cut in order to reuse it. For details, see “Scanning a Background Image” on page 38.

Layout Editing Functions

The layout editing functions are available when



is touched in the pattern layout screen.

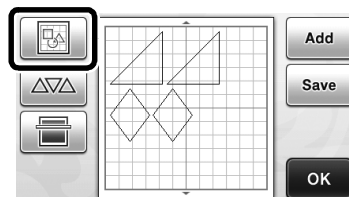

- ▶ The layout editing screen appears.

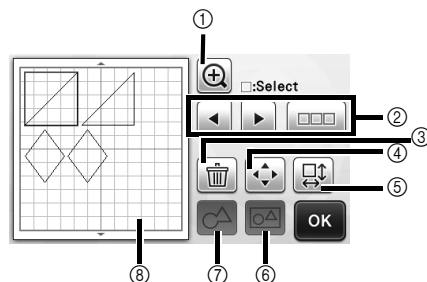

① Magnifying

Display the patterns enlarged. To scroll through the screen, touch the arrow keys.

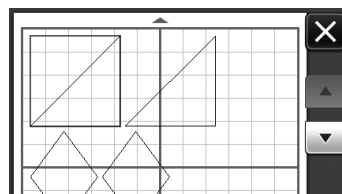

② Selecting Patterns

Select an individual pattern or multiple patterns to be edited. For details, see “PATTERN SELECTION” on page 31.

③ Deleting

Delete the selected patterns.

④ Moving

Incrementally move the selected patterns. Touch the arrow keys to adjust the position of the patterns.

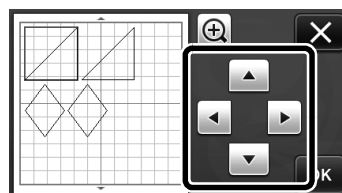

Memo

- The pattern can also be moved by touching it displayed in the layout editing screen and dragging it in the screen.

⑤ Editing Individual Patterns

Edit the selected individual pattern.

- ▶ Touching this key displays the pattern editing screen. From that screen, an individual pattern can be edited.
- For details, see “Pattern Editing Functions” on page 33.

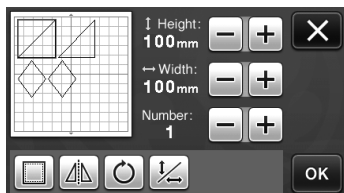

Note

- This function is not available when multiple patterns are selected.



Memo

- If the cutting line of a pattern extends from the cutting/drawing area due to editing, such as by applying a seam allowance or flipping a pattern, the line will become gray. Continue editing the pattern to move it within the cutting/drawing area.

⑥ Unifying (Grouping Multiple Patterns)

When multiple patterns are selected in the layout editing screen, those patterns can be unified together and edited as a single pattern. This is useful for increasing or reducing the size of multiple patterns at one time. For selecting multiple patterns, touch  in the layout editing screen. For details, see “Selecting Multiple Patterns” on page 31.

- ▶ Unifying

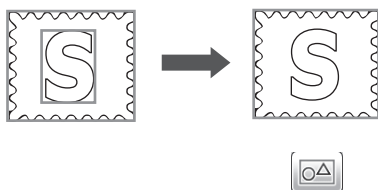

- ▶ Increasing the size of multiple patterns at one time

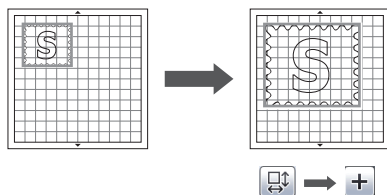

⑦ Welding (Merging the Outlines of Multiple Patterns)

Weld the outlines of multiple patterns to create a single outline. For details, see “Welding (Merging the Outlines of Multiple Patterns)” on page 36.

⑧ Previewing

Display a preview of the edited pattern.

Welding (Merging the Outlines of Multiple Patterns)

When multiple patterns are selected in the layout editing screen, the outlines of those patterns can be welded to create a single outline.

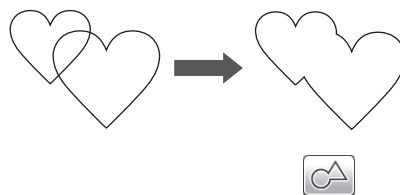

- 1 Select two heart patterns of different sizes and arrange them in the pattern layout screen.

- 2 Touch the large heart pattern in the pattern layout screen, and then drag it over the small pattern.

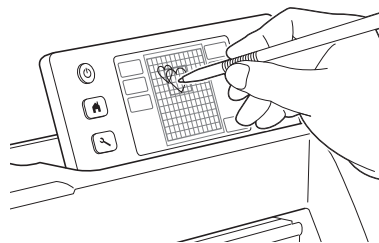

- 3 Touch  in the pattern layout screen.

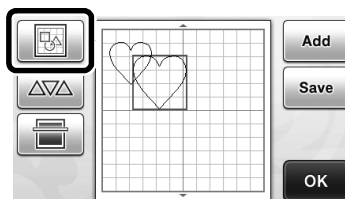

4 Touch  in the layout editing screen.

- For details on the functions in the layout editing screen, see “Layout Editing Functions” on page 35.

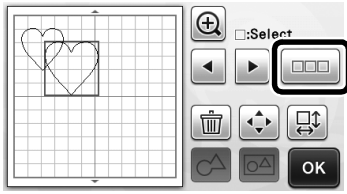

5 Select , and then touch the “OK” key.

- Two pattern selection functions are available depending on your preference. For details on selecting multiple patterns, see “Selecting Multiple Patterns” on page 31.

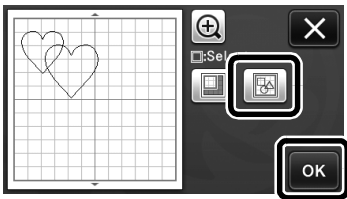

6 Touch .

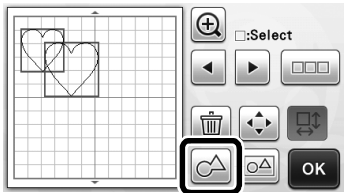

7 Check the preview, and then touch the “OK” key.

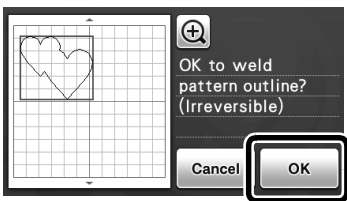

Note

- Welding pattern outlines cannot be undone. In order to recreate the original pattern arrangement, select the patterns again, and then arrange them.

- ▶ The outlines of the selected patterns are welded.

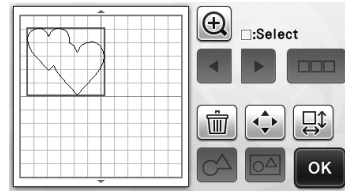

Note

- This function welds the outermost outline of the patterns. When welding certain types of patterns that have inside areas cut out, the cut-out areas are not used to create the outline. Be sure that the welded patterns in the preview area meet your wishes before completing the procedure.

- Welding built-in characters

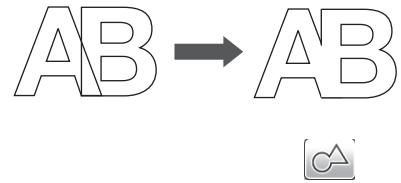

- Welding character images created by scanning

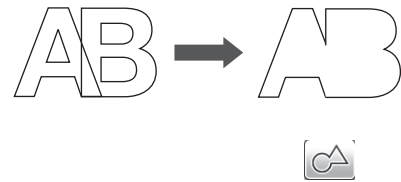

Auto Layout Functions

The auto layout function is useful when you do not wish to waste the material attached to the mat.

Touch  in the pattern layout screen (page 35) to perform the auto layout function.



Note

- Depending on the pattern and material to be cut, the patterns may not be cleanly cut if their spacing is too small. In that case, rearrange the patterns to slightly separate them.
- The spacing between arranged patterns can be specified in the settings screen (see “Pattern Interval” on page 24). Perform the auto layout function after every time you adjust the spacing between patterns so the changes are applied.
- Set the number to “3” or higher in the “Pattern Interval” setting when lightweight fabric is attached to the mat with a high tack adhesive fabric support sheet.

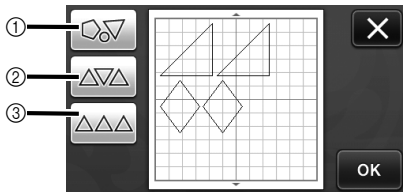

① Rearranging By Rotating Patterns to Any Angle

This is useful when arranging a large number of patterns in a limited space.

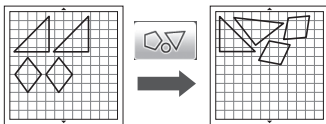

② Rearranging By Rotating Patterns 0° or 180°

This is useful when arranging the printed design (vertical patterns) on paper or fabric as the material for cutting/drawing or when using the vertical grain.

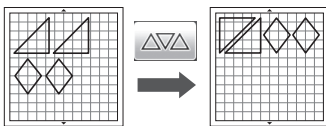

③ Rearranging Without Rotating Patterns

This is useful when arranging the printed design on paper or fabric as the material for cutting/drawing or when using the grain.

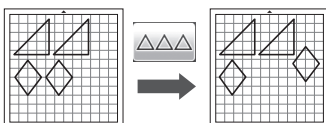

Scanning a Background Image

In this example, we will use material with a cutout in its upper-left corner as a background image.

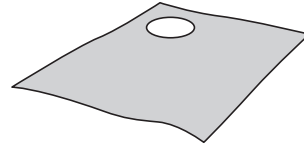

Memo

- The background scanning function is also useful when cutting out patterns from material with a design on it. By arranging the patterns on the screen in the desired patterned area of the material, cutouts with a specific design can be created.

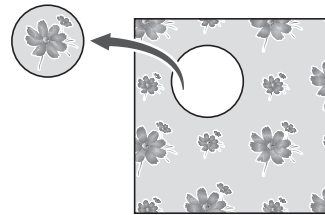

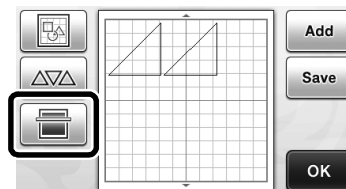

- This function cannot be used when an optional scanning mat is used.

① Touch in the pattern layout screen to start the background scanning function.

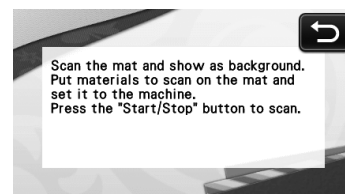

- ▶ The following message appears.



2 Attach the material for the background to the mat, and then press  in the operation panel.

For details on preparing the material and loading the mat, see “Loading the Mat” on page 20.

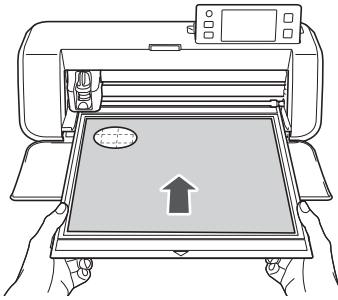

- ▶ The mat is fed in, and the “Start/Stop” button in the operation panel lights up.

3 Press the “Start/Stop” button to start scanning.

- ▶ After the material has been scanned, it appears as the background in the pattern layout screen.

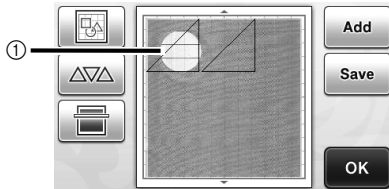



- ① Material with a cutout displayed as background

 **Memo**

- If it is difficult to see the arranged patterns, adjust the background contrast in the settings screen. Press  in the operation panel to display the settings screen.



- ▶  : Makes the background image darker.
- ▶  : Makes the background image lighter.
- ▶  : Does not display the background image.

4 Touch .

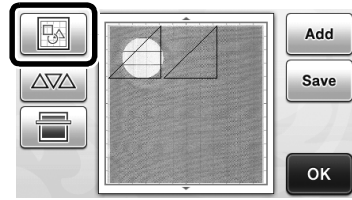

- ▶ The layout editing screen appears.

 **Memo**

- The pattern can also be moved by touching and dragging it in the screen.

5 Use the layout editing functions to move the patterns.

- For details on moving patterns, see “Pattern Layout Screen” on page 35.

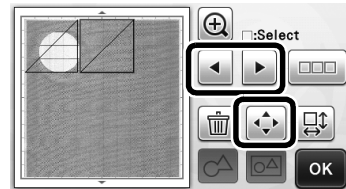

 **Memo**

- The pattern can also be moved by touching the pattern(s) displayed in the layout editing screen and dragging it in the screen.

6 Check that the patterns in the screen do not overlap the cutouts in the background material and then touch the “OK” key.

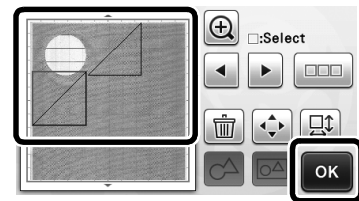

 **Memo**

- When the scanned material is unloaded, the background is cleared.

Character Input Functions

Characters can be selected, edited, cut out and drawn as a single pattern. Select the character type from the pattern category selection screen.

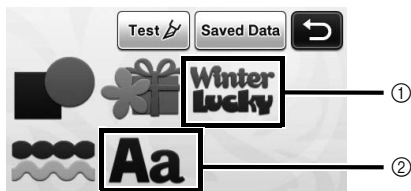

- ① Select decorated characters. The characters can be edited, cut out and drawn as a pattern. For details on editing, see “Pattern Editing Functions” on page 33.
- ② Type in the desired combination of characters.

Typing In the Word “RAINBOW”

- ① Select the font category in the pattern category selection screen.

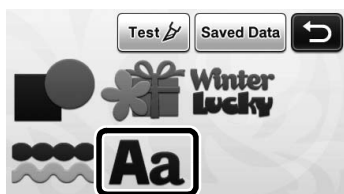

- ② Touch the desired font type.

Select the desired font type from the five that are available.

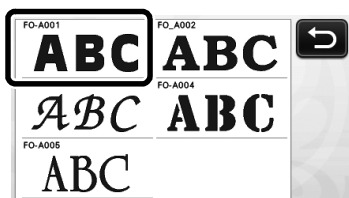

- ③ Type in the characters.

The keyboard is in the QWERTY layout. After entering the characters, touch the “OK” key.

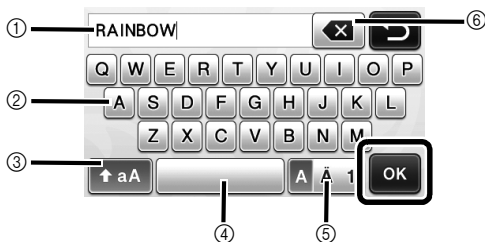

- ① Character input display
- ② Character keys
- ③ Uppercase/lowercase selection key

- ④ Space key
- ⑤ Letter/accented character/number selection key
- ⑥ Backspace key (deletes one character from the end of those displayed)

Memo

- If the entered characters do not fit within the cutting/drawing area, the character size is automatically reduced.

- ④ Adjust the settings of character size and character spacing.

Touch **+** or **-** to adjust the character size or the space between characters. After completing the adjustment, touch the “Set” key.

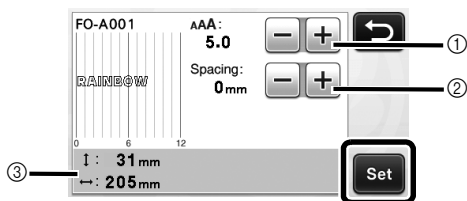

- ① Character size adjustment keys

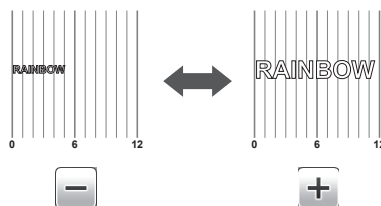

- ② Character spacing adjustment keys

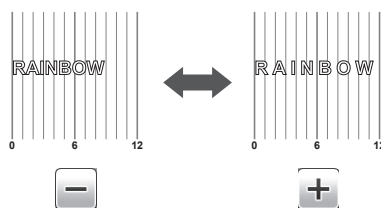

- ③ Size of entire character string

- ⑤ Check the character arrangement.

To cut or draw, touch the “OK” key.

To save the characters as data, touch the “Save” key. For details on saving data, see “Saving” on page 41.

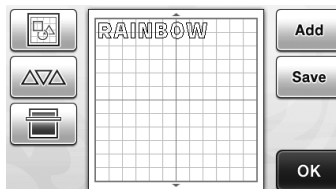

Memo

- Entered characters can only be edited as the entire character string. One character cannot be edited individually.

MEMORY FUNCTIONS

Patterns and characters arranged in the cutting/drawing area can be saved and recalled later. Either the machine's memory or a USB flash drive can be selected as the location for saving and recalling.



Note

- USB flash drive is widely used, however some USB flash drive may not be usable with this machine. Please visit our website “ <http://solutions.brother.com> ” for more details.
- This machine is incompatible with a USB hub. Plug the USB flash drive directly into the USB port.

Saving

Available in the following screen

Pattern layout screen	→Tutorial 1; Step 5 (page 26) in “Selecting and Editing the Second Pattern”
------------------------------	---

- 1 Touch the “Save” key to display the destination memory selection screen.

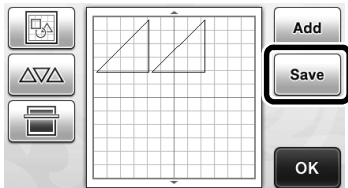

- 2 Touch the desired destination.

- In order to save data on a USB flash drive, plug the USB flash drive into the USB port on this machine.



- 1 Save to the machine's memory
 - ▶ Touch this key to start saving. When saving is finished, the following message and the name of the saved file appear.

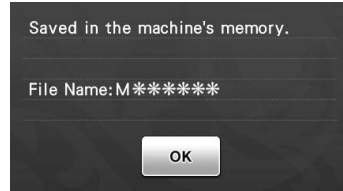

- 2 Save to the USB flash drive.
 - ▶ Touch this key to start saving. When saving is finished, the following message and the name of the saved file appear.



- The name of the saved file with the extension “.fcm” is automatically assigned.



Note

- While data is being saved, do not remove the USB flash drive.

- 3 Touch the “OK” key to finish saving the data.

- ▶ The destination memory selection screen appears again.

Recalling

Available in the following screen

Pattern category selection screen	→Tutorial 1; Step 2 (page 25) in “Selecting and Editing the First Pattern”
--	--

- 1 Touch the “Saved Data” key to display the destination memory selection screen.

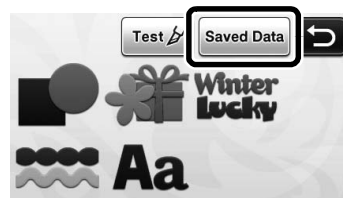

2 Touch the desired destination, and then select the desired pattern.

- To recall data from a USB flash drive, plug the USB flash drive into the USB port on this machine.



- ① Recall from the machine's memory.
- ▶ Touch the pattern to be recalled and display a preview of the pattern layout.

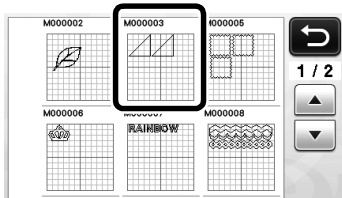

- ② Recall from a USB flash drive.
- ▶ If there are folders on the USB flash drive, touch a folder to display the list of patterns that it contains.
 - If there are many folders or patterns, touch the arrows keys in the screen to scroll up or down.

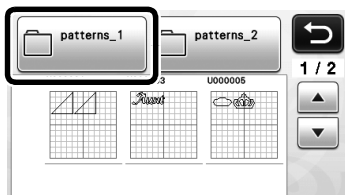

Note

- If the name of the data file/folder cannot be identified, for example, when the name contains special characters, the file/folder is not displayed. If this occurs, change the name of the file/folder. We recommend using the 26 letters of the alphabet (uppercase and lowercase), the numbers 0 through 9, “-” and “_”.

- ▶ Touch the pattern to be recalled and display a preview of the pattern layout.

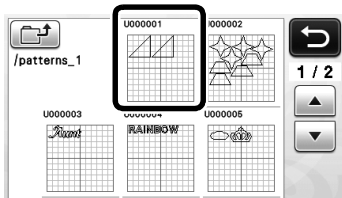

3 Check the preview of the pattern layout in the screen, and then touch the “OK” key.

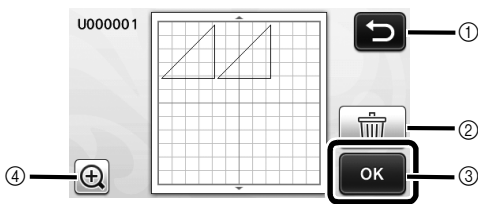

- ① Touch to return to the list of patterns at the destination.
- ② Touch to delete the data for the displayed pattern layout.
- ③ Touch to recall the pattern layout data.
- ④ Touch to display the patterns enlarged.



Memo

- Even if a seam allowance has been saved with the pattern(s) (see “Cutting Around Drawings” on page 44), the “Seam Allowance” setting specified in the settings screen will have priority and will be applied. If necessary, adjust the “Seam Allowance” setting in the settings screen (see “Seam Allowance” on page 24).

DRAWING FUNCTIONS

With a pen and pen holder, you can draw patterns on material. Using the seam allowance settings also allows you to draw patterns with seam allowances on material and then cut them out. These drawing functions can be used to create quilt pieces.

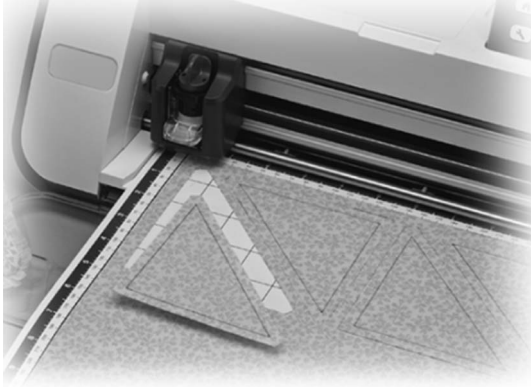

■ Preparation

Prepare the following accessories for drawing. An additional purchase may be required depending on the machine model.

- Pen holder
- Erasable pen set or color pen set
- Mat appropriate for the material that will be drawn on.
- Blade and blade holder appropriate for the material that will be cut.
- Contact sheet or support sheet appropriate for fabrics that will be cut or drawn on.

Drawing

In this example, we will draw a built-in pattern on material.

■ Preparing the Pen Holder

- 1 Press the button at the center of the pen holder to unhook the lid and open it.

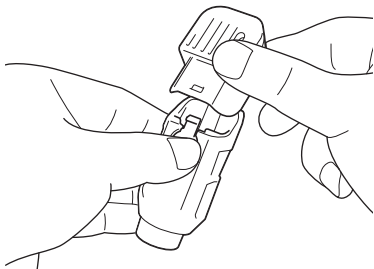

- 2 Remove the cap from the pen, and then insert the pen into the pen holder with the point down.

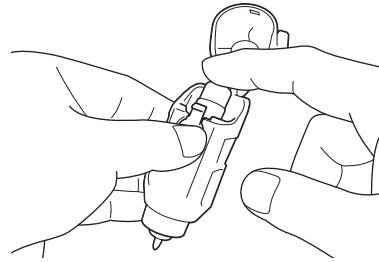

- 3 Close the lid of the pen holder.



Note

- After use, remove the pen from the pen holder, and then attach the cap to the pen before storing it.

■ Drawing

- 1 Grasp the holder grip, and then install the pen holder in the carriage with its lid opening button facing against you.

- For details, see “Installing and Uninstalling the Holder” on page 19.

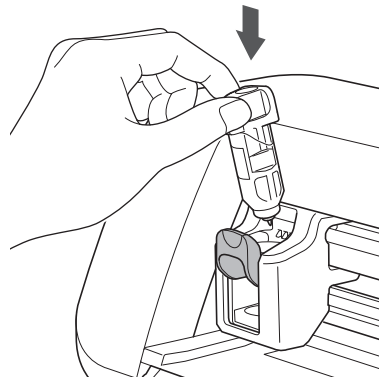

- 2 Select and edit the pattern.

- For details on selecting and editing patterns, see “Selecting and Editing the First Pattern” on page 25.

3 Load the mat with the material for drawing (cutting) attached.

- Lightly insert the mat into the feed slot, and press  in the operation panel.
- For details on inserting the mat, see “Loading the Mat” on page 20.

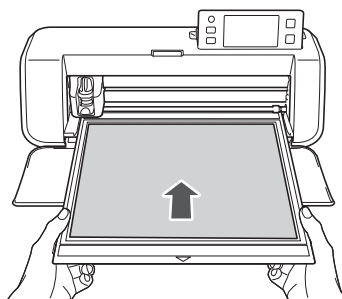

4 Select “Draw” in the draw/cut selection screen.

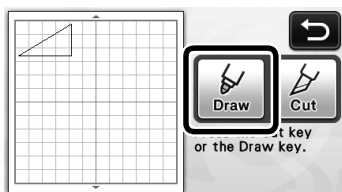

▶ The drawing line (blue) appears.

5 Adjust the drawing speed and pressure.

Before drawing the pattern, adjust the drawing speed and pressure. These adjustments can be made from the settings screen. Press  in the operation panel.

▶ Touch  or  to change the settings.

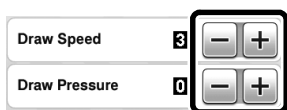

Note

- If the drawing pressure is too high, the pen tip may be damaged. Adjust it to an appropriate setting.



Memo

- Adjustments to the drawing pressure will affect the finished product. Use the same material that the pattern will be drawn on to make the adjustments.

6 Press the “Start/Stop” button in the operation panel to start drawing.



Note

- After use, remove the pen from the pen holder, and then attach the cap to the pen before storing it.

Cutting Around Drawings

In this example, we will specify a seam allowance for a built-in pattern and draw the pattern, then cut an outline around it.

■ Specifying the Seam Allowance

1 Touch the pattern to be drawn.

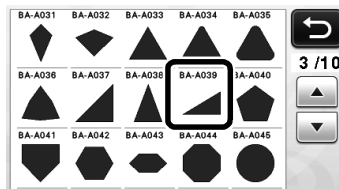

2 Adjust the seam allowance.

Specify the seam allowance, which is the distance from the pattern outline to the cutting line around the pattern, in the settings screen. Press  in the operation panel to display the settings screen.

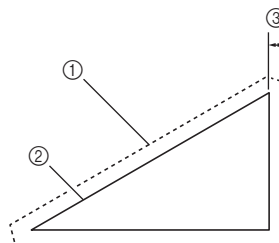
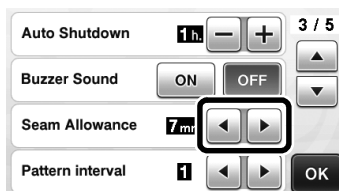

▶ Touch  or  to change setting.



- ① Seam allowance line
- ② Pattern outline (stitching line)
- ③ Seam allowance

▶ Touch the “OK” key to finish specifying the setting and return to the pattern editing screen.

3 Apply the seam allowance.

Touch  to apply the seam allowance. If  appears in gray, the seam allowance cannot be applied.

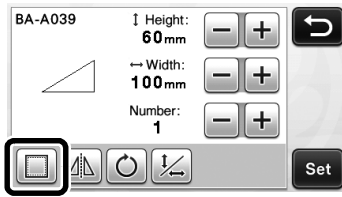

Memo

- Depending on the pattern, the seam allowance may be applied as a default. Check the setting.
- The pattern in the preview appears with a drawing line (blue) and a cutting line (black).

4 Touch the "Set" key to finish editing the pattern.

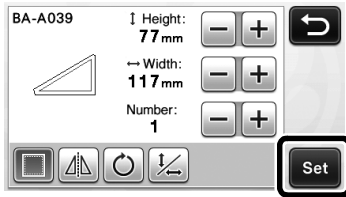

Memo

- To draw the seam allowance on the wrong side of the fabric, flip the pattern.

Image of Pattern Piece to be Created

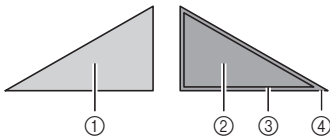

- Right side of fabric
- Wrong side of fabric
- Drawing line (stitching line)
- Seam allowance line

- After attaching to the mat the fabric with the wrong side facing up, load the mat into the machine, flip the pattern, and then draw it and cut it out.

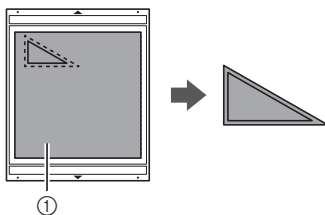

- Wrong side of fabric

5 Check the pattern arrangement, and then touch the "OK" key.

When using fabric, the patterns may not be cleanly cut if they are arranged near the edge of the fabric. In this case, move patterns so they are at least 10 mm from the fabric edge (the edge of the cutting/drawing area in the screen).

- To re-edit the pattern arrangement after checking it, touch . For details, see "Pattern Layout Screen" on page 35.

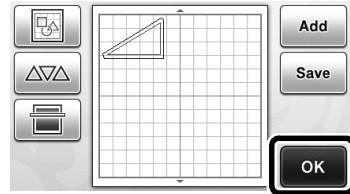

- The draw/cut selection screen appears.

Loading the Material

Load the mat with the material for cutting (drawing) attached.

When drawing the seam allowance on the wrong side of the fabric, attach the material to the mat with its wrong side facing up.

- For details on attaching material to the mat, see "Mat and Cutting Blade Combinations" on page 12.
- Lightly insert the mat into the feed slot, and press  in the operation panel.
- For details on inserting the mat, see "Loading the Mat" on page 20.

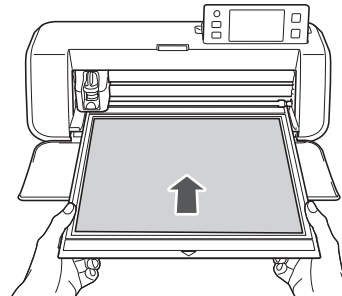

Drawing

1 Touch the "Draw" key.

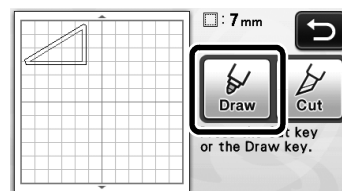

- A preview of the line to be drawn appears.

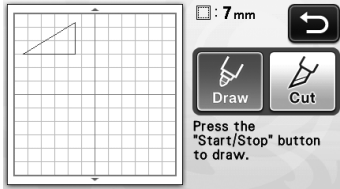



- ▶ The “Start/Stop” button in the operation panel lights up.

2 Adjust the pen pressure.

For details on adjusting the drawing pressure, see step 5 (page 44) in “Drawing”.

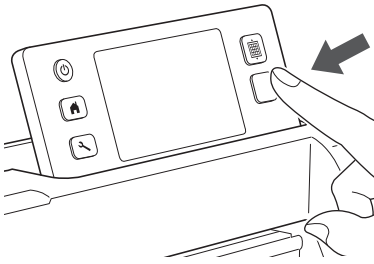
3 Press the “Start/Stop” button to start drawing.



- ▶ When drawing is finished, the message appears in the screen. After you touch the “OK” key, the draw/cut selection screen appears.
- To perform trial drawing operations to adjust the drawing pressure, repeat steps 1 through 3 in this section.
- To cut around the drawn patterns, keep the mat inserted into the slot without pressing , and continue with the following cutting procedure.

■ Cutting

1 Touch the “Cut” key.

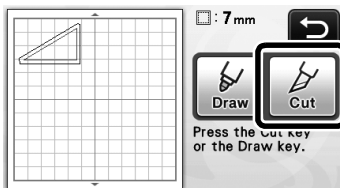

- ▶ A preview of the line to be cut appears.

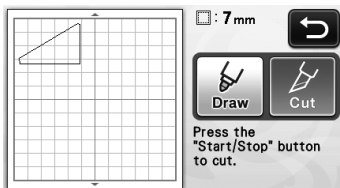

- ▶ The “Start/Stop” button in the operation panel lights up.

2 Remove the pen holder, and then install the blade holder.

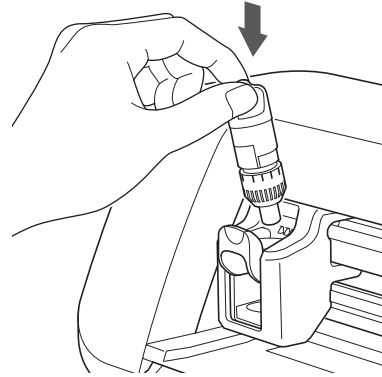

Note

- Replace the holder without turning off the machine. If the machine is turned off, the mat will be fed out when it is turned on again. Therefore, the drawn pattern outline and cut pattern may become misaligned, even if the mat is re-inserted.
- After use, remove the pen from the pen holder, and then attach the cap to the pen before storing it.

3 Press the “Start/Stop” button to start cutting.

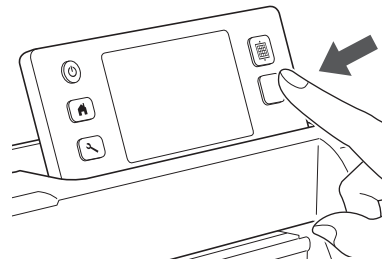

- ▶ When cutting is finished, the draw/cut selection screen appears.

4 Press in the operation panel to feed out the mat.

5 Peel the patterns off the mat.

- For details, see “Unloading the Mat” on page 21.

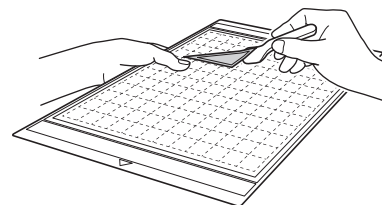

Chapter 4 SCANNING FUNCTIONS

SCANNING FOR CUTTING (Direct Cut)

A printed image or an original hand-drawn illustration can be scanned and its outline can be cut out or drawn. This is useful for scanning images for paper crafts, then cutting them out.



Tutorial 3 - Scanning and Cutting

In this tutorial, we will scan an illustration drawn on paper, then cut around it.

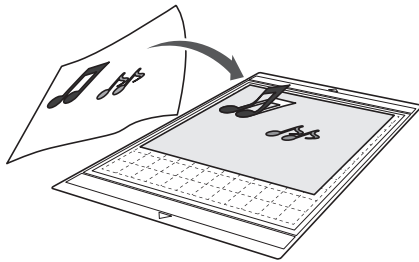

Preparation

1 Prepare the original.

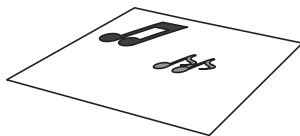

When using the "Direct Cut" mode, use originals like those described below.

- Patterns that are clearly drawn, with no gradation, fading or blurriness
- Patterns that are at least a 5 mm square
- Not using an extremely intricate design

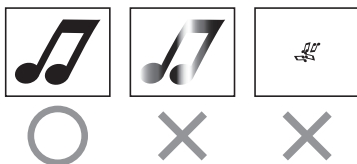

2 Press to turn on the machine.

- For details, see "Turning On/Off the Machine" on page 10.

3 Install the cutting blade holder into the carriage of the machine.

- For details, see "Installing and Uninstalling the Holder" on page 19.

Scanning

1 Touch the "Scan" key in the home screen to select the scanning mode.

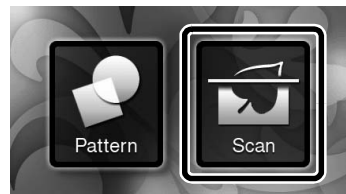

2 Select "Direct Cut" in the scanning mode selection screen.

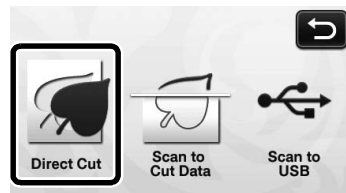

► A message appears.

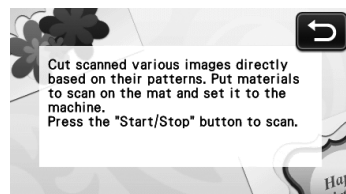

3 Attach the original that will be scanned to the mat.

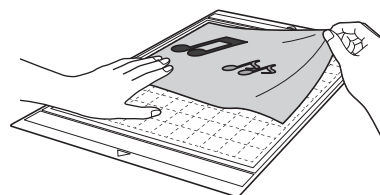

Memo

- In “Direct Cut” mode, the optional 12" × 24" (305 mm × 610 mm) mat and scanning mat cannot be used.
- Before attaching the material to the mat, use a corner of the adhesive side of the mat to test attaching it.

- 4** While holding the mat level and lightly inserting it under the feed rollers on the left and right sides of the feed slot, press  in the operation panel.

- For details, see “Loading the Mat” on page 20.
 - ▶ The “Start/Stop” button in the operation panel lights up.

- 5** Press the “Start/Stop” button to start scanning.

- ▶ When scanning is finished, the scanned image appears in the screen.

- 6** Check the scanned image, and then touch the “OK” key.

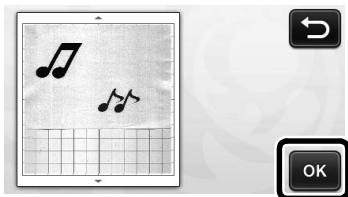

■ Editing Cutting Lines

- 1** In the image trim screen, use the touch pen to touch  and drag it around the screen to trim the image.



- 2** To cut around the image for the pattern, touch the “OK” key.

- Touch  to cut any of a variety of shapes as a frame around the scanned image. For details on selecting a frame, see “Advanced Cutting Functions” on page 49.

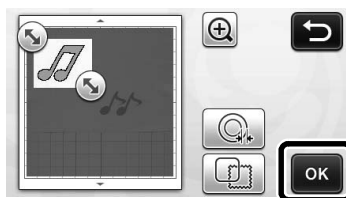

■ Cutting

- 1** Touch the “Cut” key.

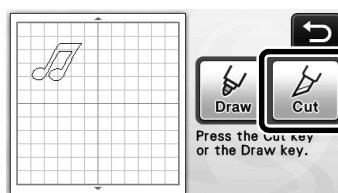

- ▶ The “Cut” key is highlighted, and the “Start/Stop” button in the operation panel lights up.

- 2** Press the “Start/Stop” button to start cutting.

- For details on unloading the mat after cutting, follow the procedure under “Unloading the Mat” on page 21.

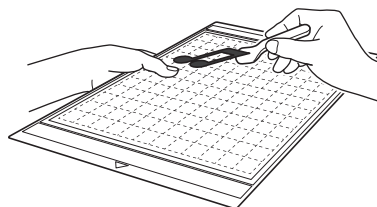

Advanced Cutting Functions

■ Outline Distance

Specify the distance from the cutting line to the outline of the scanned image.

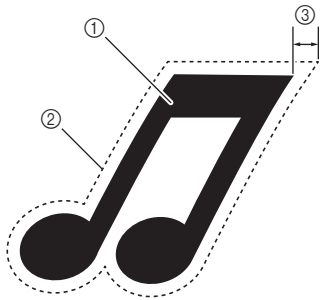

- ① Pattern outline
- ② Cutting line
- ③ Outline distance

Available in the following screen

Image trim screen →Tutorial 3; Step ② (page 48) in "Editing Cutting Lines"

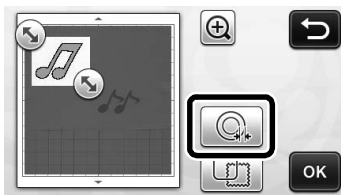

- The setting screen appears. Touch **+** or **-** to change the setting.

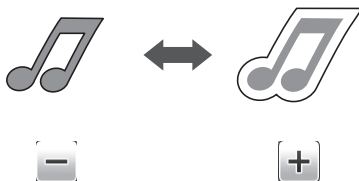

■ Outlining and Framing

Any shape can be specified as the cutting line for the scanned image.

Available in the following screen

Image trim screen →Tutorial 3; Step ② (page 48) in "Editing Cutting Lines"



- The settings screen appears.

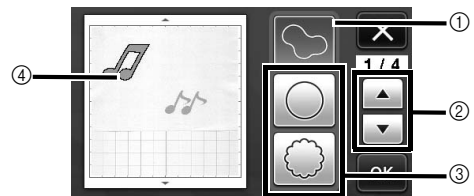

① Outlining

Touch this key to create a cutting line that follows the outline of the scanned image.

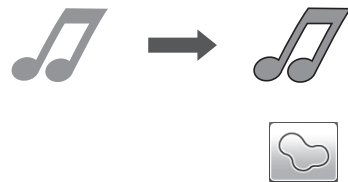

② Frame Shape Scroll Keys

Touch **▲** or **▼** to scroll up or down through the list of frames.

③ Framing

Touch the key for the desired frame to add it to the scanned image and create a cutting line that follows its shape.

- If there are multiple images, a frame can be specified for each image.

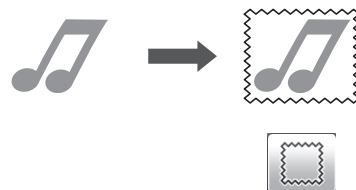

④ Previewing

Display a preview of the image together with the cutting line for the selected frame.

CREATING CUTTING DATA (Scan to Cut Data)

A printed pattern or image or an original hand-drawn illustration can be scanned, converted to cutting lines for cutting/drawing with this machine, then saved as data.



Tutorial 4- Creating Cutting Data

In this tutorial, we will save an illustration drawn on paper as cutting data.

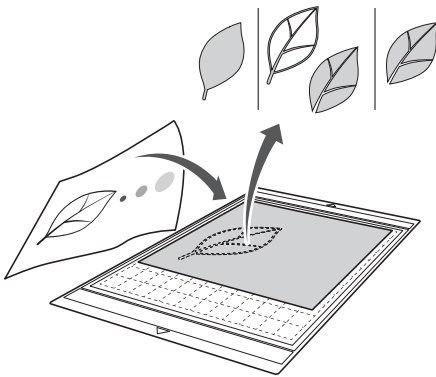

■ Scanning

- 1 Touch the "Scan" key in the home screen to select the scanning mode.

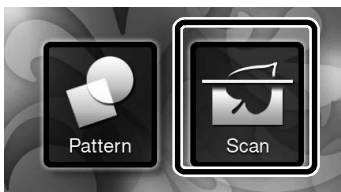

- 2 Select "Scan to Cut Data" in the scanning mode selection screen.

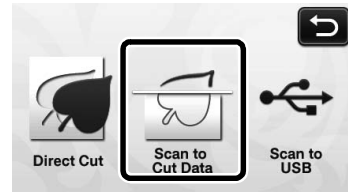

- ▶ A message appears.

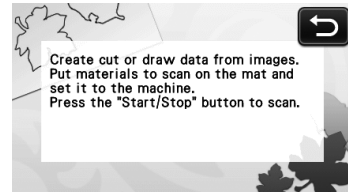

- 3 Attach the original to the mat, and then load the mat into the feed slot.

- Lightly insert the mat into the feed slot, and press  in the operation panel.
- For details on loading the mat, see "Loading the Mat" on page 20.

Memo

- In "Scan to Cut Data" mode, the optional 12" × 24" (305 mm × 610 mm) mat cannot be used.

- 4 Press the "Start/Stop" button to start scanning.

- ▶ When scanning is finished, the scanned image appears in the screen.

■ Editing Cutting Data





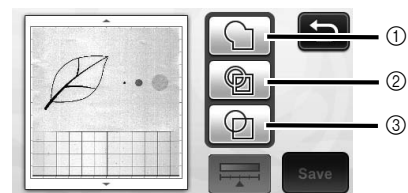

- 1 Select the cutting line type in the image editing screen.

The image shape is detected and cutting lines are created based on one of three standards. For this

example, touch  to create cutting lines using region detection.



Difference in cutting lines depending on detection standard

	① Outline detection	② Region detection	③ Line detection
Original			
Cutting lines			
Finished project after cutting			

① Outline detection

If you wish to cut/draw along the outline of an image, select this option to convert the outline of the image to a cutting line. This is useful for saving as data an illustration drawn for an appliqué.

② Region detection

Select this option to detect the colored portions of an image as regions and create a cutting line around each region. Cutouts can be created using thick hand-drawn lines, such as borderlines of images or text illustrations. This option allows you to use not only cut-out patterns but the material from which portions are cut out, such as lace.

③ Line detection

Select this option to detect the center of lines and convert them to a cutting line. This is useful for detecting patterns consisting of multiple pieces and creating cutting lines for each piece.



Memo

- Lines thicker than 1.5 mm will not be detected as lines.

② Use the touch pen to touch  and drag it around the screen to trim the cutting lines to be saved as data, and then touch the “Save” key.

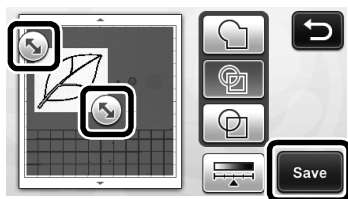

- ▶ The destination memory selection screen appears.

■ Saving Data

① Select the destination where the data will be saved.

Select either the USB flash drive or the machine's memory as the destination for saving the data. Touch the key for the desired destination. For this example, select the machine's memory. In order to save data on a USB flash drive, plug the device into the USB port on this machine.

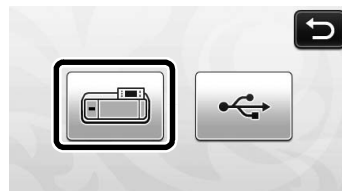

- ▶ Touching a key starts saving the data. When the data has been saved, the following message appears.

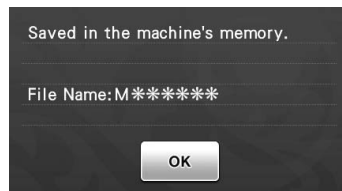

② Touch the “OK” key to finish saving the data.

- ▶ The destination memory selection screen appears again.

③ Press  in the operation panel to feed out the mat, and then peel off the original from the mat.

■ Recalling Cutting Data

Saved cutting data can be recalled for cutting.

① Attach the material for cutting to the mat, and then load the mat.

- For details on attaching the material, see “Mat and Cutting Blade Combinations” on page 12.
- For details on loading the mat, see “Loading the Mat” on page 20.

② Recall the saved cutting data.

- For details on recalling data, follow the procedure under “Recalling” on page 41.

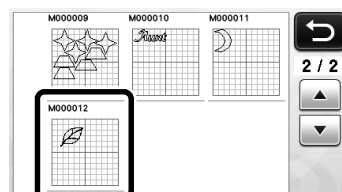

- ▶ A preview of the pattern layout appears.

3 Edit the cutting data as necessary, and then cut or draw.

For details on finishing cutting, follow the procedures under “Loading the Mat” (page 20) and “Cutting” (page 21).

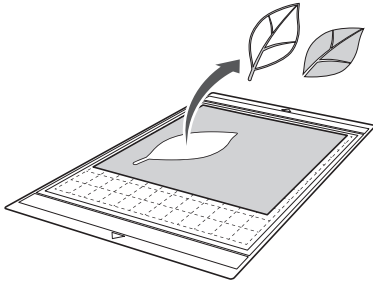
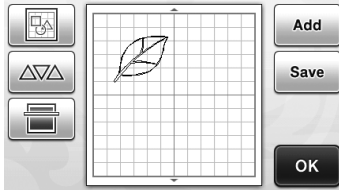

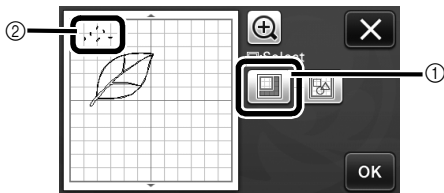

Memo

- Small spots and unwanted lines created during scanning can be deleted after a scanned image is converted to cutting data.
- ▶ After recalling the cutting data into the pattern layout screen, use the editing functions for selecting the spots to delete. For details on the function, see “Selecting Multiple Patterns” on page 31.

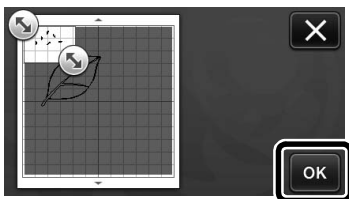

- 1 Touch for selecting multiple patterns in the specified area.
 - 2 Unwanted spots and lines
- ▶ Specify the area of the unwanted spots, and then touch the “OK” key.



- ▶ Touch  to delete all of the selected spots.

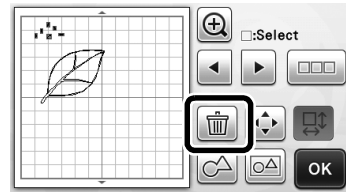

Editing Pictures

By adjusting the output level of data for a scanned image, you can reproduce the image in a wide variety of ways.

Available in the following screen

Image editing screen

→Tutorial 4; Step 1 (page 50) in “Editing Cutting Data”

■ Specifying “Delete Size”

Clean up the image by deleting small spots, unwanted lines or texts on it.

In the following example, we will scan three images of different sizes (4 mm, 40 mm, 100 mm).

- 1 Select one of the three detection options, and then touch  to display the function selection screen.

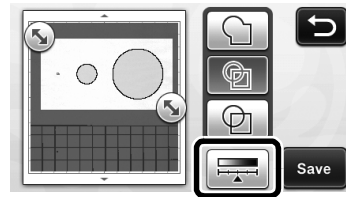

- 2 Touch  to display the setting screen.

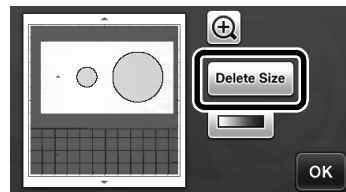

- 3** Specify an object size smaller than which is not to be converted to cutting lines.

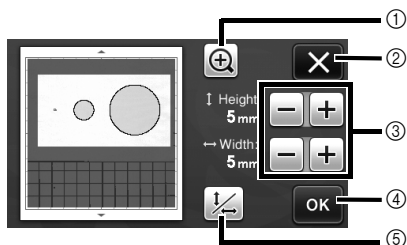

- ① Magnifying
- ③ Size Adjustment Keys
- ⑤ Locking/Unlocking the Aspect Ratio



- ① Cutting line created
- ② No cutting line created
- ▶ Touch the "OK" key (④) to apply the settings.

Touch (②) to return to the previous screen without applying the settings.

■ Setting Image Detection Level

Convert an image with a gradation or shading to a two-tone (black and white) image, and then create cutting lines for that image.

In the following example, we will scan three images of different tones (light, medium, dark).

- 1** Touch in the function selection screen to display the setting screen.

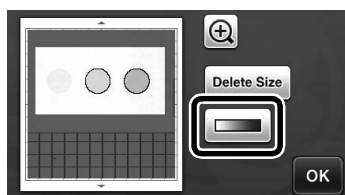

- 2** Specify the threshold for converting an image to a two-tone image using and .

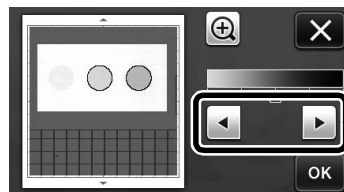

- ① Cutting line created
- ② No cutting line created
- ▶ Touch the "OK" key to apply the settings. Touch to return to the previous screen without applying the settings.

SCANNING IMAGES (Scan to USB)

A pattern printed on paper or fabric, an image, a pattern template or an original hand-drawn illustration can be scanned and saved as image data on a USB flash drive. This is useful for saving the data of an original image as backup before cutting.

Notes on Scanning

■ Scanning Specifications

- Scanning format: Color
- Saved file format: jpg
- Maximum scanning area: 296 mm × 298 mm (11 3/4" × 11 3/4").

■ Material That Can be Scanned

	with low-tack adhesive mat/ standard mat
Thickness	Max. 1.5 mm
Type	Paper/Fabric



Memo

- In "Scan to USB" mode, the optional 12" × 24" (305 mm × 610 mm) mat cannot be used.
- Use the optional scanning mat to secure the paper or fabric to be scanned. The mat can be used without attaching the paper or fabric to the mat.

Tutorial 5- Scanning to USB

In this tutorial, we will save an illustration drawn on paper as JPEG data to a USB flash drive.

■ Scan Settings

- 1 Plug the USB flash drive into the USB port on this machine.

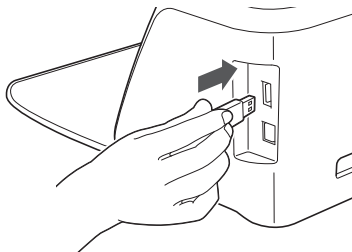

- 2 Touch the "Scan" key in the home screen to select the scanning mode.



- 3 Select "Scan to USB" in the scanning mode selection screen.

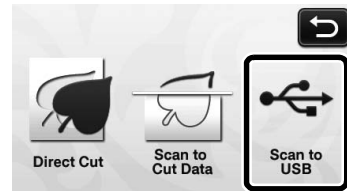

▶ A message appears.

- 4 Touch  to display the scanning settings screen.

Specify the size of the area to be scanned and the scanning resolution.

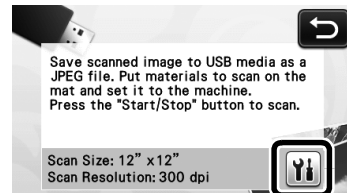

- 5 Touch  (for "Scan Size") to display the scanning size settings screen.

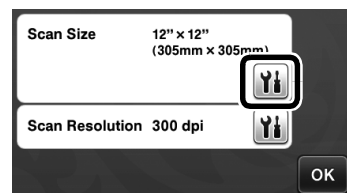

6 Select the size of the scanning area.

From the list, touch the key for the size of the original to be scanned. For this example, select the A4 size.

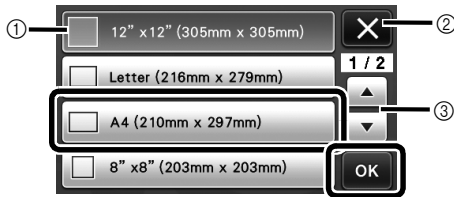

- 1 Size selection keys
- 2 Touch to cancel the setting and return to the previous screen.
- 3 Touch to scroll through the list.
 - ▶ After the selected key is highlighted, touch the "OK" key to finish specifying settings.

7 Touch (for "Scan Resolution") to display the scanning resolution settings screen.

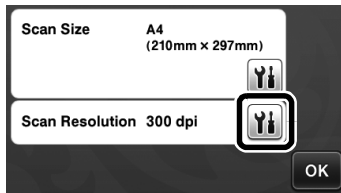

8 Select the scanning resolution.

From the list, touch the key for the scanning resolution. For this example, select 150 dpi.

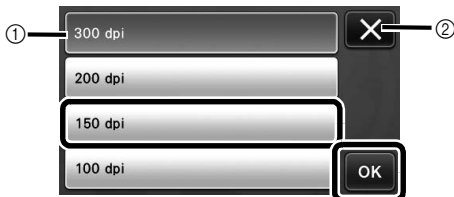

- 1 Resolution selection keys
- 2 Touch to cancel the setting and return to the previous screen.
 - ▶ After the selected key is highlighted, touch the "OK" key to finish specifying settings.

9 Check the settings, and then touch the "OK" key.



- ▶ A message appears.

■ Scanning and Saving

1 Attach the original that will be scanned to the mat.

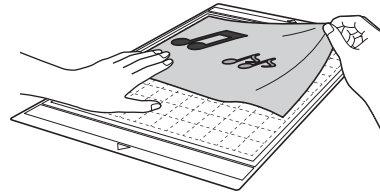

Note

- Place the original to be scanned so that it is in the landscape orientation.

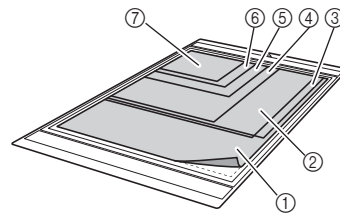

- 1 12" x 12" (305 mm x 305 mm)
- 2 Letter (216 mm x 279 mm)
- 3 A4 (210 mm x 297 mm)
- 4 8" x 8" (203 mm x 203 mm)
- 5 5" x 7" (127 mm x 178 mm)
- 6 4" x 6" (102 mm x 152 mm)
- 7 3.5" x 5" (89 mm x 127 mm)

2 Load the mat into the feed slot.

For details on loading the mat, see "Loading the Mat" on page 20.

3 Press the "Start/Stop" button to start scanning.

- ▶ The data is saved at the same time that the original is being scanned.
- ▶ When scanning and saving is finished, the completion message appears.

4 Touch the "OK" key to exit "Scan to USB" mode.

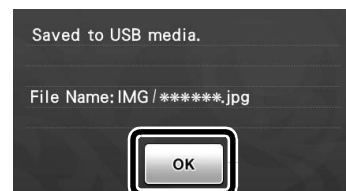

5 Press in the operation panel to feed out the mat.

6 Unplug the USB flash drive from the USB port on this machine.

7 From a computer, check the saved image data.

CONSUMABLES

Replacement Criteria

For the safe operation of this machine, replace the following consumables according to the replacement criteria. To purchase parts, contact the retailer who sold you this machine or the nearest authorized service center. For details on the optional accessories, see "OPTIONAL ACCESSORIES" on page 66.

Mat

- When the mat's adhesive strength decreases
- When there are many cutting traces in the mat

Cutting blade

- When the cuts in the material become rough, reducing the quality of the finished product
- When the cutting edge becomes blunt

High tack adhesive fabric support sheet

- When the sheet's adhesive strength decreases
- When fabric attached becomes twisted while being cut

Scanning mat

- When the mat and cover sheet become dirty, reducing the quality of the scan image

Replacing the Blade

■ Removing

- ① Twist off the holder cap to remove it.

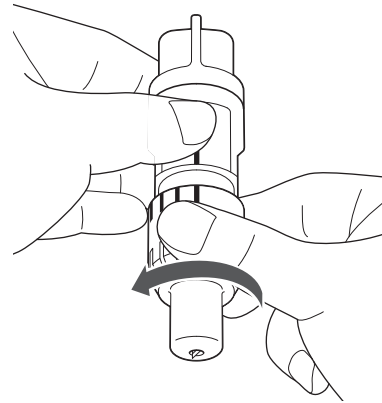

- ② Stick the blade straight into the rubber area on the back of the included spatula.

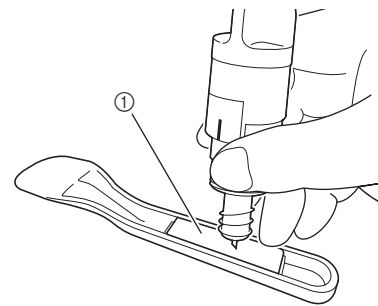

- ① Rubber area

- 3** Pull up the holder to leave the blade in the rubber area.

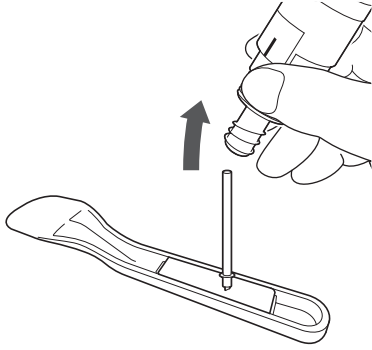

■ Installing

- 1** Grasp the shaft of the new blade, and then insert it into the blade slot in the end of the holder.

The blade shaft is held in place by a magnet in the holder. Slowly insert the blade shaft, and then slowly release it after the shaft snaps into place against the magnet.

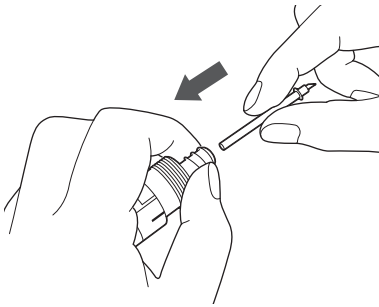

- 2** Twist on the holder cap to attach it to the holder.

Fully tighten the cap until the blade extension reaches its maximum, and then loosen the cap until the blade is no longer visible.

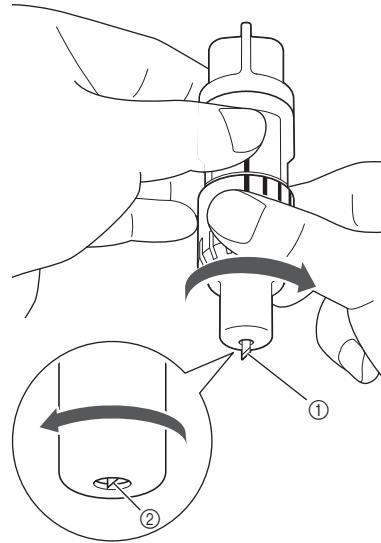

- ① Tighten the cap until the blade extension reaches its maximum.
② Loosen the cap until the blade becomes invisible from the cap end.

Note

- Loosen the holder cap until the blade tip is no longer visible. The blade extension scale on the holder applies when the blade begins to be extended from the cap end. For details on the blade extension, see “Adjusting the Blade Extension” on page 18.

Cleaning

■ Cleaning the Mat

Cuttings and cut edges of patterns attached to the mat may reduce the mat's adhesive strength and prevent correct operation. Periodically clean the mat. Using the included spatula, lightly scrape off any cuttings attached to the mat.

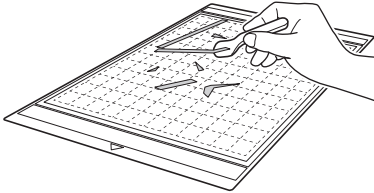

Use commercially available tweezers to remove any fabric threads attached to the mat.

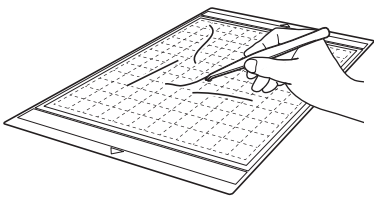

Clean the dotted marks on the mat and their surrounding area.

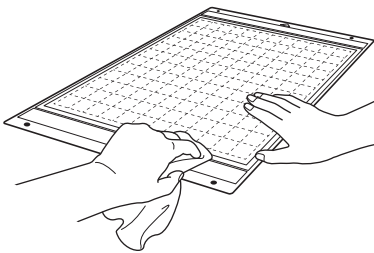

Note

- Do not use alcohol or water to clean the mat.
- When the mat is not being used, clean it, and then store it with the protective sheet affixed. At that time, do not affix the protective sheet while the mat is damp. Otherwise, the mat's adhesive strength will decrease.
- Do not fold or bend the mat to store it.
- Store the mat at room temperature and in a location not exposed to high temperatures, high humidity or direct sunlight.
- If the mat no longer has any adhesive strength, replace it with a new one. For details on optional mats, see "OPTIONAL ACCESSORIES" on page 66.

■ Cleaning the Holder

If material cuttings, lint or dust accumulate in the holder, it may not operate correctly. Clean the holder after every use.

- 1 Twist off the holder cap to remove it.

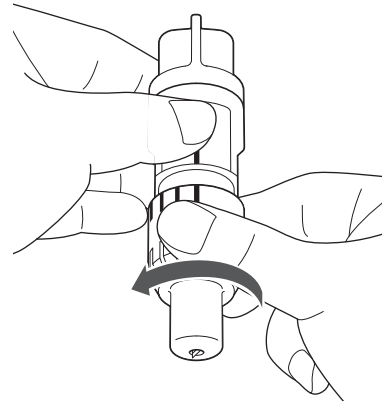

- 2 Using a commercially available brush, clean off cuttings, lint and dust.

Specifically clean off lint and dust around the blade. If lint and dust accumulate between the blade and holder, the blade may no longer rotate or the cutting quality may become poor.

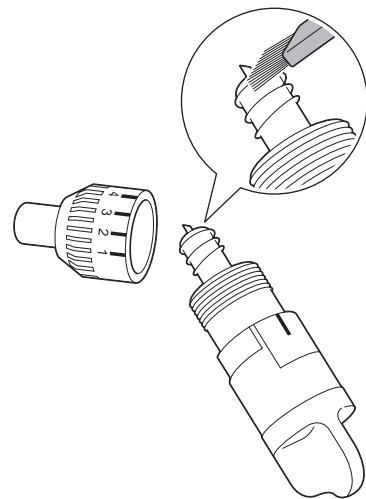

- 3 Attach the holder cap to the holder.

For details on attaching the holder cap, see "Installing" on page 57.

■ Cleaning Inside the Machine

If there are vertical lines or blank areas in the scanned image, lint or dust may have accumulated in the machine. The Lint may also attach to the surface of the feed rollers, preventing a mat to be loaded or unloaded correctly. Use a soft brush to clean it.

- 1 Turn off the machine and disconnect the power cord plug, and then disconnect the AC adapter plug from the DC power jack on the back of the machine.

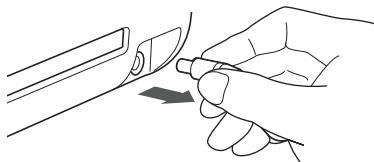

- 2 Open the cover on the front of the machine.

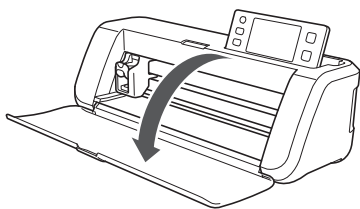

- 3 Remove the holder from the carriage.

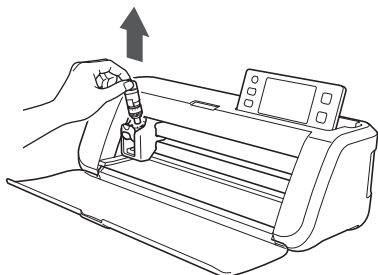

- 4 Use a commercially available brush to clean around the feed slot and the carriage.

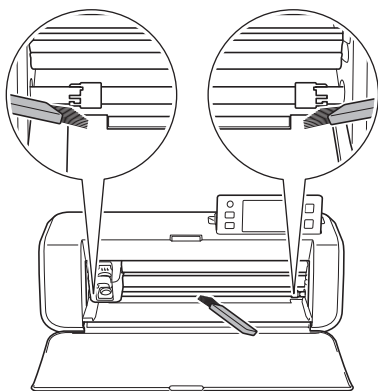

Cleaning the Scanner Glass

If there are unwanted vertical lines in the scanned image or if scanning cannot be done cleanly, the scanning area of the scanner may have become dirty. Clean the scanner glass at the bottom of the machine.

- 1 Turn off the machine and disconnect the power cord plug, and then disconnect the AC adapter plug from the DC power jack on the back of the machine.

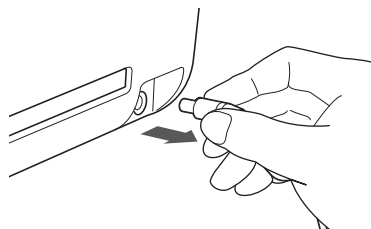

- 2 Store away the operation panel.

First raise the panel until it is vertical, and then lower and store it away.

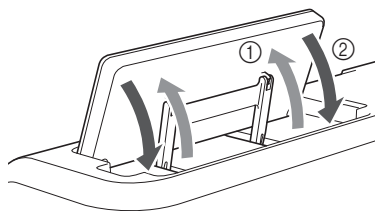

- 3 While pushing in the tab at the bottom of the machine, pull up on the cover.

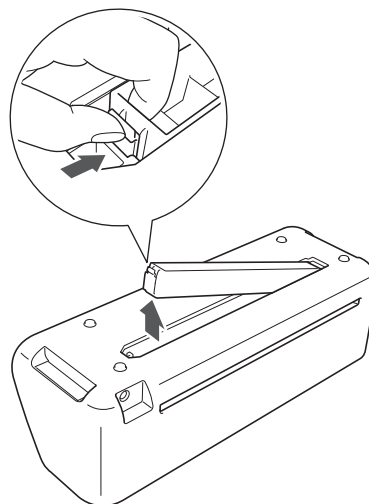

- 4 Dampen a soft lint-free cloth with water and firmly wring it out, and then wipe the scanner glass at the inside on the bottom of the machine.

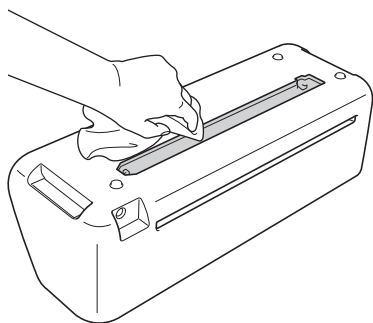

- 5 Fit the tab on the cover into the notch of the installation slot, and then attach the cover to the machine.

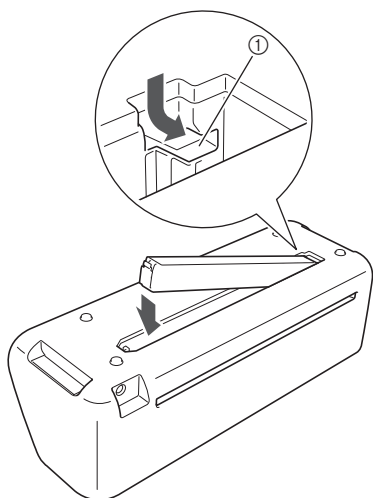

① Notch

- 6 After cleaning, perform a test scan.

Adjusting the Screen

If the screen does not respond correctly when you touch a key (the machine does not perform the operation or performs a different operation), follow the steps below to make the proper adjustments.

- 1 Holding your finger on the LCD screen, turn the main power to off and back to on.

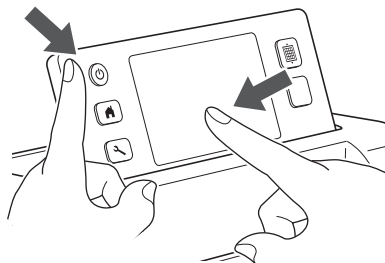

► The touch panel adjustment screen is displayed.

- 2 Using the included touch pen, lightly touch the center of each +, in order from 1 to 5.

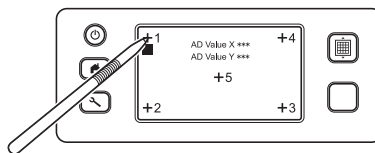

► After completing the touch panel adjustment, the message "SUCCESS" appears on the screen.

- 3 Turn the main power to off, then turn it back to on.

Note

- If you finish the screen adjustment and the screen still does not respond correctly, or if you cannot do the adjustment, contact the retailer who sold you this machine or the nearest authorized service center.

TROUBLESHOOTING

If the machine stops operating correctly, check the following possible problems before requesting service. You can solve most problems by yourself. If you need additional help, the Brother Solutions Center offers the latest FAQs and troubleshooting tips. Visit us at <http://solutions.brother.com>. If the problem persists, contact the retailer who sold you this machine or the nearest authorized service center.

Power Supply

Symptom	Possible Causes (or Results)	Solutions	Reference
The machine cannot be turned on.	The AC adapter is not correctly connected to the machine.	Check that the AC adapter is connected to the machine and that the power cord is connected to the AC adapter and electrical outlet.	page 10

Mat

Symptom	Possible Causes (or Results)	Solutions	Reference
The mat cannot be inserted.	When the mat was inserted, it was not placed under the feed rollers.	Insert the mat so that it is placed under the feed rollers on the left and right sides of the feed slot.	page 20
	The mat was not loaded using the "Feed" button.	Lightly insert the mat into the feed slot, and then press the "Feed" button.	page 20
The mat cannot be recognized.	The dotted marks on the part of the mat that is inserted are dirty.	Clean the dotted marks on the mat and their surrounding area.	page 58
	The dotted marks on the part of the mat that is inserted are hidden by material that was attached.	Attach the material while keeping it within the adhesive area of the mat.	page 12
	The mat was inserted so that the side with the material attached is facing down.	Insert the mat so that the side with the material attached is facing up.	page 20
The mat is fed in at an angle.	The mat was inserted into the feed slot at an angle.	Press the "Feed" button to feed out the mat, and then re-insert it straight in.	page 20
	The corners of the mat are deformed (bent).	Replace the mat with a new one.	page 56
The material to be cut/drawn or original to be scanned cannot be attached to the mat.	The material extends from the adhesive area of the mat.	Attach the material while keeping it within the adhesive area of the mat.	page 12
	The mat's adhesive strength has decreased.	Replace the mat with a new one.	page 56
The mat cannot be fed out.	The material to be cut/drawn or original to be scanned is jammed in the feeding mechanism in the machine.	Press the "Feed" button while the mat is being inserted to feed it out. If the mat does not feed out, turn off the machine, and then carefully pull out the mat.	page 21
When the mat is inserted, the attached material peels off.	The mat is not level due to the weight of the material.	With your hands, hold the mat level when inserting it.	page 20
	The mat's adhesive strength has decreased.	Replace the mat with a new one.	page 56

Paper/Fabric Jam

Symptom	Possible Causes (or Results)	Solutions	Reference
The mat cannot be fed.	There is an obstruction around the slot at the back of the machine.	Maintain space around the slot at the back of the machine so that the mat can be fed out.	page 9
	The surface where the machine is installed is uneven.	Place the machine on a flat, even surface.	—

Symptom	Possible Causes (or Results)	Solutions	Reference
The mat or the material catches on a feed roller when the mat is being inserted.	The mat's adhesive strength has decreased, or the material is not secured.	Press the "Feed" button to feed out the mat, and then replace the mat with a new one.	page 21 page 56
	The material extends from the adhesive area of the mat.	Press the "Feed" button to feed out the mat, and then attach the material while keeping it within the adhesive area of the mat.	page 12 page 21
The mat or the material catches on a feed roller during cutting/drawing.	<ul style="list-style-type: none"> - The mat's adhesive strength has decreased, or the material is not secured. - The material extends from the adhesive area of the mat. 	Press the "Start/Stop" button to stop the operation. Follow the instructions on the screen, and press the "Feed" button to feed out the mat.	page 12 page 21 page 56
The mat is fed in at an angle and is not fed during cutting/drawing.		If the mat does not feed out, turn off the machine, remove the holder, and then manually feed out the mat.	
The material to be cut/drawn or original to be scanned peels off during cutting/scanning.		After feeding out the mat, replace it with a new one or attach the material while keeping it within the adhesive area of the mat.	

Cutting

Symptom	Possible Causes (or Results)	Solutions	Reference
The material being cut catches on the tip of the cutting blade.	Dust or lint has accumulated in the holder.	Clean the holder.	page 58
	The blade is worn.	Replace the blade with a new one.	page 56
	The material being cut is incompatible with this machine.	Replace the material with one compatible with this machine.	page 11
The machine stopped while an operation is being performed.	For safety, the machine stops operating if the panel is touched while cutting or drawing.	Follow the instructions in the message that appears in the screen. Touch the "OK" key to move the carriage to its initial position. Load the mat and perform the operation again.	—
Not all of the material to be cut is cut. Some areas remain uncut.	A blade appropriate for the material being cut is not used.	Use a blade appropriate for the material being cut.	page 12
	The blade extension from the blade holder is too little.	Remove the holder from the carriage, and then adjust the blade extension.	page 18
	The mat's adhesive strength has decreased, or the material is not secured.	Replace the mat with a new one.	page 56
	The blade is worn.	Replace the blade with a new one.	page 56
	The material is incompatible with this machine.	Replace the material with one compatible with this machine.	page 11
	The cutting pressure ("Cut Pressure") is incorrect.	Adjust the setting for "Cut Pressure" in the settings screen.	page 18 page 23
	Dust or lint has accumulated in the holder.	Clean the holder.	page 58
	The spacing between arranged patterns is too small.	Rearrange the patterns to slightly separate them. Set the number to "3" or higher in the "Pattern Interval" setting, and then rearrange the patterns or perform the auto layout function.	page 24 page 38
	Neither a high tack adhesive fabric support sheet or iron-on fabric appliqué contact sheet is used for fabric cutting.	Attach a high tack adhesive fabric support sheet to a mat or affix an iron-on fabric appliqué contact sheet to a fabric before cutting it.	page 13 page 15
A fabric is not firmly attached to a mat that has a high tack adhesive fabric support sheet on its adhesive side.	Firmly attach the fabric to the mat pressing the handle of the included spatula across the surface of the fabric.	page 14	

Symptom	Possible Causes (or Results)	Solutions	Reference
Not all of the material to be cut is cut. Some areas remain uncut.	An iron-on fabric appliqué contact sheet is not firmly attached to a fabric.	Iron the entire contact sheet to affix it firmly to the wrong side of the fabric.	page 16
There are deep cuts completely through the mat.	The blade extension from the blade holder is too much.	Remove the holder from the carriage, and then adjust the blade extension.	page 18
	The cutting pressure ("Cut Pressure") is incorrect.	Adjust the setting for "Cut Pressure" in the settings screen.	page 18 page 23

Drawing

Symptom	Possible Causes (or Results)	Solutions	Reference
The drawn line is thicker (thinner) than intended.	The drawing speed ("Draw Speed") or drawing pressure ("Draw Pressure") is incorrect.	Adjust the settings for "Draw Speed" and "Draw Pressure" in the settings screen. To draw thicker lines, increase the drawing pressure. To draw thinner lines, decrease the drawing pressure. To draw thicker lines, reduce the drawing speed. To draw thinner lines, increase the drawing speed. After adjusting the settings, perform a trial drawing operation.	page 23

Scanning

Symptom	Possible Causes (or Results)	Solutions	Reference
Unwanted images are scanned.	The scanning area is incorrectly specified.	In "Scan to USB" mode, specify the paper size with the "Scan Size" setting.	page 54
		In "Direct Cut" or "Scan to Cut Data" mode, trim the image in the editing screen after scanning.	page 48 page 51
Scanning cannot be done cleanly (there are lines in the scanned image).	The scanner glass is dirty.	Clean the scanner glass from the bottom of the machine.	page 59
	The original to be scanned is dirty or scratched.	In "Scan to Cut Data" mode, remove thin lines or dirt in the image editing screen.	page 52
The lines printed on the mat are scanned.	The original is transparent so the lines printed on the mat are being scanned.	In "Scan to Cut Data" mode, remove the lines in the image editing screen.	page 52
The scanned image is red.	When the optional scanning mat is used, scanning is performed without peeling off the blue tape.	Peel off the blue tape from the optional scanning mat before scanning.	—

ERROR MESSAGES

The following table lists some of the messages that may appear while the machine is operating as well as their corresponding solutions.

Perform the necessary operation according to the instructions in the message or the solution described here.



If the problem persists, contact the retailer who sold you this machine or the nearest authorized service center.

Error Messages	Causes / Solutions
A malfunction occurred. Turn the machine off, then on again.	Turn the machine off, then on again.
Built-in memory is corrupted. Initialize the memory.	The data on the machine's memory is corrupted. Restart the machine.
Cannot operate when there are too many patterns.	The message appears under the following conditions: <ul style="list-style-type: none"> - There are 301 or more patterns being cut in the "Direct Cut" mode. - There are 301 or more patterns being saved as cutting data in the "Scan to Cut Data" mode. Reduce the number of patterns being used. <ul style="list-style-type: none"> - There are too many cutting lines to be created after large number of small patterns are scanned. - There are too many light tone patterns to be converted to two-tone (black and white) patterns while the image detection level is being adjusted. Scan images again after reducing the number of patterns arranged in the original.
Cannot operate when there is no pattern.	There is no scanned image or lines for scanning. Recheck the image to be scanned, and adjust the scanning area, image detection level and "Delete Size" settings. In addition, change the image drawn on the original to one more easily scanned.
Character string is too long for the mat.	Reduce the number of characters so that the length of the character string fits in the width of the 12-inch mat (maximum possible width 297 mm).
Initialization of the blade position failed. Turn the machine off.	Turn the machine off, then on again.
Initialization of the head failed. Turn the machine off.	
No more patterns can be added to this combination.	301 or more patterns cannot be combined. Reduce the number of patterns.
No pattern in the effective area.	There is no pattern(s) to be cut out or drawn within the cutting area. To cut out or draw a pattern outside of the area, increase the setting for "Cut Area", or move the pattern(s) into the area specified with "Cut Area" (page 23).
Not enough available memory to save the data.	Delete a file from the machine's memory or USB flash drive.
Not enough space on the mat. Check pattern size, space on the mat, Cut Area (setting) or Pattern Interval (setting).	Perform one of the following to arrange the patterns. <ul style="list-style-type: none"> - Delete a pattern already arranged in the pattern layout screen. - Resize a pattern in the arrangement. - Enlarge the setting for "Cut Area" (page 23). - Reduce the spacing between arranged patterns using the "Pattern Interval" setting.
Not enough space on the mat. Max: 10 (example: calculated number)	Since there are too many patterns, they cannot be arranged. Reduce the number of patterns to the maximum shown on the screen.
OK to retrieve and resume previous memory?	To use data from the previous operation, touch the "OK" key. (page 24)
Patterns cannot be unified. Invalid pair was selected.	The message appears when you are unifying patterns. Patterns with seam allowances and no seam allowances are selected as pairs. Select patterns, all of which have either seam allowances or no seam allowances.

Error Messages	Causes / Solutions
<p>Patterns cannot be welded. There are some patterns which cannot accept or no overlaps.</p>	<p>The message appears when you are welding patterns.</p> <ul style="list-style-type: none"> - The patterns do not overlap. Rearrange them so the selected patterns overlap. Unifying the pattern, instead, can be an alternative editing method depending on your project. - A pattern that has a seam allowance is selected. Deactivate the seam allowance setting and weld the patterns. - An open shape is selected as a pattern. Only closed shapes can be welded. Unifying the pattern, instead, can be an alternative editing method depending on your project.
<p>Patterns may overlap since seam allowance is set to large on the machine.</p>	<p>When the seam allowance setting for a pattern becomes larger than with a previous operation, the edges may overlap nearby patterns. Adjust the seam allowance setting. Otherwise, increase the spacing between patterns.</p>
<p>Scanning error occurred. Turn the machine off.</p>	<p>Turn the machine off, then on again, and then try performing the operation again.</p>
<p>The data cannot be deleted.</p>	<p>The USB flash drive being used may not be usable with this machine. If unplugging the USB flash drive and performing the operation again causes the message to appear again, replace the USB flash drive. For information about USB flash drive compatible with this machine, visit our website “ http://solutions.brother.com ”.</p>
<p>The data cannot be read.</p>	
<p>The data cannot be saved.</p>	
<p>The mat cannot be recognized. The mat will unload.</p>	<p>A mat that cannot be recognized has been inserted. If a mat designed specifically for this machine is not being used, use the specially designed mat.</p>
	<p>Clean the dotted marks at the edge of the mat and their surrounding area. If the mat is still not recognized, replace the mat with a new one.</p>
<p>There are some patterns which cannot add seam allowance.</p>	<p>The seam allowance settings cannot be specified for complex pattern shapes. Select a pattern with a simple shape. Expanding the seam allowance (shadow) to 2 mm or more may help.</p>
<p>There are some patterns which cannot set cutting distance from the outline.</p>	
<p>There is a pattern included that cannot be saved to USB media. Save the pattern in the machine’s memory.</p>	<p>Depending on the pattern, it may not be possible to save it to a USB flash drive.</p>
<p>There is a pattern out of the effective area. The pattern cannot be cut or drawn. OK to continue?</p>	<p>There is a pattern(s) outside of the cutting area. If the pattern(s) outside of the cutting area need(s) not to be cut out or drawn, continue the operation. To cut out or draw the pattern(s) outside of the area, increase the setting for “Cut Area”, or move the pattern(s) into the area specified with “Cut Area” (page 23).</p>
<p>This data is too complicated and cannot be converted.</p>	<p>When you are welding or unifying patterns: Reduce the number of patterns arranged or change the patterns to ones with simple designs.</p>
<p>This mat cannot be used.</p>	<p>The mat is one that cannot be used with the function being performed. Replace the mat.</p>

UPGRADING THE SOFTWARE

Using a USB flash drive, the machine's software can be upgraded. For upgrade information, refer to details posted on the Brother Solutions Center (<http://solutions.brother.com/>). If an upgrade file is posted, download the file, and then upgrade the machine according to the following procedure.

1 While holding down  in the operation panel, press  to turn on the machine.

2 Plug the USB flash drive containing the upgrade file into the USB port on this machine.

The USB flash drive must not contain any data other than the upgrade file. Otherwise, the machine may stop operating correctly.

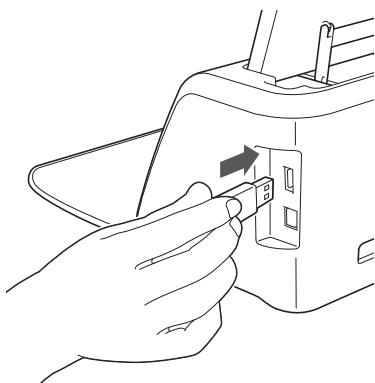

Note

- This machine is incompatible with a USB hub. Plug the USB flash drive directly into the USB port.

3 Touch the "Update" key to start the upgrade.



- ▶ When upgrading is finished, the completion message appears.

4 Unplug the USB flash drive from the port.

5 Turn the machine off, then on again.

OPTIONAL ACCESSORIES

The following are available as optional accessories to be purchased separately.

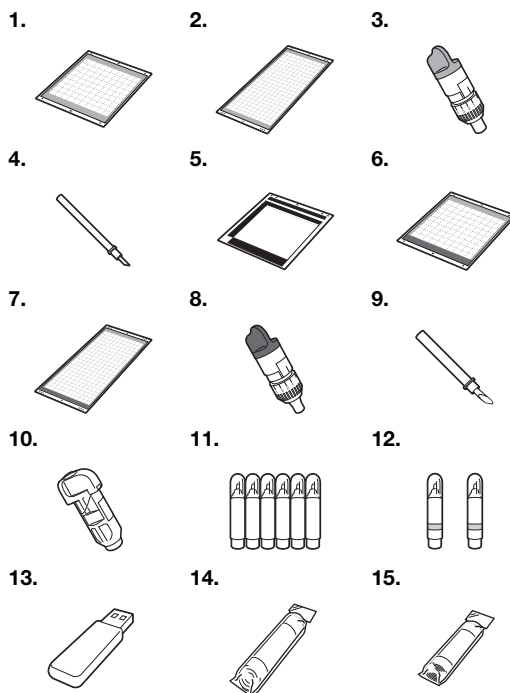

No.	Part Name	Part Code
1	Low tack adhesive mat 12" × 12" (305 mm × 305 mm) (turquoise)	CAMATP12
2	Low tack adhesive mat 12" × 24" (305 mm × 610 mm) (turquoise)	CAMATP24
3	Standard cut blade holder (turquoise) (with no blade)	CAHLP1
4	Standard cut blade	CABLDP1
5	Scanning mat 12" × 12" (305 mm × 305 mm)	CAMATS12
6	Standard mat 12" × 12" (305 mm × 305 mm) (turquoise and purple)	CAMATF12
7	Standard mat 12" × 24" (305 mm × 610 mm) (turquoise and purple)	CAMATF24
8	Deep cut blade holder (purple) (with no blade)	CAHLF1
9	Deep cut blade	CABLDF1
10	Pen holder	CAPENHL1
11	Color pen set	CAPEN1
12	Erasable pen set	CAPEN2
13	Contents USB	*
14	Iron-on fabric appliqué contact sheet (white backing)	CASTBL1
15	High tack adhesive fabric support sheet (light blue backing)	CASTBL2

* Contact the retailer who sold you this machine or the nearest authorized service center.

INDEX

- A**
Advanced (art category) pattern cutting27
Auto shutdown 23, 24
- B**
Background23
Background scanning38
Basic pattern cutting25
Blade extension 18, 22
Buzzer sound23
- C**
Carriage9, 19
Character input functions40
Cleaning58
Cut area 23, 35
Cut pressure 18, 23, 27
Cut speed23, 27
Cutting around drawings44
Cutting blade replacement56
Cutting line50
- D**
DC power jack9, 59
Deep cut blade17
Direct cut47
Draw pressure 23, 44
Draw speed23, 44
Draw/cut selection screen27
Drawing functions43
- E**
Error messages64
- F**
Feed slot9, 20
- H**
High tack adhesive fabric support sheet13
Holder lock lever9, 19
Holder setting19
Home screen 11, 25
- I**
Image editing screen50, 52
Image trim screen48, 49
Iron-on fabric appliqué contact sheet15
- L**
Language23
Layout editing functions35
Layout Interval24
Low tack adhesive mat12
- M**
Main power on/off10
Main power switch 11, 25
Mat loading20
Mat unloading21
- O**
Opening screen 11, 24
- Operation panel9, 10
Optional accessories66
Outline distance49
Outlining and framing49
- P**
Parts and functions9
Pattern category selection screen25
Pattern editing functions33
Pattern editing screen25, 33
Pattern layout screen26, 35
“Pattern” mode8
Pattern piece editing screen29, 34
Pattern piece list screen28
Pattern selection screen25, 28
Pattern sizing screen28
Pattern sub-category selection screen28
Picture editing52
- R**
Recalling41
Replacement criteria56
Required material condition (cutting/drawing)11
Required material condition (scanning)47, 54
- S**
Saving41
“Scan” mode8, 47
Scan to cut data50
Scan to USB54
Seam allowance24, 34, 44
Settings screen23
Software upgrade66
Standard cut blade12
Standard scale settings18
- T**
Touch screen calibration60
Trial cutting19
Troubleshooting61
- U**
Unifying36
Unit23
USB port9, 41, 66

Please visit us at <http://solutions.brother.com> where you can get product support and answers to frequently asked questions (FAQs).

English
891-Z01
Printed in China



XF5251-001