

Before you can use the MFC, you must set up the hardware and install the driver. Please read this "Quick Setup Guide" for proper set up and installation instructions.

Step 1

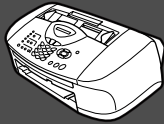

Setting Up the Machine

Step 2







Installing the Driver & Software













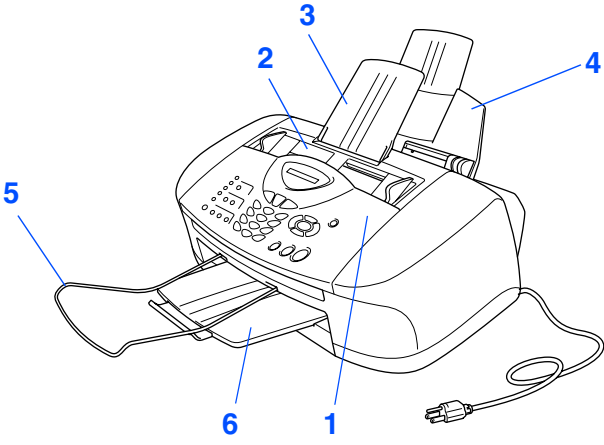
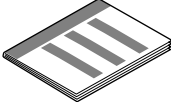

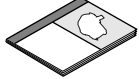
Setup is Complete!

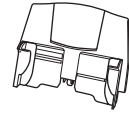
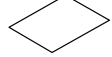
For the latest drivers and to find the best solution for your problem or question, access the Brother Solutions Center directly from the driver or go to <http://solutions.brother.com>
Keep this "Quick Setup Guide", User's Guide and supplied CD-ROM in a convenient place for quick and easy reference at all times.

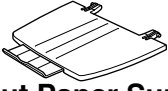
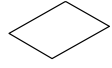
 Warning		 Hint	 User's Guide
Indicates warnings that must be observed to prevent possible personal injury.	Indicates cautions that must be observed to use the MFC properly or to prevent damage to the MFC.	Indicates notes and useful tips to remember when using the MFC.	Indicates reference to the User's Guide.

Getting Started

Carton Components

<p>MFC</p>  <p>1. Control Panel 2. Top Cover</p>		 <p>Quick Setup Guide</p>	
		 <p>CD-ROM</p>	
		 <p>User's Guide</p>	
<p>3</p>  <p>ADF Document Support</p>	<p>4</p>  <p>Paper Tray</p>	 <p>Accessory Order Form</p>	
<p>5</p>  <p>ADF Document Output Support</p>	<p>6</p>  <p>Output Paper Support</p>	 <p>Test Sheet (USA only)</p>	
 <p>Telephone Line Cord</p>		 <p>One Touch Labels</p>	
<div style="display: flex; justify-content: space-around; align-items: center;"> <div style="text-align: center;">  <p>Black (LC31BK)</p> </div> <div style="text-align: center;">  <p>Magenta (LC31M)</p> </div> <div style="text-align: center;">  <p>Yellow (LC31Y)</p> </div> <div style="text-align: center;">  <p>Cyan (LC31C)</p> </div> </div> <p style="text-align: center;">Ink Cartridges</p>			

Carton components may differ from one country to another.
Save all packing materials and the carton.



- You must use the appropriate USB cable.
- The interface cable is not a standard accessory. Please purchase an appropriate USB interface cable.
- Use only a USB interface cable that is no longer than 6 feet long (2 meters).

Control Panel

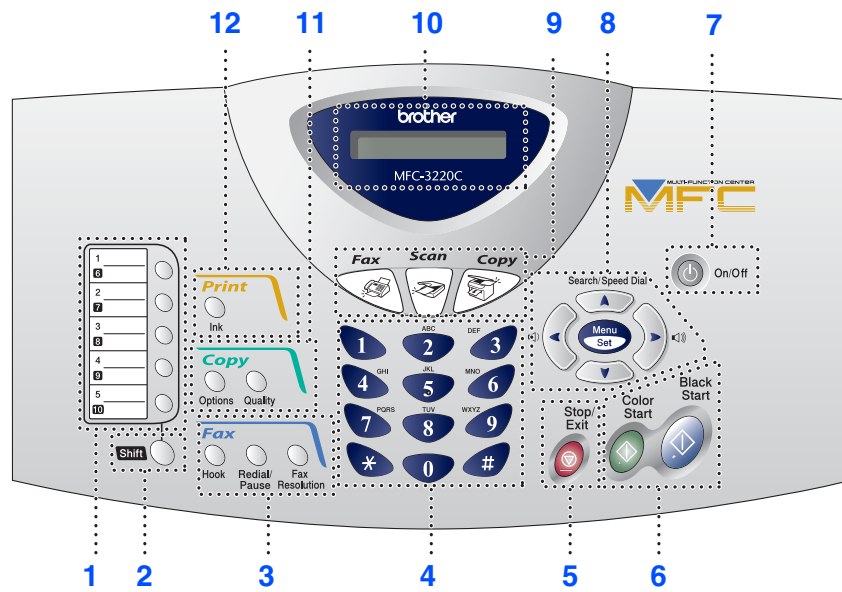

1. One Touch keys	5. Stop/Exit	9. Mode keys
2. Shift	6. Start keys	10. Liquid Crystal Display (LCD)
3. Fax and telephone keys	7. On/Off key	11. Copy keys (Temporary Settings)
4. Dial Pad	8. Navigation keys	12. Print key



For the details of the control panel, see "Control panel overview" in Chapter 1 of the User's Guide.

Table of Contents

Step 1 **Setting Up the Machine**

1. Removing the Protective Parts	4
2. Attaching the Paper Tray and Supports	4
3. Loading Paper	5
4. Install Phone Line and Power Cord	5
5. Installing the Ink Cartridges	6
6. Color Block Quality and Alignment Check	8
7. Setting the Date and Time	10
8. Setting Your Station ID	11
9. Selecting a Receive Mode	12
10. Selecting Your Language (Canada Only).....	13
11. Sending in the Product Registration and Test Sheet (USA Only)	13

Step 2 **Installing the Driver & Software**

Windows®

Supplied CD-ROM (MFL-Pro Suite).....	14
For Windows® 98/98SE/Me/2000 Professional/XP Users.....	16
■ For Windows® 98/98SE/Me Users Only	19
■ For Windows® 2000 Professional Users Only	21
■ For Windows® XP Users Only	23

Macintosh®

For Mac OS® 8.6 to 9.2 Users	24
For Mac OS® X 10.1/10.2.1 or greater Users	26

Step 1

Setting Up the Machine

1 Removing the Protective Parts

- 1 Remove the protective tape.



Do NOT connect the USB cable.
Connecting the USB cable is done when installing the driver.

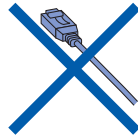

- 2 Open the control panel cover by pulling it toward you (①), and then lift the top cover toward the back (②).

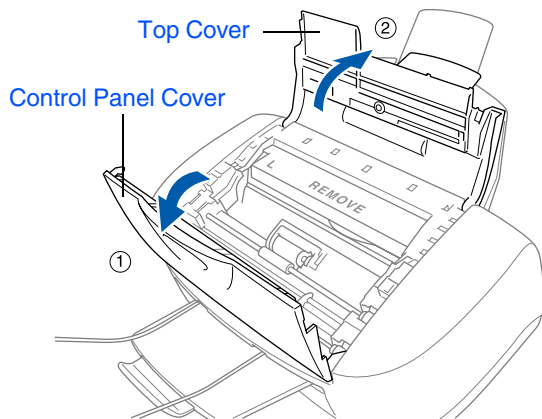

- 3 Pull the protective yellow bar out of the machine.

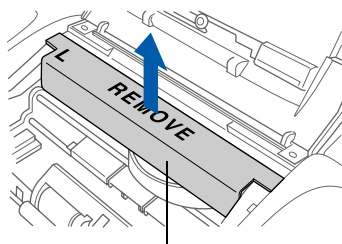

Protective Yellow Bar



Do not throw away the protective yellow bar. You will need it in the future to transport the machine.

- 4 Close the top cover, and then close the control panel cover.

2 Attaching the Paper Tray and Supports

- 1 Insert the paper tray from above into the back of the MFC.

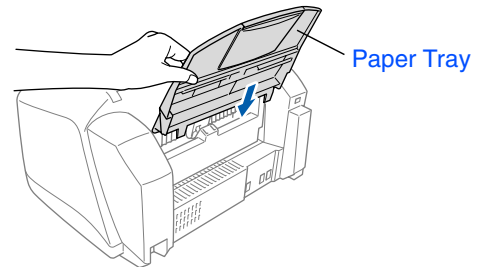

- 2 Attach the ADF document support.

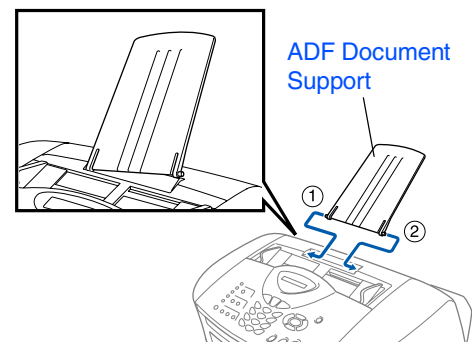

- 3 Attach the output paper support to the paper output slot, and then pull out the extension.

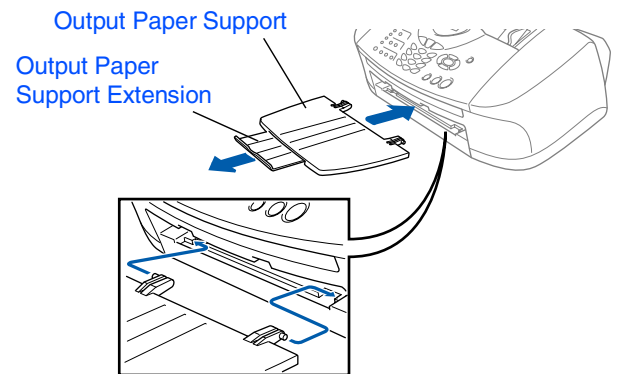

- 4 Attach the ADF document output support.

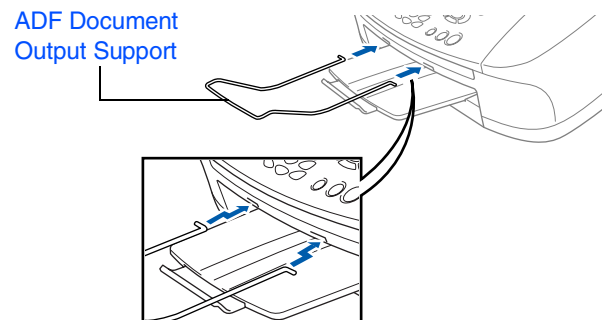

3 Loading Paper



You can load up to 100 sheets of 20 lb (80 g/m²) paper.

For more details, see "Paper Capacity of the Paper Tray" in Chapter 2 of the User's Guide.

- 1 Fan the stack of paper well to avoid paper jams and misfeeds.

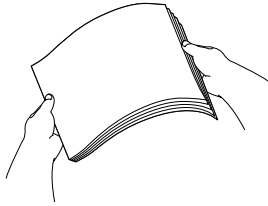

- 2 Unfold the paper support and then press and slide the paper guide to fit the paper width.

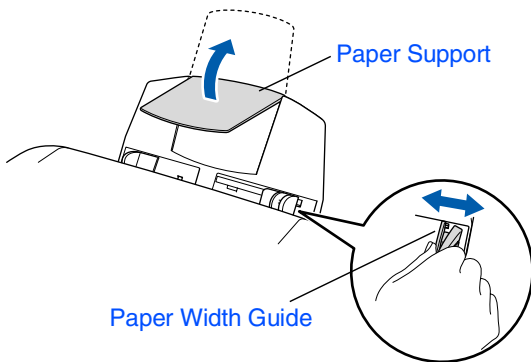

- 3 Gently insert the paper. Make sure the print side is towards you and the paper is below the maximum paper mark.

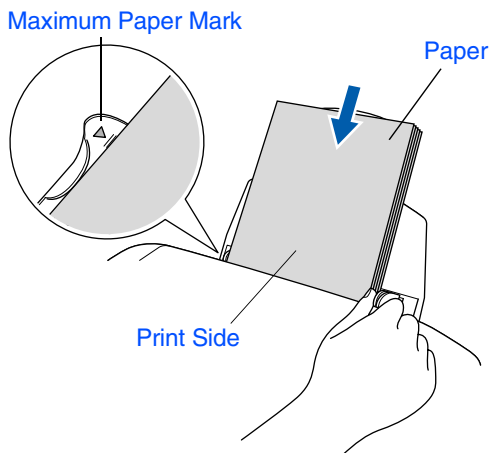

4 Install Phone Line and Power Cord

- 1 Connect the power cord.

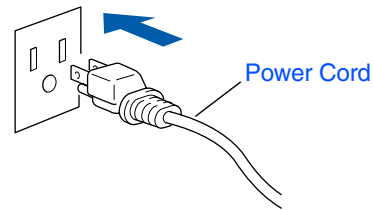

- 2 Connect the telephone line cord. Connect one end of the telephone line cord to the jack on the MFC marked **LINE** and the other end to a modular wall jack.

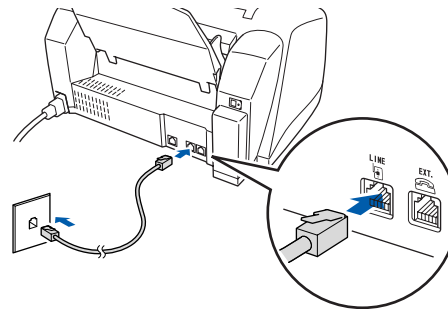

Do not connect the USB cable yet.

Warning

- The MFC must be grounded using a 3-prong plug.
- Since the MFC is grounded through the power outlet, you can protect yourself from potentially hazardous electrical conditions on the telephone network by keeping the power to your MFC on when you connect it to a telephone line. Similarly, you can protect yourself when you want to move your MFC by disconnecting the telephone line first and then the power cord.

Continued...

Step 1

Setting Up the Machine



If you are sharing one phone line with an external telephone, connect it as shown below.

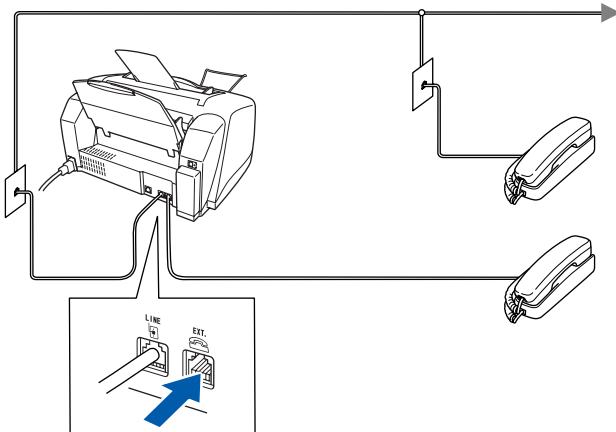

If you are sharing one phone line with an external telephone answering machine, connect it as shown below.



Please set the Receive Mode to "External TAD" if you have an external answering machine. For more details, see "Connecting the machine" in Chapter 1 of the User's Guide.

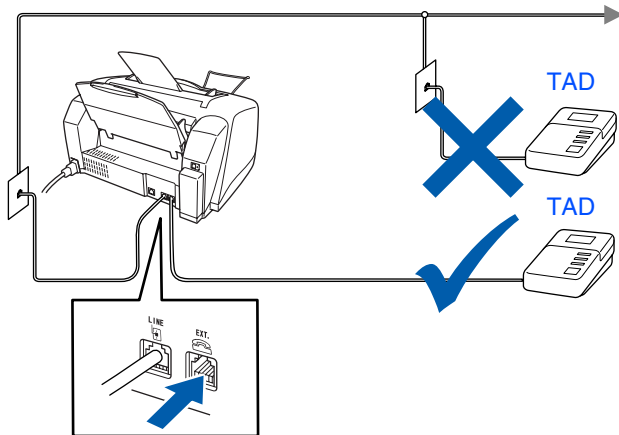

5

Installing the Ink Cartridges

Warning

If ink gets in your eyes irrigate them with water immediately, and if irritation occurs consult a doctor.

- 1 Make sure that the power is turned on. The LCD shows;

Check Cartridge

- 2 Open the control panel cover by pulling it toward you (1), then lift the top cover toward the back (2). The print heads will move to the ink replacement position.

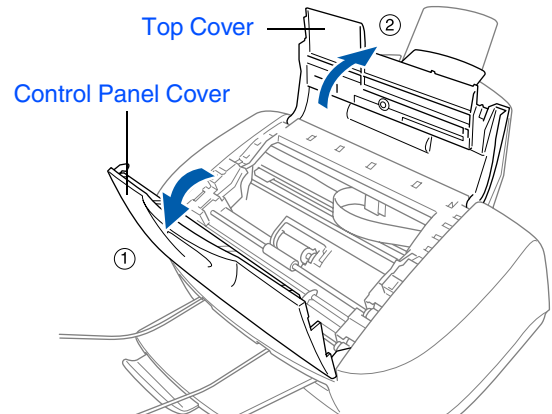

- 3 Push the four colored ink cartridge covers one at a time so they pop up.

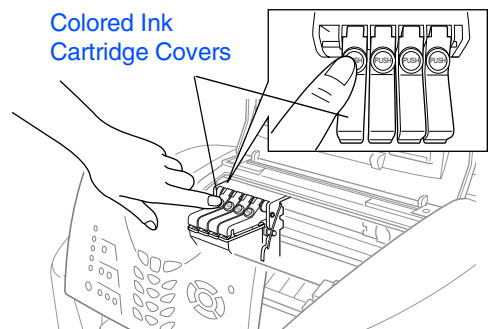

- 4 Remove the white shipping cover by pulling it towards you.

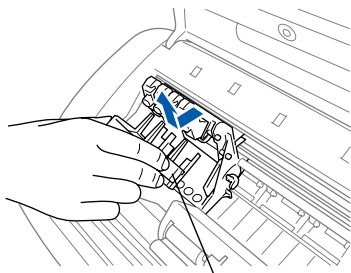

White Shipping Cover



- The bottom of the white shipping cover is wet with ink that will cause stains, so wipe it clean before you place it down.
- Do not throw away the white shipping cover. You will need it when you transport the machine.

- 5 Take out the black ink cartridge.

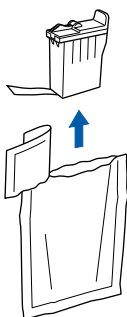

- 6 Carefully remove the sealing tape from the ink cartridge.
To prevent spilling ink and staining your hands and clothing, peel the sealing tape gently and slowly.

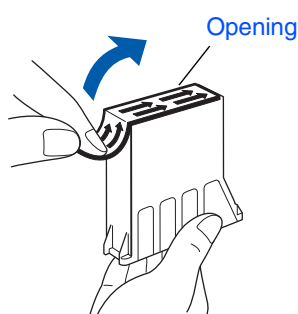

- 7 Gently insert the black ink cartridge in the black ink position.

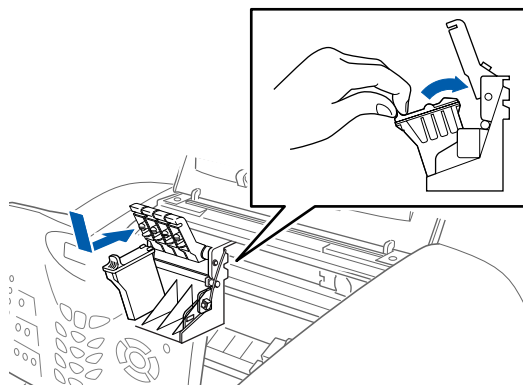

- 8 Press the cover down until it clicks.

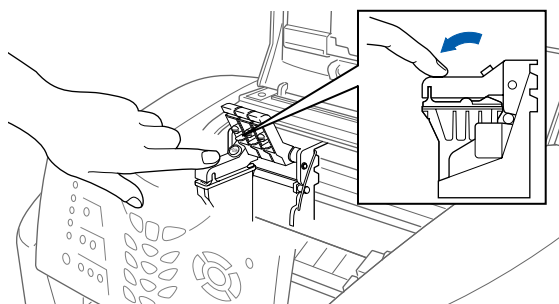

- 9 Repeat Steps 5 to 8 to install each color ink cartridge. Match the colors of the ink to the cartridge covers.

- 10 Close the top cover and control panel cover. The MFC will enter a head cleaning cycle for approximately four minutes.

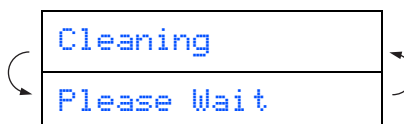

Continued...



- Do not touch the ink opening on the cartridge or removed tape.



- **DO NOT** remove ink cartridges if you do not need to replace them. If you do so, it may reduce the ink quantity and the MFC will not know the quantity of ink left in the cartridge.
- **DO NOT** shake the ink cartridges. If ink stains your body or clothing, wash with soap or detergent immediately.
- **Brother strongly recommends that you do not refill the ink cartridges provided with your machine. We also strongly recommend that you continue to use only Genuine Brother Brand replacement ink cartridges. Using or attempting to use potentially incompatible inks and/or cartridges in your machine may cause damage to the machine itself and/or it may result in unsatisfactory print quality. Our warranty coverage does not apply to any problem that was caused by the use of unauthorized third party ink and/or cartridges. To protect your investment and guarantee your print quality please continue to replace consumed ink cartridges with only Genuine Brother Branded Supplies.**



- *If you mix the colors by installing an ink cartridge in the wrong position, you must clean the print head by running several cleaning cycles after correcting the cartridge installation. (See "Cleaning the print head" on page 12-10 of the User's Guide.)*
- *Once you open an ink cartridge, install it in the MFC and use it up within six months of installation. Use unopened ink cartridges by the expiration date written on the cartridge package.*
- *If Ink Empty shows on the LCD after you install the ink cartridges, check to make sure the ink cartridges are installed correctly.*

6

Color Block Quality and Alignment Check

- 1 After the cleaning cycle is finished, the LCD shows;

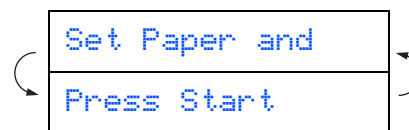

- 2 Make sure the paper is loaded in the paper tray.
Press **Color Start**.

- 3 The MFC starts printing the PRINT QUALITY CHECK SHEET (only during initial ink cartridge installation).

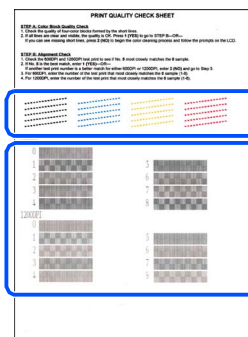

Check in **Step A**

Check in **Step B**

Step A: Color Block Quality Check

- 1 The LCD shows:

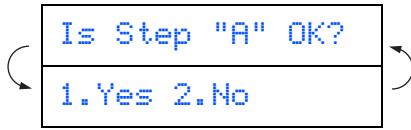

Check the quality of the four color blocks formed by the short lines printed on the sheet.
(BLACK/CYAN/YELLOW/MAGENTA)

- 2 If all lines are clear and visible, press 1 on the dial pad to go to **STEP B: Alignment Check**.

---OR---

If you can see missing short lines, press 2 on the dial pad and go to 3.

OK

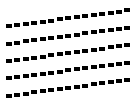

Poor



- 3 The LCD asks you if the print quality is OK for each color. Press 1 or 2 on the dial pad.

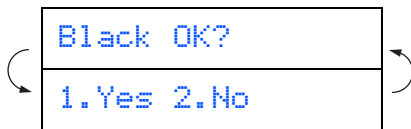

When you have finished selecting 1 (YES) or 2 (NO) for each color, the LCD shows:

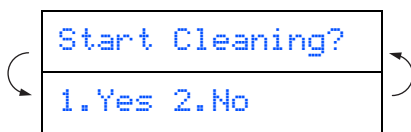

Press 1 (YES), and then MFC starts cleaning the colors.

After cleaning is finished, press **Color Start**. The MFC starts printing the PRINT QUALITY CHECK SHEET again and goes back to the first step of STEP A.

Step B: Alignment Check

- 1 The LCD shows:

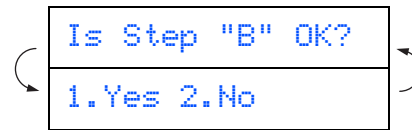

Check the 600 dpi and 1200 dpi test print to see if **No.5** most closely matches the OK sample (**No.0**). Press 1 if **No.5** matches it.

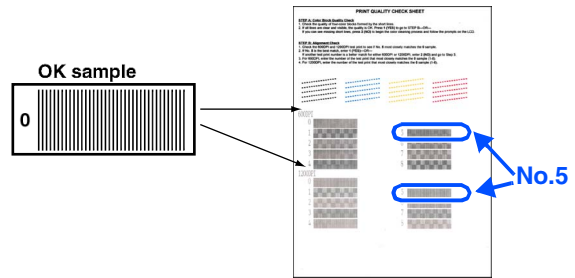

600 DPI

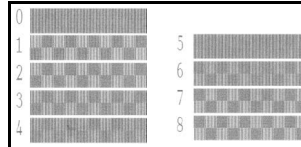

1200 DPI

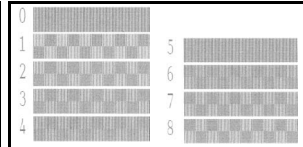

If another test print number is a better match for either 600 dpi or 1200 dpi, press 2 to select NO and go to 2.

- 2 For 600 dpi, select the number from 1 to 8 that most closely matches the **No.0** sample and enter it using the dial pad.

Select Best #

- 3 For 1200 dpi, enter the number from 1 to 8 that most closely matches the **No.0** sample.

Select Best #

The Quality check is now complete.

Step 1

Setting Up the Machine

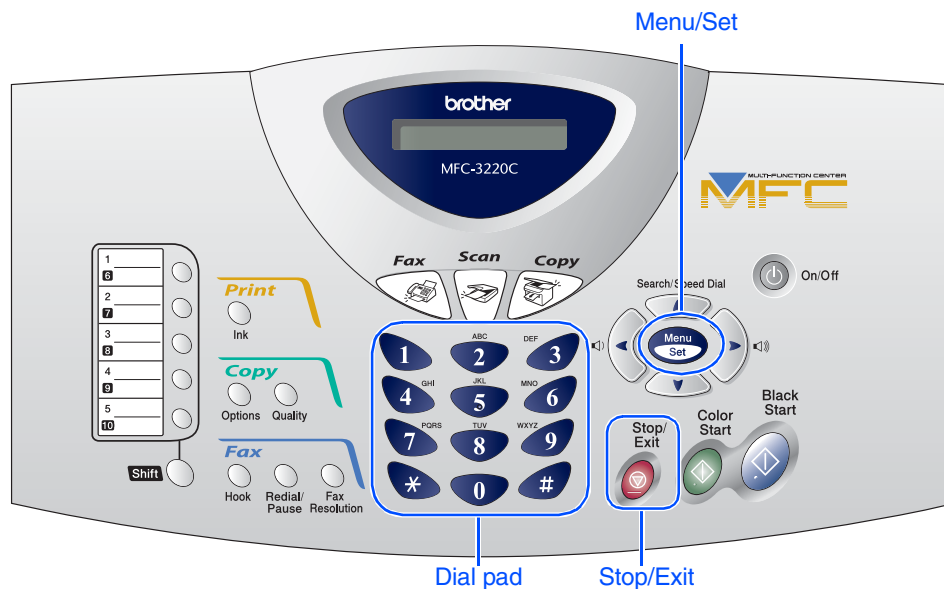

7 Setting the Date and Time

The MFC displays the date and time, and prints it on every fax you send.

- 1 Press **Menu/Set**.
- 2 Press **0**.
- 3 Press **2**.
- 4 Enter the last two digits of the year on the dial pad, and then press **Menu/Set**.

Year: 2004

(e.g. Enter **0, 4** for 2004.)

- 5 Enter the two digits for the month on the dial pad, and then press **Menu/Set**.

Month: 03

(e.g. Enter **0, 3** for March.)

- 6 Enter the two digits for the day on the dial pad, and then press **Menu/Set**.

Day: 01

(e.g. Enter **0, 1**.)

- 7 Enter the time in 24-hour format on the dial pad, and then press **Menu/Set**.

Time: 15:25

(e.g. Enter **1, 5, 2, 5** for 3:25 P.M.)

- 8 Press **Stop/Exit**.

 If you want to repeat from step 1, press **Stop/Exit**.

8 Setting Your Station ID

You should store your name and fax number to be printed on all fax pages that you send.

- 1 Press **Menu/Set**.
- 2 Press **0**.
- 3 Press **3**.
- 4 Enter your fax number (up to 20 digits) on the dial pad, and then press **Menu/Set**.

Fax: _

- 5 Use the dial pad to enter your name (up to 20 characters), and then press **Menu/Set**.

Name: _



- Refer to the following chart for entering your name.
- If you need to enter a character that is on the same key as the previous character, press  to move the cursor to the right.

Press key	One time	Two times	Three times	Four times
2	A	B	C	2
3	D	E	F	3
4	G	H	I	4
5	J	K	L	5
6	M	N	O	6
7	P	Q	R	S
8	T	U	V	8
9	W	X	Y	Z



For more details, see "Setting the Station ID" in Chapter 4 of the User's Guide.

- 6 Press **Stop/Exit**.



If you want to repeat from step 1, press **Stop/Exit**.

Step 1

Setting Up the Machine



9 Selecting a Receive Mode

Are you connecting an external telephone or external telephone answering device to the MFC?

Yes

No

Are you using the voice message function of your external telephone answering device?

Fax Only

No

The MFC automatically answers every call as a fax.

Do you want the MFC to answer fax calls only?

Yes

Fax/Tel

The MFC controls the line and automatically answers every call. If the call is not a fax, the phone will ring for you to pick up the call.

No

Manual

You control the phone line and must answer every call yourself.

Yes

External TAD

Your external telephone answering device (TAD) automatically answers every call. Voice messages are stored on the external TAD. Fax messages are printed.

There are four possible receive modes: Fax Only, Fax/Tel, Manual and External TAD.

- 1 Press **Menu/Set**.
- 2 Press **0**.
- 3 Press **1**.
- 4 Press **▲** or **▼** to select the mode.
- 5 Press **Menu/Set**.
- 6 Press **Stop/Exit**.



For more details, see "Setup Receive" in Chapter 5 of the User's Guide.

10 Selecting Your Language (Canada Only)

- 1 Press **Menu/Set**.
- 2 Press **0**.
- 3 Press **0**.
- 4 Select your language (ENGLISH or FRENCH) by using **▲** or **▼**, and then press **Menu/Set**.

English

- 5 Press **Stop/Exit**.

11 Sending in the Product Registration and Test Sheet (USA Only)

- 1 Fill out the Product Registration and Test Sheet.
- 3 Enter the toll-free fax number: 1-877-268-9575.

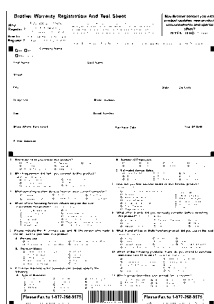

- 4 Press **Black Start**.



You will receive a confirmation fax of your Product Registration.



You can also register your product online using the On-Line Registration link from the installation CD-ROM or go to www.registermybrother.com

- 2 Place the sheet face down in the Automatic Document Feeder.

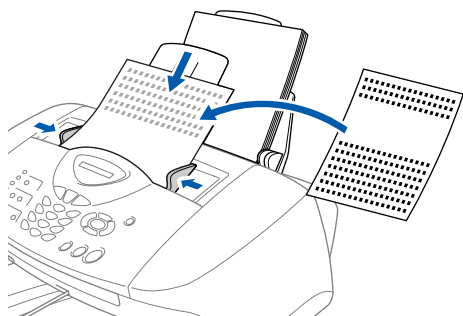

Make sure **(Fax)** is illuminated in Green.

Go to Next page to
install the driver

Windows®

Mac OS®
8.6-9.2

Mac OS® X
10.1/10.2.1 or greater

Supplied CD-ROM (MFL-Pro Suite)

The CD-ROM includes the following items:

Windows®



Install Software

You can install printer, PC-FAX Send, scanner drivers and the various utility items, including PaperPort® and TextBridge® OCR.



On-Line Registration

You will be pointed to the Brother Product Registration Web Page for quick registration of your MFC.



Documentation

View the User's Guide and other documentation in PDF format. (Viewer included)



Brother Support

You can access the Brother Solutions Center which is a Web site offering information about your Brother product including FAQs, User's Guides, Driver updates and Tips for using your machine.



Help

Helpful hints.

Macintosh®



Start Here

You can install the printer driver, scanner driver, PC-FAX Send and Presto! PageManager® for Mac OS® 8.6 - 9.2



Documentation

View the User's Guide and other documentations in PDF format.



Start Here OS X

You can install the printer driver, scanner driver, PC-Fax Send, remote setup program and Presto! PageManager® for Mac OS® 10.1/10.2.1 or greater (Scanning is not supported in OS 10.1).



Brother Solutions Center

You can access the Brother Solutions Center which is a Web site offering information about your Brother product including FAQs, User's Guides, Driver updates and Tips for using your machine.



ReadMe!

You can get important information and troubleshooting tips.



On-Line Registration

You will be pointed to the Brother Product Registration Web Page for quick registration of your MFC.



Follow the instructions on this page for your operating system.

Setting Up
the Machine

Windows®



For Windows® 98/98SE/Me/
2000 Professional/XP Users Go to page 16

Windows®

Macintosh®



For Mac OS® 8.6 to 9.2 Users Go to page 24

Mac OS®
8.6-9.2



For Mac OS® X 10.1/10.2.1 or greater Users Go to page 26

Mac OS® X
10.1/10.2.1 or greater

For Windows® 98/98SE/Me/2000 Professional/XP Users

Make sure that you have completed the instructions from Step 1 “Setting Up the Machine” on pages 4 - 13.

- 1 Turn off and unplug the MFC from the AC outlet and disconnect it from your computer, if you already connected an interface cable.

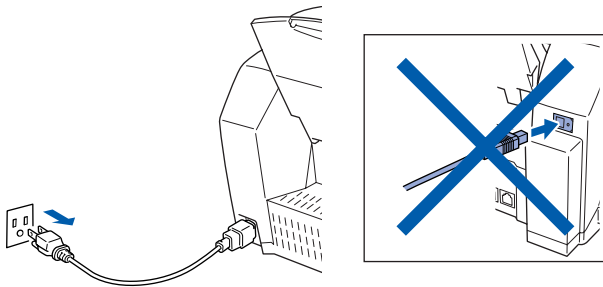

- 2 Turn on your computer. (For Windows® 2000 Professional/XP, you must be logged on as the administrator.)
- 3 Insert the supplied CD-ROM into your CD-ROM drive. If the model name screen appears, select your machine. If the language screen appears, select your language.



- 4 The CD-ROM main menu will appear. Click **Install Software**.



If this window does not appear, use Windows® Explorer to run the **setup.exe** program from the root directory of the Brother CD-ROM.

- 5 Click **MFL-Pro Suite** in Main Application.



MFL-Pro Suite includes Printer Driver, Scanner Driver, ScanSoft® PaperPort®, ScanSoft® TextBridge®, PC-FAX software, Remote Setup and True Type fonts. PaperPort® is a document management application for viewing scanned originals. ScanSoft® TextBridge®, which is integrated into PaperPort®, is an OCR application that converts an image into text and inserts it into your default word processor.

- 6 Click **Install**.

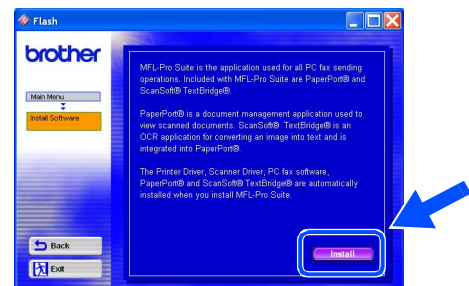

If you see the following screen, click **OK** to install the Windows® updates. After the updates are installed your PC may restart. Note: If it does the installation will automatically continue.

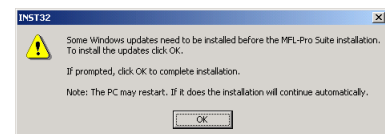

If the installation does not continue automatically, please open the installer menu again by double-clicking the **setup.exe** program from the root directory of the Brother CD-ROM, and continue from Step 4.

- 7 When the PaperPort® 8.0 SE Setup window is displayed, click **Next**.

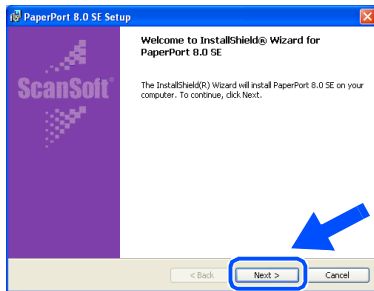

- 8 After reading and accepting the ScanSoft® License Agreement, enter your user information and click **Next**.

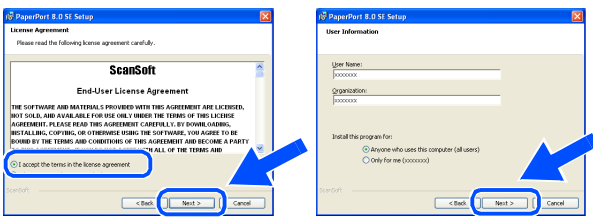

- 9 Select **Typical** and click **Next**.

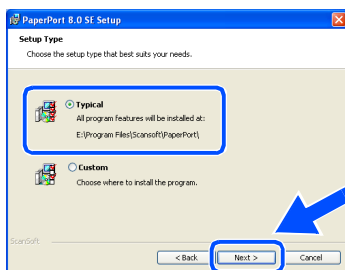

- 10 Click **Install** and PaperPort® will start installing on your computer.

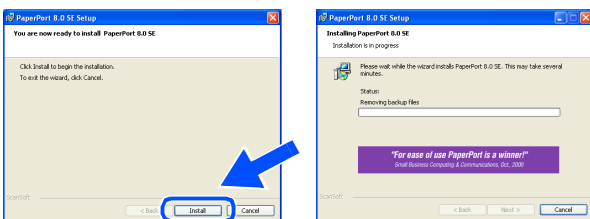

- 11 When the ScanSoft® Registration screen is displayed, make your selection and follow the on-screen instructions.

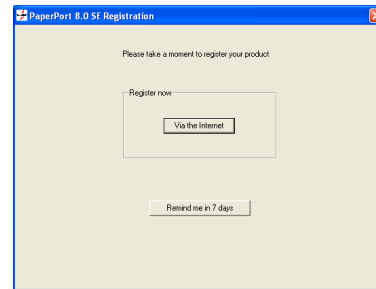

- 12 Click **Finish** to complete installation.

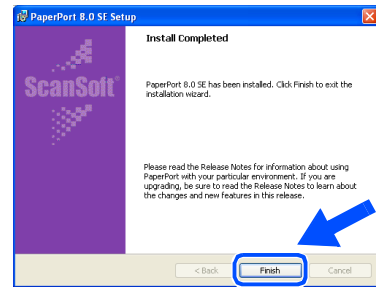

- 13 When the Brother MFL-Pro Suite Installation window appears, click **Next**.

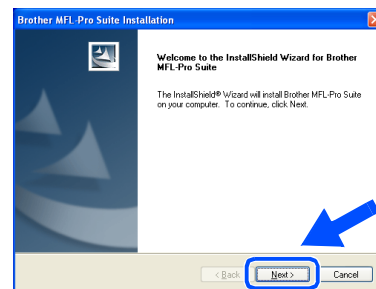

If an error message appears at this point in the installation process, you will first have to uninstall it. From the **Start** menu, select **Programs, Brother, MFL-Pro Suite, Uninstall**, and then follow the instructions on the screen.

Continued...



For Windows® 98/98SE/Me/2000 Professional/XP Users

- 14 When the Brother Software License Agreement window appears, click **Yes**, if you agree to the Software Licence Agreement.

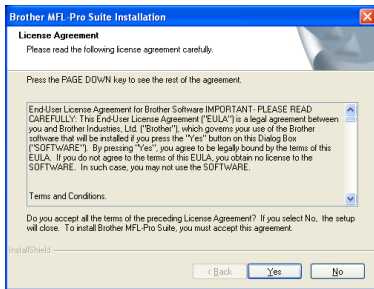

- 15 Select **Standard**, and then click **Next**. The application files will be copied and installed to your computer.

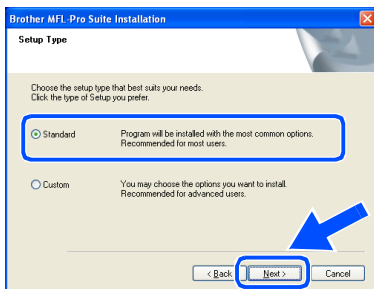

Windows® 98/98SE/Me Users

→ Go to page 19

Windows® 2000 Professional Users

→ Go to page 21

Windows® XP Users

→ Go to page 23

For Windows® 98/98SE/Me Users Only

Make sure that you followed the instructions in 1 to 15 on pages 16 - 18.

- 16 When this screen appears, connect the USB interface cable to your PC, and then connect it to the MFC.
- Turn on the MFC by plugging in the power cord.

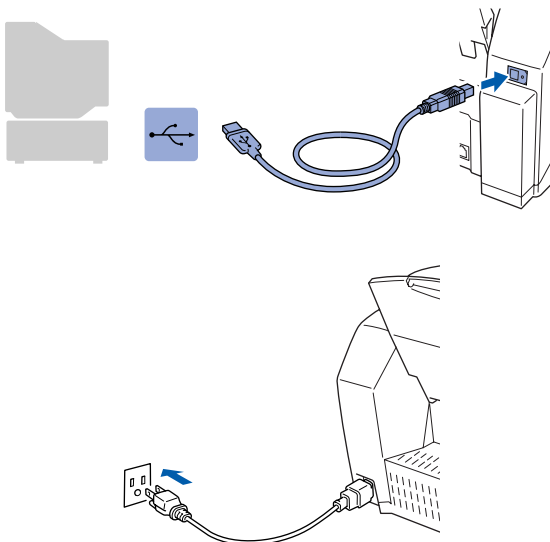
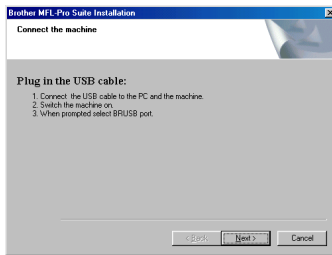

It will take a few seconds for the installation screen to appear.

The installation of the Brother drivers will automatically start. Follow the instructions on the screen.

- 17 Select **BRUSB: USB Printer Port**, and then click **Next**.

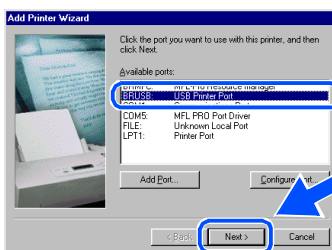

- 18 Accept the default Printer name by selecting **Yes**, and then click **Next**.

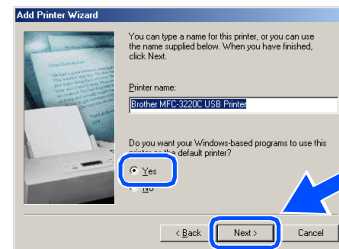

- 19 Select **Yes (recommended)**, and then click **Finish**. A test page will be printed so you can check the print quality.

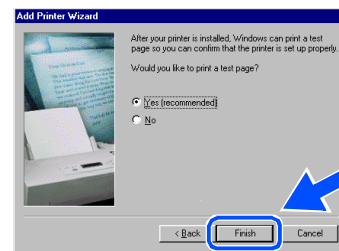

- 20 If the test page is printed correctly, click **Yes**. If you click **No**, follow the prompts on the screen to correct the problem.



If the *ReadMe3220C.wri* file shown in step 21 appears, close the *ReadMe3220C.wri* file and then click **Finish** after printing the page.

Continued...

 For Windows® 98/98SE/Me/2000 Professional/XP Users

- 21 The ReadMe3220C.wri file will be displayed.
Please read this file for troubleshooting information and then close the file to continue installation.

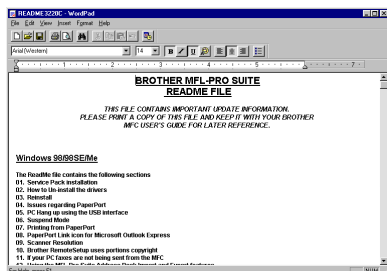

- 22 Click **Finish** to restart your computer.

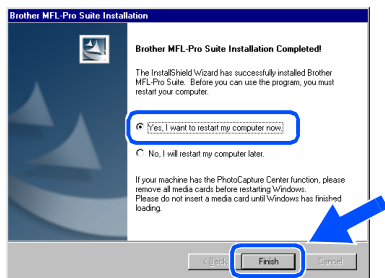

- 23 After the computer restarts, click **Yes** to have the Control Center load each time Windows® is started. The Control Center will appear as an icon in the task tray. If you click **No** the Scan keys on the MFC will be disabled.

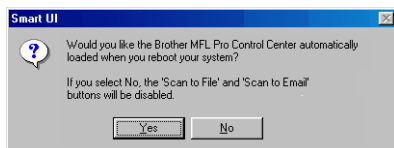

*Even if you select **NO**, later you will be able to launch the Brother Control Center to use the **Scan** key by double clicking the Smart UI icon on the desktop. This loads the Brother Control Center to the task tray. See *AutoLoad the Brother Control Center*, Chapter 4 in the Documentation (Software User's Guide) located on the CD-ROM.*

- OK!** The Brother PC-FAX, Printer and Scanner drivers have been installed and the installation is now complete.

For Windows® 2000 Professional Users Only

Make sure that you followed the instructions in ① to ⑮ on pages 16 - 18.

- ⑯ When this screen appears, connect the USB interface cable to your PC, and then connect it to the MFC.
- Turn on the MFC by plugging in the power cord.

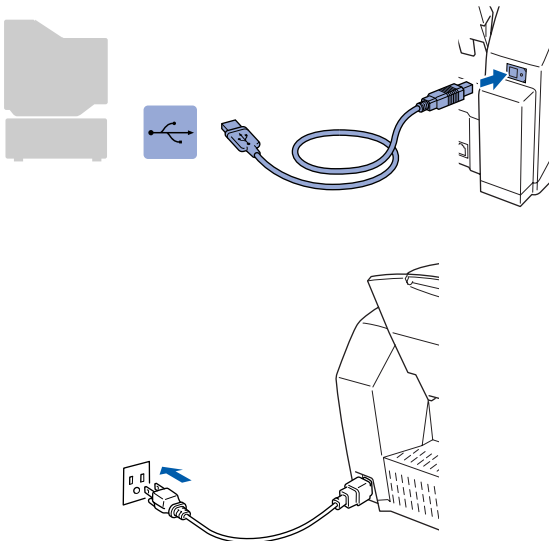
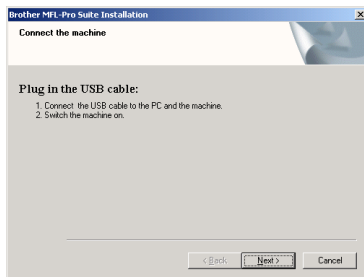

It will take a few seconds for the installation screen to appear.

The installation of the Brother drivers will automatically start. Follow the instructions on the screen.

- ⑰ If the **Digital Signature Not Found** dialog boxes appear, click **Yes** to install the driver.

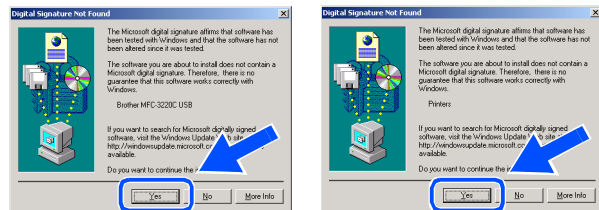

- ⑱ The ReadMe3220C.wri file will be displayed.
- Please read this file for troubleshooting information and then close the file to continue installation.

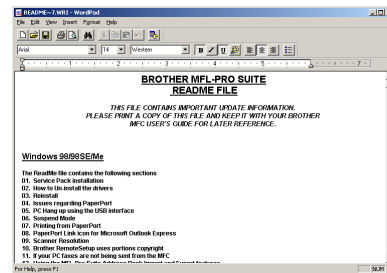

- ⑲ Click **Finish** to restart your computer.

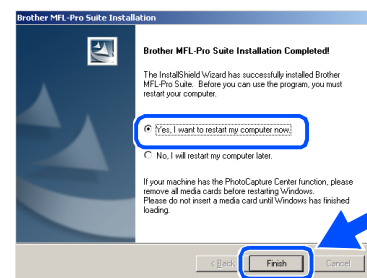

Continued...



For Windows® 98/98SE/Me/2000 Professional/XP Users

- 20 After the computer restarts, click **Yes** to have the Control Center load each time Windows® is started. The Control Center will appear as an icon in the task tray. If you click **No** the Scan keys on the MFC will be disabled.

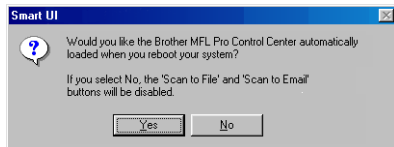

*Even if you select **NO**, later you will be able to launch the Brother Control Center to use the **Scan** key by double clicking the Smart UI icon on the desktop. This loads the Brother Control Center to the task tray. See *AutoLoad the Brother Control Center, Chapter 4 in the Documentation (Software User's Guide) located on the CD-ROM.**

- OK!** The Brother PC-FAX, Printer and Scanner drivers have been installed and the installation is now complete.

For Windows® XP Users Only

Make sure that you followed the instructions in 1 to 15 on pages 16 - 18.

- 16 When this screen appears, connect the USB interface cable to your PC, and then connect it to the MFC.
- Turn on the MFC by plugging in the power cord.

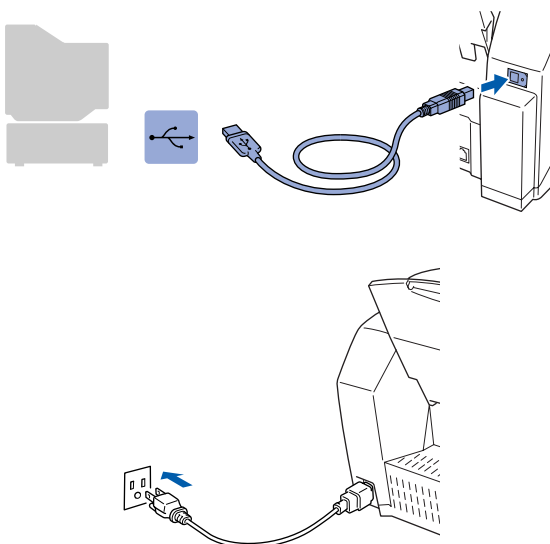
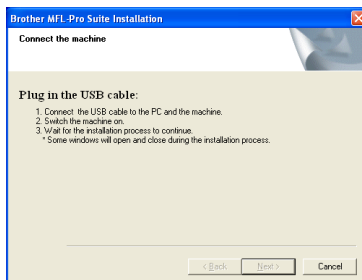

It will take a few seconds for the installation screen to appear.

The installation of the Brother drivers will automatically start. The installation screens appear one after another, please wait for a while.

- 17 The ReadMe3220C.wri file will be displayed.
- Please read this file for troubleshooting information and then close the file to continue installation.

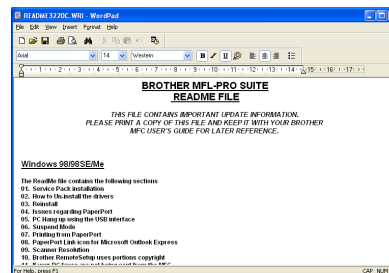

- 18 Click **Finish** to restart your computer.

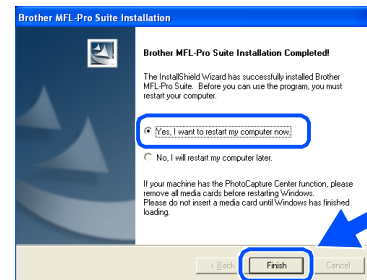

- OK! The Brother PC-FAX, Printer and Scanner drivers have been installed and the installation is now complete.

Step 2

Installing the Driver & Software

For Mac OS® 8.6 to 9.2 Users

Make sure that you have completed the instructions from Step 1 “Setting Up the Machine” on pages 4 - 13.

- 1 Turn off and unplug the MFC from the AC outlet and disconnect it from your Macintosh if you already connected an interface cable.

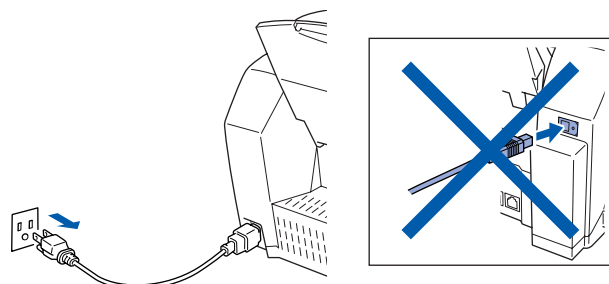

- 2 Turn on your Macintosh®.
- 3 Insert the supplied CD-ROM into your CD-ROM drive.



- 4 Double-click the **Start Here** icon to install the printer, scanner and PC-FAX Send drivers. If the language screen appears, select your language.

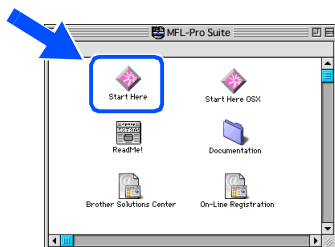

- 5 Click **MFL-Pro Suite** to install.

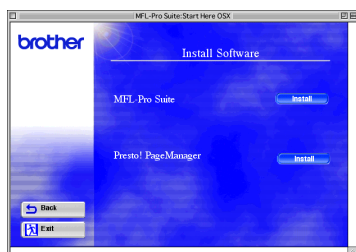

- 6 Follow the on-screen instructions, and restart your Macintosh®.

- 7 Connect the USB interface cable to your Macintosh®, and then connect it to the MFC.

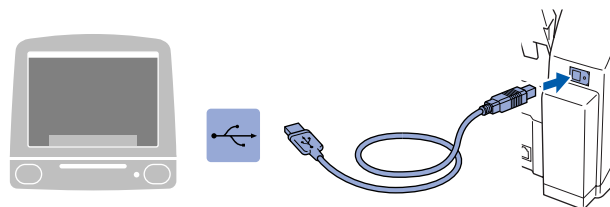

Do not connect the MFC to a USB port on a keyboard or a non powered USB hub.

- 8 Turn on the MFC by plugging in the power cord.

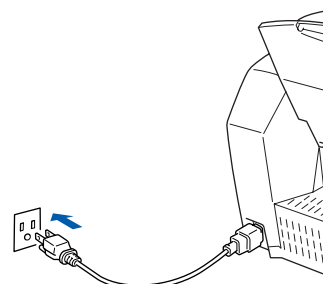

- 9 From the Apple® menu, open the **Chooser**.



- 10 Click the **Brother Ink** icon you installed. On the right side of the **Chooser**, select the printer to which you want to print. Close the **Chooser**.

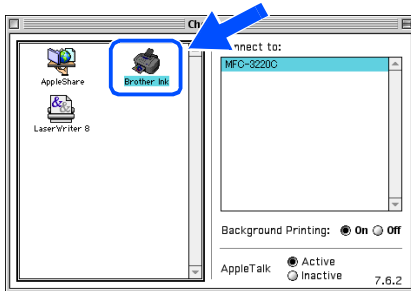

- OK! **The Brother PC-FAX Send, Printer and Scanner drivers have been installed.**

- 11 To install Presto! PageManager®, click the **Presto! PageManager®** icon and follow on the Screen instructions.



You can easily scan, share and organize photos and originals using Presto! PageManager®.

- OK! **Presto! PageManager® has been installed and the installation is now complete.**

Step 2

Installing the Driver & Software

For Mac OS[®] X 10.1/10.2.1 or greater Users

Make sure that you have completed the instructions from Step 1 “Setting Up the Machine” on pages 4 - 13.

- 1 Turn off and unplug the MFC from the AC outlet and disconnect it from your Macintosh if you already connected an interface cable.

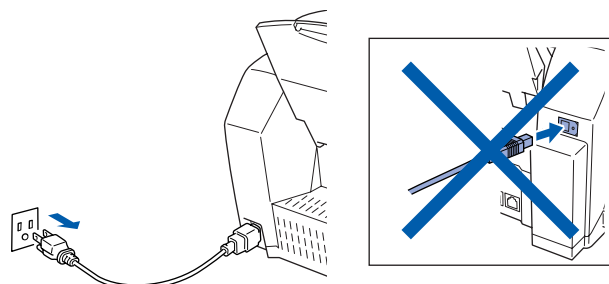

- 7 Connect the USB interface cable to your Macintosh[®], and then connect it to the MFC.

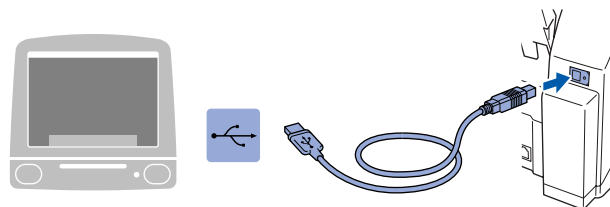

Do not connect the MFC to a USB port on a keyboard or a non powered USB hub.

- 2 Turn on your Macintosh[®].
- 3 Insert the supplied CD-ROM into your CD-ROM drive.



- 4 Double-click the **Start Here OS X** icon to install the printer driver, Scanner driver, Brother PC-FAX Send and Remote Setup program. If the language screen appears, select your language.

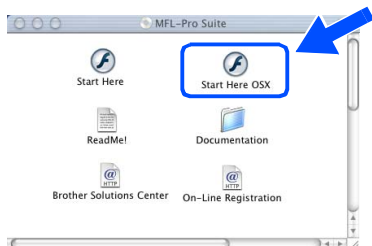

- 5 Click **MFL-Pro Suite** to install.

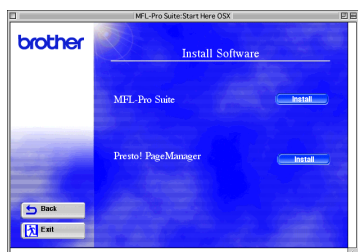

- 6 Follow the on-screen instructions, and restart your Macintosh[®].

- 8 Turn on the MFC by plugging in the power cord.

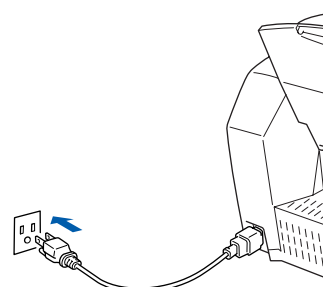

- 9 Select **Applications** from the **Go** menu.

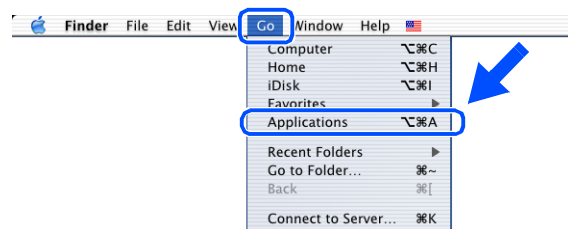

- 10 Open the **Utilities** folder.



11 Open the **Print Center** icon.

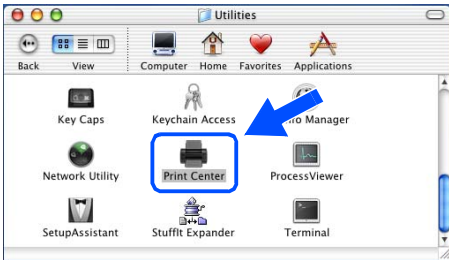

12 Click **Add Printer...**

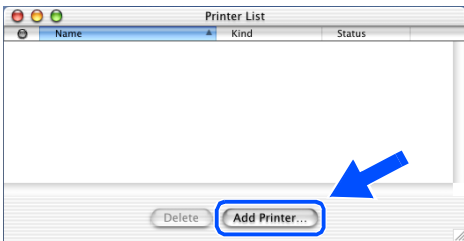

13 Select **USB**.

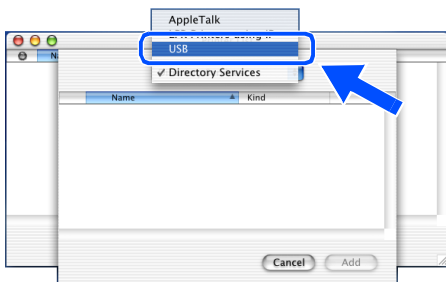

14 Select **MFC-3220C**, and then click **Add**.

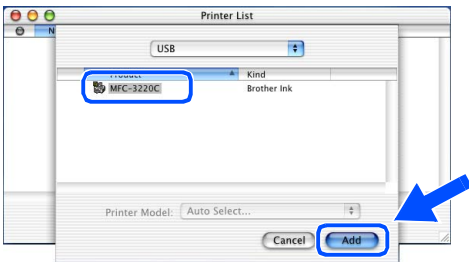

15 Select **Quit Print Center** from the **Print Center** menu.

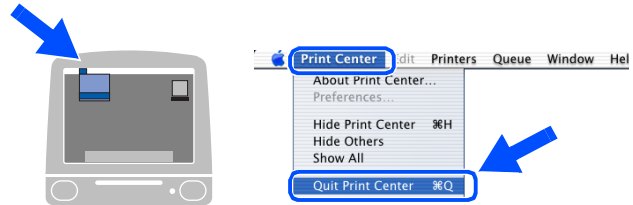

OK! The **Brother Printer driver, Scanner driver, Brother PC-FAX Send and Remote Setup Program** have been installed and the installation is now complete.

16 To install Presto! PageManager®, click the **Presto! PageManager®** icon and follow on the Screen instructions.

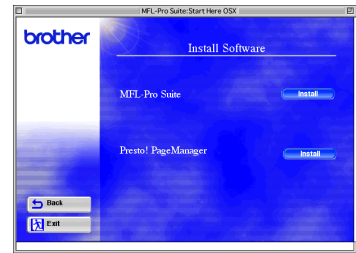

You can easily scan, share and organize photos and originals using Presto! PageManager®.

OK! **Presto! PageManager®** has been installed and the installation is now complete.

Replacement Consumables

Ink

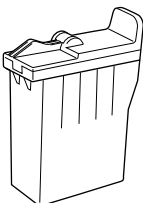
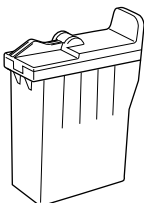
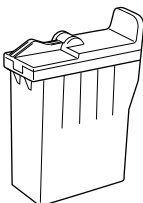
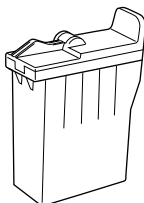
Black	Magenta	Yellow	Cyan
LC31BK	LC31M	LC31Y	LC31C
			

Trademarks

The Brother logo is a registered trademark of Brother Industries, Ltd.

Brother is a registered trademark of Brother Industries, Ltd.

Multi-Function Link is a registered trademark of Brother International Corporation.

© Copyright 2003 Brother Industries, Ltd. All rights reserved.

Windows, Microsoft and MS-DOS are registered trademarks of Microsoft in the U.S. and other countries.

Macintosh is a registered trademark of Apple Computer, Inc.

PaperPort and TextBridge are registered trademarks of ScanSoft, Inc.

Presto! PageManager is a registered trademark of NewSoft Technology Corporation.

Each company whose software title is mentioned in this manual has a Software License Agreement specific to its proprietary programs.

All other brand and product names mentioned in this manual are registered trademarks of their respective companies.

Compilation and Publication

Under the supervision of Brother Industries Ltd., this manual has been compiled and published, covering the latest product descriptions and specifications.

The contents of this manual and the specifications of this product are subject to change without notice.

Brother reserves the right to make changes without notice in the specifications and materials contained herein and shall not be responsible for any damages (including consequential) caused by reliance on the materials presented, including but not limited to typographical and other errors relating to the publication.

This product is designed for use in a Professional Environment.

brother[®]

USA
Version A