

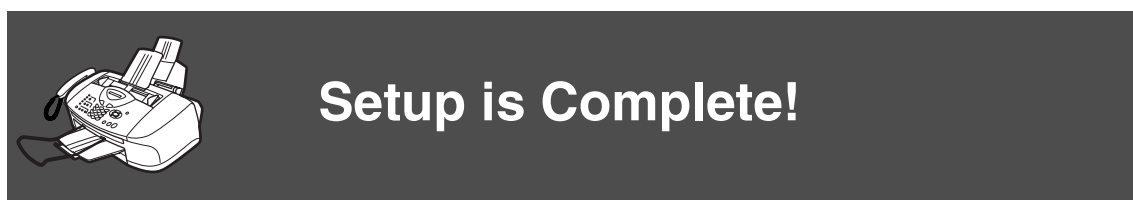









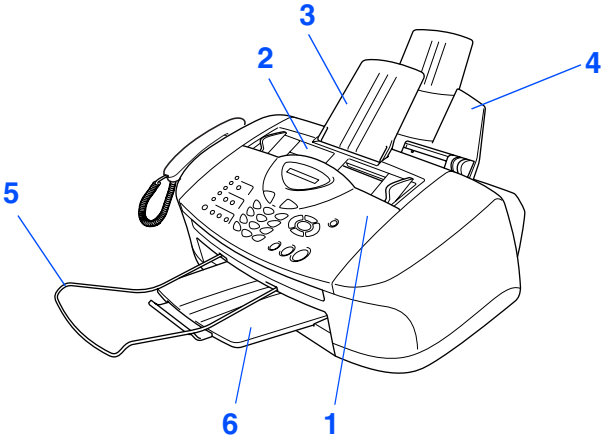
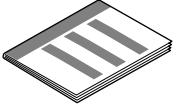
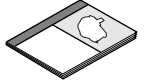

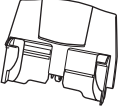
Before you can use the machine, you must set up the hardware.
To help you get started in setting up the machine, please read this “Setup Guide” and follow the simple instructions.

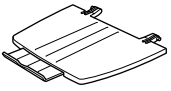





To find the best solution for your problem or question, access the Brother Solutions Centre, <http://solutions.brother.com>
Keep this “Quick Setup Guide” and User’s Guide in a convenient place for quick and easy reference at all times.

Getting Started

Carton Components

<p>FAX</p>  <p>1. Control Panel 2. Top Cover</p>		 <p>Quick Setup Guide</p>
		 <p>User's Guide</p>
		 <p>One Touch Labels</p>
<p>3</p>  <p>ADF Document Support</p>	<p>4</p>  <p>Paper Tray</p>	 <p>Power Cord</p>
<p>5</p>  <p>ADF Document Output Support</p>	<p>6</p>  <p>Output Paper Support</p>	 <p>Telephone Line Cord</p>
 <p>Telephone Handset</p>	 <p>Handset Curled Cord</p>	 <p>Telephone Line Cord Adapter (For Australia only)</p>
 <p>Black (LC800BK)</p>	 <p>Magenta (LC800M)</p>	 <p>Yellow (LC800Y)</p>
		 <p>Cyan (LC800C)</p>
<p>Ink Cartridges</p>		

Carton components may differ from one country to another.
Save all packing materials and the carton.

 <p>Warning</p> <p>Indicates warnings that must be observed to prevent possible personal injury.</p>	 <p>Indicates cautions that must be observed to use the machine properly or to prevent damage to the machine.</p>	 <p>Hint</p> <p>Indicates notes and useful tips to remember when using the machine.</p>	 <p>User's Guide</p> <p>Indicates reference to the User's Guide.</p>
--	--	---	--

Control Panel

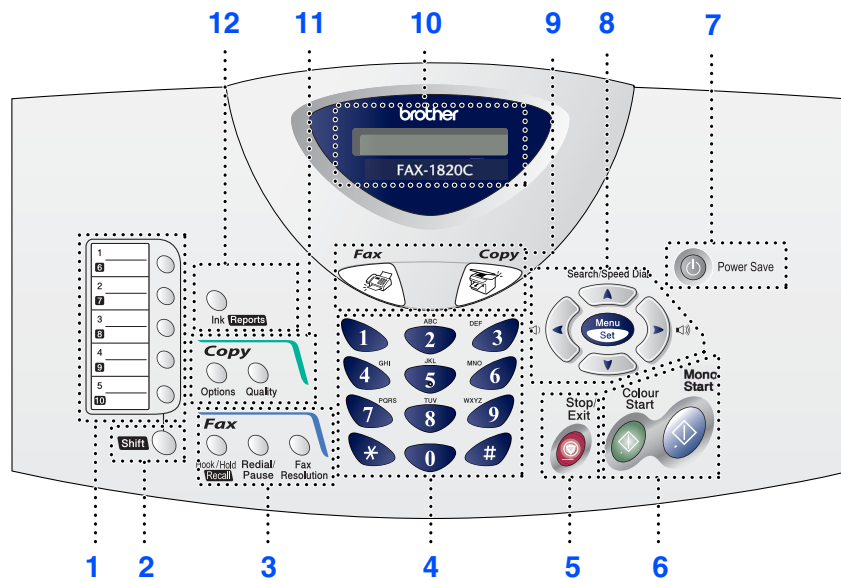

1. One Touch keys	5. Stop/Exit	9. Mode keys
2. Shift	6. Start keys	10. Liquid Crystal Display (LCD)
3. Fax and telephone keys	7. Power Save key	11. Copy keys (Temporary Settings)
4. Dial Pad	8. Navigation keys	12. Ink/Reports key



For the details of the control panel, see "Control panel overview" in Chapter 1 of the User's Guide.

Setting Up the Machine

1. Removing the Protective Parts	4
2. Install Handset.....	4
3. Attaching the Paper Tray and Supports	5
4. Loading Paper	5
5. Install Phone Line and Power Cord	6
6. Set Your Country (For Australia / New Zealand Customer only).....	7
7. Installing the Ink Cartridges.....	7
8. Colour Block Quality and Alignment Check.....	9
9. Setting the Date and Time	11
10. Setting Your Station ID	12
11. Selecting a Receive Mode	13
12. Using the FAX as a Printer or for PC-FAX Send	13

Setting Up the Machine

1 Removing the Protective Parts

- 1 Remove the protective tape and paper in the ADF.
- 2 Open the control panel cover by pulling it toward you (①), and then lift the top cover toward the back (②).

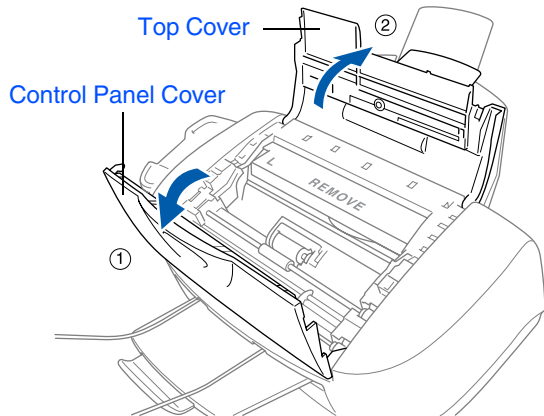

- 3 Pull the protective yellow bar out of the machine.

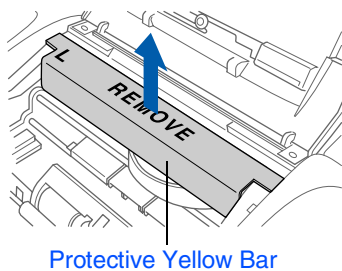

Do not throw away the protective yellow bar. You will need it in the future to transport the machine.

- 4 Close the top cover, and then close the control panel cover.

2 Install Handset

- 1 Connect the curled handset cord to the machine and the other end to the handset.

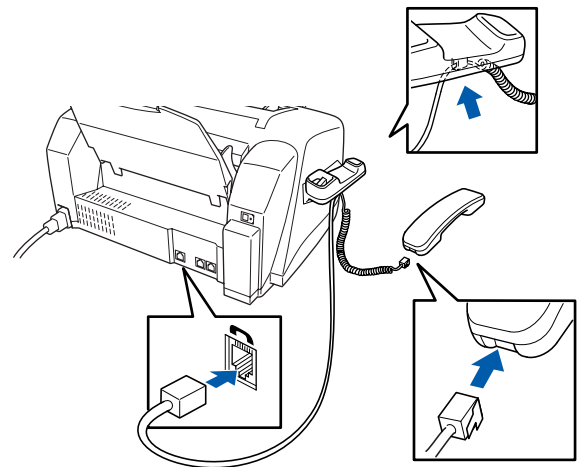

3

Attaching the Paper Tray and Supports

- 1 Insert the paper tray from above into the back of the machine.

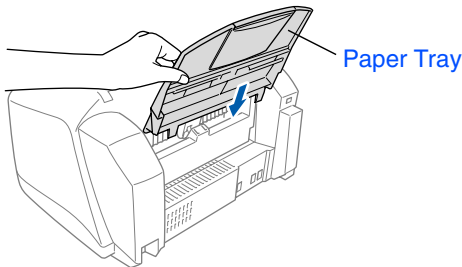

- 2 Attach the ADF document support.

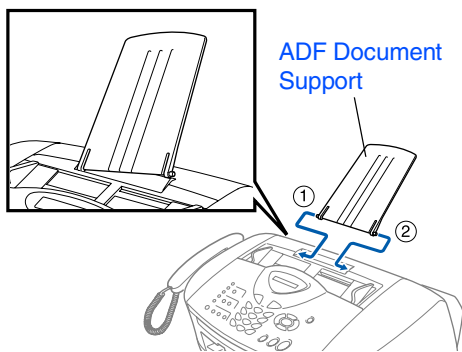

- 3 Attach the output paper support to the paper output slot, and then pull out the extension.

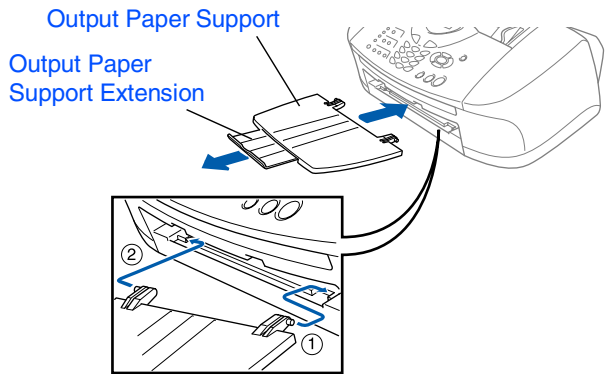

- 4 Attach the ADF document output support.

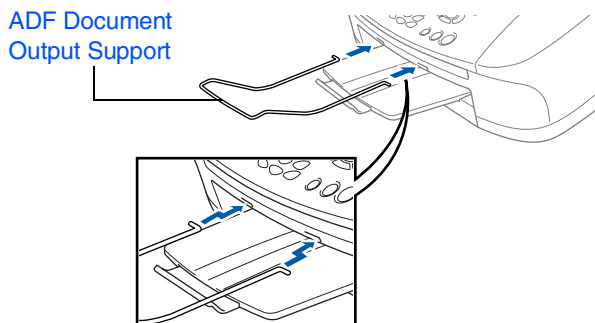

4

Loading Paper



You can load up to 100 sheets of 80 gsm paper.
For more details, see "Paper Capacity of the Paper Tray" in Chapter 2 of the User's Guide.

- 1 Fan the stack of paper well to avoid paper jams and misfeeds.

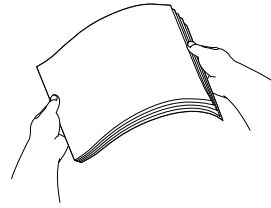

- 2 Unfold the paper support and then press and slide the paper guide to fit the paper width.

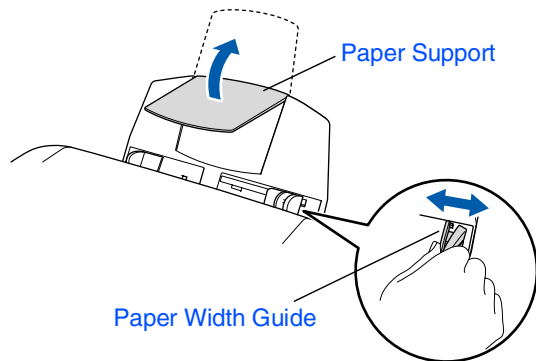

- 3 Gently insert the paper. Make sure the print side is towards you and the paper is below the maximum paper mark.

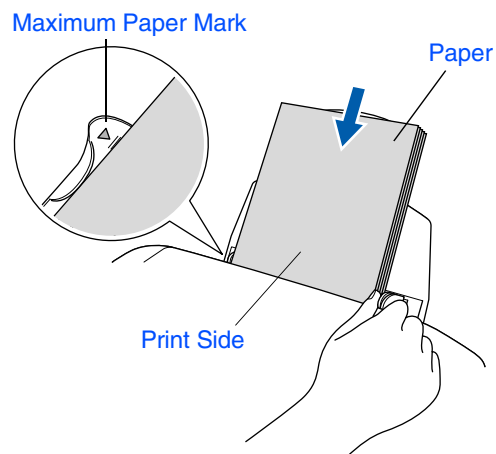

Setting Up the Machine

5 Install Phone Line and Power Cord

- 1 Connect the power cord.

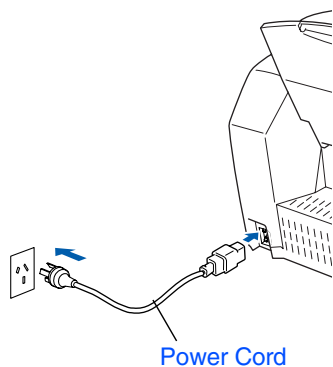

- 2 Connect the telephone line cord. Connect one end of the telephone line cord to the socket on the machine marked **LINE** and the other end to a modular wall socket.

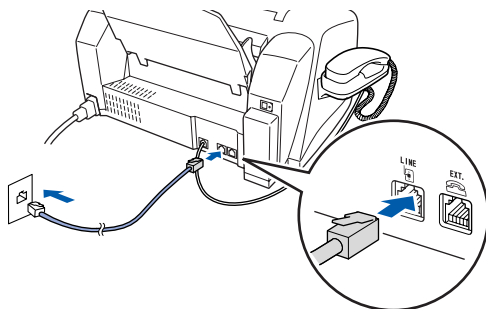

Warning

- The machine must be grounded using a 3-prong plug.
- Since the machine is grounded through the power outlet, you can protect yourself from potentially hazardous electrical conditions on the telephone network by keeping the power to your machine on when you connect it to a telephone line. Similarly, you can protect yourself when you want to move your machine by disconnecting the telephone line first and then the power cord.



If you are sharing one phone line with an external telephone, connect it as shown below.

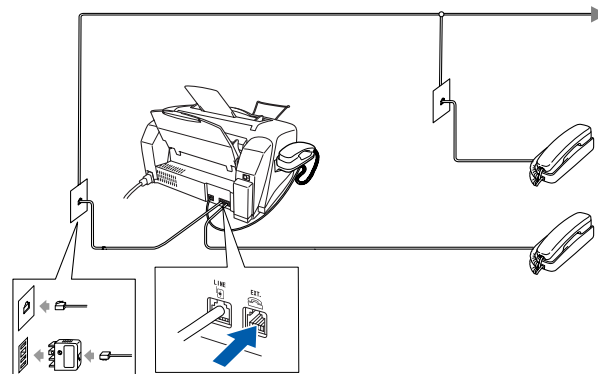

(Example for Australia)



If you are sharing one phone line with an external telephone answering machine, connect it as shown below.



Please set the Receive Mode to "External TAD" if you have an external answering machine. For more details, see "Connecting the machine" in Chapter 1 of the User's Guide.

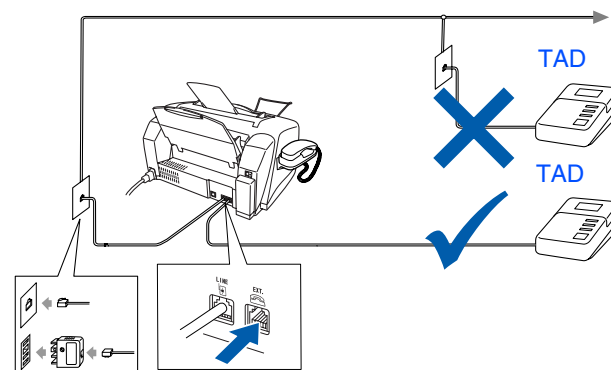

(Example for Australia)

6

Set Your Country (For Australia / New Zealand Customer only)

Warning

You must set your country so that the machine works correctly.

- 1 Check that the power is turned on (by plugging in the power cord)
The LCD shows;



- 2 Press **Menu/Set**.
The LCD shows;



- 3 Press or to select the country (AUSTRALIA or NEWZEALAND).
- 4 Press **Menu/Set** when the LCD shows your country.
- 5 The LCD prompts you to make sure of the country again



- 6 Press to go to step **7**.
---OR---
Press to go back to step **1** to select the country again.

- 7 After the LCD shows **Accepted** for two seconds, it shows; **Please Wait**
After about 30 seconds, the LCD shows;

Check Cartridge

- 8 Go to step 7 "Installing the Ink Cartridges".

7

Installing the Ink Cartridges

Warning

If ink gets in your eyes irrigate them with water immediately, and if irritation occurs consult a doctor.

- 1 Make sure that the power is turned on.
The LCD shows;

Check Cartridge

- 2 Open the control panel cover by pulling it toward you (1), then lift the top cover toward the back (2).
The print heads will move to the ink replacement position.

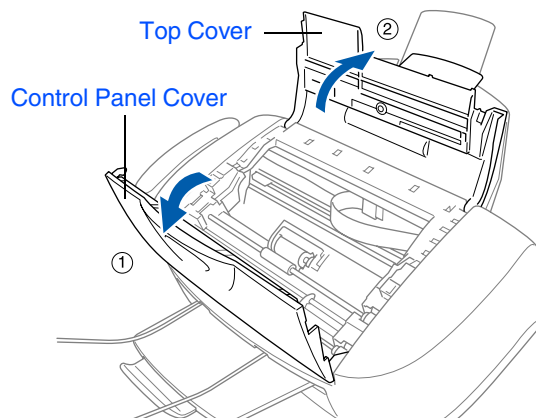

- 3 Push the four coloured ink cartridge covers one at a time so they pop up.

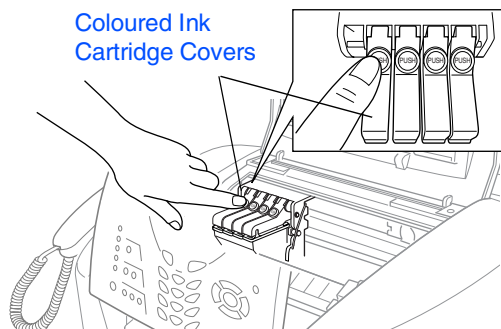

Continued...

Setting Up the Machine

- 4 Remove the white shipping cover by pulling it towards you.

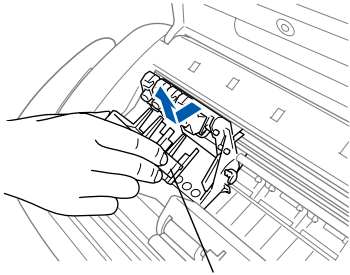

White Shipping Cover



- The bottom of the white shipping cover is wet with ink that will cause stains, so wipe it clean before you place it down.
- Do not throw away the white shipping cover. You will need it when you transport the machine.

- 5 Take out the black ink cartridge.

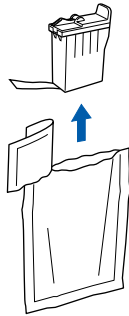

- 6 Carefully remove the sealing tape from the ink cartridge.

To prevent spilling ink and staining your hands and clothing, peel the sealing tape gently and slowly.

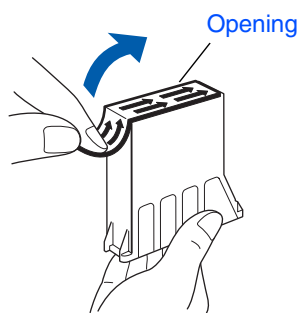

- Do not touch the ink opening on the cartridge or removed tape.

- 7 Gently insert the black ink cartridge in the black ink position.

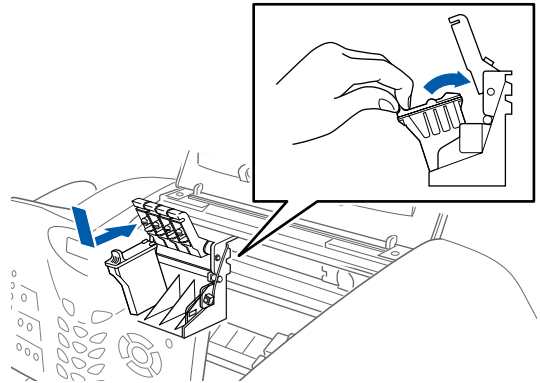

- 8 Press the cover down until it clicks.

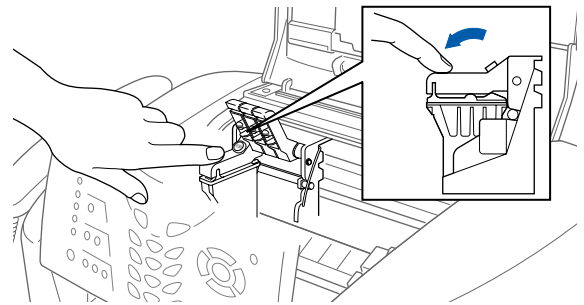

- 9 Repeat Steps 5 to 8 to install each colour ink cartridge. Match the colours of the ink to the cartridge covers.

- 10 Close the top cover and control panel cover. The machine will enter a head cleaning cycle for approximately four minutes.

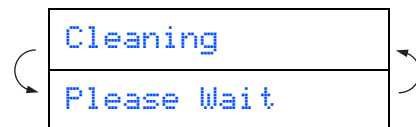



- **DO NOT** remove ink cartridges if you do not need to replace them. If you do so, it may reduce the ink quantity and the machine will not know the quantity of ink left in the cartridge.
- **DO NOT** shake the ink cartridges. If ink stains your body or clothing, wash with soap or detergent immediately.
- **Brother strongly recommends** that you do not refill the ink cartridges provided with your machine. We also strongly recommend that you continue to use only **Genuine Brother Brand** replacement ink cartridges. Using or attempting to use potentially incompatible inks and/or cartridges in your machine may cause damage to the machine itself and/or it may result in unsatisfactory print quality. Our warranty coverage does not apply to any problem that was caused by the use of unauthorized third party ink and/or cartridges. To protect your investment and guarantee your print quality please continue to replace consumed ink cartridges with only **Genuine Brother Branded Supplies**.

8

Colour Block Quality and Alignment Check

- 1 After the cleaning cycle is finished, the LCD shows;

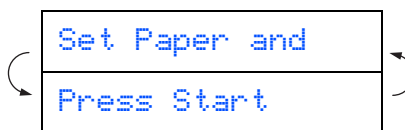

- 2 Make sure the paper is loaded in the paper tray.
Press **Colour Start**.

- 3 The machine starts printing the PRINT QUALITY CHECK SHEET (only during initial ink cartridge installation).

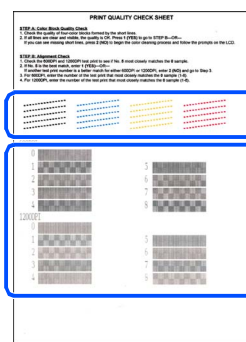

Check in **Step A**

Check in **Step B**

Continued...



- If you mix the colours by installing an ink cartridge in the wrong position, you must clean the print head by running several cleaning cycles after correcting the cartridge installation. (See "Cleaning the print head" on page 12-11 of the User's Guide.)
- Once you open an ink cartridge, install it in the machine and use it up within six months of installation. Use unopened ink cartridges by the expiration date written on the cartridge package.
- If Ink Empty shows on the LCD after you install the ink cartridges, check to make sure the ink cartridges are installed correctly.

Setting Up the Machine

Step A: Colour Block Quality Check

- 1 The LCD shows:

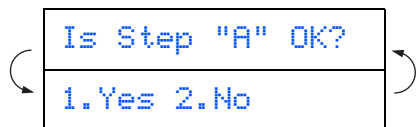

Check the quality of the four colour blocks formed by the short lines printed on the sheet.
(BLACK/CYAN/YELLOW/MAGENTA)

- 2 If all lines are clear and visible, press 1 on the dial pad to go to **STEP B: Alignment Check**.
---OR---

If you can see missing short lines, press 2 on the dial pad and go to 3.

OK

Poor



- 3 The LCD asks you if the print quality is OK for each colour. Press 1 or 2 on the dial pad.

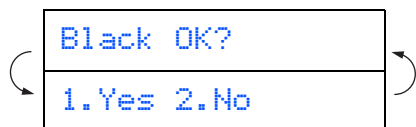

When you have finished selecting 1 (Yes) or 2 (No) for each colour, the LCD shows:

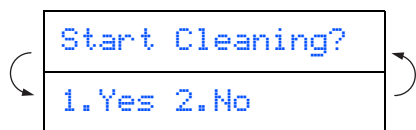

Press 1 (Yes), and then machine starts cleaning the colours.

After cleaning is finished, press **Colour Start**. The machine starts printing the PRINT QUALITY CHECK SHEET again and goes back to the first step of STEP A.

Step B: Alignment Check

- 1 The LCD shows:

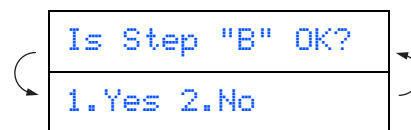

Check the 600 dpi and 1200 dpi test print to see if **No.5** most closely matches the OK sample (**No.0**). Press 1 if **No.5** matches it.

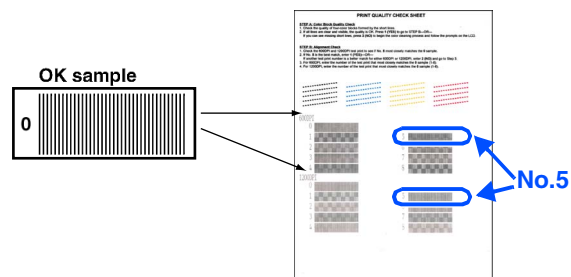

600 DPI

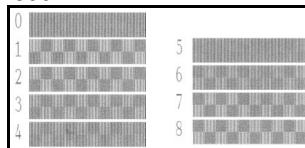

1200 DPI

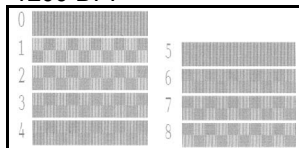

If another test print number is a better match for either 600 dpi or 1200 dpi, press 2 to select No and go to 2.

- 2 For 600 dpi, select the number from 1 to 8 that most closely matches the **No.0** sample and enter it using the dial pad.



- 3 For 1200 dpi, enter the number from 1 to 8 that most closely matches the **No.0** sample.



The Quality check is now complete.

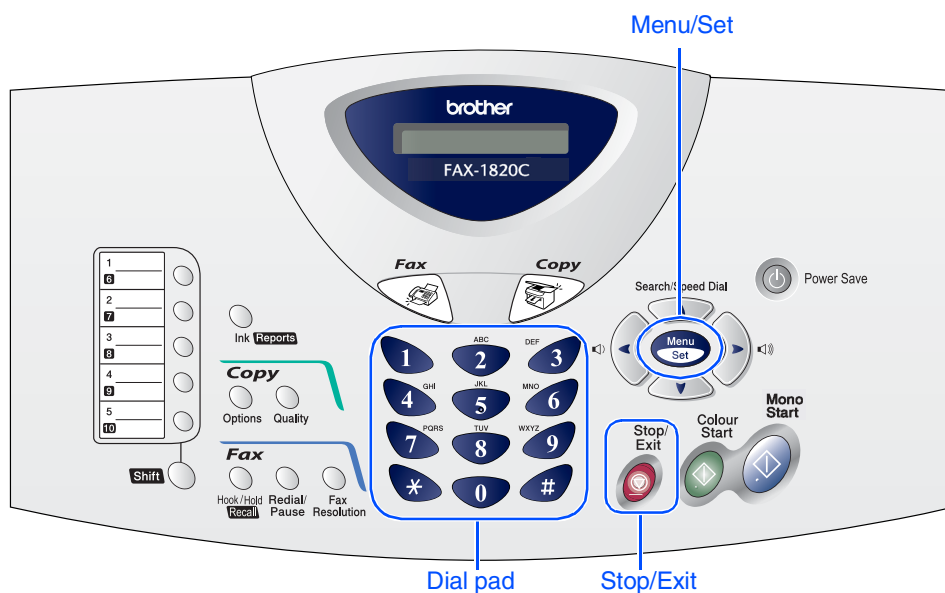

9 Setting the Date and Time

The machine displays the date and time, and prints it on every fax you send.

- 1 Press **Menu/Set**.
- 2 Press **0**.
- 3 Press **2**.
- 4 Enter the last two digits of the year on the dial pad, and then press **Menu/Set**.

 (e.g. Enter **0, 4** for 2004.)
- 5 Enter the two digits for the month on the dial pad, and then press **Menu/Set**.

 (e.g. Enter **0, 3** for March.)

- 6 Enter the two digits for the day on the dial pad, and then press **Menu/Set**.

(e.g. Enter **0, 1**.)

- 7 Enter the time in 24-hour format on the dial pad, and then press **Menu/Set**.

(e.g. Enter **1, 5, 2, 5** for 3:25 P.M.)

- 8 Press **Stop/Exit**.



*If you want to repeat from step 1, press **Stop/Exit**.*

Setting Up the Machine

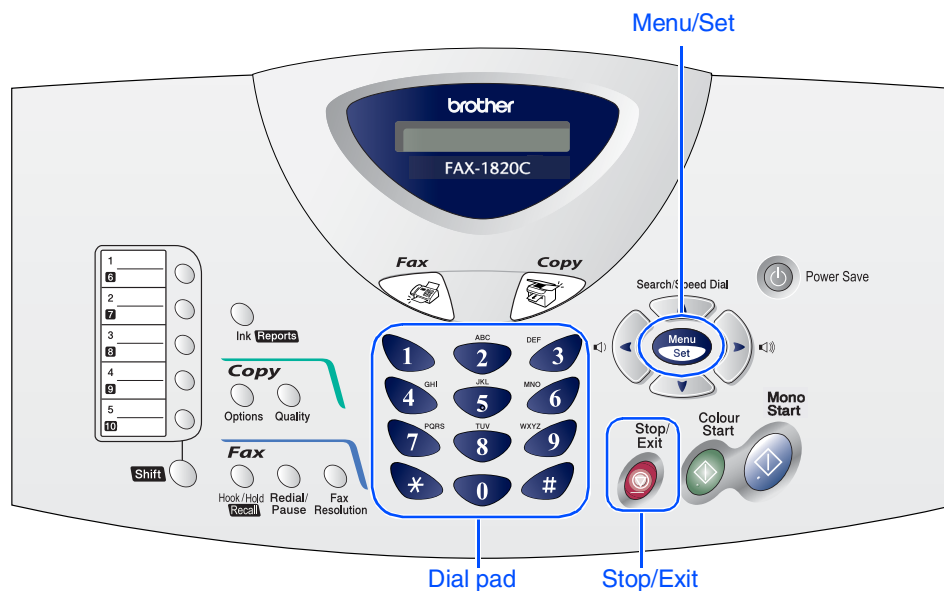

10 Setting Your Station ID

You should store your name and fax number to be printed on all fax pages that you send.

- 1 Press **Menu/Set**.
- 2 Press **0**.
- 3 Press **3**.
- 4 Enter your fax number (up to 20 digits) on the dial pad, and then press **Menu/Set**.

Fax: _

- 5 Use the dial pad to enter your name (up to 20 characters), and then press **Menu/Set**.

Name: _



- Refer to the following chart for entering your name.
- If you need to enter a character that is on the same key as the previous character, press  to move the cursor to the right.

Press key	One time	Two times	Three times	Four times
2	A	B	C	2
3	D	E	F	3
4	G	H	I	4
5	J	K	L	5
6	M	N	O	6
7	P	Q	R	S
8	T	U	V	8
9	W	X	Y	Z



For more details, see "Setting the Station ID" in Chapter 4 of the User's Guide.

- 6 Press **Stop/Exit**.



If you want to repeat from step 1, press **Stop/Exit**.

11 Selecting a Receive Mode

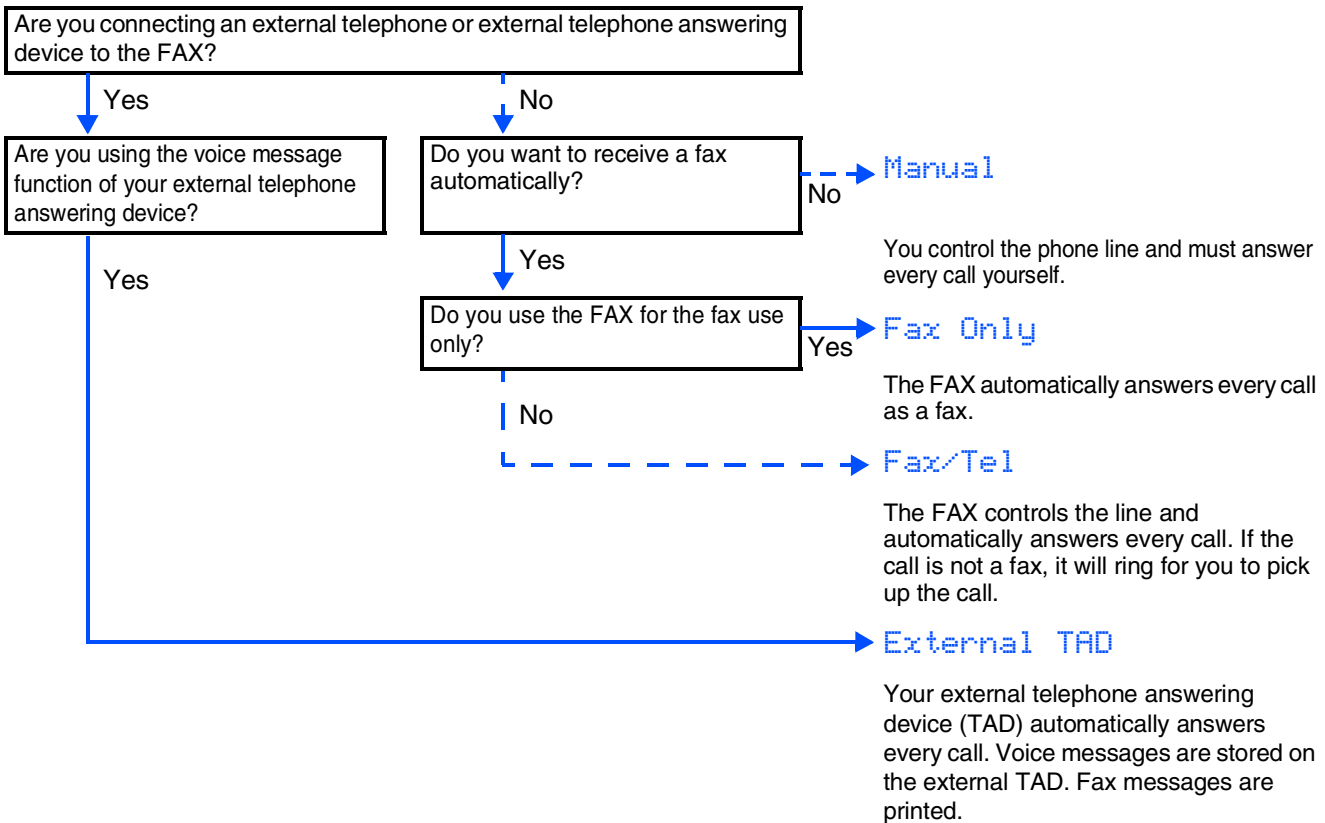

 For more details, see "Setup Receive" in Chapter 5 of the User's Guide.

There are four possible receive modes: **Fax Only**, **Fax/Tel**, **Manual** and **External TAD**.

- 1 Press **Menu/Set**.
- 2 Press **0**.

- 3 Press **1**.
- 4 Press **A** or **V** to select the mode.
- 5 Press **Menu/Set**.
- 6 Press **Stop/Exit**.

12 Using the FAX as a Printer or for PC-FAX Send

You can download the Brother Printer Driver and PC-FAX Send driver from the Brother Solutions Centre for use with your machine. Visit us at:

<http://solutions.brother.com>



- Please download the Printer Driver first before connecting the machine to your computer with the USB cable.
- You must use the appropriate USB cable. If you don't have it, please purchase a USB cable that is no longer than 2 meters.

At your side.
brother®