

Before you can use the MFC, you must set up the hardware and install the driver. Please read this "Quick Setup Guide" for proper set up and installation instructions.

Step 1



Setting Up the Machine

Step 2



Installing the Driver & Software

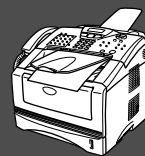

Setup is Complete!

For the latest drivers and to find the best solution for your problem or question, access the Brother Solutions Center directly from the driver or go to <http://solutions.brother.com>
Keep this "Quick Setup Guide", User's Guide and supplied CD-ROM in a convenient place for quick and easy reference at all times.

For Administrators

Macintosh® Network

Macintosh® USB

Windows® Network





Windows NT® 4.0 Parallel

Windows® Parallel







Windows® USB

Setting Up the Machine

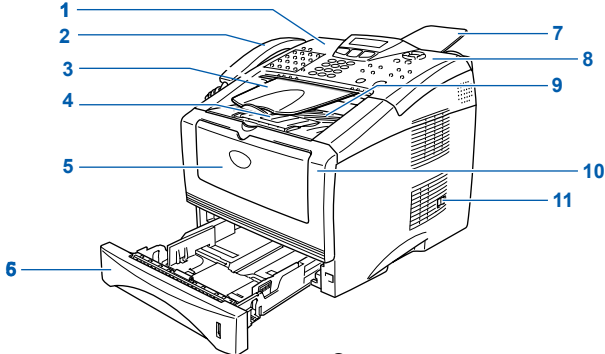
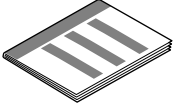
Installing the Driver & Software

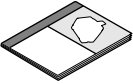
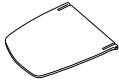
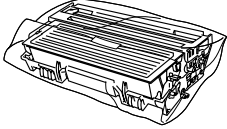
 Warning		 Hint	 User's Guide
Indicates warnings that must be observed to prevent possible personal injury.	Indicates cautions that must be observed to use the MFC properly or to prevent damage to the MFC.	Indicates notes and useful tips to remember when using the MFC.	Indicates reference to the User's Guide.

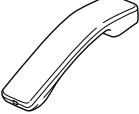
Carton Components

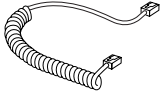
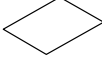
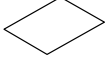
<p>MFC</p>  <ol style="list-style-type: none"> 1. Control Panel 2. Telephone Handset 3. ADF Document Output Support 4. Face-down Output Tray Support Flap with Extension (Support Flap) 5. Manual Feed Tray 6. Paper Tray 7. ADF Document Support 8. Control Panel Cover 9. Face-down Output Tray 10. Front Cover 11. Power Switch 	 <p>Quick Setup Guide</p>
	 <p>CD-ROMs For Windows® For Macintosh®</p>
	 <p>User's Guide</p>
 <p>ADF Document Support</p>	 <p>Drum Unit Assembly (including Toner Cartridge)</p>
 <p>ADF Document Output Support</p>	 <p>Telephone Handset</p>
 <p>Telephone Line Cord</p>	 <p>Handset Curled Cord</p>
 <p>Test Sheet (USA only)</p>	 <p>Accessory Order Form (USA/Canada only)</p>

Carton components may differ from one country to another. Save all packing materials and the carton.



- The interface cable is not a standard accessory. Please purchase the appropriate interface cable for the interface you intend to use (Parallel or USB).
- For Parallel use a bi-directional shield interface cable that is IEEE 1284-compliant, and not longer than 6 feet (2 meters).
- For USB: use a Hi-Speed USB 2.0 interface cable that is not longer than 6 feet (2 meters).
- Please make sure that you use a Hi-Speed USB 2.0 certified cable if your computer uses a Hi-Speed USB 2.0 interface.
- Even if your computer has a USB 1.1 interface, you can connect the MFC.



- When you move the MFC, grasp the side handholds that are at the bottom shown in the illustration.

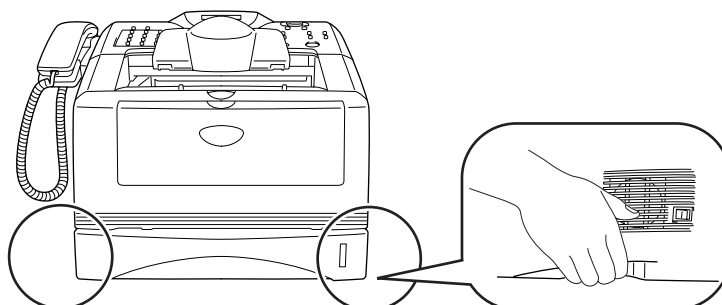

Control Panel

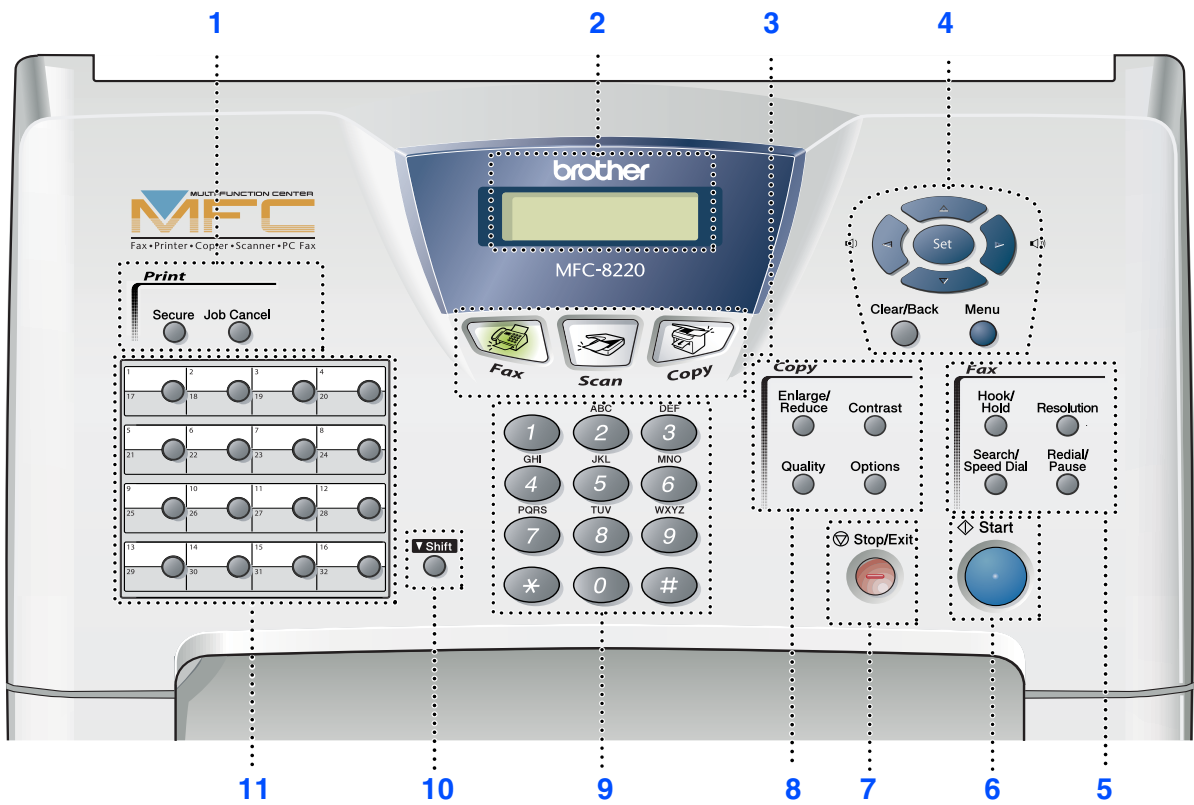

1. Print keys	5. Fax and telephone keys	9. Dial Pad
2. Liquid Crystal Display (LCD)	6. Start	10. Shift
3. Mode keys	7. Stop/Exit	11. One-Touch keys
4. Navigation keys	8. Copy keys (Temporary Settings)	



For the details of the control panel, see "Control panel overview" in Chapter 1 of the User's Guide.

Table of Contents

Step 1

Setting Up the Machine

1. Attaching the Supports	4
2. Installing the Handset.....	4
3. Installing the Drum Unit Assembly.....	5
4. Load Paper in the Paper Tray	6
5. Installing the Power Cord and Phone Line	7
6. Setting the Date and Time	8
7. Setting Your Station ID	9
8. Selecting a Receive Mode	10
9. Selecting Your Language (Canada Only).....	11
10. Sending in the Product Registration and Test Sheet (USA Only)	11

Step 2

Installing the Driver & Software

Windows®

Supplied CD-ROM (MFL-Pro Suite).....	12
For USB Interface Cable Users	
(For Windows® 98/98SE/Me/2000 Professional/XP)	14
■ For Windows® 98/98SE/Me Users Only	17
■ For Windows® 2000 Professional Users Only	19
■ For Windows® XP Users Only	23
For Parallel Interface Cable Users	
(For Windows® 95/98/98SE/Me/2000 Professional/XP)	26
■ For Windows® 95/98/98SE/Me Users Only	29
■ For Windows® 2000 Professional Users Only	31
■ For Windows® XP Users Only	35
For Windows NT® Workstation Version 4.0 Users	38
For Optional NC-9100h Network Interface Users	
(For Windows® 95/98/98SE/Me/NT/2000 Professional/XP)	41

Macintosh®

For USB Interface Cable Users	46
■ For Mac OS® 8.6 to 9.2	46
■ For Mac OS® X 10.1/10.2.1 - 10.3 or greater	48
For Optional NC-9100h Network Interface Users	50
■ For Mac OS® 8.6 to 9.2	50
■ For Mac OS® X 10.1/10.2.1 - 10.3 or greater	52

■ For Administrators

Network User's Guide Chapter Map (NC-9100h)	54
Installing the BRAdmin Professional Configuration Utility (Windows® Users Only)	55
Web BRAdmin.....	55
Setting your IP Address, Subnet Mask and Gateway using BRAdmin Professional (Windows® Users Only).....	56
Options	57
Replacement Consumables.....	57

Step 1

Setting Up the Machine

1 Attaching the Supports

 **DO NOT connect the interface cable.** Connecting the interface cable is done when installing the driver.

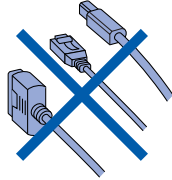

- 1 Attach the ADF document support.

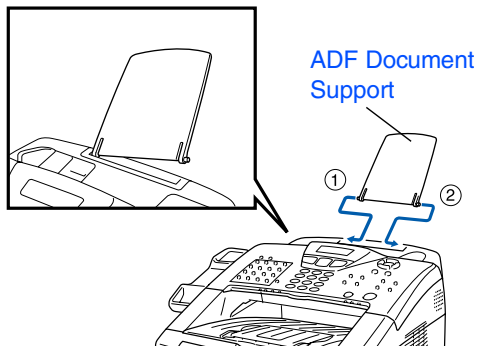

- 2 Open the control panel cover by lifting it toward the back.

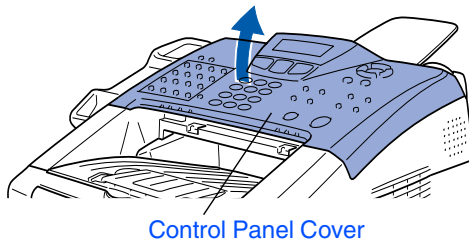

- 3 Attach the ADF Support.

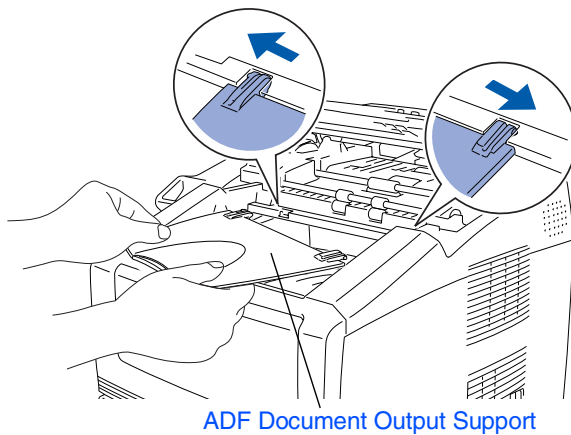

- 4 Close the control panel cover.

2 Installing the Handset

- 1 Connect the curled handset cord to the MFC and the other end to the handset.

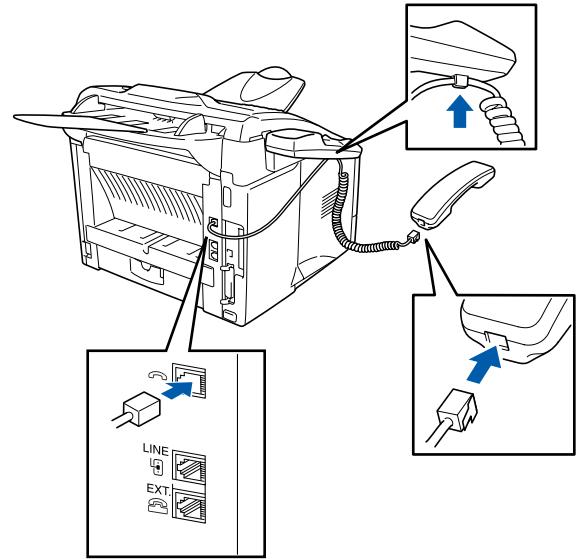

3

Installing the Drum Unit Assembly

- 1 Open the front cover by pressing the front cover release button.

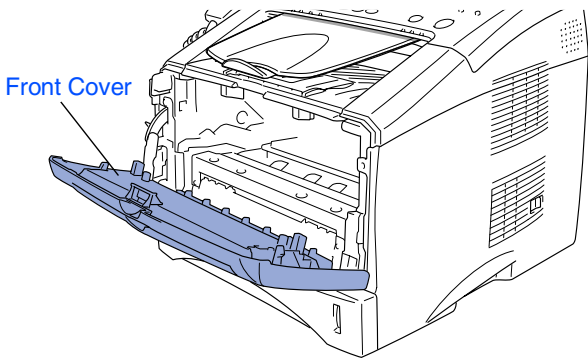
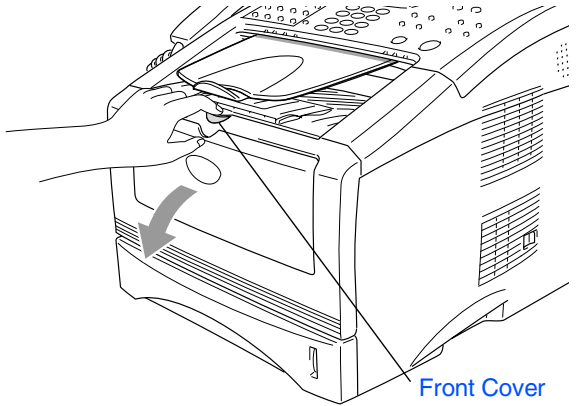

- 2 Unpack the drum unit assembly. Remove the protective part.

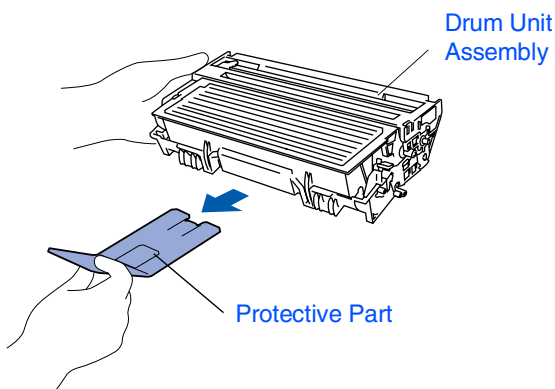

- 3 Rock it from side to side several times to distribute the toner evenly inside the assembly.

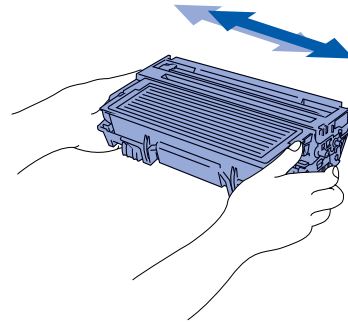

- 4 Push the drum unit assembly into the machine (until it snaps into place).

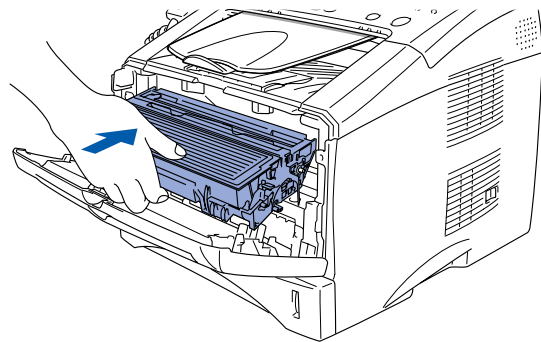

- 5 Close the front cover of the machine.

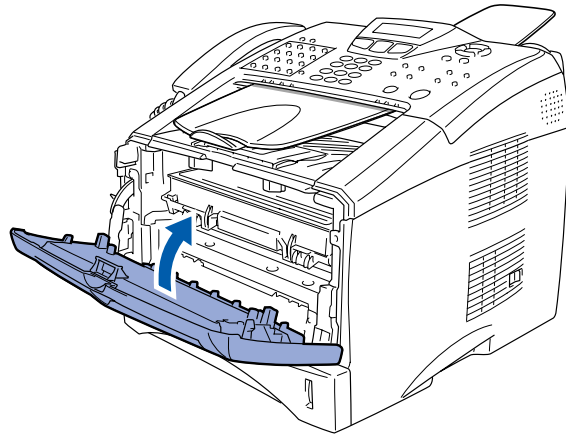

Step 1

Setting Up the Machine

4 Load Paper in the Paper Tray

- 1 Pull the paper tray completely out of the machine.

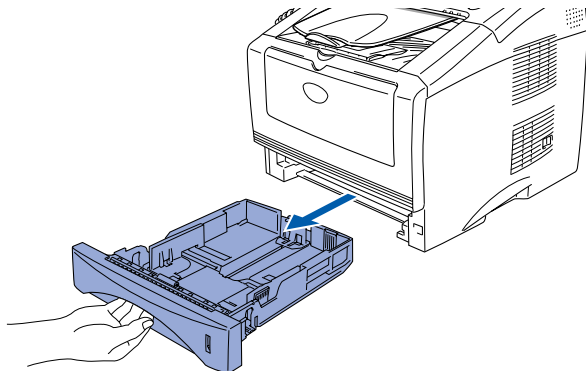

- 2 While pressing the paper guide release lever, slide the adjusters to fit the paper size. Check that the guides are firmly in the slots on the tray.

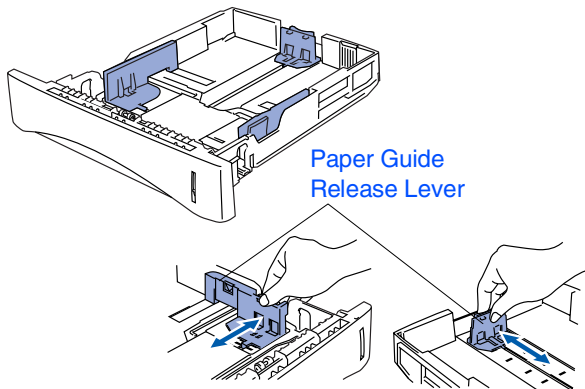

-  For Legal size paper, press the universal guide release button and pull out the rear of the paper tray.

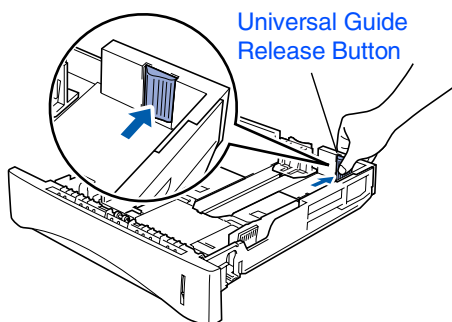

- 3 Fan the stack of paper well to avoid paper jams and misfeeds.

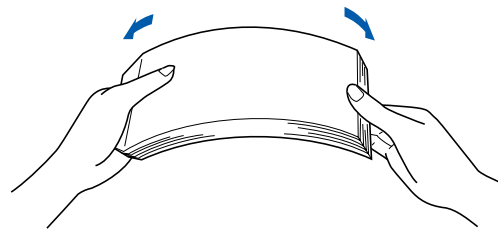

- 4 Put paper in the paper tray. Check that the paper is flat in the tray and below the maximum paper mark.

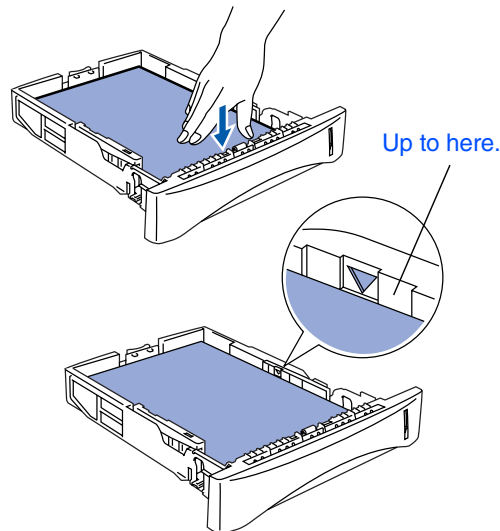

- 5 Put the paper tray firmly back in the machine and unfold the support flap before you use the machine.

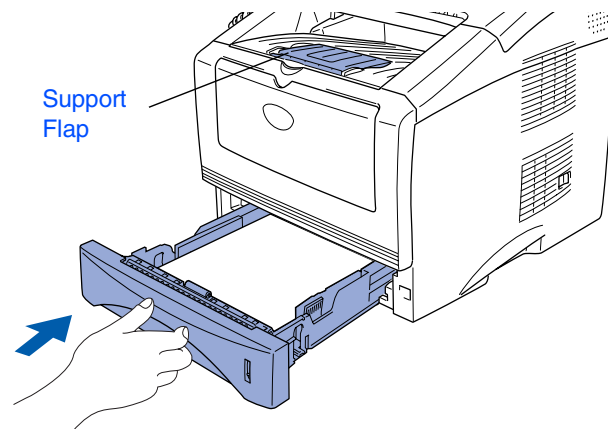

-  For details on supported paper specifications, see "About paper" in Chapter 2 of the User's Guide.

5

Installing the Power Cord and Phone Line



DO NOT connect the Parallel or USB cable yet.

- 1 Make sure that the power switch is off. Connect the power cord to the MFC.

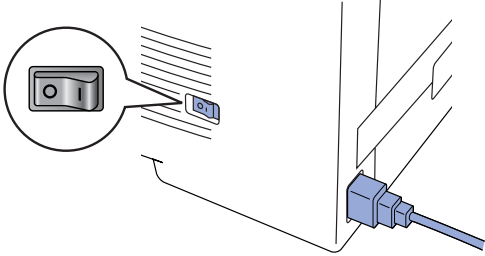

- 2 Plug the power cord into an AC outlet. Turn the power switch on.

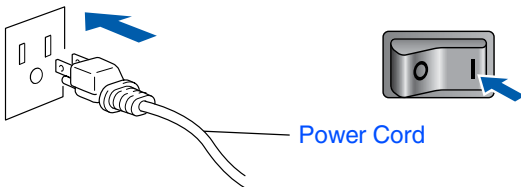

- 3 Connect one end of the telephone line cord to the jack on the MFC marked **LINE** and the other end to a modular wall jack.

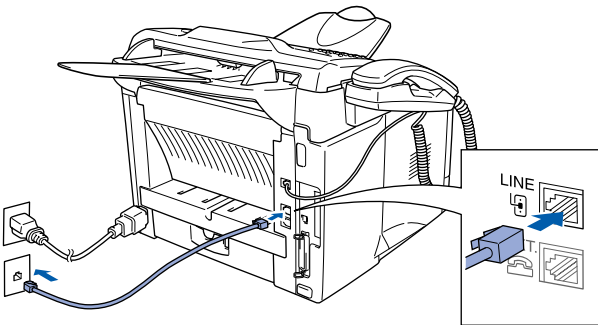

Warning

- The MFC must be grounded using a 3-prong plug.
- Since the MFC is grounded through the power outlet, you can protect yourself from potentially hazardous electrical conditions on the telephone network by keeping the power switched on when you connect it to a telephone line. Similarly, you can protect yourself when you want to move your MFC by disconnecting the telephone line first and then the power cord.



If you are sharing one phone line with an external telephone, connect it as shown below.

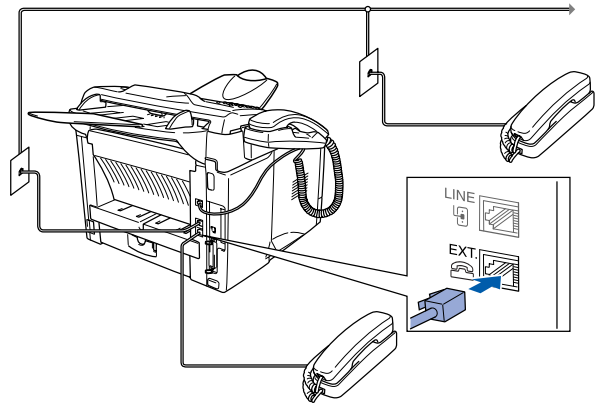

If you are sharing one phone line with an external telephone answering device, connect it as shown below.



Please set the receive mode to External TAD. For more details, see "Connecting the MFC" in Chapter 1 of the User's Guide.

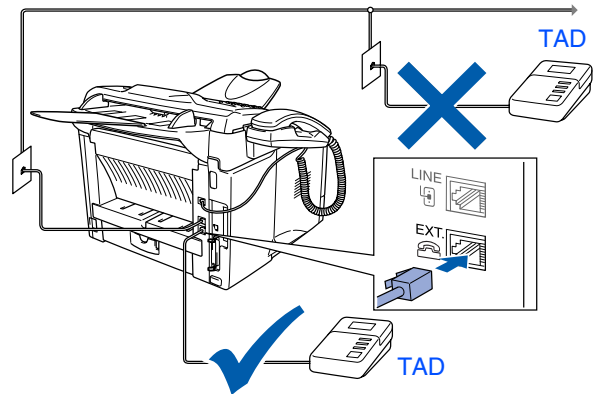

Step 1

Setting Up the Machine

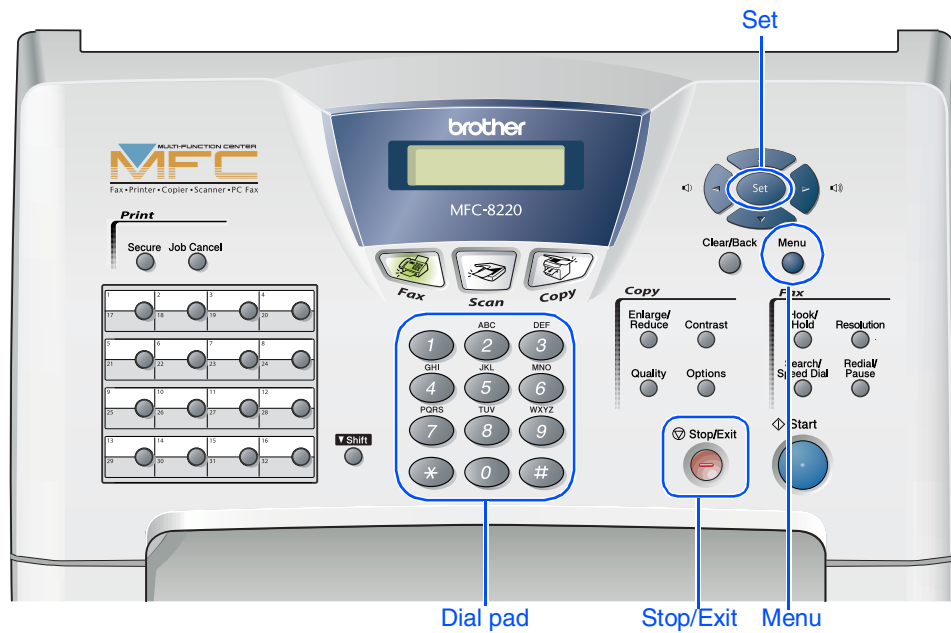

6 Setting the Date and Time

The MFC displays the date and time, and prints it on every fax you send.

- 1 Press **Menu**.
- 2 Press **0**.
- 3 Press **2**.
- 4 Enter the last two digits of the year on the dial pad, and then press **Set**.

```
Date/Time
Year:2004
```

(e.g. Enter **0, 4** for 2004.)

- 5 Enter the two digits for the month on the dial pad, and then press **Set**.

```
Date/Time
Month:03
```

(e.g. Enter **0, 3** for March.)

- 6 Enter the two digits for the day on the dial pad, and then press **Set**.

```
Date/Time
Day:01
```

(e.g. Enter **0, 1**.)

- 7 Enter the time in 24-hour format on the dial pad, and then press **Set**.

```
Date/Time
Time:15:25
```

(e.g. Enter **1, 5, 2, 5** for 3:25 P.M.)

- 8 Press **Stop/Exit**.



If you want to repeat from step 1, press **Stop/Exit**.

7 Setting Your Station ID

You should store your name and fax number to be printed on all fax pages that you send.

- 1 Press **Menu**.
- 2 Press **0**.
- 3 Press **3**.
- 4 Enter your fax number (up to 20 digits) on the dial pad, and then press **Set**.

```
Station ID
Fax: _
```

- 5 Enter your telephone number (up to 20 digits) on the dial pad, and then press **Set**. (If your telephone number and fax number are the same, enter the same number again.)

```
Station ID
Tel: _
```

- 6 Use the dial pad to enter your name (up to 20 characters), and then press **Set**.

```
Station ID
Name: _
```



- Refer to the following chart for entering your name.
- If you need to enter a character that is on the same key as the previous character, press  to move the cursor to the right.

Press key	One time	Two times	Three times	Four times
2	A	B	C	2
3	D	E	F	3
4	G	H	I	4
5	J	K	L	5
6	M	N	O	6
7	P	Q	R	S
8	T	U	V	8
9	W	X	Y	Z



For more details, see "Setting the Station ID" in Chapter 4 of the User's Guide.

- 7 Press **Stop/Exit**.

Step 1

Setting Up the Machine

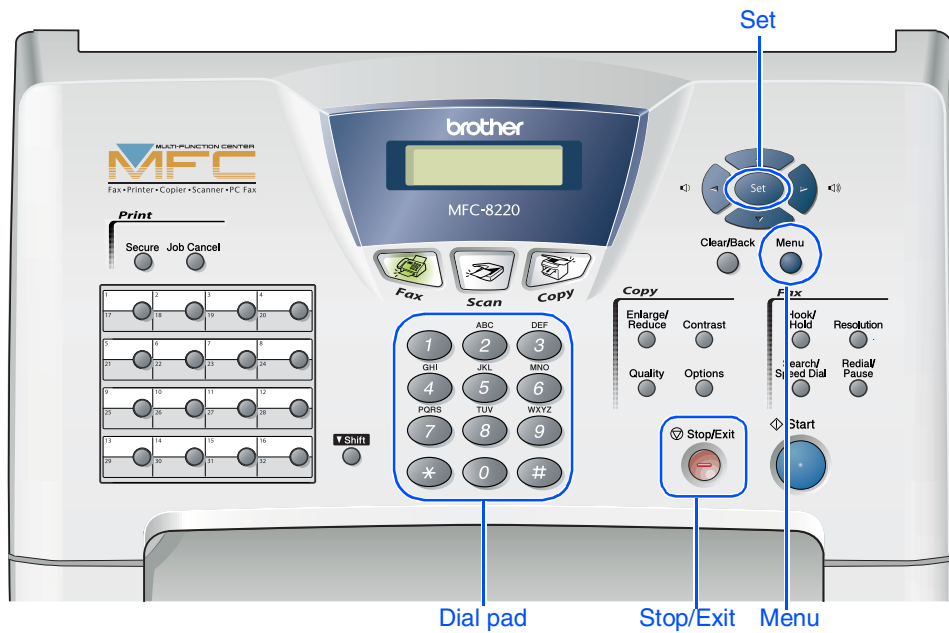

8 Selecting a Receive Mode

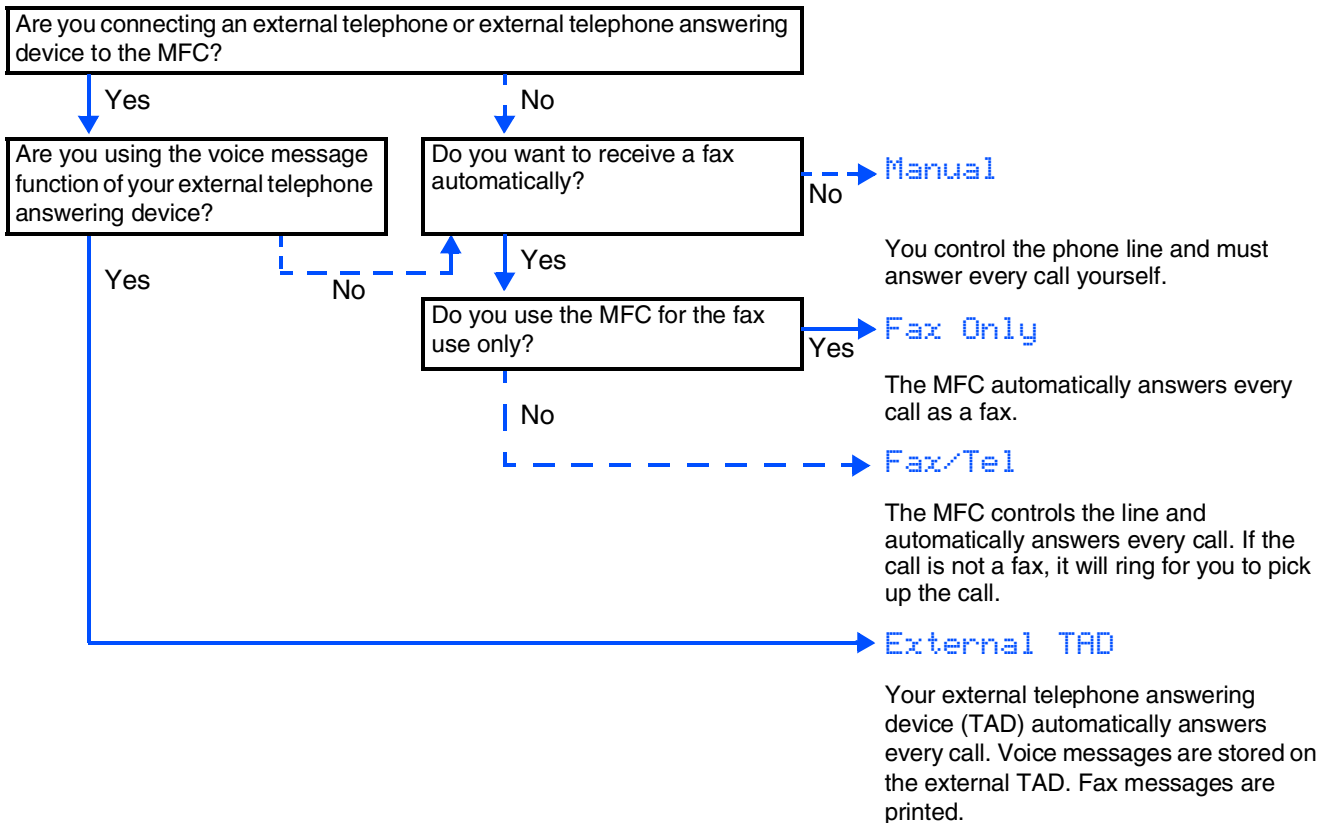

There are four possible receive modes: **Fax Only**, **Fax/Tel**, **Manual** and **External TAD**.



- 1 Press **Menu**.
- 2 Press **0**.
- 3 Press **1**.

- 4 Press **Stop/Exit** or **Start** to select the mode.
- 5 Press **Set**.
- 6 Press **Stop/Exit**.



For more details, see "Setup Receive" in Chapter 5 of the User's Guide.

9 Selecting Your Language (Canada Only)

- 1 Press **Menu**.
- 2 Press **0**.
- 3 Press **0**.
- 4 Select your language (ENGLISH or FRENCH) by using  or , and then press **Set**.

Local Language
English

- 5 Press **Stop/Exit**.

10 Sending in the Product Registration and Test Sheet (USA Only)

- 1 Fill out the Product Registration and Test Sheet.

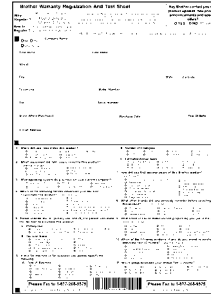

- 2 Place the sheet face down in the Automatic Document Feeder.

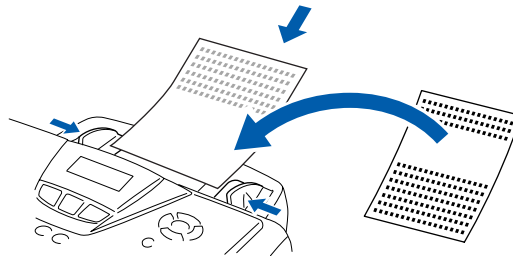

 Make sure  (Fax) is illuminated in Green.

- 3 Enter the toll-free fax number:
1-877-268-9575.

- 4 Press **Start**.

 You will receive a confirmation fax of your Product Registration.

 You can also register your product online using the On-Line Registration link from the installation CD-ROM or go to www.registermybrother.com

Go to Next page to
install the driver

Supplied CD-ROM (MFL-Pro Suite)

You can find a variety of information on the CD-ROM.

Windows®



Install Software

You can install the printer, PC-FAX Send/Receive, scanner drivers and the various utility items, including PaperPort® and TextBridge® OCR.



On-Line Registration

You will be pointed to the Brother Product Registration Web Page for quick registration of your MFC (Internet access required).



Documentation

View the User's Guide and other documentation in PDF format (Viewer included).



Brother Support

View contact information for Brother Customer Service and how to locate a Brother Authorized Service Center.



Help

Helpful hints.

Macintosh®



Start Here (Mac OS® 8.6 - 9.2)

You can install the printer driver, scanner driver, PC-FAX Send and Presto!® PageManager® for Mac OS® 8.6 - 9.2.



Start Here OSX

You can install the printer driver, scanner driver, PC-Fax Send, remote setup program and Presto!® PageManager® for Mac OS® 10.1/10.2.1 - 10.3 or greater (Scanning is not supported in Mac OS® 10.1).



ReadMe!

You can get important information and troubleshooting tips.



Documentation

View the User's Guide and other documentation in PDF format.



Brother Solutions Center

You can access the Brother Solutions Center which is a Web site offering information about your Brother product including FAQs, User's Guides, Driver updates and Tips for using your machine (Internet access required).



On-Line Registration

You will be pointed to the Brother Product Registration Web Page for quick registration of your MFC (Internet access required).



Follow the instructions on this page for your operating system and interface cable.

Setting Up
the Machine

Windows®



USB Interface Cable Users Go to page 14
(For Windows® 98/98SE/Me/2000 Professional/XP)

Windows®
USB



Parallel Interface Cable Users..... Go to page 26
(For Windows® 95/98/98SE/Me/2000 Professional/XP)

Windows®
Parallel



Windows NT® Workstation Version 4.0 Users... Go to page 38
(For Parallel Interface Cable Users)

Windows
NT® 4.0
Parallel



Optional NC-9100h Network Interface Users..... Go to page 41
(For Windows® 95/98/98SE/Me/NT/2000 Professional/XP)

Windows®
Network

Macintosh®



USB Interface Cable Users
■ For Mac OS® 8.6 to 9.2 Go to page 46
■ For Mac OS® X 10.1/10.2.1 - 10.3 or greater .. Go to page 48

Macintosh®
USB



Optional NC-9100h Network Interface Users
■ For Mac OS® 8.6 to 9.2 Go to page 50
■ For Mac OS® X 10.1/10.2.1 - 10.3 or greater .. Go to page 52

Macintosh®
Network

For Administrators..... Go to page 54

For
Administrators

Step 2

Installing the Driver & Software



For USB Interface Cable Users

(For Windows® 98/98SE/Me/2000 Professional/XP)

Make sure that you have completed the instructions from Step 1 “Setting Up the Machine” on pages 4 - 11.

- 1 Switch off and unplug the MFC from the AC outlet and disconnect it from your computer, if you already connected an interface cable.

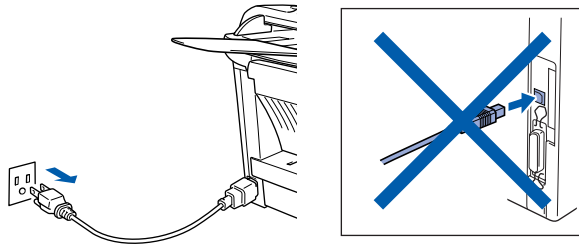

- 2 Turn on your computer. (For Windows® 2000 Professional/XP, you must be logged on as the administrator.)
- 3 Insert the supplied CD-ROM for Windows® into your CD-ROM drive. If the language screen appears, select your language.



- 4 The CD-ROM main menu will appear. Click **Install Software**.



If this window does not appear, use Windows® Explorer to run the **setup.exe** program from the root directory of the Brother CD-ROM.

- 5 Click **MFL-Pro Suite** in Main Application.



MFL-Pro Suite includes Printer Driver, Scanner Driver, ScanSoft® PaperPort®, ScanSoft® TextBridge®, PC-FAX software, Remote Setup and TrueType fonts. PaperPort® is a document management application for viewing scanned documents. ScanSoft® TextBridge®, which is integrated into PaperPort®, is an OCR application that converts an image into text and inserts it into your default word processor.

- 6 Click **Install**.

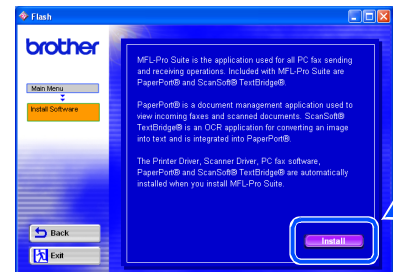

If you see the following screen, click **OK** to install the Windows® updates. After the updates are installed your PC may restart. If it does the installation will automatically continue.

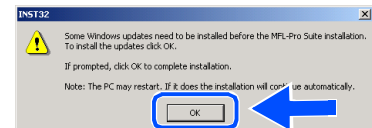

If the installation does not continue automatically, please open the installer menu again by double-clicking the **setup.exe** program from the root directory of the Brother CD-ROM, and continue from Step 4.

- 7 When the **PaperPort 8.0 SE Setup** window is displayed, click **Next**.

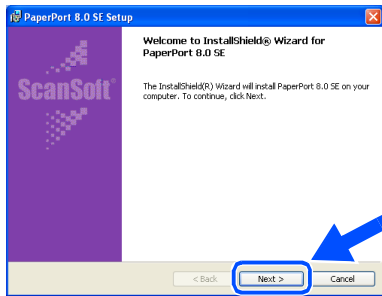

- 8 After reading and accepting the ScanSoft® License Agreement, enter your user information and click **Next**.

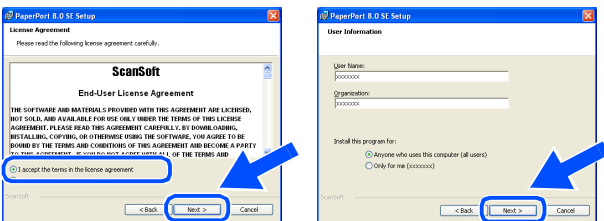

- 9 Select **Typical** and click **Next**.

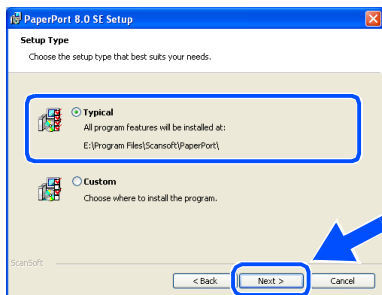

- 10 Click **Install** and PaperPort® will start installing on your computer.

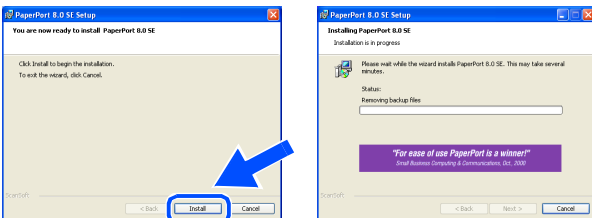

- 11 When the **PaperPort 8.0 SE Registration** screen is displayed, make your selection and follow the on-screen instructions.

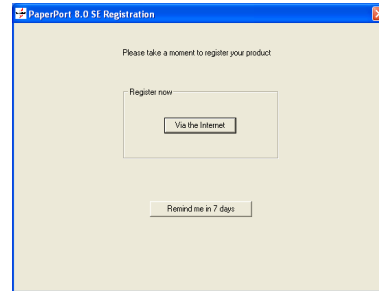

- 12 Click **Finish** to complete installation.

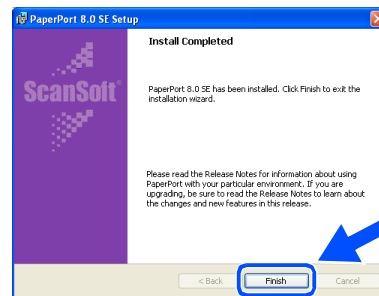

- 13 When the **Brother MFL-Pro Suite Installation** window appears, click **Next**.

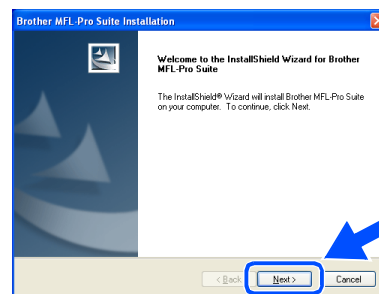

If an error message appears at this point in the installation process, or if you have previously installed the MFL-Pro Suite, you will first have to uninstall it. From the **Start** menu, select **Programs, Brother, MFL-Pro Suite MFC-8220, Uninstall**, and then follow the instructions on the screen.

Continued...

Step 2

Installing the Driver & Software

For USB Interface Cable Users (For Windows® 98/98SE/Me/2000 Professional/XP)

- 14 When the Brother Software License Agreement window appears, click **Yes**.

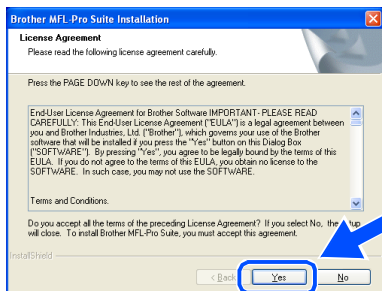

- 15 Select **Local Interface**, and then click **Next**.

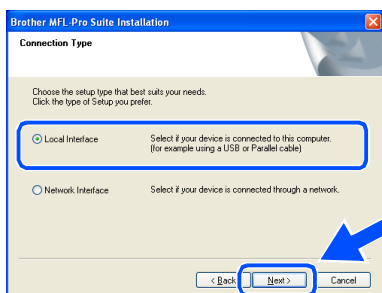

- 16 Select **Standard**, and then click **Next**. The application files will be copied and installed to your computer.

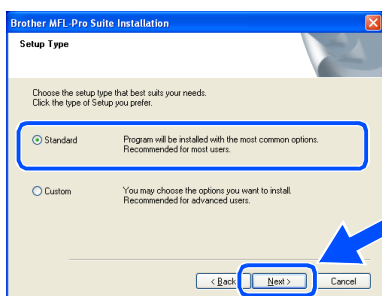

If you want to install the PS Brother (PostScript®) driver, select **Custom** and then follow the on-screen instructions. When the **Select Components** screen appears, check **PS Printer Driver**, and then continue following the on-screen instructions.



Windows® 98/98SE/Me Users
→ Go to page 17
Windows® 2000 Professional Users
→ Go to page 19
Windows® XP Users
→ Go to page 23

For Windows® 98/98SE/Me Users Only

Make sure that you followed the instructions in 1 to 16 on pages 14 - 16.

- 17 When this screen appears, connect the USB interface cable to your PC, and then connect it to the MFC. Plug the MFC into the AC power outlet. Turn the power switch on.

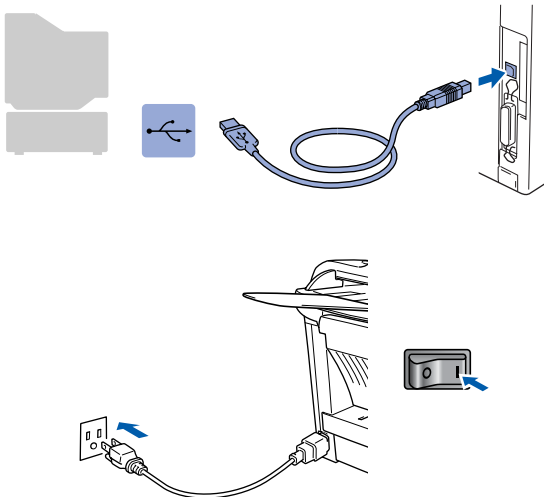
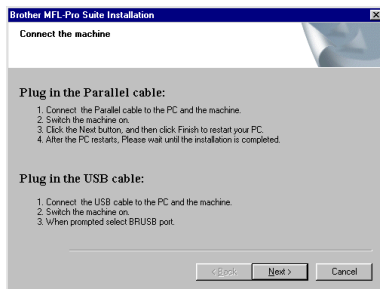

It will take a few seconds for the installation screen to appear.

The installation of the Brother drivers will automatically start. Follow the instructions on the screen.

- 18 Select **BRUSB: USB Printer Port**, and then click **Next**.

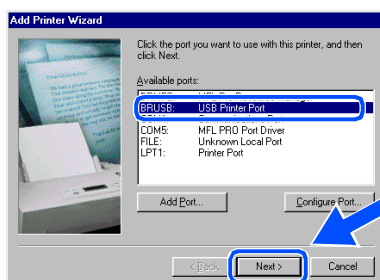

- 19 Accept the default Printer name by selecting **Yes**, and then click **Next**.

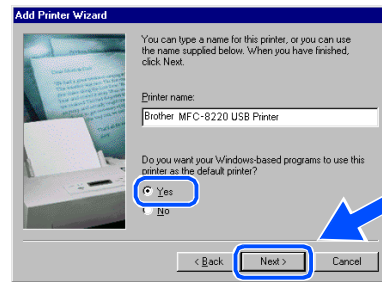

- 20 Select **Yes (recommended)**, and then click **Finish**. A test page will be printed so you can check the print quality.

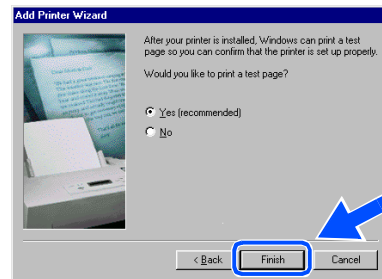

- 21 If the test page is printed correctly, click **Yes**. If you click **No**, follow the prompts on the screen to correct the problem.



If the **README** file shown in step 22 appears, close the **README.WRI** file and then click **Finish** after printing the page.

Continued...

Step 2

Installing the Driver & Software



For USB Interface Cable Users

(For Windows® 98/98SE/Me/2000 Professional/XP)

- 22 The README file will be displayed. Please read this file for troubleshooting information and then close the file to continue installation.

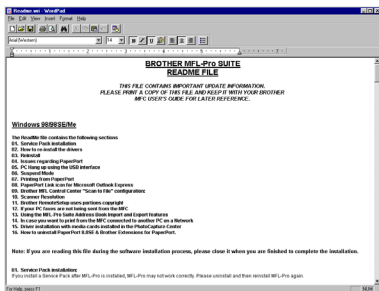

- 23 Check the **Run On-Line Registration** and then click **Next**.

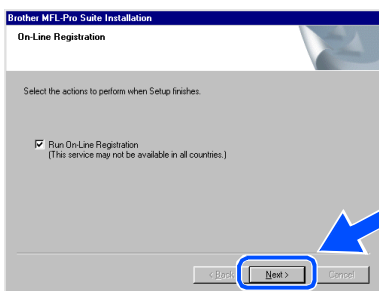

- 24 Click **Finish** to restart your computer.

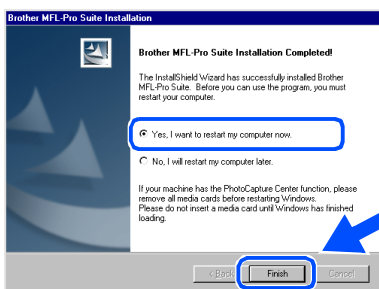

- 25 After the computer restarts, click **Yes** to have the Control Center load each time Windows® is started. The Control Center will appear as an icon in the task tray. If you click **No** the Scan key on the MFC will be disabled.

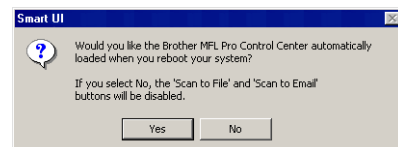

- If you checked the box in step 23, the screen for On-Line Registration will appear. Please complete your registration before proceeding to step 25.
- Even if you select **No**, you will be able to launch the Brother Control Center later to use the Scan key by double-clicking the Smart UI icon on the desktop. This loads the Brother Control Center to the task tray. See *AutoLoad the Brother Control Center, Chapter 4 in the Documentation (Software User's Guide)* located on the CD-ROM.

- OK!** The Brother PC-FAX, Printer and Scanner drivers have been installed and the installation is now complete.

For Windows® 2000 Professional Users Only

Make sure that you followed the instructions in 1 to 16 on pages 14 - 16.

- 17 When this screen appears, connect the USB interface cable to your PC, and then connect it to the MFC. Plug the MFC into the AC power outlet. Turn the power switch on.

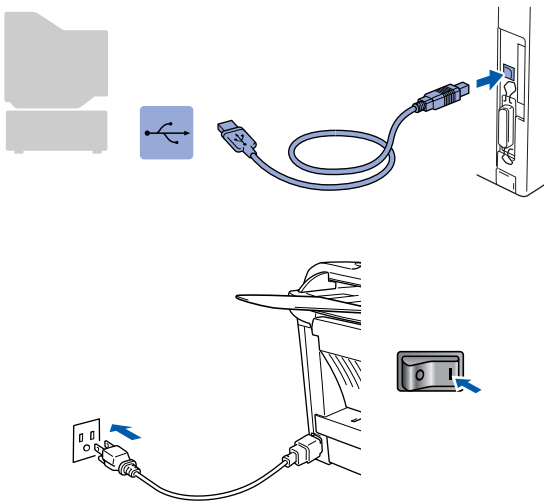
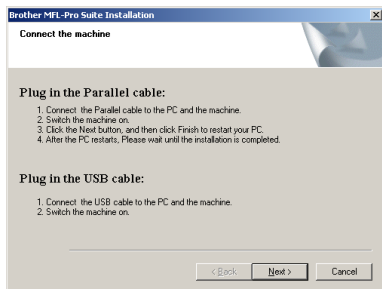

It will take a few seconds for the installation screen to appear.

The installation of the Brother drivers will automatically start. Follow the instructions on the screen.

- 18 If the **Digital Signature Not Found** dialog boxes appear, click **Yes** to install the driver.

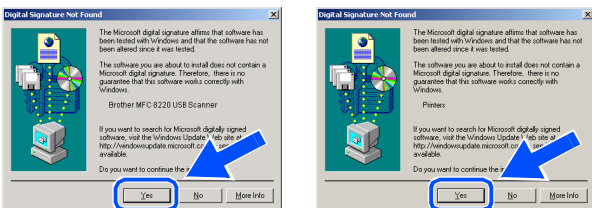

- 19 The README file will be displayed. Please read this file for troubleshooting information and then close the file to continue installation.

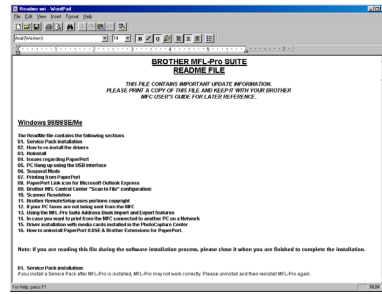

- 20 Check the **Run On-Line Registration** and then click **Next**.

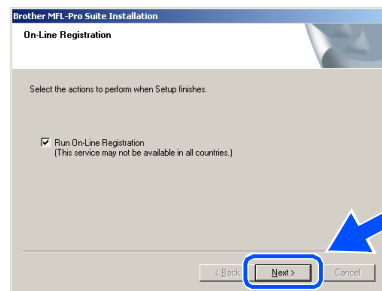

- 21 Click **Finish** to restart your computer.

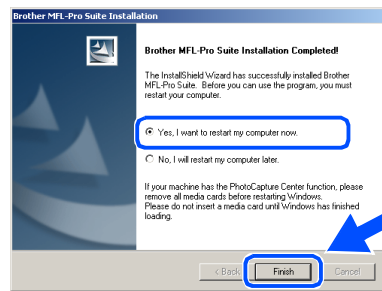

Continued...

For USB Interface Cable Users (For Windows® 98/98SE/Me/2000 Professional/XP)

- 22 After the computer restarts, click **Yes** to have the Control Center load each time Windows® is started. The Control Center will appear as an icon in the task tray. If you click **No** the Scan key on the MFC will be disabled.

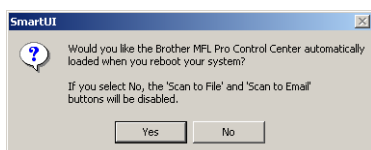

- If you checked the box in step 20, the screen for On-Line Registration will appear. Please complete your registration before proceeding to step 23.
- Even if you select **No**, you will be able to launch the Brother Control Center later to use the Scan key by double-clicking the Smart UI icon on the desktop. This loads the Brother Control Center to the task tray. See *AutoLoad the Brother Control Center, Chapter 4 in the Documentation (Software User's Guide)* located on the CD-ROM.



A Basic Universal printer driver was installed with the MFL-PRO Software Suite which is certified for use with Windows® operating systems.

Brother also offers a fully featured printer driver (Native driver) that includes more features than the Basic Universal driver. However, this driver does not include a Windows® certificate. To install the Brother Native driver proceed to step 23.



For details on what features are available, see chapter 2 of the Software User's Guide.

Brother Native driver Installation

- 23 Click **Start**, select **Settings** and then **Printers**. Click on **Add Printer** and the Add Printer Wizard will start. When this screen appears, click **Next**.

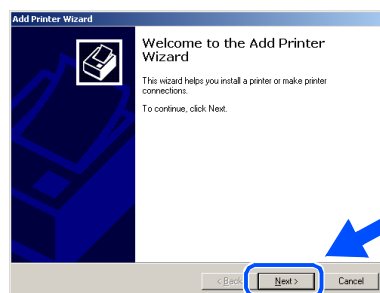

- 24 Un-check the **Automatically detect and install my Plug and Play printer** selection and then click **Next**.

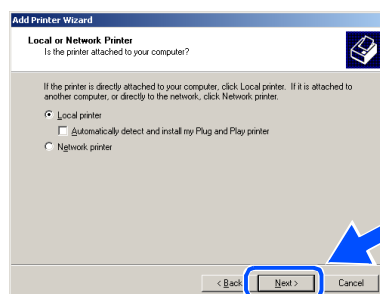

- 25 Select **USBXXX** from the pull down window for the Printer Port Selection and then click **Next**.

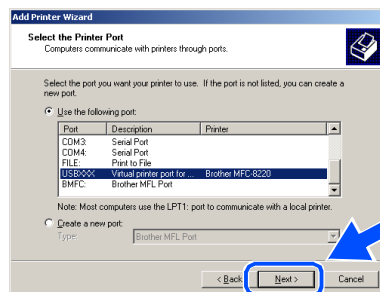

- 26 Click on **Have Disk**.

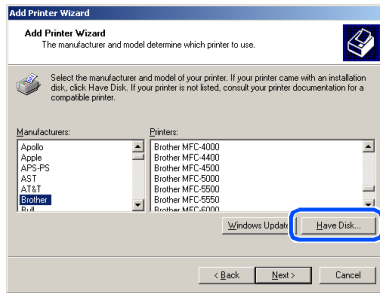

- 27 Browse the CD-ROM and highlight your country or language folder and click **Open**. Highlight the **W2K** folder and click **Open**. Highlight the **Addprt** folder and click **Open**.

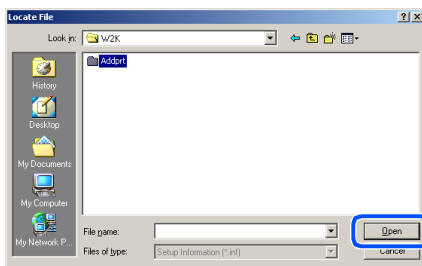

- 28 Click **Open**.

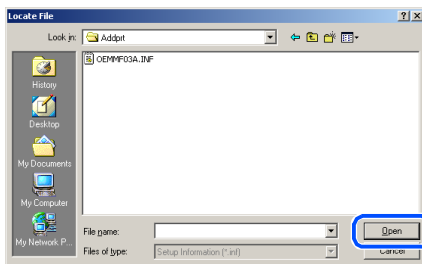

- 29 Make sure **X:\USA\W2K\Addprt** is displayed in the window and click **OK** (X:\ is the drive letter of your CD-ROM).



- 30 Highlight the model you are installing from the list of machines and click **Next**.

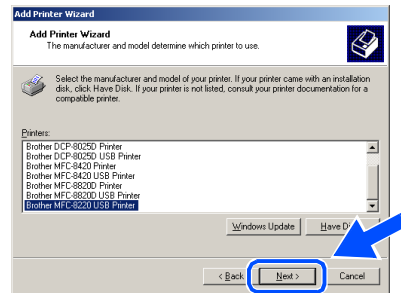

Make sure you select a USB printer.

- 31 The model you are installing will be listed in the window. Select **Yes** or **No** if you want this driver to be your default printer and then click **Next**.

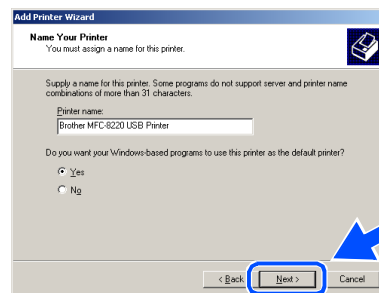

- 32 If this screen appears, select **Do not share this printer** and **Next**.

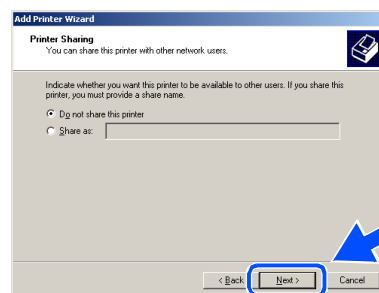

Continued...

Step 2

Installing the Driver & Software

For USB Interface Cable Users (For Windows® 98/98SE/Me/2000 Professional/XP)

- 33 Select **Yes** and **Next** to print a test page.

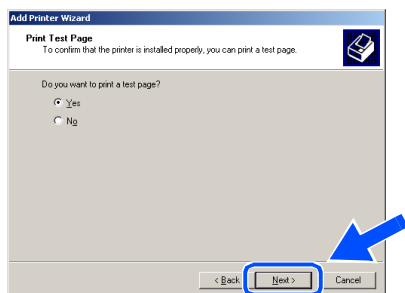

- 34 When this screen appears, click **Finish**.

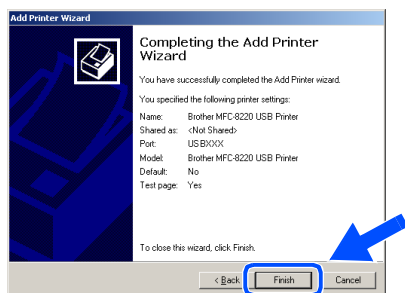

- 35 If the **Digital Signature Not Found** dialog box appears, click **Yes**.

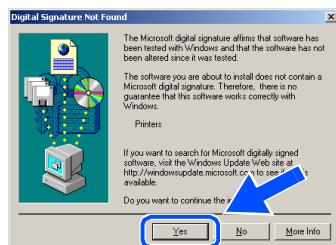

- 36 If the test page printed, click **OK**.

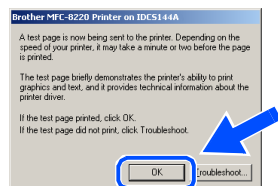

There will be two Brother printer drivers listed in the Printers selection. The driver with "Printer" after the model name (ex. Brother MFC-8220 Printer) is the Brother Native Driver.

- OK!** The Brother Native Drivers have been installed and the installation is now complete.

For Windows® XP Users Only

Make sure that you followed the instructions in 1 to 16 on pages 14 - 16.

- 17 When this screen appears, connect the USB interface cable to your PC, and then connect it to the MFC. Plug the MFC into the AC power outlet. Turn the power switch on.

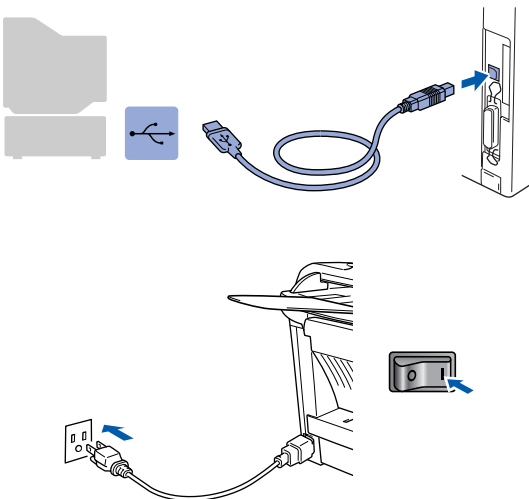
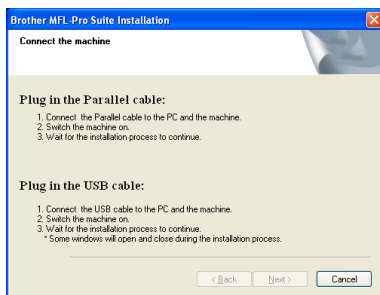

It will take a few seconds for the installation screen to appear.

The installation of the Brother drivers will automatically start. The screens appear one after another, please wait for a while.

- 18 The README file will be displayed. Please read this file for troubleshooting information and then close the file to continue installation.

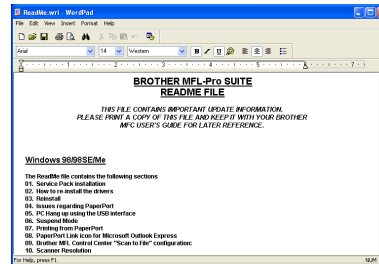

- 19 Check the **Run On-Line Registration** and then click **Next**.

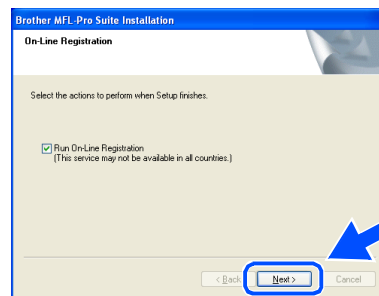

- 20 Click **Finish** to restart your computer.

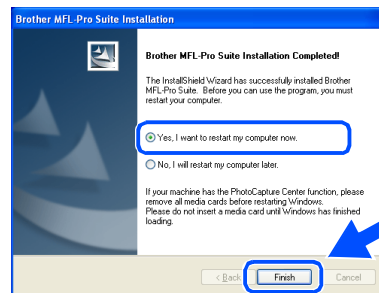

If you checked the box in step 19, the screen for On-Line Registration will appear. Please complete your registration before proceeding to step 21.

Continued...

Step 2

Installing the Driver & Software



For USB Interface Cable Users

(For Windows® 98/98SE/Me/2000 Professional/XP)

OK! A Basic Universal printer driver was installed with the MFL-PRO Software Suite which is certified for use with Windows® operating systems.

Brother also offers a fully featured printer driver (Native driver) that includes more features than the Basic Universal driver. However, this driver does not include a Windows® certificate. To install the Brother Native driver proceed to step 21.



For details on what features are available, see chapter 2 of the Software User's Guide.

Brother Native driver Installation

21 Click **Start** and select **Printers and Faxes**. Click on **Add a printer** and the Add Printer Wizard will start. When this screen appears, click **Next**.

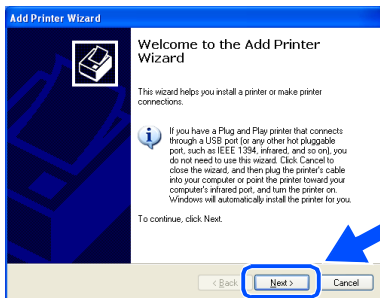

The Steps required to access **Add a printer** may be different depending on your version of Windows® XP, please refer to your Windows® XP user manual.

22 Un-check the **Automatically detect and install my Plug and Play printer** selection and then click **Next**.

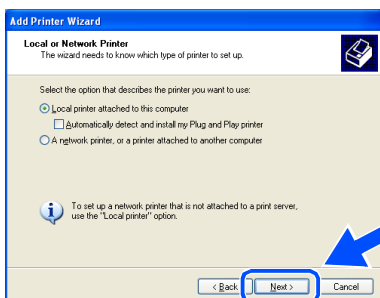

23 Select **USBXXX** from the pull down window for the Printer Port Selection and then click **Next**.

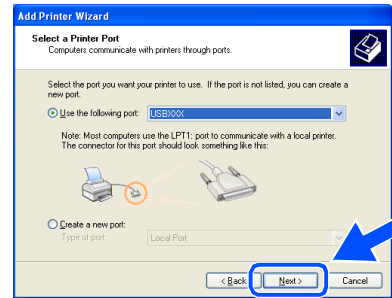

24 Click on **Have Disk**.

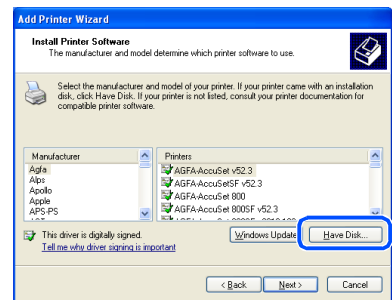

25 Browse the CD-ROM, highlight your country or language folder and click **Open**. Highlight the **WXP** folder and click **Open**. Highlight the **Addprt** folder and click **Open**.

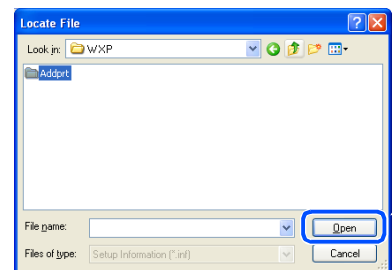

26 Click **Open**.

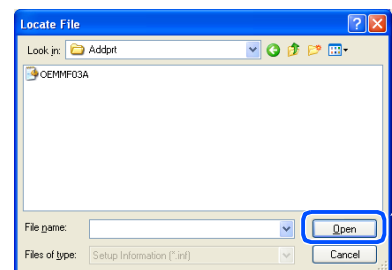

- 27 Make sure **X:\USA\WXP\Addprt** is displayed in the window and click **OK** (X:\ is the drive letter of your CD-ROM).

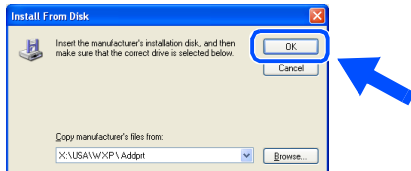

- 28 Highlight the model you are installing from the list of machines and click **Next**.

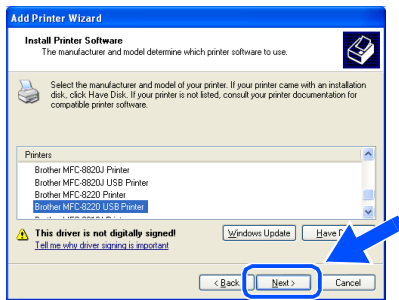

-  Make sure you select a USB printer.

- 29 The model you are installing will be listed in the window. Select **Yes** or **No** if you want this driver to be your default printer and then click **Next**.

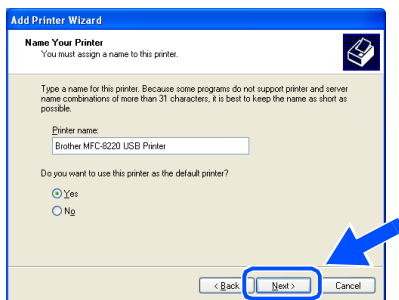

- 30 If this screen appears, select **Do not share this printer** and **Next**.

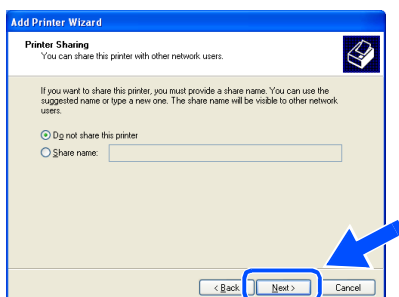

- 31 Select **Yes** and **Next** to print a test page.

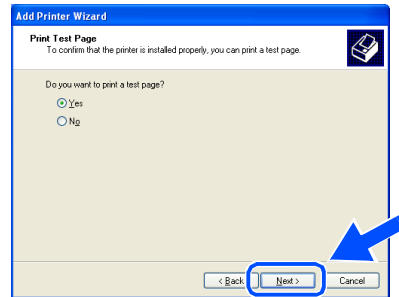

- 32 When this screen appears, click **Finish**.

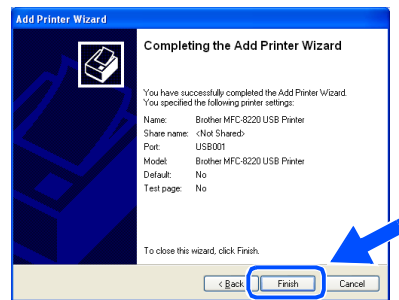

- 33 When this screen appears, click **Continue Anyway**.

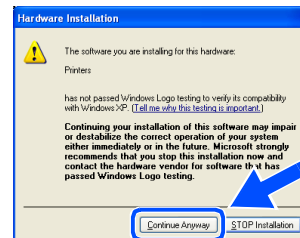

-  There will be two Brother printer drivers listed in the "Printers" selection. The driver with Printer after the model name (ex. Brother MFC-8220 Printer) is the Brother Native Driver.

- OK!** The Brother Native Drivers have been installed and the installation is now complete.

Step 2

Installing the Driver & Software

For Parallel Interface Cable Users (For Windows® 95/98/98SE/Me/2000 Professional/XP)

Make sure that you have completed the instructions from Step 1 “Setting Up the Machine” on pages 4 - 11.

- 1 Switch off and unplug the MFC from the AC outlet and disconnect it from your computer, if you already connected an interface cable.

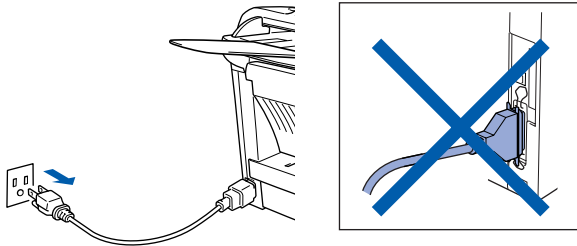

- 2 Turn on your computer. (For Windows® 2000 Professional/XP, you must be logged on as the administrator.)
- 3 Insert the supplied CD-ROM for Windows® into your CD-ROM drive. If the language screen appears, select your language.



- 4 The CD-ROM main menu will appear. Click **Install Software**.



If this window does not appear, use Windows® Explorer to run the **setup.exe** program from the root directory of the Brother CD-ROM.

- 5 Click **MFL-Pro Suite** in Main Application.



MFL-Pro Suite includes Printer Driver, Scanner Driver, ScanSoft® PaperPort®, ScanSoft® TextBridge®, PC-FAX software, Remote Setup and TrueType fonts. PaperPort® is a document management application for viewing scanned documents. ScanSoft® TextBridge®, which is integrated into PaperPort®, is an OCR application that converts an image into text and inserts it into your default word processor.

- 6 Click **Install**.

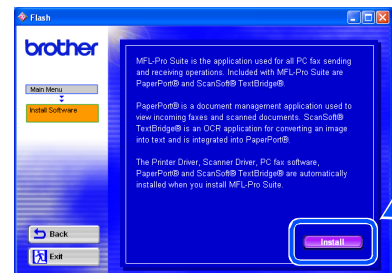

If you see the following screen, click **OK** to install the Windows® updates. After the updates are installed your PC may restart. If it does the installation will automatically continue.

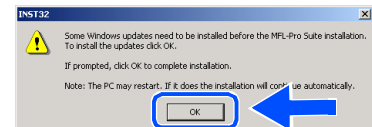

If the installation does not continue automatically, please open the installer menu again by double-clicking the **setup.exe** program from the root directory of the Brother CD-ROM, and continue from Step 4.

- 7 When the **PaperPort 8.0 SE Setup** window is displayed, click **Next**.

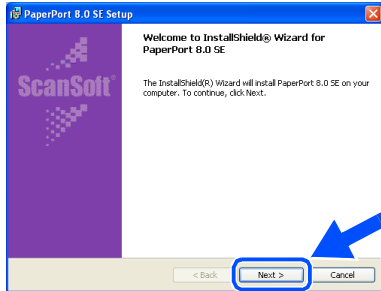

- 8 After reading and accepting the ScanSoft® License Agreement, enter your user information and click **Next**.

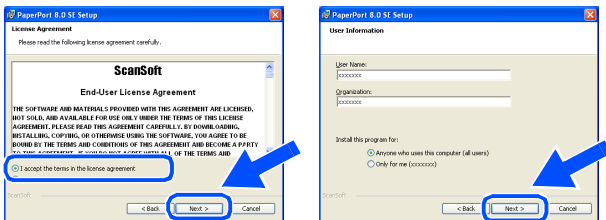

- 9 Select **Typical** and click **Next**.

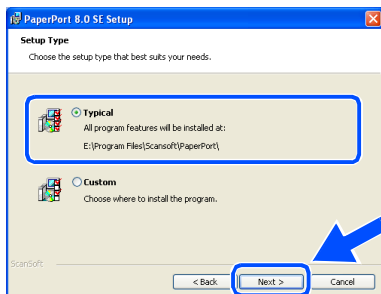

- 10 Click **Install** and PaperPort® will start installing on your computer.

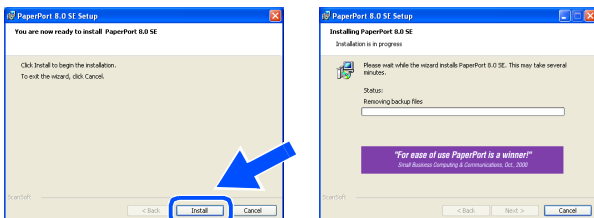

- 11 When the **PaperPort 8.0 SE Registration** screen is displayed, make your selection and follow the on-screen instructions.

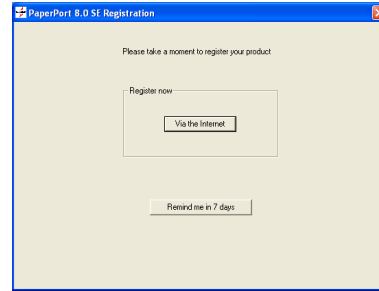

- 12 Click **Finish** to complete installation.

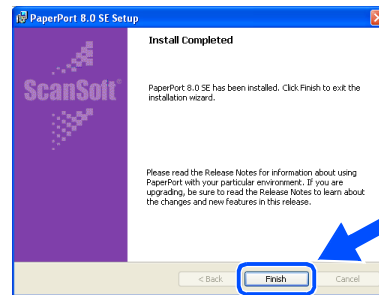

- 13 When the **Brother MFL-Pro Suite Installation** window appears, click **Next**.

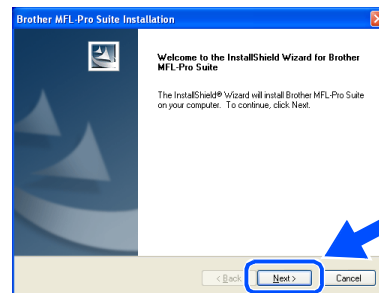

If an error message appears at this point in the installation process, or if you have previously installed the MFL-Pro Suite, you will first have to uninstall it. From the **Start** menu, select **Programs, Brother, MFL-Pro Suite MFC-8220, Uninstall**, and then follow the instructions on the screen.

Continued...

Step 2

Installing the Driver & Software

For Parallel Interface Cable Users (For Windows® 95/98/98SE/Me/2000 Professional/XP)

- 14 When the Brother Software License Agreement window appears, click **Yes**.

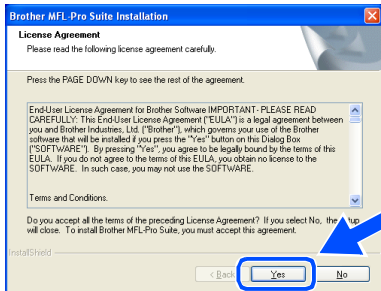

- 15 Select **Local Interface**, and then click **Next**.

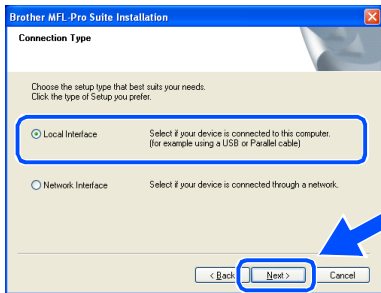

- 16 Select **Standard**, and then click **Next**.
The application files will be copied to your computer.

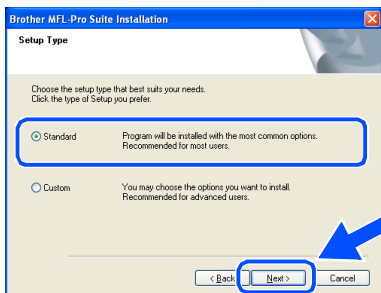

If you want to install the PS Brother (PostScript®) driver, select **Custom** and then follow the on-screen instructions. When the **Select Components** screen appears, check **PS Printer Driver**, and then continue following the on-screen instructions.

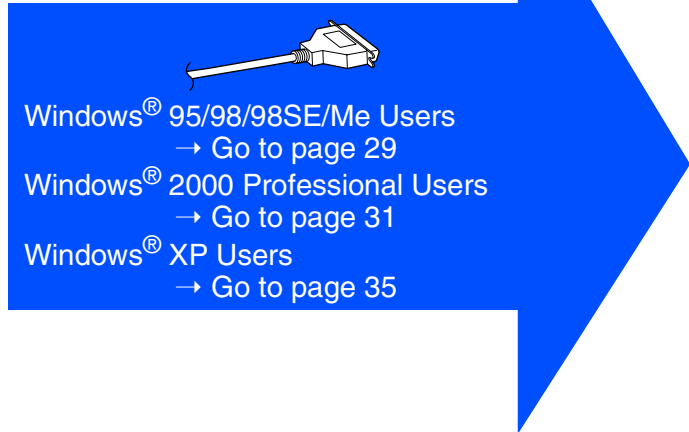

Windows® 95/98/98SE/Me Users
→ Go to page 29

Windows® 2000 Professional Users
→ Go to page 31

Windows® XP Users
→ Go to page 35

For Windows® 95/98/98SE/Me Users Only

Make sure that you followed the instructions in 1 to 16 on pages 26 - 28.

- 17 When this screen appears, connect the parallel interface cable to your PC, and then connect it to the MFC. Plug the MFC into the AC power outlet. Turn the power switch on.

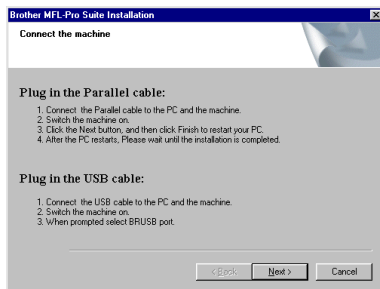

- 18 Click **Next**.

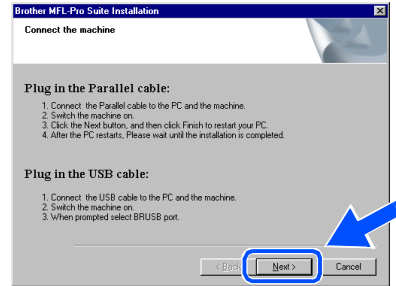

- 19 The README file will be displayed. Please read this file for troubleshooting information and then close the file to continue installation.

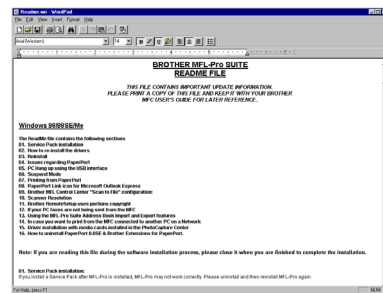

- 20 Check the **Run On-Line Registration** and then click **Next**.

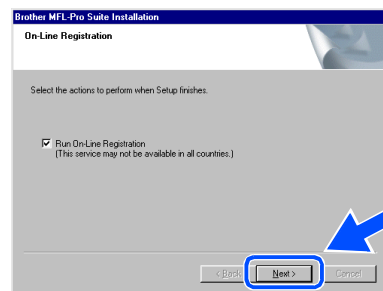

Continued...



- **DO NOT** plug the power cord before connecting the parallel interface cable. It may cause damage to your MFC.

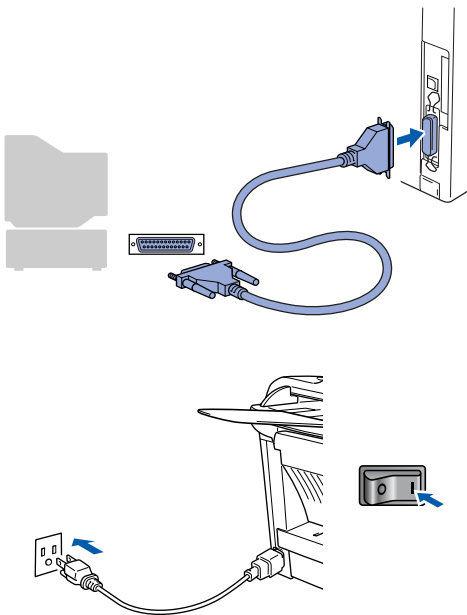

For Parallel Interface Cable Users (For Windows® 95/98/98SE/Me/2000 Professional/XP)

- 21 Click **Finish** to restart your computer.

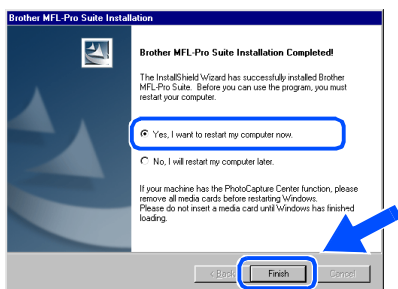

- 22 After the computer restarts, the installation of the Brother drivers will automatically start. Follow the instructions on the screen.

- 23 Click **Yes** to have the Brother MFL-Pro Control Center load each time Windows® is started. The Control Center will appear as an icon in the task tray. If you click **No** the Scan key on the MFC will be disabled.

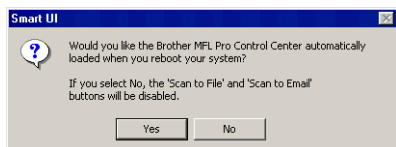

- If you checked the box in step 20, the screen for On-Line Registration will appear. Please complete your registration before proceeding to step 23.
- Even if you select **No**, you will be able to launch the Brother Control Center later to use the Scan key by double-clicking the Smart UI icon on the desktop. This loads the Brother Control Center to the task tray. See *AutoLoad the Brother Control Center*, Chapter 4 in the Documentation (Software User's Guide) located on the CD-ROM.

- OK!** The Brother PC-FAX, Printer and Scanner drivers have been installed and the installation is now complete.

For Windows® 2000 Professional Users Only

Make sure that you followed the instructions in 1 to 16 on pages 26 - 28.

- 17 When this screen appears, connect the parallel interface cable to your PC, and then connect it to the MFC. Plug the MFC into the AC power outlet. Turn the power switch on.

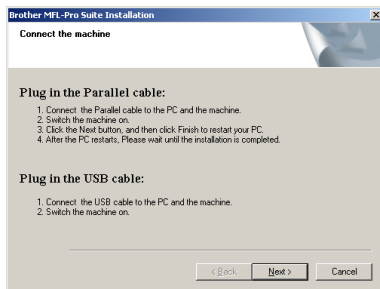

- 18 Click **Next**.

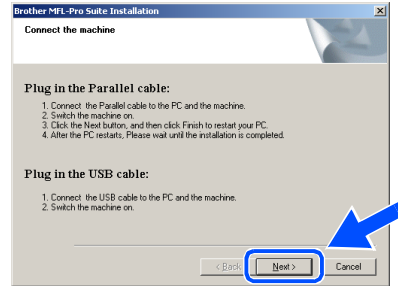

- 19 The README file will be displayed. Please read this file for troubleshooting information and then close the file to continue installation.

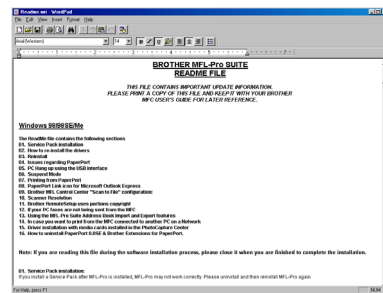

- 20 Check the **Run On-Line Registration** and then click **Next**.

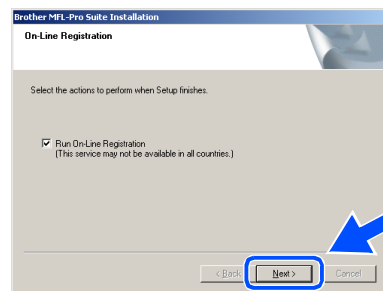

Continued...



- **DO NOT** plug the power cord before connecting the parallel interface cable. It may cause damage to your MFC.

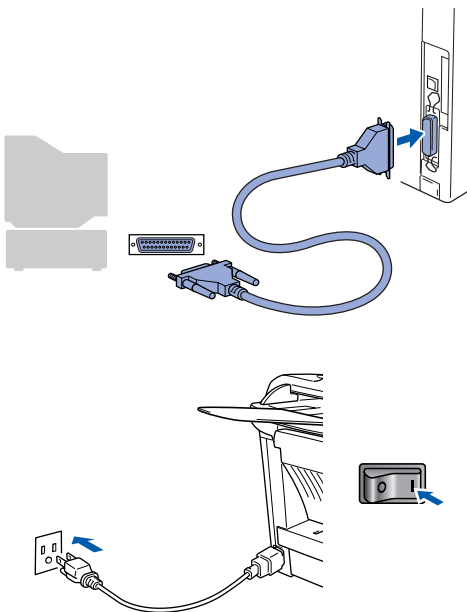

For Parallel Interface Cable Users (For Windows® 95/98/98SE/Me/2000 Professional/XP)

- 21 Click **Finish** to restart your computer.

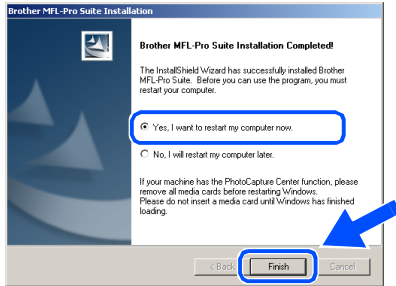

- 22 After the computer restarts, the installation of the Brother drivers will automatically start. Follow the instructions on the screen.

- 23 If the **Digital Signature Not Found** dialog boxes appear, click **Yes** to install the driver.

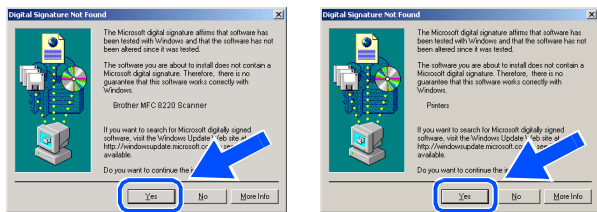

- 24 Click **Yes** to have the Control Center loaded each time Windows® is started. The Control Center will appear as an icon in the task tray. If you click **No** the Scan key on the MFC will be disabled.

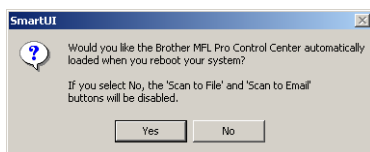

- If you checked the box in step 20, the screen for On-Line Registration will appear. Please complete your registration before proceeding to step 24.
- Even if you select **No**, you will be able to launch the Brother Control Center later to use the Scan key by double-clicking the Smart UI icon on the desktop. This loads the Brother Control Center to the task tray. See AutoLoad the Brother Control Center, Chapter 4 in the Documentation (Software User's Guide) located on the CD-ROM.

OK! A Basic Universal printer driver was installed with the MFL-PRO Software Suite which is certified for use with Windows® operating systems.

Brother also offers a fully featured printer driver (Native driver) that includes more features than the Basic Universal driver. However, this driver does not include a Windows® certificate. To install the Brother Native driver proceed to step 25.



For details on what features are available, see chapter 2 of the Software User's Guide.

Brother Native driver Installation

- 25 Click **Start** and select **Settings** and then **Printers**. Click on **Add Printer** and the Add Printer Wizard will start. When this screen appears, click **Next**.

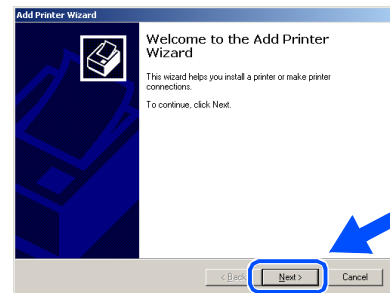

- 26 Un-check the **Automatically detect and install my Plug and Play printer** selection and then click **Next**.

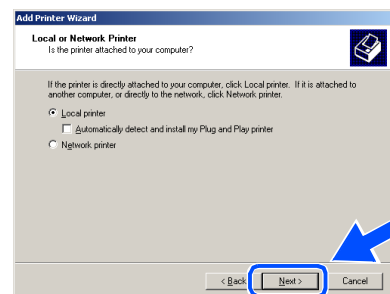

- 27 Select **BMFC (Brother MFL Port)** from the pull down window for the Printer Port Selection and then click **Next**.

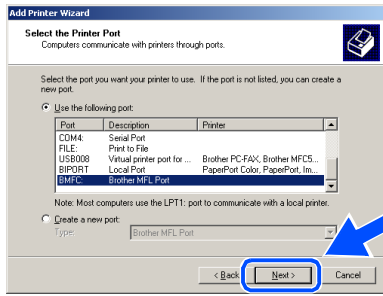

- 31 Make sure **X:\USA\W2K\Addprt** is displayed in the window and click **OK** (X:\ is the drive letter of your CD-ROM).

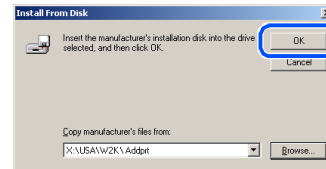

- 28 Click on **Have Disk**.

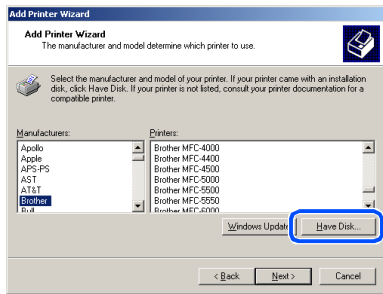

- 32 Highlight the model you are installing from the list of machines and click **Next**.

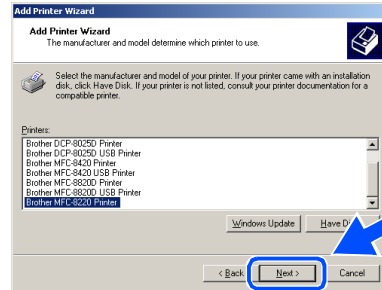

- 29 Browse the CD-ROM and highlight your country or language folder and click **Open**. Highlight the **W2K** folder and click **Open**. Highlight the **Addprt** folder and click **Open**.

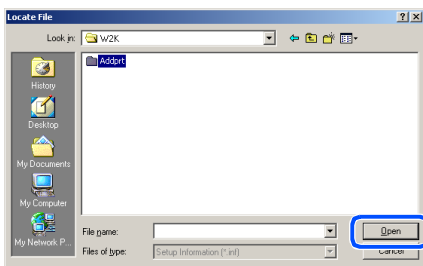

 *Make sure you do not select a USB printer.*

- 33 The model you are installing will be listed in the window. Select **Yes** or **No** if you want this driver to be your default printer and then click **Next**.

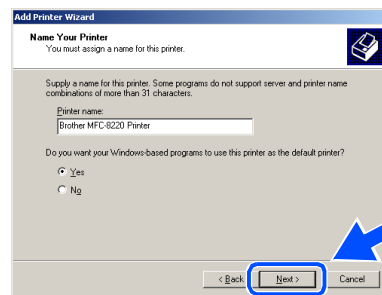

- 30 Click **Open**.

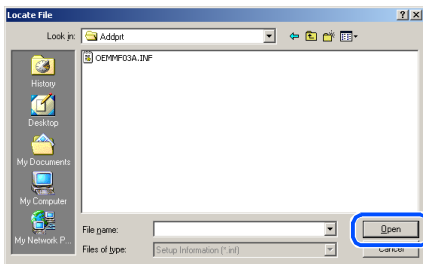

Continued... 

Step 2

Installing the Driver & Software

For Parallel Interface Cable Users (For Windows® 95/98/98SE/Me/2000 Professional/XP)

- 34 If this screen appears, select **Do not share this printer** and **Next**.

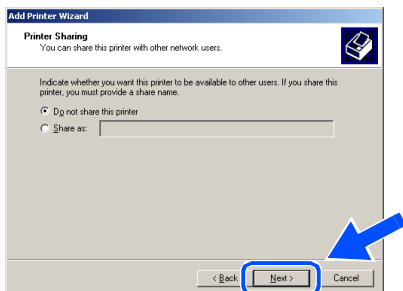

- 38 If the test page printed, click **OK**.

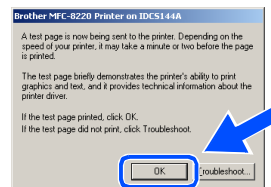

There will be two Brother printer drivers listed in the Printers selection. The driver with "Printer" after the model name (ex. Brother MFC-8220 Printer) is the Brother Native Driver.

- 35 Select **Yes** and **Next** to print a test page.

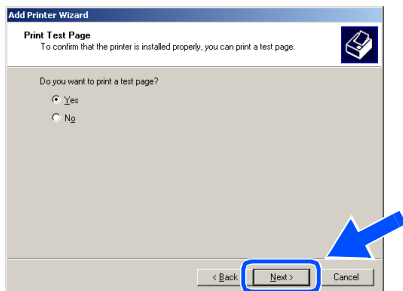

The Brother Native Drivers have been installed and the installation is now complete.

- 36 When this screen appears, click **Finish**.



- 37 If the **Digital Signature Not Found** dialog box appears, click **Yes**.

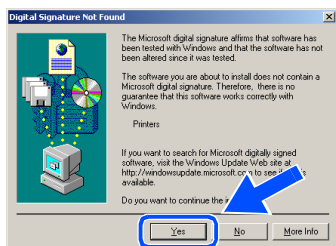

For Windows® XP Users Only

Make sure that you followed the instructions in 1 to 16 on pages 26 - 28.

- 17 When this screen appears, connect the parallel interface cable to your PC, and then connect it to the MFC. Plug the MFC into the AC power outlet. Turn the power switch on.

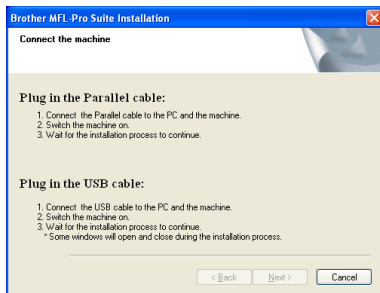

- **DO NOT** plug the power cord before connecting the parallel interface cable. It may cause damage to your MFC.

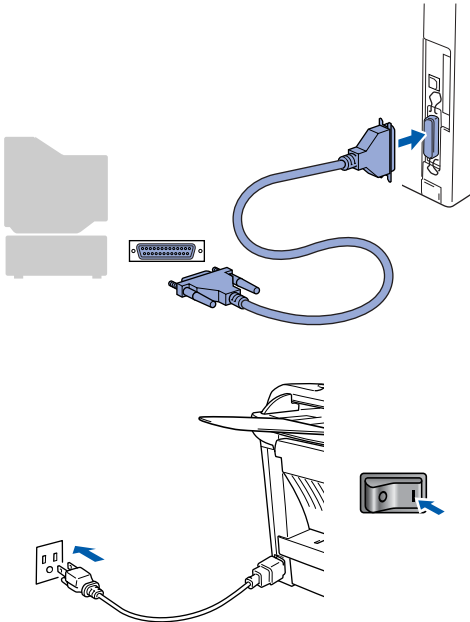

The installation of the Brother drivers will automatically start. The screens appear one after another, please wait for a while.

- 18 The README file will be displayed. Please read this file for troubleshooting information and then close the file to continue installation.

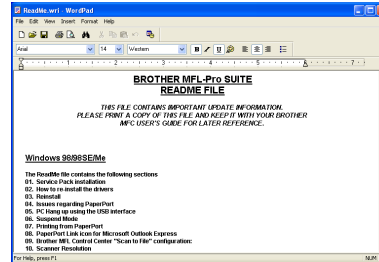

- 19 Check the **Run On-Line Registration** and then click **Next**.

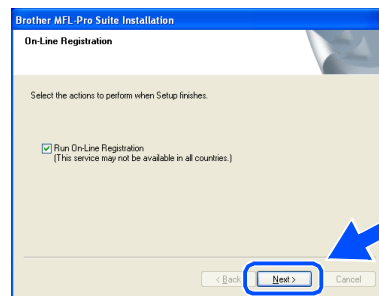

- 20 When the following screen appears, click **Finish** and wait as the PC restarts Windows® and continues the installation.

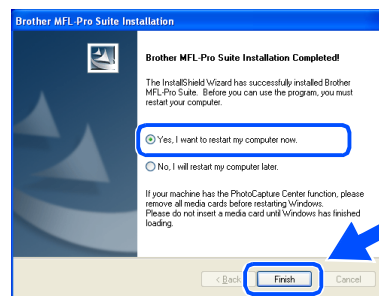

If you checked the box in step 19, the screen for On-Line Registration will appear. Please complete your registration before proceeding to step 21.

Continued...

For Parallel Interface Cable Users (For Windows® 95/98/98SE/Me/2000 Professional/XP)

OK! A Basic Universal printer driver was installed with the MFL-PRO Software Suite which is certified for use with Windows® operating systems.

Brother also offers a fully featured printer driver (Native driver) that includes more features than the Basic Universal driver. However, this driver does not include a Windows® certificate. To install the Brother Native driver proceed to step 21.

 For details on what features are available, see chapter 2 of the Software User's Guide.

Brother Native driver Installation

21 Click **Start** and select **Printers and Faxes**. Click on **Add a printer** and the Add Printer Wizard will start. When this screen appears, click **Next**.

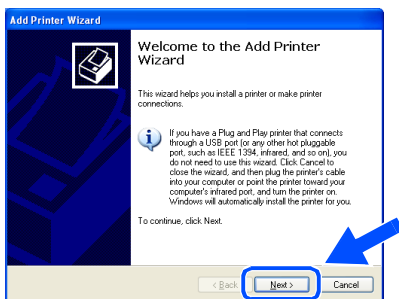

 The Steps required to access **Add a printer** may be different depending on your version of Windows® XP, please refer to your Windows® XP user manual.

22 Un-check the **Automatically detect and install my Plug and Play printer** selection and then click **Next**.

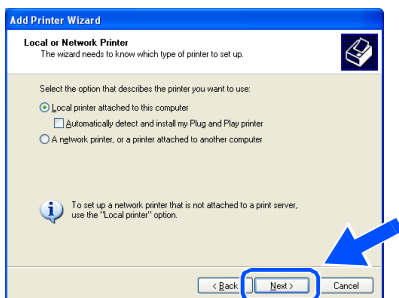

23 Select **BMFC (Brother MFL Port)** from the pull down window for the Printer Port Selection and then click **Next**.

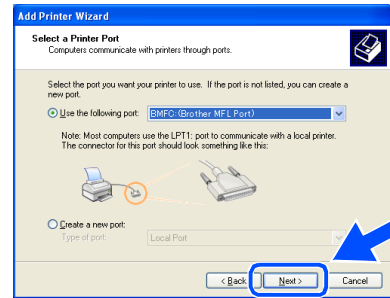

24 Click on **Have Disk**.

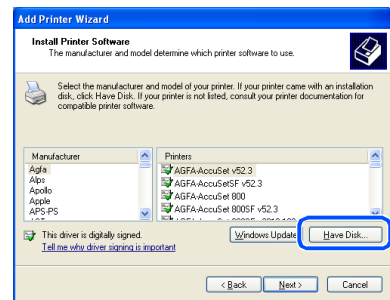

25 Browse the CD-ROM, highlight your country or language folder and click **Open**. Highlight the **WXP** folder and click **Open**. Highlight the **Addprt** folder and click **Open**.

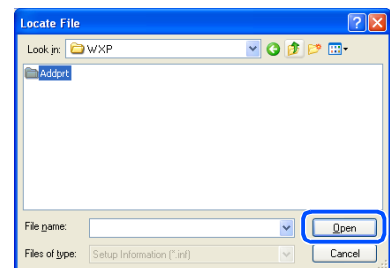

26 Click **Open**.

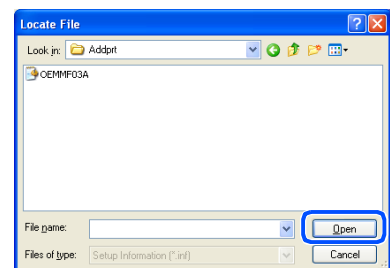

- 27 Make sure **X:\USA\WXP\Addprt** is displayed in the window and click **OK** (X:\ is the drive letter of your CD-ROM).

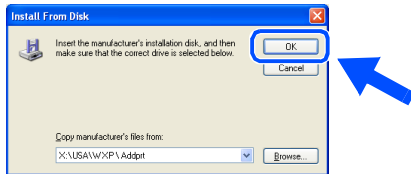

- 28 Highlight the model you are installing from the list of machines and click **Next**.

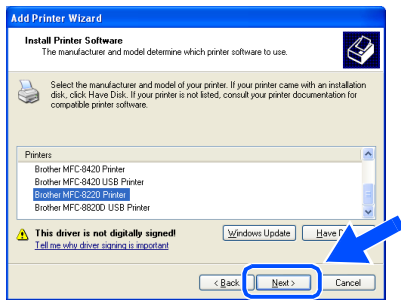

 Make sure you do not select a USB printer.

- 29 The model you are installing will be listed in the window. Select **Yes** or **No** if you want this driver to be your default printer and then click **Next**.

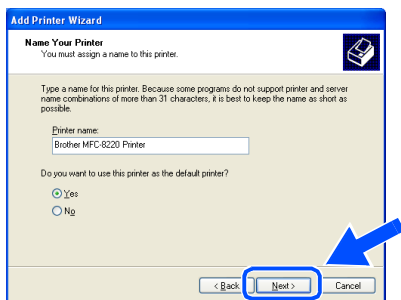

- 30 If this screen appears, select **Do not share this printer** and **Next**.

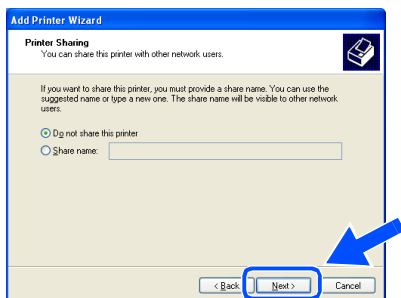

- 31 Select **Yes** and **Next** to print a test page.

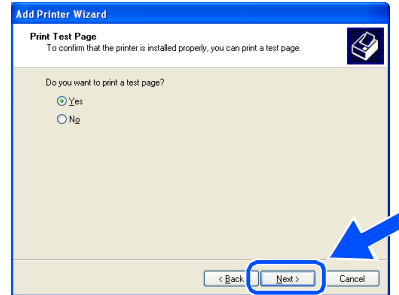

- 32 When this screen appears, click **Finish**.

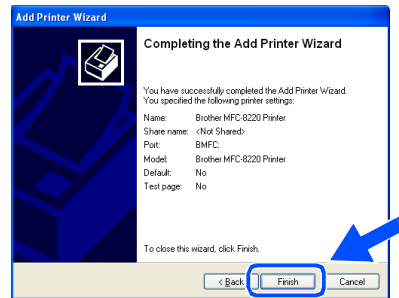

- 33 When this screen appears, click **Continue Anyway**.

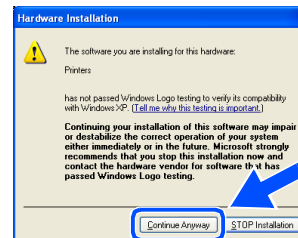

 There will be two Brother printer drivers listed in the Printers selection. The driver with "Printer" after the model name (ex. Brother MFC-8220 Printer) is the Brother Native Driver.

- OK!** The Brother Native Drivers have been installed and the installation is now complete.



For Windows NT[®] Workstation Version 4.0 Users

Make sure that you followed the instructions from Step 1 “Setting Up the Machine” on pages 4 - 11.

- 1 Turn on your computer.
You must be logged on as the Administrator.
- 2 Connect the parallel interface cable to your computer, and then connect it to the MFC.



- **DO NOT** plug the power cord before connecting the parallel interface cable. It may cause damage to your MFC.

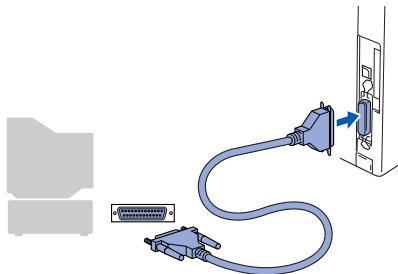

- 3 Plug the MFC into the AC power outlet. Turn the power switch on.

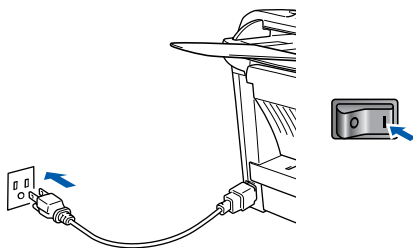

- 4 Insert the supplied CD-ROM for Windows[®] into your CD-ROM drive. If the language screen appears, select your language.



- 5 The CD-ROM main menu will appear. Click **Install Software**.



If this window does not appear, use Windows[®] Explorer to run the **setup.exe** program from the root directory of the Brother CD-ROM.

- 6 Click **MFL-Pro Suite** in Main Application.



MFL-Pro Suite includes Printer Driver, Scanner Driver, ScanSoft[®] PaperPort[®], ScanSoft[®] TextBridge[®], PC-FAX software, Remote Setup and TrueType fonts. PaperPort[®] is a document management application for viewing scanned documents. ScanSoft[®] TextBridge[®], which is integrated into PaperPort[®], is an OCR application that converts an image into text and inserts it into your default word processor.

- 7 Click **Install**.

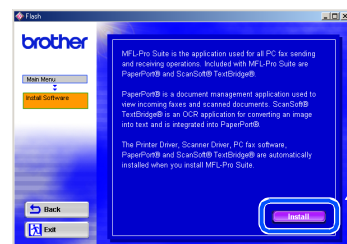

If you see the following screen, click **OK** to install the Windows[®] updates. After the updates are installed your PC may restart. If it does the installation will automatically continue.

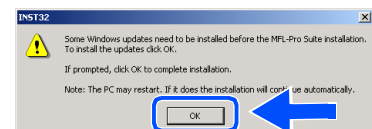

If the installation does not continue automatically, please open the installer menu again by double-clicking the **setup.exe** program on the Brother CD-ROM, and continue from Step 5.

- 8 When the **PaperPort 8.0 SE Setup** window is displayed, click **Next**.

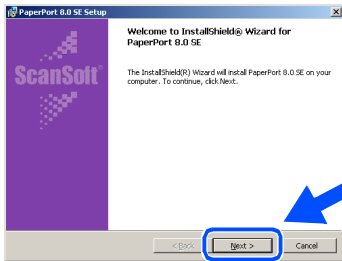

- 9 After reading and accepting the ScanSoft® License Agreement, enter your user information and click **Next**.

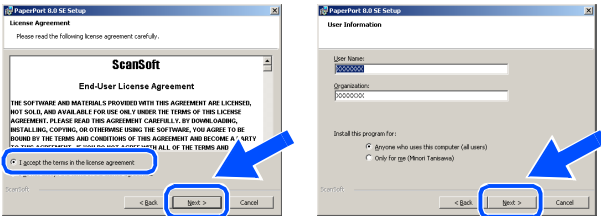

- 10 Select **Typical** and click **Next**.

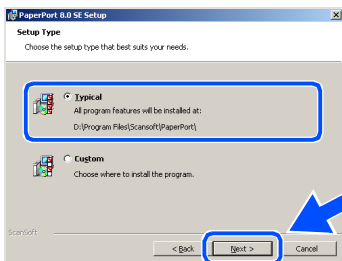

- 11 Click **Install** and PaperPort® will start installing on your computer.

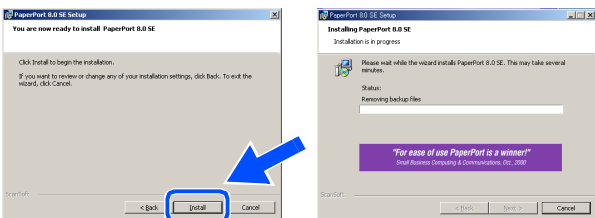

- 12 When the **PaperPort 8.0 SE Registration** screen is displayed, make your selection and follow the on-screen instructions.

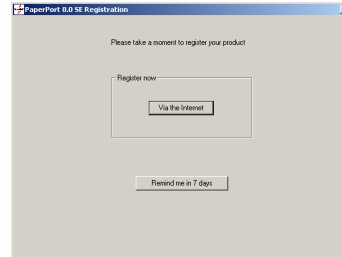

- 13 Click **Finish** to complete installation.

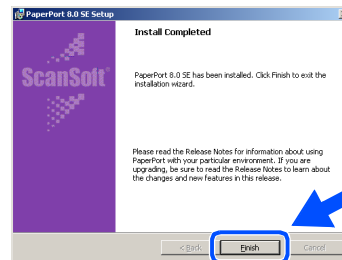

- 14 When the **Brother MFL-Pro Suite Installation** window appears, click **Next**.

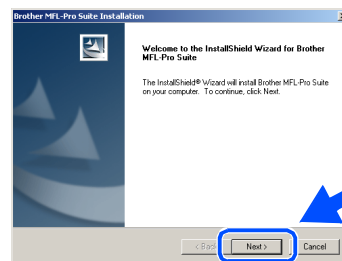

If an error message appears at this point in the installation process, or you have previously installed MFL-Pro Suite, you will first have to uninstall it. From the **Start** menu, select **Programs, Brother, MFL-Pro Suite MFC8220, Uninstall**, and then follow the instructions on the screen.

Continued...



For Windows NT® Workstation Version 4.0 Users

- 15 When the Brother Software License Agreement window appears, click **Yes** if you agree to it and go to next screen.

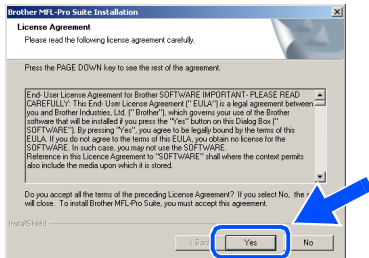

- 16 Select **Local Interface**, and then click **Next**.

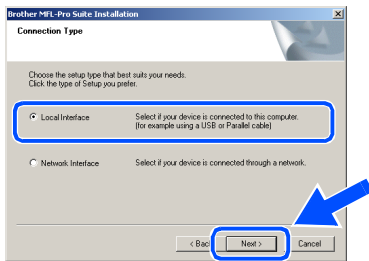

- 17 When the Setup Type window appears, select **Standard**, and then click **Next**.

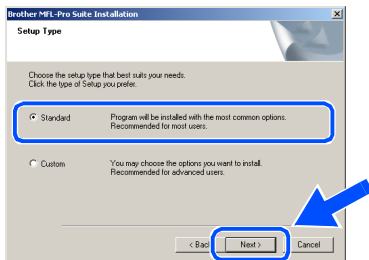

If you want to install the PS Brother (PostScript®) driver, select **Custom** and then follow the on-screen instructions. When the **Select Components** screen appears, check **PS Printer Driver**, and then continue following the on-screen instructions.

- 18 The README file will be displayed. Please read this file for troubleshooting information and then close the file to continue installation.

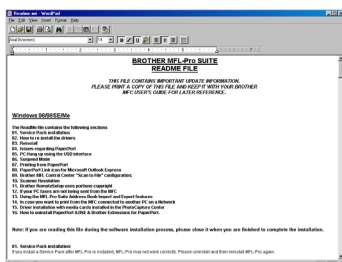

- 19 Check the **Run On-Line Registration** and then click **Next**.

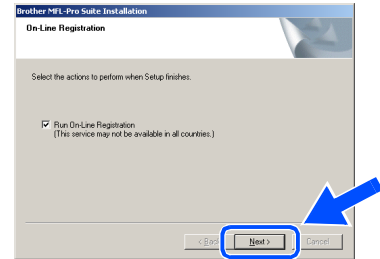

- 20 Click **Finish** to restart your computer.

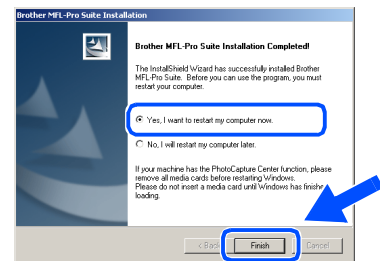

- 21 After the computer restarts, click **Yes** to have the Control Center load each time Windows® is started. The Control Center will appear as an icon in the task tray. If you click **No** the Scan key on the MFC will be disabled.

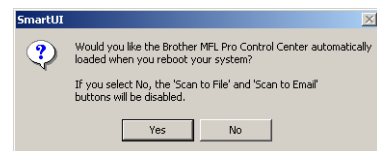

- If you checked the box in step 19, the screen for On-Line Registration will appear. Please complete your registration before proceeding to step 21.
- Even if you select **No**, you will be able to launch the Brother Control Center later to use the Scan key by double-clicking the Smart UI icon on the desktop. This loads the Brother Control Center to the task tray. See *AutoLoad the Brother Control Center*, Chapter 4 in the Documentation (Software User's Guide) located on the CD-ROM.



The Brother PC-FAX, Printer and Scanner drivers have been installed and the installation is now complete.

For Optional NC-9100h Network Interface Users (For Windows® 95/98/98SE/Me/NT/2000 Professional/XP)

Make sure that you have completed the instructions from Step 1 “Setting Up the Machine” on pages 4 - 11.

- 1 Make sure that the NC-9100h (Network Print/Fax Server) is installed into the MFC. (See "Optional accessories" in Chapter 13 of the User's Guide.)

- 2 Connect the network cable to the MFC, and then connect it to a free port on your hub. Plug the MFC into the AC power outlet. Turn the power switch on.

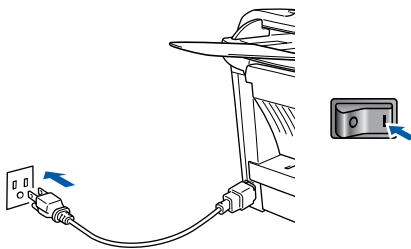
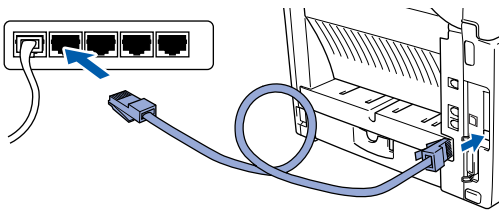

- 3 Turn on your computer. (For Windows® 2000 Professional/XP and Windows NT® 4.0, you must be logged on as the administrator.)
- 4 Insert the supplied CD-ROM for Windows® into your CD-ROM drive. If the language screen appears, select your language.



- 5 The CD-ROM main menu will appear. Click **Install Software**.



If this window does not appear, use Windows® Explorer to run the **setup.exe** program from the root directory of the Brother CD-ROM.

- 6 Click **MFL-Pro Suite** in Main Application.

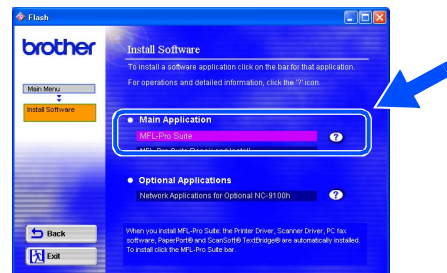

MFL-Pro Suite includes Printer Driver, Scanner Driver, ScanSoft® PaperPort®, ScanSoft® TextBridge®, PC-FAX software and TrueType fonts. PaperPort® is a document management application for viewing scanned documents. ScanSoft® TextBridge®, which is integrated into PaperPort®, is an OCR application that converts an image into text and inserts it into your default word processor.

Continued...

Step 2

Installing the Driver & Software

 For Optional NC-9100h Network Interface Users
(For Windows® 95/98/98SE/Me/NT/2000 Professional/XP)

7 Click **Install**.

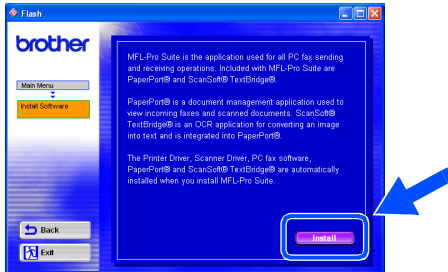

If you see the following screen, click **OK** to install the Windows® updates. After the updates are installed your PC may restart. If it does the installation will automatically continue.

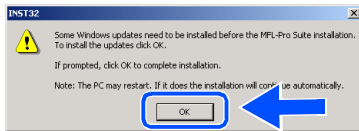

If the installation does not continue automatically, please open the installer menu again by double-clicking the **setup.exe** program from the root directory of the Brother CD-ROM, and continue from Step 5.

8 When the **PaperPort 8.0 SE Setup** window is displayed, click **Next**.

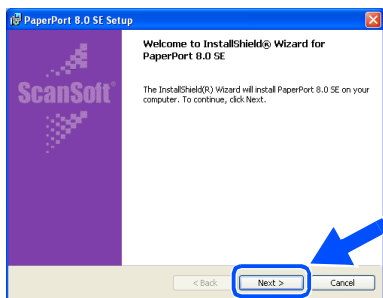

9 After reading and accepting the ScanSoft® License Agreement, enter your user information and click **Next**.

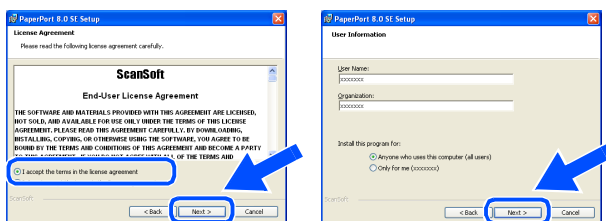

10 Select **Typical** and click **Next**.

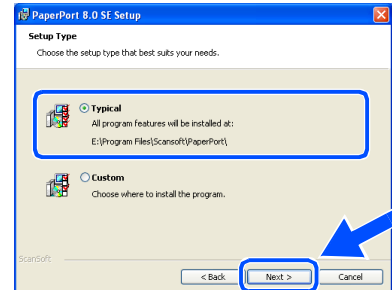

11 Click **Install** and PaperPort® will start installing on your computer.

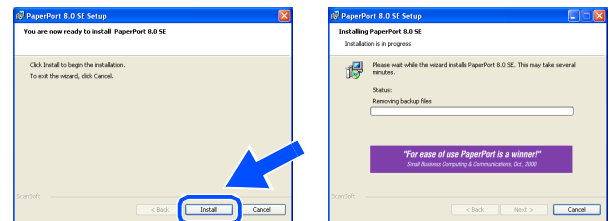

12 When the **PaperPort 8.0 SE Registration** screen is displayed, make your selection and follow the on-screen instructions.



13 Click **Finish** to complete installation.

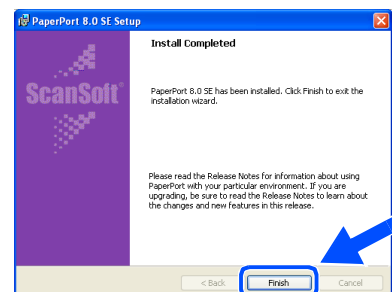

- 14 When the **Brother MFL-Pro Suite Installation** window appears, click **Next**.

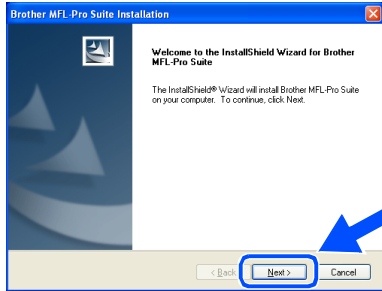

If an error message appears at this point in the installation process, you will first have to uninstall MFL-Pro Suite. From the **Start** menu, select **Programs, Brother, MFL-Pro Suite MFC-8220, Uninstall**, and then follow the instructions on the screen.

- 15 When the Brother Software License Agreement window appears, click **Yes**.

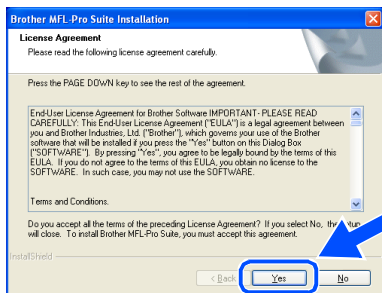

- 16 Select **Network Interface**, and then click **Next**.

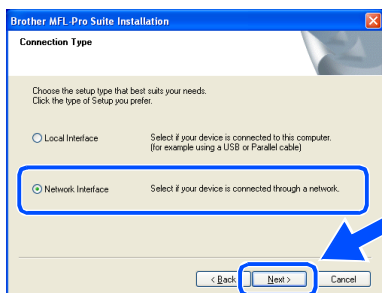

- 17 Select **Standard**, and then click **Next**. The application files will be copied to your computer.

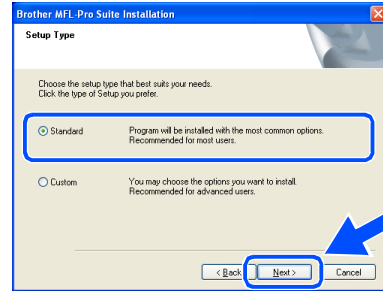

If you want to install the PS Brother (PostScript®) driver, select **Custom** and then follow the on-screen instructions. When the **Select Components** screen appears, check **PS Printer Driver**, and then continue following the on-screen instructions.

- 18 Select **Search the network for devices and choose from a list of discovered devices (Recommended)**, and then click **Next**.

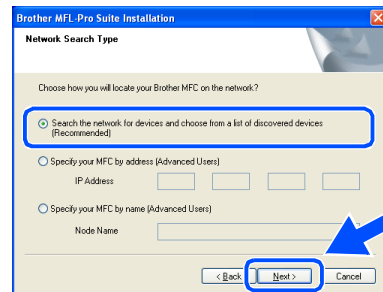

If you see the following screen, click **OK**.



Continued...

Step 2

Installing the Driver & Software

For Optional NC-9100h Network Interface Users (For Windows® 95/98/98SE/Me/NT/2000 Professional/XP)

- 19 If the MFC is un-configured for your network:
Select the APIPA or un-configured device from the list and then click **Next**. → **Go to** 20

If the MFC is configured for your network:
Select the MFC from the list and then click **Next**. → **Go to** 23

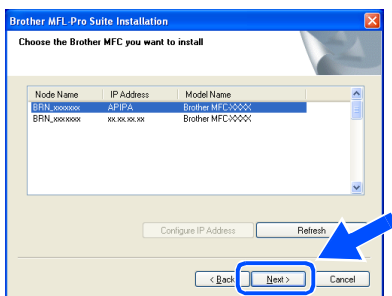

- 20 Click **Configure IP Address**.

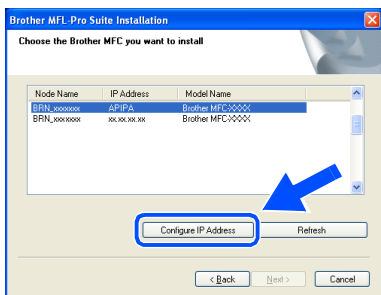

- 21 Enter the proper IP Address information for your network, and then click **OK**.

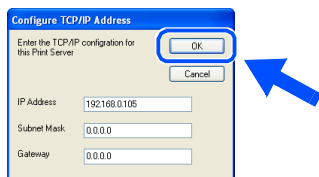

(e.g. Enter 192.168.0.105 for IP Address)

- 22 Click **Next**.

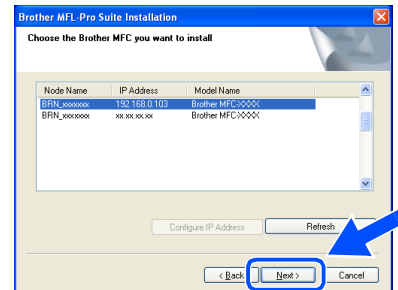

See the For Administrator section of this guide or the NC-9100h User's Guide located on the CD-ROM for more network configuration information.

Windows® 98/98SE/Me/2000/XP Users

→ **Go to** 23

Windows® 95/NT Users

→ **Go to** 26

- 23 Select yes and then click **Next** to configure Network Scanning.

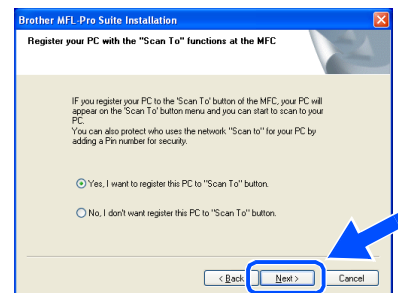

- 24 Click **Next** or enter the name you want displayed on the LCD for your PC and then click **Next**. The default name is the name of your PC.

You can avoid receiving unwanted documents by setting a 4-digit PIN Number.

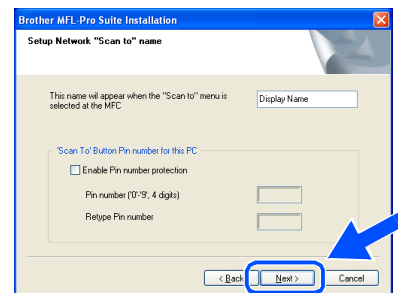

Please wait for the window to open.

- 25 The README file will be displayed. Please read this file for troubleshooting information and then close the file to continue installation.

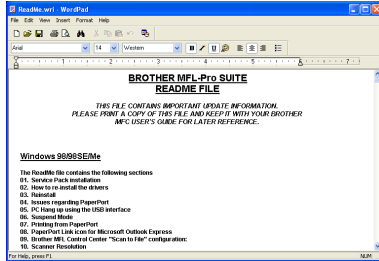

- 26 Check the **Run On-Line Registration** and then click **Next**.

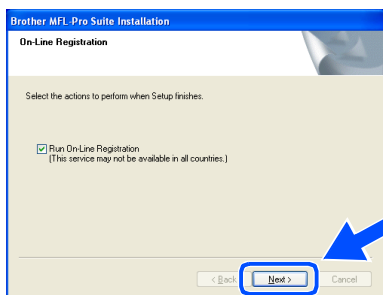

- 27 Click **Finish** to restart your computer.

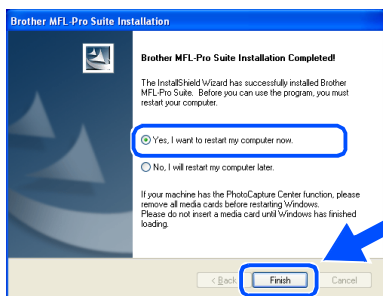

Windows® 95/98/98SE/Me/NT/2000 Users follow step 27.



The Network Scanning feature is not supported in Windows® 95 or NT.

- OK! For Windows® XP Users Only The Brother PC-FAX, Printer and Scanner drivers have been installed and the installation is now complete.

- 28 After the computer restarts, click **Yes** to have the Control Center load each time Windows® is started. The Control Center will appear as an icon in the task tray. If you click **No** the Scan key on the MFC will be disabled.

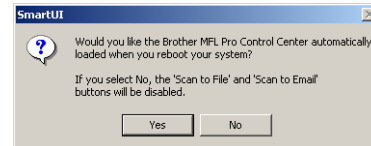

- If you checked the box in step 26, the screen for On-Line Registration will appear. Please complete your registration before proceeding to step 28.
- Even if you select **No**, you will be able to launch the Brother Control Center later to use the Scan key by double-clicking the Smart UI icon on the desktop. This loads the Brother Control Center to the task tray. See *AutoLoad the Brother Control Center*, Chapter 4 in the Documentation (Software User's Guide) located on the CD-ROM.

- OK! For Windows® 98/98SE/Me/2000 Users The Brother PC-FAX, Printer and Scanner drivers have been installed and the installation is now complete.

For Windows® 95/NT Users The Brother PC-FAX and Printer drivers have been installed and the installation is now complete.

For USB Interface Cable Users

For Mac OS[®] 8.6 to 9.2

Make sure that you have completed the instructions from Step 1 “Setting Up the Machine” on pages 4 - 11.

- 1 Switch off and unplug the MFC from the AC outlet and disconnect it from your Macintosh[®] if you already connected an interface cable.

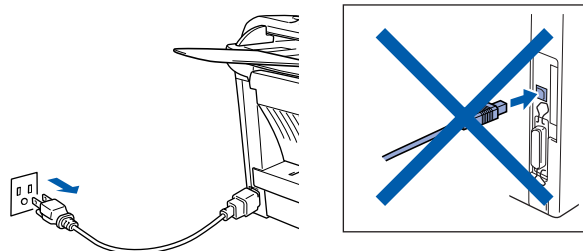

- 2 Turn on your Macintosh[®].
- 3 Insert the supplied CD-ROM for Macintosh[®] into your CD-ROM drive.



- 4 Double-click the **Start Here** icon to install the printer, scanner and PC-FAX Send drivers. If the language screen appears, select your language.

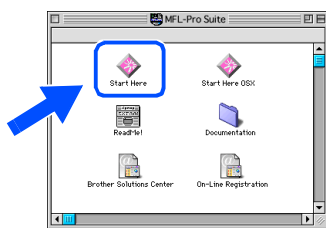

- 5 Click **Install** next to the MFL-Pro Suite for your country.

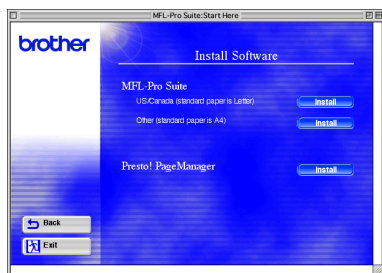

- 6 Follow the on-screen instructions, and restart your Macintosh[®].
- 7 Connect the USB interface cable to your Macintosh[®], and then connect it to the MFC.

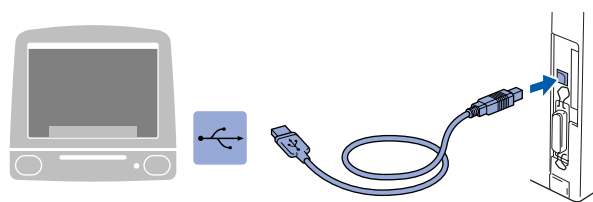

DO NOT connect the MFC to a **USB port on a keyboard or a non powered USB hub.**

- 8 Plug the MFC into the AC power outlet. Turn the power switch on.

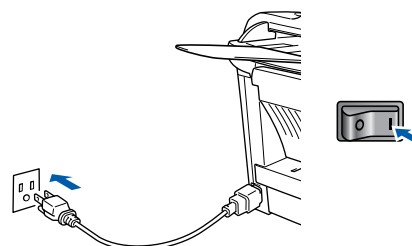

- 9 From the Apple[®] menu, open the **Chooser**.



- 10 Click the **Brother Laser** icon you installed. On the right side of the **Chooser**, select the printer to which you want to print. Close the **Chooser**.

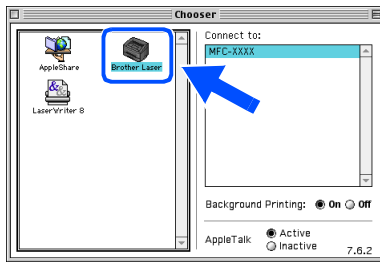

- OK! **The Brother PC-FAX Send, Printer and Scanner drivers have been installed.**

- 11 To install Presto!® PageManager®, click **Install** next to the Presto! PageManager icon and follow the on-screen instructions.

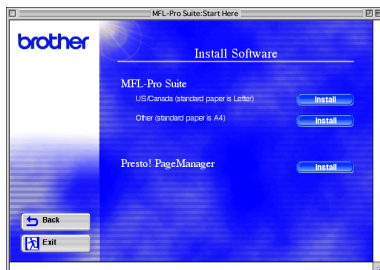

You can easily scan, share and organize photos and documents using Presto!® PageManager®.

- OK! **Presto!® PageManager® has been installed and the installation is now complete.**

For USB Interface Cable Users

For Mac OS[®] X 10.1/10.2.1 - 10.3 or greater

Make sure that you have completed the instructions from Step 1 “Setting Up the Machine” on pages 4 - 11.

- 1 Turn off and unplug the MFC from the AC outlet and disconnect it from your Macintosh[®] if you already connected an interface cable.

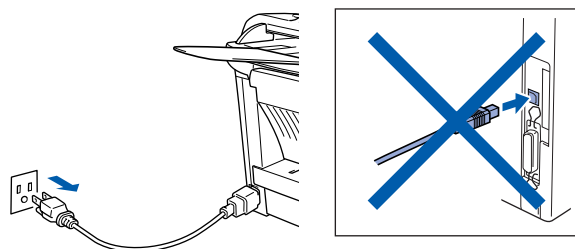

- 7 Connect the USB interface cable to your Macintosh[®], and then connect it to the MFC.

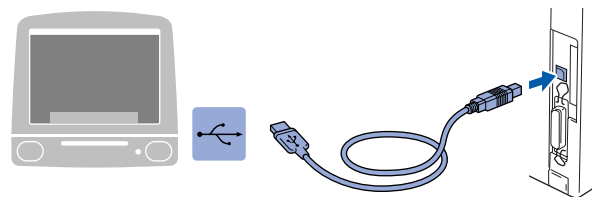

DO NOT connect the MFC to a USB port on a keyboard or a non powered USB hub.

- 2 Turn on your Macintosh[®].
- 3 Insert the supplied CD-ROM for Macintosh[®] into your CD-ROM drive.



- 4 Double-click the **Start Here OSX** icon to install the printer driver, Scanner driver, Brother PC-FAX Send and Remote Setup program. If the language screen appears, select your language (Scanning is not supported in Mac OS[®] 10.1).



- 8 Plug the MFC into the AC power outlet. Turn the power switch on.

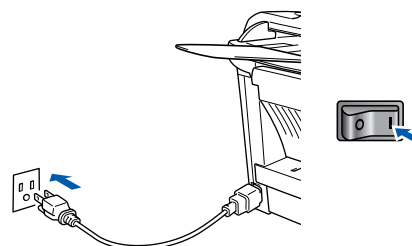

- 9 Select **Applications** from the **Go** menu.

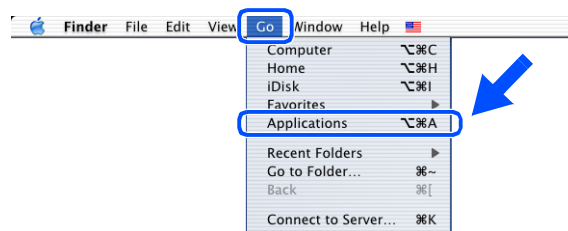

- 5 Click **Install** next to the MFL-Pro Suite.

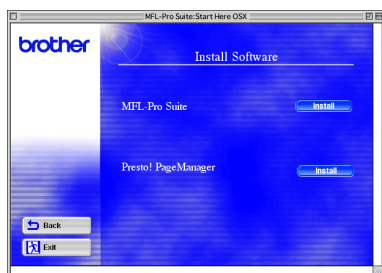

- 10 Open the **Utilities** folder.



- 6 Follow the on-screen instructions, and restart your Macintosh[®].

11 Open the **Print Center** icon.

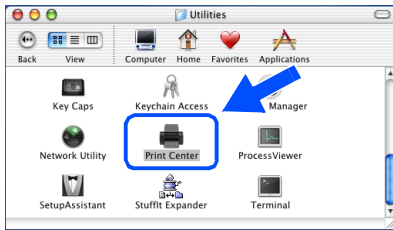

12 Click **Add Printer...**

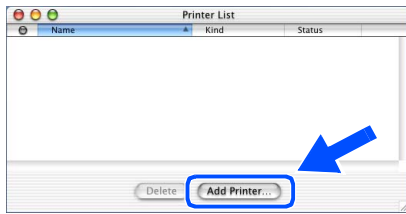

13 Select **USB**.

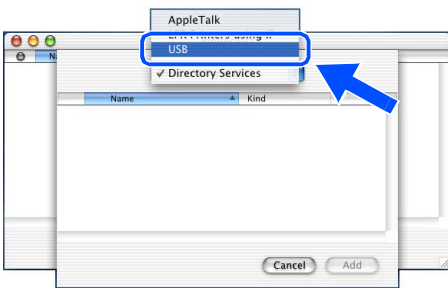

14 Select your machine, and then click **Add**.

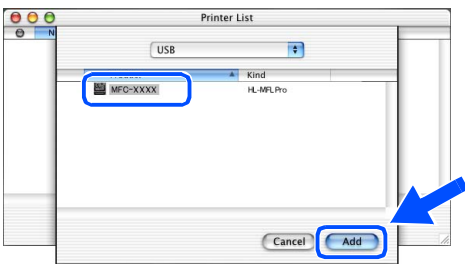

15 Select **Quit Print Center** from the **Print Center** menu.

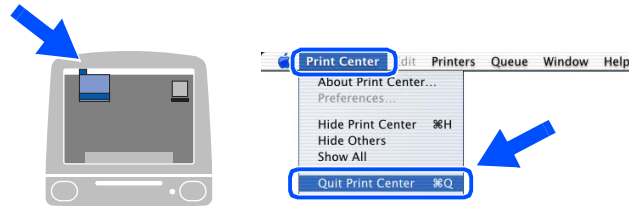

OK! The **Brother Printer driver, Scanner driver, Brother PC-FAX Send and Remote Setup Program** have been installed and the installation is now complete.



Scanning is not supported on Mac OS® 10.1

16 To install Presto!® PageManager®, click **Install** next to the Presto! PageManager icon and follow the on-screen instructions.

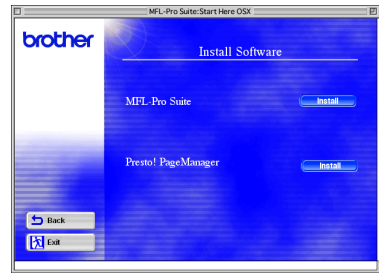

You can easily scan, share and organize photos and documents using Presto!® PageManager®.

OK! Presto!® PageManager® has been installed and the installation is now complete.

For Optional NC-9100h Network Interface Users

For Mac OS[®] 8.6 to 9.2

Make sure that you have completed the instructions from Step 1 "Setting Up the Machine" on pages 4 - 11.

- 1 Make sure that the NC-9100h (Network Print/Fax Server) is installed into the MFC. (See "Optional accessories" in Chapter 13 of the User's Guide.)
- 2 Turn off and unplug the MFC from the AC outlet and disconnect it from your Macintosh[®] if you already connected an interface cable.

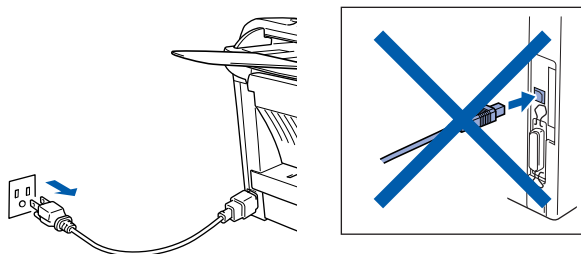

- 3 Turn on your Macintosh[®].
- 4 Insert the supplied CD-ROM for Macintosh[®] into your CD-ROM drive.



- 5 Double-click the **Start Here** icon to install the printer, scanner and PC-FAX Send drivers. If the language screen appears, select your language.

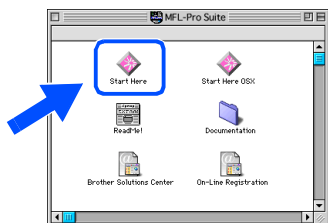

- 6 Click **Install** next to the MFL-Pro Suite for your country.



- 7 Follow the on-screen instructions, and restart your Macintosh[®].
- 8 Connect the network interface cable to the printer, and then connect it to a free port on your hub.

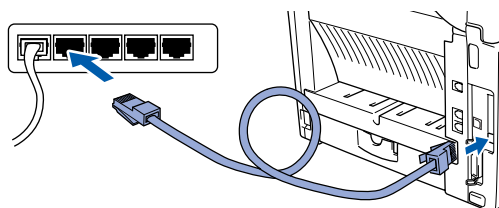

- 9 Plug the MFC into the AC power outlet. Turn the power switch on.

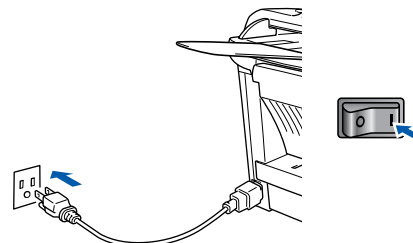

- 10 Open the **Chooser** from the **Apple** menu.



- 11 Click the **Brother Laser (AT)** icon, and then select **BRN_XXXXXX_P1**.
Click **Setup**.

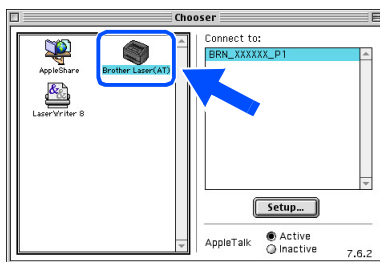

xxxxxx are the last six digits of the Ethernet address.

- 12 Select your model and click **OK**.
Close the **Chooser**.

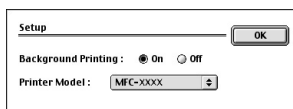

Network User's Guide Chapter 7 on the CD-ROM.

- OK!** The setup is now complete.

For Optional NC-9100h Network Interface Users

For Mac OS[®] X 10.1/10.2.1 - 10.3 or greater

Make sure that you have completed the instructions from Step 1 "Setting Up the Machine" on pages 4 - 11.

- 1 Make sure that the NC-9100h (Network Print/Fax Server) is installed into the MFC. (See "Optional accessories" in Chapter 13 of the User's Guide.)
- 2 Turn off and unplug the MFC from the AC outlet and disconnect it from your Macintosh[®] if you already connected an interface cable.

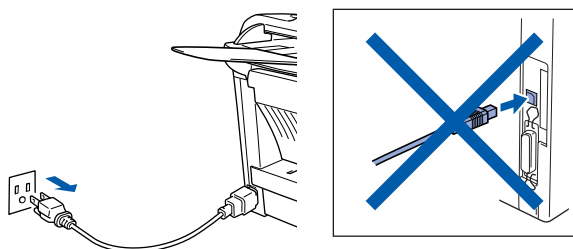

- 3 Turn on your Macintosh[®].
- 4 Insert the supplied CD-ROM for Macintosh[®] into your CD-ROM drive.



- 5 Double-click the **Start Here OSX** folder to install the printer driver and Remote Setup program. If the language screen appears, select your language.



- 6 Click **Install** next to the MFL-Pro Suite.

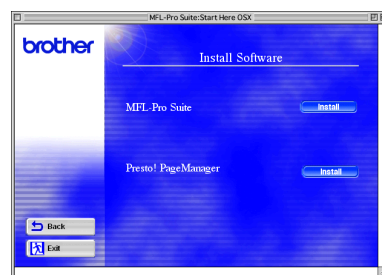

- 7 Follow the on-screen instructions, and restart your Macintosh[®].
- 8 Connect the network interface cable to the printer, and then connect it to a free port on your hub.

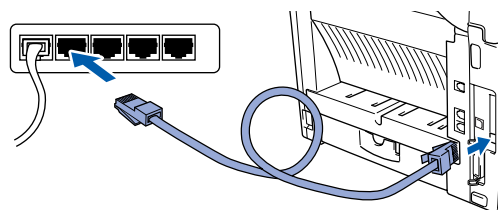

- 9 Plug the MFC into the AC power outlet. Turn the power switch on.

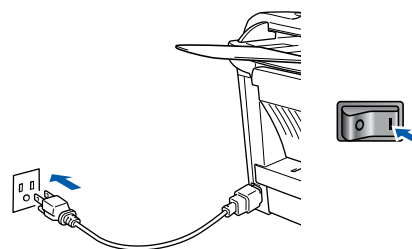

- 10 Select **Applications** from the **Go** menu.

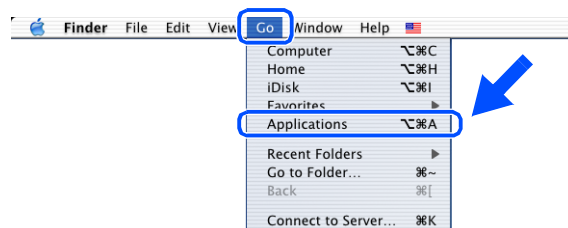

11 Open the **Utilities** folder.

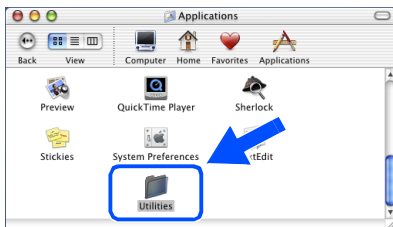

12 Open the **Print Center** icon.

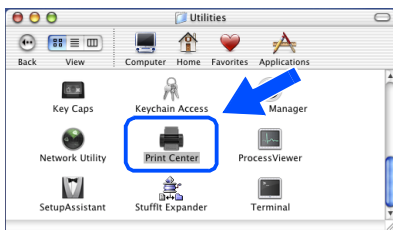

13 Click the **Add Printer...** button.

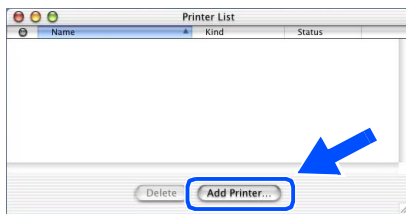

14 Select **AppleTalk**.

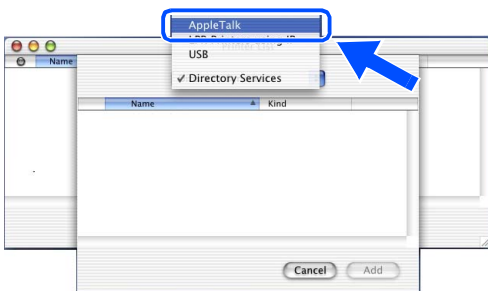

15 Select **BRN_XXXXXX_P1**, and then click the **Add** button.

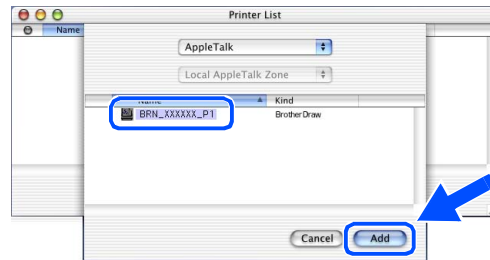

 xxxxxx are the last six digits of the Ethernet address.

 Network User's Guide Chapter 7 on the CD-ROM.

16 Select **Quit Print Center** from the **Print Center** menu.

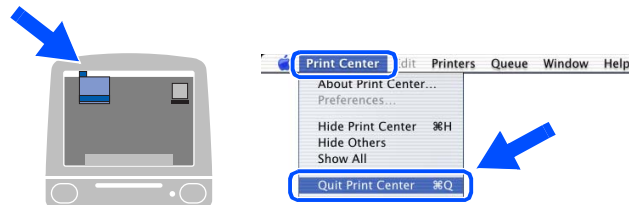

OK! The setup is now complete.

 For users of Mac OS® 10.2.2 or greater Please see Network User's Guide Chapter 7 on the CD-ROM for information about using Simple Network Configuration.

■ For Administrators

This section is for using the printer on a network with the optional NC-9100h. An administrator should set up the printer using the following steps.

Network User's Guide Chapter Map (NC-9100h)

Windows®



Macintosh®

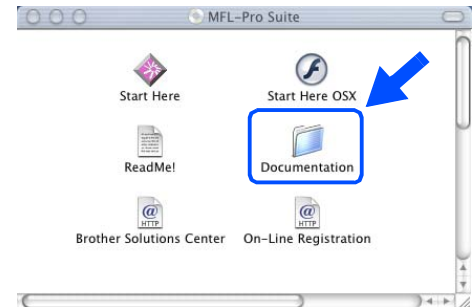

Windows® 95/98/Me	Peer-to-Peer	TCP/IP	Chapter 3	Peer-to-Peer Printing
		NetBIOS	Chapter 4	NetBIOS Peer-to-Peer Printing
	Brother Internet Print	TCP/IP	Chapter 5	Configuring Internet Print for Windows®
	Netware	IPX/SPX	Chapter 6	Novell Netware Printing
Windows NT®	Peer-to-Peer	TCP/IP	Chapter 2	TCP/IP Printing
		NetBIOS	Chapter 4	NetBIOS Peer-to-Peer Printing
		DLC/LLC	Chapter 8	DLC Printing
	Brother Internet Print (NT® 4.0 only)	TCP/IP	Chapter 5	Configuring Internet Print for Windows®
Netware	IPX/SPX	Chapter 6	Novell Netware Printing	
Windows® 2000/XP	Peer-to-Peer (Windows® 2000 only)	TCP/IP	Chapter 2	TCP/IP Printing
		NetBIOS	Chapter 4	NetBIOS Peer-to-Peer Printing
		DLC/LLC	Chapter 8	DLC Printing
	IPP (Internet Printing Protocol)	TCP/IP	Chapter 2	TCP/IP Printing
	Brother Internet Print	TCP/IP	Chapter 5	Configuring Internet Print for Windows®
Netware	IPX/SPX	Chapter 6	Novell Netware Printing	
UNIX/Linux		TCP/IP	Chapter 1	UNIX Printing
Macintosh®		AppleTalk	Chapter 7	Apple talk (Ether Talk TCP/IP Printing)
		TCP/IP	Chapter 7	Apple talk (Ether Talk TCP/IP Printing)
		Simple Network Configuration	Chapter 7	Simple Network Configuration
OS2 Warp Server LAN Server		TCP/IP	Chapter 2	TCP/IP Printing
		NetBIOS	Chapter 4	NetBIOS Peer-to-Peer Printing

Installing the BRAdmin Professional Configuration Utility (Windows® Users Only)

The BRAdmin Professional software utility is designed to manage your Brother network connected devices such as network-ready printers and/or network-ready Multifunction devices in a Local Area Network (LAN) environment.

BRAdmin Professional can also be used to manage devices from other manufacturers whose products support SNMP (Simple Network Management Protocol).

For more information on BRAdmin Professional go to <http://solutions.brother.com>

- 1 Insert the supplied CD-ROM for Windows® into your CD-ROM drive. The opening screen will appear automatically. Follow the on-screen instructions.
- 3 Click **Network Applications for Optional NC-9100h**.



- 2 Click the **Install Software** icon on the menu screen.



- 4 Click **BRAdmin Professional** and follow the on-screen instructions.

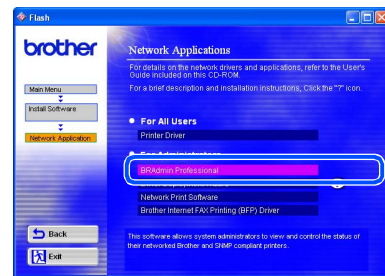

The default password for the print server is **"access"**.
You can use BRAdmin Professional or a web browser to change this password.

Web BRAdmin

Brother has also developed Web BRAdmin, an enterprise network software utility that enables management of Brother and other SNMP compliant devices in larger LAN/WAN environments.

This software is Web server based and requires the installation of Microsoft's Internet Information Server and Sun's Java client software. To learn more about the Web BRAdmin software or to download it, please go to <http://solutions.brother.com/webbradmin>

Setting Up
the Machine

Windows®
USB

Windows®
Parallel

Windows
NT® 4.0
Parallel

Windows®
Network

Macintosh®
USB

Macintosh®
Network

For
Administrators

Setting your IP Address, Subnet Mask and Gateway using BRAdmin Professional (Windows® Users Only)

- 1 Start BRAdmin Professional, and select **TCP/IP**.

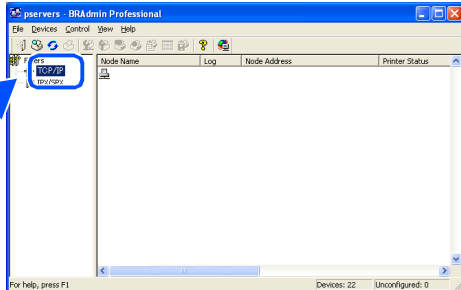

- 2 Select **Search Active Devices** from the **Devices** menu. BRAdmin will search for new devices automatically.

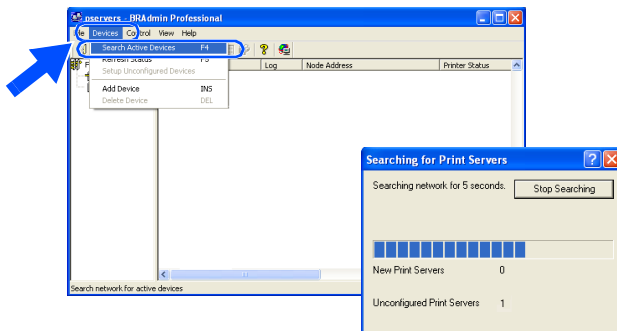

- 3 Double-click the new device.

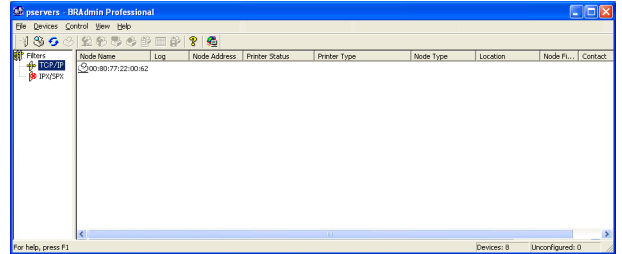

- 4 Enter the **IP Address**, **Subnet Mask** and **Gateway**, and then click the **OK** button.

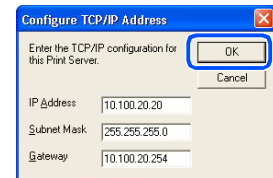

- 5 The address information will be saved to the printer.



The default password for the print server is **"access"**. You can use BRAdmin Professional or a web browser to change this password.

Options

The MFC has the following optional accessories. You can expand the capabilities of the MFC by adding these items.

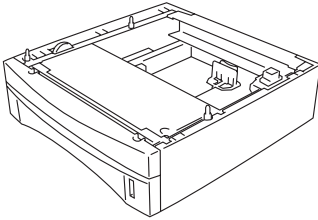
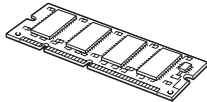
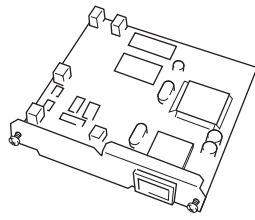
Lower Tray Unit	DIMM Memory	Network Print/Fax Server
LT-5000		NC-9100h
 <p>Second lower paper tray expands total input capacity by another 250 sheets to a total input capacity of 500 sheets.</p>	 <p>For more details, see "Memory Board" in Chapter 13 of the User's Guide.</p>	 <p>The optional Network Print/FAX Server (NC-9100h) transforms your MFC into a Network Multi Function Center, offering Network Printing / Network PC-FAX send and Network Scanning capability.</p>

Replacement Consumables

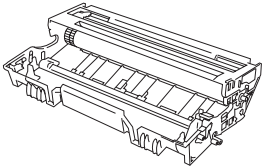
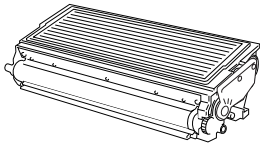
Drum Unit	Toner
DR-510	TN-540/TN-570
 <p>Up to 20,000 Letter pages @ 5% coverage.</p>	 <p>TN-540: Up to 3,500 Letter pages @ 5% coverage. TN-570: Up to 6,700 Letter pages @ 5% coverage.</p>

Trademarks

The Brother logo is a registered trademark of Brother Industries, Ltd.

Brother is a registered trademark of Brother Industries, Ltd.

Multi-Function Link is a registered trademark of Brother International Corporation.

© Copyright 2004 Brother Industries, Ltd. All rights reserved.

Windows, Microsoft and Windows NT are registered trademarks of Microsoft in the U.S. and other countries.

Macintosh, QuickDraw, iMac and iBook are trademarks or registered trademarks of Apple Computer, Inc.

PostScript and PostScript Level 3 are registered trademarks or trademarks of Adobe Systems Incorporated.

PaperPort and TextBridge are registered trademarks of ScanSoft, Inc.

Presto! PageManager is a registered trademark of NewSoft Technology Corporation.

Each company whose software title is mentioned in this manual has a Software License Agreement specific to its proprietary programs.

All other brand and product names mentioned in this manual are registered trademarks of their respective companies.

Compilation and Publication

Under the supervision of Brother Industries Ltd., this manual has been compiled and published, covering the latest product descriptions and specifications.

The contents of this manual and the specifications of this product are subject to change without notice.

Brother reserves the right to make changes without notice in the specifications and materials contained herein and shall not be responsible for any damages (including consequential) caused by reliance on the materials presented, including but not limited to typographical and other errors relating to the publication.

This product is designed for use in a Professional Environment.

brother[®]