

Setting Up the machine and PC to Work Together

Before You begin

- Please see the README.WRI file in the root directory of the CD-ROM for the latest important installation and troubleshooting information.
- If you have any problems with this installation, visit us at <http://solutions.brother.com> and view the FAQ's for your machine.
- Please purchase the appropriate interface cable you intend to use with this machine (parallel or USB).
- Some illustrations are based on the MFC-8500.

 Use only a shielded parallel interface cable that is IEEE 1284-compliant and/or a USB cable that is no longer than 6 feet long (1.8 meters).

You must set up the hardware and install the driver before you can use your machine as a printer and scanner with your applications.

Step 1. Shut down and turn OFF your computer.

Step 2. Unplug the FAX/MFC machine from the AC outlet and disconnect the interface cable if you have already connected it.

Step 3. Turn on your computer.

Note: If the "Found New Hardware Wizard" appears before the installation of the software, you should click on Cancel to exit the Wizard, and then start the installation program from the CD-ROM.

Step 4.  Insert the CD-ROM into the CD-ROM drive. If the model name screen appears, click on your model name. The CD-ROM main menu will appear. If the CD-ROM does NOT start automatically, start the installer application by clicking Start, Run, then type x:\setup.exe (where x:\ is the drive letter of your CD-ROM drive).



1. Click Install Software.

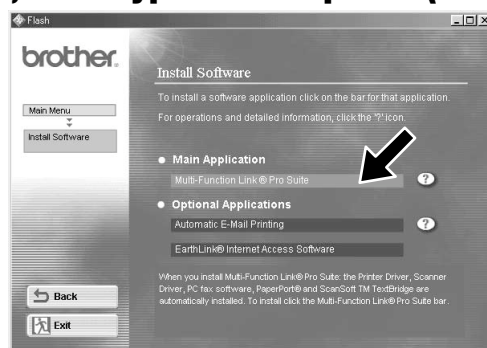

2. Click Multi-Function Link® Pro Suite in Main Application. *1

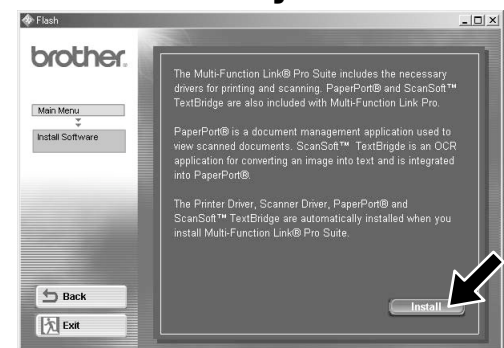

3. Click Install.

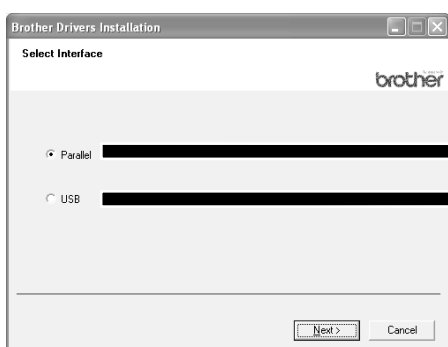

4. Select an interface cable, and then press Next.

For Parallel

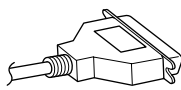

For USB

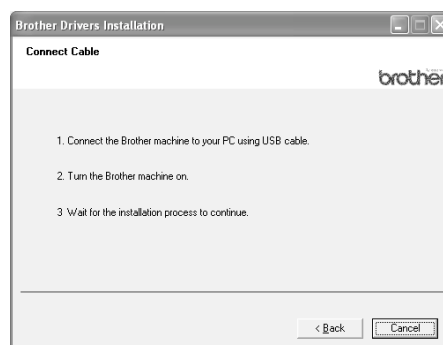
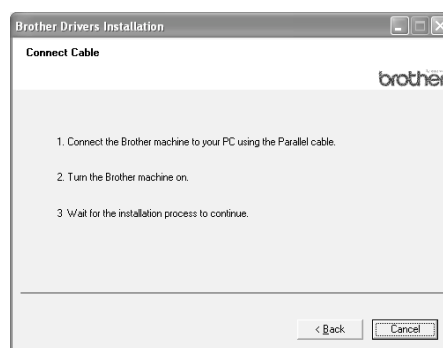
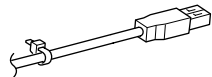

Step 5. Connect the machine to your PC using the parallel or USB cable.

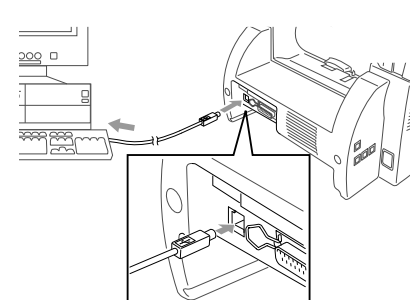
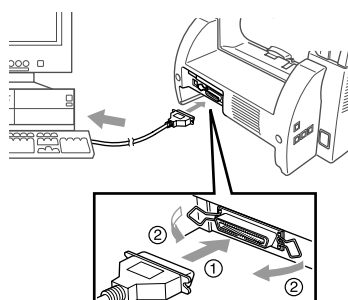

Please see STEP 6

*1 Multi-Function Link® Pro Suite includes Printer Driver, Scanner Driver, PC-FAX software and Remote Setup.
Scanner resolution: Up to 600 dpi
Paper size: 8.5" (215.9 mm) × 11.7" (297 mm)

Step 6.

Turn on the machine by plugging in the power cord (and if necessary switch on the machine power switch).

The installation of the Brother drivers will start automatically.

Step 7.

Follow the instructions on the screen.

Note: If you are installing a DCP model, installation is complete.

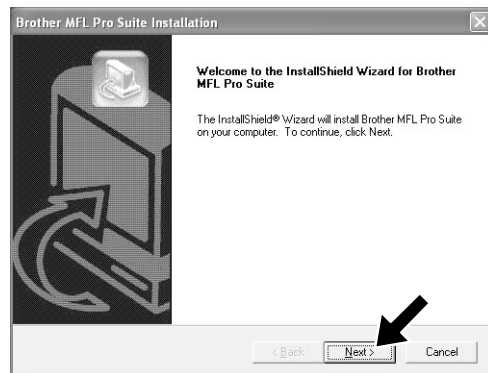

1. When the above screen appears, click **Next** to start the PC-FAX and Remote Setup Installation Program.

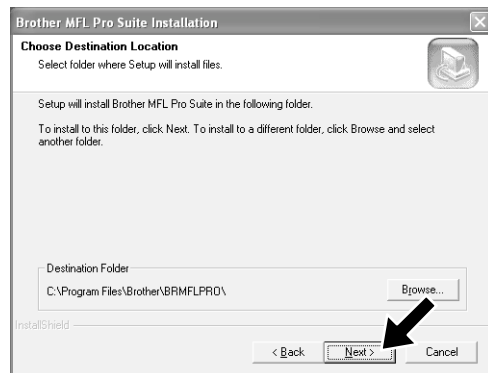

2. Select the folder where Setup will install the program files. If you do not wish to use the default directory, click the **Browse** button to select a new folder and then click **Next** to continue.

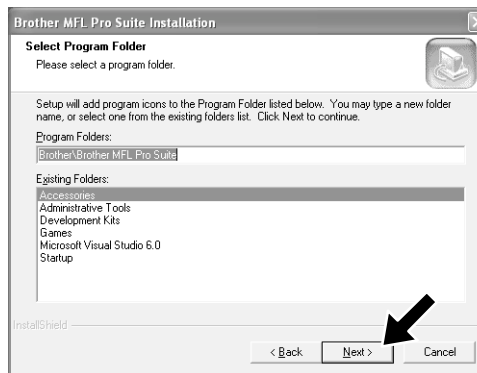

3. Select the program folder in which you wish to add the program icons, and then click **Next**.

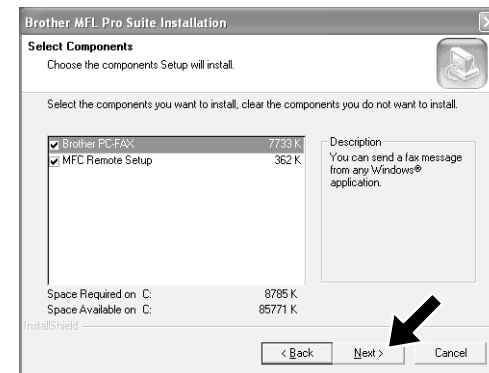

4. If this screen appears, select the components to install (the default gives you the most functionality), and then click **Next**.

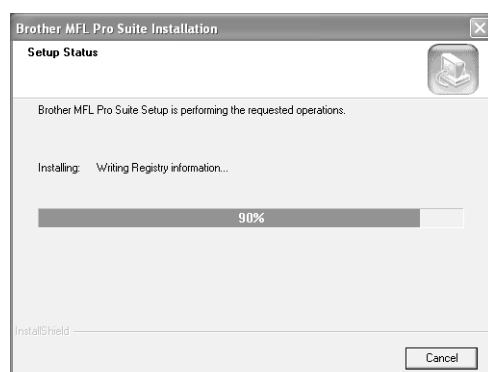

5. The installation process will now start.

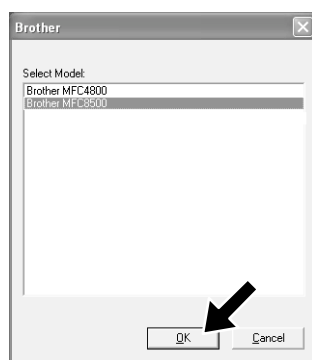

6. If this screen appears, select the model of the machine which you want to use to send PC-Faxes then click **OK**.



7. Select "Yes" to restart your computer, and then click **Finish**.



If you want to install the printer driver with the full capability, follow these instructions.

- * If you are using Windows XP Professional, Click on **Start** → **Printer and Faxes** → **Add a printer**.

- * If you are using Windows XP Home Edition, Click on **Start** → **Control Panel** → **Printer and other hardware** → **Printer and Faxes** → **Add a printer**.

1. Click on **Next**.
2. Check of **Automatically detect and install my plug and play printer**, and select **Local printer attached to this computer**.
3. Click on **Next**.
4. Select the printer port and click on **Next**.
5. Click on **Have Disk** and click on **Browse**.
6. Open the directory X:\WXP\ADDPRT.
7. Click on **OK**.
8. Follow the screen.

NOTE: Warning message might be appeared, and click on **Continue Anyway**.

What is included on the CD-ROM

You can get a variety of information from this CD-ROM



Install Software

You can install printer and scanner drivers and the various utility items.

On-Line Registration

You will be guided to a directory on the Brother Product Registration Web page.

On-Line Documentation

View the Owner's Manual and other documentation.

Brother Support

Get all the help and support you may need from our Customer Service Department, or Brother Authorized Service Center.

Help

Helpful hints.

Trademarks

The Brother logo and Multi-Function Link Pro are registered trademarks of Brother Industries, Ltd.

© Copyright 2002 Brother Industries, Ltd. All rights reserved.

Windows and Microsoft are registered trademarks of Microsoft in the U.S. and other countries.