

THANK YOU!

... FOR PURCHASING YOUR BROTHER MACHINE.
WE ARE SURE YOU WILL BE IMPRESSED WITH THE CONVENIENT WAY THAT
YOUR NEW MACHINE PERFORMS SO MANY TASKS WITH GREAT RESULTS!

Follow these simple instructions in numerical order.

For greater detail, consult your Owner's Manual and CD-ROM.

Alternatively, if you cannot solve a problem:
Refer to **Frequently Asked Questions (FAQ's)** on Brother Solutions Web Site:

URL: <http://solutions.brother.com>

Call Brother Customer Service at: 0161 931 2354

1 Packing List

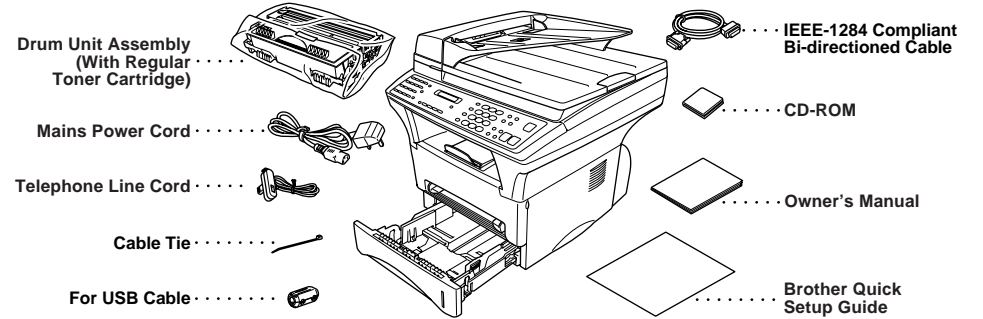

Keep the packing materials for possible future transport. If you do not pack the machine properly, it may void your warranty.

2 Install the Drum Unit

A. Unpack the drum unit assembly, and gently rock it from side to side five or six times to distribute the toner evenly inside the cartridge.

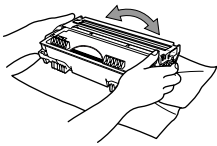

To prevent damage to the drum, do not expose it to light for longer than a few minutes.

B. Remove the protective part.

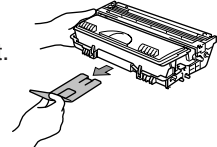

C. Open the front cover of the machine.

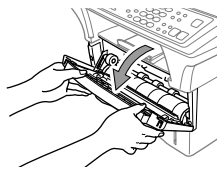

D. Insert the drum unit assembly into the machine.

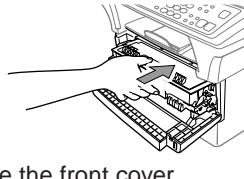

E. Close the front cover.

3 Release the Scanner Lock

Move the lever to the Unlock position as in the diagram below. Please note the location of the Blue Scanner Lock Lever from the diagram.

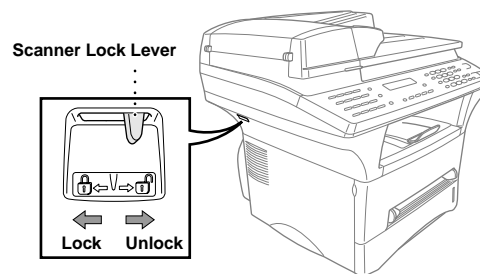

If CHECK SCAN LOCK appears on the LCD, check the lever is fully in the unlock position and press **Stop/Exit**.

4 How to connect the Optional Paper Tray

A. Carefully pick up the machine and place it on top of the Optional Paper Tray (Lower Tray).

B. Plug the modular cable from the Lower Tray into the modular jack on the machine.

To select which tray will be used for faxes or for copies, see *Lower Tray (With Optional Paper Tray Only)* in the Owner's Manual and for printer setting, see *Paper Source* in the Owner's Manual on the CD-ROM.

If you move the machine after connecting the Lower Tray, be sure to carefully lift the Lower Tray with the machine because they are not fixed together.

5 Load Paper

A. Pull the paper cassette completely out of the machine.

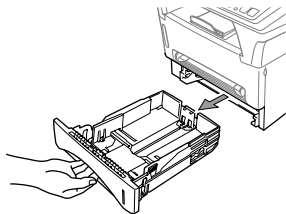

B. Adjust the paper guides at the right and rear of the paper cassette for the paper size you want.

C. Load paper in the paper cassette. Press down on the paper to flatten it in all four corners, keeping the paper level below the guide.

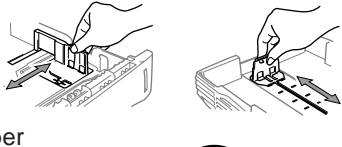

D. Slide the paper cassette into the machine until it locks into place.



6 Install Mains Power Cord and Telephone Line Cord

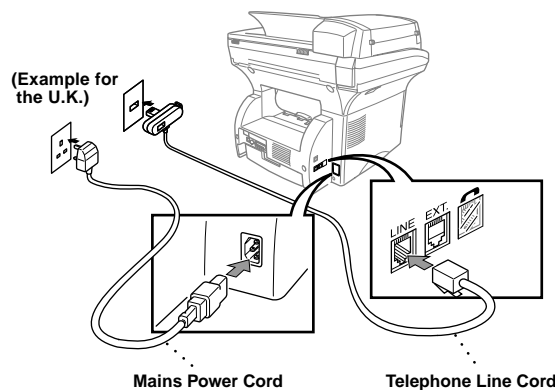

Complete reading this guide before connecting the Parallel or USB cables.

7 Sharing a Single Line with a Telephone Answering Device (TAD) or an External Telephone

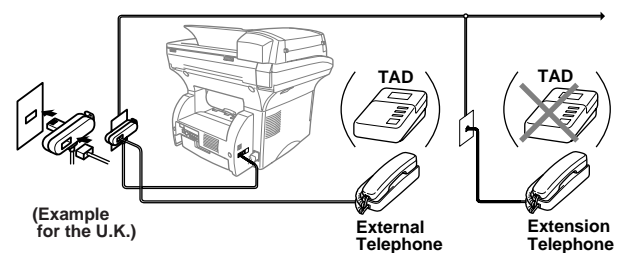

Note: If you are using an external answering machine, "TAD" should be selected as the receive mode in Step 8.

8 Selecting Receive Mode

Choose the mode that best suits your needs by pressing **Receive Mode** repeatedly until the screen displays the setting you want to use.

100% FAX ONLY AUTO

For use with a dedicated fax line.
Every call is answered as a fax.

100% FAX/TEL AUTO (with an External Telephone)

For receiving fax and voice calls on one line.
The machine will automatically receive Faxes. If the call is a voice call, the machine will pseudo ring to alert you to pick up the phone.

TAD: ANSWER MACH. 100% AUTO (with an External Answering Machine)

For use with an external answering device.
The TAD answers every call and stores voice messages.
Fax messages are printed.

100% MANUAL AUTO (with an External Telephone)

You control the phone line and must answer every call yourself.
For more details, see *Receive Mode Settings* in Owner's Manual.

9 Set Date and Time

A. Press **Menu**, (1), (1).

1. DATE/TIME
YEAR: XX
ENTER & SET KEY

B. Enter the last two digits of the year and press **Set**.

MONTH: XX
ENTER & SET KEY

C. Enter two digits for the month and press **Set**.

DAY: XX
ENTER & SET KEY

D. Enter two digits for the day and press **Set**.

TIME: XX:XX
ENTER & SET KEY

E. Enter the time in 24-hour format and press **Set**.

F. Press **Stop/Exit**.

Note: If you can't step forward, press **Stop/Exit** and repeat from Step A.

10 Set Station ID

A. Press **Menu**, (1), (2).

2. STATION ID
FAX:
ENTER & SET KEY

B. Enter your fax number, then press **Set**.

TEL:
ENTER & SET KEY

C. Enter your telephone number, then press **Set**.

NAME:
ENTER & SET KEY

D. Enter your name using the dial pad and the chart below, then press **Set**. Press **Space** twice to create blank space.

E. Press **Stop/Exit**.

For more details, see *Entering Text* in Owner's Manual.

Press Key	once	twice	three times	four times	five times
2	A	B	C	2	A
3	D	E	F	3	D
4	G	H	I	4	G
5	J	K	L	5	J
6	M	N	O	6	M
7	P	Q	R	7	P
8	T	U	V	8	T
9	W	X	Y	Z	9

Note: If you can't step forward, press **Stop/Exit** and repeat from Step A.

Setting Up the MFC and PC to Work Together

Before You begin

- You must set up the hardware and install the Brother Drivers before you can use your MFC as a printer and scanner in any Windows® application.
- Please purchase the appropriate cable if you intend to use USB.

! Use only a shielded parallel interface cable that is IEEE 1284-compliant and/or a USB cable that is no longer than 6 feet long (1.8 meters).

Follow the instructions in this guide for your operating system and interface.

For Windows® 95/98/98SE/Me/2000 Users

Step 1. Unplug the MFC from the AC outlet and disconnect your MFC from your computer if you have already connected an interface cable.

Step 2. Turn on your computer.

For Windows® 2000 Professional, you must be logged on as the Administrator.

Step 3. Insert the CD-ROM into the CD-ROM drive.

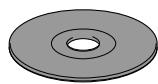

- Insert the MFC Software Suite CD-ROM into your CD-ROM drive.
- Click your language. The CD-ROM main menu will appear.
(If any window does not appear after you insert the CD-ROM into the CD-ROM drive, use Windows® Explorer to run the setup.exe program from the root directory of the Brother CD-ROM.)



3. Click **Install Software**.



4. Click **MFC Software Suite** in **Main Application**. Please see Note *1.

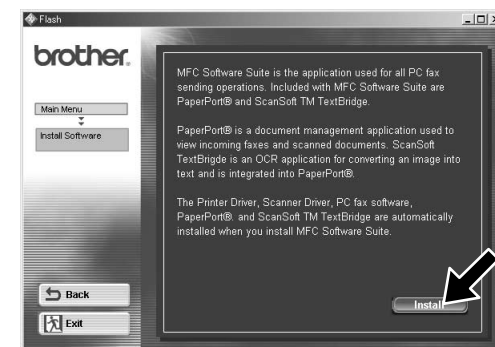

5. Click **Install**.

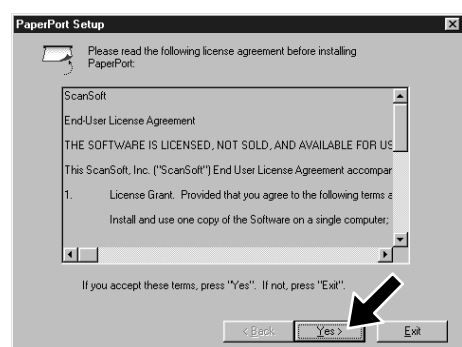

6. The InstallShield Wizard Setup window will appear briefly, followed by the PaperPort® Setup window. Click **Yes**.

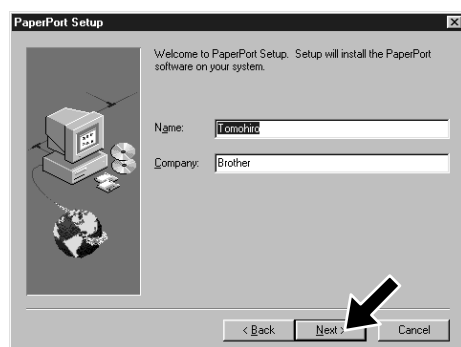

7. When the PaperPort® Setup window displays your Name and Company, either change or accept them, and then click **Next**.

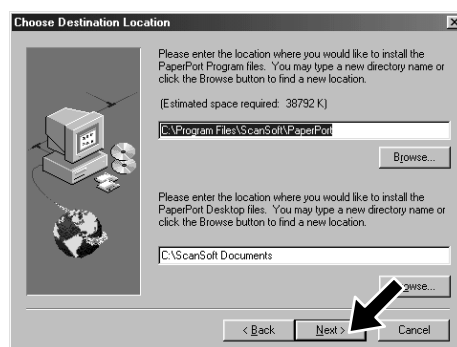

8. When the Choose Destination Location window displays the path where the PaperPort® files will be installed, either change or accept, and then click **Next**.



9. When the Register Today screen appears, click **Next**. This is registration for Paper Port®. Follow the instructions.

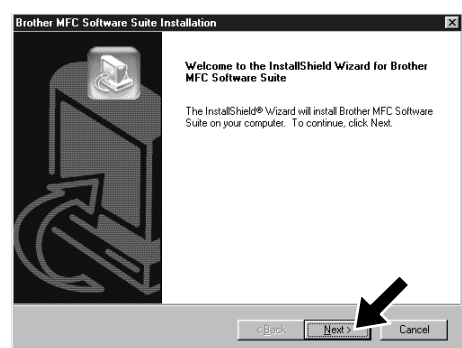

10. When the MFC Software Suite Installation window appears, click **Next** to begin installing the MFC Software Suite. Please see Note *2.

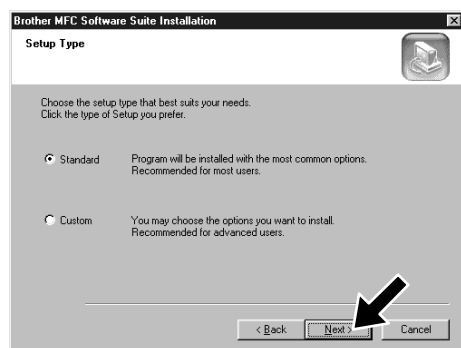

11. When the Setup Type window appears, select **Standard**, and then click **Next**. The application files will be copied to your computer.

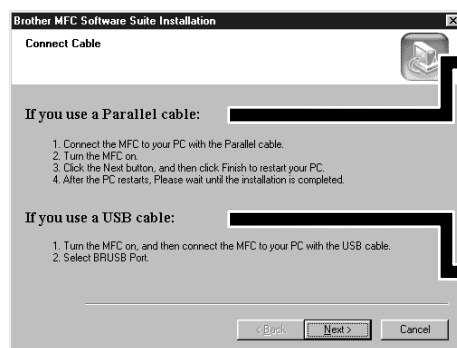

12. The Connect Cable window will appear.

For Parallel

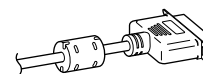

For USB

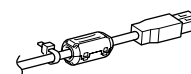

Please see **NEXT PAGE**

*1 MFC Software Suite includes Printer Driver, Scanner Driver, ScanSoft™ PaperPort®, ScanSoft™ Text Bridge®, PC-FAX software, Remote Setup and True Type fonts. PaperPort® is a document management application for viewing scanned documents. ScanSoft™ TextBridge®, which is integrated into PaperPort®, is an OCR application that converts an image into text and inserts it into your default word processor package.

*2 If an error message appears during the installation process, or you have previously installed MFC Software Suite or MFL Pro, you will first have to uninstall it. From the **Start** menu, select **Programs, Brother, Brother MFL Pro, Uninstall**, and then follow the instructions on the screen.

*3 Even if you select **NO**, later you will be able to launch the Brother Control Centre to use the Scan keys. See *AutoLoad the Brother Control Centre*, Chapter 13 in the Owner's Manual on the CD-ROM.



Step 4. Connect the MFC to your PC with Parallel Cable.

- A. Connect the parallel interface cable to the parallel interface port of the MFC and secure the wire clips.
- B. Connect the interface cable to the printer port of the computer and secure it with the two screws. For the location of your computer's parallel printer port, see the User's Guide for your computer.

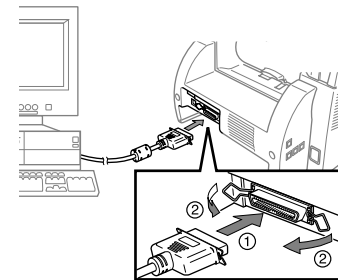

Step 5. Turn on the MFC by plugging in the power cord.

Step 6. The installation of the Brother driver will automatically start. Follow the instructions on the screen.

(For Windows® 95/98/98SE/Me Users)		(For Windows® 2000 Professional User)	
1. In the Connect Cable window, click Next .	2. When the above screen appears, click Finish and wait as the PC restarts Windows® and continues the installation.	1. In the Connect Cable window, click Next .	2. When the above screen appears, Click Finish and wait as the PC restarts Windows® and continues the installation.
3. Click Yes to have the Control Centre loaded each time Windows® is started. The Control Centre will appear as an icon in the task tray. If you click No the Scan keys on the MFC will be disabled. Please see Note *3.		3. When the Digital Signature Not Found dialog boxes appear, click Yes to install the driver.	4. Click Yes to have the Control Centre loaded each time Windows® is started. The Control Centre will appear as an icon in the task tray. If you click No the Scan keys on the MFC will be disabled. Please see Note *3.
The Brother PC fax, Printer and Scanner drivers have been installed and the installation is now complete.		The Brother PC fax, Printer and Scanner drivers have been installed and the installation is now complete.	

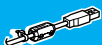

Step 4. Turn on the MFC by plugging in the power cord.

Step 5. Connect the Filter Core and Cable Tie to the USB cable, and then connect the MFC to your PC with the USB cable. (It will take a few seconds for the installation screen to appear.)

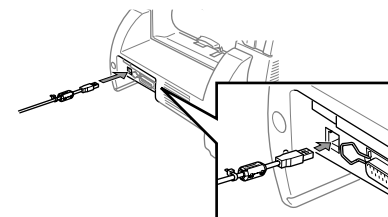

Step 6. The installation of the Brother driver will automatically start. Follow the instructions on the screen.

(For Windows® 98/98SE/Me Users)			(For Windows® 2000 Users)
1. In the Add Printer Wizard window, select BRUSB: USB Printer Port , and then click Next .	2. Accept the default Printer name by selecting Yes , and then click Next .	3. Select Yes (recommended) , and then click Finish . A test page will be printed so you can check the print quality.	1. When the Digital Signature Not Found dialog boxes appear, click Yes to install the driver.
4. If the test page is printed correctly, click Yes . If you click No , follow the prompts on the screen to correct the problem.	5. Select Yes to restart your computer, and then click Finish .	6. Click Yes to have the Control Centre loaded each time Windows® is started. The Control Centre will appear as an icon in the task tray. If you click No the Scan keys on the MFC will be disabled. Please see Note *3.	2. Select Finish to restart your computer.
The Brother PC fax, Printer and Scanner drivers have been installed and the installation is now complete.			The Brother PC fax, Printer and Scanner drivers have been installed and the installation is now complete.

For Windows NT® Workstation Version 4.0 Users

Step 1. Check that your computer is turned on.

You must be logged on as the Administrator.

Step 2. Connect the MFC to your PC with the Parallel Cable.

- Connect the parallel interface cable to the parallel interface port of the MFC and secure the wire clips.
- Connect the interface cable to the printer port of the computer and secure it with the two screws. For the location of your computer's parallel printer port, see the User's Guide for your computer.

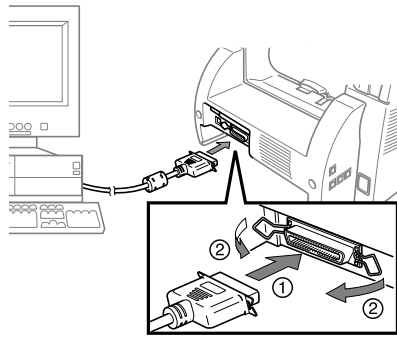

Step 3. Turn on the MFC by plugging in the power cord.

Step 4. Follow the instructions on the screen.

(Same step as Windows 95/98/98SE/Me/2000 Users **Step 3.**, 1-11)

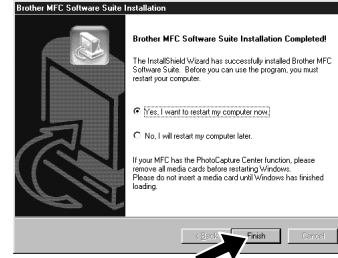

- Select **Yes** to restart your computer, and then click **Finish**.

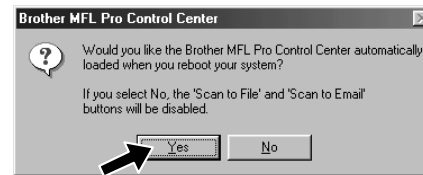

- Click **Yes** to have the Control Centre loaded each time Windows is started. The Control Centre will appear as an icon in the task bar. If you click **No**, the Scan keys on the MFC will be disabled. Please see Note *3.

The Brother PC fax, Printer and Scanner drivers have been installed and the installation is now complete.

For Apple® Macintosh® QuickDraw® Driver for OS 8.6/9.0/9.0.4/9.1 Users

Step 1. Make sure your MFC power cord is unplugged and your Macintosh is turned on.

- Make sure you do NOT connect your MFC to your Macintosh

Step 2. Insert the CD-ROM into your CD-ROM drive.

Installing MFC Software Suite



- When the window appears, double-click **MFC Software Suite Installer**.

Select your language

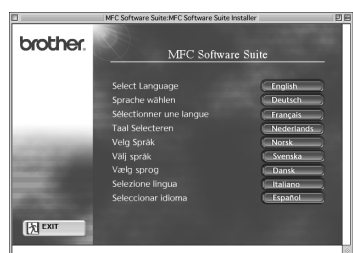

- Click your language to install the printer and scanner drivers. After the installation is completed, the screen prompts you to restart your Macintosh.

Step 3. Restart your Macintosh so it can recognize the new driver.

Step 4. Connect the Filter Core and Cable Tie to the USB cable.

Step 5. Connect the MFC to your Macintosh with the USB cable, and then turn on the MFC by plugging in the power cord.

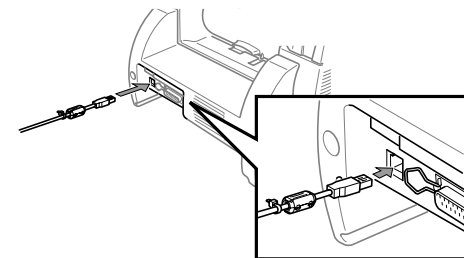

Step 6. Select the Printer.

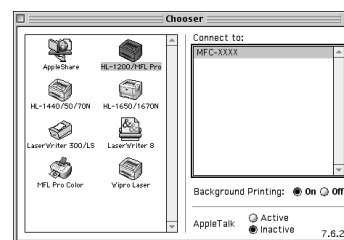

- From the Apple menu, open the **Chooser**.
- Click to highlight the printer driver icon you installed. On the right side of the **Chooser**, select the printer to which you want to print. Close the **Chooser**.

The Brother PC fax, Printer and Scanner drivers have been installed and the installation is now complete.

What is included on the CD-ROM

Windows®

You can get a variety of information from this CD-ROM



(For Windows®)

Install Software

You can install printer and scanner drivers and the various utility items.

Manuals

View the Owner's Manual and other documentation.

Brother Solutions Centre

Connect to the Brother Solutions Centre, the Service and Support Web Site for your Brother Product.

Further information

Interactive Demonstration showing features of the Printer Driver.

Macintosh®

You can get a variety of information from this CD-ROM

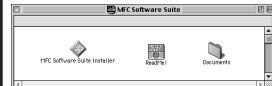

(For Macintosh®)

MFC Software Suite Installer

You can install the printer and scanner drivers and the various utility items.

ReadMe!

You can get important information and troubleshooting tips.

Documents

View the Owner's Manual and other documentation.