

Before you can use the MFC, you must set up the hardware and install the driver. To help you get started in setting up the machine and installing the driver and software, please read this "Setup Guide" and follow the simple instructions.

Step 1



Setting Up the Machine

Step 2



Installing the Driver & Software



Setup is Complete!

For the latest drivers and to find the best solution for your problem or question, access the Brother Solutions Center directly from the driver or go to <http://solutions.brother.com>. Keep this "Quick Setup Guide", User's Guide and supplied CD-ROM in a convenient place for quick and easy reference at all times.

Setting Up
the Machine

Windows[®]
USB

Windows[®]
Parallel

Windows[®]
NT[®] 4.0
Parallel

Installing the Driver & Software

Windows[®]
Network





Macintosh[®]
USB

Macintosh[®]
Network

For
Administrators

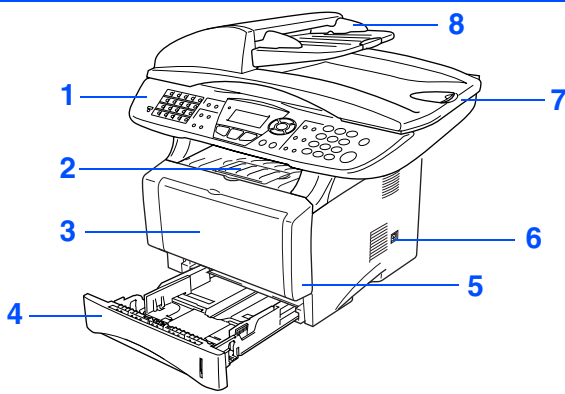
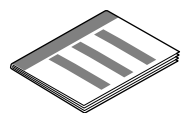
Getting Started

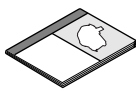
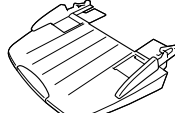
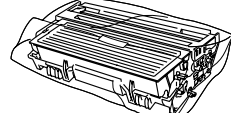
Carton Components

<p>MFC</p>  <ol style="list-style-type: none">1. Control Panel2. Face-down Output Tray Support Flap with Extension3. (For MFC-8440) Manual Feed Tray (For MFC-8840D) Multi-purpose Tray (MP Tray)4. Paper Tray5. Front Cover6. Power Switch7. Document Cover8. Automatic Document Feeder (ADF)		 <p>Quick Setup Guide</p>	
		 <p>CD-ROMs For Windows® For Macintosh®</p>	
		 <p>User's Guide</p>	
 <p>ADF Support</p>	 <p>Drum Unit Assembly (including Toner Cartridge)</p>	 <p>AC Power Cord</p>	 <p>Telephone Line Cord</p>

Carton components may differ from one country to another.
Save all packing materials and the carton.



- *The interface cable is not a standard accessory. Please purchase the appropriate interface cable for the interface you intend to use (Parallel or USB).*
- *For Parallel use a bi-directional shield interface cable that is IEEE 1284-compliant, and not longer than 2 meters.*
- *For USB use a Hi-Speed USB 2.0 interface cable that is not longer than 2 meters.*
- *Please make sure that you use a Hi-Speed USB 2.0 certified cable if your computer uses a Hi-Speed USB 2.0 interface.*
- *Even if your computer has a USB 1.1 interface, you can connect the MFC.*

Warning

When you move the MFC, grasp the side handholds that are under the scanner. Do NOT carry the MFC by holding it at the bottom.

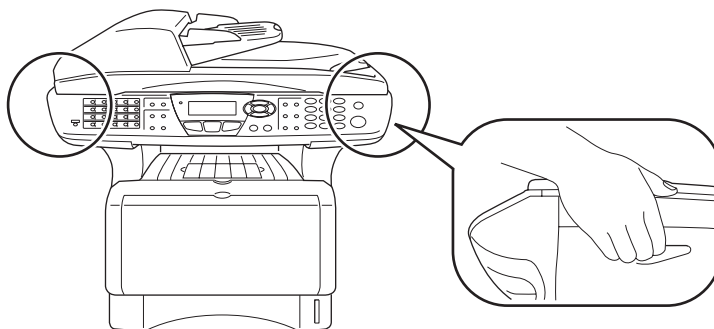

Control Panel

MFC-8440 and MFC-8840D have similar control panel keys.

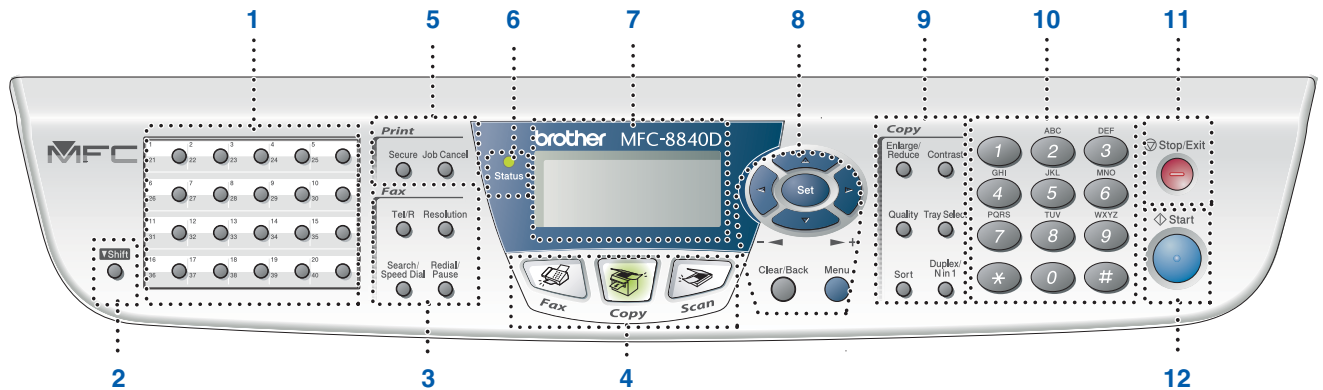

1. One Touch keys	5. Print keys	9. Copy keys (Temporary Settings)
2. Shift	6. Status LED (Light-Emitting Diode)	10. Dial Pad
3. Fax and telephone keys	7. 5-Line Liquid Crystal Display (LCD)	11. Stop/Exit
4. Mode keys	8. Navigation keys	12. Start



For the details of the control panel, see "Control panel overview" in Chapter 1 of the User's Guide.



Warning

Indicates warnings that must be observed to prevent possible personal injury.



Indicates cautions that must be observed to use the MFC properly or to prevent damage to the MFC.



Hint

Indicates notes and useful tips to remember when using the MFC.



User's Guide

Indicates reference to the User's Guide.

Table of Contents

Step 1

Setting Up the Machine

1. Install the Automatic Document Feed (ADF) Support	2
2. Install the Drum Unit Assembly	2
3. Load Paper in the Paper Tray	3
4. Release the Scanner Lock.....	4
5. Install the Power Cord and Phone Line	5
6. Selecting a Receive Mode	6
7. Setting the Date and Time	6
8. Setting Your Station ID	7

Step 2

Installing the Driver & Software

Windows®

Supplied CD-ROM "MFL-Pro Suite"	8
For USB Interface Cable Users (For Windows® 98/98SE/Me/2000 Professional/XP).....	10
■ For Windows® 98/98SE/Me Users Only	12
■ For Windows® 2000 Professional Users Only.....	13
■ For Windows® XP Users Only	16
For Parallel Interface Cable Users (For Windows® 98/98SE/Me/2000 Professional/XP).....	19
■ For Windows® 98/98SE/Me Users Only	21
■ For Windows® 2000 Professional Users Only.....	22
■ For Windows® XP Users Only	26
For Windows NT® Workstation Version 4.0 Users	29
For Network Interface Cable Users (For Windows® 98/98SE/Me/NT/2000 Professional/XP).....	31

Macintosh®

For USB Interface Cable Users.....	34
■ For Mac OS® 8.6 to 9.2	34
■ For Mac OS® X 10.1/10.2.1 or greater.....	36
For Network Interface Cable Users	38
■ For Mac OS® 8.6 to 9.2	38
■ For Mac OS® X 10.1/10.2.1 or greater.....	40

■ For Administrators

Network User's Guide Chapter Map (NC-9100h)	42
Installing the BRAdmin Professional Configuration Utility (Windows® Users Only)	43
Setting your IP Address, Subnet Mask and Gateway using BRAdmin Professional (Windows® Users Only).....	44
Options	45
Replacement Consumables.....	45

Step 1

Setting Up the Machine

1 Install the Automatic Document Feed (ADF) Support

 Do NOT connect the interface cable. Connecting the interface cable is done when installing the driver.

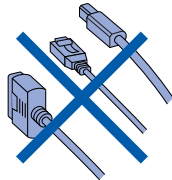

1 Open the ADF cover.

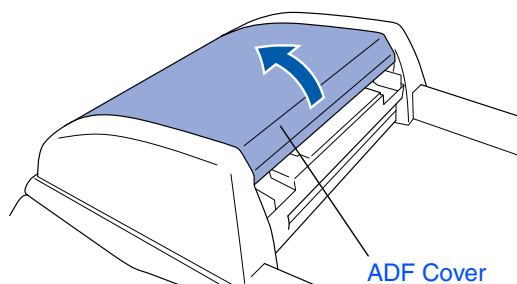

2 Insert the tabs of ADF support into the holes of the ADF one side at a time.

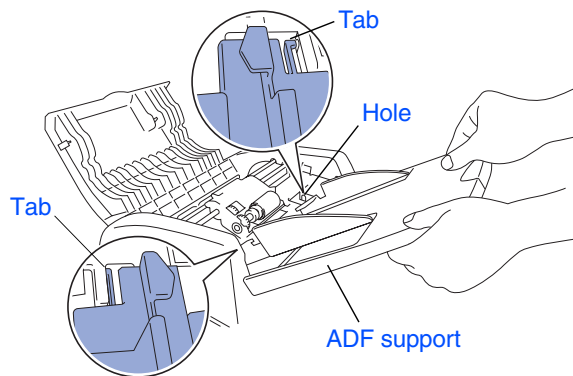

3 Push ADF Support down until it latches in place.

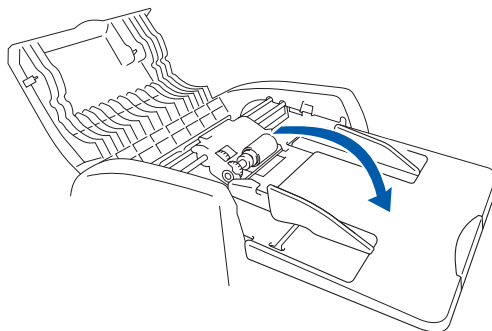

4 Close the ADF cover.

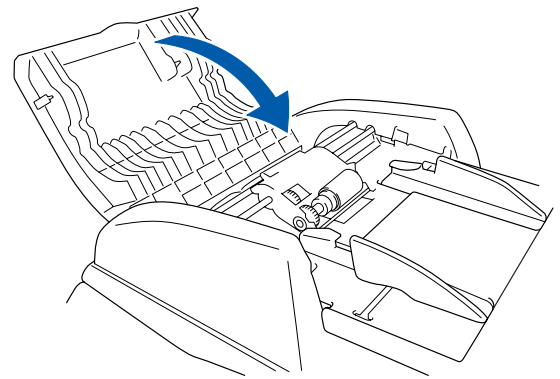

2 Install the Drum Unit Assembly

1 Open the front cover by pressing the front cover release button.

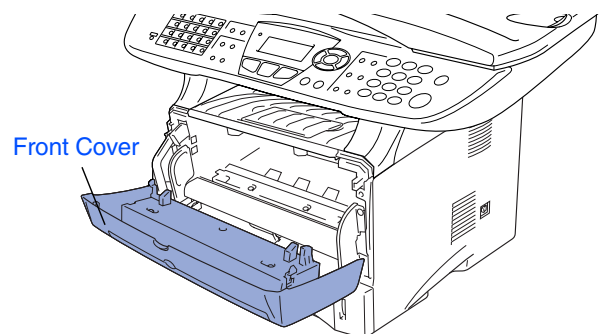
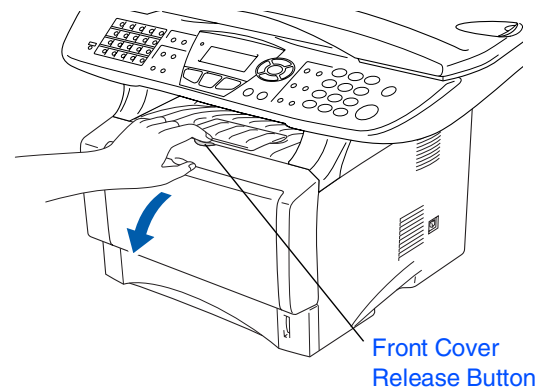

2 Unpack the drum unit assembly. Remove the protective part.

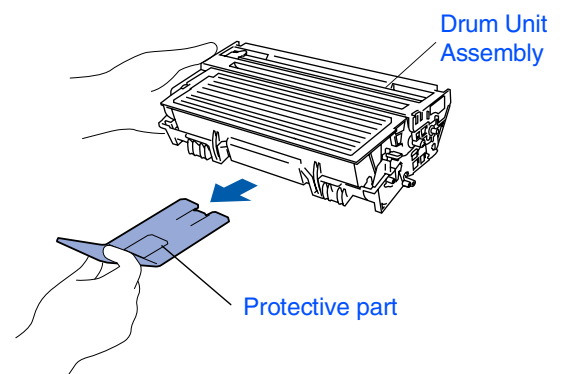

- 3 Rock it from side to side several times to distribute the toner evenly inside the assembly.

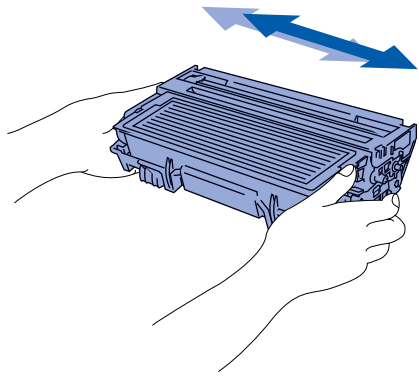

- 4 Push the drum unit assembly into the MFC (until it snaps into place).

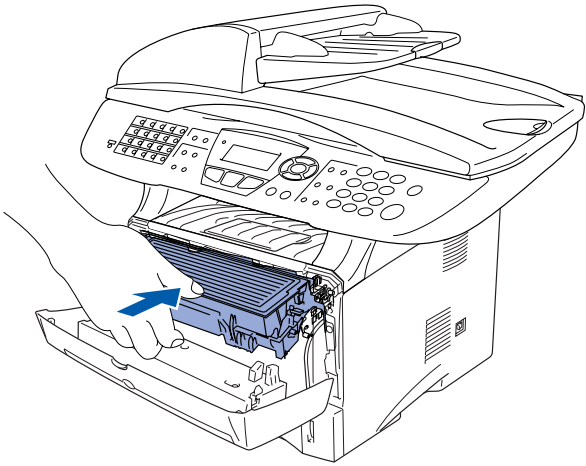

- 5 Close the front cover of the MFC.

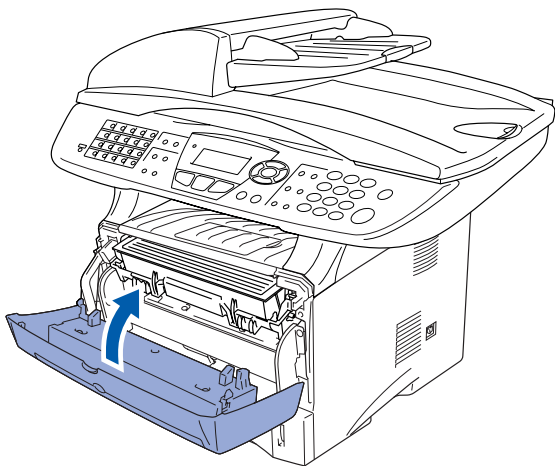

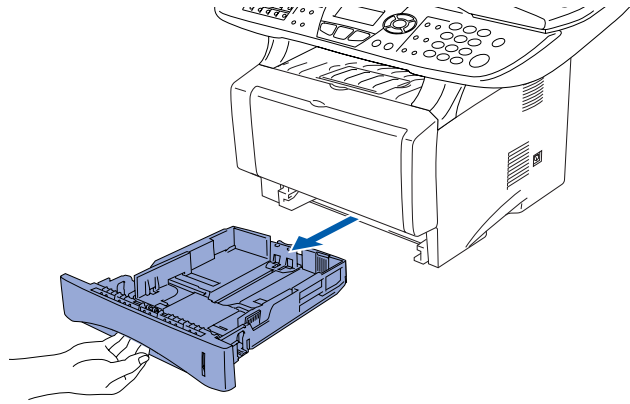

3 Load Paper in the Paper Tray

- 1 Pull the paper tray completely out of the MFC.

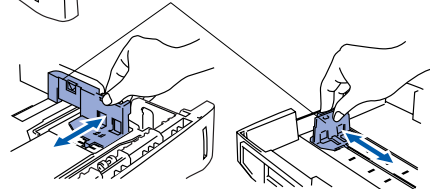
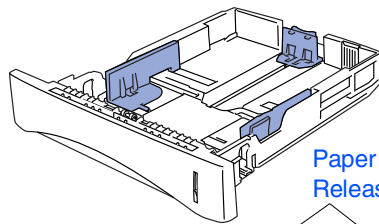

- 2 While pressing the paper guide release lever, slide the adjusters to fit the paper size. Check that the guides are firmly in the slots on the tray.



 For Legal size paper, press the universal guide release button and pull out the rear of the paper tray.

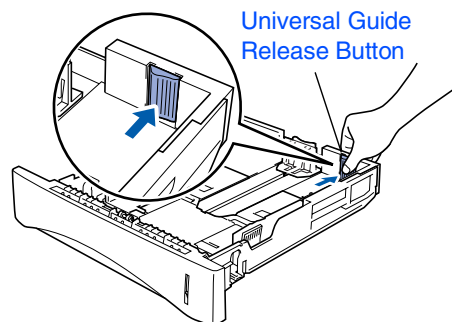

Continued ... 

Step 1

Setting Up the Machine

- 3 Fan the stack of paper well to avoid paper jams and misfeeds.

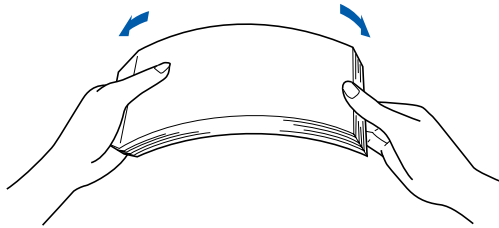

- 4 Put paper in the paper tray. Check that the paper is flat in the tray and below the maximum paper mark.

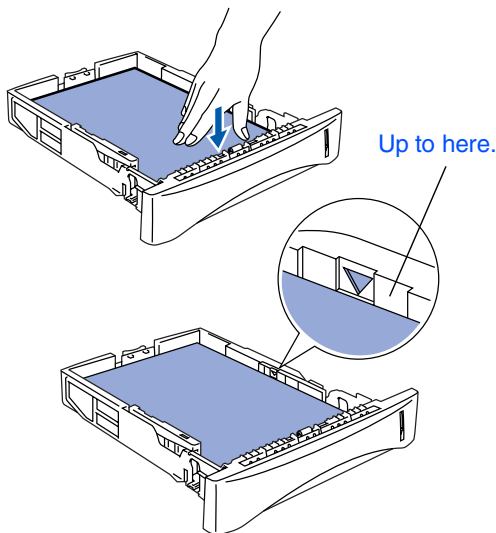

- 5 Put the paper tray firmly back in the MFC and unfold the support flap before you use the MFC.

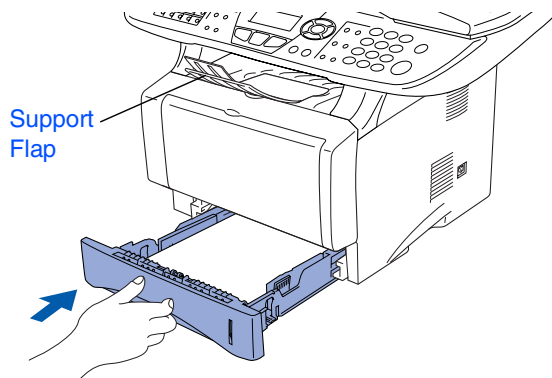

For details on supported paper specifications, see "Paper" in Chapter 2 (User's Guide).

4 Release the Scanner Lock

- 1 Push the lever up to unlock the scanner. (The gray scanner lock lever is located at the back left under side of the document cover.)

Scanner Lock Lever

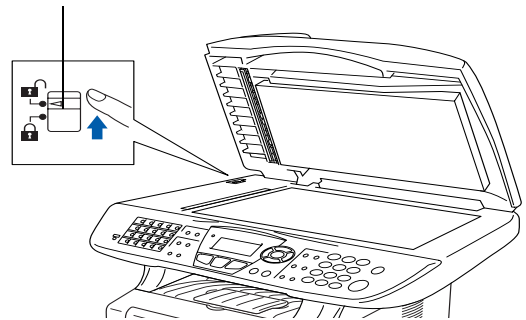

5

Install the Power Cord and Phone Line



Do not connect the Parallel or USB cable yet.

- 1 Make sure that the power switch is off. Connect the AC power cord to the MFC.

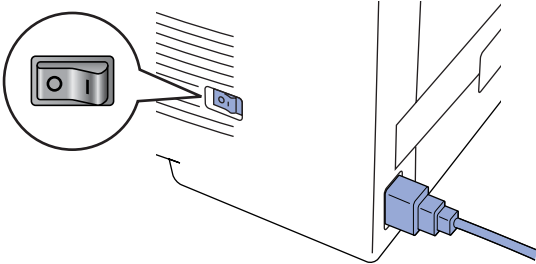

- 2 Plug the AC power cord into an AC outlet. Turn the power switch on.



*If Check Scan Lock appears on the LCD, immediately release the scanner lock and press **Stop/Exit**.*

- 3 Connect one end of the telephone line cord to the socket on the MFC marked **LINE** and the other end to a modular wall socket.

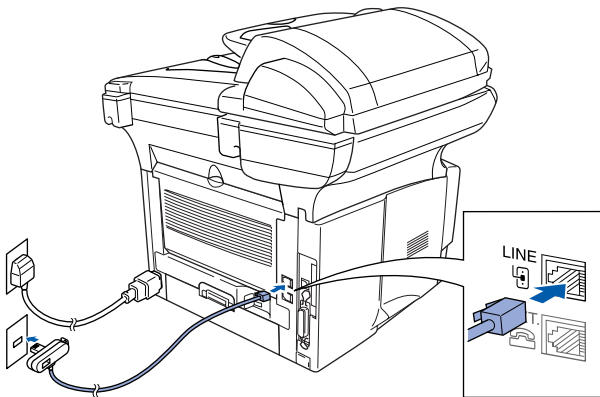

Warning

- The MFC must be fitted with an earthed plug.
- Since the MFC is grounded through the power outlet, you can protect yourself from potentially hazardous electrical conditions on the telephone network by keeping the power to your MFC on when you connect it to a telephone line. Similarly, you can protect yourself when you want to move your MFC by disconnecting the telephone line first and then the power cord.



If you are sharing one phone line with an external telephone, connect it as shown below.

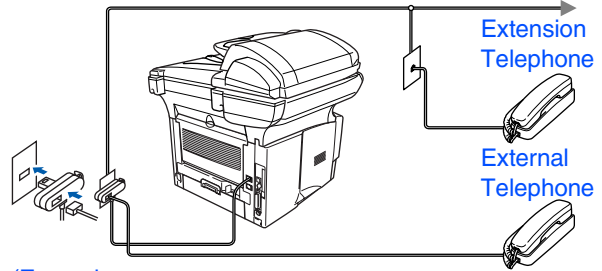

(Example for the U.K.)



If you are sharing one phone line with an external telephone answering device, connect it as shown below.



Please set the receive mode to External TAD. For more details, see "Connecting the MFC" in Chapter 1 of the User's Guide.

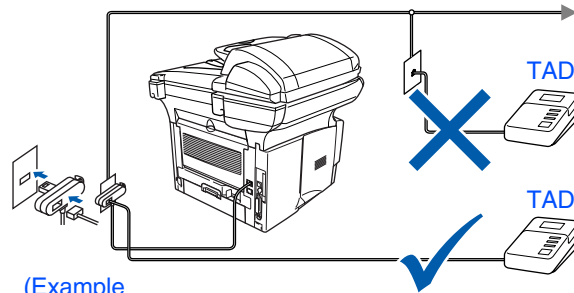





(Example for the U.K.)

6

Selecting a Receive Mode

Choose the **Receive** mode which best suits your needs.

- 1 Press the **Menu** key.
- 2 Press  key.
- 3 Press  key.
- 4 Press  or  to select the mode.
- 5 Press the **Set** key.
- 6 Press the **Stop/Exit** key.

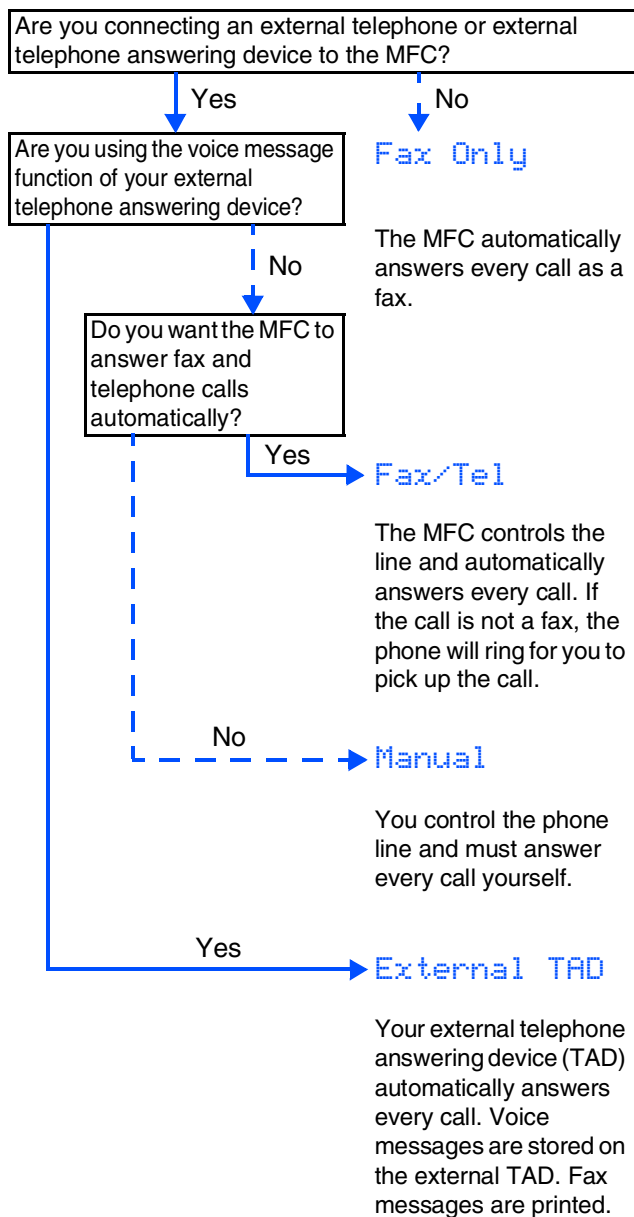



For more details, see "Setup Receive" in Chapter 5 of the User's Guide.

7

Setting the Date and Time

The MFC displays the date and time, and prints it on every fax you send.

- 1 Press the **Menu** key.
- 2 Press the  key.
- 3 Press the  key.
- 4 Enter the last two digits of the year on the dial pad, and then press the **Set** key.

02.Date/Time
Year:2005
Enter & Set Key

(e.g. Enter **0, 5** for 2005.)

- 5 Enter the two digits for the month on the dial pad, and then press the **Set** key.

02.Date/Time
XX/XX/2005
Month:03
Enter & Set Key

(e.g. Enter **0, 3** for March.)

- 6 Enter the two digits for the day on the dial pad, and then press the **Set** key.

02.Date/Time
XX/03/2005
Day:01
Enter & Set Key

(e.g. Enter **0, 1**.)

- 7 Enter the time in 24-hour format on the dial pad, and then press the **Set** key.

02.Date/Time
01/03/2005
Time:15:25
Enter & Set Key

(e.g. Enter **1, 5, 2, 5** for 3:25 P.M.)

- 8 Press the **Stop/Exit** key.



If you want to repeat from step 1, press the **Stop/Exit** key.

8 Setting Your Station ID

You should store your name and fax number to be printed on all fax pages that you send.

- 1 Press the **Menu** key.
- 2 Press the **0** key.
- 3 Press the **3** key.
- 4 Enter your fax number (up to 20 digits) on the dial pad, and then press the **Set** key.

```

03.Station ID
Fax: _
Enter & Set Key
    
```

- 5 Enter your telephone number (up to 20 digits) on the dial pad, and then press the **Set** key.
(If your telephone number and fax number are the same, enter the same number again.)

```

03.Station ID
Fax: +44XXXXXXXXXX
Tel: _
Enter & Set Key
    
```

 Press ***** to enter "+" (plus) character.

- 6 Use the dial pad to enter your name (up to 20 characters), and then press the **Set** key.

```

03.Station ID
Fax: +44XXXXXXXXXX
Tel: +44XXXXXXXXXX
Name: _
Enter & Set Key
    
```



- Refer to the following chart for entering your name.
- If you need to enter a character that is on the same key as the previous character, press **>** to move the cursor to the right.

Press key	One time	Two times	Three times	Four times
2	A	B	C	2
3	D	E	F	3
4	G	H	I	4
5	J	K	L	5
6	M	N	O	6
7	P	Q	R	S
8	T	U	V	8
9	W	X	Y	Z



For more details, see "Setting the Station ID" in Chapter 4 of the User's Guide.

- 7 Press the **Stop/Exit** key.



If you want to repeat from step 1, press the **Stop/Exit** key.

Go to Next page to install the driver

Supplied CD-ROM “MFL-Pro Suite”

The CD-ROM includes the following items:

Windows®



MFL-Pro Suite includes Printer Driver, Scanner Driver, ScanSoft® PaperPort® 9.0SE, ScanSoft® OmniPage® and True Type® fonts. PaperPort® 9.0SE is a document management application for viewing scanned documents. ScanSoft® OmniPage®, which is integrated into PaperPort® 9.0SE, is an OCR application that converts an image into text and inserts it into your default word processor.

Macintosh®



Install MFL-Pro Suite

You can install the MFL-Pro Suite and multifunction drivers.



Install Optional Applications

You can install additional MFL-Pro Suite software utilities.



Documentation*¹

View the User's Guide and other documentation in PDF format (Viewer included).



On-Line Registration

You will be pointed to the Brother Product Registration Web page for quick registration of your machine.



Brother Solutions Center

Brother contact information and web site links offering the latest news and support information.



Repair MFL-Pro Suite

If you experience errors while installing the MFL-Pro Suite you can use this function to automatically repair and re-install the software.



Start Here OS 8.6-9.2

You can install the printer driver, scanner driver and Presto!® PageManager® for Mac OS® 8.6 - 9.2.



Start Here OSX

You can install the printer driver, scanner driver, remote setup program and Presto!® PageManager® for Mac OS® 10.1/10.2.1 or greater.



Readme!

You can get important information and troubleshooting tips.



Documentation*¹

View the User's Guide and other documentation in PDF format.



Brother Solutions Center

You can access the Brother Solutions Center, a Web site offering information about your Brother product including FAQs, User's Guides, Driver updates and Tips for using the MFC.



On-Line Registration

You will be pointed to the Brother Product Registration Web Page for quick registration of the MFC.

*¹ The User's Guide on the CD-ROM includes the Software and Network User's Guide for features available when connected to a computer (e.g. Printing and scanning).



Follow the instructions on this page for your operating system and interface cable.

Setting Up
the Machine

Windows®



USB Interface Cable Users Go to page 10
(For Windows® 98/98SE/Me/2000 Professional/XP)

Windows®
USB



Parallel Interface Cable Users Go to page 19
(For Windows® 98/98SE/Me/2000 Professional/XP)

Windows®
Parallel



Windows NT® Workstation Version 4.0 Users ... Go to page 29
(For Parallel Interface Cable Users)

Windows
NT® 4.0
Parallel



Network Interface Cable Users..... Go to page 31
(For Windows® 98/98SE/Me/NT/2000 Professional/XP)

Windows®
Network

Macintosh®



USB Interface Cable Users
■ For Mac OS® 8.6 to 9.2 Go to page 34
■ For Mac OS® X 10.1/10.2.1 or greater Go to page 36

Macintosh®
USB



Network Interface Cable Users
■ For Mac OS® 8.6 to 9.2 Go to page 38
■ For Mac OS® X 10.1/10.2.1 or greater Go to page 40

Macintosh®
Network

For Administrators Go to page 42

For
Administrators

Step 2

Installing the Driver & Software

For USB Interface Cable Users (For Windows® 98/98SE/Me/2000 Professional/XP)

Make sure that you have completed the instructions from Step 1 “Setting Up the Machine” on pages 2 - 7.



- Brother recommends you connect the machine directly to your computer.
- Please close any applications running before installing the MFL-Pro.

- 1 Disconnect the MFC from the power socket and from your computer, if you have already connected an interface cable.

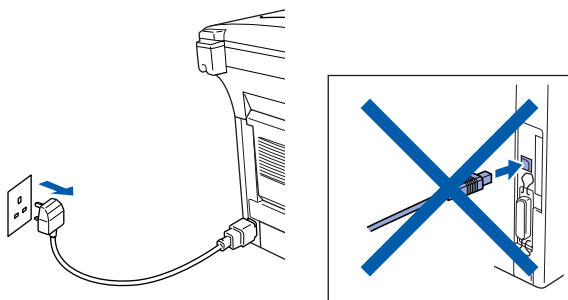

- 2 Turn on your computer. (For Windows® 2000 Professional/XP, you must be logged on as the administrator.)
- 3 Insert the supplied CD-ROM into your CD-ROM drive. If the model name screen appears, select the MFC. If the language screen appears, select your language.



- 4 The CD-ROM main menu will appear. Click **Install MFL-Pro Suite**.



If this window does not appear, use Windows® Explorer to run the **setup.exe** program from the root directory of the Brother CD-ROM.



If you see the following screen, click **OK** to install the Windows® updates. After the updates are installed, your PC may restart. Then the installation will automatically continue.

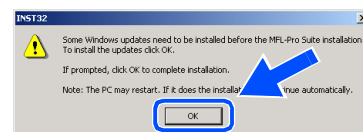

If the installation does not continue automatically, please open the main menu again by ejecting then reinserting the CD-ROM disc or double-click the **setup.exe** program from the root directory, and continue from Step 4 to install the MFL-Pro Suite.

- 5 After reading and accepting the ScanSoft® PaperPort® 9.0SE License Agreement, click **Yes**.

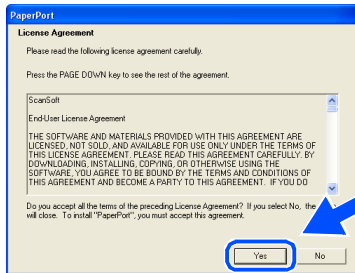

- 6 The installation of PaperPort® 9.0SE will automatically start and is followed by the installation of MFL-Pro Suite.



If an error message appears during the installation process, you can repair and reinstall the software. From the CD menu, select **Repair MFL-Pro Suite** and follow the instructions on the screen.

- 7 When the Brother MFL-Pro Suite Software License Agreement window appears, read the agreement, then click **Yes** if you agree to its terms.

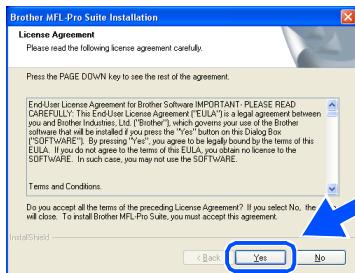

- 8 Select **Local Connection**, and then click **Next**.
The installation will continue.

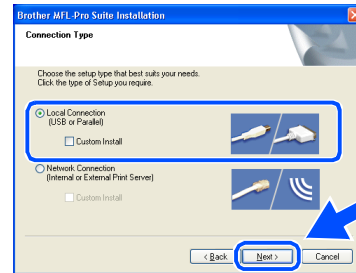

If you want to install the PS driver, select **Custom Install** and then follow the on-screen instructions. When the **Select Components** screen appears, check **PS Printer Driver**, and then continue following the on-screen instructions.

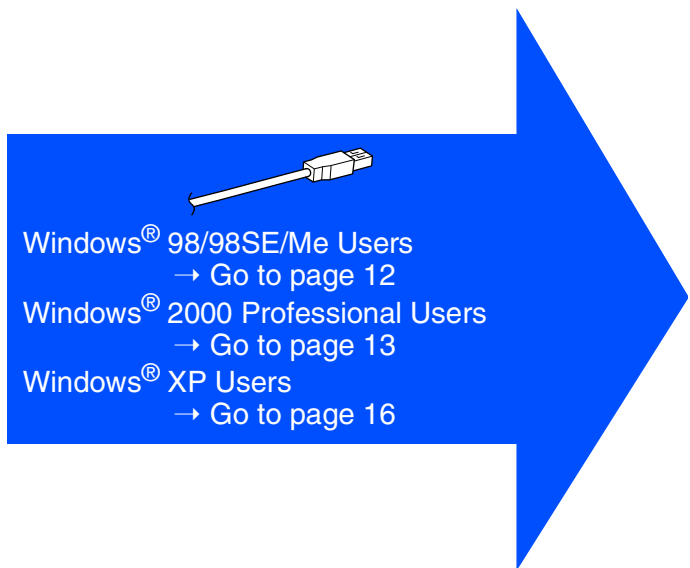

For USB Interface Cable Users (For Windows® 98/98SE/Me/2000 Professional/XP)

For Windows® 98/98SE/Me Users Only

Make sure that you followed the instructions in ① to ⑧ on pages 10 - 11.

- ⑨ When the screen appears, connect the USB interface cable to your PC, and then connect it to the MFC.

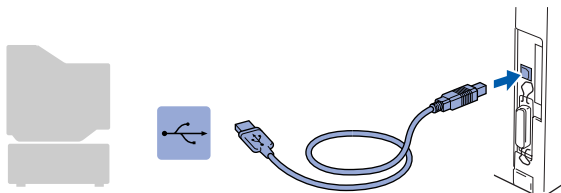
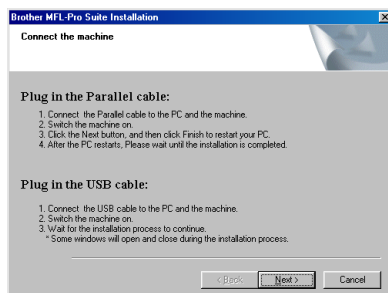

- ⑩ Plug in the power cord and turn on the MFC.

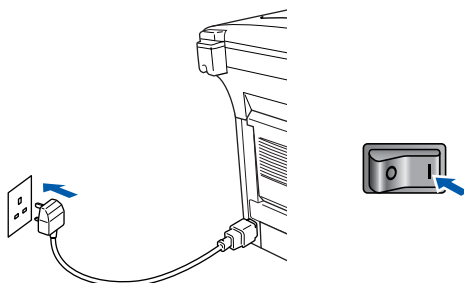

It will take a few seconds for the installation screens to appear. The installation of the Brother drivers will automatically start. The installation screens appear one after another, please wait for a while.

- ⑪ When the Brother on-line Registration screen is displayed, make your selection and follow the on-screen instructions.

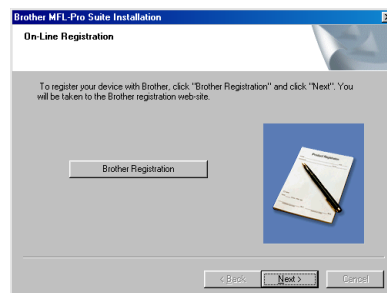

- ⑫ When the following screen appears, click **Finish** and wait as the PC restarts Windows and continues the installation.

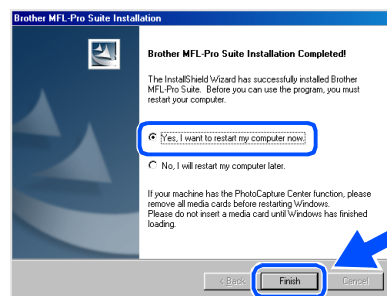

*If the installation is unsuccessful, try installing again using **Repair MFL-Pro Suite** option from the main menu. Select **Repair MFL-Pro** and follow the instructions on the screen.*

- OK!** The MFL-Pro Suite, PC-FAX, Printer driver and Scanner driver have been installed and the installation is now complete.

For Windows® 2000 Professional Users Only

Make sure that you followed the instructions in 1 to 8 on pages 10 - 11.

- 9 When this screen appears, connect the USB interface cable to your PC, and then connect it to the MFC. Plug in the power cord and turn on the MFC.

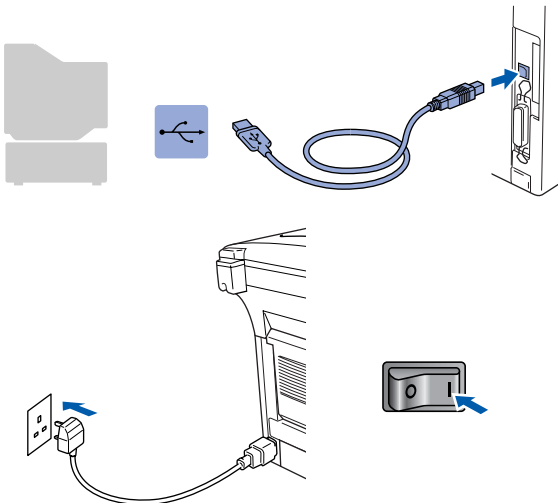
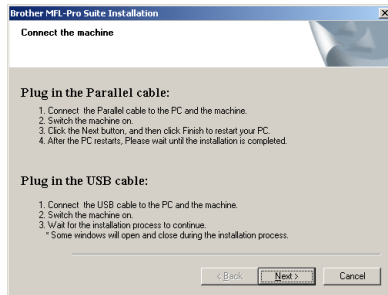

It will take a few seconds for the installation screen to appear.

The installation of the Brother drivers will automatically start. Follow the instructions on the screen.

- 10 When the Brother on-line Registration screen is displayed, make your selection and follow the on-screen instructions.

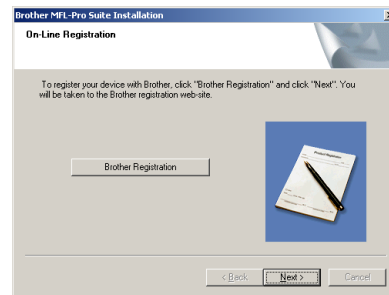

- 11 When the following screen appears, click **Finish** and wait as the PC restarts Windows and continues the installation.

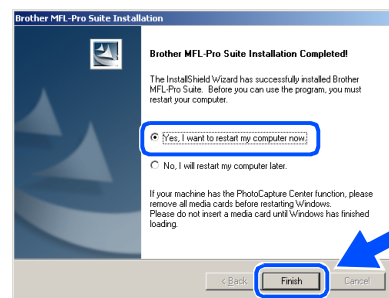

- OK! A Basic Universal printer driver was installed with the MFL-Pro Suite which is certified for use with Windows operating systems.

Brother also offers a full featured printer driver (Native driver) that includes more features than the Basic Universal driver. However, this driver does not include a Windows certificate. To install the Brother Native driver proceed to step 12.



For details on what features are available see Chapter 2 of the Software User's Guide.

Continued ...

Step 2

Installing the Driver & Software



For USB Interface Cable Users

(For Windows® 98/98SE/Me/2000 Professional/XP)

Brother Native driver Installation

- 12 Click **Start** and select **Settings** and then **Printers**. Click on **Add a printer** and the Add Printer Wizard will start. When this screen appears, click **Next**.

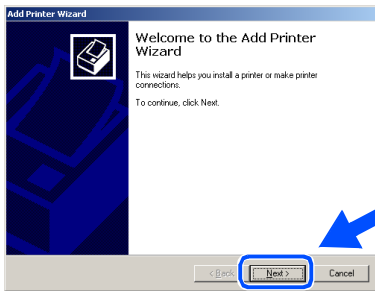

- 13 Un-check the **Automatically detect and install my Plug and Play printer** selection and then click **Next**.

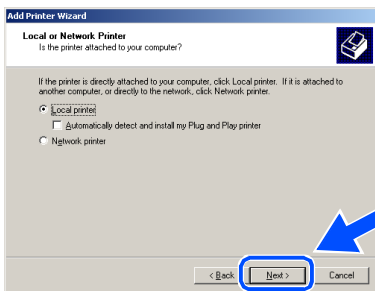

- 14 Select **USBXXX** from the pull down window for the Printer Port Selection and then click **Next**.

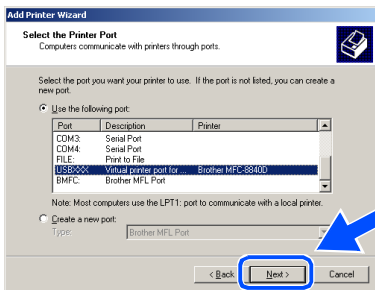

- 15 Click on **Have Disk**.

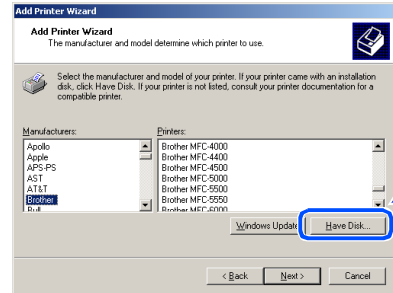

- 16 Browse the CD-ROM and highlight your language folder and click **Open**. Highlight the **W2K** folder and click **Open**. Highlight the **Addprt** folder and click **Open**.

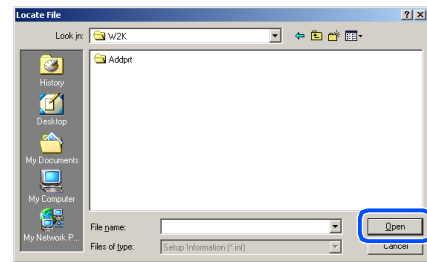

- 17 Click **Open**.

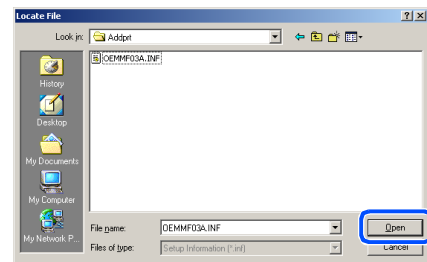

- 18 Make sure **X:\ENG\W2K\Addprt** is displayed in the window and click **OK** (X:\ is the drive letter of your CD-ROM).

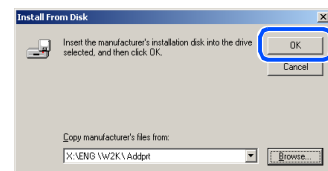

- 19 Highlight the model you are installing from the list of machines and click **Next**.

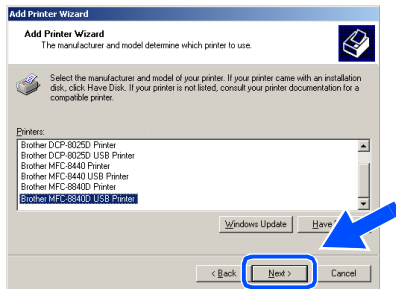

Make sure you select a USB printer.

- 20 The model you are installing will be listed in the window. Select **Yes** or **No** if you want this driver to be your default printer.

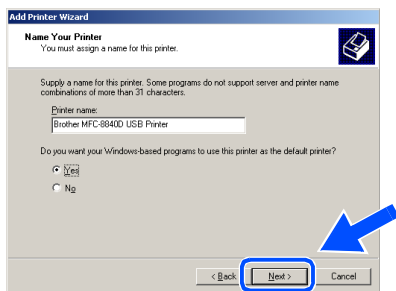

- 21 If this screen appears, select **Do not share this printer** and **Next**.

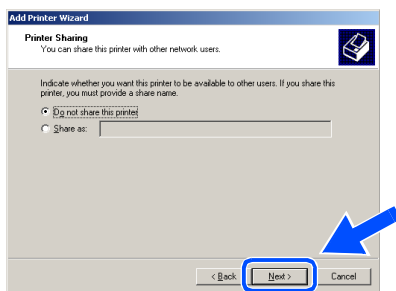

- 22 Select **Yes** and **Next** to print a test page.

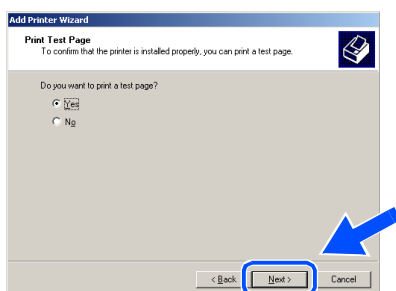

- 23 When this screen appears, click **Finish**.



- 24 If the Digital Signature Not Found dialog box appears, click **Yes**.

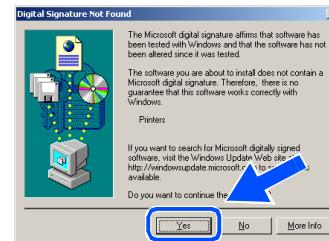

- 25 If the test page printed, click **OK**.

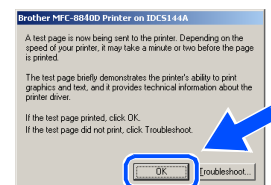

There will be two Brother printer drivers listed in the Printers selection. The driver with "Printer" after the model name (ex. Brother MFC-8840D Printer) is the Brother Native Driver.

- OK!** The Brother Native Drivers have been installed and the installation is now complete.

For USB Interface Cable Users (For Windows® 98/98SE/Me/2000 Professional/XP)

For Windows® XP Users Only

Make sure that you followed the instructions in 1 to 8 on pages 10 - 11.

- 9 When this screen appears, connect the USB interface cable to your PC, and then connect it to the MFC. Plug in the power cord and turn on the MFC.

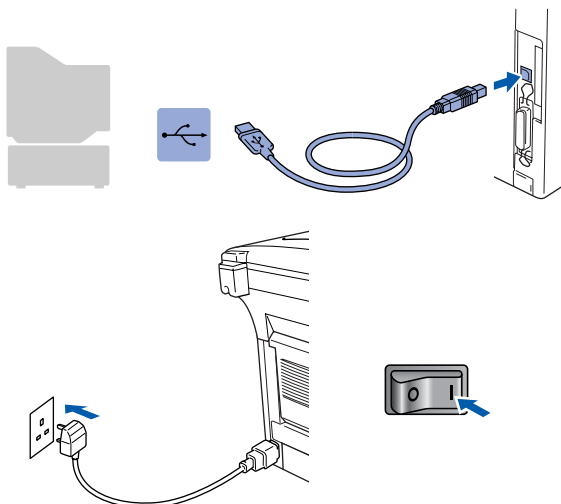
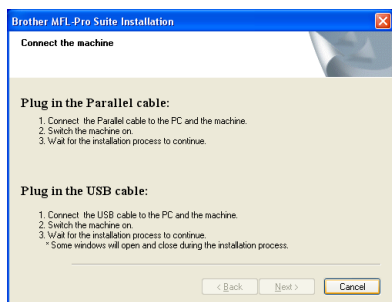

It will take a few seconds for the installation screen to appear.

The installation of the Brother drivers will automatically start. The screens appear one after another, please wait for a while.

- 10 When the Brother on-line Registration screen is displayed, make your selection and follow the on-screen instructions.



- 11 When the following screen appears, click **Finish** and wait as the PC restarts Windows and continues the installation.

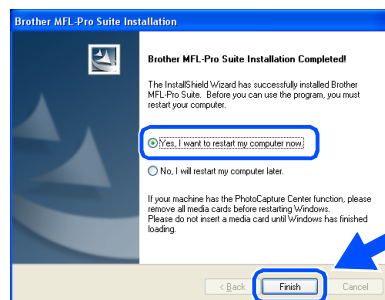

- OK! A Basic Universal printer driver was installed with the MFL-Pro Suite which is certified for use with Windows operating systems.

Brother also offers a full featured printer driver (Native driver) that includes more features than the Basic Universal driver. However, this driver does not include a Windows certificate. To install the Brother Native driver proceed to step 12.



For details on what features are available see Chapter 2 of the Software User's Guide.

Brother Native driver Installation

- 12 Click **Start** and select **Printers and Faxes**. Click on **Add a printer** and the Add Printer Wizard will start. When this screen appears, click **Next**.



- 13 Un-check the **Automatically detect and install my Plug and Play printer** selection and then click **Next**.

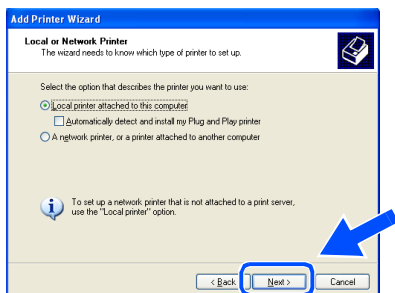

- 14 Select **USBXXX** from the pull down window for the Printer Port Selection and then click **Next**.

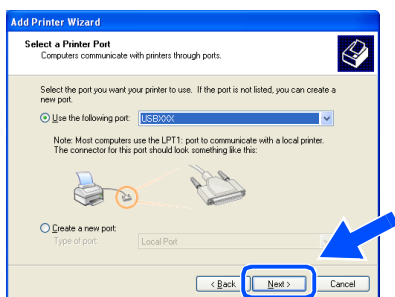

- 15 Click on **Have Disk**.

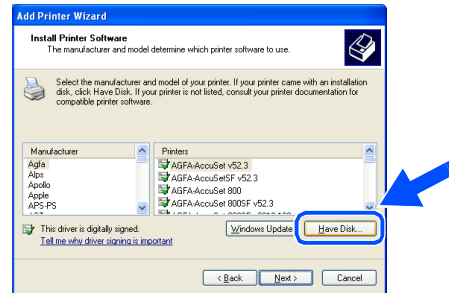

- 16 Browse the CD-ROM and highlight your language folder and click **Open**. Highlight the **WXP** folder and click **Open**. Highlight the **Addprt** folder and click **Open**.

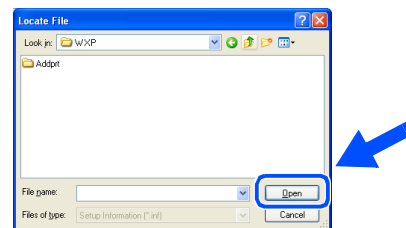

- 17 Click **Open**.

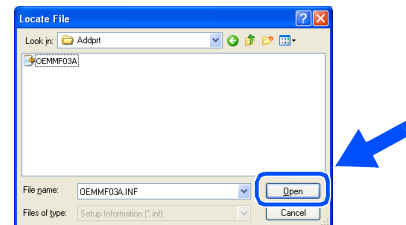

- 18 Make sure **X:\ENG\WXP\Addprt** is displayed in the window and click **OK** (X:\ is the drive letter of your CD-ROM).

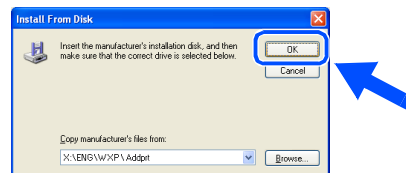

Continued ...

Step 2

Installing the Driver & Software



For USB Interface Cable Users

(For Windows[®] 98/98SE/Me/2000 Professional/XP)

- 19 Highlight the model you are installing from the list of machines and click **Next**.

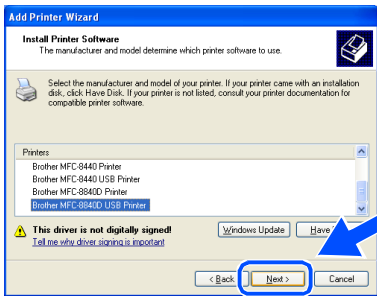

Make sure you select a USB printer.

- 20 The model you are installing will be listed in the window. Select **Yes** or **No** if you want this driver to be your default printer.

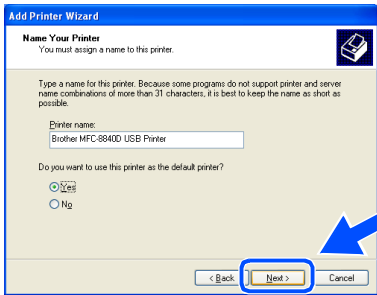

- 21 If this screen appears, select **Do not share this printer** and **Next**.

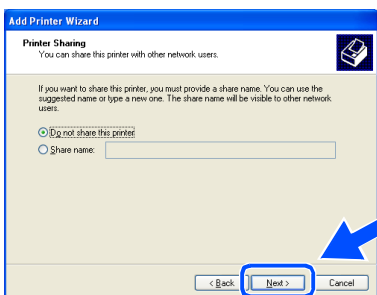

- 22 Select **Yes** and **Next** to print a test page.

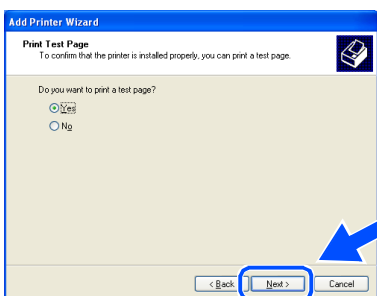

- 23 When this screen appears, click **Finish**.

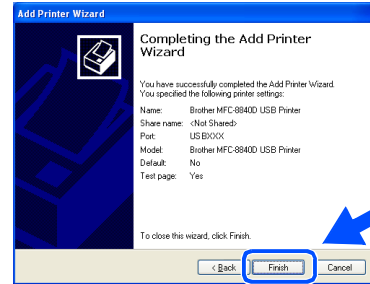

- 24 When the Windows Logo testing screen appears, click **Continue Anyway**.

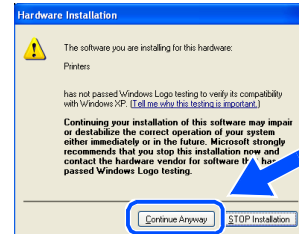

There will be two Brother printer drivers listed in the Printers selection. The driver with "Printer" after the model name (ex. Brother MFC-8840D Printer) is the Brother Native Driver.

- OK!** The Brother Native Drivers have been installed and the installation is now complete.

For Parallel Interface Cable Users (For Windows® 98/98SE/Me/2000 Professional/XP)

Make sure that you have completed the instructions from Step 1 “Setting Up the Machine” on pages 2 - 7.



- Brother recommends you connect the machine directly to your computer.
- Please close any applications running before installing the MFL-Pro.

- 1 Switch off and unplug the MFC from the AC outlet and disconnect it from your computer, if you have already connected an interface cable.

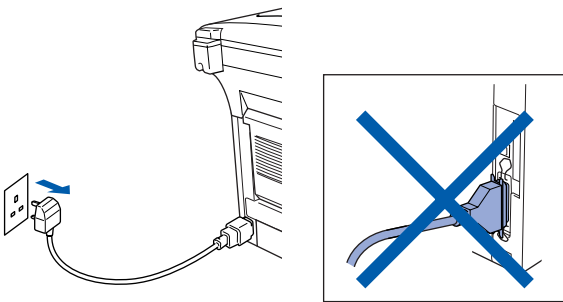

- 2 Turn on your computer.
(For Windows® 2000 Professional/XP, you must be logged on as the administrator.)

- 3 Insert the supplied CD-ROM for Windows® into your CD-ROM drive. If the model name screen appears, select the MFC. If the language screen appears, select your language.



- 4 The CD-ROM main menu will appear. Click **Install MFL-Pro Suite**.

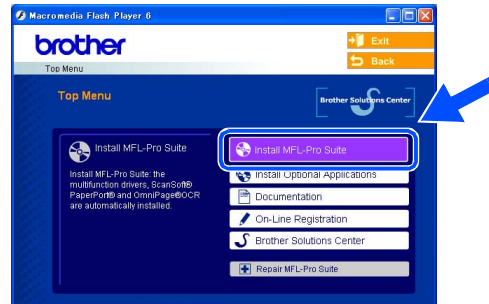

If this window does not appear, use Windows® Explorer to run the **setup.exe** program from the root directory of the Brother CD-ROM.



If you see the following screen, click **OK** to install the Windows® updates. After the updates are installed your PC may restart. Note: If it does the installation will automatically continue.

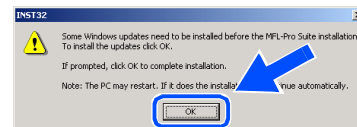

If the installation does not continue automatically, please open the installer menu again by double-clicking the **setup.exe** program from the root directory of the Brother CD-ROM, and continue from Step 4.

Continued ...

Step 2

Installing the Driver & Software

For Parallel Interface Cable Users (For Windows® 98/98SE/Me/2000 Professional/XP)

- 5 After reading and accepting the ScanSoft® PaperPort® 9.0SE License Agreement, click **Yes**.

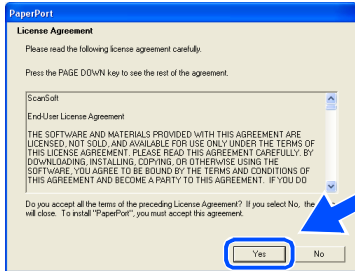

- 6 The installation of PaperPort® 9.0SE will automatically start and is followed by the installation of MFL-Pro Suite.



*If an error message appears during the installation process, you can repair and reinstall the software. From the CD menu, select **Repair MFL-Pro Suite** and follow the instructions on the screen.*

- 7 When the Brother MFL-Pro Suite Software License Agreement window appears, read the agreement, then click **Yes** if you agree to its terms.

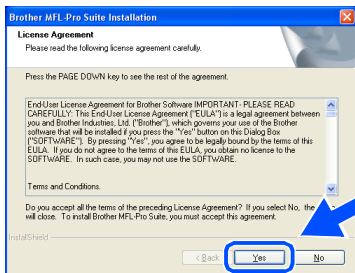

- 8 Select **Local Connection**, and then click **Next**.
The installation will continue.

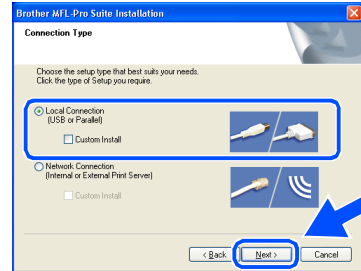

*If you want to install the PS driver, select **Custom Install** and then follow the on-screen instructions. When the **Select Components** screen appears, check **PS Printer Driver**, and then continue following the on-screen instructions.*

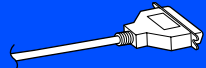

Windows® 98/98SE/Me Users
→ Go to page 21
Windows® 2000 Professional Users
→ Go to page 22
Windows® XP Users
→ Go to page 26

For Windows® 98/98SE/Me Users Only

Make sure that you followed the instructions in 1 to 8 on pages 19 - 20.

- 9 When this screen appears, connect the parallel interface cable to your PC, and then connect it to the MFC. Plug in the power cord and turn on the MFC.

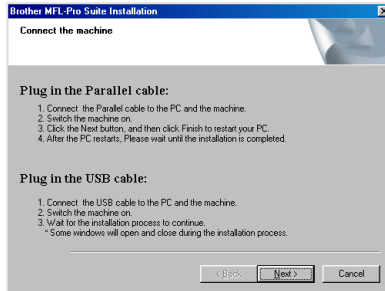

- 10 Click **Next**.

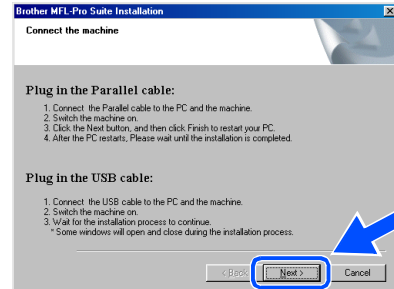

- 11 When the Brother on-line Registration screen is displayed, make your selection and follow the on-screen instructions.

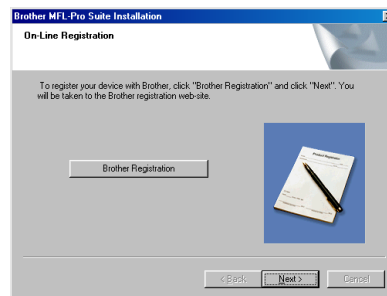

- 12 When the following screen appears, click **Finish** and wait as the PC restarts Windows and continues the installation.

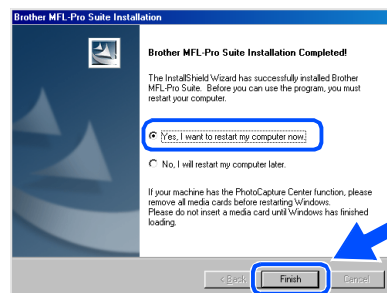

- 13 After the computer restarts, the installation of the Brother driver will automatically start. Follow the instructions on the screen.

- OK!** The MFL-Pro Suite, PC-FAX, Printer driver and Scanner driver have been installed and the installation is now complete.

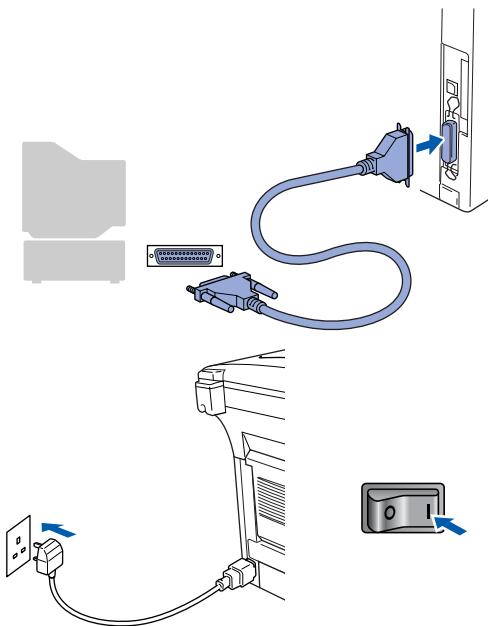

For Parallel Interface Cable Users (For Windows® 98/98SE/Me/2000 Professional/XP)

For Windows® 2000 Professional Users Only

Make sure that you followed the instructions in 1 to 8 on pages 19 - 20.

- 9 When this screen appears, connect the parallel interface cable to your PC, and then connect it to the MFC. Plug in the power cord and turn on the MFC.

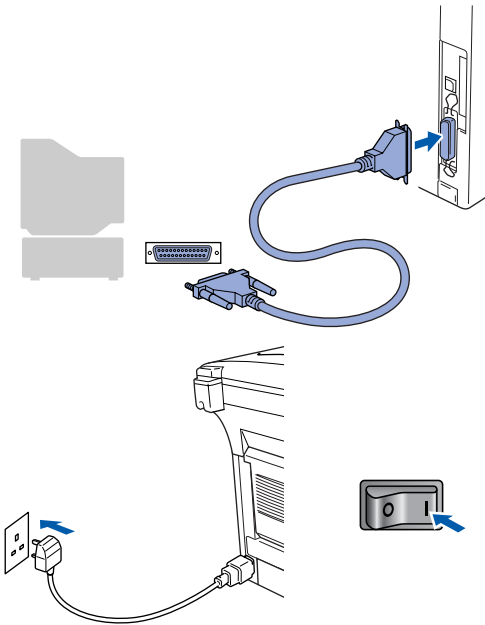
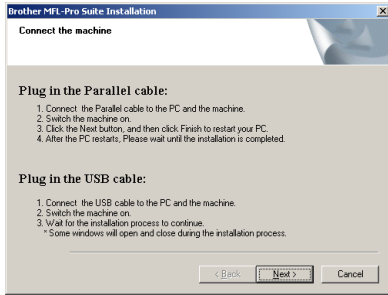

- 10 Click **Next**.

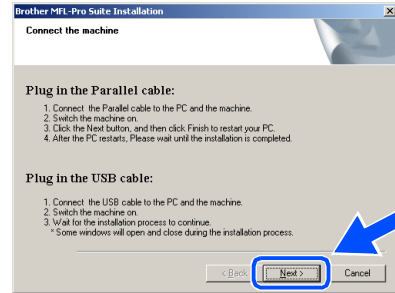

- 11 When the Brother on-line Registration screen is displayed, make your selection and follow the on-screen instructions.

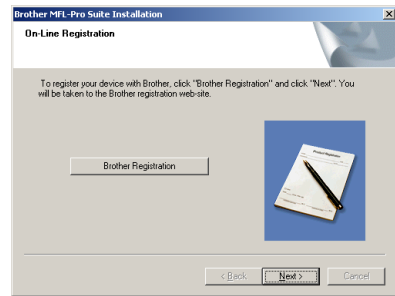

- 12 When the following screen appears, click **Finish** and wait as the PC restarts Windows and continues the installation.

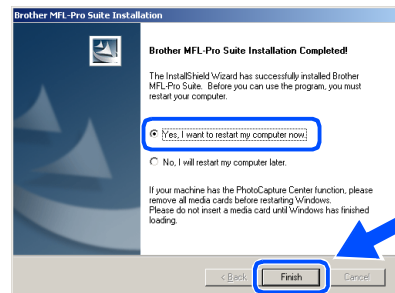

- 13 After the computer restarts, the installation of the Brother drivers will automatically start. Follow the instructions on the screen.
- 14 If the **Digital Signature Not Found** dialog boxes appear, click **Yes** to install the driver.

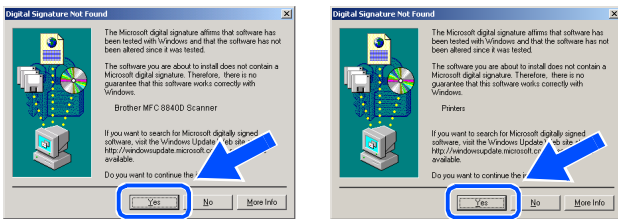

- OK!** A Basic Universal printer driver was installed with the MFL-Pro Suite which is certified for use with Windows operating systems.

Brother also offers a full featured printer driver (Native driver) that includes more features than the Basic Universal driver. However, this driver does not include a Windows certificate. To install the Brother Native driver proceed to step 15.



For details on what features are available see Chapter 2 of the Software User's Guide.

Brother Native driver Installation

- 15 Click **Start** and select **Settings** and then **Printers**. Click on **Add a printer** and the Add Printer Wizard will start. When this screen appears, click **Next**.



- 16 Un-check the **Automatically detect and install my Plug and Play printer** selection and then click **Next**.

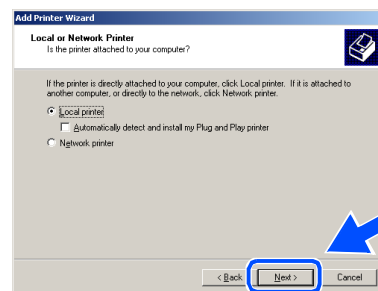

- 17 Select **BMFC (Brother MFL Port)** from the pull down window for the Printer Port Selection and then click **Next**.

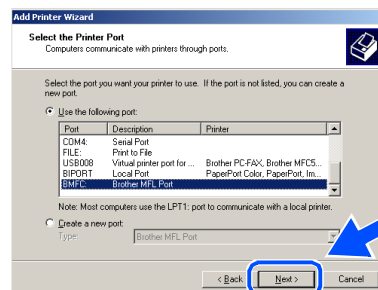

Continued ...

Step 2

Installing the Driver & Software

For Parallel Interface Cable Users (For Windows® 98/98SE/Me/2000 Professional/XP)

- 18 Click on **Have Disk**.

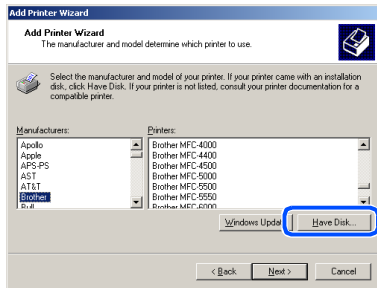

- 19 Browse the CD-ROM and highlight your language folder and click **Open**. Highlight the **W2K** folder and click **Open**. Highlight the **Addprt** folder and click **Open**.

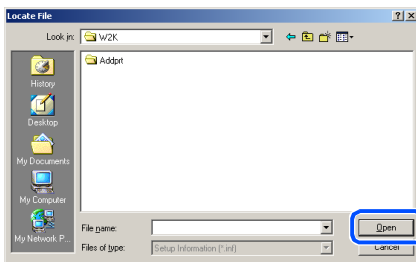

- 20 Click **Open**.

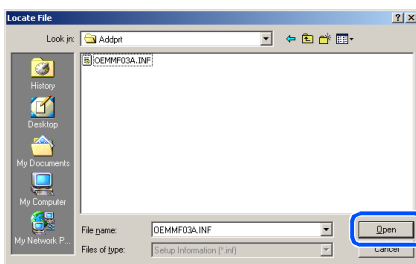

- 21 Make sure **X:\ENG\W2K\Addprt** is displayed in the window and click **OK** (X:\ is the drive letter of your CD-ROM).

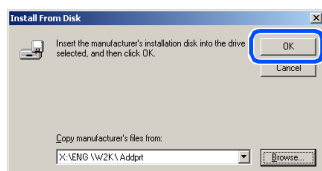

- 22 Highlight the model you are installing from the list of machines and click **Next**.

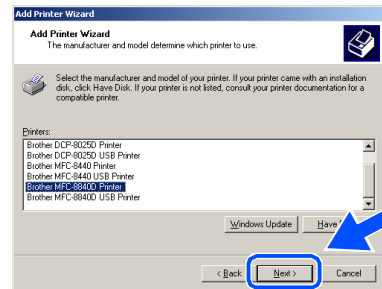

-  Make sure you **do not** select a USB printer.

- 23 The model you are installing will be listed in the window. Select **Yes** or **No** if you want this driver to be your default printer.

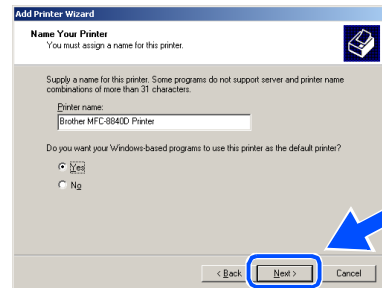

- 24 If this screen appears, select **Do not share this printer** and **Next**.

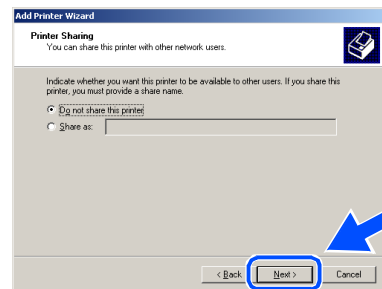

- 25 Select **Yes** and **Next** to print a test page.

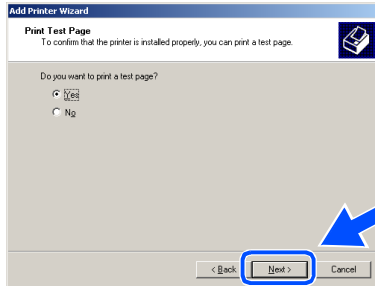

- 26 When this screen appears, click **Finish**.

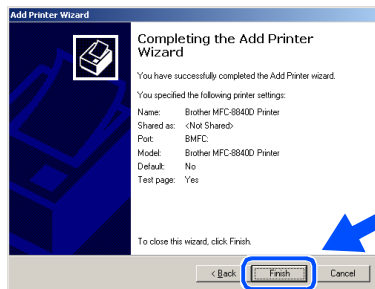

- 27 If the Digital Signature Not Found dialog box appears, click **Yes**.

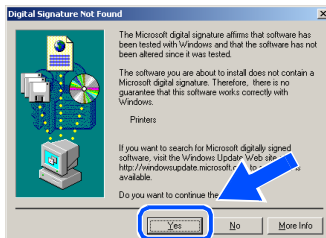

- 28 If the test page printed, click **OK**.

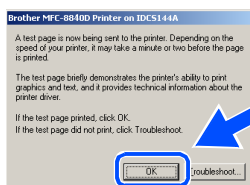

There will be two Brother printer drivers listed in the Printers selection. The driver with "Printer" after the model name (ex. Brother MFC-8840D Printer) is the Brother Native Driver.

- OK!** The Brother Native Drivers have been installed and the installation is now complete.

For Parallel Interface Cable Users (For Windows® 98/98SE/Me/2000 Professional/XP)

For Windows® XP Users Only

Make sure that you followed the instructions in ① to ⑧ on pages 19 - 20.

- ⑨ When this screen appears, connect the parallel interface cable to your PC, and then connect it to the MFC. Plug in the power cord and turn on the MFC.

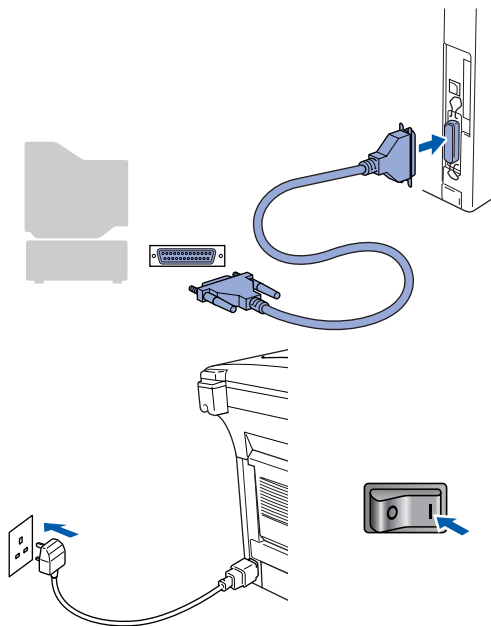
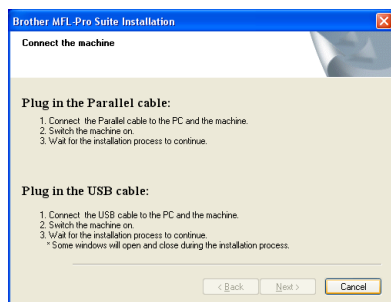

The installation of the Brother drivers will automatically start. The screens appear one after another, please wait for a while.

- ⑩ When the Brother on-line Registration screen is displayed, make your selection and follow the on-screen instructions.

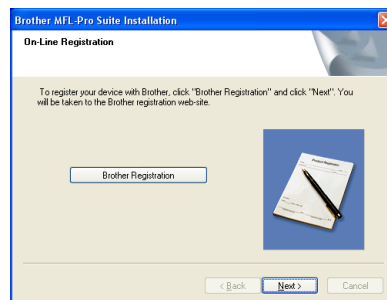

- ⑪ When the following screen appears, click **Finish** and wait as the PC restarts Windows and continues the installation.

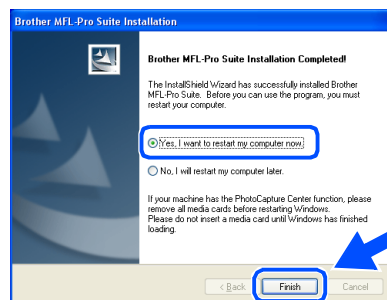

- OK!** A Basic Universal printer driver was installed with the MFL-Pro Suite which is certified for use with Windows operating systems.

Brother also offers a full featured printer driver (Native driver) that includes more features than the Basic Universal driver. However, this driver does not include a Windows® certificate. To install the Brother Native driver proceed to step ⑫.



For details on what features are available see chapter 2 of the Software User's Guide.

Brother Native driver Installation

- 12 Click **Start** and select **Printers and Faxes**. Click on **Add a printer** and the Add Printer Wizard will start. When this screen appears, click **Next**.

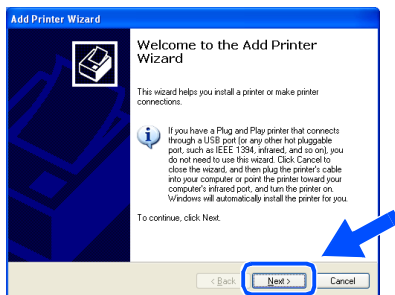

- 13 Un-check the **Automatically detect and install my Plug and Play printer** selection and then click **Next**.

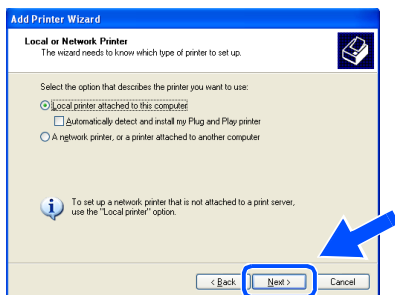

- 14 Select **BMFC (Brother MFL Port)** from the pull down window for the Printer Port Selection and then click **Next**.

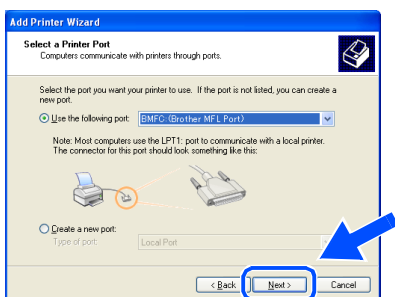

- 15 Click on **Have Disk**.

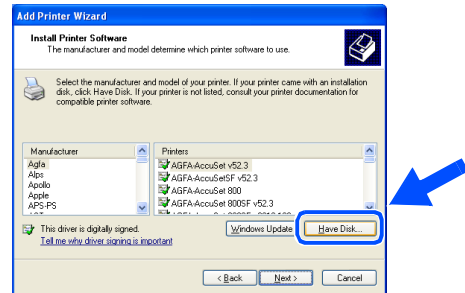

- 16 Browse the CD-ROM and highlight your language folder and click **Open**. Highlight the **WXP** folder and click **Open**. Highlight the **Addprt** folder and click **Open**.

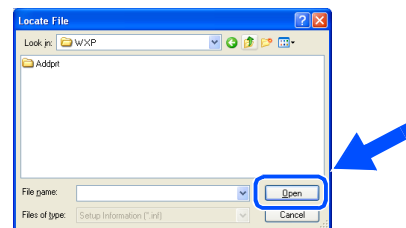

- 17 Click **Open**.

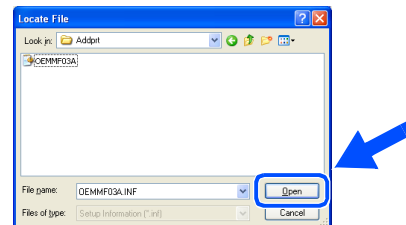

- 18 Make sure **X:\ENG\WXP\Addprt** is displayed in the window and click **OK** (X:\ is the drive letter of your CD-ROM).

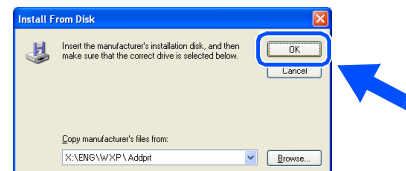

Continued ...

Step 2

Installing the Driver & Software

For Parallel Interface Cable Users (For Windows® 98/98SE/Me/2000 Professional/XP)

- 19 Highlight the model you are installing from the list of machines and click **Next**.

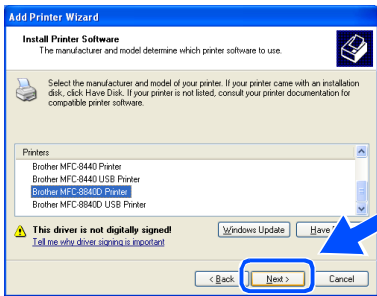

Make sure you **do not** select a USB printer.

- 20 The model you are installing will be listed in the window. Select **Yes** or **No** if you want this driver to be your default printer.

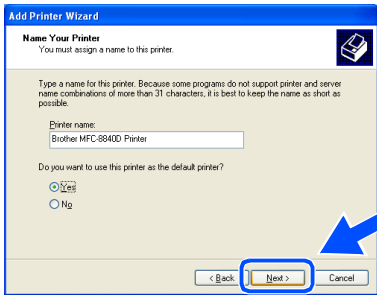

- 21 If this screen appears, select **Do not share this printer** and **Next**.

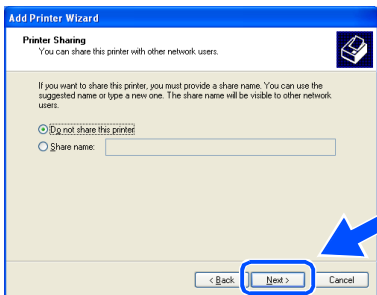

- 22 Select **Yes** and **Next** to print a test page.

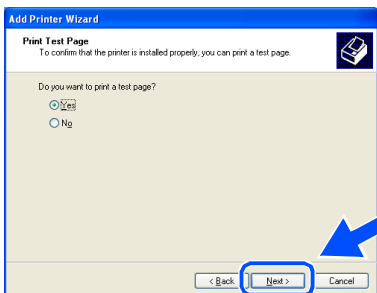

- 23 When this screen appears, click **Finish**.



- 24 When the Windows Logo testing screen appears, click **Continue Anyway**.

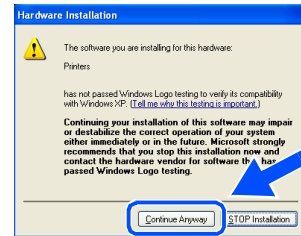



There will be two Brother printer drivers listed in the Printers selection. The driver with "Printer" after the model name (ex. Brother MFC-8840D Printer) is the Brother Native Driver.

- OK!** The Brother Native Drivers have been installed and the installation is now complete.

For Windows NT® Workstation Version 4.0 Users

Make sure that you followed the instructions from Step 1 “Setting Up the Machine” on pages 2 - 7.

-  ■ Brother recommends you connect the machine directly to your computer.
-  ■ Please close any applications running before installing the MFL-Pro.

- 1 Turn on your computer. You must be logged on as the Administrator.
- 2 Connect the parallel interface cable to your computer, and then connect it to the MFC.

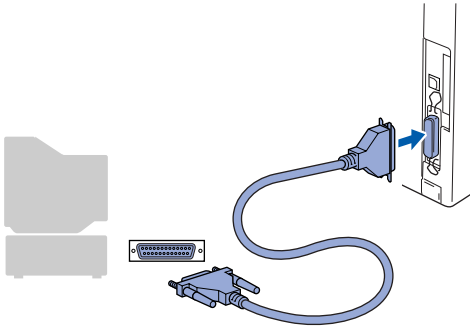

- 3 Plug in the power cord and turn on the MFC.

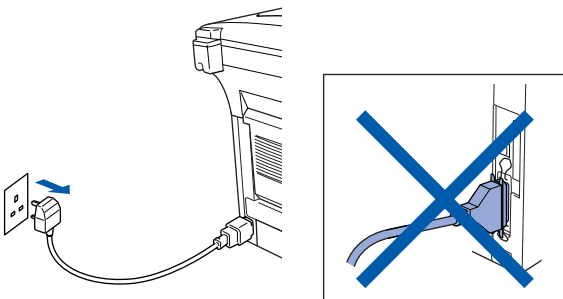



- 4 Insert the Supplied CD-ROM for Windows® into your CD-ROM drive. If the model name screen appears, select the MFC. If the language screen appears, select your language.



- 5 The CD-ROM main menu will appear. Click **Install MFL-Pro Suite**.



 If this window does not appear, use Windows® Explorer to run the **setup.exe** program from the root directory of the Brother CD-ROM.

 If you see the following screen, click **OK** to install the Windows® updates. After the updates are installed your PC may restart. Note: If it does the installation will automatically continue.

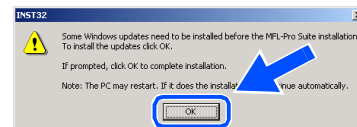

If the installation does not continue automatically, please open the installer menu again by double-clicking the **setup.exe** program on the Brother CD-ROM, and continue from Step 5.

 Continued ...

Step 2

Installing the Driver & Software



For Windows NT® Workstation Version 4.0 Users

- 6 After reading and accepting the ScanSoft® PaperPort® 9.0SE License Agreement, click **Yes**.

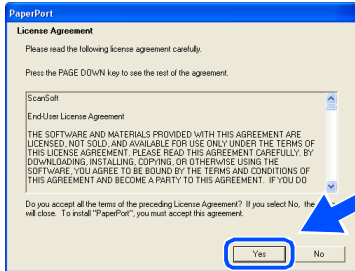

- 7 The installation of PaperPort® 9.0SE will automatically start and is followed by the installation of MFL-Pro Suite.



If an error message appears during the installation process, you can repair and reinstall the software. From the CD menu, select **Repair MFL-Pro Suite** and follow the instructions on the screen.

- 8 When the Brother MFL-Pro Suite Software License Agreement window appears, read the agreement, then click **Yes** if you agree to its terms.

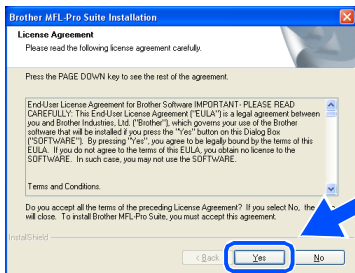

- 9 Select **Local Connection**, and then click **Next**. The installation will continue.

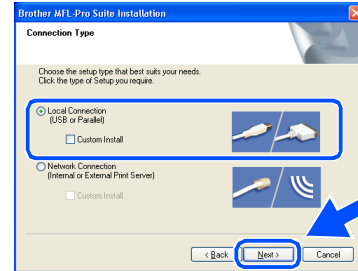

If you want to install the PS driver, select **Custom Install** and then follow the on-screen instructions. When the **Select Components** screen appears, check **PS Printer Driver**, and then continue following the on-screen instructions.

- 10 When the Brother on-line Registration screen is displayed, make your selection and follow the on-screen instructions.

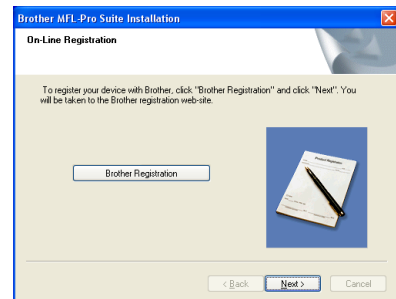

- 11 When the following screen appears, click **Finish** and wait as the PC restarts Windows and continues the installation.

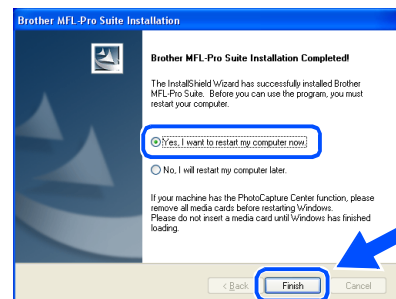

OK! The MFL-Pro Suite, PC-FAX, Printer driver and Scanner driver have been installed and the installation is now complete.

For Network Interface Cable Users (For Windows® 98/98SE/Me/NT/2000 Professional/XP)

Make sure that you have completed the instructions from Step 1 “Setting Up the Machine” on pages 2 - 7.

Before installation, if you are using Personal Firewall software, disable it. Once you are sure that you can print, re-start your Personal Firewall software.

- 1 Make sure that the NC-9100h (Network Print/Fax Server) is installed into the MFC. (See “Optional accessories” in Chapter 13 of the User’s Guide.)
- 2 Connect the network cable to the MFC, and then connect it to a free port on your hub.

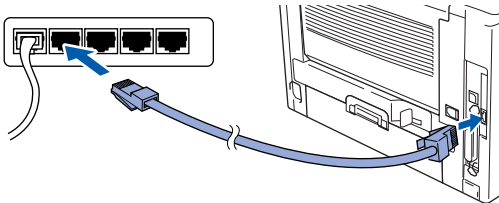

- 3 Plug in the power cord and turn on the MFC.

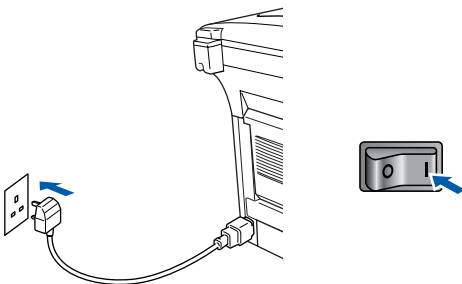

- 4 Turn on your computer. (For Windows® 2000 Professional/XP/Windows NT® 4.0, you must be logged on as the administrator.)

- 5 Insert the supplied CD-ROM into your CD-ROM drive. If the model name screen appears, select the MFC. If the language screen appears, select your language.



- 6 The CD-ROM main menu will appear. Click **Install MFL-Pro Suite**.



If this window does not appear, use Windows® Explorer to run the **setup.exe** program from the root directory of the Brother CD-ROM.



If you see the following screen, click **OK** to install the Windows® updates. After the updates are installed your PC may restart. Then the installation will automatically continue.

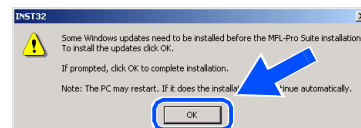

If the installation does not continue automatically, please open the main menu again by ejecting then reinserting the CD-ROM disc or double-click the **setup.exe** program from the root directory, and continue from Step 6 to install the MFL-Pro Suite.

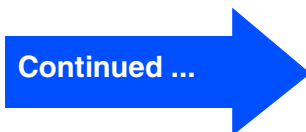

Step 2

Installing the Driver & Software

For Network Interface Cable Users (For Windows® 98/98SE/Me/NT/2000 Professional/XP)

- 7 After reading and accepting the ScanSoft® PaperPort® 9.0SE License Agreement, click **Yes**.

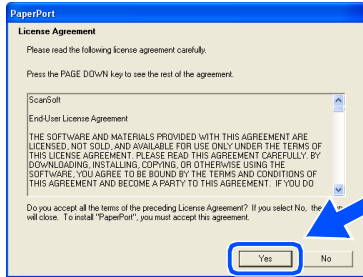

- 8 The installation of PaperPort® 9.0SE will automatically start and is followed by the installation of MFL-Pro Suite.
- 9 When the Brother MFL-Pro Suite Software License Agreement window appears, read the agreement, then click **Yes** if you agree to its terms.

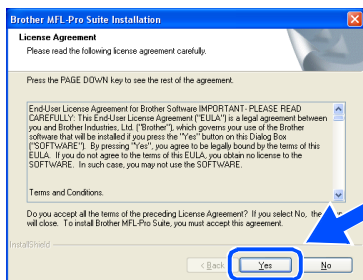

- 10 Select **Network Connection**, and then click **Next**.

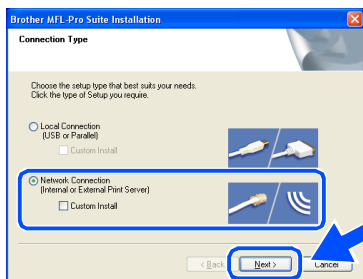

If you want to install the PS driver, select **Custom Install** and then follow the on-screen instructions. When the **Select Components** screen appears, check **PS Printer Driver**, and then continue following the on-screen instructions.

- 11 The installation of the Brother drivers will automatically start. The installation screens appear one after another, please wait for a while.

- 12 If the MFC is configured for your network, select the MFC from the list, and then click **Next**.



This window will not appear if there is only one machine connected on the network, it will be selected automatically.

If the MFC is not yet configured for use on your network, the **Configure IP Address** window will appear. Enter the IP address information appropriate to your network by following the on-screen instructions.



- 13 When the Brother on-line Registration screen is displayed, make your selection and follow the on-screen instructions.

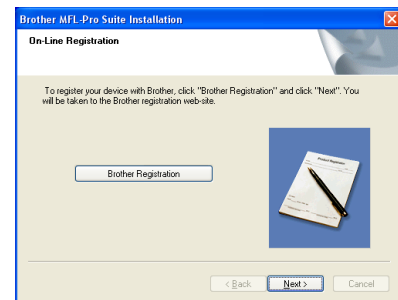

- 14 When the following screen appears, click **Finish** and wait as the PC restarts Windows and continues the installation.

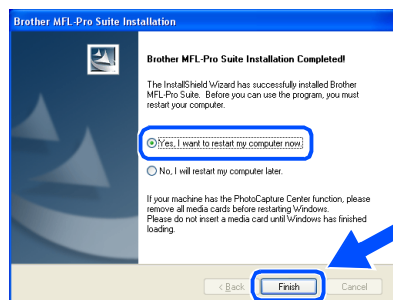

- OK!** The MFL-Pro Suite, Network Printer driver and Network Scanner driver have been installed and the installation is now complete.



Network Scanning is not supported in Windows NT®.

For USB Interface Cable Users

For Mac OS[®] 8.6 to 9.2

Make sure that you have completed the instructions from Step 1 “Setting Up the Machine” on pages 2 - 7.

- 1 Disconnect the machine from the power socket and from the Macintosh[®], if you have already connected an interface cable.

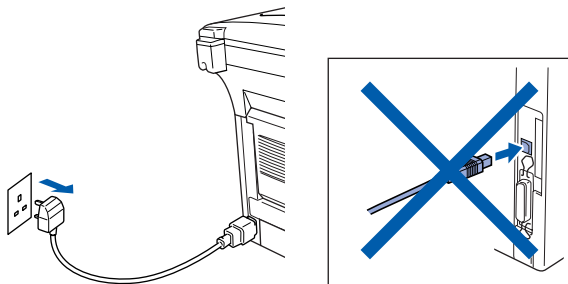

- 2 Turn on your Macintosh[®].
- 3 Insert the supplied CD-ROM into your CD-ROM drive.



- 4 Double-click the **Start Here OS 8.6-9.2** icon to install the printer and scanner drivers. If the language screen appears, select your language.

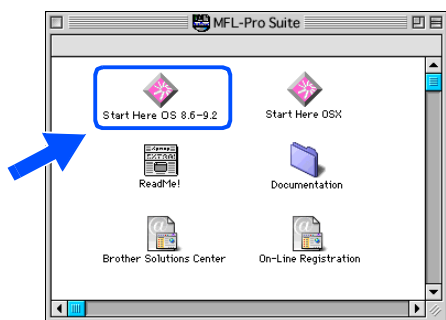

- 5 Click **MFL-Pro Suite** to install.



- 6 Follow the on-screen instructions, and restart your Macintosh[®].
- 7 Connect the USB interface cable to your Macintosh[®], and then connect it to the MFC.

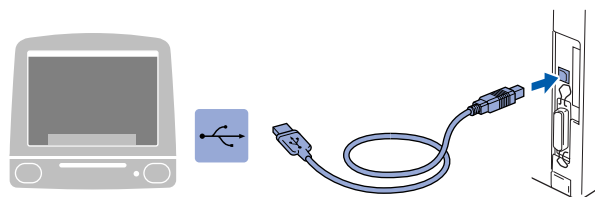

DO NOT connect the MFC to a USB port on a keyboard or a non powered USB hub.

- 8 Plug in the power cord and turn on the MFC.

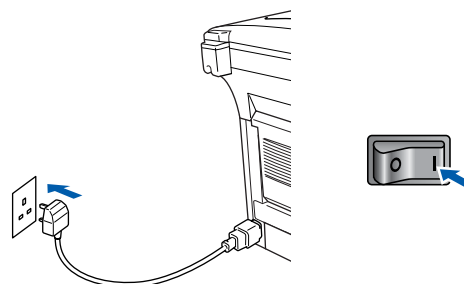

- 9 From the Apple® menu, open the **Chooser**.



- 10 Click the **Brother Laser** icon you installed. On the right side of the **Chooser**, select the printer to which you want to print. Close the **Chooser**.

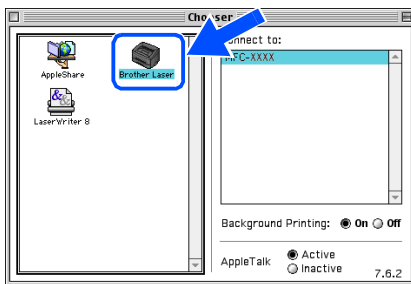

- OK! The MFL-Pro Suite, Printer driver and Scanner driver have been installed.



ControlCenter2.0 is not supported in Mac OS® 8.6 to 9.2.

- 11 To install Presto!® PageManager®, click the **Presto! PageManager** icon and follow the on-screen instructions.

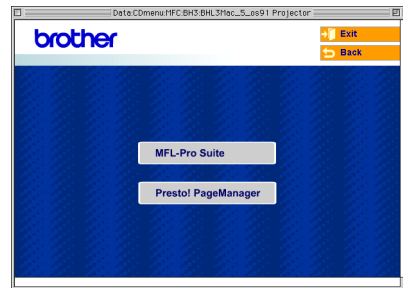

You can easily scan, share and organize photos and documents using Presto!® PageManager®.

- OK! Presto!® PageManager® has been installed and the installation is now complete.

For USB Interface Cable Users

For Mac OS® X 10.1/10.2.1 or greater

Make sure that you have completed the instructions from Step 1 “Setting Up the Machine” on pages 2 - 7.

 For Mac OS® X 10.2.0 user, please upgrade to Mac OS® X 10.2.1 or greater. (The latest information for Mac OS® X, please visit at: <http://solutions.brother.com>)

- 1 Disconnect the MFC from the power socket and from the Macintosh®, if you have already connected an interface cable.

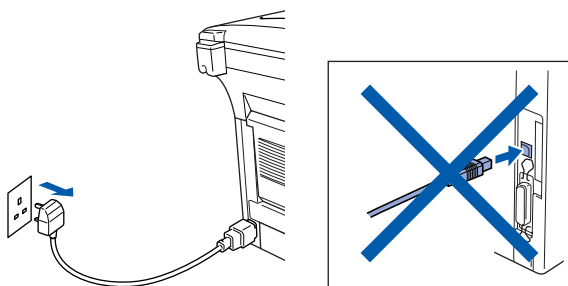

- 2 Turn on your Macintosh®.
- 3 Insert the supplied CD-ROM into your CD-ROM drive.



- 4 Double-click the **Start Here OSX** icon to install the printer driver, Scanner driver and Remote Setup program. If the language screen appears, select your language.



- 5 Click **MFL-Pro Suite** to install.

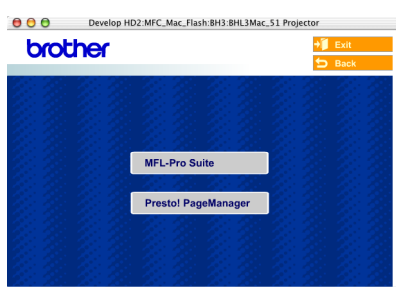

- 6 Follow the on-screen instructions, and restart your Macintosh®.
- 7 After the **DeviceSelector** window appears, connect the USB interface cable to your Macintosh® and then to the machine.



 The **DeviceSelector** window will not appear if the USB interface cable has been connected before restarting your Macintosh® or if you are overwriting a previously installed version of the Brother Software. If you encounter this problem continue with the installation skipping step 10 and then see the Software User's Guide Chapter 7 for details on selecting what machine the ControlCenter2.0 will connect with.

- 8 Connect the USB interface cable to your Macintosh®, and then connect it to the MFC.

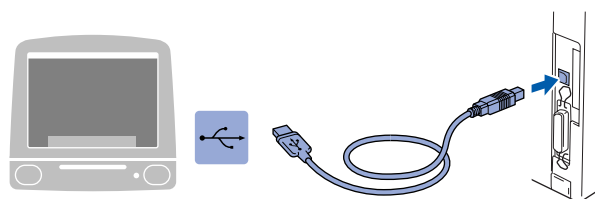

 **DO NOT** connect the MFC to a USB port on a keyboard or a non powered USB hub.

- 9 Plug in the power cord and turn on the MFC.

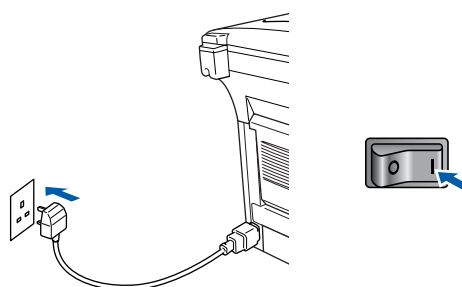

- 10 Select **USB** and then click **OK**.



- 11 Select **Applications** from the **Go** menu.

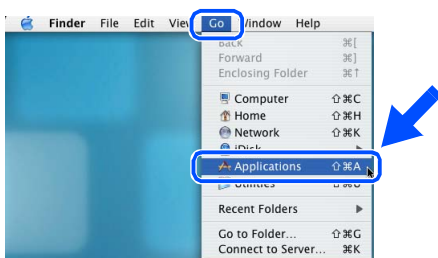

- 12 Open the **Utilities** folder.



- 13 Open the **Print Center** icon.



- 14 Click **Add**.

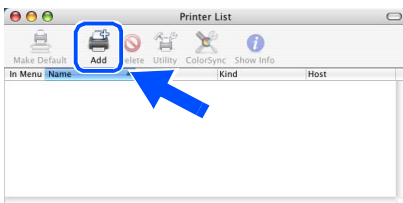

- 15 Select **USB**.

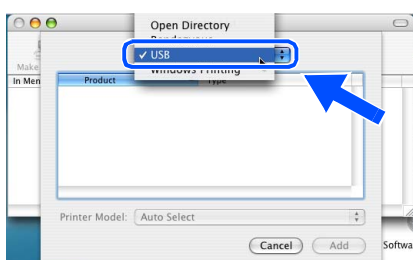

- 16 Select **MFC-XXXX** (XXXX is your model name), and then click **Add**.

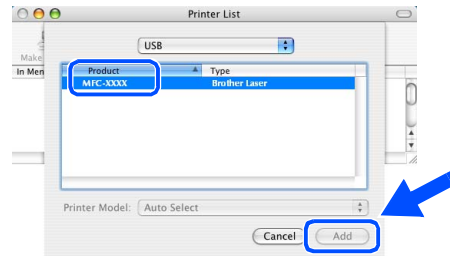

- 17 Select **Quit Printer Setup Utility** from the **Printer Setup Utility** menu.

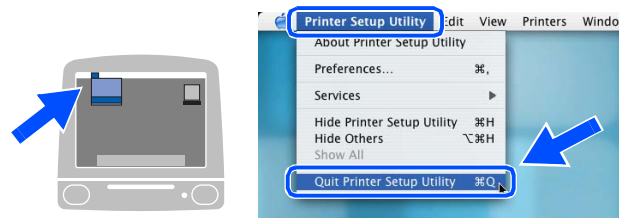

- OK!** The **MFL-Pro Suite**, **Printer driver**, **Scanner driver** and **Remote Setup Program** have been installed and the installation is now complete.

Scanning and ControlCenter2.0 is not supported in Mac OS® X 10.1.

- 18 To install **Presto!® PageManager®**, click the **Presto! PageManager** icon and follow the on-screen instructions.



You can easily scan, share and organize photos and documents using Presto!® PageManager®.

- OK!** **Presto!® PageManager®** has been installed and the installation is now complete.

For Network Interface Cable Users

For Mac OS[®] 8.6 to 9.2

Make sure that you have completed the instructions from Step 1 “Setting Up the Machine” on pages 2 - 7.

- 1 Make sure that the NC-9100h (Network Print/Fax Server) is installed into the MFC. (See “Optional accessories” in Chapter 13 of the User’s Guide.)
- 2 Disconnect the MFC from the power socket and from the Macintosh[®], if you have already connected an interface cable.

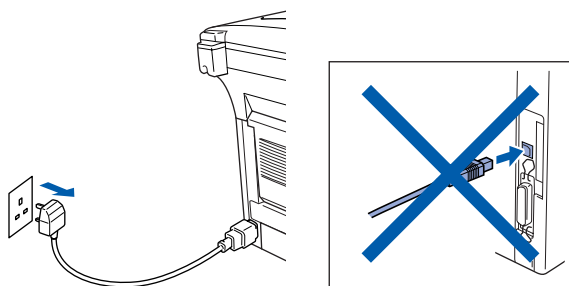

- 3 Turn on your Macintosh[®].
- 4 Insert the supplied CD-ROM into your CD-ROM drive.



- 5 Double-click the **Start Here OS 8.6-9.2** icon to install the printer and scanner drivers. If the language screen appears, select your language.

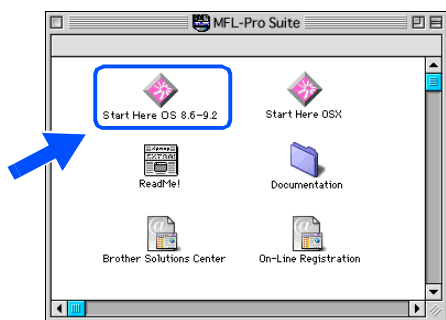

- 6 Click **MFL-Pro Suite** to install.



- 7 Follow the on-screen instructions, and restart your Macintosh[®].
- 8 Connect the network interface cable to the MFC, and then connect it to a free port on your hub.

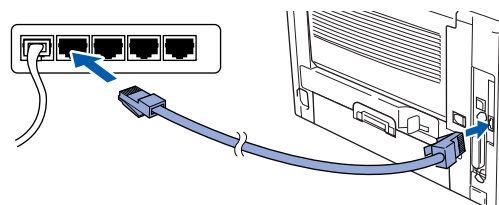

- 9 Plug in the power cord and turn on the MFC.

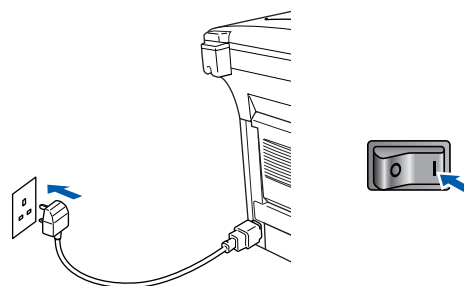

- 10 Open the **Chooser** from the **Apple** menu.



- 11 Click the **Brother Laser (AT)** icon, and then select **BRN_XXXXXX_P1**.
Close the **Chooser**.

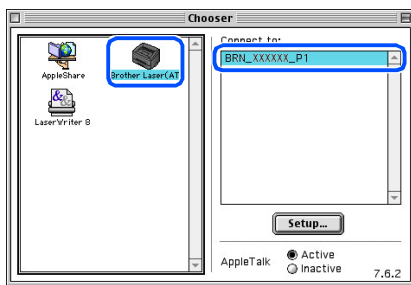

xxxxxx are the last six digits of the Ethernet address.



Network User's Guide Chapter 7 on the CD-ROM.

- OK!** The setup is now complete.

For Network Interface Cable Users

For Mac OS® X 10.1/10.2.1 or greater

Make sure that you have completed the instructions from Step 1 “Setting Up the Machine” on pages 2 - 7.

- 1 Make sure that the NC-9100h (Network Print/Fax Server) is installed into the MFC. (See “Optional accessories” in Chapter 13 of the User’s Guide.)
- 2 Disconnect the MFC from the power socket and from the Macintosh®, if you have already connected an interface cable.

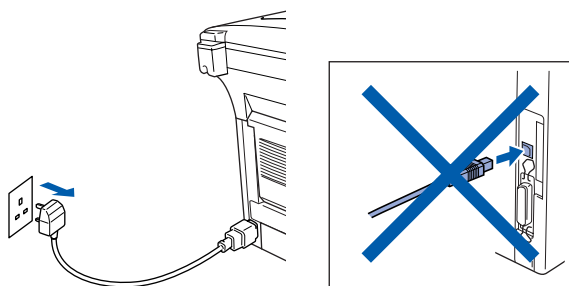

- 3 Turn on your Macintosh®.
- 4 Insert the supplied CD-ROM into your CD-ROM drive.



- 5 Double-click the **Start Here OSX** icon to install the printer driver and Remote Setup program. If the language screen appears, select your language.



- 6 Click **MFL-Pro Suite** to install.



- 7 Follow the on-screen instructions, and restart your Macintosh®.
- 8 After the **DeviceSelector** window appears, connect the network interface cable to your Macintosh® and then to the machine.



*The **DeviceSelector** window will not appear if you have also connected a USB interface cable to the machine before restarting your Macintosh® or if you are overwriting a previously installed version of the Brother Software. If you encounter this problem continue with skipping steps 11 through 13 and then see the Software User’s Guide Chapter 7 for details on selecting what machine the ControlCenter2.0 will connect with.*

- 9 Connect the network interface cable to the MFC, and then connect it to a free port on your hub.

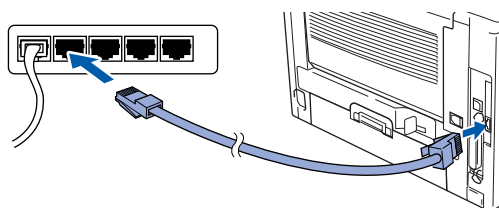

- 10 Plug in the power cord and turn on the MFC.

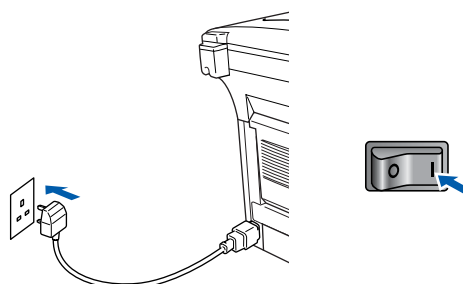

- 11 Select **Network** and then click **OK**.

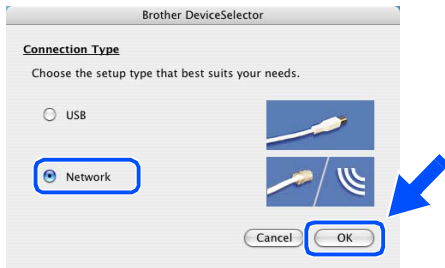

- 12 Click **Browse**.

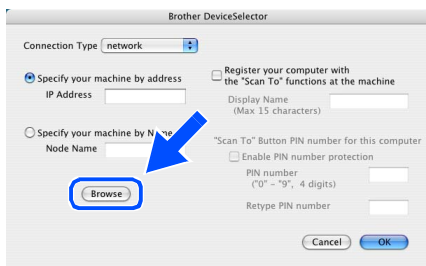

- 13 Select your model name, and then click **OK**. Then click **OK** again to close the **DeviceSelector**.

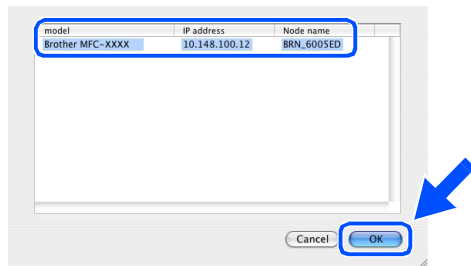

- 14 Select **Applications** from the **Go** menu.

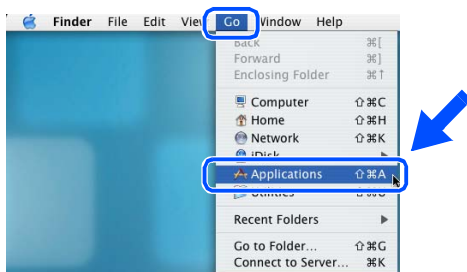

- 15 Open the **Utilities** folder.



- 16 Open the **Print Center** icon.



- 17 Click **Add**.

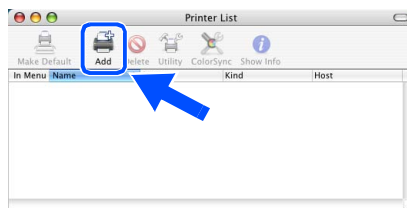

- 18 Select **AppleTalk**.

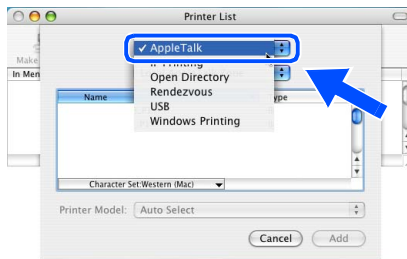

- 19 Select **BRN_XXXXXX_P1** and then click the **Add** button.

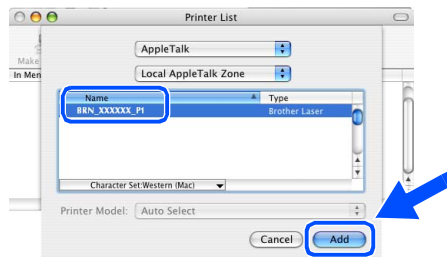

xxxxxx are the last six digits of the Ethernet address.

- 20 Select **Quit Printer Setup Utility** from the **Printer Setup Utility** menu.

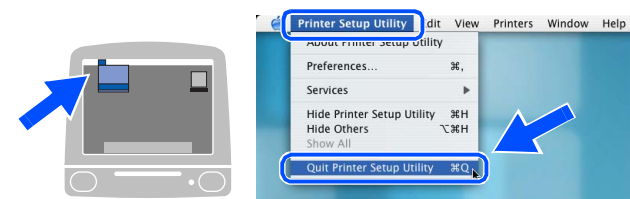

OK! The setup is now complete.

Please see Network User's Guide Chapter 7 on the CD-ROM for more information about using Simple Network Configuration.

■ For Administrators

This section is for using the printer on a network. An administrator should set up the printer using the following steps.

Network User's Guide Chapter Map (NC-9100h)

Windows®

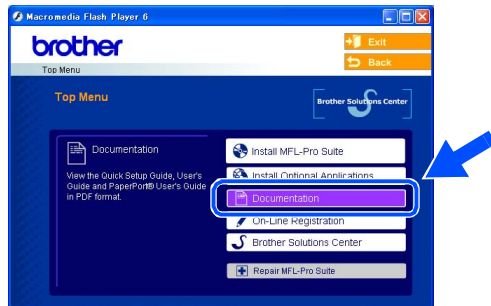

Macintosh®



Windows® 98/Me	Peer-to-Peer	TCP/IP	Chapter 3	Peer-to-Peer Printing
		NetBIOS	Chapter 4	NetBIOS Peer-to-Peer Printing
	Brother Internet Print	TCP/IP	Chapter 5	Configuring Internet Print for Windows®
	Netware	IPX/SPX	Chapter 6	Novell Netware Printing
Windows NT®	Peer-to-Peer	TCP/IP	Chapter 2	TCP/IP Printing
		NetBIOS	Chapter 4	NetBIOS Peer-to-Peer Printing
		DLC/LLC	Chapter 8	DLC Printing
	Brother Internet Print (NT® 4.0 only)	TCP/IP	Chapter 5	Configuring Internet Print for Windows®
Netware	IPX/SPX	Chapter 6	Novell Netware Printing	
Windows® 2000/XP	Peer-to-Peer (Windows® 2000 only)	TCP/IP	Chapter 2	TCP/IP Printing
		NetBIOS	Chapter 4	NetBIOS Peer-to-Peer Printing
		DLC/LLC	Chapter 8	DLC Printing
	IPP (Internet Printing Protocol)	TCP/IP	Chapter 2	TCP/IP Printing
	Brother Internet Print	TCP/IP	Chapter 5	Configuring Internet Print for Windows®
Netware	IPX/SPX	Chapter 6	Novell Netware Printing	
UNIX/Linux		TCP/IP	Chapter 1	UNIX Printing
Macintosh®		AppleTalk	Chapter 7	Apple talk (Ether Talk TCP/IP Printing)
		TCP/IP	Chapter 7	Apple talk (Ether Talk TCP/IP Printing)
		Simple Network Configuration	Chapter 7	Simple Network Configuration
OS2 Warp Server LAN Server		TCP/IP	Chapter 2	TCP/IP Printing
		NetBIOS	Chapter 4	NetBIOS Peer-to-Peer Printing

Installing the BRAdmin Professional Configuration Utility (Windows® Users Only)

The BRAdmin Professional utility is designed to manage your Brother network connected devices such as network-ready Multifunction devices and/or network-ready printers in a Local Area Network (LAN) environment.

BRAdmin Professional can also be used to manage devices from other manufacturers whose products support SNMP (Simple Network Management Protocol).

For more information on BRAdmin Professional go to <http://solutions.brother.com>

- 1 Insert the supplied CD-ROM into your CD-ROM drive. The opening screen will appear automatically. Follow the on-screen instructions.



- 2 Click the **Install Optional Applications** icon on the main menu screen.



- 3 Click **BRAdmin Professional** and follow the on-screen instructions.

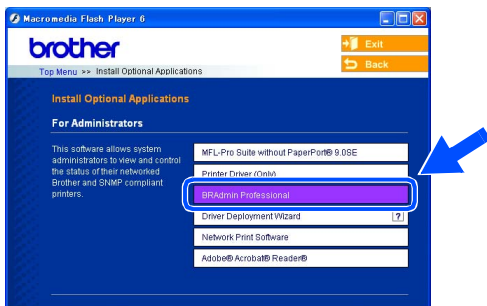

The default password for the print server is **“access”**. You can use BRAdmin Professional or a web browser to change this password.

Setting Up
the Machine

Windows®
USB

Windows®
Parallel

Windows
NT® 4.0
Parallel

Windows®
Network

Macintosh®
USB

Macintosh®
Network

For
Administrators

Setting your IP Address, Subnet Mask and Gateway using BRAdmin Professional (Windows® Users Only)

- 1 Start BRAdmin Professional, and select **TCP/IP**.

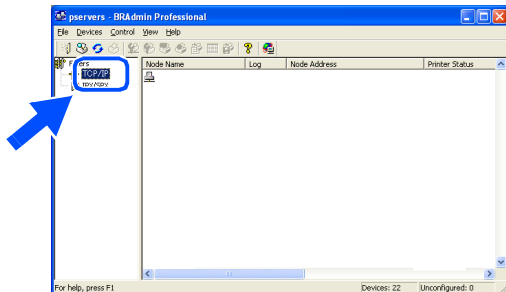

- 2 Select **Search Active Devices** from the **Devices** menu. BRAdmin will search for new devices automatically.

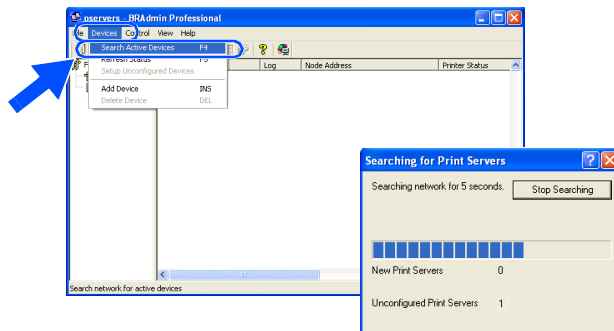

- 3 Double-click the new device.

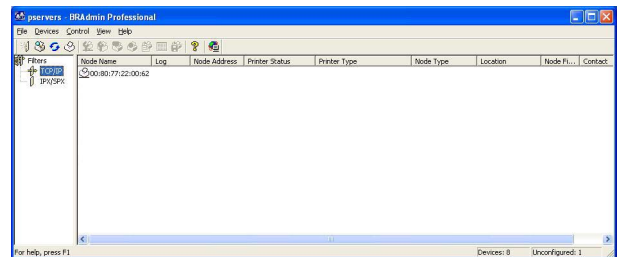

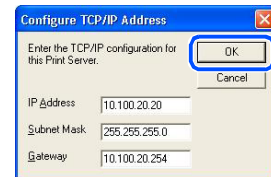

- 4 Enter the **IP Address**, **Subnet Mask** and **Gateway**, and then click the **OK** button.



- 5 The address information will be saved to the printer.

Options

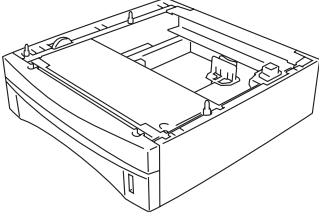
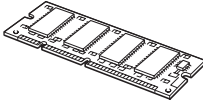
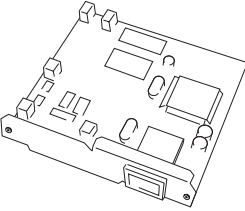
The MFC has the following optional accessories. You can expand the capabilities of the MFC by adding these items.

<p align="center">Lower Tray Unit</p>	<p align="center">DIMM Memory</p>
<p align="center">LT-5000</p>	
 <p>Second lower paper tray expands total input capacity by another 250 sheets to a total input capacity of 500 sheets.</p>	 <p>For more details, see "Memory Board" in Chapter 13 (User's Guide).</p>
<p align="center">Network Print/Fax Server</p>	<p align="center">External Wireless Print/Scan Server</p>
<p align="center">NC-9100h</p>	<p align="center">NC-2200w</p>
 <p>The optional Network Print/Fax Server (NC-9100h) transforms your MFC into a Network Multi Function Center, offering Network Printing / Network PC-FAX and Network Scanning capability.</p>	 <p>The optional External Wireless Print/Scan Server (NC-2200w) provides wireless (IEEE 802.11b) network printing and the network scanning capability.</p>

Replacement Consumables

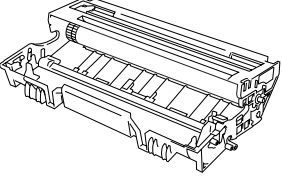
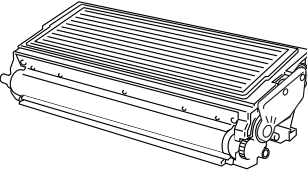
<p align="center">Drum Unit</p>	<p align="center">Toner</p>
<p align="center">DR-3000</p>	<p align="center">TN-3030 / TN-3060</p>
 <p>Up to 20,000 A4/Letter pages @ 5% coverage.</p>	 <p>TN-3030: Up to 3,500 A4/Letter pages @ 5% coverage. TN-3060: Up to 6,700 A4/Letter pages @ 5% coverage.</p>

Trademarks

The Brother logo is a registered trademark of Brother Industries, Ltd.

Brother is a registered trademark of Brother Industries, Ltd.

Multi-Function Link is a registered trademark of Brother International Corporation.

© Copyright 2004 Brother Industries, Ltd. All rights reserved.

Windows, Microsoft and Windows NT are registered trademarks of Microsoft in the U.S. and other countries.

Macintosh, QuickDraw, iMac and iBook are trademarks or registered trademarks of Apple Computer, Inc.

Postscript and Postscript Level 3 are registered trademarks or trademarks of Adobe Systems Incorporated.

PaperPort and TextBridge are registered trademarks of ScanSoft, Inc.

Presto! PageManager is a registered trademark of NewSoft Technology Corporation.

Each company whose software title is mentioned in this manual has a Software License Agreement specific to its proprietary programs.

All other brand and product names mentioned in this manual are registered trademarks of their respective companies.

Compilation and Publication

Under the supervision of Brother Industries Ltd., this manual has been compiled and published, covering the latest product descriptions and specifications.

The contents of this manual and the specifications of this product are subject to change without notice.

Brother reserves the right to make changes without notice in the specifications and materials contained herein and shall not be responsible for any damages (including consequential) caused by reliance on the materials presented, including but not limited to typographical and other errors relating to the publication.

This product is designed for use in a Professional Environment.

At your side.
brother®



UK
LF6361001①