

HL-5240
HL-5240L
HL-5250DN

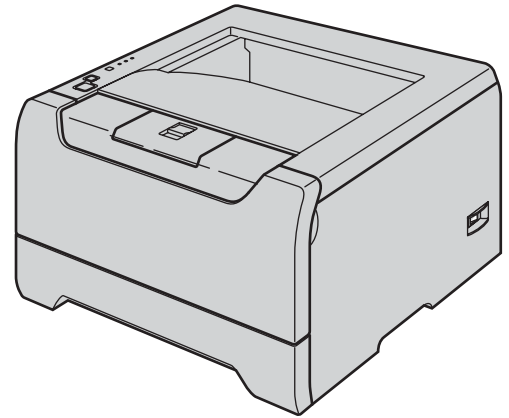

Before you can use the printer, you must set up the hardware and install the driver. Please read this 'Quick Setup Guide' for proper set up and installation instructions.

STEP 1

Setting Up the Machine



STEP 2

Installing the Printer Driver







Setup is Complete!



How to use the printer, see the User's Guide in the CD-ROM.

Keep this 'Quick Setup Guide' and the supplied CD-ROM in a convenient place for quick and easy reference at all times.

Symbols used in this guide

 Warning	 Electrical Hazard	 Hot Surface	 Caution
Warnings tell you what to do to prevent possible personal injury.	Electrical Hazard icons alert you to a possible electrical shock.	Hot Surface icons warn you not to touch machine parts that are hot.	Cautions specify procedures you must follow or avoid to prevent possible damage to the printer or other objects.
 Improper Setup	 Note	 User's Guide Network User's Guide	
Improper Setup icons alert you to devices and operations that are not compatible with the printer.	Notes tell you how you should respond to a situation that may arise or give tips about how the current operation works with other features.	Indicates reference to the User's Guide or Network User's Guide which is on the CD-ROM we have supplied.	

Trademarks

The Brother logo is a registered trademark of Brother Industries, Ltd.

Apple, the Apple Logo, Macintosh and TrueType are registered trademarks of Apple Computer, Inc in the United States and other countries.

Epson is a registered trademark and FX-80 and FX-850 are trademarks of Seiko Epson Corporation.

Hewlett Packard is a registered trademark and HP LaserJet 6P, 6L, 5P, 5L, 4, 4L 4P, III, IIIP, II, and IIP are trademarks of Hewlett-Packard Company.

IBM, IBM PC, and Proprinter are registered trademarks of International Business Machines Corporation.

Microsoft, MS-DOS, Windows and Windows NT are registered trademarks of Microsoft Corporation in the U.S. and other countries.

PostScript and PostScript 3 are trademarks of Adobe Systems Incorporated.

Java and all Java-based trademarks and logos are trademarks or registered trademarks of Sun Microsystems, Inc. in the United States and other countries.

All other terms and brand and product names mentioned in this Quick Setup Guide are registered trademarks of their respective companies.

Compilation and Publication

This manual has been compiled and published, under the supervision of Brother Industries Ltd., covering the latest product descriptions and specifications.

The contents of this manual and the specifications of this product are subject to change without notice.

Brother reserves the right to make changes without notice in the specifications and materials contained herein and shall not be responsible for any damages (including consequential) caused by reliance on the materials presented, including but not limited to typographical and other errors relating to the publication.

This product is designed for use in a professional environment.

© 2005 Brother Industries, Ltd. © 1998-2005 TROY Group, Inc. © 1983-2005 PACIFIC SOFTWARES INC.

This product includes the "KASAGO TCP/IP" software developed by Elmic Systems, Inc. ALL RIGHTS RESERVED.

Safety Precautions	2
Regulations	3

Getting Started

What is in the box?.....	5
Control panel.....	6
Printer LED Indications	6
Supplied CD-ROM	7

STEP 1 – Setting Up the Machine

Put the CD-ROM into the CD-ROM drive.....	8
Install the drum unit and toner cartridge assembly	9
Load paper in the paper tray	9
Print a test page	10

STEP 2 – Installing the Printer Driver

Windows®

For USB interface cable users (Windows® 98/Me/2000/XP only).....	12
For parallel interface cable users	13
For network interface cable users (For HL-5250DN)	14
For Brother Peer-to-Peer network printer users (LPR/NetBIOS)	14
For shared network printer users	15

Macintosh®

For USB interface cable users	16
For Mac OS® X 10.2.4 or greater users.....	16
For Mac OS® 9.1 to 9.2 users.....	17
For network interface cable users (For HL-5250DN)	18
For Mac OS® X 10.2.4 or greater users.....	18
For Mac OS® 9.1 to 9.2 users.....	19

Repacking Information

Shipment of the printer.....	21
------------------------------	----

Troubleshooting

 **User's Guide Chapter 7**

Safety Precautions

To Use the Printer Safely

Warning



There are high voltage electrodes inside the printer. Before you clean the inside of the printer, make sure that you have turned off the power switch and unplugged the printer from the AC power outlet.

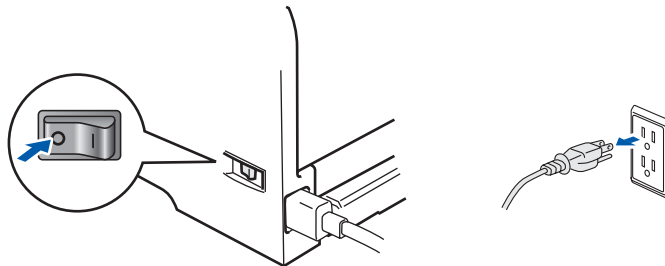

DO NOT handle the plug with wet hands. Doing this might cause an electrical shock.

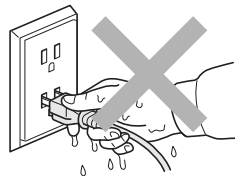

After you have just used the printer, some internal parts of the printer will be extremely hot. DO NOT touch the shaded parts shown in the illustration when you open the front or back cover of the printer.

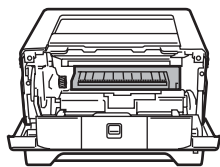

Inside the printer (Front View)

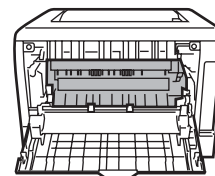

Open the back cover (Back View)



DO NOT remove or damage the caution labels located on or around the fuser.

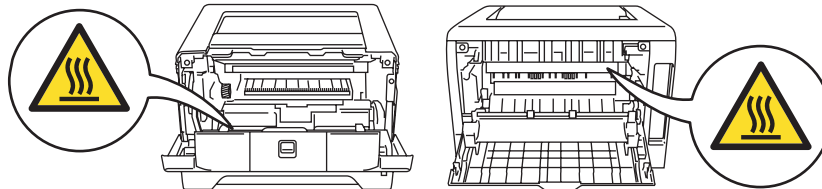

DO NOT use a vacuum cleaner to clean up scattered toner. Doing this might cause the toner dust to ignite inside the vacuum cleaner, potentially starting a fire. Please carefully clean the toner dust with a dry, lint-free cloth and dispose of it according to local regulations.



DO NOT use flammable substances near the printer. Doing this might cause a fire or electrical shock.

Regulations

Important

A shielded interface cable should be used in order to ensure compliance with the limits for a Class B digital device.

Changes or modifications not expressly approved by Brother Industries, Ltd. could void the user's authority to operate the equipment.

Radio interference (220-240 volt model only)

This printer follows EN55022 (CISPR Publication 22)/Class B.

Before you use this product, make sure that you use one of the following interface cables.

1 A shielded parallel interface cable with twisted-pair conductors and that it is marked "IEEE 1284 compliant".

2 A USB cable.

The cable must not be more than 2 metres long.

EC Declaration of Conformity



EC Declaration of Conformity

Manufacturer

Brother Industries Ltd.,
15-1, Naeshiro-cho, Mizuho-ku,
Nagoya 467-8561, Japan

Plant

Brother Corporation (Asia) Ltd.,
Brother Buji Nan Ling Factory,
Gold Garden Ind., Nan Ling Village,
Buji, Rong Gang, Shenzhen, China

Herewith declare that:

Products description : Laser Printer
Product Name : HL-5240, HL-5250DN
Model Number : HL-52

are in conformity with provisions of the Directives applied : Low Voltage Directive 73/23/EEC (as amended by 93/68/EEC) and the Electromagnetic Compatibility Directive 89/336/EEC (as amended by 91/263/EEC and 92/31/EEC and 93/68/EEC).

Standards applied :

Harmonized : Safety : EN60950-1:2001

EMC : EN55022: 1998 +A1: 2000 +A2: 2003 Class B
EN55024: 1998 +A1: 2001 +A2: 2003
EN61000-3-2: 2000
EN61000-3-3: 1995 +A1: 2001

Year in which CE marking was first affixed : 2005

Issued by : Brother Industries, Ltd.

Date : 10th May, 2005

Place : Nagoya, Japan

Signature :

Takashi Maeda
Manager
Quality Management Group
Quality Management Dept.
Information & Document Company

IEC 60825-1 specification (220 to 240 volt model only)

This printer is a Class 1 laser product as defined in IEC 60825-1 specifications. The label shown below is attached in countries where it is needed.



This printer has a Class 3B laser diode which produces invisible laser radiation in the scanner unit. You should not open the scanner unit under any circumstances.

! Caution

Use of controls or adjustments or performance of procedures other than those specified herein may result in hazardous radiation exposure.

Internal laser radiation

Maximum radiation power: 5 mW
Wave length: 770 - 810 nm
Laser class: Class 3B

IMPORTANT - For Your Safety

To ensure safe operation, the supplied three-pin plug must be inserted only into a standard three-pin power outlet that is properly grounded through the normal household wiring.

Extension cords used with this printer must be three-pin plug type and correctly wired to provide proper grounding. Incorrectly wired extension cords may cause personal injury and equipment damage.

The fact that the equipment operates satisfactorily does not imply that the power is grounded and that the installation is completely safe. For your safety, if in any doubt about the effective grounding of the power, call a qualified electrician.

This product should be connected to an AC power source within the range indicated on the rating label. DO NOT connect it to a DC power source. If you are not sure, contact a qualified electrician.

Safety Precautions

Disconnect device

You must install this printer near a power outlet that is easily accessible. In case of an emergency, you must disconnect the power cord from the power outlet to shut off the power completely.

Caution for LAN connection (For model HL-5250DN only)

Connect this product to a LAN connection that is not subjected to over voltages.

IT power system (For Norway only)

This product is also designed for an IT power system with phase-to-phase voltage 230V.

Wiring information (for UK)

Important

If you need to replace the plug fuse, fit a fuse that is approved by ASTA to BS1362 with the same rating as the original fuse.

Always replace the fuse cover. Never use a plug that does not have a cover.

Warning - This printer must be earthed.

The wires in the mains lead are coloured in line with the following code:

Green and Yellow: Earth

Blue: Neutral

Brown: Live

If in any doubt, call a qualified electrician.

What is in the box?

Carton components may vary from one country to another.

Save all packing materials and the printer carton in case for any reason you must ship your printer.

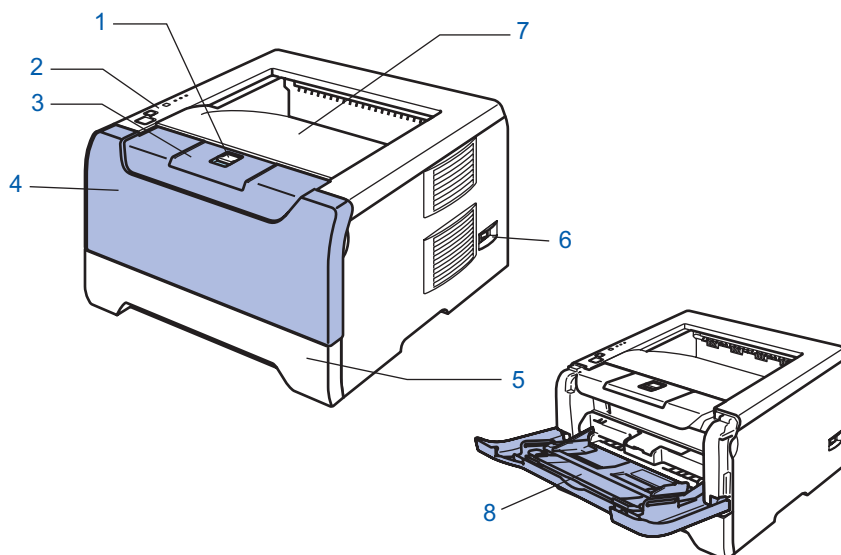

1 Front Cover Release Button

2 Control panel

3 Face-down output tray support flap (Support flap)



4 Front cover

5 Paper tray

6 Power switch

7 Face-down output tray

8 Multi-purpose tray (MP tray)

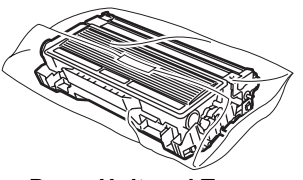
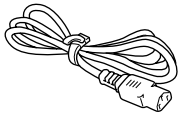
 <p>CD-ROM (including User's Guide)</p>	 <p>Quick Setup Guide</p>	 <p>Drum Unit and Toner Cartridge Assembly</p>	 <p>AC Power Cord</p>
---	---	---	---

The interface cable is not a standard accessory. Buy the proper interface cable for the interface you want to use (USB, Parallel or Network).

■ **USB cable**

Do not use a USB interface cable that is longer than 6 feet (2.0 meters).

Do not connect the USB cable to a non-powered hub or a Macintosh[®] keyboard.

Make sure that you connect it to the USB connector of your PC.

USB is not supported under Windows[®] 95 or Windows NT[®] 4.0.

■ **Parallel interface**

Do not use a parallel interface cable that is longer than 6 feet (2.0 meters).

Use a shielded interface cable that is IEEE 1284-compliant.

■ **Network cable (for HL-5250DN)**

Use a straight-through Category5 (or greater) twisted-pair cable for 10BASE-T or 100BASE-TX Fast Ethernet Network.

Control panel

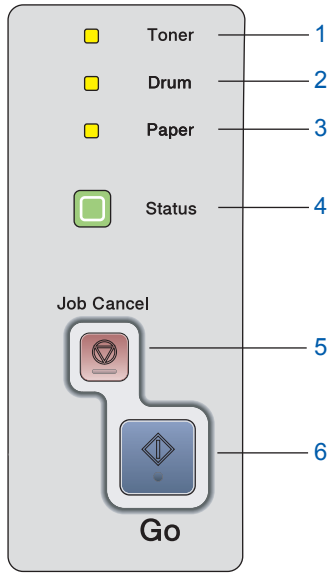

- 1 **Toner**
LED indicates when the Toner is low or at the end of its life.
- 2 **Drum**
LED indicates when the Drum is nearing the end of its life.
- 3 **Paper**
LED indicates when the paper tray is empty or there is a paper jam.
- 4 **Status**
LED will flash and change color depending on the printer status.
- 5 **Job Cancel button**
stops and cancels the print operation in progress.
- 6 **Go button**
Wake-up / Error recovery / Form feed / Reprint



For the details of the control panel, see Chapter 4 of the User's Guide on the CD-ROM.

Printer LED Indications

★: Blinking

■: ON

□: OFF

Printer LED	Sleep / OFF	Warming up Cooling down	Ready	Receiving data	Print Data remaining
Toner	□	□	□	□	□
Drum	□	□	□	□	□
Paper	□	□	□	□	□
Status	□	★ Green ²	■ Green	★ Yellow ²	■ Yellow

Printer LED	Toner low	Toner life end	Drum near end of life	Cover open	No paper Paper jam	Service call
Toner	★ Yellow ¹	■ Yellow	□	□	□	★ Yellow ²
Drum	□	□	★ Yellow ¹	□	□	★ Yellow ²
Paper	□	□	□	□	★ Yellow ²	★ Yellow ²
Status	■ Green	■ Red	■ Green	■ Red	■ Red	★ Red ²
User's Guide	Chapter 6	Chapter 6	Chapter 6	Chapter 7	Chapter 7	Chapter 4

¹ The LED will blink in a pattern of ON for 2 seconds and then OFF for 3 seconds.

² The LED will blink fast.

Supplied CD-ROM

You can find a variety of information on the CD-ROM.

Windows®

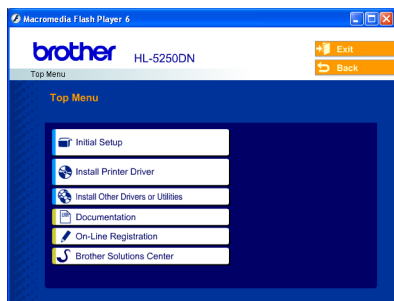

Macintosh®

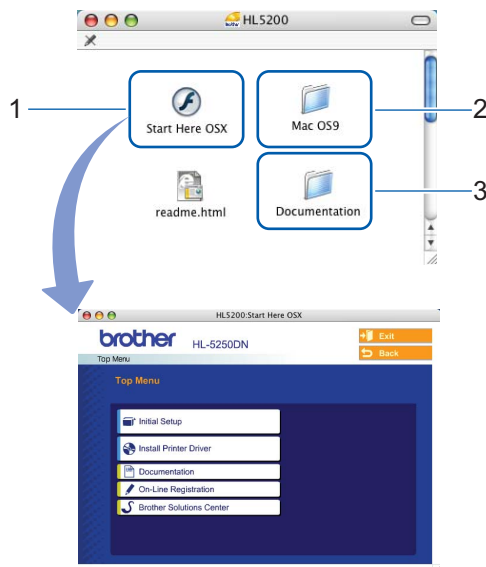

- 1 Mac OS® X 10.2.4 or greater Users
- 2 Mac OS® 9.1 to 9.2 Users
The menu screen is not supported by Mac OS® 9.1 to 9.2.
- 3 View the User's Guide and Network User's Guide in PDF format.
(See  Documentation below.)

Initial Setup

Instructional movie for printer setup.

Install Printer Driver

Install the printer driver.

Install Other Driver or Utilities (For Windows® users)

Install optional drivers, utilities and Network management tools (For HL-5250DN users).

Documentation

View the Printer User's Guide and Network User's Guide (For HL-5250DN) in PDF format (Viewer included).

The User's Guide in PDF format will be installed automatically when you install the driver. (For Windows® users only) Click the **Start** button, **Programs**¹, your printer (e.g. Brother HL-5250DN), and then User's Guide. If you do not want to install the User's Guide, choose **Custom setup** from **Install Printer Driver**, and uncheck **User's Guide in PDF format** when you install the driver.

¹ All Programs for Windows® XP users

On-Line Registration

Register your product on-line.

Brother Solutions Center

The Brother Solutions Center (<http://solutions.brother.com>) is a one-stop resource for all your printer needs.

Download the latest drivers and utilities for your printers, read FAQs and troubleshooting tips, or learn about printer solutions.

Note

For visually impaired users, we have prepared an HTML file on the supplied CD-ROM: readme.html. This file can be read by Screen Reader 'text-to-speech' software.

1 Put the CD-ROM into the CD-ROM drive

For Windows® users

⊘ Improper Setup

DO NOT connect the interface cable.
Connecting the interface cable is done when installing the driver.

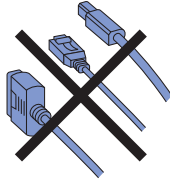

- 1 Put the supplied CD-ROM into your CD-ROM drive. The opening screen will appear automatically.
Choose your printer model and the language.

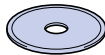

- 2 Click **Initial Setup** on the menu screen.

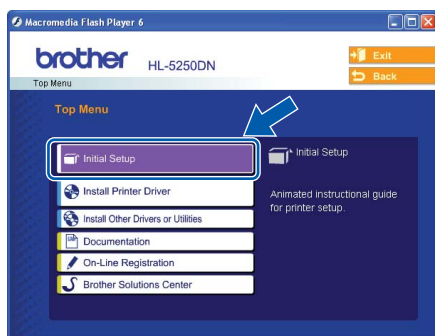

- 3 You can view the initial setup instructions and follow along with the steps on the next page.



For Macintosh® users

⊘ Improper Setup

DO NOT connect the interface cable.
Connecting the interface cable is done when installing the driver.

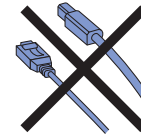

- 1 For Mac OS® 9.1 to 9.2 Users, go to next page. For Mac OS® 10.2.4 or greater Users, put the supplied CD-ROM into your CD-ROM drive, and then double-click the **HL5200** icon on your desktop. Double-click the **Start Here OS X** icon. Follow the on-screen instructions.



- 2 Click **Initial Setup** on the menu screen.



- 3 You can view the initial setup instructions and follow along with the steps on the next page.

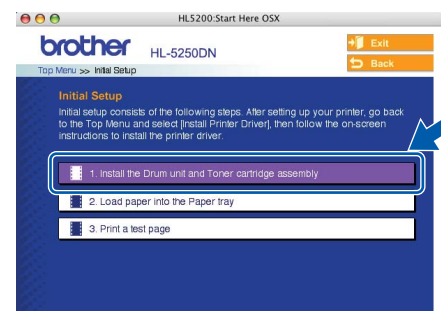

2 Install the drum unit and toner cartridge assembly

⊘ Improper Setup

DO NOT connect the interface cable yet.

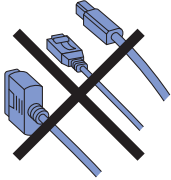

- 1 Press the front cover release button and open the front cover (1).

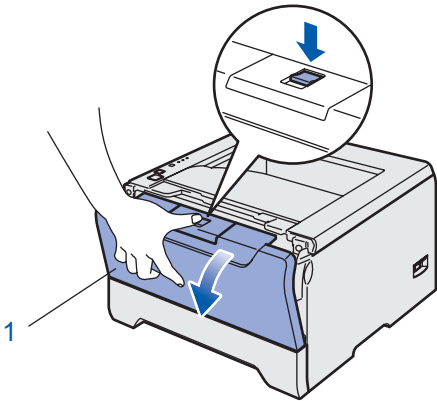

- 2 Unpack the drum unit and toner cartridge assembly.

- 3 Rock it from side to side several times to distribute the toner evenly inside the assembly.

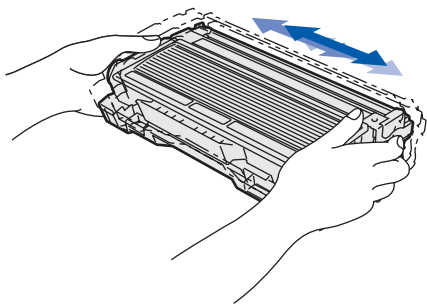

- 4 Put the drum unit and toner cartridge assembly into the printer.

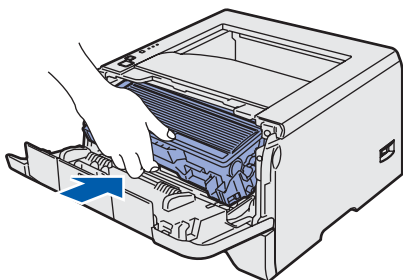

- 5 Close the front cover of the printer.

3 Load paper in the paper tray

- 1 Pull the paper tray completely out of the printer.

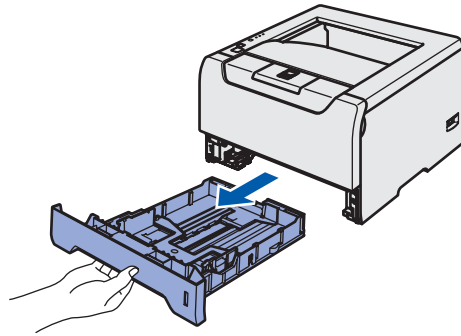

- 2 While pressing the blue paper-guide release lever (1), slide the paper guides to fit the paper size. Make sure that the guides are firmly in the slots.

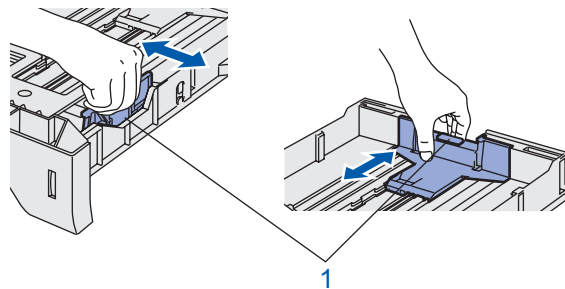
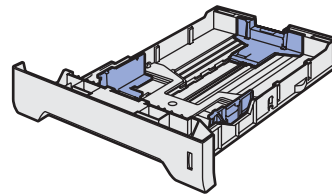

- 3 Fan the stack of paper well to avoid paper jams and misfeeds.

- 4 Put paper in the paper tray. Make sure that the paper is flat in the tray and below the maximum paper mark (1).

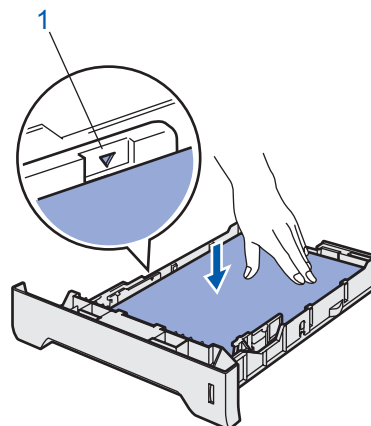

- 5 Put the paper tray firmly back in the printer.

4 Print a test page

⊘ Improper Setup

DO NOT connect the interface cable yet.

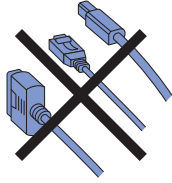

- 1 Make sure that the printer power switch is off. Connect the AC power cord to the printer.

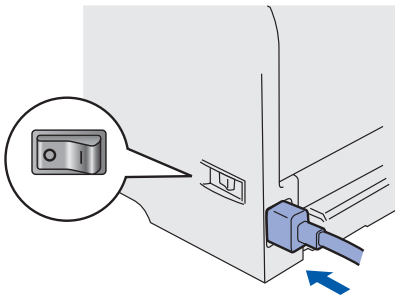

- 2 Plug the AC power cord into an AC power outlet. Turn on the printer power switch.

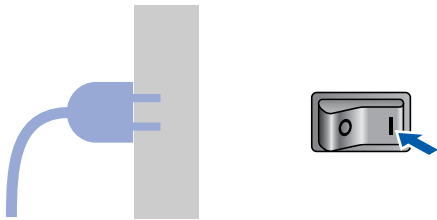

- 3 After the printer has finished warming up, the **Status** LED stops blinking and stays green.

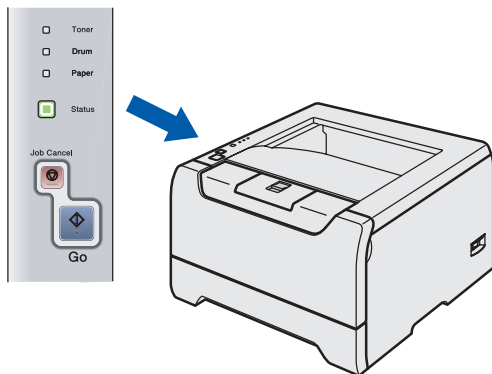

- 4 Press **Go**. The printer prints a test page. Check that the test page has printed correctly.

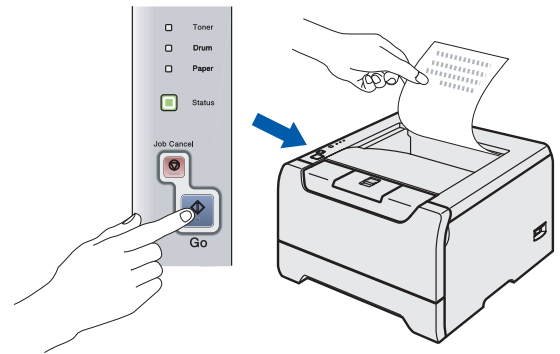

📄 Note

This function will not be available after the first print job you send from your PC.

Now go to

Go to the next page to install the driver.

STEP 2

Installing the Printer Driver

Follow the instructions on this page for your operating system and interface cable.
For the latest driver and to find the best solution for your problem or question, access the Brother Solutions Center directly from the CD-ROM / Driver or visit <http://solutions.brother.com>.

Windows®



For Windows® XP Professional x64 Edition users, visit <http://solutions.brother.com> for driver downloads and installation steps.

For USB interface cable users (Windows® 98/Me/2000/XP only) 12



For parallel interface cable users 13



For network interface cable users (For HL-5250DN) 14



- For Brother Peer-to-Peer network printer users (LPR/NetBIOS) 14
- For shared network printer users 15

Macintosh®

For USB interface cable users 16



- For Mac OS® X 10.2.4 or greater users 16
- For Mac OS® 9.1 to 9.2 users 17

For network interface cable users (For HL-5250DN) 18



- For Mac OS® X 10.2.4 or greater users 18
- For Mac OS® 9.1 to 9.2 users 19

For USB interface cable users (Windows® 98/Me/2000/XP only)



Note

If the **Found New Hardware Wizard** appears on your PC, click **Cancel**.

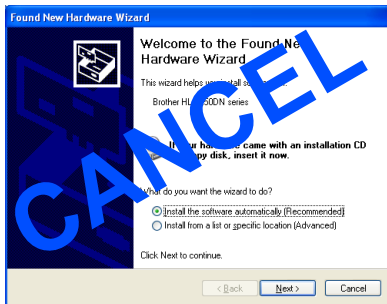

5

When this screen appears, make sure the printer power switch is on. Connect the USB interface cable to your PC, and then connect it to the printer. Click **Next**.

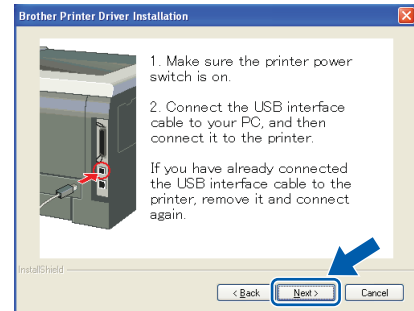

Installing the driver and connecting the printer to your PC

1

Make sure the USB interface cable is **NOT** connected to the printer, and then begin installing the driver. If you have already connected the cable, remove it.

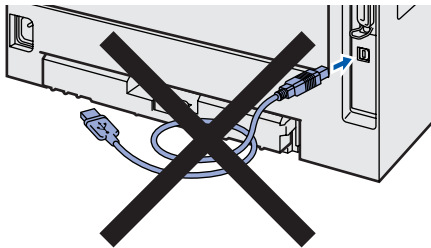

2

Click **Install Printer Driver** on the menu screen.



3

Click **USB cable users**.

4

When the License Agreement window appears, click **Yes** if you agree to the License Agreement.

6

Click **Finish**.



Note

If you want to register your product on-line, check **On-Line Registration**.



For Windows® 98/Me users, the setup is now complete.

Now go to

For Windows® 2000/XP users, go to 'Setting Your Printer as the Default Printer'.

Setting your printer as the default printer (For Windows® 2000/XP only)

- 1 Click the **Start** button and then **Printers and Faxes**.

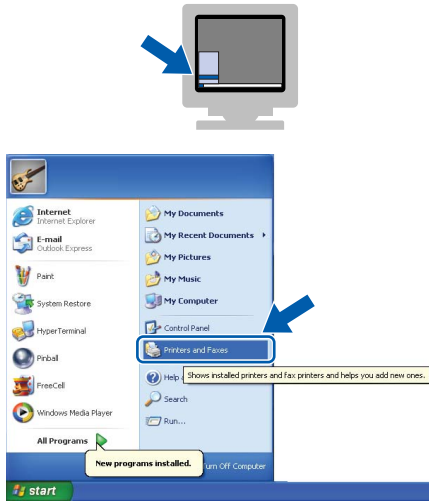

- 2 Choose the Brother Printer icon.

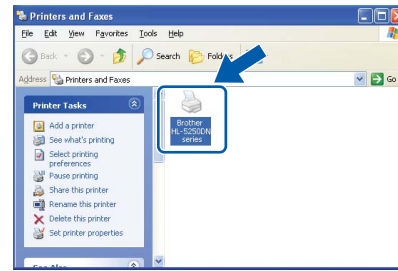

- 3 Click **File**, and then **Set as Default printer**.

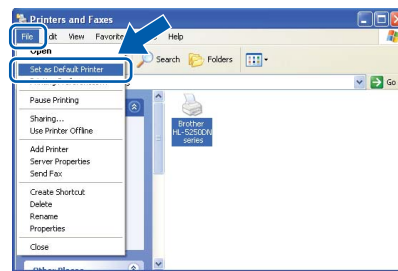

For parallel interface cable users

Note

If the **Found New Hardware Wizard** appears on your PC, click **Cancel**.

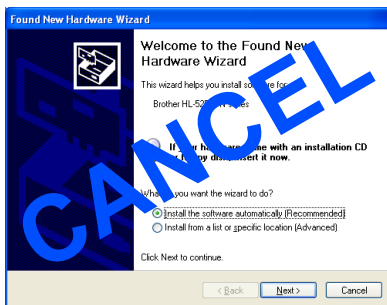

- 3 When the License Agreement window appears, click **Yes** if you agree to the License Agreement.

- 4 Click **Finish**.

Note

If you want to register your product on-line, check **On-Line Registration**.

- 5 Turn off the printer power switch.

- 6 Connect the parallel interface cable to your PC, and then connect it to your printer.

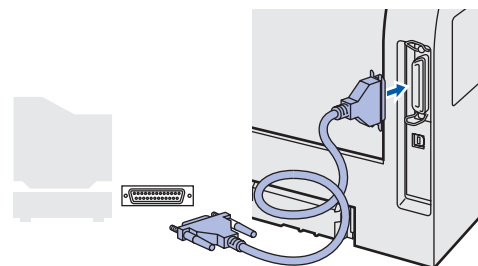

Connecting the printer to your PC and installing the driver

- 1 Click **Install Printer Driver** on the Menu screen.

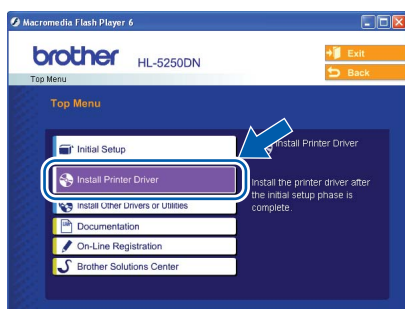

- 7 Turn on the printer power switch.

OK! The setup is now complete.

- 2 Click **Parallel cable users**.

For network interface cable users (For HL-5250DN)

For Brother Peer-to-Peer network printer users (LPR/NetBIOS)

Note

- If you are going to connect the printer to your network, we recommend that you contact your system administrator prior to installation or see the *Network User's Guide*.
- Before installation, if you are using Personal Firewall software (e.g. the Internet Connection Firewall available in Windows XP), disable it. Once you are sure that you can print, restart your Personal Firewall software.
- Peer-to-peer print with NetBIOS is not available for Windows® XP x64 Edition.

Connecting the printer to your network and installing the driver

- 1 Click **Install Printer Driver** on the menu screen.



- 2 Click **Network cable users**.
- 3 Turn off the printer power switch.
- 4 Connect the network interface cable to the printer, and then connect it to a free port on your hub.

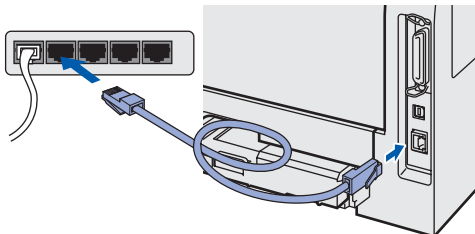

- 5 Turn on the printer power switch.
- 6 When the License Agreement window appears, click **Yes** if you agree to the License Agreement.

- 7 Choose **Brother Peer-to-Peer Network Printer**, and then click **Next**.

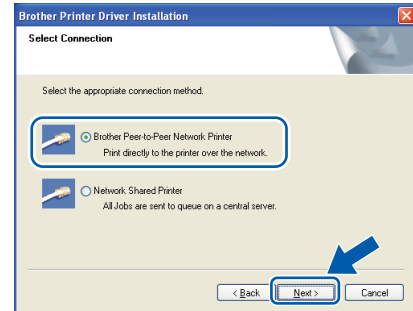

- 8 **For LPR Users:**
Choose **Search the network for devices and choose from a list of discovered devices (Recommended)**. Or enter your printer's IP address or its node name. Click **Next**.

For NetBIOS Users:
Choose **Search the network for devices and choose from a list of discovered devices (Recommended)**. Click **Next**.

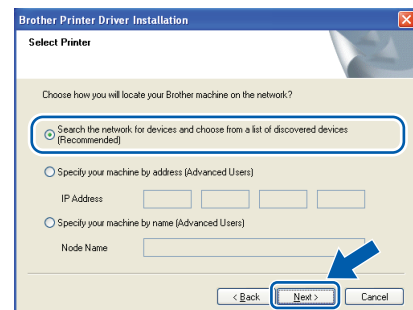

Note

Contact your administrator if you do not know the printer's IP address or node name.

- 9 **For LPR Users:**
Choose your printer and choose **LPR (Recommended)**, and then click **Next**.

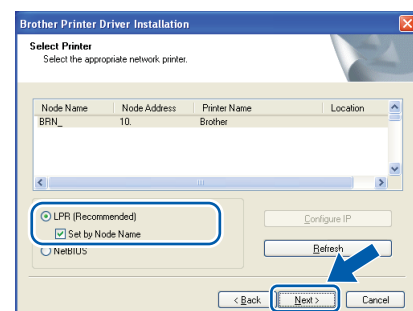

For NetBIOS Users:

Choose your printer and **NetBIOS**, and then click **Next**.

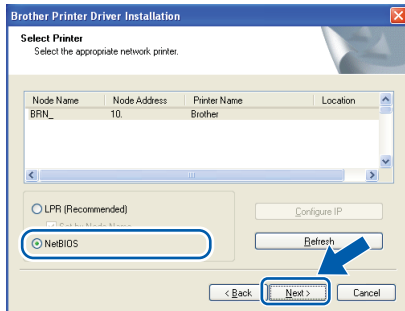

10 Click **Finish**.



Note

*If you want to register your product on-line, check **On-Line Registration**.*



For Windows NT® 4.0 and Windows® 2000/XP users, the setup is now complete.



For Windows® 95/98/Me users, the setup will be complete after your PC has restarted.

For shared network printer users



Note

If you are going to connect to a shared printer on your network, we recommend that you ask your system administrator about the queue or share name prior to installation.

Installing the driver and choosing the proper printer queue or share name

1 Click **Install Printer Driver** on the menu screen.

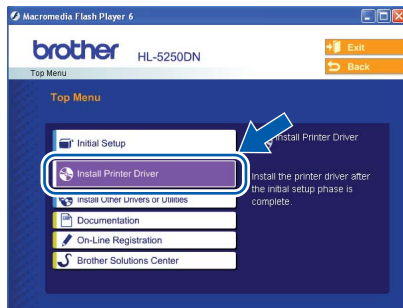

2 Click **Network cable users**.

3 When the License Agreement window appears, click **Yes** if you agree to the License Agreement.

4 Choose **Network Shared Printer**, and then click **Next**.

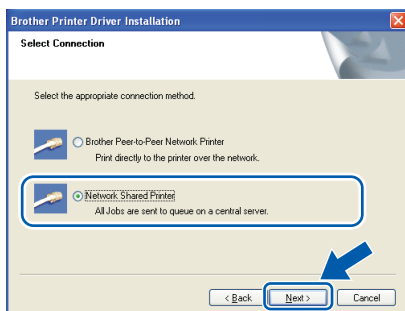

5

Choose your printer's queue, and then click **OK**.

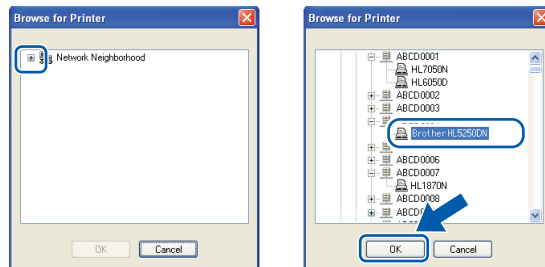

Note

Contact your administrator if you do not know about the location and name of the printer in the network.

6

Click **Finish**.



Note

*If you want to register your product on-line, check **On-Line Registration**.*



The setup is now complete.

For USB interface cable users

For Mac OS® X 10.2.4 or greater users

Connecting the printer to your Macintosh® and installing the driver

- 1 Click **Install Printer Driver** on the menu screen.

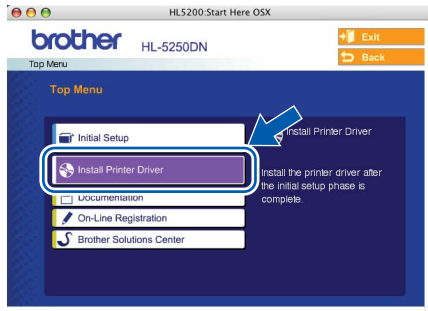

- 2 Click **USB cable users** and follow the on-screen instructions. Then, restart your Macintosh®.
- 3 Connect the USB interface cable to your Macintosh®, and then connect it to the printer.

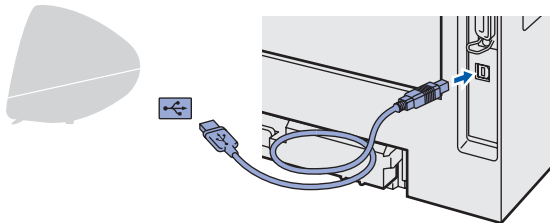

⊘ Improper Setup

DO NOT connect the printer to a USB port on a keyboard or a non-powered USB hub.

- 4 Make sure the printer power switch is on.
- 5 Click **Go**, then **Applications**.

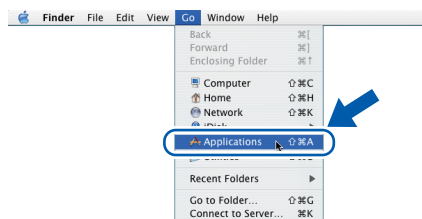

- 6 Double-click the **Utilities** folder.

- 7 Double-click the **Printer Setup Utility** icon.



Note

For Mac OS® X 10.2 users, open the **Print Center** icon.

- 8 Click **Add**.

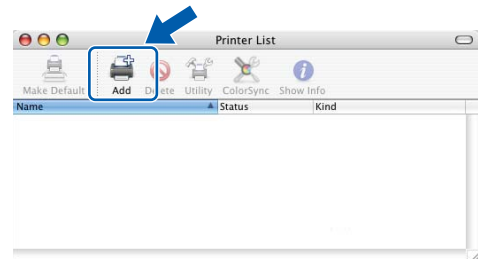

For Mac OS® 10.2.4 to 10.3 users:
Go to the next step.

For Mac OS® 10.4 or greater users:
Go to Step 10.

- 9 Choose **USB**.

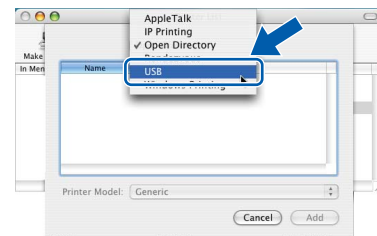

- 10 Choose the proper printer, and then click **Add**.
For Mac OS® 10.2 users:

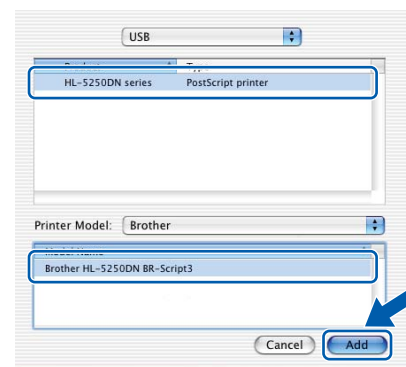

For Mac OS® 10.3 users:

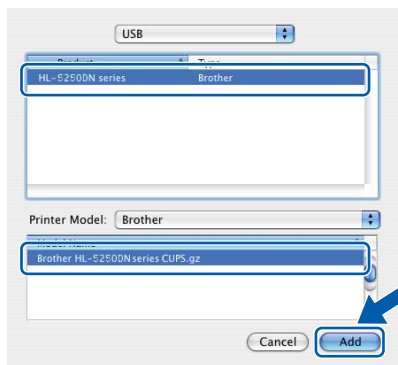

For Mac OS® 10.4 or greater users:

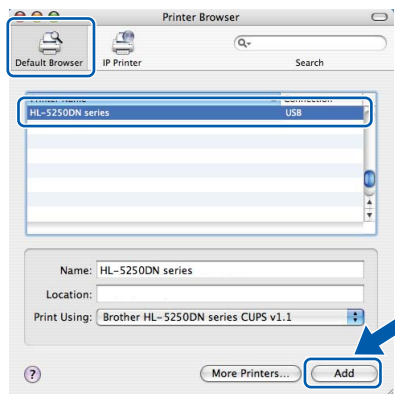

11 Click **Printer Setup Utility**, then **Quit Printer Setup Utility**.

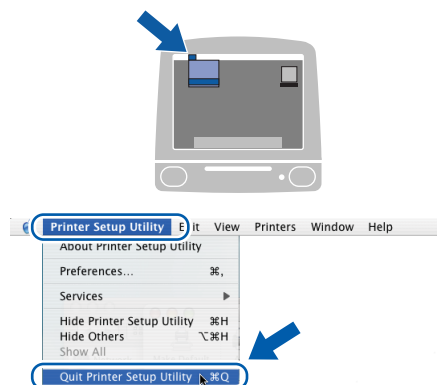

OK! The setup is now complete.

For Mac OS® 9.1 to 9.2 users

Connecting the printer to your Macintosh® and installing the driver

1 Put the supplied CD-ROM into your CD-ROM drive. Double-click the **Mac OS 9** folder.

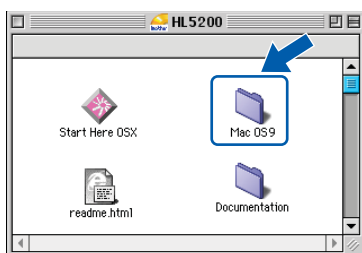

2 Double-click your language folder.



3 Double-click the **Printer Driver Installer** icon to install the printer driver. Follow the on-screen instructions and restart your Macintosh®.

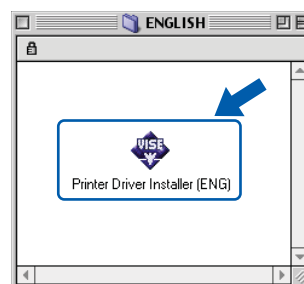

4 Connect the USB interface cable to your Macintosh®, and then connect it to the printer.

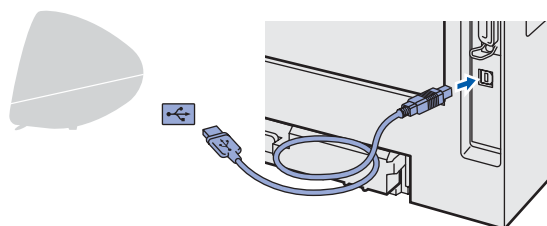

⊘ Improper Setup

DO NOT connect the printer to a USB port on a keyboard or a non-powered USB hub.

5 Make sure the printer power switch is on.

6 From the **Apple®** menu, click **Chooser**.

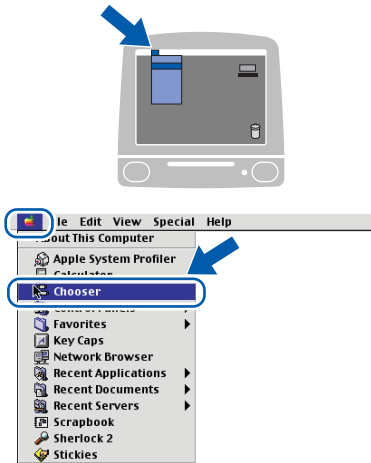

7 Click the **Brother Laser** icon. On the right side of the **Chooser**, choose the printer to which you want to print. Close the **Chooser**.

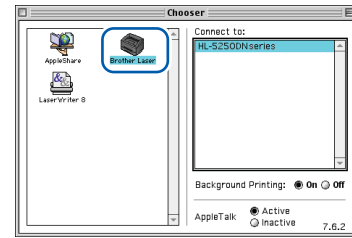

The setup is now complete.

For network interface cable users (For HL-5250DN)

For Mac OS® X 10.2.4 or greater users

Connecting the printer to your Macintosh® and installing the driver

1 Click **Install Printer Driver** on the menu screen.

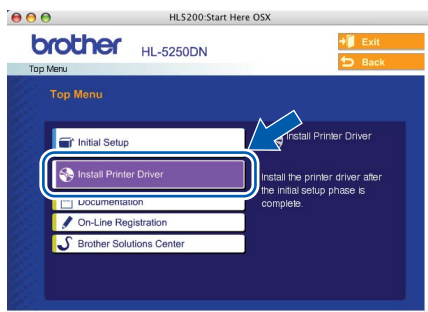

2 Click **Network cable users** and follow the on-screen instructions. Then, restart your Macintosh®.

3 Turn off the printer power switch.

4 Connect the network interface cable to the printer, and then connect it to a free port on your hub.

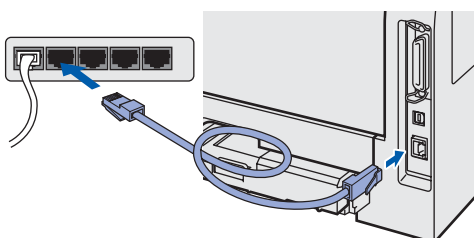

5 Turn on the printer power switch.

6 Click **Go**, then **Applications**.

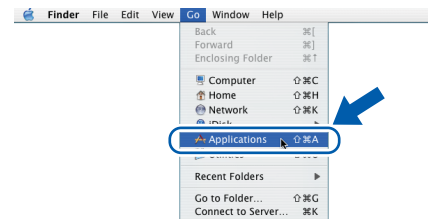

7 Double-click the **Utilities** folder.

8 Double-click the **Printer Setup Utility** icon.



Note

For Mac OS® X 10.2 users, open the **Print Center** icon.

9 Click **Add**.

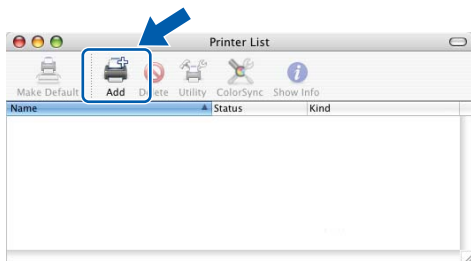

For Mac OS® 10.2.4 to 10.3 users:
Go to the next step.

For Mac OS® 10.4 or greater users:
Go to Step **12**.

10 Make the following selection.

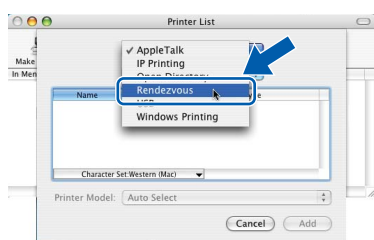

11 Choose **Brother HL-5250DN series**, and then click **Add**. Go to Step **13**.

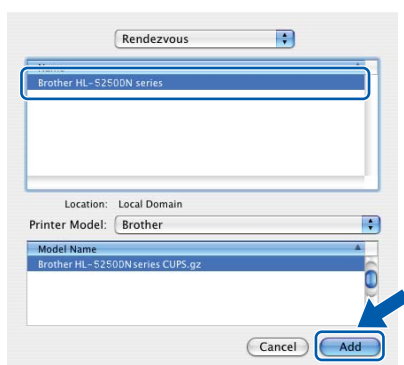

12 Choose **Brother HL-5250DN series**, and then click **Add**.

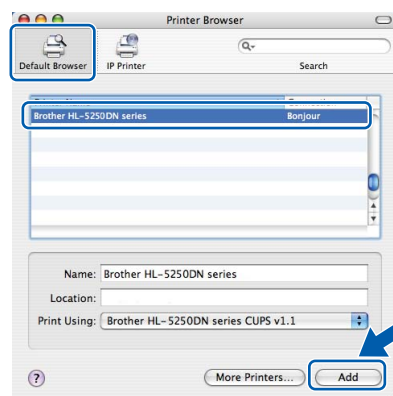

Note

If there is more than one of the same model printer (HL-5250DN) connected on your network, the Ethernet address (MAC address) will be displayed after the model name.



Network User's Guide Chapter 6 .

13 Click **Printer Setup Utility**, then **Quit Printer Setup Utility**.

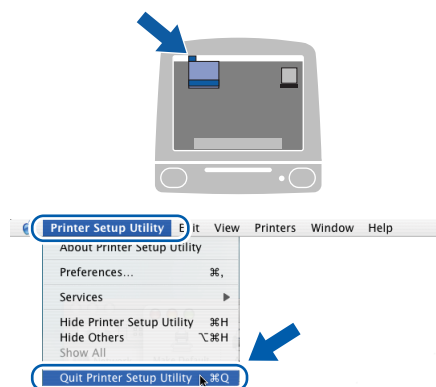

For Mac OS® 9.1 to 9.2 users

Connecting the printer to your Macintosh® and installing the driver

1 Turn off the printer power switch.

2 Connect the network interface cable to the printer, and then connect it to a free port on your hub.

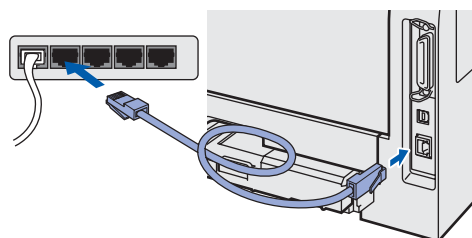

3 Turn on the printer power switch.



4 Put the supplied CD-ROM into your CD-ROM drive. Double-click the **Mac OS 9** folder.

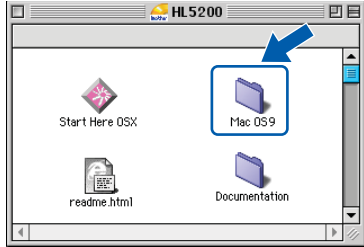

5 Double-click your language folder.



6 Double-click the **Printer Driver Installer** icon to install the printer driver. Follow the on-screen instructions.

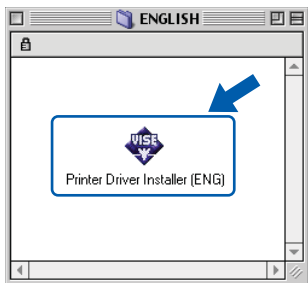

7 From the **Apple®** menu, click **Chooser**.

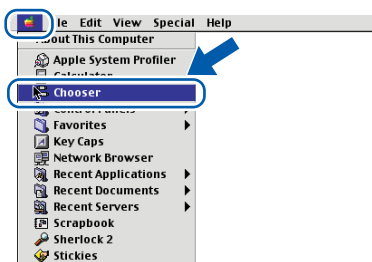
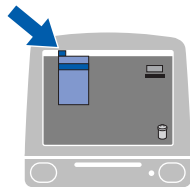

8 Click the **Brother Laser (IP)** icon, and then choose **BRN_XXXXXX** (where XXXXXX are the last six digits of the Ethernet address). Click **Setup...**

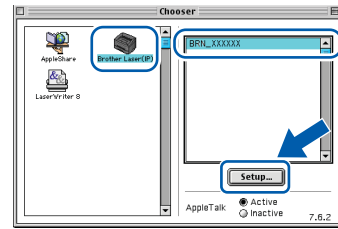

Network User's Guide Chapter 6.

9 Click **OK**.
Close the **Chooser**.

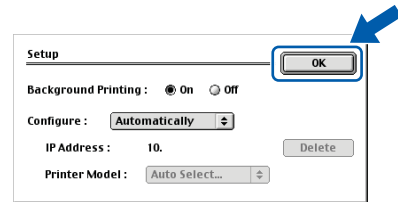

The setup is now complete.

Shipment of the printer

If for any reason you must ship your printer, carefully package the printer to avoid any damage during transit. We recommend that you save and use the original packaging. The printer should also be adequately insured with the carrier.

! Caution

When shipping the printer, the DRUM UNIT and TONER CARTRIDGE assembly must be removed from the printer and put in a plastic bag. Failure to remove the unit and put it in a plastic bag before shipping may cause severe damage to the printer and may VOID THE WARRANTY.

- 1 Turn off the printer power switch, and then unplug the AC power cord.

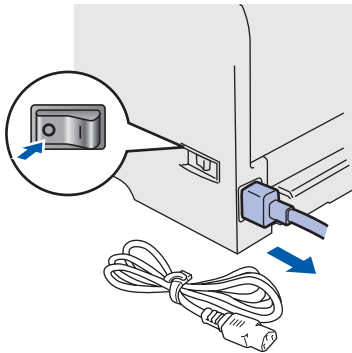

- 2 Remove the drum unit and toner cartridge assembly. Put it in a plastic bag and seal the bag completely.

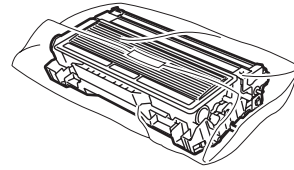

- 3 Repack the printer.

