

Before you can use the machine, read this Quick Setup Guide for the correct setup and installation.

 WARNING	Warnings tell you what to do to prevent possible personal injury.
--	---







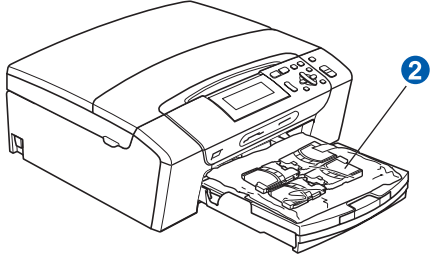

Important

DO NOT connect the USB cable yet (if you are using a USB cable).

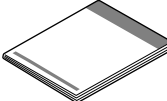
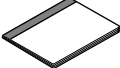

1

Unpack the machine and check the components

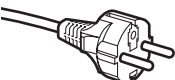
		 <p>Inbox Ink Cartridges [x4]</p> <p>Black Yellow Cyan Magenta (Approx. 65% yield of the replacement cartridge) For details, see <i>Consumable items</i> in the User's Guide.</p>	 <p>Quick Setup Guide</p>
 <p>User's Guide</p>	 <p>CD-ROM</p>	 <p>USB Interface Cable</p>	
 <p>Power Cord</p>	 <p>Australia & New Zealand</p>	 <p>Hong Kong, Malaysia & Singapore</p>	 <p>Philippines & Thailand</p>
<p>The supplied mains plug is a grounded three pin plug.</p>		<p>The supplied mains plug is a side grounded two pin plug.</p>	
<p>Make sure that the AC socket will accept the supplied grounded pin plug. This machine must be grounded, If in doubt, call a qualified electrician.</p>			

 **WARNING**

Plastic bags are used in the packaging of your machine. To avoid danger of suffocation, please keep these bags away from babies and children.

- a** Remove the protective tape and film covering the scanner glass.
- b** Remove the green protective packing **1** by lifting the front of the machine and then pulling down on the packing part.
- c** Remove the plastic bag **2** containing the ink cartridges from on top of the paper tray.
- d** Make sure you have all components.

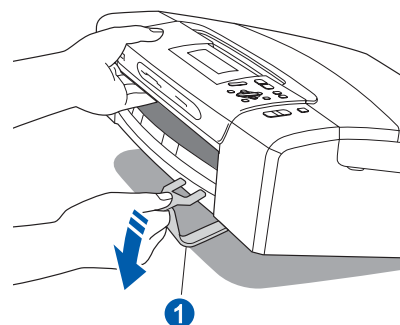

 **Note**

- The components included in the box may differ depending on your country.
- Save all packing materials and the box in case for any reason you must ship your machine.
- For a network connection you will need to purchase a network interface cable. Please use the supplied USB cable for a USB connection.
- To ensure safe operation the supplied plug must be inserted only into a standard power outlet that is properly grounded through the standard electrical wiring. Non grounded equipment may cause an electrical shock hazard, and may cause excessive electrical noise radiation.

USB cable

Please make sure you use a USB 2.0 cable (Type A/B) that is no more than 2 metres long.

Network cable

Use a straight-through Category5 (or greater) twisted-pair cable for 10BASE-T or 100BASE-TX Fast Ethernet Network.

2 Load plain A4 paper

- a** Pull the paper tray **1** completely out of the machine.

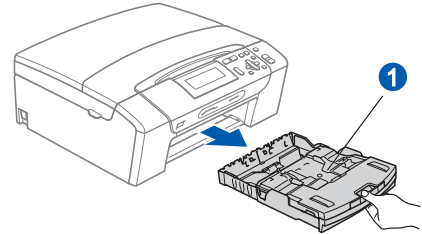

- b** Open the paper tray cover **1**.

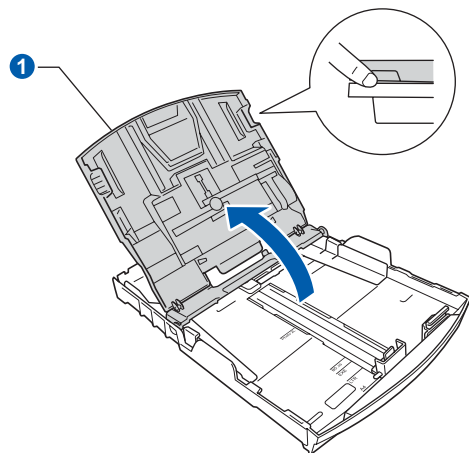

- c** With both hands, gently press and slide the paper side guides **1** and then the paper length guide **2** to fit the paper size.

Make sure that the triangular marks **3** on the paper side guides **1** and paper length guide **2** line up with the mark for the paper size you are using.

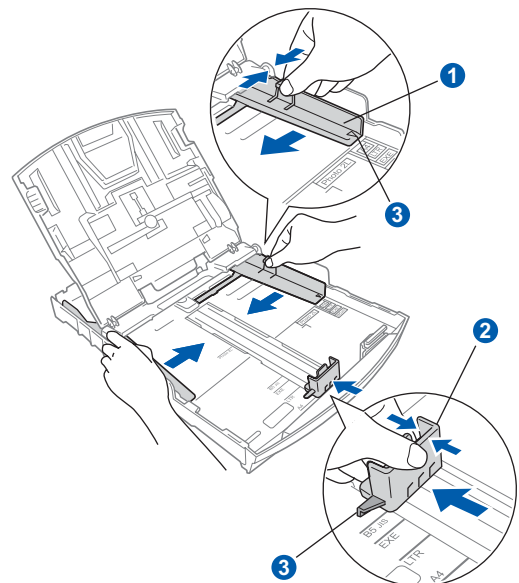

- d** Fan the stack of paper well to avoid paper jams and misfeeds.
- e** Gently put the paper into the paper tray print side down and top edge first. Check that the paper is flat in the tray.

Important

Do not push the paper in too far.

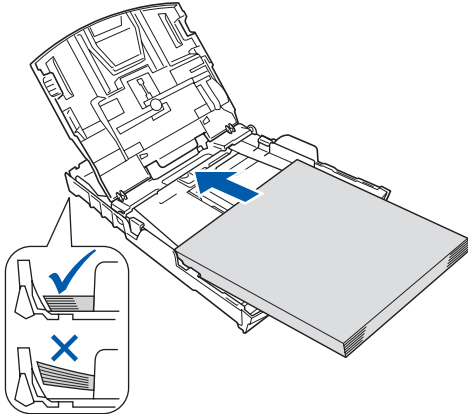

- f** Gently adjust the paper side guides to the paper with both hands. Make sure that the paper side guides touch the edges of the paper.
- g** Close the paper tray cover **1**.

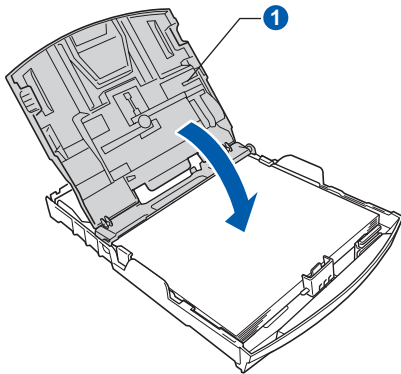

- h** *Slowly* push the paper tray completely into the machine.

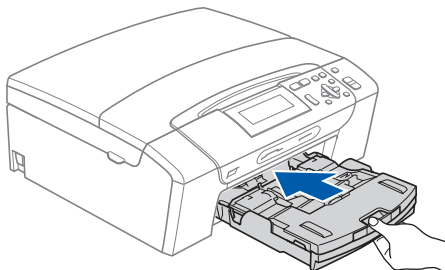

- i** While holding the paper tray in place, pull out the paper support **1** until it clicks, and then unfold the paper support flap **2**.

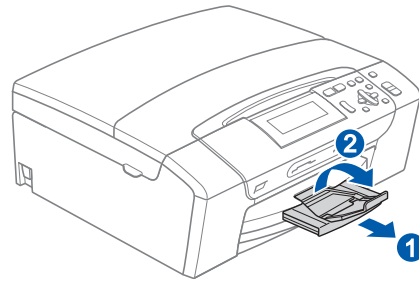

3 Connect the power cord

Important

DO NOT connect the USB cable yet (if you are using a USB cable).

- a** Connect the power cord.

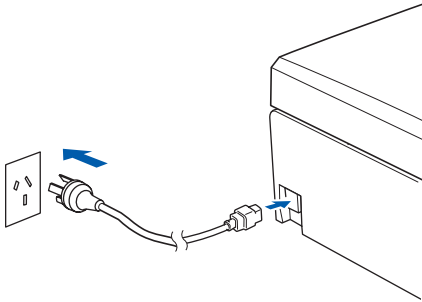

WARNING

The machine must be fitted with an earthed plug.

Note

The control panel warning LED will stay on until you have installed the ink cartridges.

4 Choose your language (not available for Hong Kong users)

- a** After connecting the power cord, the LCD shows:

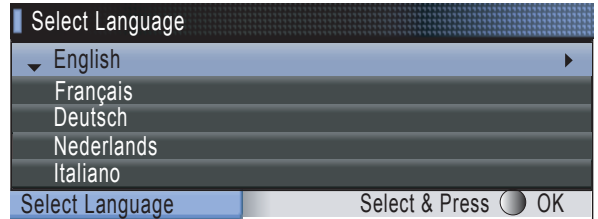

Press ▲ or ▼ to choose your language and press **OK**.

- b** Choose **Yes** or **No** and press **OK**.

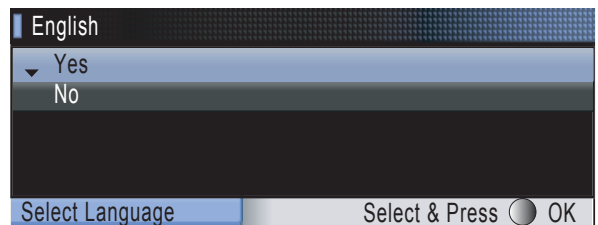

 If you set the wrong language, you can change the language after setting the date and time. (For details, see *Changing LCD language in Chapter 3 of the User's Guide.*)

5 Install the ink cartridges

! WARNING

If ink gets in your eyes, wash them out with water at once, and if irritation occurs consult a doctor.

- a** Make sure that the power is turned on. The LCD shows:

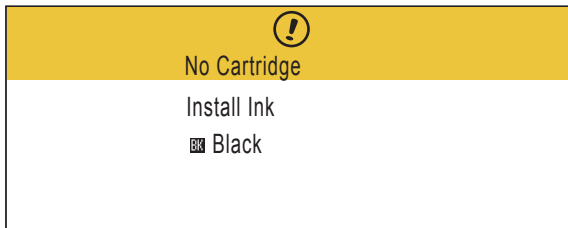

- b** Open the ink cartridge cover ①.

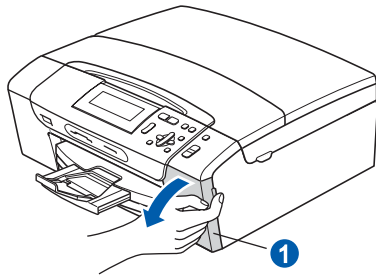

- c** Remove the green protective part ①.

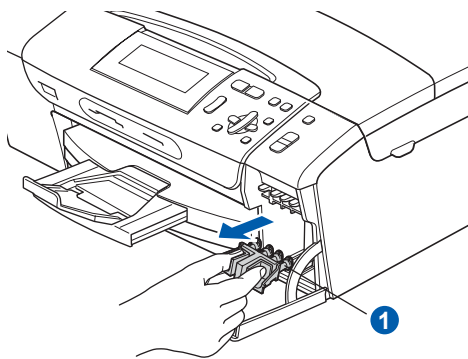

Note

Do not throw away the green protective part. You will need it if you transport the machine.

- d** Unpack the ink cartridge.

- e** Turn the green knob on the protective yellow cap clockwise until it clicks to release the vacuum seal, then remove the cap ①.

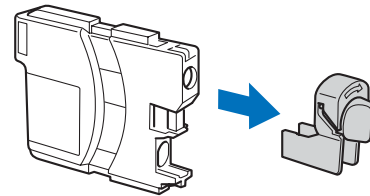
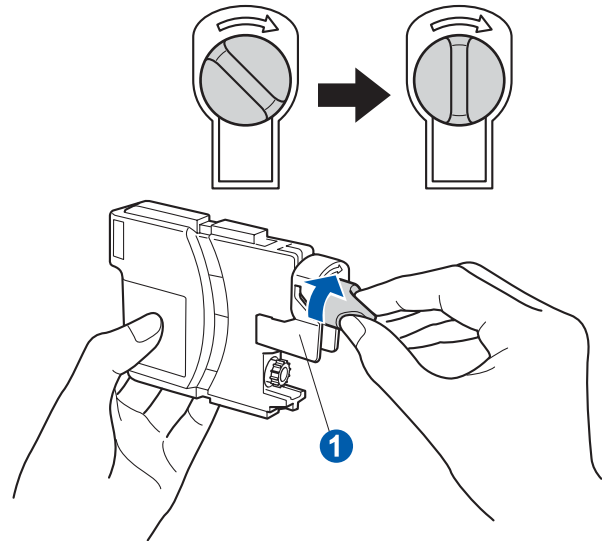

- f** Take care to match the colour of the lever ① with the cartridge colour ②, as shown in the diagram below.

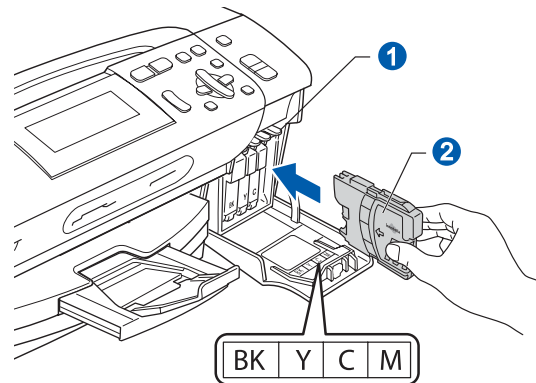

- g** Install each ink cartridge in the direction of the arrow on the label.

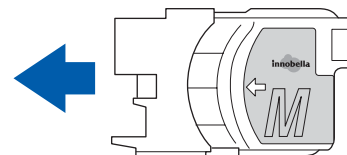

h

Gently push the ink cartridge until it clicks. After all the ink cartridges are installed close the ink cartridge cover.

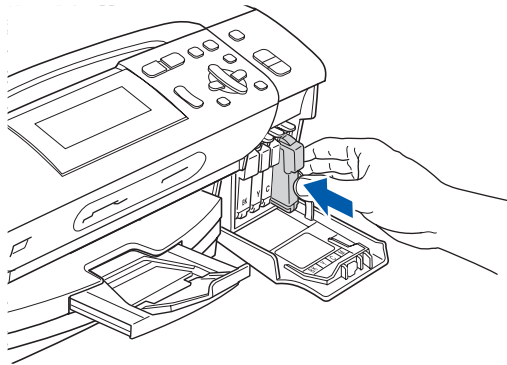

Important

After initial installation of the ink cartridges, the machine will start cleaning the ink tube system. This cleaning process will last approximately four minutes.

DO NOT unplug the machine from the power outlet or attempt to stop the cleaning process. Interruption of cleaning process may cause undesired print quality problems.

Important

- **DO NOT** take out ink cartridges if you do not need to replace them. If you do so, it may reduce the ink quantity and the machine will not know the quantity of ink left in the cartridge.
- **DO NOT** shake the ink cartridges. If ink stains your skin or clothing, wash with soap or detergent at once.
- **DO NOT** repeatedly insert and remove the cartridges. If you do so, ink may seep out of the cartridge.
- If you mix the colours by installing an ink cartridge in the wrong position, clean the print head several times after correcting the cartridge installation. (See *Cleaning the print head in Appendixes B of the User's Guide.*)
- Once you open an ink cartridge, install it in the machine and use it up within six months of installation. Use unopened ink cartridges by the expiration date written on the cartridge package.
- **DO NOT** dismantle or tamper with the ink cartridge, this can cause the ink to leak out of the cartridge.
- Brother multifunction machines are designed to work with ink of a particular specification and will work to a level of optimum performance when used with genuine Brother branded ink cartridges. Brother cannot guarantee this optimum performance if ink or ink cartridges of other specifications are used. Brother does not therefore recommend the use of cartridges other than genuine Brother branded cartridges with this machine or the refilling of empty cartridges with ink from other sources. If damage is caused to the print head or other parts of this machine as a result of using incompatible products with this machine, any repairs required as a result may not be covered by the warranty.

6 Check the print quality

a When the preparation process has finished, the LCD shows this message

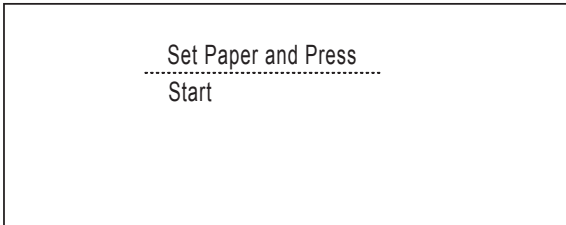

Press **Colour Start**.

b Check the quality of the four colour blocks (black/yellow/cyan/magenta)

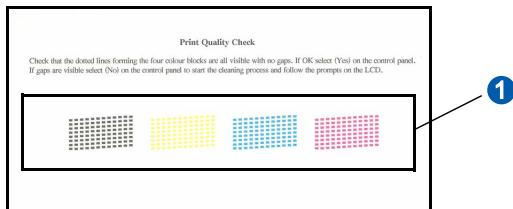

c If all lines are clear and visible, press **+** (Yes) to finish the quality check.

OK

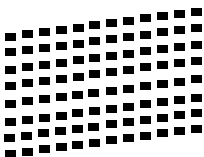

If you can see missing short lines, press

- (No) and go to **d**.

Poor

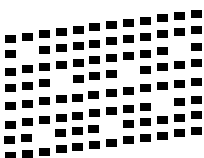

d The LCD asks you if the print quality is OK for black and colour. Press **+** (Yes) or **-** (No).

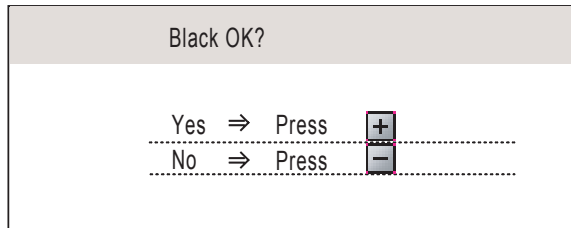

After pressing **+** (Yes) or **-** (No) for both black and colour, the LCD shows:

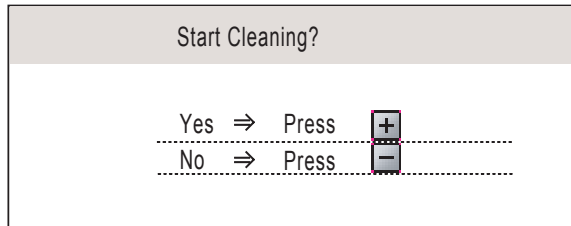

e Press **+** (Yes), the machine will then start cleaning the colours.

f After cleaning is finished, press **Colour Start**. The machine starts printing the Print Quality Check Sheet again. Go back to **b**.

7 Choose your language (For Hong Kong users only)

a Press **Menu**.

b Press **▲** or **▼** to choose **Initial Setup**. Press **OK**.

c Press **▲** or **▼** to choose **Local Language**. Press **OK**.

d Press **▲** or **▼** to choose your language. Press **OK**.

e Press **Stop/Exit**.

8 Set the LCD contrast (If needed)

If you are having difficulty reading the LCD, try changing the contrast setting.

- a** Press **Menu**.
- b** Press **▲** or **▼** to choose **General Setup**. Press **OK**.
- c** Press **▲** or **▼** to choose **LCD Settings**. Press **OK**.
- d** Press **▲** or **▼** to choose **LCD Contrast**.
- e** Press **◀** or **▶** to choose **Light, Med or Dark**. Press **OK**.
- f** Press **Stop/Exit**.



Note

You can also adjust the angle of the display by lifting it.

9 Set the date and time

Setting the date and time allows the machine to clean the print head regularly and maintain optimum print quality. It also allows the machine to name files created when using the Scan to Media feature.

- a** Press **Menu**.
- b** Press **▲** or **▼** to choose **Initial Setup**. Press **OK**.
- c** Press **▲** or **▼** to choose **Date&Time**. Press **OK**.
- d** Press **▲** or **▼** repeatedly to enter the last two digits of the year, and then press **OK**.

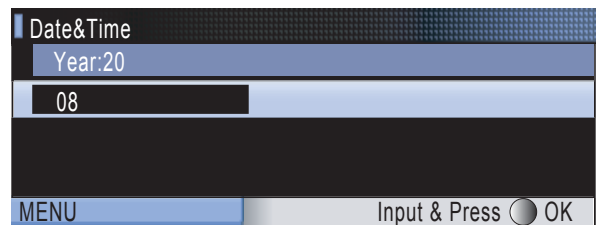

(e.g. Enter **08** for 2008.)

- e** Repeat for **Month and Day**, and **Hours and Minutes** in 24-hour format.
- f** Press **Stop/Exit**.

10

Choose your connection type

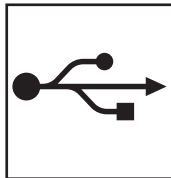
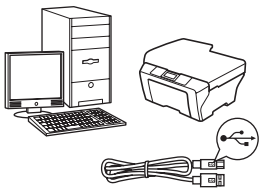

For USB interface cable

Windows[®], go to page 10
Macintosh[®], go to page 14

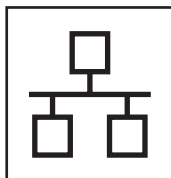
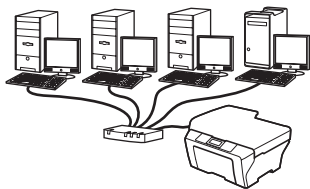

For Wired Network

Windows[®], go to page 17
Macintosh[®], go to page 22

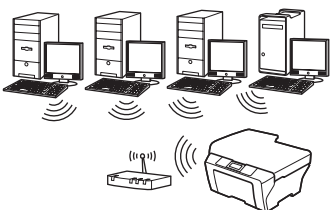

For Wireless Network

Windows[®] and Macintosh[®],
go to page 26

Windows[®]
USB

Macintosh[®]

Windows[®]
Wired Network

Macintosh[®]

Wireless Network



For USB Interface Users (For Windows® 2000 Professional/XP/XP Professional x64 Edition/ Windows Vista®)

11 Before you install

a Make sure that your computer is ON and you are logged on with Administrator rights.

Important

- **DO NOT** connect the USB cable yet.
- If there are any programs running, close them.
- Make sure there are no memory cards or a USB Flash memory drive inserted.
- The screens may differ depending on the operating system.
- The supplied CD-ROM includes ScanSoft™ PaperPort™ 11SE*. This software supports Windows® 2000 (SP4 or greater), XP (SP2 or greater), XP Professional x64 Edition and Windows Vista®. Update to the latest Windows® Service Pack before installing MFL-Pro Suite.

* For Hong Kong users, CD-ROM includes Presto!® PageManager® instead of ScanSoft™ PaperPort™ 11SE.

b Disconnect the machine from the power socket and from your computer, if you already connected an interface cable.

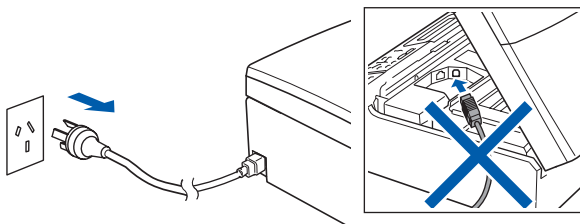

12 Install MFL-Pro Suite

a Put the supplied CD-ROM into your CD-ROM drive. If the model name screen appears, choose your machine. If the language screen appears, choose your language.

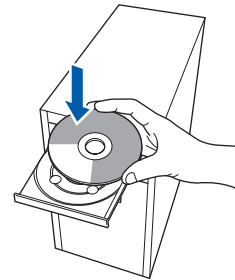

Note

*If the Brother screen does not appear automatically, go to **My Computer (Computer)**, double-click the CD-ROM icon, and then double-click **start.exe**.*

b The CD-ROM main menu will appear. Click **Install MFL-Pro Suite**.





Note

- If this screen appears, click **OK** and restart your computer.

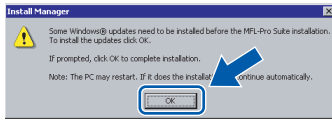

- If the installation does not continue automatically, open the main menu again by ejecting and then reinserting the CD-ROM or double-click the **start.exe** program from the root folder, and continue from **b** to install MFL-Pro Suite.
- For Windows Vista®, when the **User Account Control** screen appears, click **Allow**.

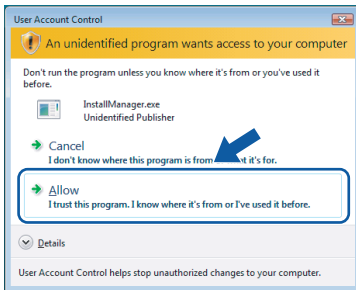

- When the ScanSoft™ PaperPort™ 11SE **License Agreement** window appears, click **Yes** if you agree to the Software License Agreement.

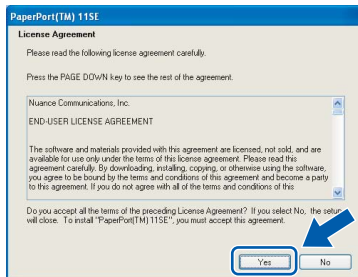

- The installation of ScanSoft™ PaperPort™ 11SE will automatically start and is followed by the installation of MFL-Pro Suite.

- When the Brother MFL-Pro Suite Software **License Agreement** window appears, click **Yes** if you agree to the Software License Agreement.

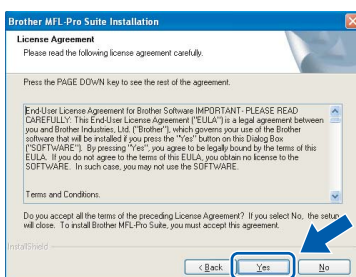

f

Choose **Local Connection**, and then click **Next**. The installation continues.

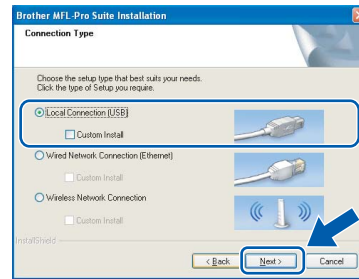

g

When this screen appears, go to the next step.

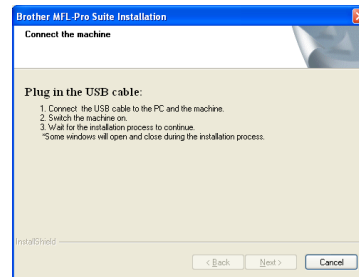



13

Connect the USB cable

Important

- **DO NOT** connect the machine to a USB port on a keyboard or a non-powered USB hub.
- **Connect the machine directly to your computer.**

- a** Using both hands, use the plastic tabs on both sides of the machine to lift the scanner cover until it locks securely into the open position.

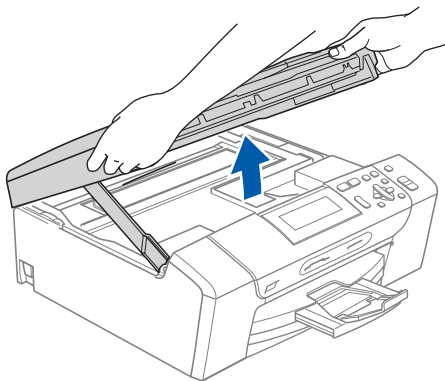

- b** Connect the USB cable to the USB socket marked with a  symbol. You will find the USB socket inside the machine on the right as shown below.

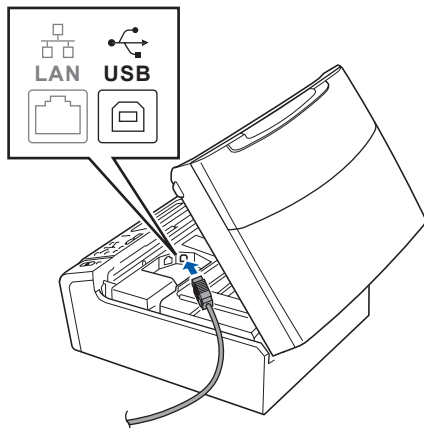

- c** Carefully guide the USB cable through the trench as shown below, following the trench around and toward the back of the machine. Then connect the cable to your computer.

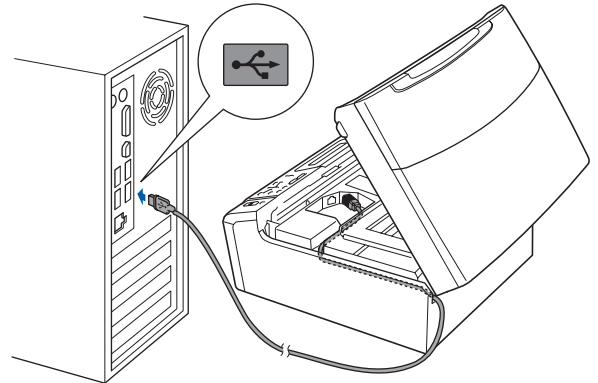

Important

Make sure that the cable does not restrict the cover from closing, or an error may occur.

- d** Lift the scanner cover to release the lock **1**. Gently push the scanner cover support down **2** and close the scanner cover **3**.

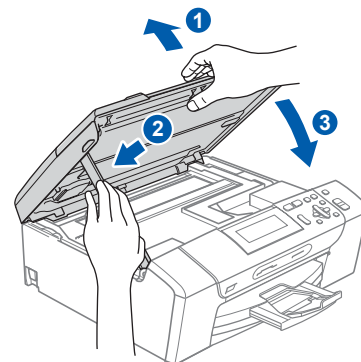



14 Connect the power cord

- a Connect the power cord. The installation will continue automatically. The installation screens appear one after another.

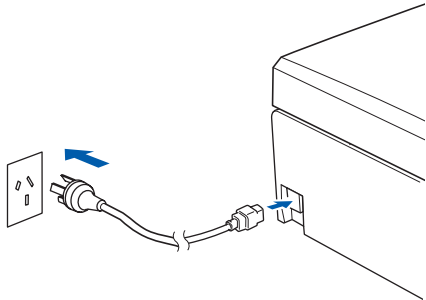

Important
DO NOT cancel any of the screens during the installation. It may take a few seconds for all screens to appear.

- b When the **On-Line Registration** screen is displayed, make your selection and follow the on-screen instructions.

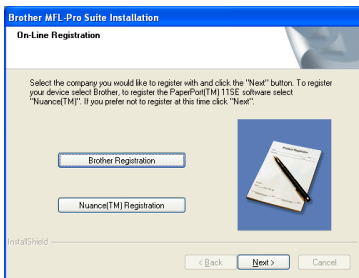

15 Finish and restart

- a Click **Finish** to restart your computer. After restarting the computer, you must be logged on with Administrator rights.

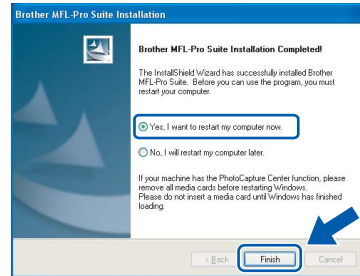

Note

*If an error message appears during the software installation, run the **Installation Diagnostics** located in **Start/All Programs/Brother/DCP-XXXX** (where DCP-XXXX is your model name).*

Finish The installation is now complete.

Now go to

Proceed to Install Optional Applications on page 39.



For USB Interface Users (For Mac OS® X 10.2.4 or greater)

11 Before you install

a Make sure your machine is connected to the power and your Macintosh® is ON. You must be logged on with Administrator rights.

Important

- For Mac OS® X 10.2.0 to 10.2.3 users, upgrade to Mac OS® X 10.2.4 or greater. (For the latest information for Mac OS® X, visit <http://solutions.brother.com/>)
- Make sure there are no memory cards or a USB Flash memory drive inserted.

12 Connect the USB cable

Important

- DO NOT connect the machine to a USB port on a keyboard or a non-powered USB hub.
- Connect the machine directly to your Macintosh®.

a Using both hands, use the plastic tabs on both sides of the machine to lift the scanner cover until it locks securely into the open position.

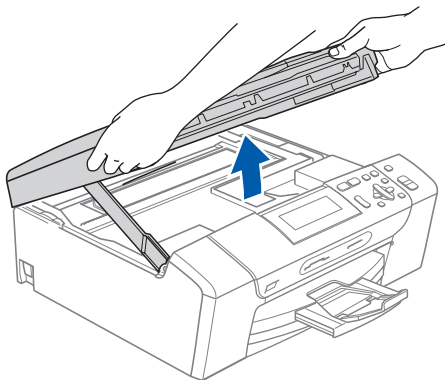

b Connect the USB cable to the USB socket marked with a  symbol. You will find the USB socket inside the machine on the right as shown below.

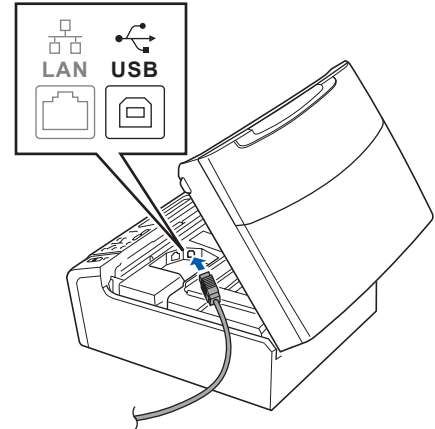

c Carefully guide the USB cable through the trench as shown below, following the trench around and toward the back of the machine. Then connect the cable to your Macintosh®.

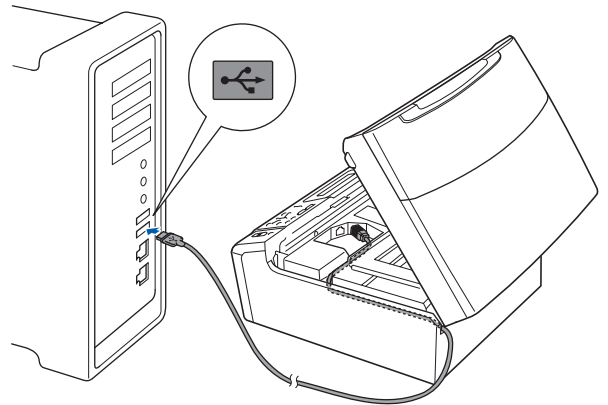

Important

Make sure that the cable does not restrict the cover from closing, or an error may occur.

d Lift the scanner cover to release the lock **1**. Gently push the scanner cover support down **2** and close the scanner cover **3**.

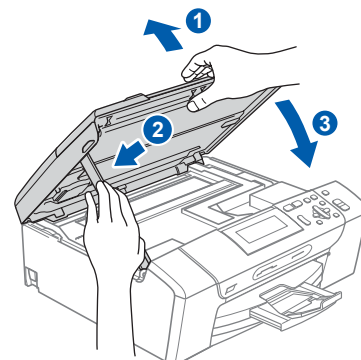



13 Install MFL-Pro Suite

a Put the supplied CD-ROM into your CD-ROM drive.

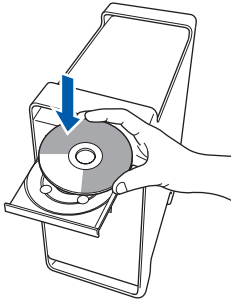

b Double-click the **Start Here OSX** icon to install.

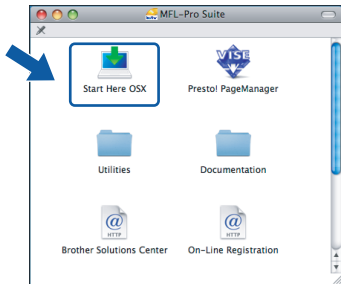

c Choose **Local Connection**, and then click **Next**. Follow the on-screen instructions.

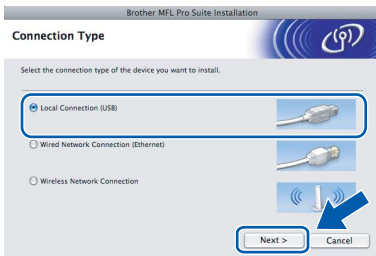

Note

*Please wait, it will take a few seconds for the software to install. After the installation, click **Restart** to finish installing the software.*

d The Brother software will search for the Brother device. During this time the following screen will appear.

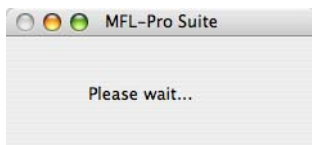

e When this screen appears, click **OK**.

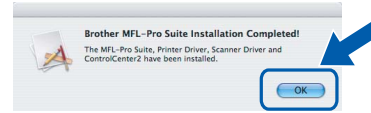

OK! For Mac OS® X 10.3.x or greater, the installation of MFL-Pro Suite is now complete. Go to step **14** on page 16.

f For Mac OS® X 10.2.4 to 10.2.8 users, click **Add**.

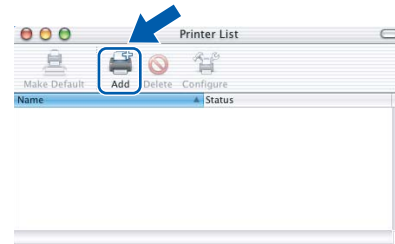

g Choose **USB**.

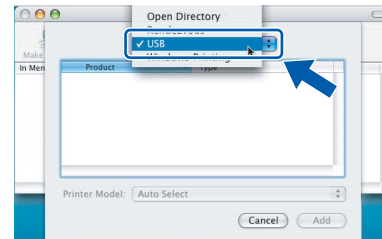

h Choose **XXX-XXXX** (where XXX-XXXX is your model name), and then click **Add**.

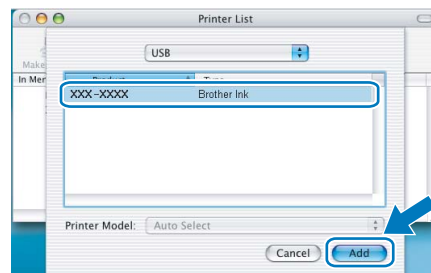

i Click **Print Center**, then **Quit Print Center**.

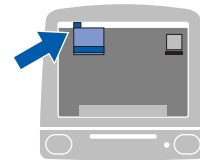

OK! The installation of MFL-Pro Suite is now complete. Go to step **14** on page 16.



14 Install Presto!® PageManager®

When Presto!® PageManager® is installed OCR capability is added to Brother ControlCenter2. You can easily scan, share and organize photos and documents using Presto!® PageManager®.

- a** Double-click the **Presto! PageManager** icon and follow the on-screen instructions.



For Mac OS® X 10.2.4 to 10.3.8 users, when this screen appears, click **Go** to download the software from the Brother Solutions Center website.



Finish The installation is now complete.



For Wired Network Interface Users (For Windows® 2000 Professional/XP/XP Professional x64 Edition/ Windows Vista®)

11 Before you install

- a** Make sure that your computer is ON and you are logged on with Administrator rights.

Important

- If there are any programs running, close them.
- Make sure there are no memory cards or a USB Flash memory drive inserted.
- The screens may differ depending on the operating system.
- The supplied CD-ROM includes ScanSoft™ PaperPort™ 11SE*. This software supports Windows® 2000 (SP4 or greater), XP (SP2 or greater), XP Professional x64 Edition and Windows Vista®. Update to the latest Windows® Service Pack before installing MFL-Pro Suite.

* For Hong Kong users, CD-ROM includes Presto!® PageManager® instead of ScanSoft™ PaperPort™ 11SE.

Important

Before installation, if you are using personal firewall software (other than Windows® Firewall), anti-spyware or antivirus applications, temporarily disable them.

- b** Disconnect the machine from the power socket.

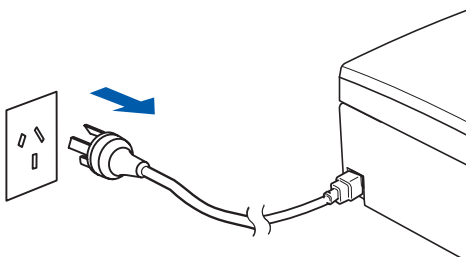

12 Connect the network cable

- a** Using both hands, use the plastic tabs on both sides of the machine to lift the scanner cover until it locks securely into the open position.

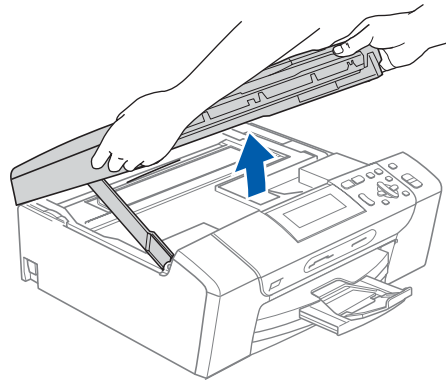

- b** Connect the network cable to the LAN socket marked with a  symbol. You will find the LAN socket inside the machine on the left as shown below.

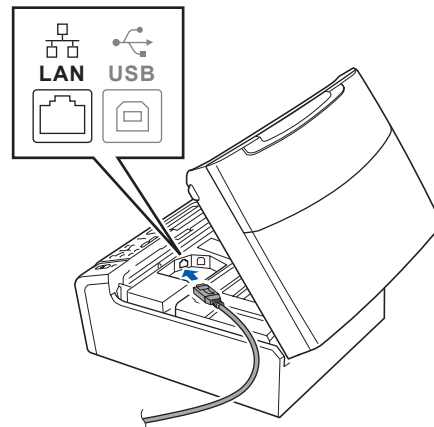



- c** Carefully guide the network cable to the trench as shown below, following the trench around and toward the back of the machine. Then, connect the cable to your network.

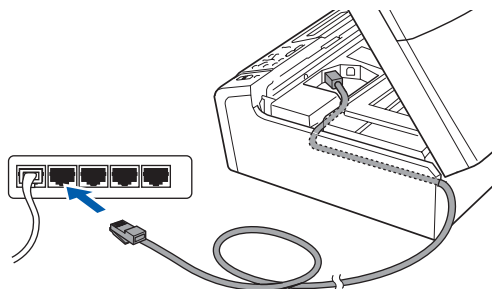

 **Note**

If both USB and LAN cables are being used, guide both cables through the trench with one on top of the other.

Important

Make sure that the cable does not restrict the cover from closing, or an error may occur.

- d** Lift the scanner cover to release the lock **1**. Gently push the scanner cover support down **2** and close the scanner cover **3**.

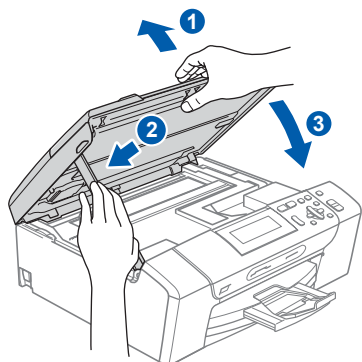

13 Connect the power cord

- a** Connect the power cord.

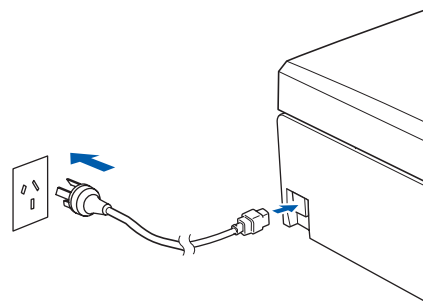

Important

If you have previously set up your machine for a wireless network and then want to set it up on a wired network, you should check that the machine's Network I/F is set to Wired LAN. The wireless network interface will become inactive with this setting.

On your machine, press Menu.

Press ▲ or ▼ to choose Network and press OK.

Press ▲ or ▼ to choose Network I/F and press OK.

Press ▲ or ▼ to choose Wired LAN and press OK.

Press Stop/Exit.



14 Install MFL-Pro Suite

a Put the supplied CD-ROM into your CD-ROM drive. If the model name screen appears, choose your machine. If the language screen appears, choose your language.

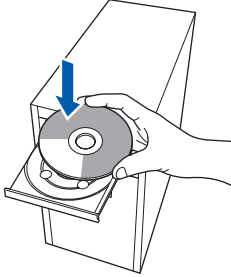

Note

If the Brother screen does not appear automatically, go to **My Computer (Computer)**, double-click the CD-ROM icon, and then double-click **start.exe**.

b The CD-ROM main menu will appear. Click **Install MFL-Pro Suite**.



Note

If this screen appears, click **OK** and restart your computer.

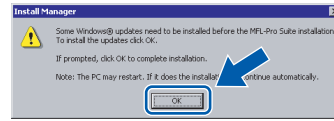

If the installation does not continue automatically, open the main menu again by ejecting and then reinserting the CD-ROM or double-click the **start.exe** program from the root folder, and continue from **b** to install MFL-Pro Suite.

For Windows Vista®, when the **User Account Control** screen appears, click **Allow**.

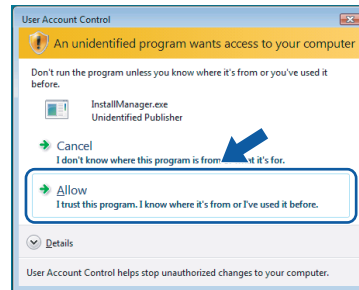

c When the ScanSoft™ PaperPort™ 11SE License Agreement window appears, click **Yes** if you agree to the Software License Agreement.

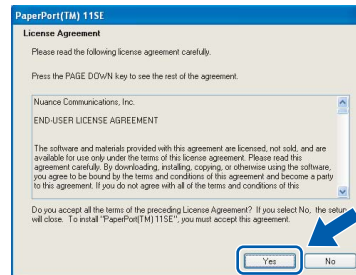

d The installation of ScanSoft™ PaperPort™ 11SE will automatically start and is followed by the installation of MFL-Pro Suite.

e When the Brother MFL-Pro Suite Software License Agreement window appears, click **Yes** if you agree to the Software License Agreement.

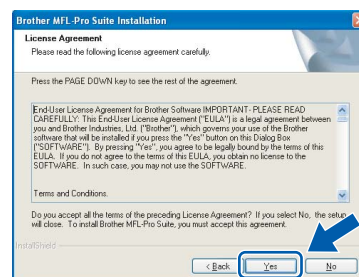

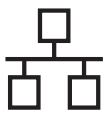

- f** Choose **Wired Network Connection**, and then click **Next**.

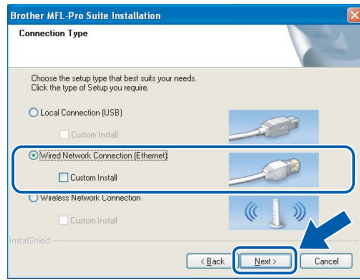

- g** For Windows® XP SP2/Windows Vista® users, when this screen appears, choose **Change the Firewall port settings to enable network connection and continue with the installation. (Recommended)** and click **Next**.

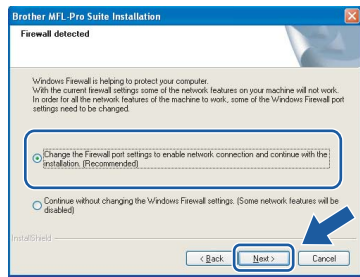

If you are using a firewall other than Windows® Firewall or Windows® Firewall is off, this screen may appear.

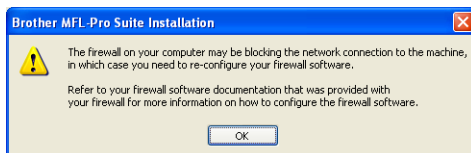

See the instructions provided with your firewall software for information on how to add the following network ports.

- For network scanning, add UDP port 54925.
- If you still have trouble with your network connection, add UDP port 137.

Note

- If the machine is configured for your network, choose the machine from the list, and then click **Next**.
This window will not appear if there is only one machine connected on the network, it will be chosen automatically.

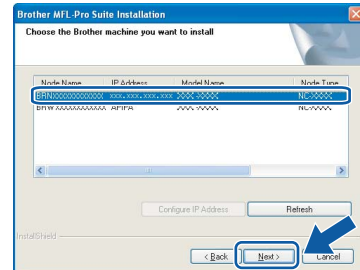

If your machine shows **APIPA** in the **IP Address** field, click **Configure IP Address** and enter an IP address for your machine that is suitable for your network.

- If the machine is not yet configured for use on your network, the following screen appears.



Click **OK**.

The **Configure IP Address** window will appear. Enter an IP address for your machine that is suitable for your network by following the on-screen instructions.

- h** The installation of the Brother drivers will automatically start. The installation screens appear one after another.

Important

DO NOT cancel any of the screens during the installation. It may take a few seconds for all screens to appear.

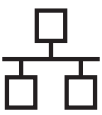

Note

For Windows Vista®, when this screen appears, click the check box and click **Install** to complete the installation correctly.

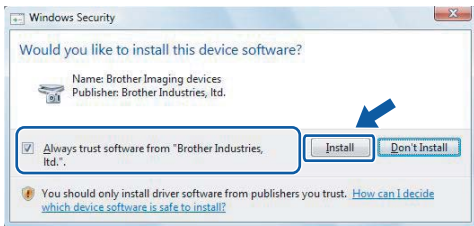

i When the **On-Line Registration** screen is displayed, make your selection and follow the on-screen instructions.

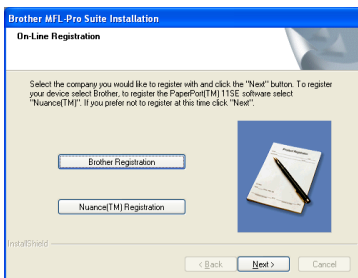

15 Finish and restart

a Click **Finish** to restart your computer. After restarting the computer, you must be logged on with Administrator rights.



Note

If an error message appears during the software installation, run the **Installation Diagnostics** located in **Start/All Programs/Brother/DCP-XXXX** (where DCP-XXXX is your model name).

16 Install MFL-Pro Suite on additional computers (If needed)

If you want to use your machine with multiple computers on the network, install MFL-Pro Suite on each computer. Go to step **14** on page 19. Also see step **11-a** on page 17 before you install.

Note

This product includes a PC license for up to 2 Users.
This license supports the installation of the MFL-Pro Suite including ScanSoft™ PaperPort™ 11SE on up to 2 PCs on the network.
If you want to use more than 2 PCs with ScanSoft™ PaperPort™ 11SE installed, please buy the Brother NL-5 pack which is a multiple PC license agreement pack for up to 5 additional users. To buy the NL-5 pack, contact your Brother dealer.

Finish

The installation is now complete.

Now go to

Proceed to **Install Optional Applications** on page 39.

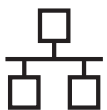

For Wired Network Interface Users (For Mac OS® X 10.2.4 or greater)

11 Before you install

- a** Make sure your machine is connected to the power and your Macintosh® is ON. You must be logged on with Administrator rights.

Important

- For Mac OS® X 10.2.0 to 10.2.3 users, upgrade to Mac OS® X 10.2.4 or greater. (For the latest information for Mac OS® X, visit <http://solutions.brother.com/>)
- Make sure there are no memory cards or a USB Flash memory drive inserted.
- If you have previously set up your machine for a wireless network and then want to set it up on a wired network, you should check that the machine's Network I/F is set to Wired LAN. The wireless network interface will be inactive with this setting. On your machine, press Menu. Press ▲ or ▼ to choose Network and press OK. Press ▲ or ▼ to choose Network I/F and press OK. Press ▲ or ▼ to choose Wired LAN and press OK. Press Stop/Exit.

12 Connect the network cable

- a** Using both hands, use the plastic tabs on both sides of the machine to lift the scanner cover until it locks securely into the open position.

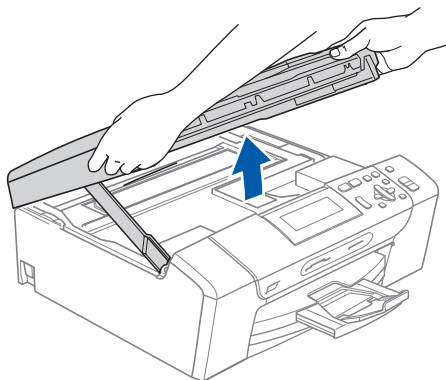

- b** Connect the network cable to the LAN socket marked with a  symbol. You will find the LAN socket inside the machine on the left as shown below.

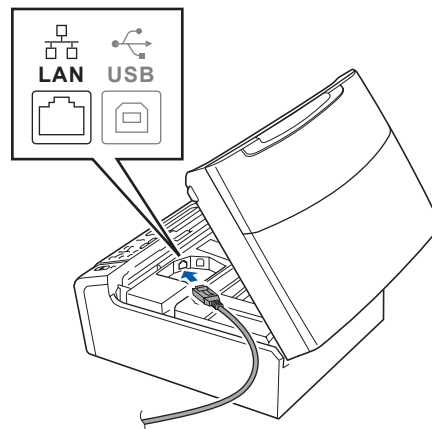

- c** Carefully guide the network cable to the trench as shown below, following the trench around and toward the back of the machine. Then, connect the cable to your network.

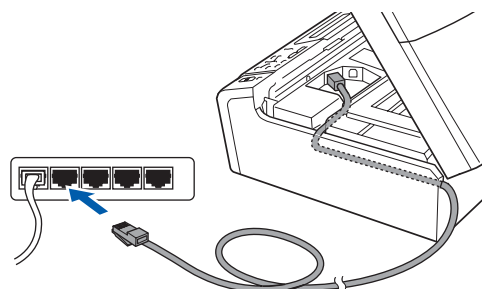

Important

Make sure that the cable does not restrict the cover from closing, or an error may occur.

Note

If both USB and LAN cables are being used, guide both cables through the trench with one on top of the other.

- d** Lift the scanner cover to release the lock ①. Gently push the scanner cover support down ② and close the scanner cover ③.

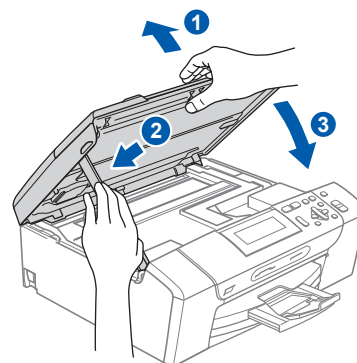



13 Install MFL-Pro Suite

- a Put the supplied CD-ROM into your CD-ROM drive.

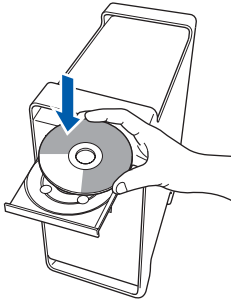

- b Double-click the **Start Here OSX** icon to install.

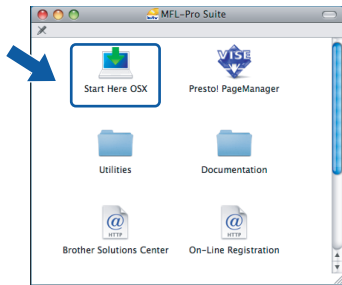

- c Choose **Wired Network Connection**, and then click **Next**. Follow the on-screen instructions.

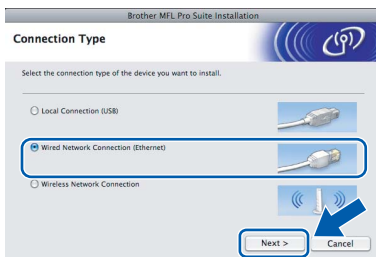

Note

Please wait, it will take a few seconds for the software to install. After the installation, click **Restart** to finish installing the software.

- d The Brother software will search for the Brother device. During this time the following screen will appear.

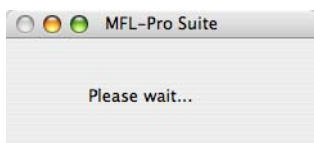

Note

- If the machine is configured for your network, choose the machine from the list, and then click **OK**. This window will not appear if there is only one machine connected on the network, it will be chosen automatically. Go to e.

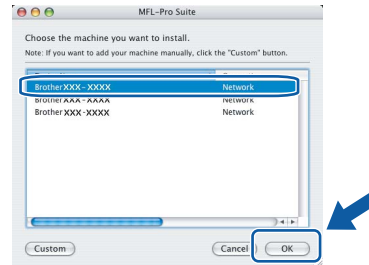

- If this screen appears click **OK**.



Enter a name for your Macintosh® in **Display Name** up to 15 characters long and click **OK**. Go to e.

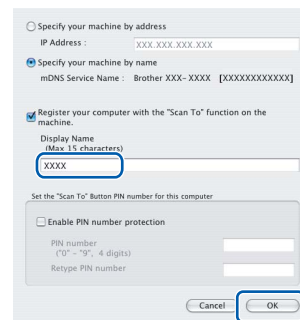

- If you want to use the machine's **Scan** key to scan over the network you must check the **Register your computer with the "Scan To" function on the machine box**.
- The name you enter will appear on the machine's LCD when you press the **Scan** key and choose a scan option. (For more information, see *Network Scanning in the Software User's Guide on the CD-ROM*.)

- e When this screen appears, click **OK**.

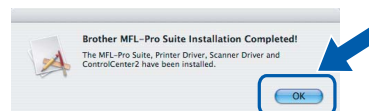

- OK! For Mac OS® X 10.3.x or greater, the installation of MFL-Pro Suite is now complete. Go to step **14** on page 25.

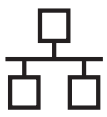

- f** For Mac OS® X 10.2.4 to 10.2.8 users, click **Add**.

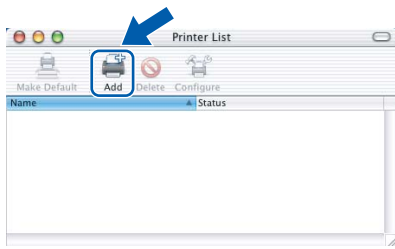

- g** Make the selection shown below.

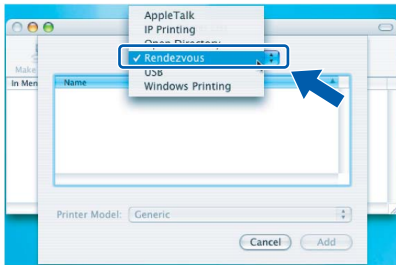

- h** Choose **XXX-XXXX** (where XXX-XXXX is your model name), and then click **Add**.

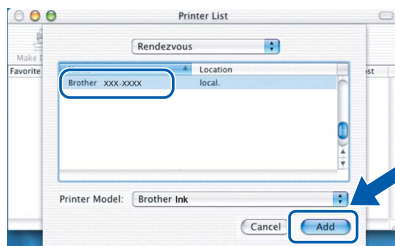

- i** Click **Print Center**, then **Quit Print Center**.

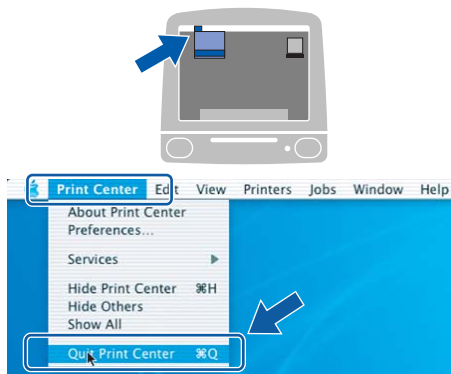

- OK!** The installation of MFL-Pro Suite is now complete.
Go to step **14** on page 25.



14 Install Presto!® PageManager®

When Presto!® PageManager® is installed OCR capability is added to Brother ControlCenter2. You can easily scan, share and organize photos and documents using Presto!® PageManager®.

- a** Double-click the **Presto! PageManager** icon and follow the on-screen instructions.



For Mac OS® X 10.2.4 to 10.3.8 users, when this screen appears, click **Go** to download the software from the Brother Solutions Center website.



15 Install MFL-Pro Suite on additional computers (If needed)

If you want to use your machine with multiple computers on the network, install MFL-Pro Suite on each computer. Go to step **13** on page 23. Also see step **11-a** on page 22 before you install.

Finish

The installation is now complete.



For Wireless Network Interface Users

11 Before you begin

First you must configure the wireless network settings of your machine to communicate with your network access point (router). After the machine is configured to communicate with your access point (router), computers on your network will have access to the machine. To use the machine from these computers, you will need to install the drivers and software. The following steps will guide you through the configuration and installation process.

To achieve optimum results with normal everyday document printing, place the Brother machine as close to the network access point (router) as possible with minimal obstructions. Large objects and walls between the two devices as well as interference from other electronic devices can affect the data transfer speed of your documents.

Although the Brother DCP-585CW can be used in a both wired and wireless network, only one of the connection methods can be used at a time.

Important

If you have previously configured the wireless settings of the machine you must reset the network (LAN) settings before you can configure the wireless settings again.

On your machine, press Menu. Press ▲ or ▼ to choose Network and press OK.

Press ▲ or ▼ to choose Factory Reset, and then press OK.

Press  twice to choose Yes.

Note

The following instructions are for infrastructure mode.

To set up your machine in any other wireless environment you can find instructions in the Network User's Guide on the CD-ROM.

You can view the Network User's Guide by following the instructions below.

1 Turn on your computer/Macintosh®. Insert the Brother CD-ROM into your CD-ROM drive.

For Windows®:

2 Choose your model and the language. The CD-ROM main menu will appear.

3 Click **Documentation, and then click **HTML documents**.**

For Macintosh®:

2 Double-click **Documentation, and then double-click your language folder.**

3 Double-click **top.html.**

Infrastructure Mode

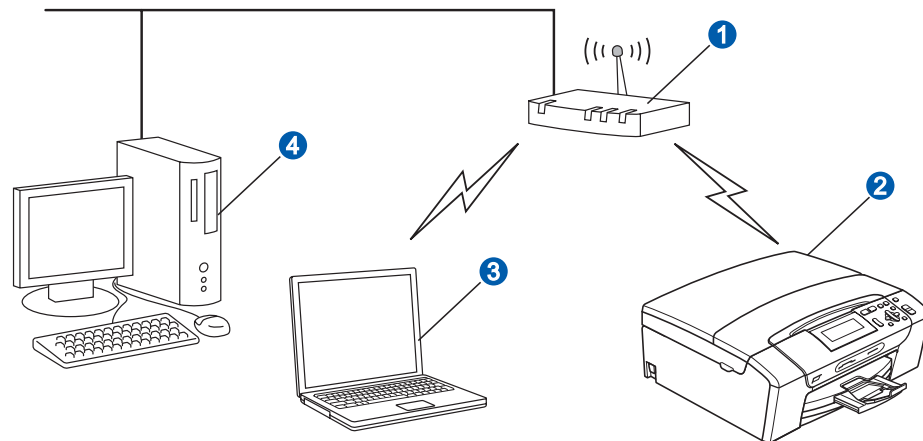

- 1 Access Point (router)
- 2 Wireless Network machine (your machine)
- 3 Wireless capable computer connected to the access point
- 4 Wired computer connected to the access point



12 Confirm your network environment (Infrastructure Mode)

The following instructions will offer two methods for installing your Brother machine in a wireless network environment. Both methods are for infrastructure mode, using a wireless router or access point that uses DHCP to assign IP addresses. Choose a configuration method and proceed to the page indicated.

- a** If your wireless router/access point does not support SecureEasySetup™, Wi-Fi Protected Setup™ or AOSS™, **write down the wireless network settings** of your access point or wireless router in the area below.

Important

If you do not know this information (Network Name, WEP key or WPA2-PSK (Pre-Shared Key)), you cannot continue the wireless setup. You should see the documentation provided with your access point or wireless router, consult the router manufacturer, or your system administrator.

SSID (Service Set ID or Network name)

Authentication (Open System or Shared Key)/Encryption Type (None or WEP)
WEP Key (if needed) ¹

WPA/WPA2-PSK Encryption type (TKIP or AES) (if needed) ²
WPA/WPA2-PSK (Pre-Shared Key) (if needed) ²

¹ The WEP key is for 64-bit encrypted networks or 128-bit encrypted networks and can contain both numbers and letters. If you do not know this information you should see the documentation provided with your access point or wireless router. This key is a 64-bit or 128-bit value that must be entered in an ASCII or HEXADECIMAL format.

For example:

64-bit ASCII:	Uses 5 text characters e.g. "Hello" (this is case sensitive)
64-bit Hexadecimal:	Uses 10 digits of hexadecimal data e.g. "71f2234aba"
128-bit ASCII:	Uses 13 text characters e.g. "Wirelesscomms" (this is case sensitive)
128-bit Hexadecimal:	Uses 26 digits of hexadecimal data e.g. "71f2234ab56cd709e5412aa3ba"

² WPA/WPA2-PSK is a Wi-Fi® Protected Access Pre-Shared Key, which lets the Brother wireless machine associate with access points using TKIP or AES encryption (WPA-Personal). WPA/WPA2-PSK (TKIP or AES) uses a Pre-Shared Key (PSK) that is 8 or more characters in length, up to a maximum of 63 characters. See the Network User's Guide for more details.

Now go to

page 28

- b** If your wireless router/access point supports automatic wireless (one-push) setup (SecureEasySetup™, Wi-Fi Protected Setup™ or AOSS™)



Now go to

page 30



Connecting the Brother machine to the wireless network

13

Configure the wireless settings (Typical Wireless Setup in infrastructure mode)

- a** On your machine, press **Menu**.
Press **▲** or **▼** to choose **Network** and press **OK**.
Press **▲** or **▼** to choose **WLAN** and press **OK**.
Press **▲** or **▼** to choose **Setup Wizard** and press **OK**.

When **Network I/F switched to Wireless** is displayed, press **OK** to accept. This will start the wireless setup wizard. To cancel, press **Clear/Back**.

- b** The machine will search for available SSIDs. If a list of SSIDs is displayed, use the **▲** or **▼** keys to choose the SSID you wrote down in step **12** on page 27, then press **OK**. Go to **f**.

Note

It will take several seconds to display a list of available SSIDs.

If your access point is set to not broadcast the SSID you will have to manually add the SSID name. Go to **c**.

- c** Press **▲** or **▼** to choose **<New SSID>** and press **OK**. Go to **d**.

- d** Enter the SSID you wrote down in step **12** on page 27 using the **▲**, **▼** keys to choose each letter or number.

You can use the **◀** and **▶** keys to move the cursor left and right. For example, to enter the letter **a**, press the **▲** key once. To enter the number **3**, hold down the **▲** key until it appears.

The letters appear in this order: lower case, upper case, numbers and then special letters. (For more information, see *Entering Text for Wireless Settings* on page 43.)

Press **OK** when you have entered all the characters.

- e** Press **▲** or **▼** to choose **Infrastructure**, then press **OK**.

f

Use the **▲**, **▼** and **OK** keys to choose one of the options below: If your network is configured for Authentication and Encryption you must match the settings used for your network.

- **No Authentication or Encryption:**
Choose **Open System**, press **OK** then choose **None** for **Encryption Type?** and press **OK**. Then press **+ Yes** to apply your settings. Go to **i**.
- **No Authentication with WEP Encryption:**
Choose **Open System**, press **OK** then use the **▲** or **▼** to choose **WEP** for the **Encryption Type?** and press **OK**. Go to **g**.
- **Authentication with WEP Encryption:**
Choose **Shared Key** and press **OK**. Go to **g**.
- **Authentication with WPA/WPA2-PSK (TKIP or AES) Encryption:**
Choose **WPA/WPA2-PSK** and press **OK**. Go to **h**.

g

Press **▲** or **▼** to choose the appropriate key number and press **OK**. Enter the WEP key you wrote down in step **12** on page 27 using the **▲**, **▼** keys to choose each letter or number.

You can use the **◀** and **▶** keys to move the cursor left and right. For example, to enter the letter **a**, press the **▲** key once. To enter the number **3**, hold down the **▲** key until it appears.

The letters appear in this order: lower case, upper case, numbers and then special letters. (For more information, see *Entering Text for Wireless Settings* on page 43.)

Press **OK** when you have entered all the characters, then press **+ Yes** to apply your settings. Go to **i**.



h Press **▲** or **▼** to choose **TKIP** or **AES** for **Encryption Type?** and press **OK**. Enter the WPA/WPA2-PSK password you wrote down in step **12** on page 27 using the **▲**, **▼** keys to choose each letter or number.

You can use the **◀** and **▶** keys to move the cursor left and right. For example, to enter the letter **a**, press the **▲** key once. To enter the number **3**, hold down the **▲** key until it appears.

The letters appear in this order: lower case, upper case, numbers and then special letters. (For more information, see *Entering Text for Wireless Settings* on page 43.)

Press **OK** when you have entered all the characters, then press **+** **Yes** to apply your settings. Go to **i**.

i Your machine will now try to connect to your wireless network using the information you have entered. If successful, **Connected** will appear briefly on the LCD.

*If your machine does not successfully connect to your network, verify your network settings collected in step **12** on page 27 then repeat **a** to **h** to make sure you have entered the correct information.*

*If your access point does not have DHCP enabled you will need to manually configure the IP address, subnet mask and gateway of the machine to suit your network. See the *Network User's Guide* for details.*



Wireless setup is now complete. A four level indicator on the bottom of your machine's LCD will show the wireless signal strength of your access point or router.

To install MFL-Pro Suite, continue to step 14.

For Windows® Users:

Now go to

Page 32

For Mac OS® Users:

Now go to

Page 36



13 Configure the wireless settings using the automatic wireless (one-push) method

- a** Confirm your wireless router or access point has the SecureEasySetup™, Wi-Fi Protected Setup™ or AOSS™ symbol as shown below.



- b** Place the Brother machine within range of a SecureEasySetup™, Wi-Fi Protected Setup™ or AOSS™ access point/router. The range may differ depending on your environment. Refer to the instructions provided with your access point/router.
- c** Push the SecureEasySetup™, Wi-Fi Protected Setup™ or AOSS™ button on your wireless router or access point. See the user's guide for your wireless router or access point for instructions.

- d** On your machine, press **Menu**. Press **▲** or **▼** to choose **Network** and press **OK**. Press **▲** or **▼** to choose **WLAN** and press **OK**. Press **▲** or **▼** to choose **SES/WPS/AOSS** and press **OK**.

When **Network I/F switched to Wireless** is displayed, press **OK** to accept. This will start the wireless setup wizard. To cancel, press **Clear/Back**.

This feature will automatically detect which mode (SecureEasySetup™, Wi-Fi Protected Setup™ or AOSS™) your access point uses to configure your machine.

Note

If your wireless access point supports Wi-Fi Protected Setup™ (PIN Method) and you want to configure your machine using the PIN (Personal Identification Number) Method, see *Using the PIN Method of Wi-Fi Protected Setup™ in the Network User's Guide on the CD-ROM*.

- e** If the LCD shows **Connected**, the machine has successfully connected to your router or access point. You can now use your machine in a wireless network.

If the LCD shows **Setting WLAN, Connecting SES (Connecting WPS or Connecting AOSS), then Connection Failed**, the machine has not successfully connected to your router or access point. Try starting from **c** again. If the same message is indicated again, reset the machine back to the default factory settings and try again. For resetting, see *Restore the network settings to factory default* on page 43.

If the LCD shows **Setting WLAN, then Connection Failed or Incorrect Mode**, a session overlap or connection failure was detected. (see the table below), the machine has detected 2 or more routers or access points on your network that have the SecureEasySetup™, Wi-Fi Protected Setup™ mode or AOSS™ mode enabled. Make sure that only one router or access point has the SecureEasySetup™, Wi-Fi Protected Setup™ mode or AOSS™ mode enabled and try starting from **c** again.

LCD messages when using the SES/WPS/AOSS control panel menu	
<i>Setting WLAN</i>	<i>Searching or accessing the access point and downloading settings from the access point.</i>
<i>Connecting SES/WPS/AOSS</i>	<i>Connecting to the access point.</i>
<i>Connection Failed</i>	<i>Connection failed. If this is shown after the LCD shows Connecting SES/WPS/AOSS, a session overlap was detected.</i>
<i>Incorrect Mode</i>	<i>A session overlap was detected.</i>
<i>Connected</i>	<i>The machine has successfully connected.</i>

Note

If you encounter a problem during setup, temporarily place your machine closer to the wireless access point, and go back to **c**.



Wireless setup is now complete.



Wireless setup is now complete. To install MFL-Pro Suite, continue to step **14**.

For Windows® Users:

Now go to

Page 32

For Mac OS® Users:

Now go to

Page 36



Install the Drivers & Software

(For Windows® 2000 Professional/XP/XP Professional x64 Edition/
Windows Vista®)

14

Before you install MFL-Pro Suite

- a** Make sure that your computer is ON and you are logged on with Administrator rights.

Important

- If there are any programs running, close them.
- Make sure there are no memory cards or a USB Flash memory drive inserted.
- The screens may differ depending on the operating system.
- The supplied CD-ROM includes ScanSoft™ PaperPort™ 11SE*. This software supports Windows® 2000 (SP4 or greater), XP (SP2 or greater), XP Professional x64 Edition and Windows Vista®. Update to the latest Windows® Service Pack before installing MFL-Pro Suite.

* For Hong Kong users, CD-ROM includes Presto!® PageManager® instead of ScanSoft™ PaperPort™ 11SE.

Important

Before installation, if you are using personal firewall software (other than Windows® Firewall), anti-spyware or antivirus applications, temporarily disable them.

15

Install MFL-Pro Suite

- a** Put the supplied CD-ROM into your CD-ROM drive. If the model name screen appears, choose your machine. If the language screen appears, choose your language.

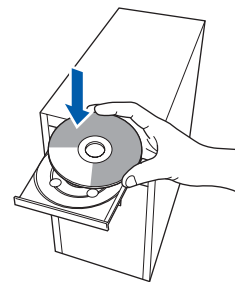

Note

If the Brother screen does not appear automatically, go to **My Computer (Computer)**, double-click the CD-ROM icon, and then double-click **start.exe**.

- b** The CD-ROM main menu will appear. Click **Install MFL-Pro Suite**.

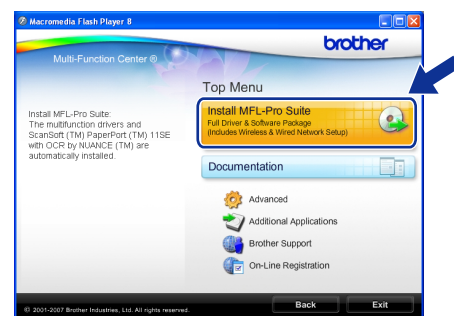



Note

- If this screen appears, click **OK** and restart your computer.

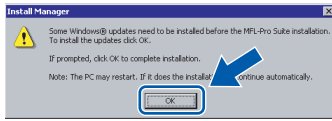

- If the installation does not continue automatically, open the main menu again by ejecting and then reinserting the CD-ROM or double-click the **start.exe** program from the root folder, and continue from **b** to install MFL-Pro Suite.
- For Windows Vista®, when the **User Account Control** screen appears, click **Allow**.

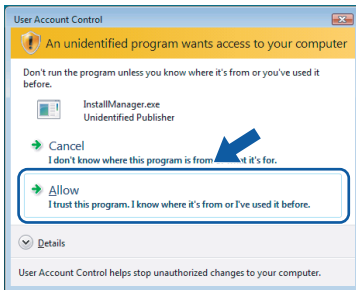

- When the ScanSoft™ PaperPort™ 11SE License Agreement window appears, click **Yes** if you agree to the Software License Agreement.

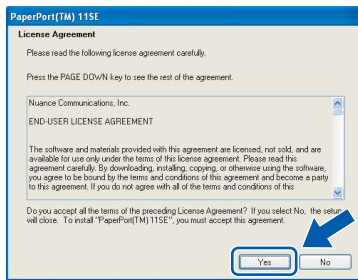

- The installation of ScanSoft™ PaperPort™ 11SE will automatically start and is followed by the installation of MFL-Pro Suite.

- When the Brother MFL-Pro Suite Software License Agreement window appears, click **Yes** if you agree to the Software License Agreement.

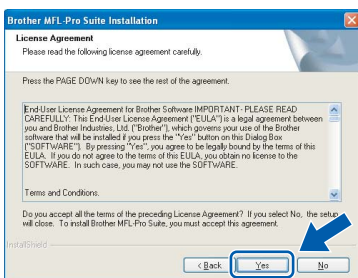

f

Choose **Wireless Network Connection**, and then click **Next**.

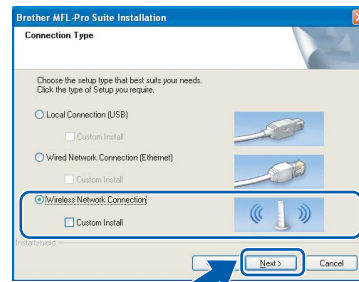

g

Click on **Checked and confirmed** check box, and then click **Next**.

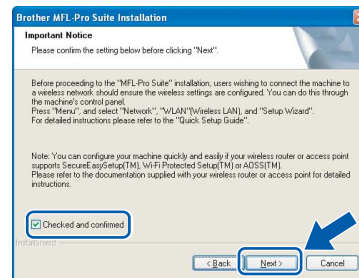

h

For Windows® XP SP2/Windows Vista® users, when this screen appears, choose **Change the Firewall port settings to enable network connection and continue with the installation. (Recommended)** and click **Next**.

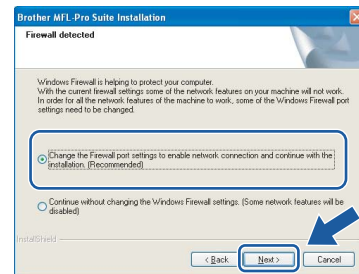

If you are using a firewall other than Windows® Firewall or Windows® Firewall is off, this screen may appear.

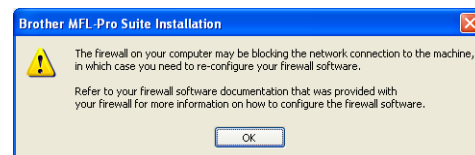

See the instructions provided with your firewall software for information on how to add the following network ports.

- For network scanning, add UDP port 54925.
- If you still have trouble with your network connection, add UDP port 137.



Note

- If the machine is configured for your network, choose the machine from the list, and then click **Next**.

This window will not appear if there is only one machine connected on the network, it will be chosen automatically.

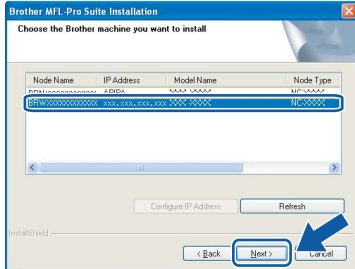

If your machine shows **APIPA** in the **IP Address** field, click **Configure IP Address** and enter an IP address for your machine that is suitable for your network.



- If your wireless settings fail, an error message will appear during the installation of MFL-Pro Suite and the installation will be terminated. If you encounter this failure, go to step 12 on page 27 and setup the wireless connection again.
- If you are using WEP and the LCD displayed 'Connected' but your machine is not found, make sure you entered the WEP key correctly. The WEP key is case sensitive.
- If the machine is not yet configured for use on your network, the following screen appears.



Click **OK**.
The **Configure IP Address** window will appear. Enter an IP address for your machine that is suitable for your network by following the on-screen instructions.

i

The installation of the Brother drivers will automatically start. The installation screens appear one after another.

Important

DO NOT cancel any of the screens during the installation. It may take a few seconds for all screens to appear.

Note

For Windows Vista®, when this screen appears, click the check box and click **Install** to complete the installation correctly.

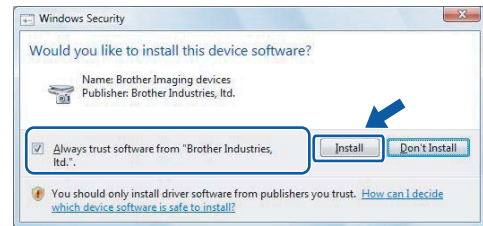

j

When the **On-Line Registration** screen is displayed, make your selection and follow the on-screen instructions.

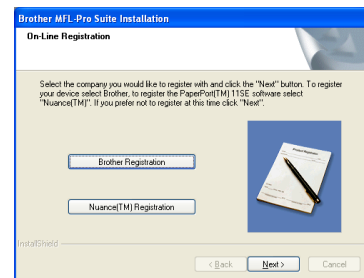



16 Finish and restart

- a Click **Finish** to restart your computer. After restarting the computer, you must be logged on with Administrator rights.

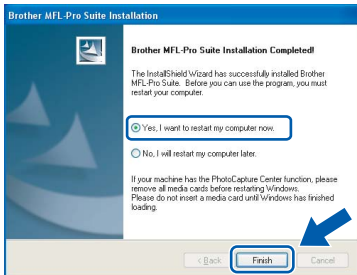

Note

If an error message appears during the software installation, run the **Installation Diagnostics** located in **Start/All Programs/Brother/DCP-XXXX** (where DCP-XXXX is your model name).

17 Install MFL-Pro Suite on additional computers (If needed)

If you want to use your machine with multiple computers on the network, install MFL-Pro Suite on each computer. Go to step **14** on page 32.

Note

This product includes a PC license for up to 2 Users.
This license supports the installation of the MFL-Pro Suite including ScanSoft™ PaperPort™ 11SE on up to 2 PCs on the network.
If you want to use more than 2 PCs with ScanSoft™ PaperPort™ 11SE installed, please buy the Brother NL-5 pack which is a multiple PC license agreement pack for up to 5 additional users. To buy the NL-5 pack, contact your Brother dealer.

Finish

The installation is now complete.

Now go to

Proceed to Install Optional Applications on page 39.



Install the Drivers & Software (For Mac OS® X 10.2.4 or greater)

14 Before you install MFL-Pro Suite

- a** Make sure your machine is connected to the power and your Macintosh® is ON. You must be logged on with Administrator rights.

Important

- For Mac OS® X 10.2.0 to 10.2.3 users, upgrade to Mac OS® X 10.2.4 or greater. (For the latest information for Mac OS® X, visit <http://solutions.brother.com/>)
- Make sure there are no memory cards or a USB Flash memory drive inserted.

15 Install MFL-Pro Suite

- a** Put the supplied CD-ROM into your CD-ROM drive.

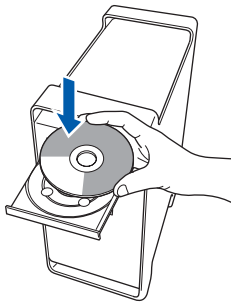

- b** Double-click the **Start Here OSX** icon to install.

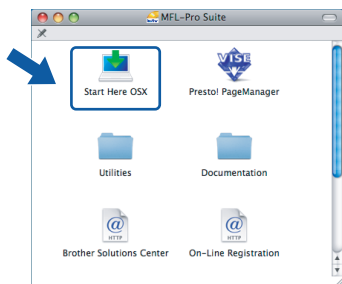

- c** Choose **Wireless Network Connection**, and then click **Next**.

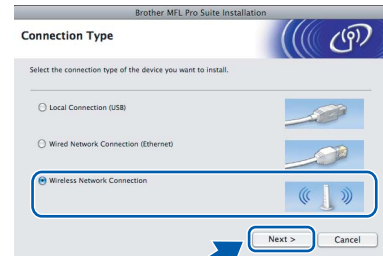

- d** Click on the **Checked and confirmed** check box, and then click **Next**. Follow the on-screen instructions.



Note

*Please wait, it will take a few seconds for the software to install. After the installation, click **Restart** to finish installing the software.*

- e** The Brother software will search for the Brother device. During this time the following screen will appear.

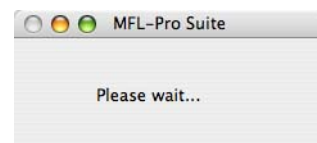



Note

- If the machine is configured for your network, choose the machine from the list, and then click **OK**.

This window will not appear if there is only one machine connected on the network, it will be chosen automatically. Go to **f**.

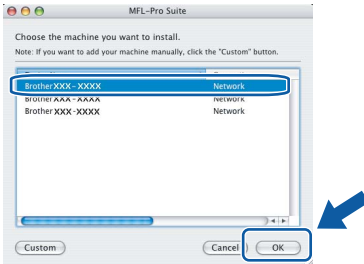

- If your machine is not detected, go to step **12** on page 27 and setup the wireless connection again.
- If you are using WEP and the LCD displayed 'Connected' but your machine is not found, make sure you entered the WEP key correctly. The WEP key is case sensitive.
- If this screen appears click **OK**.



Enter a name for your Macintosh® in **Display Name** up to 15 characters long and click **OK**. Go to **f**.

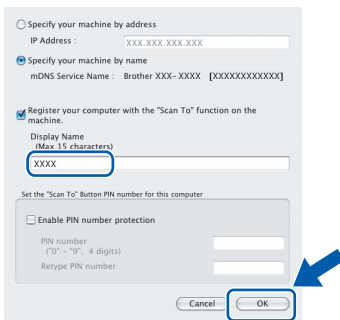

- If you want to use the machine's **Scan** key to scan over the network you must check the **Register your computer with the "Scan To" function on the machine box**.
- The name you enter will appear on the machine's LCD when you press the **Scan** key and choose a scan option. (For more information, see *Network Scanning in the Software User's Guide on the CD-ROM*.)

- f** When this screen appears, click **OK**.

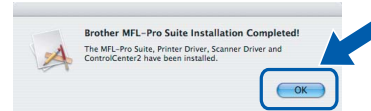

- OK!** For Mac OS® X 10.3.x or greater, the installation of MFL-Pro Suite is now complete. Go to step **16** on page 38.

- g** For Mac OS® X 10.2.4 to 10.2.8 users, click **Add**.

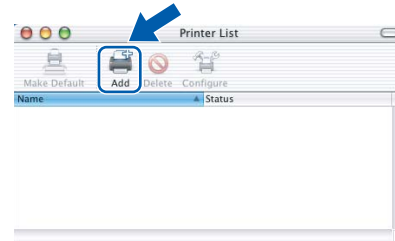

- h** Make the selection shown below.

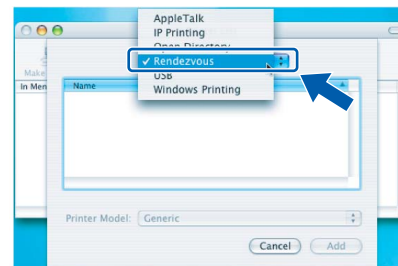

- i** Choose **XXX-XXXX** (where XXX-XXXX is your model name), and then click **Add**.

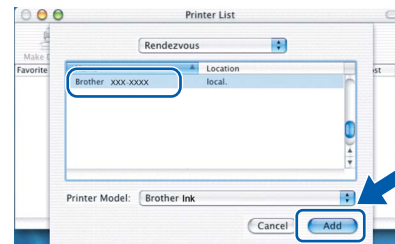

- j** Click **Print Center**, then **Quit Print Center**.

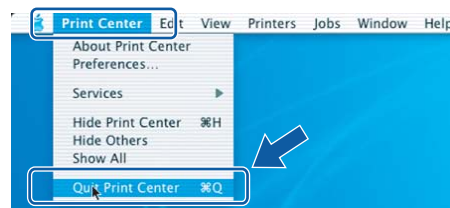
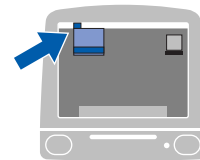

- OK!** The installation of MFL-Pro Suite is now complete. Go to step **16** on page 38.



16 Install Presto!® PageManager®

When Presto!® PageManager® is installed OCR capability is added to Brother ControlCenter2. You can easily scan, share and organize photos and documents using Presto!® PageManager®.

- a** Double-click the **Presto! PageManager** icon and follow the on-screen instructions.



For Mac OS® X 10.2.4 to 10.3.8 users, when this screen appears, click **Go** to download the software from the Brother Solutions Center website.



17 Install MFL-Pro Suite on additional computers (If needed)

If you want to use your machine with multiple computers on the network, install MFL-Pro Suite on each computer. Go to step **14** on page 36.

Finish

The installation is now complete.

1 Install FaceFilter Studio supported by Reallusion, Inc

FaceFilter Studio is an easy-to-use borderless photo printing application. FaceFilter Studio also lets you edit your photo data and add photo effects such as red eye reduction or skin tone enhancement.

Important

- The machine must be ON and connected to the computer.
- The computer must be connected to the Internet.

- Open the main menu again by ejecting and then reinserting the CD-ROM or by double-clicking the **start.exe** program from the root folder.
- The CD-ROM main menu will appear. Choose your language and then click **Additional Applications**.

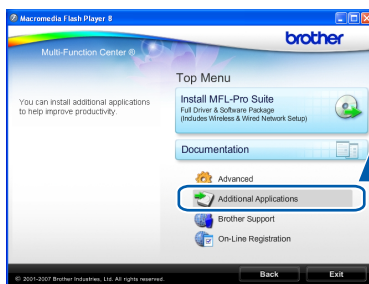

- Click the **FaceFilter Studio** button to install.

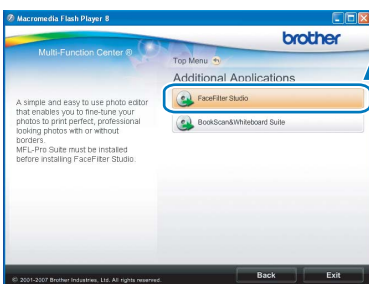

2 Install FaceFilter Studio Help (For Hong Kong users, CD-ROM includes FaceFilter Studio Help)

To get instructions on how to use FaceFilter Studio, download and install FaceFilter Studio Help.

- To run FaceFilter Studio, go to **Start/All Programs/Reallusion/FaceFilter Studio** on your computer.
- Click the **?** button on the upper right corner of the screen.
- Click **Check for updates** to go to the Reallusion update web page.



- Click the **Download** button and choose a folder to save the file in.
- Close FaceFilter Studio before you start the installer for FaceFilter Studio Help. Double-click the downloaded file from the folder you specified and follow the on-screen instructions for installation.

Note

To view the complete FaceFilter Studio Help, choose **Start/All Programs/Reallusion/FaceFilter Studio/FaceFilter Studio Help** on your computer.

3 Install BookScan&Whiteboard Suite supported by Reallusion, Inc

You can install **BookScan&Whiteboard Suite**. The **BookScan Enhancer** software can correct your scanned book images automatically. The **Whiteboard Enhancer** software cleans up and enhances text and images from photos taken of your whiteboard. (Internet access required.)

Important

- The machine must be ON and connected to the computer.
- The computer must be connected to the Internet.

- Open the main menu again by ejecting and then reinserting the CD-ROM or by double-clicking the **start.exe** program from the root folder.
- The CD-ROM main menu will appear. Choose your language and then click **Additional Applications**.



- Click the **BookScan&Whiteboard Suite** button to install.

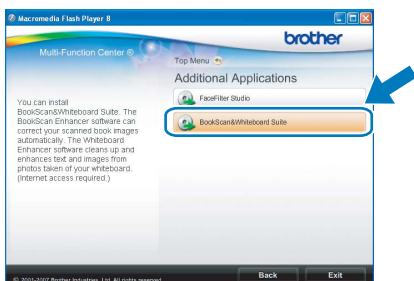

BRAdmin Light utility (For Windows® users)

BRAdmin Light is a utility for initial setup of Brother network connected devices. It also can search for Brother products on your network, view the status and configure basic network settings, such as IP address. For more information on BRAdmin Light, visit us at <http://solutions.brother.com/>.

Note

If you require more advanced printer management, use the latest Brother BRAdmin Professional utility version that is available as a download from <http://solutions.brother.com/>.

Install the BRAdmin Light configuration utility

- a** Click **Advanced** and then **Network Utilities** on the menu screen.

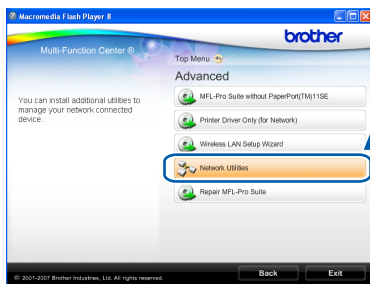
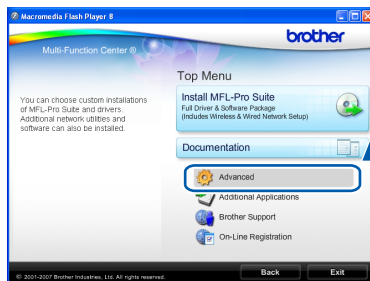

- b** Click **BRAdmin Light** and follow the on-screen instructions.



Set your IP address, Subnet Mask and Gateway using BRAdmin Light

Note

If you have a DHCP/BOOTP/RARP server in your network, you don't have to do the following operation. The machine will automatically obtain its own IP address.

- a** Start BRAdmin Light. It will search for new devices automatically.

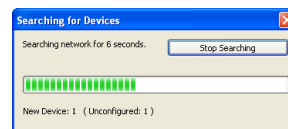

- b** Double-click the unconfigured device.

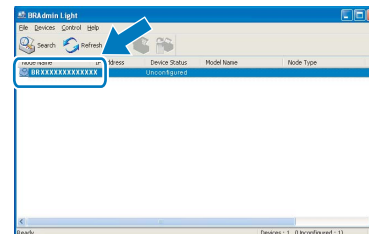

- c** Choose **STATIC** for the **Boot Method**. Enter the **IP Address**, **Subnet Mask** and **Gateway**, and then click **OK**.

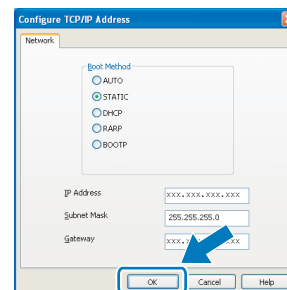

- d** The address information will be saved to the machine.

BRAdmin Light utility (For Mac OS® X users)

BRAdmin Light is a utility for initial setup of Brother network connected devices. It also can search for Brother products on your network, view the status and configure basic network settings, such as IP address from a computer running Mac OS® X 10.2.4 or greater.

The BRAdmin Light software will be installed automatically when you install the printer driver. If you have already installed the printer driver, you don't have to install BRAdmin Light again. For more information on BRAdmin Light, visit us at <http://solutions.brother.com/>.

Set your IP address, Subnet Mask and Gateway using BRAdmin Light

Note

- If you have a DHCP/BOOTP/RARP server in your network, you don't have to do the following operation. The machine will automatically obtain its own IP address.
- Make sure that version 1.4.1_07 or later of Java™ client software is installed on your computer.

- a** Double-click the **Macintosh HD** icon on your desktop.

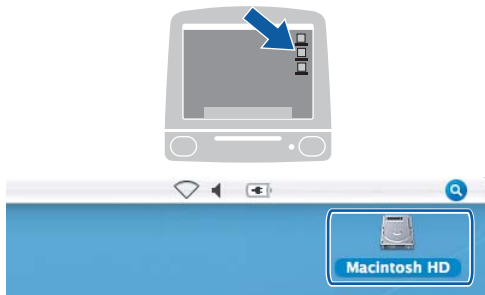

- b** Choose **Library**, **Printers**, **Brother** and then **Utilities**.

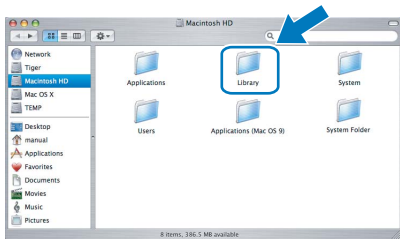

- c** Double-click the file **BRAdmin Light.jar** and run the software. BRAdmin Light will then search for new devices automatically.

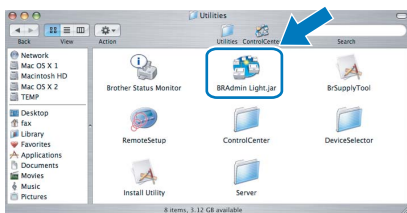

- d** Double-click the unconfigured device.

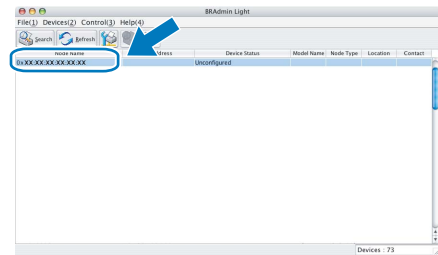

- e** Choose **STATIC** for the **Boot Method**. Enter the **IP Address**, **Subnet Mask** and **Gateway**, and then click **OK**.

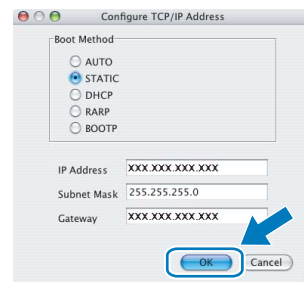

- f** The address information will be saved to the machine.

Restore the network settings to factory default

To restore all network settings of the internal Print/Scan server to factory default, please follow the steps below.

- a** Make sure the machine is not operating, then disconnect all the cables from the machine (except the power cord).
- b** Press **Menu**.
- c** Press **▲** or **▼** to choose **Network**.
Press **OK**.
- d** Press **▲** or **▼** to choose **Factory Reset**.
Press **OK**.
- e** Press **+** to choose **Yes**.
- f** Press **+** to choose **Yes**.
- g** The machine will restart, re-connect cables once this is complete.

Entering Text for Wireless Settings

Press **▲** or **▼** repeatedly to select a character from the list below:

abcdefghijklmnopqrstuvwxyzABCDEFGHIJKLMNOPQRSTUVWXYZ0123456789

(space)!"#\$%&'()*+,-./:;<=>?@[^_`{|}~

Press **◀** or **▶** repeatedly to move the cursor.



Note





Making corrections

*If you entered an incorrect letter and want to change it, press **◀** or **▶** to position the cursor under the incorrect letter. Use the **▲** and **▼** keys to change to the correct letter, then press **▶** repeatedly to move the cursor back to the end of the text.*

Replacement consumables

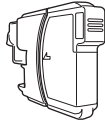
When the time comes to replace ink cartridges, an error message will be indicated on the LCD. For more information about the ink cartridges for your machine, visit <http://www.brother.com/original/> or contact your local Brother re-seller.

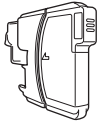
Ink cartridge

Black	Yellow	Cyan	Magenta
LC67BK	LC67Y	LC67C	LC67M
			

What is Innobella™?

Innobella™ is a range of genuine consumables offered by Brother. The name "Innobella™" derives from the words "Innovation" and "Bella" (meaning "Beautiful" in Italian) and is a representation of the "innovative" technology providing you with "beautiful" and "long lasting" print results.



Trademarks

The Brother logo is a registered trademark of Brother Industries, Ltd.

Brother is a registered trademark of Brother Industries, Ltd.

Multi-Function Link is a registered trademark of Brother International Corporation.

Windows Vista is either a registered trademark or a trademark of Microsoft Corporation in the United States and other countries.

Microsoft, Windows and Windows Server are registered trademarks of Microsoft Corporation in the United States and/or other countries.

Macintosh and TrueType are registered trademarks of Apple Inc.

Nuance, the Nuance logo, PaperPort and ScanSoft are trademarks or registered trademarks of Nuance Communications, Inc. or its affiliates in the United States and/or other countries.

Presto! PageManager is a registered trademark of NewSoft Technology Corporation.

PictBridge is a trademark.

FaceFilter Studio is a trademark of Reallusion, Inc.

BROADCOM, SecureEasySetup and the SecureEasySetup logo are trademarks or registered trademarks of Broadcom Corporation in the United States and/or other countries.

AOSS is a trademark of Buffalo Inc.

Wi-Fi, WPA and WPA2 are registered trademarks and Wi-Fi Protected Setup is a trademark of Wi-Fi Alliance.

Each company whose software title is mentioned in this manual has a Software License Agreement specific to its proprietary programs.

All other brand and product names mentioned in this manual are trademarks or registered trademarks of their respective companies.

Compilation and Publication

Under the supervision of Brother Industries, Ltd., this manual has been compiled and published, covering the latest product descriptions and specifications.

The contents of this manual and the specifications of this product are subject to change without notice.

Brother reserves the right to make changes without notice in the specifications and materials contained herein and shall not be responsible for any damages (including consequential) caused by reliance on the materials presented, including but not limited to typographical and other errors relating to the publication.

Copyright and License

©2008 Brother Industries, Ltd.

This product includes software developed by the following vendors:

©1983-1998 PACIFIC SOFTWARES, INC.

This product includes the "KASAGO TCP/IP" software developed by ELMIC WESCOM, Inc.

©2008 Devicescape Software, Inc.