

# Product Safety Guide

ADS-2100e  
ADS-2600We

UK/IRE/GEN Version A

Please read this booklet before attempting to operate the machine, or before attempting any maintenance. Failure to follow these instructions may result in an increased risk of fire, electrical shock, burns or suffocation. Brother shall not be liable for damage caused where the product owner has failed to follow instructions set out in this guide.

## How to use this guide:

- 1 Read the whole guide before using your machine and keep it for later reference.
- 2 Carefully follow the instructions set out in this guide and always ensure that you follow all warnings and instructions marked on the product.
- 3 If you have concerns about how to use your machine having read this guide, please refer to your local Brother dealer or Brother customer service.
- 4 To ensure you understand all of the instructions, study the Symbols and Conventions used in the documentation below.

## Symbols and conventions used in the documentation

The following symbols and conventions are used throughout the documentation:

### **WARNING**

**WARNING** indicates a potentially hazardous situation which, if not avoided, could result in death or serious injuries.

### **CAUTION**

**CAUTION** indicates a potentially hazardous situation which, if not avoided, may result in minor or moderate injuries.

### **IMPORTANT**

**IMPORTANT** indicates a potentially hazardous situation which, if not avoided, may result in damage to property or loss of product functionality.

### **NOTE**

**NOTE** tells you how you should respond to a situation that may arise or give tips about how the operation works with other features.



Prohibition icons indicate actions that must not be performed.



This icon indicates that flammable sprays may not be used.



This icon indicates that organic solvents such as alcohol and liquids may not be used.



Electrical Hazard icons alert you to possible electrical shocks.



Fire Hazard icons alert you to the possibility of fire.

### **Bold**

Bold typeface identifies specific buttons on the machine's control panel, or on the computer screen.

### *Italics*

Italicised typeface emphasises an important point or refers you to a related topic.

(ADS-2600We only)  
Courier New Text in the Courier New font identifies messages on the LCD of the machine.

Follow all warnings and instructions marked on the machine.

### **NOTE**

The illustrations in this guide show the ADS-2100e.

# Product Safety Guide

## Compilation and Publication Notice

This manual has been compiled and published to provide the latest product safety information at the time of publication. The information contained in this manual may be subject to change.

For the latest manual, please visit us at [support.brother.com](http://support.brother.com)

## Choose a safe location for the machine

Put your machine on a flat, stable surface that is free from shocks and vibrations, such as a desk. Put the machine near a standard grounded electrical socket. Choose a dry, well ventilated location where the temperature remains between 5 and 35 °C.

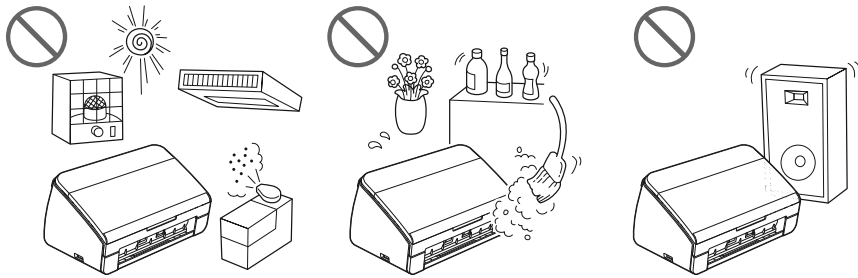

### ! WARNING



**DO NOT** expose the machine to direct sunlight, excessive heat, open flames, corrosive gasses, moisture or dust. **DO NOT** place the machine on a carpet or rug, as this will expose it to dust. Doing so may create a risk of an electrical short or fire. It may also damage the machine and/or render it inoperable.



**DO NOT** place the machine near radiators, heaters, air conditioners, water, chemicals or devices that contain magnets or generate magnetic fields. Doing so may create the risk of a short circuit or fire should water come into contact with the machine (including condensation from heating, air conditioning, and/or ventilation equipment that may be sufficient to create a short circuit or fire).



**DO NOT** place the machine near chemicals or in a place where chemical spillage could occur. In particular, organic solvents or liquids may cause the casing and/or cables to melt or dissolve, risking fire or electric shock. They may also cause the machine to malfunction or become discoloured.

# Product Safety Guide



Slots and openings in the casing, back or bottom of the product are provided for ventilation. To avoid blocking or covering these openings, the machine should be placed where it will not touch any wall or other device. Blocking the machine's ventilation could create a risk of overheating and/or fire.

## IMPORTANT

- Always place the machine on a solid surface, never on a bed, sofa, rug, or similar soft surfaces.
- DO NOT place the machine in a "built-in" installation.

## CAUTION

Make sure that no part of the machine protrudes from the desk or stand where the machine is located. In particular, do not leave the output tray open when the machine is located on the edge of a table, stand, etc. Make sure that the machine is located on a flat, level, and stable surface free from vibration. Failure to observe these precautions could cause the machine to fall, causing injury to you and serious damage to the machine.

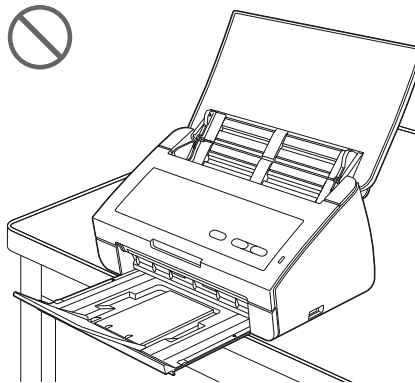

DO NOT place the machine on an unstable or tilted cart, stand, table or on any tilted/slanted surface. The machine may fall, causing injury to you and serious damage to the machine.

## IMPORTANT

- DO NOT put objects on top of the machine.
- DO NOT place the machine next to sources of interference, such as speakers or the base units of non-Brother cordless telephones. Doing so may interfere with the operation of the machine's electronic components.

# Product Safety Guide

## General precautions

### **! WARNING**

Plastic bags are used in the packing of the machine. To avoid danger of suffocation, keep these plastic bags away from babies and children. Plastic bags are not toys.



Never insert any objects into the slots in the machine's casing, since they may touch dangerous voltage points or short out parts resulting in the risk of fire or electric shock. If metal objects, water or other liquids get inside the machine, immediately unplug the machine from the electrical socket. Contact your Brother dealer or Brother customer service.



DO NOT use flammable substances, any type of spray, or an organic solvent/liquid that contains alcohol or ammonia to clean the inside or outside of the machine. Doing this may cause a fire or electrical shock.



DO NOT disassemble or modify the machine, otherwise fire or electric shock may result. If the machine requires repair, contact your Brother dealer or Brother customer service.



DO NOT touch the machine during a thunderstorm. There may be a remote risk of electric shock from lightning when the machine is used during a thunderstorm.



DO NOT use the machine near any liquids, for example, near a bath tub, wash bowl, kitchen sink or washing machine, in a wet basement or near a swimming pool.

# Product Safety Guide

## **⚠ CAUTION**

DO NOT try and pick up pages until they have finished scanning and are ejected from the machine. Doing this may cause you injury by trapping your fingers in the rollers.

Some areas of the machine can cause injury if covers (shaded) are closed with force. Take care when placing your hand in the areas shown in the illustrations.

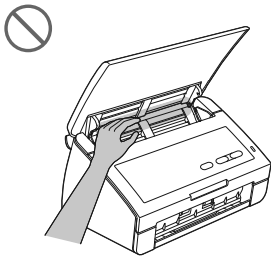
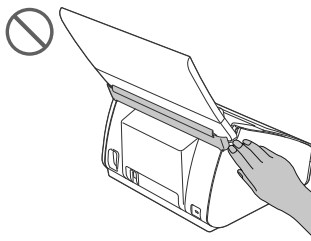
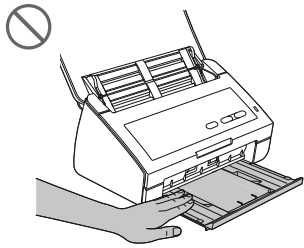
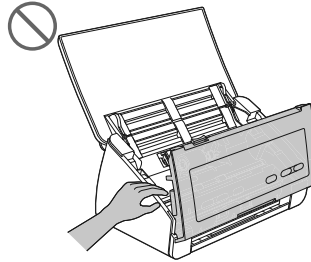
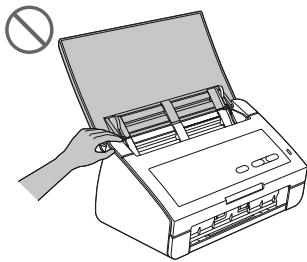

# Product Safety Guide

Be careful when touching the Separation Pad and its surrounding area in the machine. Otherwise, you could cause injury to yourself, and serious damage to the machine.

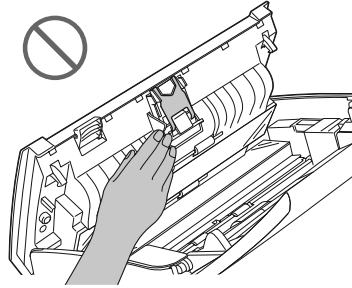

DO NOT carry the machine by holding the top cover. Doing this may cause the machine to slip out of your hands. Only carry the machine by placing your hands under the entire machine.

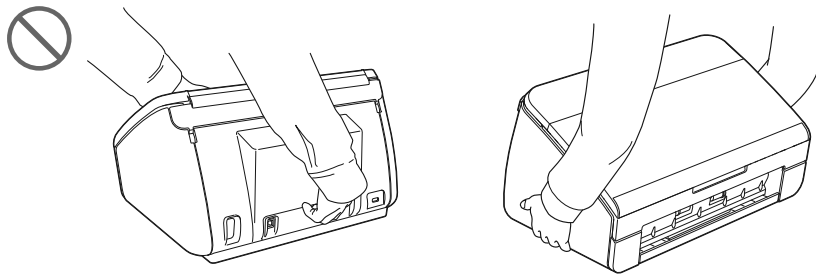

Use caution when operating the machine to prevent clothing (particularly sleeves, neckties, etc.), hair, or accessories from being drawn into the machine, otherwise injury may result. In the event that an object is drawn into the machine, immediately disconnect the machine from the power source.

## IMPORTANT

(ADS-2600We only)

DO NOT touch the Touchscreen immediately after plugging in the power cord or turning on the machine. Doing this may cause an error.

# Product Safety Guide

## Connecting the machine safely

### ! WARNING



There are high-voltage electrodes inside the machine. Before you access the inside of the machine, (for routine maintenance, such as cleaning), make sure you have unplugged the power cord from the electrical socket as well as any Ethernet (ADS-2600We only) cables from the machine.

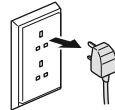

**DO NOT** handle the plug with wet hands. Doing this might cause an electrical shock.

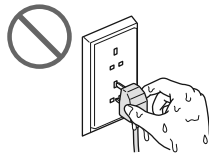

**DO NOT** connect it to a DC power source or inverter. Doing this might cause an electrical shock. If you are not sure what kind of power source you have, contact a qualified electrician.



**DO NOT** use the machine if the power cord is frayed or damaged, doing so may cause an electrical shock or a fire.



**DO NOT** pull on the middle of the AC power cord. **DO NOT** allow anything to rest on the power cord. **DO NOT** place the machine where people can walk on the cord. Doing this might cause an electrical shock or a fire.



Brother strongly recommends that you **DO NOT** use any type of extension cord. Failure to observe these precautions could cause fire, electric shock, or damage to the machine.

# Product Safety Guide

## Servicing the machine

DO NOT attempt to service the machine yourself. Opening or removing covers may expose you to dangerous voltages and other risks, and may void your warranty. Contact your Brother dealer or Brother customer service.

### **WARNING**



**If the machine has been dropped or the casing has been damaged, there may be the possibility of an electric shock or a fire. Unplug the machine from the power socket and contact your Brother dealer or Brother customer service.**

### **CAUTION**

If the machine becomes unusually hot, releases smoke, generates any strong smells, or if you accidentally spill any liquid on it, immediately unplug the machine from the electrical socket. Contact your Brother dealer or Brother customer service.

### **IMPORTANT**

If the machine does not operate normally when the operating instructions are followed, adjust only those controls that are covered by the operating instructions. Incorrect adjustment of other controls may result in damage, and will often require extensive work by a qualified technician to restore the machine to normal operation.



# Product Safety Guide

## Product Warranty & Liability

Nothing in this guide shall affect any existing product warranty or be construed as granting any additional product warranty. Failure to follow the safety instructions in this guide may invalidate your product's warranty.

### **! WARNING**

**Use only the power cord supplied with this machine.**

**This product must be installed near an electrical socket that is easily accessible. In case of an emergency, you must unplug the power cord from the electrical socket to shut off the power completely.**

## Wiring information (U.K. only)

If you need to replace the fuse in the plug, fit a fuse that is approved by ASTA to BS1362 with the same rating as the original fuse. Always replace the fuse cover. Never use a plug that does not have a cover. If in any doubt, call a qualified electrician.

Warning - This machine must be earthed.

The wires in the mains lead are coloured in line with the following code:

- Green and Yellow: Earth
- Blue: Neutral
- Brown: Live

## Declaration of Conformity (Europe only)

We, Brother Industries, Ltd.

15-1, Naeshiro-cho, Mizuho-ku, Nagoya 467-8561 Japan

declare that this product is in conformity with the essential requirements of all relevant directives and regulations applied within the European Community.

The Declaration of Conformity (DoC) can be downloaded from Brother Solutions Center. Visit [support.brother.com](http://support.brother.com) and:

- > select "Europe"
- > select your country
- > select your model
- > select "Manuals".

Your Declaration will be downloaded as a PDF file.

# Product Safety Guide

## Declaration of Conformity for R&TTE (Radio and Telecommunications) Directive 1999/5/EC (Europe only) (ADS-2600We only)

We, Brother Industries, Ltd.  
15-1, Naeshiro-cho, Mizuho-ku, Nagoya 467-8561 Japan  
declare that this product is in conformity with the provisions of the R&TTE Directive 1999/5/EC.  
A copy of the Declaration of Conformity can be downloaded by following the instructions in the Declaration of Conformity (Europe only) section.

## [After 13th June 2017] Declaration of Conformity for RE Directive 2014/53/EU (ADS-2600We only)

We, Brother Industries, Ltd.  
15-1, Naeshiro-cho, Mizuho-ku, Nagoya 467-8561 Japan  
declare that this product is in conformity with the provisions of the RE Directive 2014/53/EU.  
A copy of the Declaration of Conformity can be downloaded by following the instructions in the Declaration of Conformity section.

## Wireless LAN (ADS-2600We only)

This scanner has a wireless interface.  
Frequency band(s): 2400 - 2483.5 MHz  
Maximum radio-frequency power transmitted in the frequency band(s): less than 20 dBm (e.i.r.p)

## LAN connection (ADS-2600We only)

### IMPORTANT

DO NOT connect this machine to a LAN connection that is subject to over voltages.

## Radio interference

This product complies with EN55022 (CISPR Publication 22)/Class B. When connecting the machine to a computer, ensure that you use a USB cable which does not exceed 2 m in length.

## Information for compliance with Commission Regulation 801/2013

Power consumption* (Networked Standby mode)	ADS-2100e 1.5 W	ADS-2600We 5.0 W
--	--------------------	---------------------

\* All network ports activated and connected

# Product Safety Guide

## WLAN Enable/Disable (ADS-2600We only)

- 1 Press .
- 2 Press **Network**.
- 3 Press **WLAN**.
- 4 Press **▲** or **▼** to display **WLAN Enable**.
- 5 Press **WLAN Enable**.
- 6 Press **On** (or **Off**).

## Recycling information in accordance with the WEEE and Battery Directives



Product mark



Battery mark

European Union only

The product/battery is marked with one of the above recycling symbols. It indicates that at the end of the life of the product/battery, you should dispose of it separately at an appropriate collection point and not place it in the normal domestic waste stream.

## International ENERGY STAR® Qualification Statement

The purpose of the International ENERGY STAR® Program is to promote the development and popularisation of energy-efficient office equipment.

As an ENERGY STAR® Partner, Brother Industries, Ltd. has determined that this product meets the ENERGY STAR® specifications for energy efficiency.



# Product Safety Guide

## Trademarks

BROTHER is either a trademark or a registered trademark of Brother Industries, Ltd.

Microsoft, Windows, Windows Vista, Windows Server, Outlook and Internet Explorer are either registered trademarks or trademarks of Microsoft Corporation in the United States and/or other countries.

Apple, Macintosh, Mac OS and Safari are trademarks of Apple Inc., registered in the United States and other countries.

Nuance, the Nuance logo, PaperPort and ScanSoft are trademarks or registered trademarks of Nuance Communications, Inc. or its affiliates in the United States and/or other countries.

AOSS is a trademark of Buffalo Inc.

WPA, WPA2, Wi-Fi Protected Access and Wi-Fi Protected Setup are marks of the Wi-Fi Alliance.

Wi-Fi and Wi-Fi Alliance are registered marks of the Wi-Fi Alliance.

AMD is a trademark of Advanced Micro Devices, Inc.

Linux is the registered trademark of Linus Torvalds in the U.S. and other countries.

Android is a trademark of Google Inc.

ISIS, Captiva and QuickScan are either registered trademarks or trademarks of EMC Corporation in the United States and/or other countries.

Intel is a trademark of Intel Corporation in the U.S. and/or other countries.

Adobe, Reader and Photoshop are either registered trademarks or trademarks of Adobe Systems Incorporated in the United States and/or other countries.

Each company whose software title is mentioned in this manual has a Software License Agreement specific to its proprietary programs.

**Any trade names and product names of companies appearing on Brother products, related documents and any other materials are all trademarks or registered trademarks of those respective companies.**

### Compilation and Publication

Under the supervision of Brother Industries, Ltd., this manual has been compiled and published, covering the latest product descriptions and specifications.

The contents of this manual and the specifications of this product are subject to change without notice.

Brother reserves the right to make changes without notice in the specifications and materials contained herein and shall not be responsible for any damages (including consequential) caused by reliance on the materials presented, including but not limited to typographical and other errors relating to the publication.

### Copyright and License

© 2014 Brother Industries, Ltd. All rights reserved.

This product includes software developed by the following vendors:

© 1983-1998 PACIFIC SOFTWARES, INC.

© 2008 Devicescape Software, Inc.

This product includes the "KASAGO TCP/IP" software developed by ZUKEN ELMIC, Inc.

# Product Safety Guide

## Open Source Licensing Remarks

This product includes open-source software.  
Please visit the Brother Solutions Center at [support.brother.com](http://support.brother.com) to see the open source licensing remarks.

## Brother customer service

### Customer service

Visit [www.brother.com](http://www.brother.com) for contact information for your local Brother office.

### Service centre locations

For service centres in Europe, contact your local Brother Office. Address and telephone contact information for European offices can be found at [www.brother.com](http://www.brother.com) by selecting your country.

## Unlawful use of scanning equipment

It is an offence to make reproductions of certain items or documents with the intent to commit fraud. The following is a non-exhaustive list of documents which it may be unlawful to produce copies of. We suggest you check with your legal adviser and/or the relevant legal authorities if in doubt about a particular item or document:

- Currency
- Bonds or other certificates of debt
- Certificates of deposit
- Armed forces service or draft papers
- Passports
- Postage stamps (cancelled or uncanceled)
- Immigration papers
- Welfare documents
- Cheques or drafts drawn by governmental agencies
- Identifying badges or insignias

Copyrighted works cannot be copied lawfully, subject to the “fair dealing” exception relating to sections of a copyrighted work. Multiple copies would indicate improper use. Works of art should be considered the equivalent of copyrighted works.

# Product Safety Guide

## Notice Regarding the Faithful Reproduction of Scanned Documents

After scanning a document, confirm that the accuracy and quality of the corresponding scan data meets your needs by confirming the size of the scan data, the amount of image data captured, image fidelity, colour tones, etc.

Always confirm the scan data before destroying the original document.

It is possible that a portion of the scan data may be lost or damaged, therefore, read all instructions carefully and keep the following in mind:

- Depending on the condition of the document, the document may become worn thin, distorted, dirty, or cracked during scanning. In this case, some or all of the scan data may be lost.

Confirm that the document has no wrinkles, bends, or holes.

- If the inside of the machine is dirty, the document may become worn thin, distorted, dirty, or cracked during scanning. In this case, some or all of the scan data may be lost.

Clean the inside of the machine carefully and regularly.

- The following may occur depending on the scan settings, such as document size, scanning resolution, colour-related settings, single-side or double-side scanning settings, auto deskew, blank page skip, etc:

- Text may be illegible or unclear if image resolution is too low.
- Scan data of a colour document may be captured in black-and-white.
- Only one side of a two-sided document may be captured.
- A portion of the document may not be scanned, or the size may be too small.
- The document may only be scanned up to a certain point, after which scan data will be lost.
- Blank pages may not be deleted, or pages may be deleted unnecessarily.
- Margins may be added to the edges of the scan data.

Refer to the User's Guide for information about how to configure the scan settings.

- Depending on the condition of the document (such as if it has wrinkles, bends, or holes) and consumables, multiple pages of a document may be fed at once, causing some pages to be missing from the scanned data.

Confirm that the document has no wrinkles, bends, or holes.

Replace all consumables periodically.

- When scanning documents that are not within the recommended guidelines, or depending on the condition of the document (such as if it has wrinkles, bends, or holes), consumables, or the paper feeding mechanisms inside the machine, documents may become jammed inside the machine during scanning. In this case, some or all of the scan data may be lost. (Documents may be destroyed as a result of a paper jam.)

Refer to "Acceptable Documents" in the User's Guide for information about acceptable documents.

# Product Safety Guide

- When scanning documents that have been marked with a fluorescent marker, marked areas may not be seen correctly in the scan data, or the marker colour may not be reproduced correctly, depending on the colour and density of the marker ink. You may achieve more desirable results by increasing the scanning resolution. Refer to the User's Guide for information about resolution settings.

# brother

Visit us on the World Wide Web  
[www.brother.com](http://www.brother.com)



[www.brotherearth.com](http://www.brotherearth.com)