

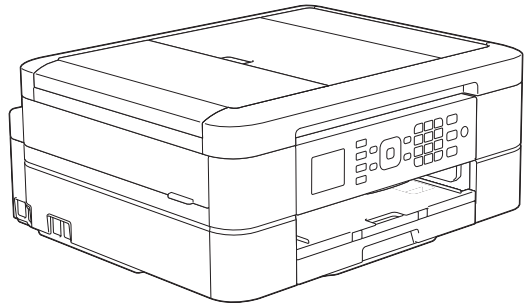

Basic User's Guide

MFC-J480DW



Online User's Guide

This Basic User's Guide contains basic instructions and information for your Brother machine.

For more advanced instructions and information, see the Online User's Guide at solutions.brother.com/manuals



If you need to call Customer Service

Please complete this information for future reference:

Model Number: MFC-J480DW

Serial Number: ¹ _____

Date of Purchase: _____

Place of Purchase: _____

¹ The serial number is on the back of the machine. Retain this User's Guide with your sales receipt as a permanent record of your purchase, in the event of theft, fire or warranty service.

Register your product online at

<http://www.brother.com/html/registration>

You Can Use the Following Features

Mobile Connect

Use Brother iPrint&Scan to check the machine status and access various functions from mobile devices.

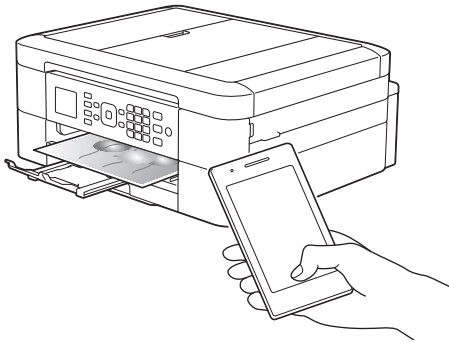

By installing Brother iPrint&Scan on your mobile device and connecting to the machine, you can use the following convenient features:

- **Print**
You can print photos, documents, and web pages from your mobile device. You can also print files from various web services.
- **Scan**
You can scan photos and documents and save them to your mobile device.
- **Copy**
You can use your mobile device to edit scanned images (crop and rotate images), and then print them using the machine.
- **Fax**
You can fax photos and documents that are stored on your mobile device. You can also view faxes, which are received by the machine, on your mobile device.
- **Check the Machine Status**
You can check the remaining ink levels and other information, and view error solutions.

For more information, see the *Mobile Print/Scan Guide for Brother iPrint & Scan*:

solutions.brother.com/manuals



Web Connect / Brother Apps

Scan and upload images and files to popular web services directly from your machine. Capture and convert information directly from your machine without your computer.

For more information, see the *Web Connect Guide*:

solutions.brother.com/manuals

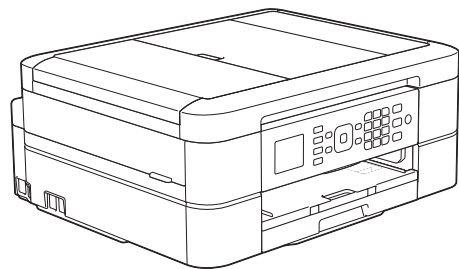

Printing ↑ ↓ Scanning

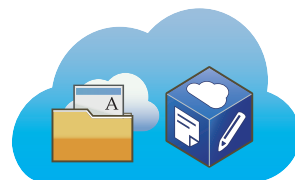

User's Guides and Where to Find Them

Which Guide?	What's in It?	Where Is It?
Product Safety Guide	Read this Guide first. Please read the Safety Instructions before you set up your machine. See this Guide for trademarks and legal limitations.	Printed / In the box
Quick Setup Guide	Follow the instructions for setting up your machine, and installing the drivers and software for the operating system and connection type you are using.	Printed / In the box
Basic User's Guide	Learn the basic PC-Print, Scan, Copy and Fax operations and basic machine maintenance. See troubleshooting tips.	Printed / In the box
Online User's Guide	This guide includes the additional contents of the Basic User's Guide. In addition to information about the PC-Print, Scan, Copy, Fax and Brother ControlCenter operations, useful information is included about using the machine on a network.	HTML and PDF file / Brother Solutions Center ¹
Web Connect Guide	This Guide provides useful information about accessing Internet services from the Brother machine, as well as downloading images, printing data and uploading files directly to Internet services.	PDF file / Brother Solutions Center ¹
AirPrint Guide	This Guide provides information for using AirPrint to print from OS X v10.8.5 or later and your iPhone, iPod touch, iPad, or other iOS device to your Brother machine without installing a printer driver.	PDF file / Brother Solutions Center ¹
Google Cloud Print Guide	This Guide provides details about how to use Google Cloud Print™ services for printing over the Internet.	PDF file / Brother Solutions Center ¹
Mobile Print/Scan Guide for Brother iPrint&Scan	This Guide provides useful information about printing from your mobile device, and scanning from your Brother machine to your mobile device when connected to a Wi-Fi® network.	PDF file / Brother Solutions Center ¹

¹ Visit solutions.brother.com/manuals.

Basic Operations and Where to Find Instructions

The contents of the Basic User's Guide are also included in the Online User's Guide with more details.

Features	Contents	Guide
Setup	Load paper	Basic User's Guide
	Connect the machine to your computer	Quick Setup Guide
	Connect the machine to your mobile device	Quick Setup Guide
Copy	Copy a document	Basic User's Guide
	Various types of copies (2-sided copies, and so on)	Online User's Guide
Print	Print from your computer (Windows®/ Macintosh)	Basic User's Guide
	Print from your mobile device (Brother iPrint&Scan)	Mobile Print/Scan Guide
	Print using the AirPrint function	AirPrint Guide
	Print using the Google Cloud Print function	Google Cloud Print Guide
	Print data downloaded from a cloud service	Web Connect Guide
Fax	Send and receive a fax	Basic User's Guide
	Transfer a fax to your computer	Online User's Guide
	Send and receive a fax using your computer	Basic User's Guide
	Send and view a fax using your mobile device (Brother iPrint&Scan)	Mobile Print/Scan Guide
Scan	Scan from the machine	Basic User's Guide
	Scan from your computer	Basic User's Guide
	Scan from your mobile device (Brother iPrint&Scan)	Mobile Print/Scan Guide
	Save scanned data to a cloud service	Web Connect Guide
Additional information	Error messages	Basic User's Guide
	Troubleshooting	Basic User's Guide
	Specifications	Online User's Guide

The Online User's Guide Helps You Get the Most Out of Your Machine

We hope that you find this guide helpful. To learn more about your machine's features, please take a look at our Online User's Guide. It offers:

Quicker navigation!

- ✓ Search box
- ✓ Navigation index in a separate panel

Comprehensive!

- ✓ Every topic in one guide

Simplified Layout!

- ✓ Provides step-by-step instructions
- ✓ Feature summary at the top of the page



1. Search Box
2. Navigation
3. Summary
4. Step-by-Step

To View Online User's Guides

To view the Online User's Guide and other available guides, visit solutions.brother.com/manuals.

For Windows® users only: you can also access your machine's guides by using Brother Utilities. The Brother Utilities tool is included in the standard installation and, once installed, you can find it either as a shortcut on your desktop, or from the Windows® Start menu.

Questions or Problems? Please take a look at our FAQs, solutions, and videos online.





Go to your model's FAQs & Troubleshooting page on the Brother Solutions Center at

<http://support.brother.com>

- Provides several ways to search!
- Displays related questions for more information
- Receives regular updates based on customer feedback

FAQs & Troubleshooting

Categorized Popular Latest

-  **How To / Troubleshooting**
 - ▶ [Error Messages](#) ▶ [Paper Feed/Paper Jam](#) ▶ [Print](#) ▶ [Scan](#)
 - ▶ [Copy](#) ▶ [Telephone](#) ▶ [Fax](#) ▶ [Mobile](#) ▶ [Cloud](#)
-  **Setup / Settings**
 - ▶ [Product Setup](#) ▶ [Driver/Software](#)
-  **Consumables & Accessories / Routine Maintenance**
 - ▶ [Consumables/Paper/Accessories](#) ▶ [Cleaning](#)
-  **Others**
 - ▶ [Specification](#) ▶ [OS Support Information](#) ▶ [Video FAQs](#)

Search by Keyword(s)

▶ [Search by FAQ ID number](#)

▶

Categorized Popular Latest

Since the Brother Solutions Center is updated regularly, this screenshot is subject to change without notice.

Definitions of Notes

We use the following symbols and conventions throughout this User's Guide:

IMPORTANT

IMPORTANT indicates a potentially hazardous situation which, if not avoided, may result in damage to property or loss of product functionality.

NOTE

NOTE specifies the operating environment, conditions for installation, or special conditions of use.



Tips icons provide helpful hints and supplementary information.

Bold

Bold style identifies buttons on the machine's control panel or computer screen.

Italics

Italicised style emphasises an important point or refers you to a related topic.

[Courier New]

Courier New font identifies messages shown on the machine's LCD.



-
- Most of the illustrations in this User's Guide show the MFC-J480DW.
-

For the Latest Driver Updates

Go to your model's **Downloads** page on the Brother Solutions Center at <http://support.brother.com> to download drivers.

To keep your machine's performance up-to-date, check there for the latest firmware upgrades.

Compilation and Publication Notice

This manual has been compiled and published to provide the latest product safety information at the time of publication. The information contained in this manual may be subject to change.

For the latest manual, visit us at solutions.brother.com/manuals.

Table of Contents

Basic User's Guide

1	General Information	1
	Control Panel Overview	1
	LCD Overview	5
	Access Brother Utilities (Windows®)	6
	Uninstall the Brother Software and Drivers (Windows®)	6
2	Paper Handling	7
	Load Paper	7
	Load paper in the paper tray.....	7
	Change the Check Paper Size Setting	9
	Change the Paper Size and Paper Type	9
	Recommended Print Media	10
	Handle and Use Print Media.....	10
3	Print	11
	Print from Your Computer	11
	Print a Document (Macintosh)	11
	Print a Document (Windows®).....	11
	Print on Both Sides of the Paper Automatically (Automatic 2-sided Printing) (Windows®)	11
	Print More Than One Page on a Single Sheet of Paper (N in 1) (Windows®).....	12
	Print Photos from ControlCenter4 (Windows®)	12
4	Copy	14
	Copy a Document	14
	Copy Settings	15
	Copy Options	15
5	Scan	17
	Scan from Your Computer (Windows®).....	17
	Scan Using ControlCenter4 Home Mode (Windows®)	17
	Scan Using the Scan Button on Your Brother Machine	18
	Scan Using the Scan Button on the Machine	18
6	Fax	20
	Before Faxing	20
	Set Your Station ID	20

Telephone Line Interference/VoIP	20
Receive Modes	20
Choose the Correct Receive Mode.....	22
Set the F/T Ring Time (Pseudo/Double-ring).....	23
Set the Number of Rings Before the Machine Answers (Ring Delay)	23
Store Numbers	24
Store Address Book Numbers	24
Change or Delete Address Book Names or Numbers	24
Telephone Services and External Devices	26
Voice Mail	26
Voice Over Internet Protocol (VoIP).....	26
Connection of an External Telephone Answering Device (TAD).....	26
External and Extension Telephones	26
Fax Using Your Machine	27
Send a Fax	27
Fax Using Your Computer (PC-FAX).....	29
Send Faxes from Your Computer	29
Receive Faxes on Your Computer (Windows® only)	29
A Routine Maintenance	31
Clean the Scanner.....	31
Check the Print Quality.....	31
Check the Print Alignment from Your Brother Machine	33
B Troubleshooting	34
Identify the Problem.....	34
Error and Maintenance Messages.....	36
Transfer Your Faxes or Fax Journal Report.....	40
Troubleshooting for Wireless LAN setup	42
Wireless LAN Report Error Codes	42
Fax and Telephone Problems.....	44
Troubleshooting for Other Fax Problems.....	45
Print or Scan Problems.....	47
Troubleshooting for Other Print Problems	49
Document and Paper Jams	50
Document Jams.....	50
Printer Jam or Paper Jam.....	51
C Appendix	58
Enter Text on Your Brother Machine.....	58
Information for compliance with Commission Regulation 801/2013.....	59
Supply Specifications	60

D Index.....	61
---------------------	----

Control Panel Overview

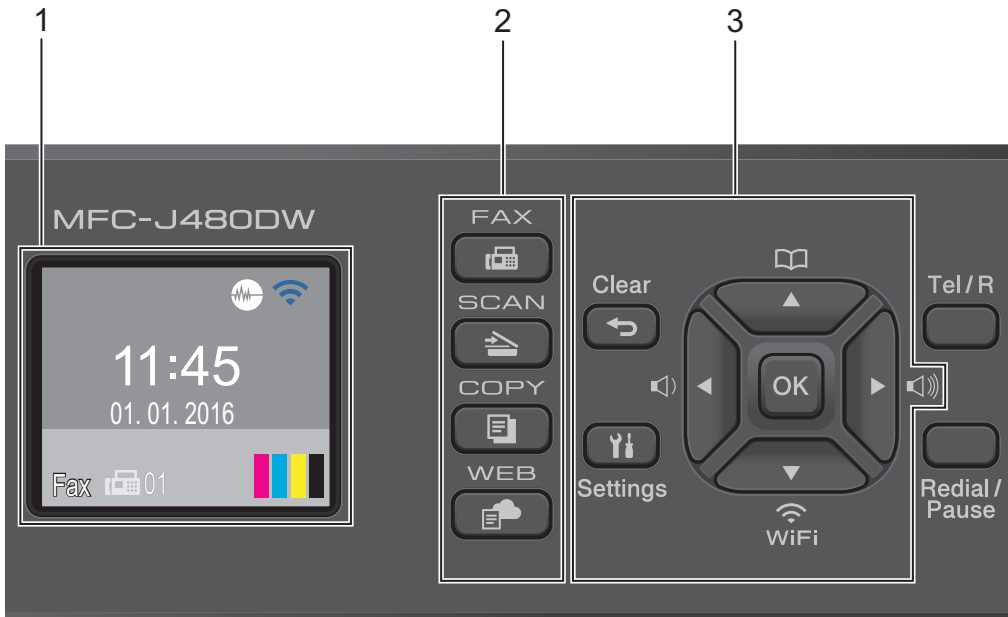

1. 1.8"(44.9 mm) Liquid Crystal Display (LCD)

Displays messages to help you set up and use the machine.

Adjust the angle of the control panel by lifting it.

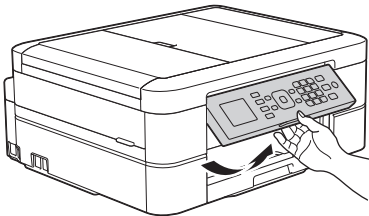

2. Mode buttons



FAX

Press to switch the machine to FAX Mode.



SCAN

Press to switch the machine to SCAN Mode.



COPY

Press to switch the machine to COPY Mode.



WEB

Press to switch the machine to WEB Mode.

3. Settings buttons

Clear

Press to delete characters or to go back to the previous menu level.

Settings

Press to access the main menu.

OK

Press to choose a setting.

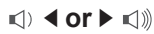

Press to adjust the ring volume while the machine is idle.



- Press to store Speed Dial and Group numbers in the machine's memory.
- Press to look up and dial numbers that are stored in the machine's memory.



Press to configure the wireless settings while the machine is idle.



Press to scroll through the menus and options.



Press to move the cursor left or right on the LCD.

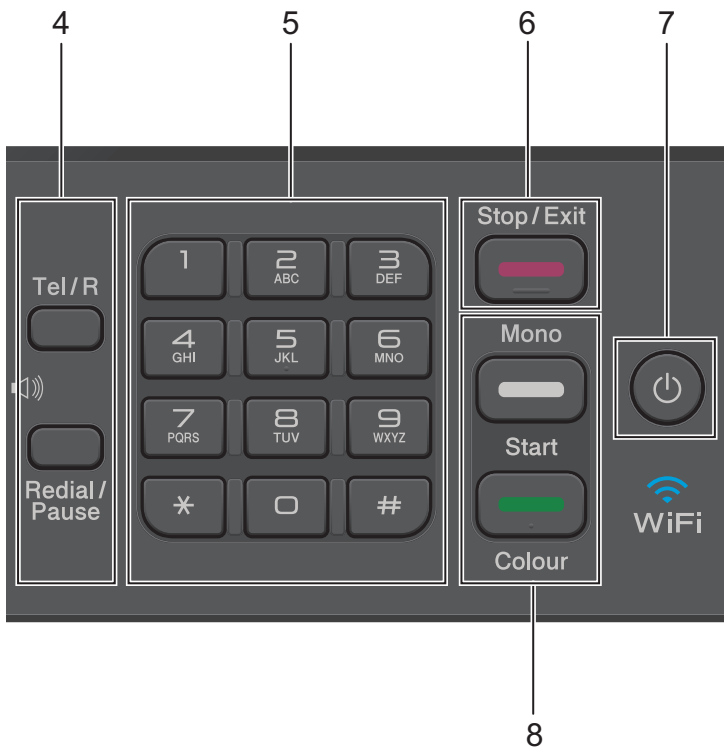

4. Telephone buttons

Tel/R

If the machine is in Fax/Tel (F/T) Mode and you pick up the handset of an external telephone during the F/T ring (pseudo/double-ring), press **Tel/R** to talk.

When connected to a PBX, press to gain access to an outside line or to transfer a call to another extension.

Redial/Pause

- Press to dial the last 30 numbers you called.
- Press to insert a pause when dialling numbers.

5. Dial Pad

- Use to dial fax and telephone numbers.
- Use as a keyboard to enter text or characters.

6. Stop/Exit

- Press to stop an operation.
- Press to exit from a menu.

7. Power On/Off

Press  to turn on the machine.

Press and hold down  to turn off the machine. The LCD will display [Shutting Down] and will stay on for a few seconds before turning itself off. If you have connected an external telephone or TAD, it is always available.

If you turn off the machine using , it will still clean the print head periodically to maintain print quality. To prolong print head life, provide better ink efficiency, and maintain print quality, keep your machine connected to a power source at all times.

8. Start buttons

Mono Start

- Press to start sending faxes in monochrome.
- Press to start making copies in monochrome.
- Press to start scanning documents (in colour or monochrome depending on the scan setting).

Colour Start

- Press to start sending faxes in full colour.
- Press to start making copies in full colour.
- Press to start scanning documents (in colour or monochrome depending on the scan setting).

LCD Overview

This screen shows the machine's status when the machine is idle. This Home screen is also called the Ready Mode screen. When displayed, this indicates that your machine is Ready for the next command.

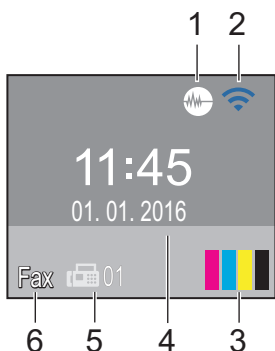



1. Quiet Mode

The  (**Quiet Mode**) icon appears when the [Quiet Mode] setting is set to [On].

The Quiet Mode setting can reduce printing noise. When Quiet Mode is turned on, the print speed becomes slower.

2. Wireless Status

Each icon in the following table shows the wireless network status.

	The wireless setting is disabled.
	Wireless network is connected. A three-level indicator in the LCD displays the current wireless signal strength.
	The wireless access point cannot be detected.



You can configure wireless settings by pressing  on the control panel. For more information, see the *Quick Setup Guide*.

3. Ink

Displays the available ink volume.

When an ink cartridge is near the end of its life or having a problem, an error icon is displayed on the ink colour.

4. Date & Time

Displays the date and time set on the machine.

5. Faxes in memory

Displays how many received faxes are in the machine's memory.





6. Receive Mode

Displays the current Receive Mode.

- [Fax] (Fax Only)
- [F/T] (Fax/Tel)
- [TAD] (External TAD)
- [Mnl] (Manual)

Access Brother Utilities (Windows®)

Brother Utilities is an application launcher that offers convenient access to all Brother applications installed on your computer.

- 1 Do one of the following:
 - (Windows® XP, Windows Vista® and Windows® 7)
Click  (**Start**) > **All Programs** > **Brother** > **Brother Utilities**.
 - (Windows® 8)
Tap or click  (**Brother Utilities**) either on the **Start** screen or the desktop.
 - (Windows® 8.1)
Move your mouse to the lower left corner of the **Start** screen and click  (if you are using a touch-based device, swipe up from the bottom of the **Start** screen to bring up the **Apps** screen).
When the **Apps** screen appears, tap or click  (**Brother Utilities**).

- 2 Select your machine.

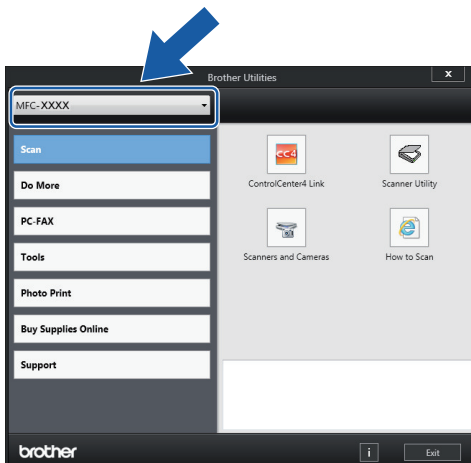

- 3 Choose the operation you want to use.

Uninstall the Brother Software and Drivers (Windows®)

- 1 Launch  (**Brother Utilities**).
- 2 Click the drop-down list, and then select your model name (if not already selected). Click **Tools** in the left navigation bar, and then click **Uninstall**.
Follow the instructions in the dialog box to uninstall the software and drivers.

Load Paper

Load paper in the paper tray

- If the [Check Paper] setting is set to [On] and you pull the paper tray out of the machine, a message appears on the LCD asking if you want to change the paper type and paper size. Change the Paper Size and Paper Type settings if needed, following the on-screen instructions.
- Load only one size and type of paper in the paper tray at a time.
- When you load a different paper size in the tray, you must change the Paper Size setting in the machine or the paper size setting on your computer.

- 1 Pull the paper tray completely out of the machine.

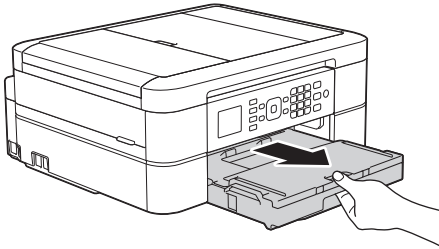

- 2 Open the output paper tray cover (1).

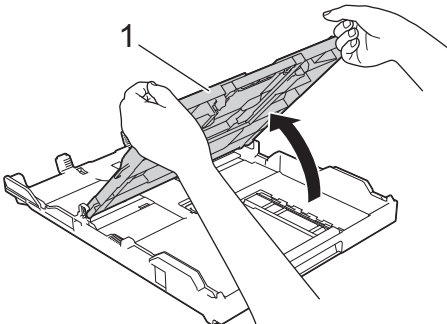

- 3 Gently press and slide the paper width guides (1) and then the paper length guide (2) to fit the paper size.

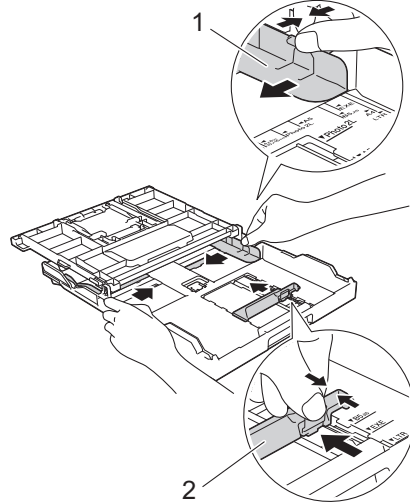

- 4 Fan the stack of paper well.

- 5 Gently load paper in the paper tray with the printing surface **face down**.

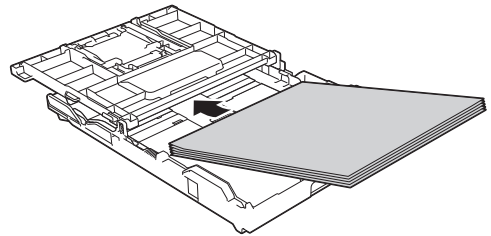

Make sure the paper is flat in the tray and the paper length guide (1) touches the edges of the paper.

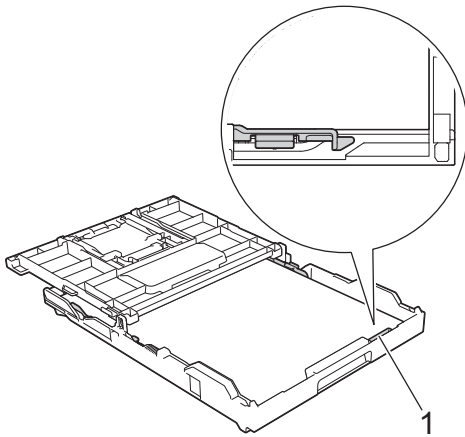

IMPORTANT

- Be careful not to push the paper in too far; it may lift at the back of the tray and cause paper feed problems.
- Loading more than 20 sheets of Photo 2L (13 x 18 cm) paper may cause paper jams.

 To add paper before the tray is empty, remove the paper from the tray and combine it with the paper you are adding. Always fan the stack of paper well to prevent the machine from feeding multiple pages.

6 Gently adjust the paper width guides (1) to fit the paper.

Make sure the paper guides touch the edges of the paper.

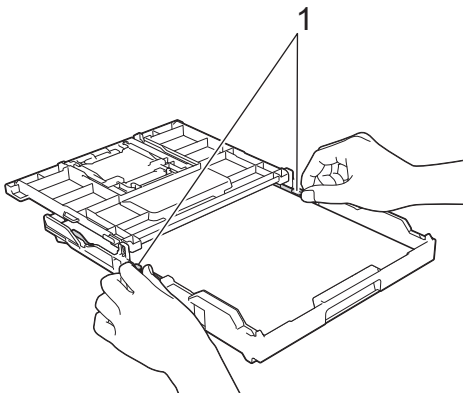

7 Close the output paper tray cover.

Slowly push the paper tray completely into the machine.

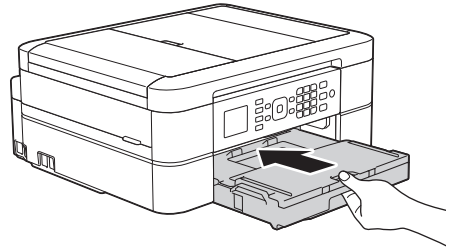

8 While holding the paper tray in the machine, pull out the paper support (1) until it locks into place, and then unfold the paper support flap (2).

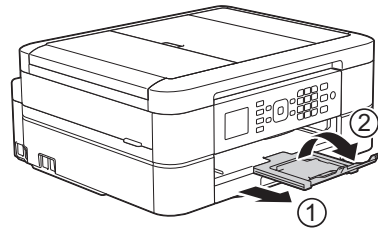

Change the Check Paper Size Setting

If the Check Paper setting is set to [On] and you pull the paper tray out of the machine, the LCD displays a message asking if you want to change the Paper Size and Paper Type settings.

The default setting is [On].

- 1 Press **Settings**.
- 2 Press **▲** or **▼** to select the following:
 - a. Select [General Setup]. Press **OK**.
 - b. Select [Check Paper]. Press **OK**.
 - c. Select [On] or [Off]. Press **OK**.
- 3 Press **Stop/Exit**.

Related Information

- Error and Maintenance Messages on page 36
-

Change the Paper Size and Paper Type

Set the Paper Size and Paper Type settings for the paper tray.

- To get the best print quality, set the machine for the type of paper you are using.
- When you change the size of the paper you load in the tray, you must change the Paper Size setting on the LCD at the same time.

- 1 Press **Settings**.
- 2 Press **▲** or **▼** to select the following:
 - a. Select [General Setup]. Press **OK**.
 - b. Select [Paper Type]. Press **OK**.
 - c. Select [Plain Paper], [Inkjet Paper], [Brother BP71] or [Other Glossy]. Press **OK**.
 - d. Select [Paper Size]. Press **OK**.
 - e. Select the paper size option you want, and then press **OK**.
- 3 Press **Stop/Exit**.



The machine ejects paper with the printed surface face up onto the paper tray at the front of the machine. When you use glossy paper, remove each sheet at once to prevent smudging or paper jams.

Related Information

- Error and Maintenance Messages on page 36
-

Recommended Print Media

For the best print quality, we recommend using the Brother paper listed in the table.

If Brother paper is not available in your country, we recommend testing various paper types before purchasing large quantities.

Brother paper

Paper Type	Item
A4 Plain	BP60PA
A4 Glossy Photo	BP71GA4
A4 Inkjet (Matte)	BP60MA
10 x 15 cm Glossy Photo	BP71GP

Handle and Use Print Media

- Store paper in its original packaging and keep it sealed. Keep the paper flat and away from moisture, direct sunlight and heat.
- Avoid touching the shiny (coated) side of photo paper.

IMPORTANT

DO NOT use the following kinds of paper:

- Damaged, curled, wrinkled, or irregularly shaped

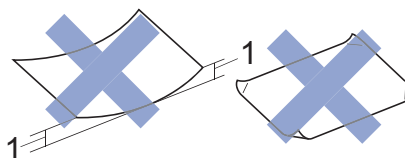

1. **2 mm or greater curl may cause jams to occur.**

- Extremely shiny or highly textured
- Paper that cannot be arranged uniformly when stacked
- Paper made with a short grain

Paper capacity of the output paper tray cover

Up to 50 sheets of A4 80 g/m² paper.

- Photo paper must be picked up from the output paper tray cover one page at a time to avoid smudging.

Print from Your Computer

Print a Document (Macintosh)

For printing instructions, see the *Online User's Guide: Print from Your Computer (Macintosh)*.

Print a Document (Windows®)

- 1 Select the print command in your application.
- 2 Select **Brother MFC-XXXX** (where XXXX is the name of your model).
- 3 Click **Print**.
- 4 Complete your print operation.



For more information, see the *Online User's Guide: Print from Your Computer (Windows®)*.

Print on Both Sides of the Paper Automatically (Automatic 2-sided Printing) (Windows®)

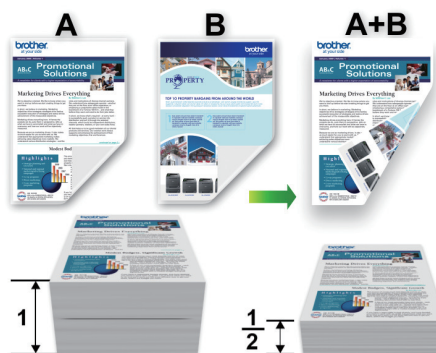

- Make sure the back cover is closed.
- If paper is curled, straighten it and put it back in the paper tray.
- Use regular paper or thin paper. DO NOT use bond paper.
- If the paper is thin, it may wrinkle.

- 1 Select the print command in your application.
- 2 Select **Brother MFC-XXXX** (where XXXX is the name of your model), and then click the printing properties or preferences button.
The printer driver window appears.

- 3 In the **Orientation** field, select either the **Portrait** or **Landscape** option to set the orientation of your printout.

 If your application software contains a similar layout feature, we recommend using the one in the application.

- 4 Click the **2-sided / Booklet** drop-down list, and then select **2-sided**.
- 5 Click the **2-sided Settings** button.
- 6 Select one of the options from the **2-sided Type** menu.
- 7 Select the **Binding Offset** check box if you want to specify the offset for binding in inches or millimetres.
- 8 Click **OK** to return to the printer driver window.
- 9 Change other printer settings if needed.

 The Borderless feature is not available when using this option.

- 10 Click **OK** again, and then complete your print operation.

Print More Than One Page on a Single Sheet of Paper (N in 1) (Windows®)



- 1 Select the print command in your application.
- 2 Select **Brother MFC-XXXX** (where XXXX is the name of your model), and then click the printing properties or preferences button.
The printer driver window appears.
- 3 In the **Orientation** field, select either the **Portrait** or **Landscape** option to set the orientation of your printout.

 If your application software contains a similar layout feature, we recommend using the one in the application.

- 4 Click the **Multiple Page** drop-down list, and then select the **2 in 1**, **4 in 1**, **9 in 1**, or **16 in 1** option.
- 5 Click the **Page Order** drop-down list, and then select your page order.
- 6 Click the **Border Line** drop-down list, and then select your border line type.
- 7 Change other printer settings if needed.
- 8 Click **OK**, and then complete your print operation.

Print Photos from ControlCenter4 (Windows®)

You can print and edit photos using various ControlCenter features.

In the following steps, the ControlCenter Home mode is used as an example.

- 1 Make sure you have loaded the correct media in the paper tray.
- 2 Click the  (**ControlCenter4**) icon in the task tray, and then click **Open**.

3 Click the **Photo** tab.



4 Select the folder that contains the image you want to print.

5 Select images you want to print by clicking the image in the image viewer and selecting the check box under the image.

6 Specify the number of copies you want to print (1-99) by clicking .

7 Click **Print**. The print settings window appears.

8 Configure the settings for the **Paper Size**, **Media Type**, and **Layout** options.

9 Click the **Start Printing** button.

Copy a Document

- 1 Make sure you have loaded the correct size paper in the paper tray.
- 2 Do one of the following:
 - Place the document *face down* on the scanner glass.

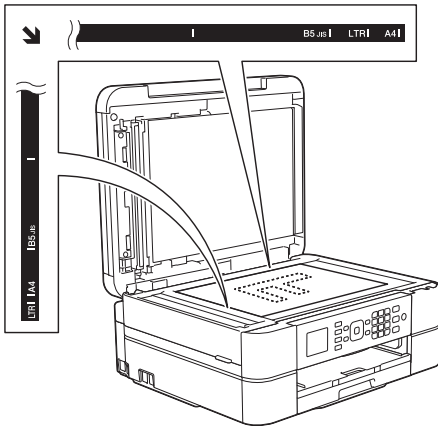

- Place the document *face down* in the ADF.
(If you are copying multiple pages, we recommend using the ADF.)

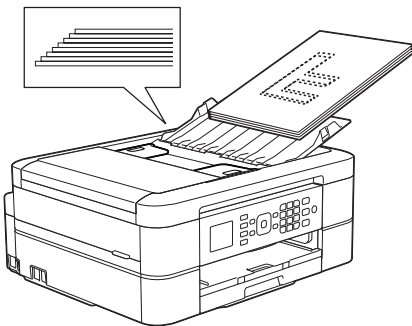

- 3 Press  (COPY).

The LCD displays:

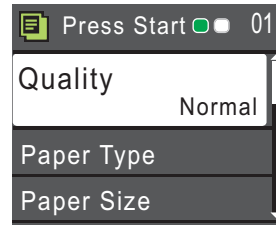

- 4 Enter the number of copies using the dial pad.

- 5 Change the copy settings, if needed.
Press ▲ or ▼ to scroll through the copy settings. When the setting you want is highlighted, press **OK**.



- When you load paper other than A4 size Plain Paper, you must change the [Paper Size] and [Paper Type] settings.

- 6 When finished, press **Mono Start** or **Colour Start**.



To stop copying, press **Stop/Exit**.

Copy Settings

Copy Options

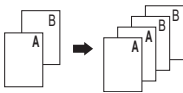
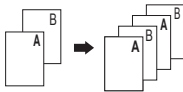
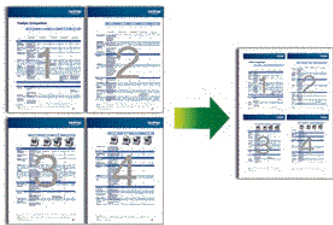
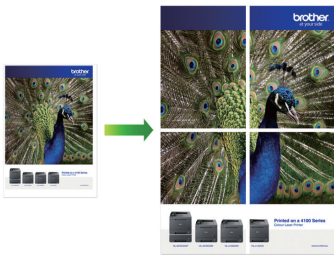
Option	Description	
Quality	Select a copy resolution for your type of document. <ul style="list-style-type: none"> When you select the Normal option, Plain Paper is the only Paper Type option. 	
Paper Type	Select a paper type. If you are copying on special paper, set the machine for the type of paper you are using to get the best print quality.	
Paper Size	Select a paper size. If you are copying on paper other than A4 size, you must change the Paper Size setting.	
Enlarge/Reduce	100%	-
	Enlarge	Select an enlargement ratio for the next copy.
	Reduce	Select a reduction ratio for the next copy.
	Fit to Page	Adjusts the copy size to fit on the paper size you have set.
	Custom (25-400%)	Enter an enlargement or reduction ratio.
Density	Increase the density to make the text darker. Decrease the density to make the text lighter.	
Stack/Sort	Select to stack or sort multiple copies.	
	Stack 	Sort 
Page Layout	Make N in 1, 2 in 1 ID, or Poster copies.	
	4 in 1 	Poster 

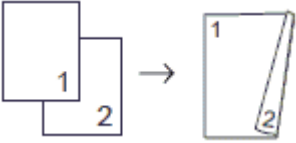
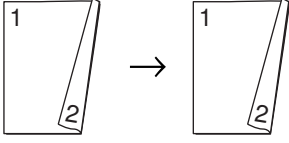
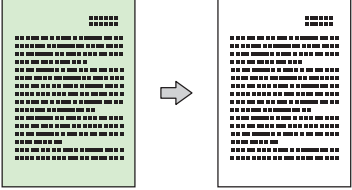
Option	Description
2-sided Copy	<p>Select to copy on both sides of the paper.</p> <div style="display: flex; justify-content: space-around; align-items: center;"> <div style="text-align: center;"> <p>1-sided→2-sided</p>  </div> <div style="text-align: center;"> <p>2-sided→2-sided</p>  </div> </div>
Advanced Settings	<p>Remove Background</p> <p>Removes the document's background colour in copies. The white background becomes more apparent. This saves some ink and may make certain copies easier to read.</p> <div style="text-align: center;">  </div>
Set New Default	<p>Saves the copy settings that you use most often by setting them as the default settings.</p>
Factory Reset	<p>Restores any changed copy settings to the factory settings.</p>

Scan from Your Computer (Windows®)

There are several ways you can use your computer to scan photos and documents on your Brother machine. Use the software applications provided by Brother, or use your favourite scanning application.

Scan Using ControlCenter4 Home Mode (Windows®)

Select **Home Mode** as the mode setting for ControlCenter4.

- 1 Load your document.
- 2 Click the  (**ControlCenter4**) icon in the task tray, and then click **Open**.
- 3 Click the **Scan** tab.
- 4 Select the **Document Type**.
- 5 Change the document's **Scan Size**, if needed.





- 6 Click  (**Scan**).

The machine starts scanning, and the scanned image appears in the image viewer.

- 7 If you scanned multiple pages using the ADF, click the left or right arrow buttons to preview each scanned page.

- 8 Crop the scanned image, if needed.

- 9 Do one of the following:

- Click  (**Save**) to save scanned data.
- Click  (**Print**) to print scanned data.
- Click  (**Open with an Application**) to open scanned data in another application.
- Click  (**Send E-mail**) to attach scanned data to an email.
- Click  (**OCR**) to convert your scanned document to an editable text file.

Scan Using the Scan Button on Your Brother Machine

Scan Using the Scan Button on the Machine

Use the Scan button on the machine to make temporary changes to the scan settings. To make permanent changes, use Brother's ControlCenter software.

1 Do one of the following:

- Place the document *face down* on the scanner glass.

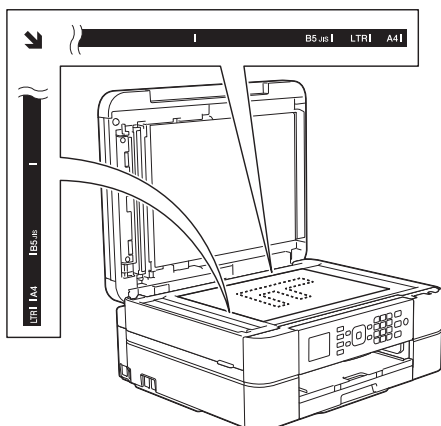

- Place the document *face down* in the ADF.

(If you are scanning multiple pages, we recommend using the ADF.)

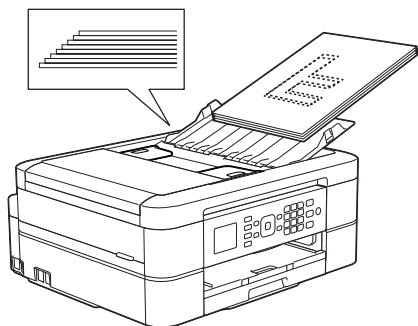

2 Press (SCAN).

3 Press ▲ or ▼ to select the [Scan to File] option, and then press **OK**.

4 If the machine is connected over the network, press ▲ or ▼ to select the computer where you want to send data, and then press **OK**.

 If the LCD prompts you to enter a PIN, use the control panel to enter the four-digit PIN for the computer, and then press **OK**.

5 Do one of the following:

- To change the settings, go to the next step.
- To use the default settings, press **Mono Start** or **Colour Start**.

 [Scan Type] depends on the default settings. Pressing **Mono Start** or **Colour Start** does not allow you to change the settings.

6 Press ▲ or ▼ to select the [Scan Settings] option, and then press **OK**.

 To use the [Scan Settings] option, a computer with the ControlCenter software installed must be connected to the machine.

7 Press ▲ or ▼ to select the [Set at Device] option, and then press **OK**.

8 Select the scan settings you want to change, and then press **OK**.

- [Scan Type]

Select the scan type for your document.

- [Resolution]

Select the scan resolution for your document.

- [File Type]

Select the file format for your document.

- [Scan Size]

Select the scan size for your document.

- [Remove Background]

Change the amount of background colour that is removed.

9 Press **Mono Start** or **Colour Start**.



[Scan Type] depends on the settings you have selected. Pressing **Mono Start** or **Colour Start** does not allow you to change the settings.

Before Faxing

Set Your Station ID

Set the machine's Station ID if you want the date and time to appear on each fax you send.

- 1 Press **Settings**.
- 2 Press **▲** or **▼** to select the following:
 - a. Select [Initial Setup]. Press **OK**.
 - b. Select [Station ID]. Press **OK**.
- 3 Enter your fax number (up to 20 digits) using the dial pad, and then press **OK**.
- 4 Enter your name (up to 20 characters) using the dial pad, and then press **OK**.



For more information about how to enter text, see the *Appendix*.

- 5 Press **Stop/Exit**.

Telephone Line Interference/ VoIP

If you are having problems sending or receiving a fax due to possible interference on the telephone line or if you are using a VoIP system, we recommend changing the modem speed to minimise errors in fax operations.

- 1 Press **Settings**.
- 2 Press **▲** or **▼** to select the following:

- a. Select [Initial Setup]. Press **OK**.
- b. Select [Compatibility]. Press **OK**.
- c. Select [Normal] or [Basic (for VoIP)]. Press **OK**.
 - [Basic (for VoIP)] reduces the modem speed to 9,600 bps and turns off colour fax receiving and ECM, except for colour fax-sending. Unless interference is a recurring problem on your telephone line, you may prefer to use it only when needed.

To improve compatibility with most VoIP services, Brother recommends changing the compatibility setting to [Basic (for VoIP)].
 - [Normal] sets the modem speed at 14,400 bps.

- 3 Press **Stop/Exit**.



- VoIP (Voice over IP) is a type of phone system that uses an Internet connection, rather than a traditional phone line.

Related Information

- Error and Maintenance Messages on page 36
- Fax and Telephone Problems on page 44

Receive Modes

Some receive modes answer automatically ([Fax Only] and [Fax/Tel]). You may want to change the Ring Delay before using these modes.

Fax Only

[Fax Only] mode automatically will answer every call as a fax.

Fax/Tel

[Fax/Tel] mode helps you manage incoming calls, by recognising whether they are fax or voice calls and handling them in one of the following ways:

- Faxes will be received automatically.
- Voice calls will start the F/T ring to tell you to pick up the line. The F/T ring is a pseudo/double-ring made by your machine.

Manual

[Manual] mode turns off all automatic answering functions (unless you are using the BT Call Sign feature).

To receive a fax in [Manual] mode, lift the handset of the external telephone. When you hear fax tones (short repeating beeps), press the Start button, and then select [Receive] to receive a fax. You can also use the Fax Detect feature to receive faxes by lifting a handset on the same line as the machine.

External TAD

[External TAD] mode lets an external answering device manage your incoming calls.

Incoming calls will be handled in the following ways:

- Faxes will be received automatically.
- Voice callers can record a message on the external TAD.

Related Information

- Fax and Telephone Problems on page 44
-

Choose the Correct Receive Mode

You must choose a Receive Mode depending on the external devices and telephone services you have on your line.

By default, your machine automatically will receive any faxes that are sent to it. The diagram below will help you select the correct mode.

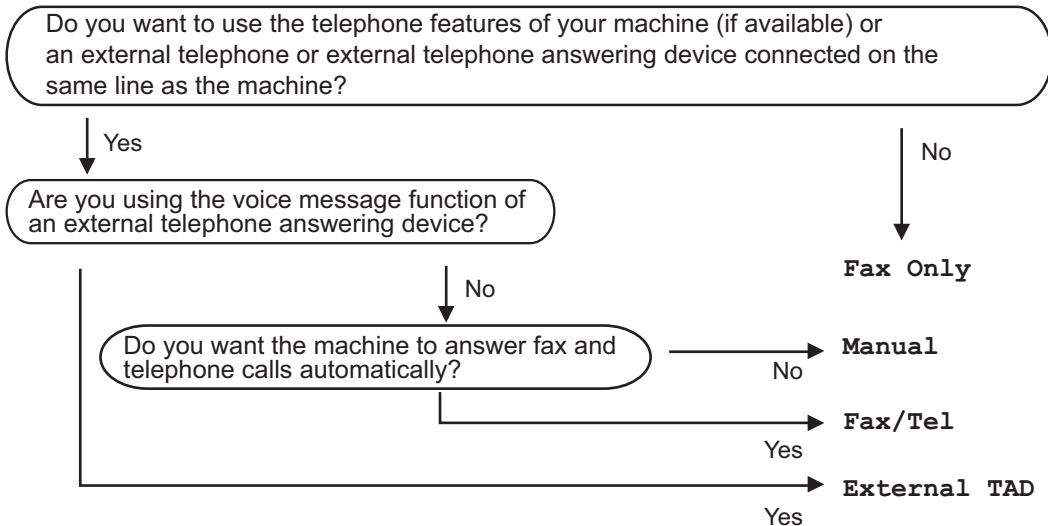

1 Press **Settings**.

2 Press **▲** or **▼** to select the following:

- Select [Fax]. Press **OK**.
- Select [Setup Receive]. Press **OK**.
- Select [Receive Mode]. Press **OK**.



If the option to change the Receive Mode is unavailable, make sure the BT Call Sign feature is set to [Off].

3 Press **▲** or **▼** to select the [Fax Only], [Fax/Tel], [External TAD], or [Manual] option, and then press **OK**.

4 Press **Stop/Exit**.

Related Information

- Fax and Telephone Problems on page 44
- Troubleshooting for Other Fax Problems on page 45

Set the F/T Ring Time (Pseudo/Double-ring)

When you set the Receive Mode to [Fax/Tel], if the call is a fax, your machine will receive it automatically. However, if it is a voice call, the machine will sound the F/T ring (pseudo/double-ring) for the time you set in the F/T Ring Time option. When you hear the F/T ring, it means that a voice caller is on the line.

Because the F/T ring is a setting only on your Brother machine, extension and external telephones will not ring; however, you can still answer the machine's call on any telephone.

- 1 Press **Settings**.
- 2 Press **▲** or **▼** to select the following:
 - a. Select [Fax]. Press **OK**.
 - b. Select [Setup Receive]. Press **OK**.
 - c. Select [F/T Ring Time]. Press **OK**.
 - d. Select how long the machine will double-ring to alert you to a voice call. Press **OK**.

- 3 Press **Stop/Exit**.



Even if the caller hangs up during the pseudo/double-ringing, the machine will continue to ring for the set time.

Set the Number of Rings Before the Machine Answers (Ring Delay)

When somebody calls your machine, you will hear the normal telephone ring sound. The number of rings is set in the Ring Delay option.

- The Ring Delay setting sets the number of times the machine rings before it answers in [Fax Only] and [Fax/Tel] modes.
- If you have external or extension telephones on the same line as the machine, select the maximum number of rings.

- 1 Press **Settings**.
- 2 Press **▲** or **▼** to select the following:
 - a. Select [Fax]. Press **OK**.
 - b. Select [Setup Receive]. Press **OK**.
 - c. Select [Ring Delay]. Press **OK**.
 - d. Select the number of times you want the line to ring before the machine answers. Press **OK**.



-
- If you select [0], the machine will answer immediately and the line will not ring at all (available only for some countries).
-

- 3 Press **Stop/Exit**.

Store Numbers





You can set up your machine to store fax numbers in the Address Book.





If you lose electrical power, the Address Book numbers that are in the machine's memory will not be lost.

Store Address Book Numbers

You can store up to 40 two-digit Speed Dial codes, and each code has a name.

- 1 Press  (Address Book).
- 2 Press  or  to select [Set Speed Dial] and then press **OK**.
- 3 Do the following steps:
 - a. Press  or  to select the two-digit Speed Dial code where you want to store the number. Press **OK**.
 - b. Enter the name (up to 16 characters) using the dial pad. Press **OK**.
 - c. Enter the fax or telephone number (up to 20 digits). Press **OK**.







- Press **Redial/Pause** to insert a pause between numbers. You can press **Redial/Pause** as many times as needed to increase the length of the pause.
 - Be sure to include the area code when entering a fax or telephone number. Depending on the country, the Caller ID names and history may not be displayed correctly if the area code is not registered with the fax or telephone number.
- d. Press  or  to select [Complete] and then press **OK**.

To store another Speed Dial code, repeat these steps.

- 4 Press **Stop/Exit**.





Change or Delete Address Book Names or Numbers

You can change or delete an Address Book name or number that has already been stored.

- 1 Press  (Address Book).
- 2 Press  or  to select [Set Speed Dial] and then press **OK**.
- 3 Press  or  to select the following:
 - a. Select the two-digit Speed Dial code where you want to change the number. Press **OK**.
 - b. Select [Change]. Press **OK**.







To delete the number, select [Delete] and then press **OK**. Press **1** [Yes] to confirm.

- 4 Do one of the following:
 - To change the name, press  or  to select [Name] and then press **OK**. Enter the name (up to 16 characters) using the dial pad. Press **OK**.
 - To change the fax or telephone number, press  or  to select [Fax/Tel], and then press **OK**. Enter the fax or telephone number (up to 20 digits). Press **OK**.



How to change the stored name or number:

To change a character, press  or  to position the cursor to under the character you want to change, and then press **Clear**. Enter the new character.

- 5 Press  or  to select [Complete] and then press **OK** to finish.

6 Press **Stop/Exit**.



Telephone Services and External Devices

You may be able to use the following services and connections with your Brother machine.



These are summaries of ways to connect your machine. For more information about each topic, see the *Online User's Guide*.

Voice Mail

If you have a Voice Mail service on the telephone line that your Brother machine is connected to, it may conflict with your Brother machine when receiving incoming faxes. If using this service, we suggest setting the Brother machine's Receive Mode to Manual.

Voice Over Internet Protocol (VoIP)

VoIP is a type of phone system that uses an Internet connection instead of a traditional telephone line. Your machine may not work with some VoIP systems. If you have questions about how to connect your machine to a VoIP system, contact your VoIP provider.

Connection of an External Telephone Answering Device (TAD)

You may choose to connect an external answering device to your Brother machine. To receive faxes successfully, you must connect it correctly. When recording an outgoing message on your external TAD, we recommend recording 5 seconds of silence at the beginning of your message, and limiting your speaking to 20 seconds. Set your machine's Receive Mode to External TAD.

External and Extension Telephones

You can connect a separate telephone to your machine. If you answer a fax call on an extension or external telephone, you can make your machine receive the fax by pressing * 5 1. If the machine answers a voice call and pseudo/double-rings for you to take over, press # 5 1 to take the call on an extension telephone.

Fax Using Your Machine

Send a Fax

1 Load your document in the ADF or on the scanner glass.

2 Press  (FAX).

The LCD displays:

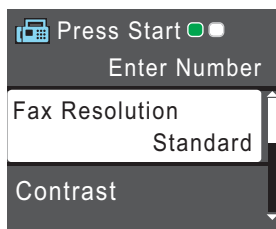

3 Enter the fax number in one of the following ways:

- Dial Pad (Enter the fax number manually.)

Press all digits of the number using the dial pad.

- **Redial/Pause** (Redial the last number you dialled.)
- [Outgoing Call] (Select a number from the Outgoing Call history.)

Press ▲ or ▼ to select the following:

- a. Select [Outgoing Call]. Press **OK**.
 - b. Select the number you want, and then press **OK**.
 - c. Select [Send a fax]. Press **OK**.
- [Caller ID hist.] (Select a number from the Caller ID history.)
- Press ▲ or ▼ to select the following:
- a. Select [Caller ID hist.]. Press **OK**.
 - b. Select the number you want, and then press **OK**.

c. Select [Send a fax]. Press **OK**.

- [Address Book] (Select a number from the Address Book.)

Press ▲ or ▼ to select the following:

- a. Select [Address Book]. Press **OK**.
- b. Select [Search]. Press **OK**.
- c. Do one of the following:
 - Enter the two-digit Speed Dial code using the dial pad.
 - Select a number from the list in the following ways:
 - i. Select [Alphabetical Order] or [Numerical Order]. Press **OK**.
 - ii. Select the number you want. Press **OK**.
 - iii. Select [Send a fax]. Press **OK**.

4 If you want to change the fax settings, press ▲ or ▼ to select the setting you want to change, and then press **OK**.

5 When finished, press **Mono Start** or **Colour Start**.

- 6** Do one of the following:
- If you are using the ADF, the machine starts scanning and sending the document.
 - If you are using the scanner glass and pressed **Mono Start**, the machine starts scanning the first page.
Go to the next step.
 - If you are using the scanner glass and pressed **Colour Start**, the LCD asks if you want to send a colour fax.
Press **1** to confirm. The machine starts dialling and sending the document.

- 7** When the LCD displays [Next Page?], do one of the following:
- Press **1** to scan another page. Place the next page on the scanner glass, and then press **OK**. The machine starts scanning the page.
 - Press **2** to send a fax (or press **Mono Start** again) when finished scanning pages. The machine starts sending the document.

Repeat this step for each additional page.

Fax Using Your Computer (PC-FAX)

Send Faxes from Your Computer

The Brother PC-FAX feature lets you send a file, created in any application on your computer, as a standard fax and even attach a cover page.

For Windows®:

For more information, see the *Online User's Guide: PC-FAX for Windows®*.

For Macintosh:

For more information, see the *Online User's Guide: PC-FAX for Macintosh*.

- 1 From your application select **File**, and then **Print**.

(The steps may vary depending on your application.)

The Print dialog box appears.

- 2 Select **Brother PC-FAX**.

- 3 Click **Print**.

The **Brother PC-FAX** user interface appears.

- 4 Enter the recipient's fax number.

- a. Use your computer keyboard or click the **Brother PC-FAX** user interface's numeric keypad.
- b. Click **Add Send Address**.



You can also select a stored number from the **Address Book**.

- 5 Click **Start**.

Your document is sent to the Brother machine and then faxed to the recipient.

Contact the application's vendor if you need more support.

Receive Faxes on Your Computer (Windows® only)

Use Brother's PC-FAX software to receive faxes on your computer, screen them, and print only those faxes you want.



- Even if you turn off your computer (at night or on the weekend, for example), your machine will receive and store your faxes in its memory. The number of received faxes that are stored in the memory appears on the LCD.
- When you start your computer and the PC-Fax Receive software runs, your MFC transfers your faxes to your computer automatically.
- For PC-Fax Receive to work, the PC-FAX Receive software must be running on your computer.
- Before you can set up PC-Fax Receive, you must install the Brother software and drivers on your computer. Make sure your Brother machine is connected to your computer and turned on.
- If your machine displays an error and is unable to print faxes from memory, use PC-FAX to transfer your faxes to a computer.
- *PC-Fax Receive is not available for Macintosh.*

- 1** Do one of the following:
- (Windows® XP, Windows Vista® and Windows® 7)

Click **Start > All Programs > Brother > Brother Utilities > PC-FAX > Receive**.

- (Windows® 8)

Click  (**Brother Utilities**), and then click the drop-down list and select your model name (if not already selected).

Click **PC-FAX** in the left navigation bar, and then click **Receive**.

- 2** Confirm the message and click **Yes**.
The **PC-FAX Receive** window appears.
The  (**PC-FAX Receive**) icon also appears in your computer task tray.

Clean the Scanner

- 1 Unplug the machine from the electrical socket.
- 2 Lift the document cover (1). Clean the scanner glass (2) and the white plastic (3) with a soft lint-free cloth moistened with a non-flammable glass cleaner.

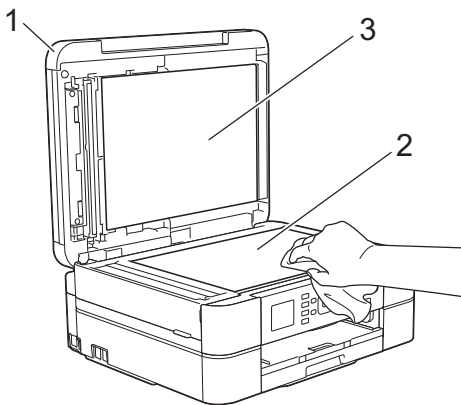

- 3 In the ADF unit, clean the white bar (1) and the glass strip (2) with a lint-free cloth moistened with a non-flammable glass cleaner. (ADF models only)

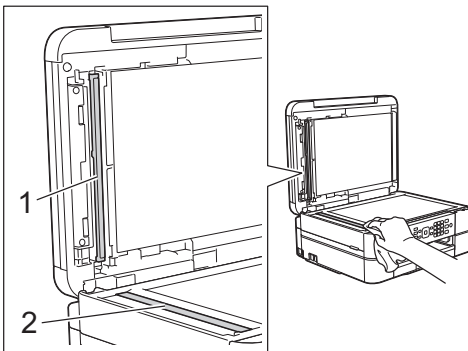

Related Information

- Troubleshooting for Other Fax Problems on page 45
- Troubleshooting for Other Print Problems on page 49

Check the Print Quality

If faded or streaked colours and text appear or if text is missing on your printouts, the print head nozzles may be clogged. Print the Print Quality Check Sheet and look at the nozzle check pattern.

- 1 Press **Settings**.
- 2 Press **▲** or **▼** to select the following:
 - a. Select [Ink/Maintenance]. Press **OK**.
 - b. Select [Impr. PrintQuality]. Press **OK**.
 - c. Select [Impr. PrintQuality] again. Press **OK**.
- 3 Press **Colour Start**.
The machine prints the Print Quality Check Sheet.
- 4 Check the quality of the four colour blocks on the sheet.
- 5 The LCD asks about the print quality. Do one of the following:
 - If all lines are clear and visible, press **▶** to select [No], and then press **OK**. Press **Stop/Exit** to finish the Print Quality check.
 - If lines are missing (see **Poor**, below), press **◀** to select [Yes], and then press **OK**.

OK

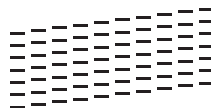

Poor

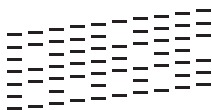

- 6 The LCD asks you to check the print quality of each colour. Press ◀ or ▶ to select the pattern (1–4) that most closely matches the printing result, and then press **OK**.
- 7 Do one of the following:
 - If print head cleaning is needed, press **OK** to start the cleaning procedure.
 - If print head cleaning is not needed, the Maintenance screen reappears on the LCD. Press **Stop/Exit** to finish the Print Quality check.

- 8 After the cleaning procedure is finished, the LCD asks if you want to check the print quality again.

Press **1** [Yes] to start the print quality check, and then press **Colour Start**.

The machine prints the Print Quality Check Sheet again. Check the quality of the four colour blocks on the sheet again.

If you clean the print head and the print has not improved, try installing a new Genuine Brother Brand replacement ink cartridge for each problem colour. Try cleaning the print head again. If the print has not improved, contact Brother customer service or your local Brother dealer.

IMPORTANT

DO NOT touch the print head. Touching the print head may cause permanent damage and may void the print head's warranty.



When a print head nozzle is clogged, the printed sample looks like this.



After the print head nozzle is cleaned, the horizontal lines are gone.



Related Information

- Troubleshooting for Other Print Problems on page 49

Check the Print Alignment from Your Brother Machine

If your printed text becomes blurred or images become faded after transporting the machine, adjust the print alignment.

- 1 Press **Settings**.
- 2 Press **▲** or **▼** to select the following:
 - a. Select [Ink/Maintenance]. Press **OK**.
 - b. Select [Impr. PrintQuality]. Press **OK**.
 - c. Select [Alignment]. Press **OK**.
- 3 Press **OK**.
- 4 Press **Mono Start** or **Colour Start**.
The machine starts printing the Alignment Check Sheet.

(A)

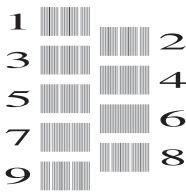

- 5 For the (A) pattern, press **◀** or **▶** to select the number of the test print that has the fewest visible vertical stripes (1-9), and then press **OK**.
In the example above, row number 6 is the best choice.
Repeat this step for the rest of the patterns.



When the print alignment is not adjusted correctly, text looks blurry or crooked, like this.

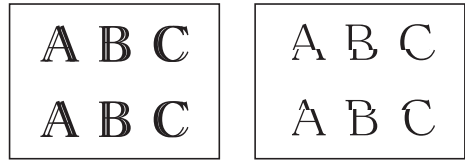

After the print alignment is adjusted correctly, text looks like this.



- 6 Press **Stop/Exit**.

Related Information

- Troubleshooting for Other Print Problems on page 49







Use this section to resolve problems you may encounter when using your Brother machine.

Identify the Problem

Even if there seems to be a problem with your machine, you can correct most problems yourself.

First, check the following:

- The machine's power cord is connected correctly and the machine's power is on.
- All of the machine's orange protective parts have been removed.
- The ink cartridges are installed correctly.
- The Scanner Cover and the Jam Clear Cover are fully closed.
- Paper is inserted correctly in the paper tray.
- The interface cables are securely connected to the machine and the computer, or the wireless connection is set up on both the machine and your computer.
- (For network models) The access point (for wireless), router, or hub is turned on and its link button is blinking.
- Check the LCD or the machine's status in **Status Monitor** on your computer.

Find the Error	Find the Solution
<p>Using the Status Monitor</p>  <ul style="list-style-type: none"> • Double-click the  icon in the task tray. • (Windows®) If you check Load Status Monitor on Startup, the Status Monitor will launch automatically each time you start your computer. 	<p>Find the Solution</p> <ul style="list-style-type: none"> • A green icon indicates the normal stand-by condition.  • A yellow icon indicates a warning.  • A red icon indicates an error has occurred.  • A grey icon indicates the machine is offline.  • Click the Troubleshooting button to access Brother's troubleshooting website.

Find the Error	Find the Solution
Using the LCD	<ol style="list-style-type: none"><li data-bbox="710 170 1256 202">1. Follow the messages on the LCD.<li data-bbox="710 214 1256 276">2. See the instructions in the following Error and Maintenance Messages table.<li data-bbox="710 287 1256 459">3. If you cannot resolve the error, please refer to the <i>Online User's Guide: Error and Maintenance Messages</i> or see FAQs on the Brother Solutions Center at http://support.brother.com

Error and Maintenance Messages

The most common error and maintenance messages are shown in the table. To see more detailed information, read the *Online User's Guide*.

You can correct most errors and perform routine maintenance yourself. If you need more tips, go to your model's **FAQs & Troubleshooting** page on the Brother Solutions Center at <http://support.brother.com>.

Error Message	Action
Absorber NearFull	The ink absorber box or flushing box must be replaced soon. Contact Brother customer service or your local Brother dealer.
B&W Print Only Replace Ink	<p>One or more of the colour ink cartridges have reached the end of their lives.</p> <p>Replace the ink cartridges.</p> <p>For more information, see the <i>Online User's Guide: Replace the Ink Cartridges</i>.</p> <p>The machine will stop all print operations and you will not be able to use the machine until you change to a new ink cartridge in the following cases:</p> <ul style="list-style-type: none"> • If you unplug the machine or take out the ink cartridge. • (Windows®) If you select Slow Drying Paper in the Basic tab of the printer driver. <p>(Macintosh) If you select Slow Drying Paper in the Print Settings drop-down list of the printer driver.</p>
BT Call Sign On (U.K. only)	<p>BT Call Sign is set to On. You cannot change the Receive Mode from Manual to another mode.</p> <p>Set BT Call Sign to Off.</p> <p>For more information, see the <i>Online User's Guide: Enable the Machine to Work with BT Call Sign (with Your External Telephone only)</i>.</p>
Cannot Detect	Take out the new ink cartridge and reinstall it slowly and firmly until it latches.
	For more information, see the <i>Online User's Guide: Replace the Ink Cartridges</i> .
	Remove the used ink cartridge and install a new one.
	Replace the cartridge with a Brother Original ink cartridge. If the error message remains, contact Brother customer service or your local Brother dealer.
	Slowly turn the ink cartridge so that the ink supply port is pointing downward, and then reinstall the cartridge.
<p>Check the model numbers of the ink cartridges and install the correct ink cartridges.</p> <p>See <i>Related Information: Supply Specifications</i> at the end of this section.</p>	

Error Message	Action
Cannot Detect Ink	Replace the cartridge with a Brother Original ink cartridge. If the error message remains, contact Brother customer service or your local Brother dealer.
Cannot Print Replace Ink	<p>One or more of the ink cartridges have reached the end of their lives. Replace the ink cartridges.</p> <p>For more information, see the <i>Online User's Guide: Replace the Ink Cartridges</i>.</p> <ul style="list-style-type: none"> • You can still scan even if the ink is low or needs to be replaced.
Data Remaining	Press Stop/Exit . The machine will cancel the job and clear it from the memory. Try to print again.
Disconnected	<p>Try to send or receive again.</p> <p>If calls are stopped repeatedly and you are using a VoIP (Voice over IP) system, try changing the Compatibility to Basic (for VoIP).</p> <p>See <i>Related Information: Telephone Line Interference/VoIP</i> at the end of this section.</p>
Document Jam	<p>The document was not inserted or fed correctly, or the document scanned from the ADF was too long.</p> <p>See <i>Related Information: Document Jams</i> at the end of this section.</p>
High Temperature	After cooling the room, allow the machine to cool down to room temperature. Try again when the machine has cooled down.
Ink Absorber Full	<p>The ink absorber box or flushing box must be replaced. Contact Brother customer service or your local Brother Authorised Service Centre to have your machine serviced.</p> <p>Reasons for cleaning are:</p> <ol style="list-style-type: none"> 1. The machine automatically cleans itself after you remove the power cord and plug it back in. 2. After a paper jam has been cleared, the machine automatically cleans itself before the next received page is printed. 3. The machine automatically cleans itself after sitting idle for more than 30 days (infrequent use). 4. The machine automatically cleans itself after ink cartridges of the same colour have been replaced 12 times.
Ink Low	<p>One or more of the ink cartridges are near the end of their lives. Order a new ink cartridge. You can continue printing until the LCD displays <code>Cannot Print</code>.</p> <p>For more information, see the <i>Online User's Guide: Replace the Ink Cartridges</i>.</p> <ul style="list-style-type: none"> • You can still scan even if the ink is low or needs to be replaced.

Error Message	Action
Jam A Inside/ Front Repeat Jam A	<p>Remove the jammed paper.</p> <p>See <i>Related Information: Printer Jam or Paper Jam</i> at the end of this section.</p> <hr/> <p>Make sure the paper length guide is set to the correct paper size.</p>
Jam B Front Repeat Jam B	<p>Remove the jammed paper.</p> <p>See <i>Related Information: Printer Jam or Paper Jam</i> at the end of this section.</p> <hr/> <p>Make sure the paper length guide is set to the correct paper size.</p>
Jam C Rear	<p>Remove the jammed paper.</p> <p>See <i>Related Information: Printer Jam or Paper Jam</i> at the end of this section.</p> <hr/> <p>Make sure the paper length guide is set to the correct paper size.</p> <hr/> <p>Clean the paper pick-up rollers.</p> <p>For more information, see the <i>Online User's Guide: Clean the Paper Pick-up Rollers</i>.</p>
Low Temperature	<p>After warming the room, allow the machine to warm up to room temperature. Try again when the machine has warmed up.</p>
No Caller ID	<p>There is no incoming call history. You did not receive calls or you have not subscribed to the Caller ID service from your telephone company.</p> <p>If you want to use the Caller ID feature, contact your telephone company.</p> <p>For more information, see the <i>Online User's Guide: Caller ID</i>.</p>
No Ink Cartridge	<p>Take out the new ink cartridge and re-install it slowly and firmly until it latches.</p> <p>For more information, see the <i>Online User's Guide: Replace the Ink Cartridges</i>.</p>
No Paper Fed	<p>Do one of the following:</p> <ul style="list-style-type: none"> • Refill the paper tray, and then press Mono Start or Colour Start. • Remove and reload the paper, and then press Mono Start or Colour Start. <hr/> <p>The Jam Clear Cover is not closed correctly.</p>
No Paper Fed Again	<p>Clean the paper pick-up rollers.</p> <p>For more information, see the <i>Online User's Guide: Clean the Paper Pick-up Rollers</i>.</p>
Not Registered	<p>You tried to access a Speed Dial number that has not been stored in the machine.</p> <p>Set up the Speed Dial number.</p>

Error Message	Action
Out of Fax Memory	<p>Do one of the following:</p> <ul style="list-style-type: none"> • Clear the data from the memory. To gain extra memory, you can turn off Memory Receive. For more information, see the <i>Online User's Guide: Turn Off Memory Receive</i>. • Print the faxes that are in the memory. For more information, see the <i>Online User's Guide: Print a Fax Stored in the Machine's Memory</i>.
Out of Memory	<p>If a fax-sending or copy operation is in progress:</p> <ul style="list-style-type: none"> • Press Stop/Exit and wait until the other operations that are in progress finish, and then try again. • Press Mono Start or Colour Start to select <code>Send Now</code> to send the pages scanned so far. • Press Mono Start or Colour Start to select <code>Partial Print</code> to copy the pages scanned so far. • Clear the data in the memory. To gain extra memory, you can turn off Memory Receive. For more information, see the <i>Online User's Guide: Turn Off Memory Receive</i>. • Print the faxes that are in the memory. For more information, see the <i>Online User's Guide: Print a Fax Stored in the Machine's Memory</i>.
Paper Size Mismatch	<ol style="list-style-type: none"> 1. Check that the paper size you chose on the machine's display matches the size of the paper in the tray. See <i>Related Information: Change the Paper Size and Paper Type</i> at the end of this section. 2. Make sure you loaded the paper in a Portrait position, by setting the paper guides at the indicators for your paper size. 3. After you have checked the paper size and the paper position, follow the on-screen instructions. <p>If you are printing from your computer, make sure the paper size you chose in the printer driver matches the size of paper in the tray. For more information, see the <i>Online User's Guide: Print Settings (Windows®)</i> or <i>Print Options (Macintosh)</i>.</p>
Tray not detected	<p>Slowly push the paper tray completely into the machine.</p> <p>Paper or a foreign object has prevented the paper tray from being inserted properly.</p> <p>Pull the paper tray out of the machine, and remove the jammed paper or foreign object. If you cannot find or remove the jammed paper, see <i>Related Information: Printer Jam or Paper Jam</i> at the end of this section.</p>

Error Message	Action
Tray Removed	<p>This message is displayed when the setting to confirm the paper type and size is enabled.</p> <p>To not display this confirmation message, change the setting to Off.</p> <p>See <i>Related Information: Change the Check Paper Size Setting</i> at the end of this section.</p>
Unable to Clean XX Unable to Init. XX Unable to Print XX	<p>A foreign object, such as a paper clip or a piece of ripped paper, is in the machine.</p> <p>Open the scanner cover and remove any foreign objects and paper scraps from inside the machine.</p> <p>If the error message continues:</p> <ul style="list-style-type: none"> • Transfer your faxes to another fax machine or your computer before disconnecting the machine so you will not lose any important messages. Then, disconnect the machine from the power for several minutes and reconnect it. <p>For more information, see the <i>Online User's Guide: Transfer Your Faxes or Fax Journal Report</i>.</p>
Unable to Scan XX	<ul style="list-style-type: none"> • Transfer your faxes to another fax machine or your computer before disconnecting the machine so you will not lose any important messages. Then, disconnect the machine from the power for several minutes and reconnect it. <p>For more information, see the <i>Online User's Guide: Transfer Your Faxes or Fax Journal Report</i>.</p>
Wrong Ink Cartridge	<p>The ink cartridge model number is not compatible with your machine.</p> <p>Verify the cartridge model number will work with your machine.</p> <p>See <i>Related Information: Supply Specifications</i> at the end of this section.</p>
Wrong Ink Colour	<p>Check which ink cartridges are not matched by colour to their ink cartridge positions and move them to their correct positions.</p>

Related Information

- Change the Check Paper Size Setting on page 9
- Change the Paper Size and Paper Type on page 9
- Telephone Line Interference/VoIP on page 20
- Document Jams on page 50
- Printer Jam or Paper Jam on page 51
- Supply Specifications on page 60

Transfer Your Faxes or Fax Journal Report

If the LCD shows:

- [Unable to Clean XX]
- [Unable to Init. XX]

- [Unable to Print XX]
- [Unable to Scan XX]

We recommend transferring your faxes to another fax machine or to your computer.

You can also transfer the Fax Journal report to see if there are any faxes you must transfer.

For more information, see the *Online User's Guide: Transfer Your Faxes or Fax Journal Report*.

Troubleshooting for Wireless LAN setup

Wireless LAN Report Error Codes

If the Wireless LAN Report shows that the connection failed, check the error code on the printed report and see the corresponding instructions in the table:

Error Code	Problem and Recommended Solutions
TS-01	The wireless setting is not activated, change the wireless setting to ON.
TS-02	<p>The wireless access point/router cannot be detected.</p> <ol style="list-style-type: none">1. Check the following two points:<ul style="list-style-type: none">• Unplug the power to your wireless access point/router, wait for 10 seconds, and then plug it back in.• If your WLAN access point/router is using MAC address filtering, confirm that the MAC address of the Brother machine is allowed in the filter.2. If you manually entered the SSID and security information (SSID/authentication method/encryption method/Network Key), the information may be incorrect. Reconfirm the SSID and security information and re-enter the correct information if needed.
TS-04	<p>The Authentication/Encryption methods used by the selected wireless access point/router are not supported by your machine.</p> <p>For infrastructure mode, change the authentication and encryption methods of the wireless access point/router. Your machine supports the following authentication methods:</p> <ul style="list-style-type: none">• WPA-Personal TKIP or AES• WPA2-Personal AES• Open WEP or None (without encryption)• Shared key WEP <p>If your problem is not solved, the SSID or network settings you entered may be incorrect. Confirm the wireless network settings.</p> <p>For Ad-Hoc Mode, change the authentication and encryption methods of your computer for the wireless setting. Your machine supports Open authentication only, with optional WEP encryption.</p>
TS-05	<p>The security information (SSID/Network Key) is incorrect.</p> <p>Confirm the SSID and Network Key. If your router uses WEP encryption, enter the key used as the first WEP key. Your Brother machine supports the use of the first WEP key only.</p>

Error Code	Problem and Recommended Solutions
TS-06	<p>The wireless security information (Authentication method/Encryption method/Network Key) is incorrect.</p> <p>Confirm the wireless security information (Authentication method/Encryption method/Network Key) listed in TS-04. If your router uses WEP encryption, enter the key used as the first WEP key. Your Brother machine supports the use of the first WEP key only.</p>
TS-07	<p>The machine cannot detect a wireless access point/router that has WPS or AOSS™ enabled.</p> <p>If you would like to configure your wireless settings using WPS or AOSS™, you must operate both your machine and the wireless access point/router. Confirm that your wireless access point/router supports WPS or AOSS™ and try starting again.</p> <p>If you do not know how to operate your wireless access point/router using WPS or AOSS™, see the documentation provided with your wireless access point/router, ask the manufacturer of your wireless access point/router, or ask your network administrator.</p>
TS-08	<p>Two or more wireless access points that have WPS or AOSS™ enabled are detected.</p> <ul style="list-style-type: none"> • Confirm that only one wireless access point/router within range has the WPS or AOSS™ method active and try again. • Try starting again after a few minutes to avoid interference from other access points.

Fax and Telephone Problems

If you cannot send or receive a fax, check the following:

- 1 Connect one end of the telephone line cord to the area labelled "LINE", and then connect the other end of the telephone line cord directly to a telephone wall socket.

If you can send and receive faxes when the telephone line is directly connected to the fax, the problem may be unrelated to the machine. Please contact your telephone service provider for connection issues.

- 2 Check the receive mode.

See *Related Information*:

- *Receive Modes*
- *Choose the Correct Receive Mode*

- 3 Try changing the compatibility settings.

You may be able to send and receive faxes by lowering the connection speed.

For more information, see *Related Information: Telephone Line Interference/VoIP*.

If the problem still is not resolved, turn the machine off, and then turn it on.



Related Information

- Telephone Line Interference/VoIP on page 20
 - Receive Modes on page 20
 - Choose the Correct Receive Mode on page 22
-

Troubleshooting for Other Fax Problems

Difficulties	Suggestions
Cannot send a fax.	Check all line cord connections. Make sure the telephone line cord is plugged into the telephone wall socket and the LINE socket of the machine. If you subscribe to DSL or VoIP services, contact your service provider for connection instructions.
	Print the Transmission Verification Report and check for an error.
	Ask the other party to check that the receiving machine has paper.
Cannot receive a fax.	<p>If you are using a telephone answering machine (External TAD mode) on the same line as the Brother machine, make sure your answering machine is set up correctly.</p> <ol style="list-style-type: none"> 1. Connect the external TAD as shown in the illustration. For more information, see the <i>Online User's Guide: External TAD (Telephone Answering Device)</i>. 2. Set your answering machine to answer in one or two rings. 3. Record the outgoing message on your answering machine. <ul style="list-style-type: none"> • Record five seconds of silence at the beginning of your outgoing message. • Limit your speaking to 20 seconds. • End your outgoing message with your Remote Activation Code for people sending manual faxes. For example: "After the beep, leave a message or press *51 and Start to send a fax." 4. Set your answering machine to answer calls. 5. Set your Brother machine's Receive Mode to External TAD. See <i>Related Information: Choose the Correct Receive Mode</i> at the end of this section.
	Make sure your Brother machine's Fax Detect feature is turned On. Fax Detect is a feature that allows you to receive a fax even if you answered the call on an external or extension telephone.
Left and right margins are cut off or a single page is printed on two pages.	Turn on Auto Reduction.
Dialling does not work. (No dial tone)	<p>Check all line cord connections.</p> <p>Change Tone/Pulse setting. (Available only for some countries)</p>
Poor sending quality.	Try changing your resolution to Fine or S.Fine.
	<p>Make a copy to check your machine's scanner operation. If the copy quality is not good, clean the scanner.</p> <p>See <i>Related Information: Clean the Scanner</i> at the end of this section.</p>

Difficulties	Suggestions
Vertical black lines when sending.	Black vertical lines on faxes you send are typically caused by dirt or correction fluid on the glass strip. Clean the glass strip. See <i>Related Information: Clean the Scanner</i> at the end of this section.

Related Information

- Choose the Correct Receive Mode on page 22
 - Clean the Scanner on page 31
-

Print or Scan Problems

IMPORTANT

Using non-Brother supplies may affect the print quality, hardware performance, and machine reliability.

If you cannot print or scan a document, check the following:

- 1 All of the machine's protective parts have been removed.
- 2 The interface cables are securely connected to the machine and the computer.
- 3 The printer or scanner driver has been installed correctly.

4 (Scan problem only)

Confirm the machine is assigned with an available IP address. (Windows®)

- a. Do one of the following:

(Windows® XP, Windows Vista® and Windows® 7)

Click  (**Start**) > **All Programs** > **Brother** > **Brother Utilities**.

Click the drop-down list and select your model name (if not already selected). Click **Scan** in the left navigation bar, and then click **Scanners and Cameras**.

(Windows® 8)

Click  (**Brother Utilities**), and then click the drop-down list and select your model name (if not already selected). Click **Scan** in the left navigation bar, and then click **Scanners and Cameras**.

- b. Do one of the following:

(Windows® XP)

Right-click a scanner device, and then select **Properties**. The Network Scanner Properties dialog box appears.

(Windows Vista®, Windows® 7 and Windows® 8)

Click the **Properties** button.

- c. Click the **Network Setting** tab to confirm the machine's IP address.

Try printing with your machine. If the problem still remains, uninstall and reinstall the printer driver.

5 If the problem still remains after trying all the above, try the following:

For a USB interface connection

- Change the USB cable for a new one.
- Use a different USB port.

For a Wireless Network connection

- Confirm your machine's Wireless status on the LCD.



The wireless connection setting is disabled. Enable the WLAN connection and set up the wireless network connection.



The wireless access point cannot be detected. Set up the wireless network connection again.



The wireless network is connected. A three-level indicator in the LCD displays the current wireless signal strength.



You can configure wireless settings by pressing  on the control panel.

If you cannot print on both sides of paper, check the following:

6 Change the paper size setting in the printer driver to A4.

Troubleshooting for Other Print Problems

Difficulties	Suggestions
Poor print quality	<p>Check the print quality.</p> <p>See <i>Related Information: Check the Print Quality</i> at the end of this section.</p> <p>Make sure the Media Type setting in the printer driver or the Paper Type setting in the machine's menu matches the type of paper you are using.</p> <p>For more information, see the <i>Online User's Guide: Print Settings (Windows®)</i> or <i>Print Options (Macintosh)</i>.</p>
White horizontal lines appear in text or graphics.	<p>Check the print quality.</p> <p>See <i>Related Information: Check the Print Quality</i> at the end of this section.</p>
The machine prints blank pages.	<p>Check the print quality.</p> <p>See <i>Related Information: Check the Print Quality</i> at the end of this section.</p>
Characters and lines are blurred.	<p>Check the printing alignment.</p> <p>See <i>Related Information: Check the Print Alignment from Your Brother Machine</i> at the end of this section.</p>
Printing appears dirty or ink seems to run.	<p>If you are using photo paper, make sure the glossy side of the photo paper is face down in the tray and you have set the correct paper type. If you are printing a photo from your computer, set the Media Type in the printer driver.</p>
Photo paper does not feed correctly.	<p>When you print on Brother Photo paper, load one extra sheet of the same photo paper in the paper tray. An extra sheet has been included in the paper package for this purpose.</p>
Vertical black lines or streaks appear in copies.	<p>Black vertical lines on copies are typically caused by dirt or correction fluid on the glass strip. Clean the glass strip, scanner glass, and the white bar and white plastic above them.</p> <p>See <i>Related Information: Clean the Scanner</i> at the end of this section.</p> <p>Check that the speck of dirt has been removed.</p>
Black marks or spots appear in copies.	<p>Black marks or spots on copies are typically caused by dirt or correction fluid on the scanner glass. Clean the scanner glass and white plastic above it.</p> <p>See <i>Related Information: Clean the Scanner</i> at the end of this section.</p> <p>Check that the speck of dirt has been removed.</p>

Related Information

- Clean the Scanner on page 31
- Check the Print Quality on page 31
- Check the Print Alignment from Your Brother Machine on page 33

Document and Paper Jams

Document Jams

Related Information

- Error and Maintenance Messages on page 36

Document is Jammed in the Top of the ADF Unit

- 1 Take out any paper from the ADF that is not jammed.
- 2 Open the ADF cover.
- 3 Remove the jammed document by pulling it upward.

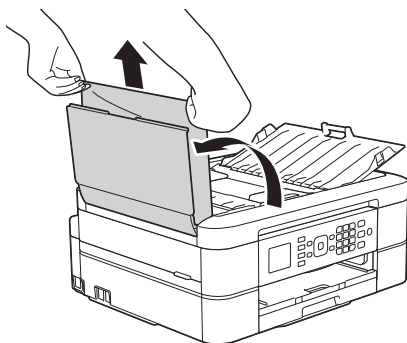

- 4 Close the ADF cover.
- 5 Press **Stop/Exit**.

IMPORTANT

To avoid future document jams, close the ADF cover correctly by pressing it down in the centre.

Document is Jammed inside the ADF Unit

- 1 Take any paper that is not jammed out of the ADF.
- 2 Lift the document cover.
- 3 Pull the jammed document out to the left.

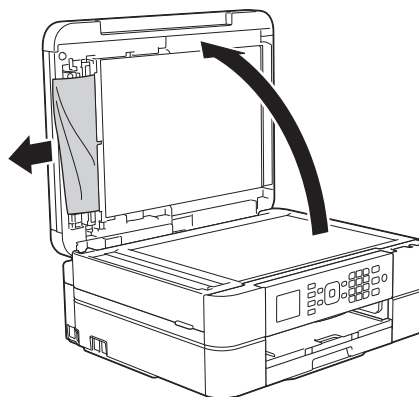

- 4 Close the document cover.
- 5 Press **Stop/Exit**.

Remove Paper Scraps Jammed in the ADF

- 1 Lift the document cover.

- 2 Insert a piece of stiff paper, such as cardstock, into the ADF to push any small paper scraps through.

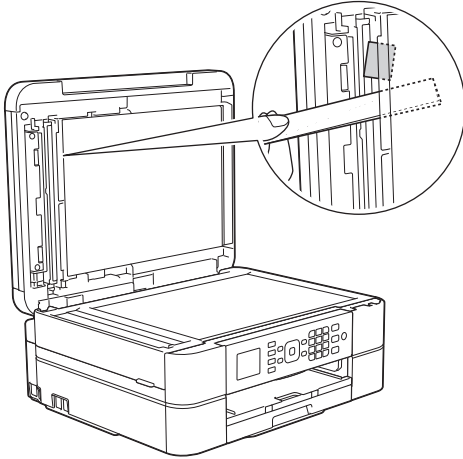

- 3 Close the document cover.

- 4 Press **Stop/Exit**.

Printer Jam or Paper Jam

Locate and remove the jammed paper.

Related Information

- Error and Maintenance Messages on page 36

Paper is Jammed Inside and in the Front of the Machine (Jam A Inside/Front)

If the LCD displays [Jam A Inside/Front] or [Repeat Jam A], follow these steps:

- 1 Unplug the machine from the electrical socket.

IMPORTANT

(MFC-J480DW)

Before you unplug the machine from the power source, you can transfer your faxes that are stored in the machine's memory to your computer or another fax machine so you will not lose any important messages.

For more information, see the *Online User's Guide: Transfer Your Faxes or Fax Journal Report*.

- 2 Pull the paper tray (1) completely out of the machine.

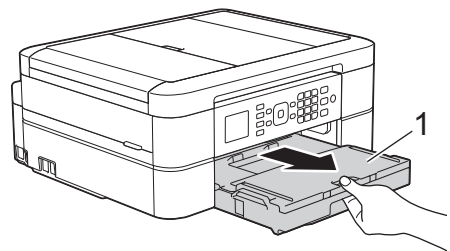

- 3** Pull the two green levers inside the machine to release the jammed paper.

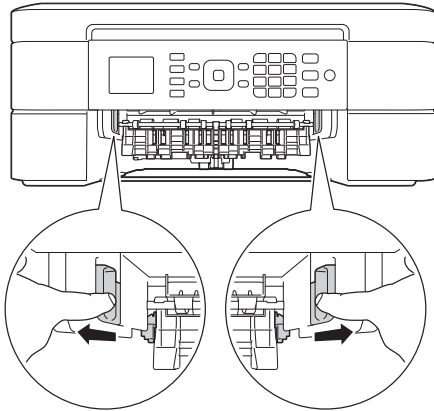

- 4** Place both hands under the plastic tabs on both sides of the machine to lift the scanner cover (1) into the open position.

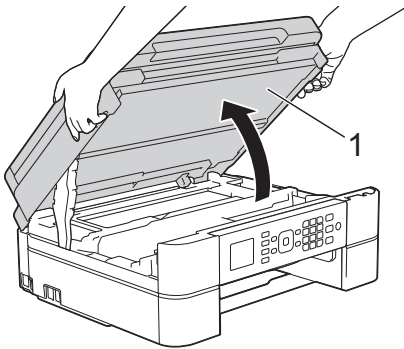

- 5** Slowly pull the jammed paper (1) out of the machine.

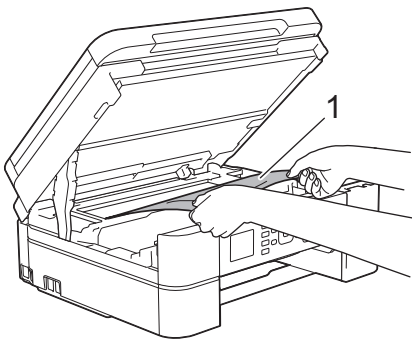

- 6** If the LCD displays [Repeat Jam A], move the print head (if needed) to take out any paper remaining in this area. Make sure scraps of paper are not left in the corners of the machine (1) and (2).

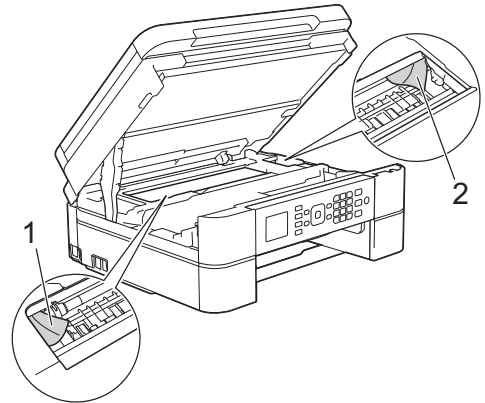

IMPORTANT

- DO NOT touch the encoder strip, a thin strip of plastic that stretches across the width of the machine (1). Doing this may cause damage to the machine.

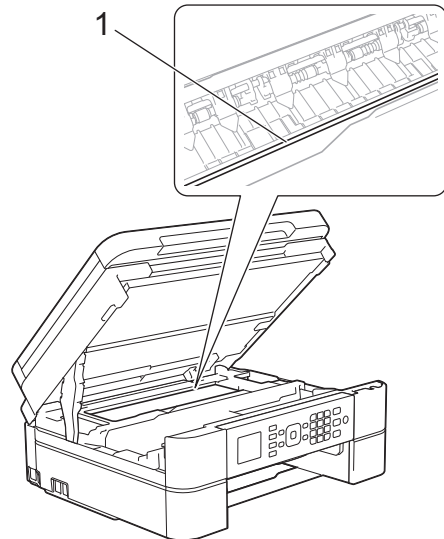

- If the print head is in the right corner as shown in the illustration (2), you cannot move the print head. Close the scanner cover, and then reconnect the power cord. Open the scanner cover again, and then hold down **Stop/Exit** until the print head moves to the centre. Then unplug the machine from the power source and take out the paper.

- If the paper is jammed under the print head, unplug the machine from the power source, and then move the print head to take out the paper.

Hold the concave areas with the triangle marks shown in the illustration (3) to move the print head.

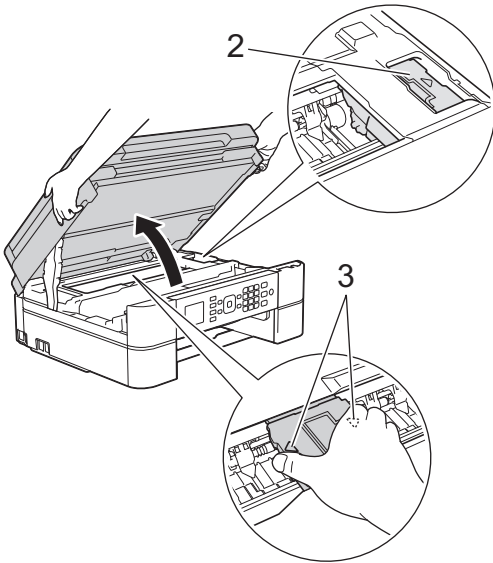

- If ink gets on your skin or clothing, immediately wash it off with soap or detergent.

7 Gently close the scanner cover using both hands.

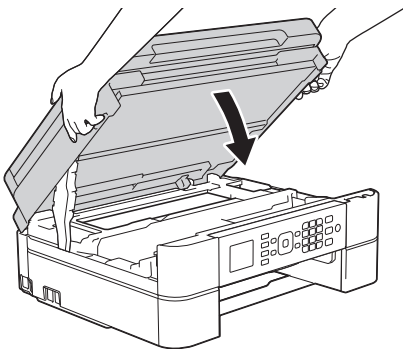

8 Slowly pull the jammed paper (1) out of the machine.

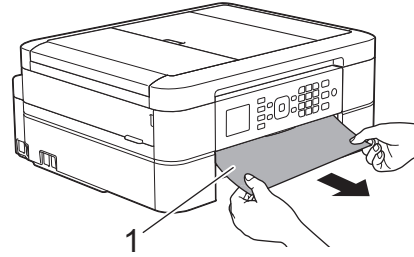

If the LCD displays [Repeat Jam A], do the following:

- Make sure you look carefully inside (1) for any scraps of paper.

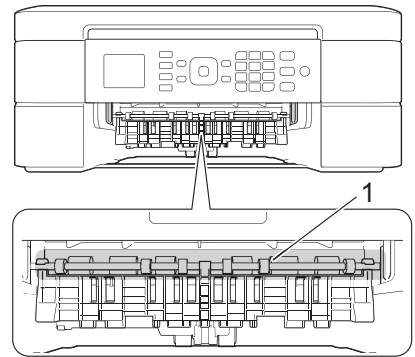

- Squeeze both levers (1), and then open the Jam Clear Cover at the back of the machine.

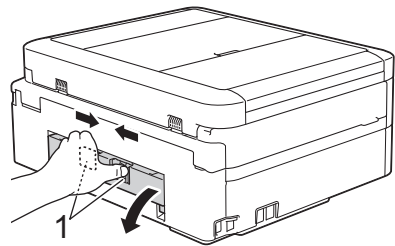

- Slowly pull the jammed paper out of the machine.

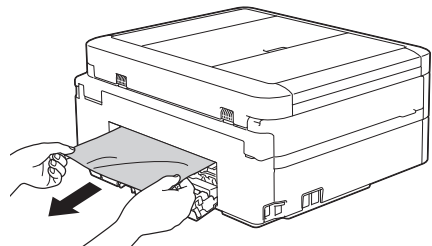

- d. Close the Jam Clear Cover. Make sure the cover is closed completely.

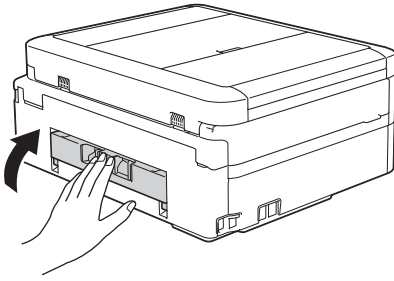

- 9 Put the paper tray firmly back in the machine.

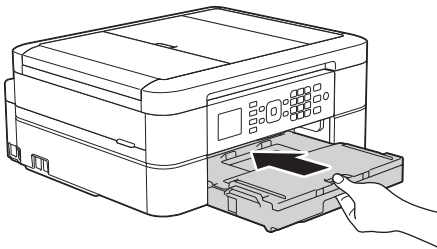

- 10 While holding the paper tray in the machine, pull out the paper support (1) until it locks into place, and then unfold the paper support flap (2).

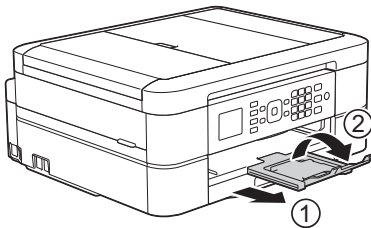

- 11 Reconnect the power cord.

Paper is Jammed in the Front of the Machine (Jam B Front)

If the LCD displays [Jam B Front] or [Repeat Jam B], follow these steps:

- 1 Unplug the machine from the electrical socket.

IMPORTANT

(MFC-J480DW)

Before you unplug the machine from the power source, you can transfer your faxes that are stored in the machine's memory to your computer or another fax machine so you will not lose any important messages.

For more information, see the *Online User's Guide: Transfer Your Faxes or Fax Journal Report*.

- 2 Pull the paper tray (1) completely out of the machine.

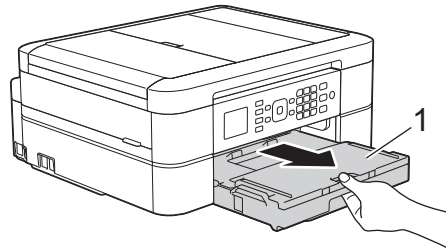

- 3 Pull the two green levers inside the machine to release the jammed paper.

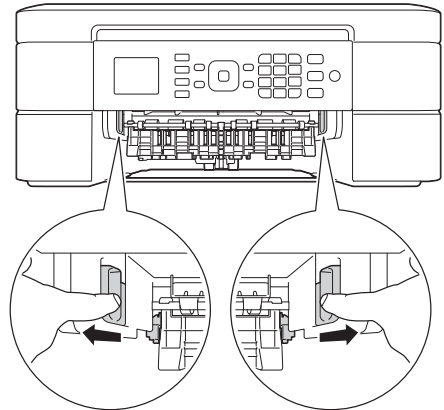

4 Slowly pull out the jammed paper (1).

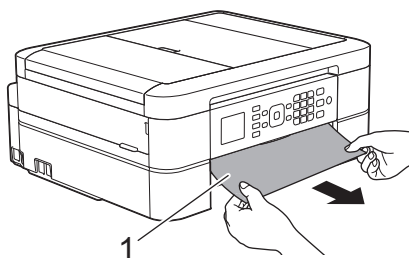

If the LCD displays [Repeat Jam B], do the following:

- Make sure you look carefully inside (1) for any scraps of paper.

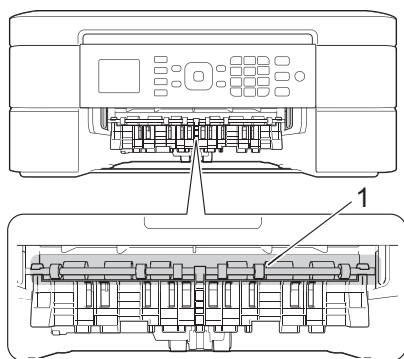

- Squeeze both levers (1), and then open the Jam Clear Cover at the back of the machine.

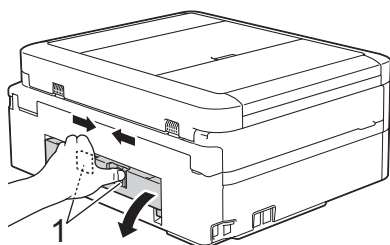

- Slowly pull the jammed paper out of the machine.

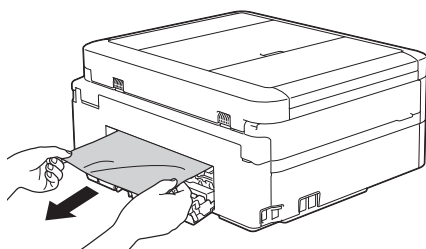

- Close the Jam Clear Cover. Make sure the cover is closed completely.

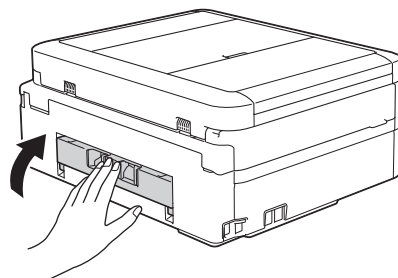

- Put the paper tray firmly back in the machine.

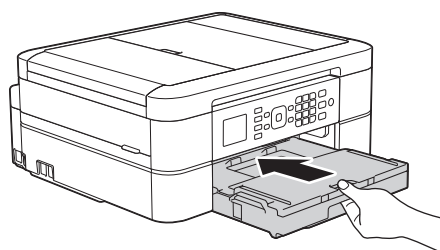

- While holding the paper tray in the machine, pull out the paper support (1) until it locks into place, and then unfold the paper support flap (2).

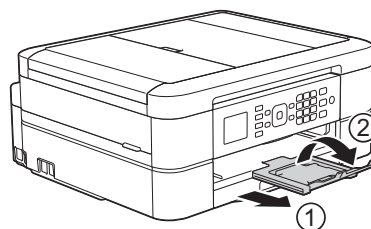

- Reconnect the power cord.

Paper is Jammed in the Back of the Machine (Jam C Rear)

If the LCD displays [Jam C Rear], follow these steps:

- Unplug the machine from the electrical socket.

IMPORTANT

(MFC-J480DW)

Before you unplug the machine from the power source, you can transfer your faxes that are stored in the machine's memory to your computer or another fax machine so you will not lose any important messages.

For more information, see the *Online User's Guide: Transfer Your Faxes or Fax Journal Report*.

- 2 Pull the paper tray (1) completely out of the machine.

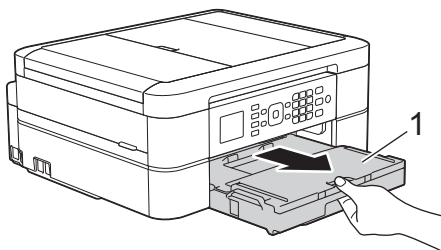

- 3 Pull the two green levers inside the machine to release the jammed paper.

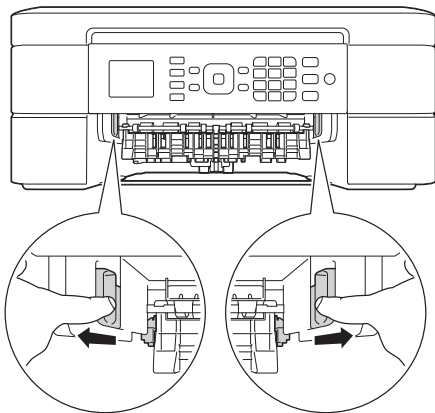

Depending on the paper size, it is easier to remove the jammed paper from the front of the machine rather than from the back of the machine.

- 4 Squeeze both levers (1), and then open the Jam Clear Cover at the back of the machine.

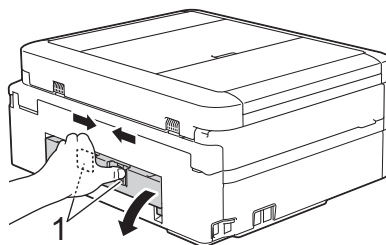

- 5 Slowly pull the jammed paper out of the machine.

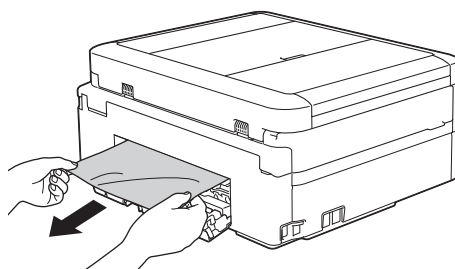

- 6 Close the Jam Clear Cover. Make sure the cover is closed completely.

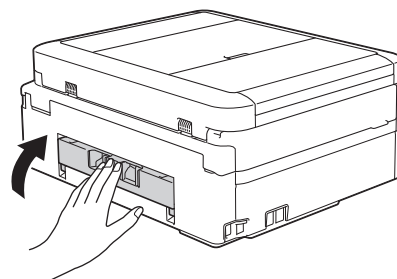

- 7 Put the paper tray firmly back in the machine.

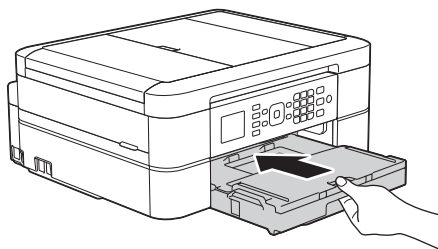

- 8 While holding the paper tray in the machine, pull out the paper support (1)

until it locks into place, and then unfold the paper support flap (2).

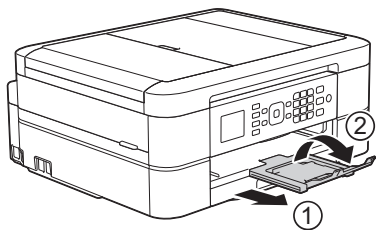

9 Reconnect the power cord.

Enter Text on Your Brother Machine

- The characters that are available may differ depending on your country.

When you are setting certain menu selections, such as the Station ID, you may need to enter text into the machine. Most dial pad buttons have three or four letters printed on the buttons. The buttons for **0**, **#** and ***** do not have printed letters because they are used for special characters.

Press the appropriate dial pad button the number of times shown in this reference table to access the character you want.

Press button	one time	two times	three times	four times	five times
2	A	B	C	2	A
3	D	E	F	3	D
4	G	H	I	4	G
5	J	K	L	5	J
6	M	N	O	6	M
7	P	Q	R	S	7
8	T	U	V	8	T
9	W	X	Y	Z	9

- To move the cursor to the left or right, press ◀ or ▶.

Inserting spaces

- To enter a space in a fax number, press ▶ once.
- To enter a space in a name, press ▶ twice.

Making corrections

- If you entered an incorrect character and want to change it, press ◀ or ▶ to move the cursor under the incorrect character. Press **Clear**, and then enter the correct character.
- To insert a character, press ◀ or ▶ to move the cursor to the correct place, and then enter the character.
- To erase all the characters, press **Clear** repeatedly.

Repeating letters

- To enter a letter that is on the same button as the letter before, press ▶ to move the cursor to the right before you press the button again.

Special characters and symbols

Press *, # or 0 repeatedly until you see the special character or symbol you want.

Press *	(space)! " # \$ % & ' () * + , - . / €
Press #	: ; < = > ? @ [] ^ _
Press 0	Ä Ë Ö Ü À Ç È É 0

Information for compliance with Commission Regulation 801/2013

Power consumption	MFC-J480DW
Networked Standby ¹	Approx. 1.7 W

¹ All network ports activated and connected

How to enable/disable Wireless LAN

To turn on or off the wireless network connection, press **Settings**, select [Network] > [WLAN Enable] > [On] or [Off].

Supply Specifications

Ink	The machine uses individual Black, Yellow, Cyan and Magenta ink cartridges that are separate from the print head assembly.
Service Life of Ink Cartridge	The first time you install a set of ink cartridges the machine will use an amount of ink to fill the ink delivery tubes for high quality printouts. This process will only happen once. After this process is complete the cartridges provided with your machine will have a lower yield than regular capacity cartridges (80%). With all following ink cartridges you can print the specified number of pages.
Replacement Supplies	<p><Standard Yield Black> LC221BK <Standard Yield Yellow> LC221Y <Standard Yield Cyan> LC221C <Standard Yield Magenta> LC221M</p> <p>Black, Yellow, Cyan and Magenta - Approximately 260 pages ¹</p>
	<p><High Yield Black> LC223BK <High Yield Yellow> LC223Y <High Yield Cyan> LC223C <High Yield Magenta> LC223M</p> <p>Black, Yellow, Cyan and Magenta - Approximately 550 pages ¹</p>
	<p>For more information about replacement supplies, visit us at http://www.brother.com/pageyield</p>
<p>What is Innobella?</p> 	<p>Innobella is a range of genuine supplies offered by Brother. The name "Innobella" derives from the words "Innovation" and "Bella" (meaning "Beautiful" in Italian) and is a representation of the "innovative" technology providing you with "beautiful" and "long lasting" print results.</p> <p>When you print photo images, Brother recommends Innobella glossy photo paper (BP71 series) for high quality. Brilliant prints are made easier with Innobella Ink and paper.</p>

¹ Approx. cartridge yield is declared in accordance with ISO/IEC 24711



If you are using Windows[®], double-click the Brother CreativeCenter icon  on your desktop to access our **FREE** website designed as a resource to help you easily create and print customised materials for business and home use with photos, text and creativity.

Mac users can access Brother CreativeCenter at this web address:

<http://www.brother.com/creativecenter>

Related Information

- Error and Maintenance Messages on page 36

A

Address Book.....	24
ADF (automatic document feeder).....	14, 18
Automatic	
fax receive.....	20

C

Cleaning	
scanner.....	31
Control Panel Overview.....	1
Copy.....	14
settings.....	15

D

Document	
how to load.....	14, 18

E

Entering Text.....	58
Error messages.....	36

F

Fax	
F/T ring time.....	23
ring delay.....	23
station ID.....	20
telephone line compatibility.....	20
Fax receive.....	20
Fax, from computer.....	29

J

Jams.....	50
document.....	50
paper.....	51

M

Manual	
receive.....	20

P

Paper	
check paper setting.....	9
how to load	7
Print.....	11
alignment check.....	33
quality check.....	31

R

Receive Mode.....	20, 22
-------------------	--------

S

Scan.....	17
Supplies.....	60

T

TAD (Telephone Answering Device), external.....	20, 26
Transferring your faxes or Fax Journal report.....	40
Troubleshooting	
document and paper jams	50
error and maintenance messages ..	36
fax and telephone problems	44
print or scan problems	47

V

Voice Mail.....	26
VoIP systems.....	20, 26

W

Wireless LAN report.....	42
--------------------------	----

brother

Visit us on the World Wide Web
<http://www.brother.com>



Made from 100% recycled paper
(excludes cover)

UK
Version 0