

Please read this booklet before attempting to operate the machine, or before attempting any maintenance. Failure to follow these instructions may result in an increased risk of fire, electrical shock, burns or suffocation. Brother shall not be liable for damage caused where the product owner has failed to follow instructions set out in this guide.

How to use this guide:

- 1 Read the whole guide before using your machine and keep it for later reference.
- 2 Carefully follow the instructions set out in this guide and always ensure that you follow all warnings and instructions marked on the product.
- 3 If you have concerns about how to use your machine having read this guide, please refer to your local Brother dealer or Brother customer service.
- 4 To ensure you understand all of the instructions, study the Symbols and Conventions used in the documentation below.

Symbols and conventions used in the documentation

The following symbols and conventions are used throughout the documentation:

WARNING

WARNING indicates a potentially hazardous situation which, if not avoided, could result in death or serious injuries.

CAUTION

CAUTION indicates a potentially hazardous situation which, if not avoided, may result in minor or moderate injuries.

IMPORTANT

IMPORTANT indicates a potentially hazardous situation which, if not avoided, may result in damage to property or loss of product functionality.

NOTE

NOTE tells you how you should respond to a situation that may arise or give tips about how the operation works with other features.

 Prohibition icons indicate actions that must not be performed.

 This icon indicates that flammable sprays may not be used.

 This icon indicates that organic solvents such as alcohol and liquids may not be used.

 Electrical Hazard icons alert you to possible electrical shocks.

 Fire Hazard icons alert you to the possibility of fire.

 Unplug icons indicate that you should unplug the machine.

Bold Bold typeface identifies specific buttons on the machine's control panel, or on the computer screen.

Italics Italicised typeface emphasises an important point or refers you to a related topic.

(ADS-2800W, ADS-3600W only)
Courier New Text in the Courier New font identifies messages on the LCD of the machine.

Follow all warnings and instructions marked on the machine and AC adapter (from now on collectively referred to as "the unit").

NOTE

The illustrations in this guide show the ADS-3600W.

Product Safety Guide

Compilation and Publication Notice

This manual has been compiled and published to provide the latest product safety information at the time of publication. The information contained in this manual may be subject to change.

For the latest manual, visit the Brother Solutions Center at support.brother.com

Choose a safe location for the unit

Put your unit on a flat, stable surface that is free from shocks and vibrations, such as a desk. Put the unit near a standard earthed electrical socket. Choose a dry, well ventilated location where the temperature remains between 5 and 35 °C.

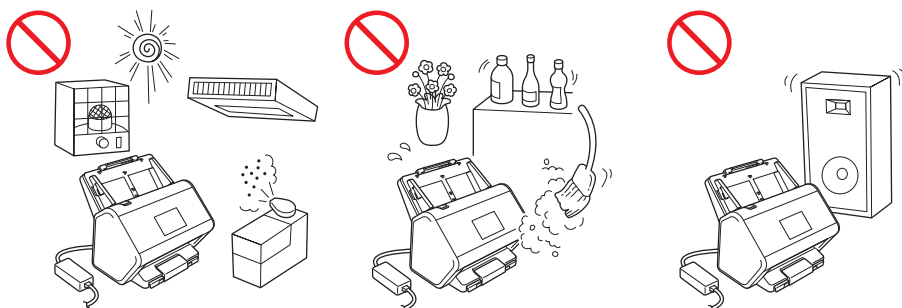

WARNING



DO NOT expose the unit to direct sunlight, excessive heat, open flames, corrosive gasses, moisture or dust. **DO NOT** place the unit on a carpet or rug, as this will expose it to dust. Doing so may create a risk of an electrical short or fire. It may also damage the unit and/or render it inoperable.



DO NOT place the unit near radiators, heaters, air conditioners, water, chemicals or devices that contain magnets or generate magnetic fields. Doing so may create the risk of a short circuit or fire should water come into contact with the unit (including condensation from heating, air conditioning, and/or ventilation equipment that may be sufficient to create a short circuit or fire).



DO NOT place the unit near chemicals or in a place where chemical spillage could occur. In particular, organic solvents or liquids may cause the casing and/or cables to melt or dissolve, risking a fire or electric shock. They may also cause the unit to malfunction or become discoloured.

Product Safety Guide



Slots and openings in the casing, back or bottom of the product are provided for ventilation. To avoid blocking or covering these openings, the product should be placed where it will not touch any wall or other device. Blocking the unit's ventilation could create a risk of overheating and/or fire.

IMPORTANT

- Always place the unit on a solid surface, never on a bed, sofa, rug, or similar soft surfaces.
- DO NOT place the unit in a “built-in” installation.

CAUTION

Avoid placing the unit in a high-traffic area. If you must place it in a high-traffic area, ensure that the unit is in a safe location where it cannot be accidentally knocked over, which could cause injury to you or others and serious damage to the unit.

Ensure that cables and cords leading to the unit are secured so as not to pose a tripping hazard.

Make sure that no part of the unit protrudes from the desk or stand where the unit is located. In particular, do not leave the output tray open when the machine is located on the edge of a table, stand, etc. Make sure that the unit is located on a flat, level, and stable surface free from vibration. Failure to observe these precautions could cause the machine to fall, causing injury to you and serious damage to the unit.

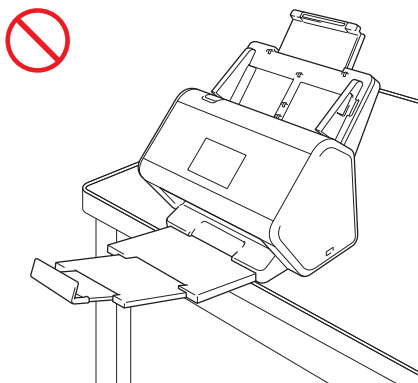

DO NOT place the unit on an unstable or tilted cart, stand, table or on any tilted/slanted surface. The machine may fall, causing injury to you and serious damage to the unit.

IMPORTANT

- DO NOT put objects on top of the unit.
- DO NOT place the unit next to sources of interference, such as speakers or the base units of non-Brother cordless telephones. Doing so may interfere with the operation of the unit's electronic components.

Product Safety Guide

General precautions

WARNING

Plastic bags are used in the packing of the machine. To avoid danger of suffocation, keep these plastic bags away from babies and children. Plastic bags are not toys.



Never insert any objects into the slots in the machine's casing, since they may touch dangerous voltage points or short out parts resulting in the risk of fire or electric shock. If metal objects, water or other liquids get inside the machine, immediately unplug the unit from the electrical socket. Contact your Brother dealer or Brother customer service.



DO NOT use flammable substances, any type of spray, or an organic solvent/liquid that contains alcohol or ammonia to clean the inside or outside of the unit. Doing this may cause a fire or electrical shock.



DO NOT disassemble or modify the unit, otherwise a fire or electrical shock may occur. If the unit requires repair, contact your Brother dealer or Brother customer service.



DO NOT touch the unit during a thunderstorm. There may be a remote risk of electrical shock from lightning when the machine is used during a thunderstorm.



DO NOT use the unit near any liquids, for example, near a bath tub, wash bowl, kitchen sink or washing machine, in a wet basement or near a swimming pool.



DO NOT use a damaged AC adapter.



DO NOT place heavy objects on, damage, or modify the AC adapter. Do not forcibly bend or pull the cord.



DO NOT drop, hit, or otherwise damage the AC adapter.

Product Safety Guide

⚠ CAUTION

DO NOT put pressure or weight on the unit or use it for any purpose beyond its intended purpose.

To avoid cutting yourself, do not slide or scrape your hand or fingers along the edge of the Carrier Sheet.

Wait until the machine ejects the pages to avoid trapping your fingers in the rollers.

Some areas of the machine can cause injury if covers (shaded) are closed with force. Take care when placing your hand in the areas shown in the illustrations.

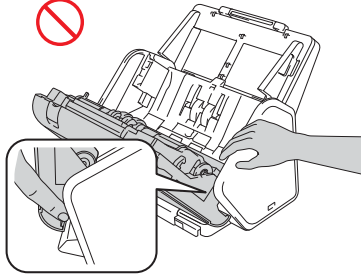
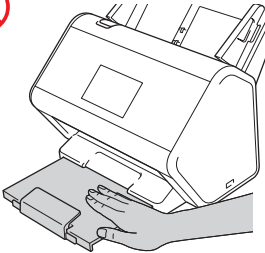

DO NOT carry the machine by holding the Extendable Automatic Document Feeder (ADF). Doing this may cause the Extendable Automatic Document Feeder (ADF) to detach from the machine. Only carry the machine by placing your hands under the entire machine.

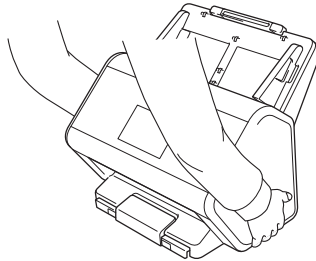
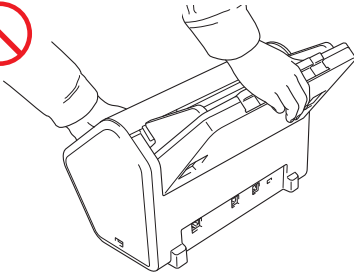

Use caution when operating the machine to prevent clothing (particularly sleeves, neckties, etc.), hair, or accessories from being drawn into the machine, otherwise an injury may occur. In the event that an object is drawn into the machine, immediately disconnect the unit from the power source.

DO NOT swing the AC adapter around or play with it. Doing so may result in injury to yourself or others.

IMPORTANT

(ADS-2800W, ADS-3600W only)

DO NOT touch the Touchscreen immediately after plugging in the power cord or turning the machine on. Doing this may cause an error.

Product Safety Guide

Connecting the unit safely

WARNING



There are high-voltage electrodes inside the unit. Before you access the inside of the machine, (for routine maintenance, such as cleaning), make sure you have unplugged the power cord from the electrical socket as well as any Ethernet (ADS-2800W, ADS-3600W only) cables from the machine.

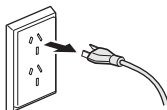

DO NOT touch the AC adapter, or handle the plug with wet hands. Doing this may cause an electrical shock.



DO NOT connect it to a DC power source or inverter. Doing this may cause an electrical shock. If you are not sure what kind of power source you have, contact a qualified electrician.



DO NOT use the unit if the power cord is frayed or damaged, doing so may cause an electrical shock or fire.



DO NOT pull on the middle of the AC power cord. **DO NOT** allow anything to rest on the power cord. **DO NOT** place the unit where people can walk on the cord. Doing this may cause an electrical shock or a fire.



Brother strongly recommends that you **DO NOT** use any type of extension cord. Failure to observe these precautions could cause a fire, electrical shock, or damage to the unit.



When disconnecting the AC adapter from the machine or from the power socket, always hold the connector, not the cable, and pull firmly. Failure to do so may result in exposed or broken power cord wires, fire, or electrical shock.

Product Safety Guide



Make sure that one end of the power cord is firmly plugged into a standard electrical socket and the other end is plugged into the adapter block firmly. Do not use an electrical socket that is loose. If the power cord is not completely plugged into the electrical socket and adapter block, there is a danger of the adapter becoming hot and catching fire.



Always use the supplied AC adapter, and plug the adapter into an electrical socket within the voltage range indicated on *Specifications* in the *User's Guide*. Failure to do so may result in an injury to yourself or others, or damage to the machine or other property. Brother does not assume any responsibility for any accident or damage resulting from not using the supplied AC adapter.



DO NOT connect the supplied AC adapter to other products.



DO NOT overload the AC adapter.

CAUTION

If you do not intend to use the unit for an extended period of time, disconnect the AC adapter from the electrical socket.

Servicing the unit

DO NOT attempt to service the unit yourself. Opening or removing covers may expose you to dangerous voltages and other risks, and may void your warranty. Contact your Brother dealer or Brother customer service.

WARNING



If the unit has been dropped or the casing has been damaged, there may be the possibility of an electric shock or a fire. Unplug the unit from the electrical socket and contact your Brother dealer or Brother customer service.



If the unit becomes unusually hot, releases smoke, generates any strong smells, or if you accidentally spill any liquid on it, immediately unplug the unit from the electrical socket. Contact your Brother dealer or Brother customer service.

IMPORTANT

If the machine does not operate normally when the operating instructions are followed, adjust only those controls that are covered by the operating instructions. Incorrect adjustment of other controls may result in damage, and will often require extensive work by a qualified technician to restore the unit to normal operation.

Important Information for Australia

Important safety instructions

- 1 Read all of these instructions.
- 2 Save them for later reference.
- 3 Follow all warnings and instructions marked on the machine.
- 4 Unplug this machine from the wall socket before cleaning the outside of the machine. Do not use liquid or aerosol cleaners. Use a damp cloth for cleaning.
- 5 Do not use this machine near water.
- 6 Do not place this machine on an unstable cart, stand, or table. The machine may fall, causing serious damage to the machine.
- 7 Slots and openings in the cabinet and the back or bottom are provided for ventilation; to ensure reliable operation of the machine and to protect it from overheating, these openings must not be blocked or covered. The openings should never be blocked by placing the machine on a bed, sofa, rug, or other similar surface. This machine should never be placed near or over a radiator or heater. This machine should never be placed in a built-in installation unless adequate ventilation is provided.
- 8 This machine should be connected to an AC power source within the range indicated on *Specifications* in the *User's Guide*. Do not connect it to a DC power source. If you are not sure, contact a qualified electrician.
- 9 Do not place anything on top of the power cord including this machine. Do not allow the power cord to be stepped on.
- 10 Do not place anything in front of the machine that will block scanned documents. Do not place anything in the path of documents.
- 11 Do not touch a document during scanning.
- 12 Never push objects of any kind into this machine through cabinet slots, since they may touch dangerous voltage points or short out parts resulting in a risk of fire or electric shock. Never spill liquid of any kind on the machine.
- 13 Do not attempt to service this machine yourself. Opening or removing covers may expose you to dangerous voltage points and/or other risks. Refer all servicing to service personnel.
- 14 Do not try and pick up pages that have not yet finished scanning and exited the machine.
- 15 Unplug this machine from the electrical socket and refer servicing to Authorized Service Personnel under the following conditions:
 - When the power cord is damaged or frayed.
 - If liquid has been spilled into the machine.
 - If the machine has been exposed to rain or water.
 - If the machine does not operate normally when the operating instructions are followed. Adjust only those controls that are covered by the operating instructions. Improper adjustment of other controls may result in damage and will often require extensive work by a qualified technician to restore the machine to normal operation.
 - If the machine has been dropped or the cabinet has been damaged.
 - If the machine exhibits a distinct change in performance, indicating a need for service.

Product Warranty & Liability

Nothing in this guide shall affect any existing product warranty or be construed as granting any additional product warranty. Failure to follow the safety instructions in this guide may invalidate your product's warranty.

WARNING

Use only the AC adapter supplied with this machine.

This product must be installed near an electrical socket that is easily accessible. In case of an emergency, you must unplug the power cord from the electrical socket to shut off the power completely.

Wireless LAN (ADS-2800W, ADS-3600W only)

This scanner supports a wireless interface.

LAN connection

IMPORTANT

DO NOT connect this machine to a LAN connection that is subject to over voltages.

NFC (ADS-3600W only)

This scanner supports NFC (Near Field Communication) capabilities.

Radio interference

This product complies with EN55022 (CISPR Publication 22)/Class B. When connecting the machine to a computer, ensure that you use a USB cable which does not exceed 2 m in length.

WLAN Enable/Disable (ADS-2800W, ADS-3600W only)

- 1 Press .
- 2 Press `Network`.
- 3 Press `WLAN`.
- 4 Press `▲` or `▼` to display `WLAN Enable`.
- 5 Press `WLAN Enable`.
- 6 Press `On` (or `Off`).

Product Safety Guide

For Singapore

Complies with
IDA Standards
DB02405

Complies with
IDA Standards
DB02405

For Thailand

This telecommunication equipment conforms to NTC technical requirement.

Trademarks

BROTHER is either a trademark or a registered trademark of Brother Industries, Ltd.

Microsoft, Windows, Windows Vista, Windows Server, Outlook and Internet Explorer are either registered trademarks or trademarks of Microsoft Corporation in the United States and/or other countries.

Apple, Macintosh, Mac OS and Safari are trademarks of Apple Inc., registered in the United States and other countries.

ABBYY, ABBYY FineReader and ABBYY PDF Transformer are either registered trademarks or trademarks of ABBYY Software Ltd.

Nuance, the Nuance logo and PaperPort are trademarks or registered trademarks of Nuance Communications, Inc. or its affiliates in the United States and/or other countries.

WPA, WPA2, Wi-Fi Protected Access and Wi-Fi Protected Setup are marks of the Wi-Fi Alliance.

Wi-Fi, Wi-Fi Alliance and Wi-Fi Direct are registered marks of the Wi-Fi Alliance.

AMD is a trademark of Advanced Micro Devices, Inc.

ISIS is a either registered trademark or a trademark of EMC Corporation in the United States and/or other countries.

Intel is a trademark of Intel Corporation in the U.S. and/or other countries.

Adobe and Photoshop are either registered trademarks or trademarks of Adobe Systems Incorporated in the United States and/or other countries.

Each company whose software title is mentioned in this manual has a Software License Agreement specific to its proprietary programs.

Any trade names and product names of companies appearing on Brother products, related documents and any other materials are all trademarks or registered trademarks of those respective companies.

Compilation and Publication

Under the supervision of Brother Industries, Ltd., this manual has been compiled and published, covering the latest product descriptions and specifications.

The contents of this manual and the specifications of this product are subject to change without notice.

Brother reserves the right to make changes without notice in the specifications and materials contained herein and shall not be responsible for any damages (including consequential) caused by reliance on the materials presented, including but not limited to typographical and other errors relating to the publication.

Copyright and License

© 2015 Brother Industries, Ltd. All rights reserved.

This product includes software developed by the following vendors:

© 2008 Devicescape Software, Inc.

This product includes the "KASAGO TCP/IP" software developed by ZUKEN ELMIC, Inc.

Open Source Licensing Remarks

This product includes open-source software.

Please visit the Brother Solutions Center at support.brother.com to see the open source licensing remarks.

Brother customer service

Customer service

Visit www.brother.com for contact information for your local Brother office.

Service centre locations

For service centres in Europe, contact your local Brother Office. Address and telephone contact information for European offices can be found at www.brother.com by selecting your country.

Unlawful use of scanning equipment

It is an offence to make reproductions of certain items or documents with the intent to commit fraud. The following is a non-exhaustive list of documents which it may be unlawful to produce copies of. We suggest you check with your legal adviser and/or the relevant legal authorities if in doubt about a particular item or document:

- Currency
- Bonds or other certificates of debt
- Certificates of deposit
- Armed forces service or draft papers
- Passports
- Postage stamps (cancelled or uncanceled)
- Immigration papers
- Welfare documents
- Cheques or drafts drawn by governmental agencies
- Identifying badges or insignias

Copyrighted works cannot be copied lawfully, subject to the "fair dealing" exception relating to sections of a copyrighted work. Multiple copies would indicate improper use. Works of art should be considered the equivalent of copyrighted works.

Notice Regarding the Faithful Reproduction of Scanned Documents

After scanning a document, confirm that the accuracy and quality of the corresponding scan data meets your needs by confirming the size of the scan data, the amount of image data captured, image fidelity, colour tones, etc.

Always confirm the scan data before destroying the original document.

It is possible that a portion of the scan data may be lost or damaged, therefore, read all instructions carefully and keep the following in mind:

- Depending on the condition of the document, the document may become worn thin, distorted, dirty, or cracked during scanning. In this case, some or all of the scan data may be lost.

Confirm that the document has no wrinkles, bends, or holes.

- If the inside of the machine is dirty, the document may become worn thin, distorted, dirty, or cracked during scanning. In this case, some or all of the scan data may be lost.

Clean the inside of the machine carefully and regularly.

- The following may occur depending on the scan settings, such as document size, scanning resolution, colour-related settings, single-side or double-side scanning settings, auto deskew, blank page skip, etc:

- Text may be illegible or unclear if image resolution is too low.
- Scan data of a colour document may be captured in black-and-white.
- Only one side of a two-sided document may be captured.
- A portion of the document may not be scanned, or the size may be too small.
- The document may only be scanned up to a certain point, after which scan data will be lost.
- Blank pages may not be deleted, or pages may be deleted unnecessarily.
- Margins may be added to the edges of the scan data.

Refer to the *User's Guide* for information about how to configure the scan settings.

- Depending on the condition of the document (such as if it has wrinkles, bends, or holes) and consumables, multiple pages of a document may be fed at once, causing some pages to be missing from the scanned data.

Confirm that the document has no wrinkles, bends, or holes.

Replace all consumables periodically.

- When scanning documents that are not within the recommended guidelines, or depending on the condition of the document (such as if it has wrinkles, bends, or holes), consumables, or the paper feeding mechanisms inside the machine, documents may become jammed inside the machine during scanning. In this case, some or all of the scan data may be lost. (Documents may be destroyed as a result of a paper jam.)

Refer to "Acceptable Documents" in the *User's Guide* for information about acceptable documents.

- When scanning documents that have been marked with a fluorescent marker, marked areas may not be seen correctly in the scan data, or the marker colour may not be reproduced correctly, depending on the colour and density of the marker ink.

You may achieve more desirable results by increasing the scanning resolution. Refer to the *User's Guide* for information about resolution settings.

Product Safety Guide

For Australia Only:

Support – For technical support of your Brother Product other than what you can resolve through the User's Guide, please visit our Web Site or Solutions Web Site (see below) to find an answer to FAQs/Troubleshooting, locating Drivers & Software.

Alternatively, please contact the Product Support Centre for any customer care/technical support enquiry.

To contact Brother International (Aust) Pty Ltd for support on a Brother product please see the details listed below:

Product Support Centre: **Australia**

Brother International (Aust) Pty Ltd

Phone: 02 8875 6000

Fax: 02 9870 7223

Solutions Site: solutions.brother.com

Web Site: www.brother.com.au

Email: To submit an e-mail enquiry, visit www.brother.com.au go to **Service and Support** area and follow the prompts.

Our Technical Support Consultants are available 5 days a week by phone during the hours of 8.30 am to 5.00 pm (EST/EDST) Monday to Friday.

For New Zealand Only:

To contact Brother International (NZ) Limited for support with a Brother product please use the following methods.

Phone:

Premium End User Assistance 0900 552 152

Auto Attendant Self Help 0800 652 152

Brother Recycle Assistance 0800 632 467

Fax Assistance 0800 837 822

Email Assistance Please visit www.brother.co.nz and submit a helpdesk enquiry from Online Help.

Web Assistance Please visit www.brother.co.nz under Online Help for Frequently Asked Questions, Driver downloads, Warranty information and Service Centres.

Our Technical Support Consultants are available 7 days a week by phone during the hours of 8.30 am to 5 pm Monday to Friday and 9 am to 5 pm Saturday and Sunday.

Outside of these hours you can find assistance from our Auto Attendant Self Help and our Website www.brother.co.nz under Online Help.

brother

Visit us on the World Wide Web
www.brother.com



www.brotherearth.com