



Online User's Guide

DCP-J785DW
MFC-J985DW

Table of Contents

Before You Use Your Brother Machine	1
Applicable Models	2
Definitions of Notes	3
Trademarks	4
Important Note	5
Introduction to Your Brother Machine.....	6
Before Using Your Machine	7
Control Panel Overview	8
LCD Overview	10
Message from Brother	16
Settings Screen Overview	17
Navigate the Touchscreen.....	19
Access Brother Utilities (Windows®)	20
Uninstall the Brother Software and Drivers (Windows®)	21
Paper Handling.....	22
Load Paper.....	23
Load Paper in the Paper Tray	24
Load Photo or Photo L Paper in Photo Paper Tray	35
Load Paper in the Manual Feed Slot.....	38
Unprintable Area	41
Paper Settings.....	42
Acceptable Paper and Other Print Media	45
Load Documents	54
Load Documents in the Automatic Document Feeder (ADF)	55
Load Documents on the Scanner Glass	57
Unscannable Area	59
Print.....	60
Print from Your Computer (Windows®)	61
Print a Photo (Windows®).....	62
Print a Document (Windows®).....	63
Cancel a Print Job (Windows®).....	64
Print More Than One Page on a Single Sheet of Paper (N in 1) (Windows®).....	65
Print as a Poster (Windows®).....	66
Print on Both Sides of the Paper Automatically (Automatic 2-sided Printing) (Windows®)	67
Print as a Booklet Automatically (Windows®).....	70
Print a Colour Document in Greyscale (Windows®).....	72
Prevent Smudged Printouts and Paper Jams When Printing on Both Sides of the Paper (Windows®)	73
Use a Preset Print Profile (Windows®)	74
Change the Default Print Settings (Windows®).....	77
Print Settings (Windows®).....	78
Print from Your Computer (Mac)	83
Print a Photo (Mac)	84

Print a Document (Mac)	85
Print on Both Sides of the Paper Automatically (Automatic 2-sided Printing) (Mac)	86
Print More Than One Page on a Single Sheet of Paper (N in 1) (Mac)	87
Print a Colour Document in Greyscale (Mac)	88
Prevent Smudged Printouts and Paper Jams When Printing on Both Sides of the Paper (Mac)	89
Print Options (Mac)	90
Scan.....	96
Scan Using the Scan Button on Your Brother Machine	97
Scan Photos and Graphics	98
Save Scanned Data to a Folder as a PDF File	100
Save Scanned Data to a Memory Card or USB Flash Drive	102
Scan Multiple Business Cards and Photos (Auto Crop)	107
Scan to an Editable Text File Using OCR	109
Scan to E-mail Attachment	111
Web Services for Scanning on Your Network (Windows Vista® SP2 or greater, Windows® 7, Windows® 8 and Windows® 10)	113
Change Scan Button Settings from ControlCenter4 (Windows®)	118
Change Scan Button Settings from ControlCenter2 (Mac)	122
Scan from Your Computer (Windows®)	125
Scan Using ControlCenter4 Home Mode (Windows®)	126
Scan Using ControlCenter4 Advanced Mode (Windows®)	141
Scan Using Nuance™ PaperPort™ 14 or Other Windows® Applications	156
Scan Using Windows® Photo Gallery or Windows® Fax and Scan	160
Install BookScan Enhancer and Whiteboard Enhancer (Windows®)	164
Scan from Your Computer (Mac)	165
Scan Using ControlCenter2 (Mac)	166
Scan Using Presto! PageManager or other TWAIN-Compliant Applications (Mac)	181
Copy	185
Copy a Document	186
Enlarge or Reduce Copied Images	188
Sort Copies	189
Make Page Layout Copies (N in 1 or Poster)	190
Page Layout Options for Copies	192
2-sided Copy	194
Copy on Both Sides of the Paper (1-sided to 2-sided/2-sided to 2-sided)	195
Copy an ID Card	197
Copy in Ink Save Mode	199
Copy Options	200
Fax	203
Send a Fax	204
Send a Fax from Your Brother Machine	205
Send a Fax Manually	207
Send a Fax at the End of a Conversation	208
Send the Same Fax to More than One Recipient (Broadcasting)	209
Send a Fax in Real Time	212
Send a Fax at a Specified Time (Delayed Fax)	213

Cancel a Fax in Progress	214
Check and Cancel a Pending Fax	215
Fax Polling	216
Fax Options	220
Receive a Fax	221
Receive Mode Settings	222
Fax Preview	228
Shrink Page Size of an Oversized Incoming Fax	232
Set the Fax Receive Stamp	233
Receive a Fax at the End of a Telephone Conversation	234
Memory Receive Options	235
Remote Fax Retrieval	242
Fax Polling	248
Voice Operations and Fax Numbers	256
Voice Operations	257
Store Fax Numbers	259
Set up Groups for Broadcasting	264
Telephone Services and External Devices	268
Use BT Call Sign	269
Caller ID	271
Set the Telephone Line Type	273
Voice Over Internet Protocol (VoIP/Telephone Line Interference)	275
External TAD (Telephone Answering Device)	276
External and Extension Telephones	280
Fax Reports	286
Set the Transmission Verification Report's Style	287
Set the Fax Journal's Interval Period	288
PC-FAX	289
PC-FAX for Windows®	290
PC-FAX for Mac	314
PhotoCapture Center	317
Print Photos Directly from Media	318
Compatible Memory Cards and USB Flash Drives	319
Important Information about PhotoCapture Center	320
Print Photos from Media Using the Photo Button on the Brother Machine	321
Copy Photos from Media to a Computer	335
Before Copying Photos	336
Copy Photos from Media Over a Local Connection	337
Copy Photos from Media Over a Network Connection	338
Print Photos from ControlCenter4 (Windows®)	339
Edit Photos Using ControlCenter4 (Windows®)	341
Network	343
Get Started	344
Supported Basic Network Features	345
Network Management Software and Utilities	346
Learn about Network Management Software and Utilities	347
Additional Methods of Configuring Your Brother Machine for a Wireless Network	348

Before Configuring Your Brother Machine for a Wireless Network.....	349
Configure Your Machine for a Wireless Network Using the One Push Method of Wi-Fi Protected Setup™ (WPS) or AOSS™	350
Configure Your Machine for a Wireless Network Using the PIN Method of Wi-Fi Protected Setup™ (WPS).....	351
Configure Your Machine for a Wireless Network in Ad-Hoc Mode Using a New SSID	353
Configure Your Machine for a Wireless Network When the SSID is Not Broadcast.....	354
Use Wi-Fi Direct®	356
Advanced Network Features.....	365
Print the Network Configuration Report.....	366
Technical Information for Advanced Users.....	367
Reset the Network Settings to Factory Default	368
Print the WLAN Report.....	369
Security	372
Lock the Machine Settings	373
About Using Memory Security.....	374
Mobile/Web Connect.....	378
Use Web Services from Your Brother Machine.....	379
Use Brother Web Services	380
Print with Google Cloud Print™	382
Print with AirPrint.....	383
Print with Mopria®	384
Print and Scan from a Mobile Device.....	385
Print and Scan Using Near-Field Communication (NFC).....	386
ControlCenter	387
ControlCenter4 (Windows®).....	388
Change the Operation Mode in ControlCenter4 (Windows®)	389
Scan Using ControlCenter4 Home Mode (Windows®).....	391
Scan Using ControlCenter4 Advanced Mode (Windows®).....	392
Set Up the Brother Machine Using ControlCenter4 (Windows®)	393
Create a Custom Tab Using ControlCenter4 Advanced Mode (Windows®).....	395
ControlCenter2 (Mac).....	397
Scan Using ControlCenter2 (Mac)	398
Set Up the Brother Machine Using ControlCenter2 (Mac)	399
Turn the AutoLoad Feature On (Mac)	401
Troubleshooting	402
Error and Maintenance Messages	403
Transfer Your Faxes or Fax Journal Report	412
Document Jams	416
Document is Jammed in the Top of the ADF Unit	417
Document is Jammed inside the ADF Unit.....	418
Remove Paper Scraps Jammed in the ADF	419
Printer Jam or Paper Jam	420
Paper is Jammed Inside and in the Front of the Machine (Jam A Inside/Front)	421
Paper is Jammed in the Front of the Machine (Jam B Front).....	426
Paper is Jammed in the Back of the Machine (Jam C Rear)	429

If You Are Having Difficulty with Your Machine	431
Paper Handling and Printing Problems	432
Telephone and Fax problems	438
Other Problems	444
Network Problems	446
Check the Machine Information	456
Reset Your Brother Machine	457
Reset Functions	458
Routine Maintenance	459
Replace the Ink Cartridges.....	460
Clean Your Brother Machine	463
Clean the Scanner.....	464
Clean the Print Head from Your Brother Machine	466
Clean the Print Head from Your Computer (Windows®).....	467
Clean the Print Head from Your Computer (Mac).....	469
Clean the Machine's LCD.....	470
Clean the Outside of the Machine	471
Clean the Machine's Printer Platen	473
Clean the Paper Feed Rollers	474
Clean the Paper Pick-up Rollers	476
Check Your Brother Machine	477
Check the Print Quality.....	478
Check the Print Alignment from Your Brother Machine	481
Check the Ink Volume	482
Monitor Machine Status from Your Computer (Windows®)	483
Monitor Machine Status from Your Computer (Mac).....	488
Correct the Paper Feed to Clear Vertical Lines.....	490
Pack and Ship Your Brother Machine	491
Machine Settings.....	493
Change Machine Settings from the Control Panel.....	494
In the Event of Power Failure (Memory Storage).....	495
General Settings.....	496
Save Your Favourite Settings as a Shortcut.....	509
Print Reports	512
Settings and Features Tables.....	515
Change Machine Settings from Your Computer.....	529
Change the Machine Settings Using Remote Setup	530
Appendix.....	542
Specifications	543
Enter Text on Your Brother Machine	550
Supply Specifications	551
Information Regarding Recycled Paper	552
Glossary.....	553

Before You Use Your Brother Machine

- [Applicable Models](#)
- [Definitions of Notes](#)
- [Trademarks](#)
- [Important Note](#)

Applicable Models

This User's Guide applies to the following models:

2.7 inch Touchscreen LCD models: DCP-J785DW/MFC-J985DW



Related Information

- [Before You Use Your Brother Machine](#)
-

Definitions of Notes

We use the following symbols and conventions throughout this User's Guide:

WARNING

WARNING indicates a potentially hazardous situation which, if not avoided, could result in death or serious injuries.

CAUTION

CAUTION indicates a potentially hazardous situation which, if not avoided, may result in minor or moderate injuries.

IMPORTANT

IMPORTANT indicates a potentially hazardous situation which, if not avoided, may result in damage to property or loss of product functionality.

NOTE

NOTE specifies the operating environment, conditions for installation, or special conditions of use.



Tips icons provide helpful hints and supplementary information.



Electrical Hazard icons alert you to possible electrical shock.

Bold

Bold style identifies buttons on the machine's control panel or computer screen.

Italics

Italicised style emphasises an important point or refers you to a related topic.

[Courier New]

Courier New font identifies messages shown on the machine's LCD.



Related Information

- [Before You Use Your Brother Machine](#)

Trademarks

Microsoft, Windows, Windows Vista, Windows Server, SharePoint, Internet Explorer, Word, Excel, PowerPoint, OneNote, OneDrive and Windows Phone are either registered trademarks or trademarks of Microsoft Corporation in the United States and/or other countries.

Apple, Mac, Safari, iPad, iPad mini, iPhone, iPod touch and OS X are trademarks of Apple Inc., registered in the United States and other countries.

AirPrint is a trademark of Apple Inc.

Nuance and PaperPort are trademarks or registered trademarks of Nuance Communications, Inc. or its affiliates in the United States and/or other countries.

Memory Stick PRO Duo, Memory Stick Duo, Memory Stick Micro and M2 are trademarks of Sony Corporation.

The SDHC Logo is a trademark of SD-3C, LLC.

AOSS is a trademark of Buffalo Inc.

Wi-Fi, Wi-Fi Alliance, Wi-Fi Direct and Wi-Fi Protected Access are registered trademarks of Wi-Fi Alliance®.

WPA, WPA2, Wi-Fi Protected Setup and Wi-Fi Protected Setup logo are trademarks of Wi-Fi Alliance®.

Flickr is a trademark of Yahoo! Inc.

Android, Android Market, Google Cloud Print, Google Drive, Picasa Web Albums, Google Play and Google Chrome are trademarks of Google, Inc. Use of these trademarks are subject to Google Permissions.

Mozilla and Firefox are registered trademarks of the Mozilla Foundation.

UNIX is a registered trademark of The Open Group in the United States and other countries.

Linux is the registered trademark of Linus Torvalds in the U.S. and other countries.

The Bluetooth word mark is owned by the Bluetooth SIG, Inc. and any use of such marks by Brother Industries, Ltd. is under license.

Intel is a trademark of Intel Corporation in the U.S. and/or other countries.

Evernote is a trademark of Evernote Corporation and used under a license.

The Mopria is a trademark of Mopria Alliance, Inc.

WordPerfect is a registered trademark of Corel Corporation and/or its subsidiaries in Canada, the United States and/or other countries.

Each company whose software title is mentioned in this manual has a Software License Agreement specific to its proprietary programs.

Any trade names and product names of companies appearing on Brother products, related documents and any other materials are all trademarks or registered trademarks of those respective companies.



Related Information

- [Before You Use Your Brother Machine](#)

Important Note

- Do not use this product outside the country of purchase as it may violate the wireless telecommunication and power regulations of that country.
- Not all models are available in all countries.
- Windows® XP in this document represents Windows® XP Professional, Windows® XP Professional x64 Edition and Windows® XP Home Edition.
- Windows Server® 2003 in this document represents Windows Server® 2003, Windows Server® 2003 x64 Edition, Windows Server® 2003 R2 and Windows Server® 2003 R2 x64 Edition.
- Windows Server® 2008 in this document represents Windows Server® 2008 and Windows Server® 2008 R2.
- In this User's Guide, the LCD messages of the MFC-J985DW are used unless otherwise specified.
- In this User's Guide, the illustrations of the MFC-J985DW are used unless otherwise specified.
- Unless otherwise specified, the screens in this manual are from Windows® 7 and OS X v10.9.x. Screens on your computer may vary depending on your operating system.
- The contents of this guide and the specifications of this product are subject to change without notice.
- This documentation is for both MFC and DCP models. Where it says 'MFC' in this User's Guide, read 'MFC-xxxx' as 'DCP-xxxx'. DCP models are not equipped with a fax function.



Related Information

- [Before You Use Your Brother Machine](#)

Introduction to Your Brother Machine

- [Before Using Your Machine](#)
- [Control Panel Overview](#)
- [LCD Overview](#)
- [Settings Screen Overview](#)
- [Navigate the Touchscreen](#)
- [Access Brother Utilities \(Windows®\)](#)

Before Using Your Machine

Before attempting any printing operation, confirm the following:

- Make sure you have installed the Brother software and drivers.
- For USB or network cable users: Make sure the interface cable is physically secure.

Selecting the correct type of paper

For high quality printing, it is important to select the correct type of paper. Be sure to read the information about acceptable paper before buying paper, and to determine the printable area depending on the settings in the printer driver.

Simultaneous printing, scanning and faxing

Your machine can print from your computer while sending or receiving a fax into memory or while scanning a document into the computer. Fax sending will not be stopped during printing from your computer. However, when the machine is copying or receiving a fax on paper, it pauses the printing operation, and then continues printing when copying or fax receiving has finished.



DCP models do not support the fax feature.

Firewall (Windows®)

If your computer is protected by a firewall and you are unable to network print, network scan, or PC-FAX, you may need to configure the firewall settings. If you are using the Windows® Firewall and you installed the Brother software and drivers from the CD-ROM, the necessary firewall settings have already been set. If you are using any other personal firewall software, see the User's Guide for your software or contact the software manufacturer.



Related Information

- [Introduction to Your Brother Machine](#)

Control Panel Overview

The control panel will vary depending on your model.

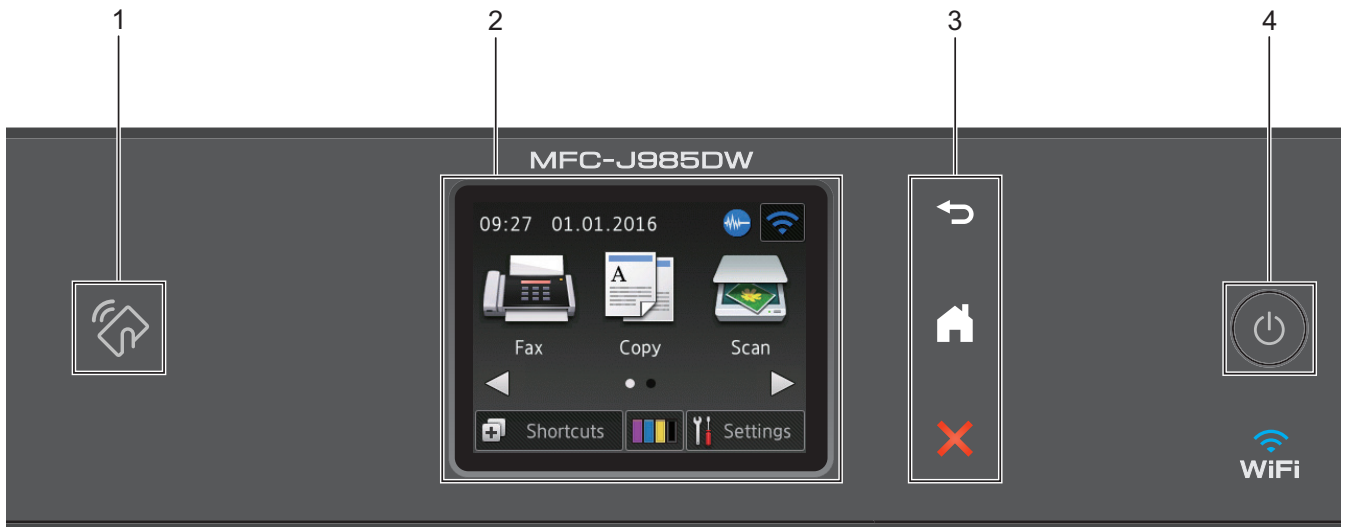

1. NFC (Near Field Communication) logo

(MFC-J985DW)

- If your Android™ device supports the NFC feature, you can print from your device or scan documents to your device by touching it to the NFC logo on the control panel. You must download and install Brother iPrint&Scan to your Android™ device to use this feature.
- Make sure the NFC settings of both your Brother machine and your Android™ device are set to On.

2. 2.7"(67.5 mm) Touchscreen Liquid Crystal Display (LCD)

Access menus and options by pressing them on this touchscreen.

Adjust the angle of the touchscreen LCD and touchpanel by lifting it.

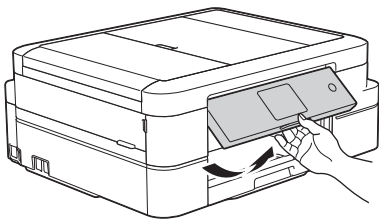

3. Touchpanel

(Back)

Press to go back to the previous menu.

(Home)

Press to return to the Home screen.

While the machine is in Sleep Mode, the Home icon blinks.

(Cancel)

Press to cancel an operation (available when illuminated in red).

4. Power On/Off

Press  to turn the machine on.

Press and hold down  to turn the machine off. The touchscreen will display [Shutting Down] and will stay on for a few seconds before turning itself off. If you have connected an external telephone or TAD, it is always available.

If you turn the machine off using , it will still clean the print head periodically to maintain print quality. To prolong print head life, provide better ink efficiency, and maintain print quality, keep your machine connected to a power source at all times.



Related Information

- [Introduction to Your Brother Machine](#)
 - [Print and Scan Using Near-Field Communication \(NFC\)](#)
-

LCD Overview

MFC-J985DW

There are two Home screens that you can access by pressing ◀ or ▶.

From the Home screens, you can access Wi-Fi setup, Shortcuts, Ink levels and Setup screens.

Home Screen 1

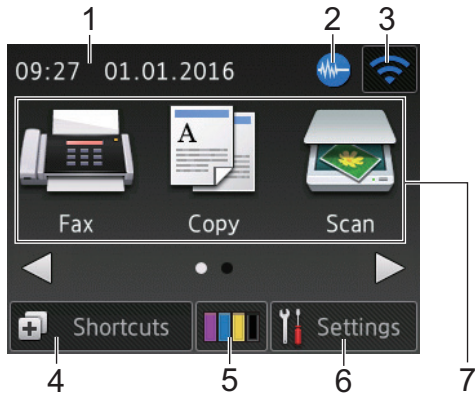

This screen shows the machine's status when the machine is idle. This Home screen is also called the Ready Mode screen. When displayed, this indicates that your machine is Ready for the next command.

Home Screen 1 provides access to [Fax], [Copy] and [Scan] operations.

Home Screen 2



Home Screen 2 provides access to additional features, such as [Photo], [Web] and [Apps] operations.

1. Date & Time

Displays the date and time set on the machine.



2. Quiet Mode

This icon appears when the [Quiet Mode] setting is set to [On].

The Quiet Mode setting can reduce printing noise. When Quiet Mode is turned on, the print speed becomes slower.

3. Wireless Status

Each icon in the following table shows the wireless network status.

	Your machine has not been connected to the wireless access point. Press this button to configure wireless settings. For more detailed information, see the <i>Quick Setup Guide</i> .
	Wireless network is connected. A three-level indicator in each of the Home screens displays the current wireless signal strength.
	The wireless access point cannot be detected.



The wireless setting is disabled.



You can configure wireless settings by pressing the Wireless Status button.

4. [Shortcuts]

Create Shortcuts for frequently-used operations such as sending a fax, copying, scanning and using Web Connect.



- There are three Shortcuts screens. You can program four shortcuts on each screen.
- To display the other Shortcuts screens, press ◀ or ▶.

5. [Ink]







Displays the available ink volume. Press to access the [Ink] menu.

When an ink cartridge is near the end of its life or having a problem, an error icon is displayed on the ink colour.

6. [Settings]

Press to access the [Settings] menu.

7. Modes:

-  [Fax]
Press to access Fax mode.
-  [Copy]
Press to access Copy mode.
-  [Scan]
Press to access Scan mode.
-  [Photo]
Press to access Photo mode.
-  [Web]
Press to connect the Brother machine to an Internet service.
For more detailed information, see the *Web Connect Guide*: support.brother.com/manuals
-  [Apps]
Press to connect the Brother machine to the Brother Apps service.
For more detailed information, see the *Web Connect Guide*: support.brother.com/manuals

8. [Stored Fax(es) :]



When [Fax Preview] is set to [Off], [Stored Fax(es)] displays how many received faxes are in the machine's memory.

Press [Print] to print the faxes.

9. [New Fax(es) :]





When [Fax Preview] is set to [On], [New Fax(es)] displays how many new faxes you have received and stored in the memory.

Press [View] to view the faxes on the touchscreen.

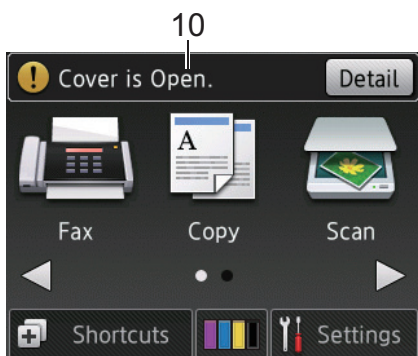
10. Warning icon



The warning icon  appears when there is an error or maintenance message; press [Detail] to view it, and then press  to return to Ready mode.



- This product adopts the font of ARPHIC TECHNOLOGY CO.,LTD.

DCP-J785DW

There are two Home screens that you can access by pressing ◀ or ▶.

From the Home screens, you can access Wi-Fi setup, Shortcuts, Ink levels and Setup screens.

Home Screen 1

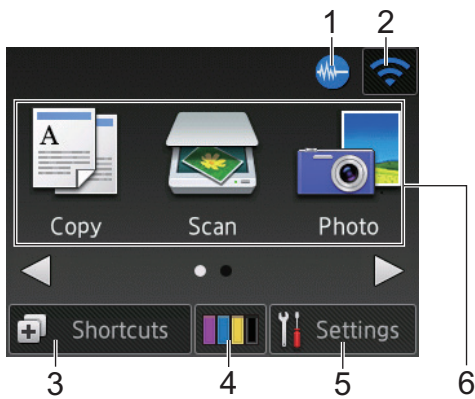

This screen shows the machine's status when the machine is idle. This Home screen is also called the Ready Mode screen. When displayed, this indicates that your machine is Ready for the next command.

Home Screen 1 provides access to [Copy], [Scan] and [Photo] operations.

Home Screen 2

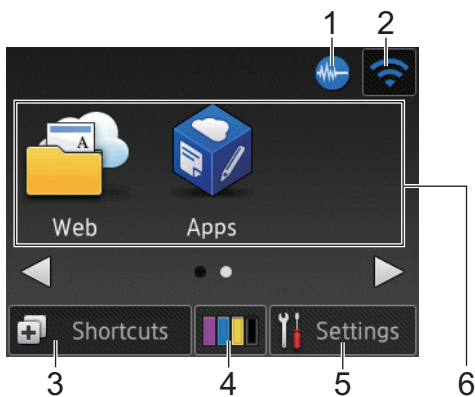

Home Screen 2 provides access to additional features, such as [Web] and [Apps] operations.





1. Quiet Mode

This icon appears when the [Quiet Mode] setting is set to [On].

The Quiet Mode setting can reduce printing noise. When Quiet Mode is turned on, the print speed becomes slower.

2. Wireless Status

Each icon in the following table shows the wireless network status.

	Your machine has not been connected to the wireless access point. Press this button to configure wireless settings. For more detailed information, see the <i>Quick Setup Guide</i> .
	Wireless network is connected. A three-level indicator in each of the Home screens displays the current wireless signal strength.
	The wireless access point cannot be detected.
	The wireless setting is disabled.



You can configure wireless settings by pressing the Wireless Status button.

3. [Shortcuts]

Create Shortcuts for frequently-used operations such as making a copy, scanning and using Web Connect.

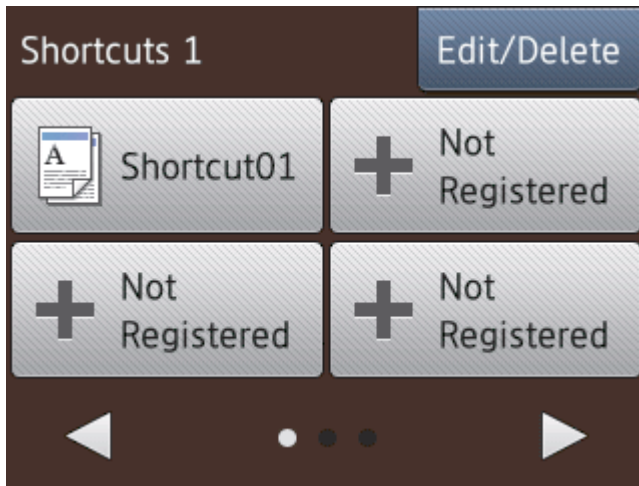

- There are three Shortcuts screens. You can program four shortcuts on each screen.
- To display the other Shortcuts screens, press ◀ or ▶.

4.  [Ink]

Displays the available ink volume. Press to access the [Ink] menu.

When an ink cartridge is near the end of its life or having a problem, an error icon is displayed on the ink colour.

5.  [Settings]

Press to access the [Settings] menu.

6. **Modes:**

•  [Copy]

Press to access Copy mode.

•  [Scan]

Press to access Scan mode.

•  [Photo]

Press to access Photo mode.

•  [Web]

Press to connect the Brother machine to an Internet service.

For more detailed information, see the *Web Connect Guide*: support.brother.com/manuals



•  [Apps]

Press to connect the Brother machine to the Brother Apps service.

For more detailed information, see the *Web Connect Guide*: support.brother.com/manuals

7. **Warning icon**



The warning icon  appears when there is an error or maintenance message; press [Detail] to view it, and then press  to return to Ready mode.



-
- This product adopts the font of ARPHIC TECHNOLOGY CO.,LTD.
-



Related Information

- [Introduction to Your Brother Machine](#)
 - [Message from Brother](#)
 - [Reduce Printing Noise](#)
 - [Reset Functions](#)
 - [Reset Your Brother Machine](#)
 - [Check the Ink Volume](#)
 - [Settings Screen Overview](#)
 - [Error and Maintenance Messages](#)
-

Message from Brother

If you use Brother Web Connect and [New Function Notice] is set to [On], notifications about cloud services will appear on the Home screen.

Check for new notifications by pressing [Detail].

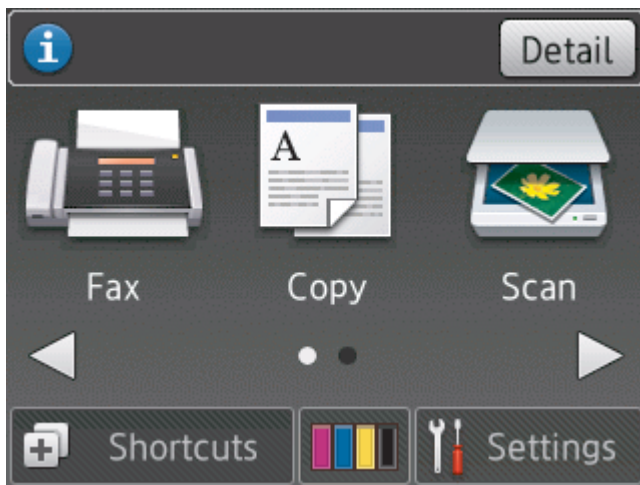

✓ Related Information

- [LCD Overview](#)

Settings Screen Overview

DCP-J785DW

The touchscreen shows the machine's status when you press  [Settings].

Use the Settings menu to access all of your Brother machine's settings.

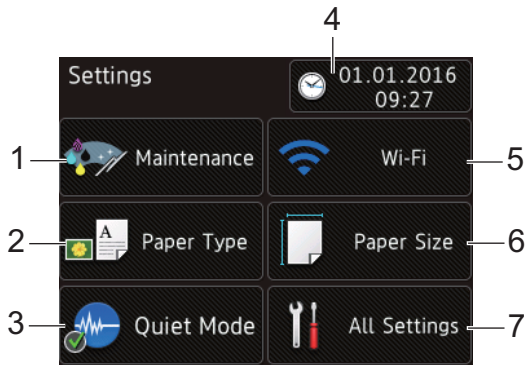

1. [Maintenance]

Press to access the [Maintenance] menu.

Use options in the Maintenance menu to check and improve print quality, clean the print head and check the ink volume.

2. [Paper Type]

Press to access the [Paper Type] menu.

3. [Quiet Mode]

Displays the Quiet Mode setting.

Press to access the [Quiet Mode] menu.

When this menu is set to [On],  is displayed on the Home screen.

4. [Date & Time]

Displays the date and time.

Press to access the [Date & Time] menu.

5. [Wi-Fi]

Press to set up a wireless network connection.

If you are using a wireless connection, a three-level indicator  on the screen displays the current wireless signal strength.

6. [Paper Size]

Press to access the [Paper Size] menu.

7. [All Settings]

Press to access a menu of all of your machine's settings.

MFC-J985DW

The touchscreen shows the machine's status when you press  [Settings].

Use the Settings menu to access all of your Brother machine's settings.



1. [Maintenance]

Press to access the [Maintenance] menu.

Use options in the Maintenance menu to check and improve print quality, clean the print head and check the ink volume.

2. [Quiet Mode]

Displays the Quiet Mode setting.

Press to access the [Quiet Mode] menu.

When this menu is set to [On],  is displayed on the Home screen.

3. [Fax Preview]

Displays the Fax Preview setting.

Press to access the [Fax Preview] menu.

4. Receive Mode

Displays the current Receive Mode.

- [Fax] (Fax Only)
- [Fax/Tel]
- [External TAD]
- [Manual]

5. [Date & Time]

Displays the date and time.

Press to access the [Date & Time] menu.

6. [Wi-Fi]

Press to set up a wireless network connection.

If you are using a wireless connection, a three-level indicator  on the screen displays the current wireless signal strength.

7. [Tray Setting]

Press to access the [Tray Setting] menu.

Use options in the Tray setting menu to change the paper size and type.

8. [All Settings]

Press to access a menu of all of your machine's settings.

Related Information

- [Introduction to Your Brother Machine](#)
- [LCD Overview](#)
- [Check the Ink Volume](#)

Navigate the Touchscreen

- Press your finger on the touchscreen to display and access all the settings and features and their available options. Press ◀▶ or ▲▼ to scroll through them.

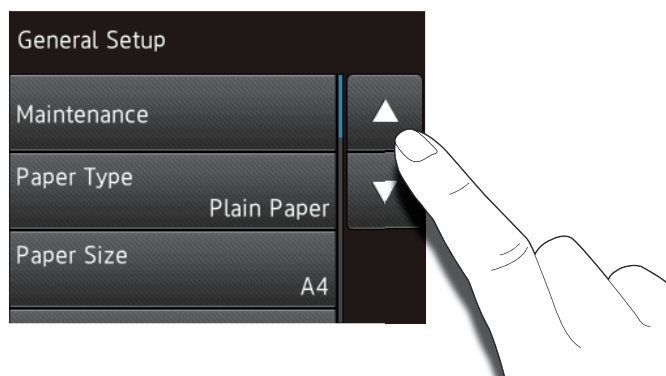

IMPORTANT

DO NOT press the touchscreen with a sharp object such as a pen or stylus. It may damage the machine.



DO NOT touch the touchscreen immediately after plugging in the power cord or turning on the machine. Doing this may cause an error.



Related Information

- [Introduction to Your Brother Machine](#)

Access Brother Utilities (Windows®)

Brother Utilities is an application launcher that offers convenient access to all Brother applications installed on your computer.

1. Do one of the following:

- Windows® XP, Windows Vista® and Windows® 7

Click  (**Start**) > **All Programs** > **Brother** > **Brother Utilities**.

- Windows® 8

Tap or click  (**Brother Utilities**) either on the **Start** screen or the desktop.

- Windows® 8.1

Move your mouse to the lower left corner of the **Start** screen and click  (if using a touch-based device, swipe up from the bottom of the **Start** screen to bring up the **Apps** screen).

When the **Apps** screen appears, tap or click  (**Brother Utilities**).

- Windows® 10

Click  > **All apps** > **Brother** > **Brother Utilities**.

2. Select your machine.

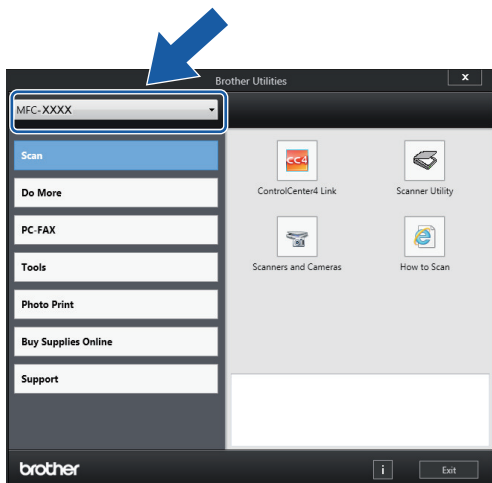

3. Select the operation you want to use.

Related Information

- [Introduction to Your Brother Machine](#)
- [Uninstall the Brother Software and Drivers \(Windows®\)](#)

Uninstall the Brother Software and Drivers (Windows®)

1. Do one of the following:

- Windows® XP, Windows Vista® and Windows® 7

Click  (**Start**) > **All Programs** > **Brother** > **Brother Utilities**.

- Windows® 8

Tap or click  (**Brother Utilities**) either on the **Start** screen or the desktop.

- Windows® 8.1

Move your mouse to the lower left corner of the **Start** screen and click  (if using a touch-based device, swipe up from the bottom of the **Start** screen to bring up the **Apps** screen).

When the **Apps** screen appears, tap or click  (**Brother Utilities**).

- Windows® 10

Click  > **All apps** > **Brother** > **Brother Utilities**.

2. Click the drop-down list, and then select your model name (if not already selected). Click **Tools** in the left navigation bar, and then click **Uninstall**.

Follow the instructions in the dialog box to uninstall the software and drivers.



Related Information

- [Access Brother Utilities \(Windows®\)](#)

Paper Handling

- [Load Paper](#)
- [Load Documents](#)

Load Paper

- [Load Paper in the Paper Tray](#)
- [Load Photo or Photo L Paper in Photo Paper Tray](#)
- [Load Paper in the Manual Feed Slot](#)
- [Unprintable Area](#)
- [Paper Settings](#)
- [Acceptable Paper and Other Print Media](#)
- [Error and Maintenance Messages](#)
- [Paper Handling and Printing Problems](#)

Load Paper in the Paper Tray

- [Load Cut-Sheet Paper or Photo 2L Paper in the Paper Tray](#)
- [Load Photo Paper in the Paper Tray](#)
- [Load Envelopes in the Paper Tray](#)

Load Cut-Sheet Paper or Photo 2L Paper in the Paper Tray

- If the [Check Paper] setting is set to [On] and you pull the paper tray out of the machine, a message appears on the LCD asking if you want to change the paper type and paper size. Change the Paper Size and Paper Type settings if needed, following the on-screen instructions.
- Load only one size and type of paper in the paper tray at a time.
- When you load a different paper size in the tray, you must change the Paper Size setting in the machine or the paper size setting on your computer.

1. If the paper support flap (1) is open, close it, and then close the paper support (2).

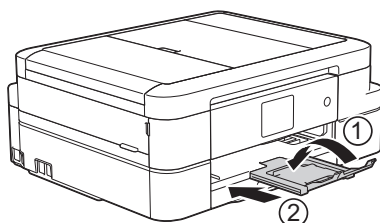

2. Pull the paper tray completely out of the machine.

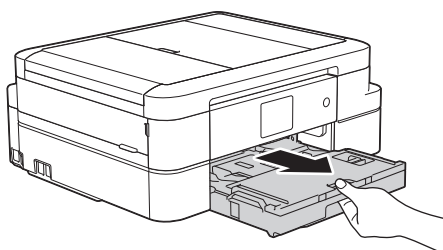

3. Open the output paper tray cover (1).

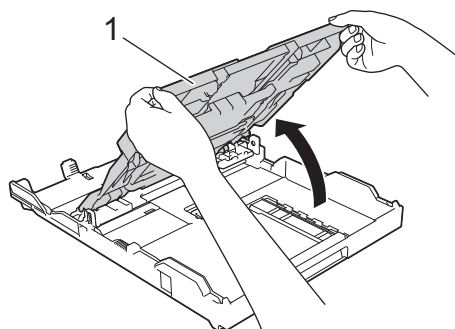

4. Gently press and slide the paper width guides (1) and then the paper length guide (2) to fit the paper size.

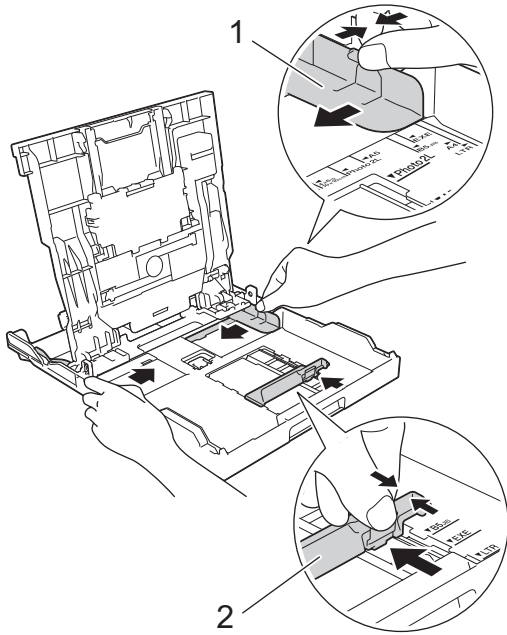

5. Fan the stack of paper well to avoid paper jams and misfeeds.

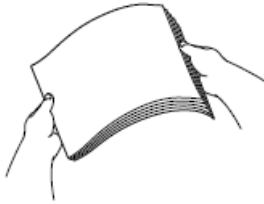

 Always make sure the paper is not curled or wrinkled.

6. Gently load paper in the paper tray with the printing surface **face down**.

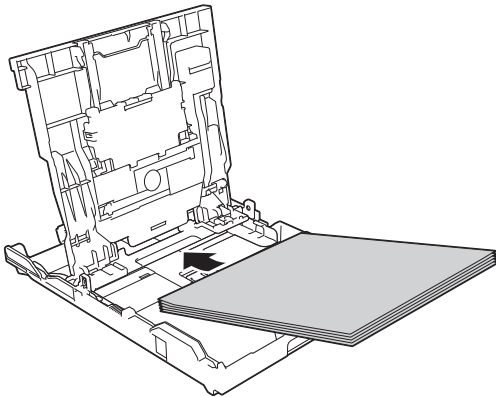

Make sure the paper is flat in the tray and the paper length guide (1) touches the edges of the paper.

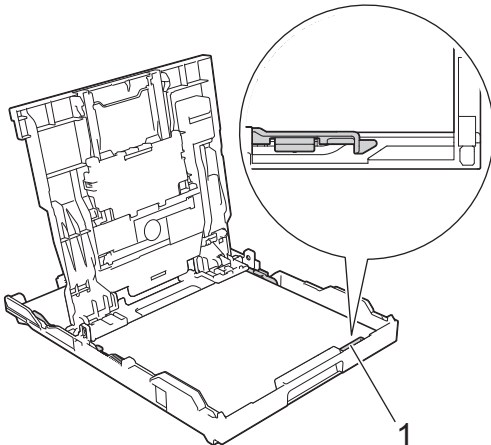

IMPORTANT

- Be careful not to push the paper in too far; it may lift at the back of the tray and cause paper feed problems.
- Loading more than 20 sheets of Photo 2L (13 x 18 cm) paper may cause paper jams.



To add paper before the tray is empty, remove the paper from the tray and combine it with the paper you are adding. Always fan the stack of paper well to prevent the machine from feeding multiple pages.

7. Gently adjust the paper width guides (1) to fit the paper.
Make sure the paper guides touch the edges of the paper.

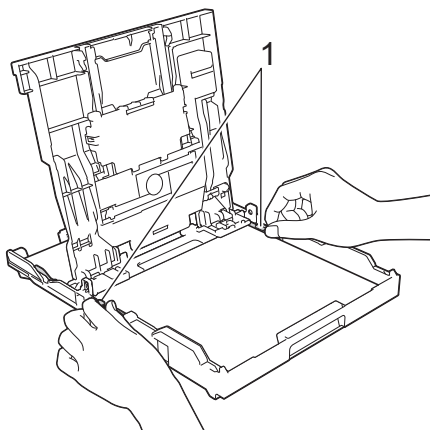

8. Close the output paper tray cover.

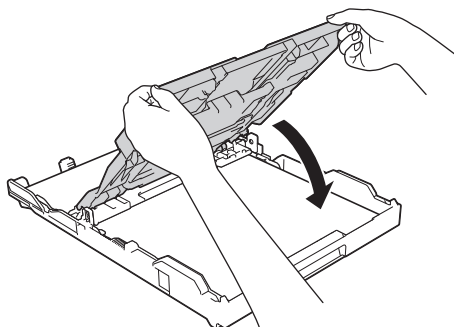

9. Slowly push the paper tray completely into the machine.

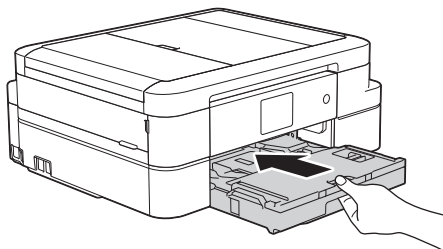

10. While holding the paper tray in the machine, pull out the paper support (1) until it locks into place, and then unfold the paper support flap (2).

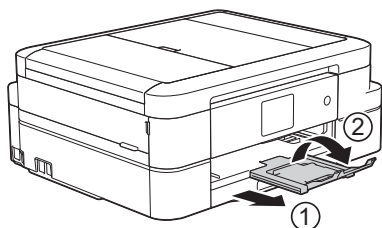



Related Information

- [Load Paper in the Paper Tray](#)
 - [Change the Check Paper Size Setting](#)
 - [Choose the Right Print Media](#)
 - [Change the Paper Size and Paper Type](#)
-

Load Photo Paper in the Paper Tray

- If the [Check Paper] setting is set to [On] and you pull the paper tray out of the machine, a message appears on the LCD asking if you want to change the paper type and paper size. Change the Paper Size and Paper Type settings if needed, following the on-screen instructions.
- Load only one size and type of paper in the paper tray at a time.
- When you load a different paper size in the tray, you must change the Paper Size setting in the machine or the paper size setting on your computer.

1. If the paper support flap (1) is open, close it, and then close the paper support (2).

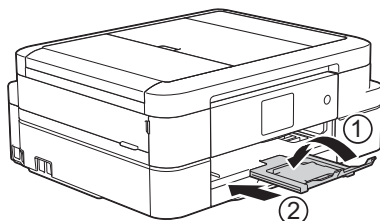

2. Pull the paper tray completely out of the machine.

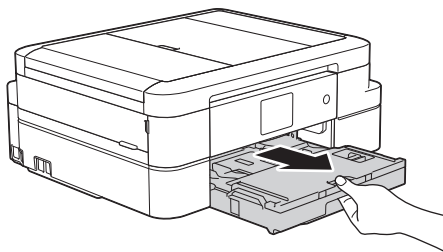

3. Open the output paper tray cover (1).

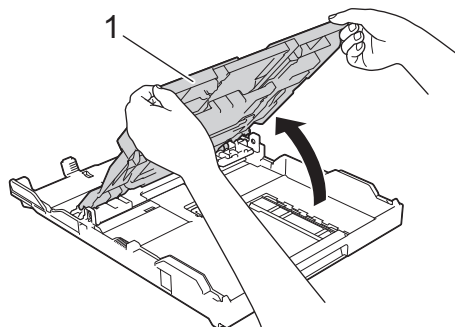

4. Gently press and slide the paper width guides (1) to fit the paper size, and then lift up the stopper (2).

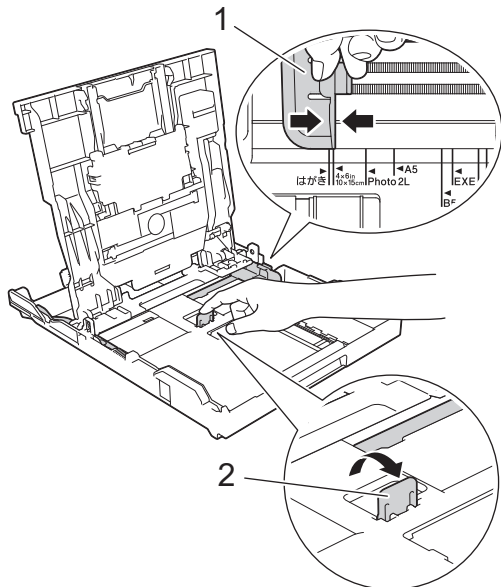

5. Close the output paper tray cover.

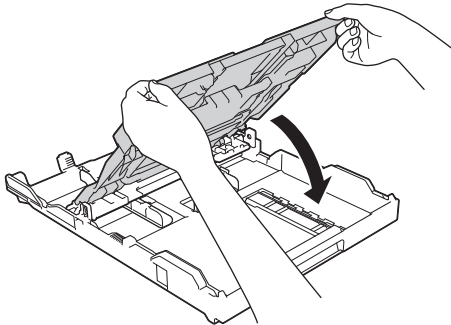

6. Load up to 20 sheets of Photo paper with the printing surface **face down**.
Loading more than 20 sheets of photo paper may cause paper jams.

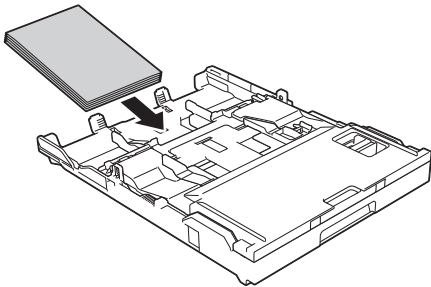

7. Gently adjust the paper guides (1) to fit the paper.
Make sure the paper width guides touch the edges of the paper and the paper is flat in the tray.

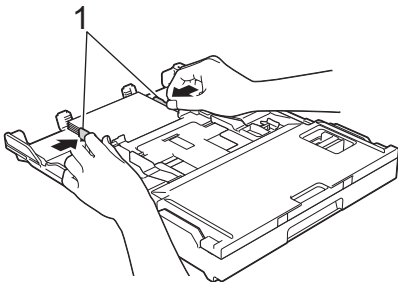

8. Slowly push the paper tray completely into the machine.

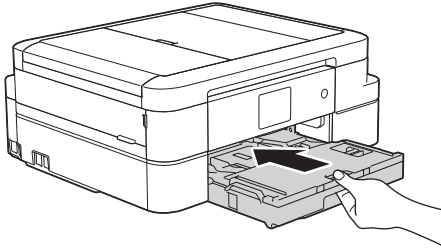

9. While holding the paper tray in the machine, pull out the paper support (1) until it locks into place, and then unfold the paper support flap (2).

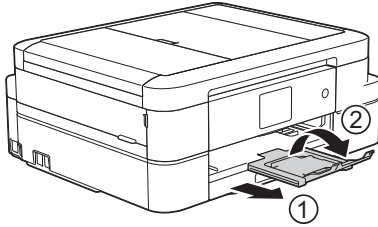

Related Information

- [Load Paper in the Paper Tray](#)
 - [Change the Check Paper Size Setting](#)
 - [Choose the Right Print Media](#)
 - [Change the Paper Size and Paper Type](#)
-

Load Envelopes in the Paper Tray

- If the [Check Paper] setting is set to [On] and you pull the paper tray out of the machine, a message appears on the LCD asking if you want to change the paper type and paper size. Change the Paper Size and Paper Type settings if needed, following the on-screen instructions.
- Load only one size and type of paper in the paper tray at a time.
- When you load a different paper size in the tray, you must change the Paper Size setting in the machine or the paper size setting on your computer.
- Before loading envelopes in the tray, press the corners and sides of the envelopes to make them as flat as possible.

See *Related Information*.

1. If the paper support flap (1) is open, close it, and then close the paper support (2).

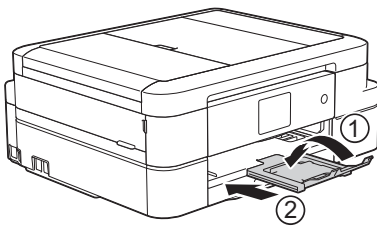

2. Pull the paper tray completely out of the machine.

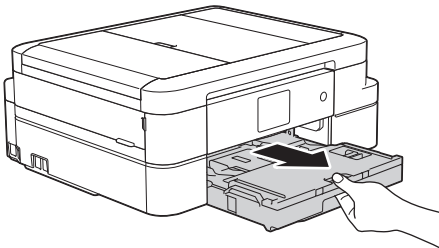

3. Open the output paper tray cover (1).

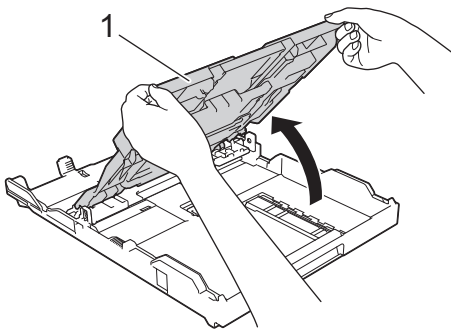

4. Load up to 10 envelopes in the paper tray with the printing surface **face down**. Loading more than 10 envelopes may cause paper jams.

If the envelope flaps are on the long edge, load the envelopes with the flap on the left, as shown in the illustration. Gently press and slide the paper width guides (1) and paper length guide (2) to fit the size of the envelopes.

Make sure the envelopes are flat in the tray.

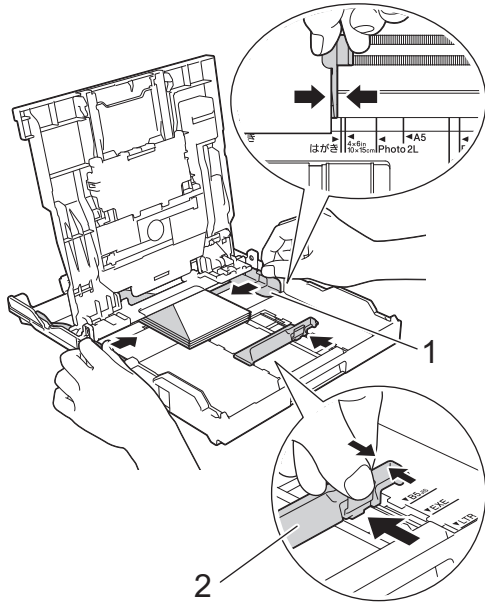

IMPORTANT

If envelopes are "double-feeding," load one envelope in the paper tray at a time.

- Close the output paper tray cover.

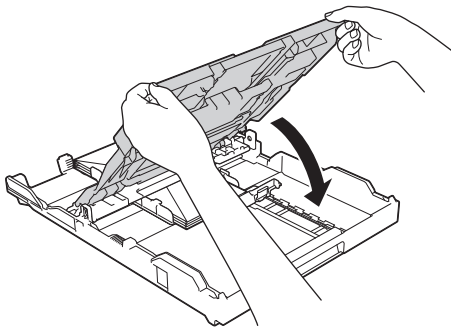

- Slowly push the paper tray completely into the machine.

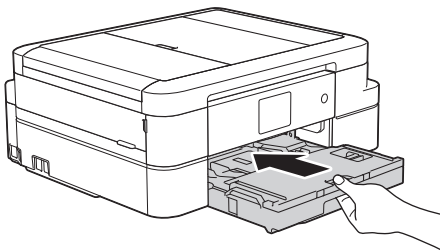

- While holding the paper tray in the machine, pull out the paper support (1) until it locks into place, and then unfold the paper support flap (2).

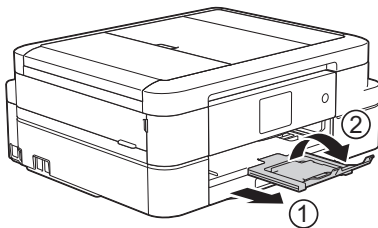

Related Information

- [Load Paper in the Paper Tray](#)
- [About Envelopes](#)
- [Change the Check Paper Size Setting](#)

-
- Choose the Right Print Media
 - Change the Paper Size and Paper Type
-

Load Photo or Photo L Paper in Photo Paper Tray

Use the photo paper tray, which is located on the top of the output paper tray cover, to print on Photo (10 x 15 cm) or Photo L (89 x 127 mm) size paper.



- When you use the photo paper tray, you do not have to remove the paper from the tray beneath it.

- If the [Check Paper] setting is set to [On] and you pull the paper tray out of the machine, a message appears on the LCD asking if you want to change the paper type and paper size. Change the Paper Size and Paper Type settings if needed, following the on-screen instructions.
- Load only one size and type of paper in the paper tray at a time.
- When you load a different paper size in the tray, you must change the Paper Size setting in the machine or the paper size setting on your computer.

- If the paper support flap (1) is open, close it, and then close the paper support (2).

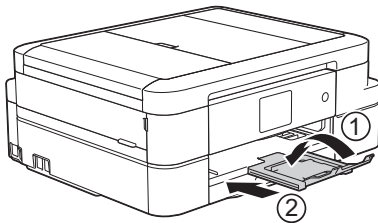

- Pull the paper tray completely out of the machine.

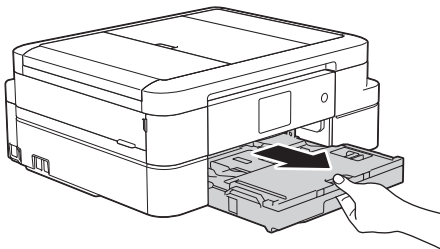

- Press the blue photo paper tray release button (1) and slide the whole output paper tray cover forward until it locks into the photo printing position (2).

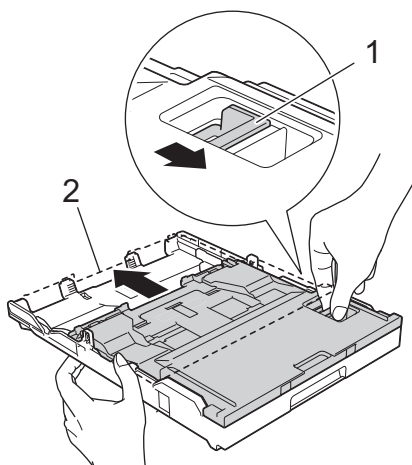

- Load up to 20 sheets of Photo or Photo L paper in the photo paper tray with the printing surface **face down**. Loading more than 20 sheets of photo paper may cause paper jams.

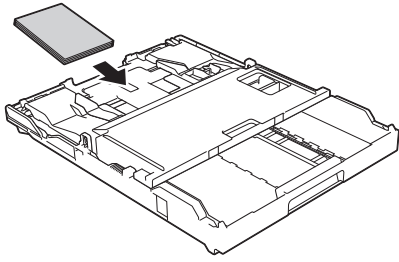

5. Gently adjust the paper width guides (1) to fit the paper. Make sure the paper width guides touch the edges of the paper and the paper is flat in the tray.

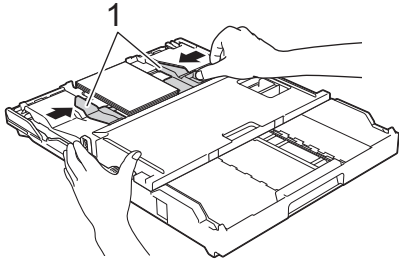

6. Slowly push the paper tray completely into the machine.

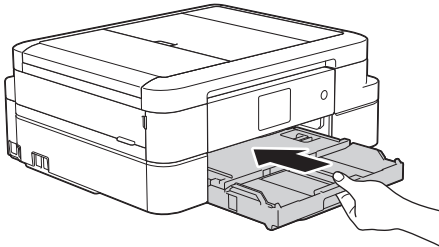

Do not open the paper support and the paper support flap when using the photo paper tray. Otherwise it is difficult to take out the printouts.

IMPORTANT

When you have finished printing photos, return the photo paper tray to the Normal printing position. If you do not, you will get a [No Paper Fed] error when you use cut sheet paper.

Photo Paper Tray in the Normal printing position

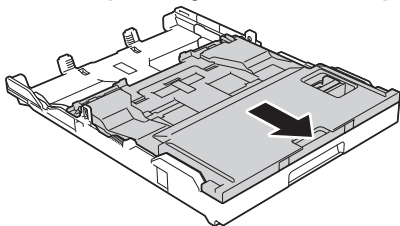
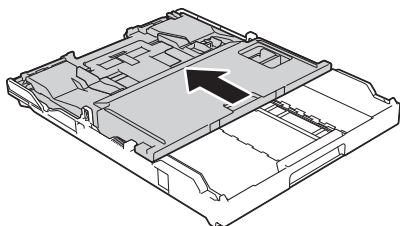

Photo Paper Tray in the Photo printing position



Related Information

- [Load Paper](#)
- [Error and Maintenance Messages](#)

Load Paper in the Manual Feed Slot

Load special print media in this slot one sheet at a time.



The machine automatically turns on Manual Feed mode when you put paper in the manual feed slot.

1. Open the manual feed slot cover.

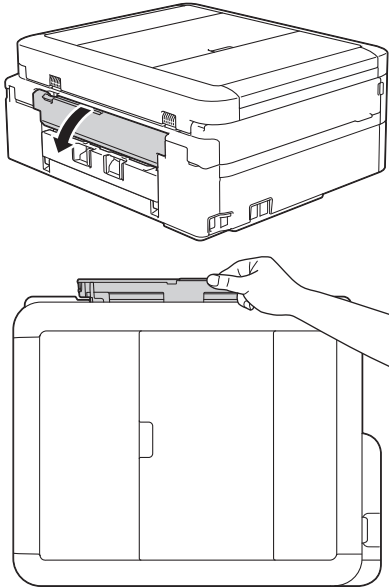

2. Lift up the paper support.

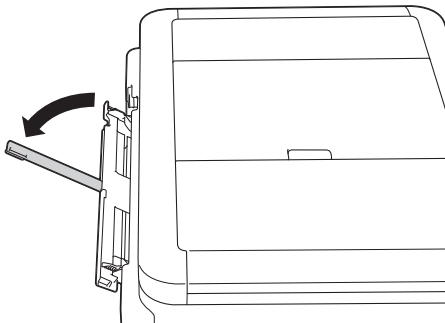

3. Slide the manual feed slot paper guides to fit the width of the paper you are using.

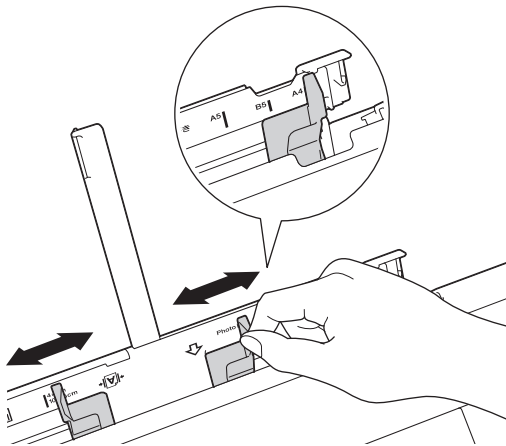

4. Load only one sheet of paper in the manual feed slot with the printing surface **face up**.

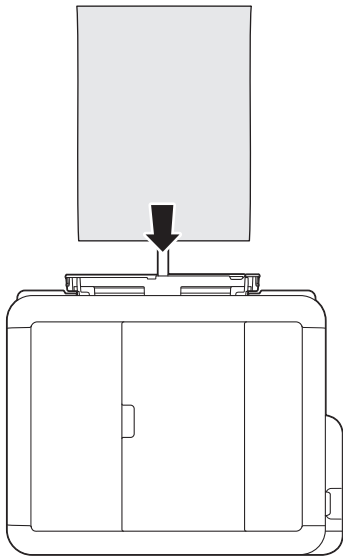
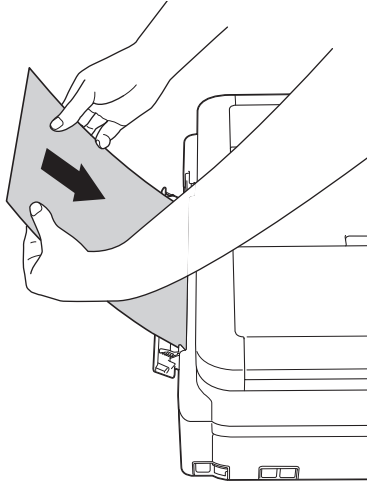

When using envelopes, load the envelopes with the printing surface **face up** and the flap on the left as shown in the illustration.

See *Related Information*.

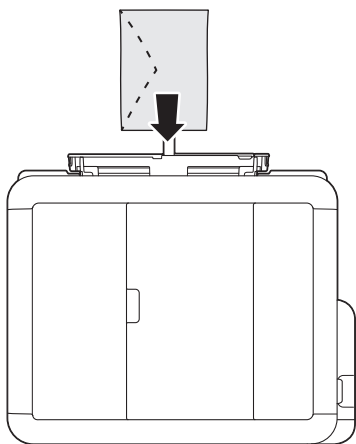

IMPORTANT

- DO NOT load more than one sheet of paper in the manual feed slot at any time. Doing this may cause a paper jam. When printing multiple pages, do not feed the next sheet of paper until the Touchscreen displays a message instructing you to feed the next sheet.

- DO NOT load paper in the manual feed slot when you are printing from the paper tray. Doing this may cause a paper jam.

5. Using both hands, push one sheet of paper into the manual feed slot until the front edge touches the paper feed rollers. Let go of the paper when you hear the machine pull it. The LCD displays [Manual Feed Slot ready.]. Read the instruction displayed on the LCD, and then press [OK].

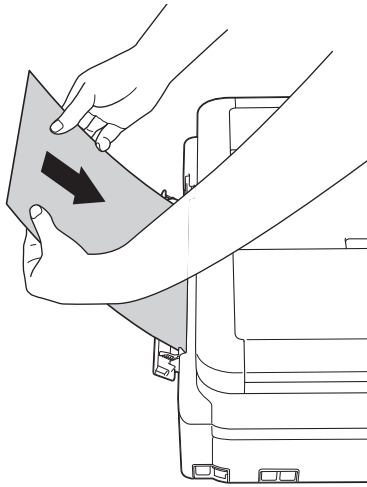

When loading an envelope, or a sheet of thick paper, push the envelope into the manual feed slot until you feel the paper feed rollers grab it.

6. While holding the paper tray in the machine, pull out the paper support (1) until it locks into place, and then unfold the paper support flap (2).

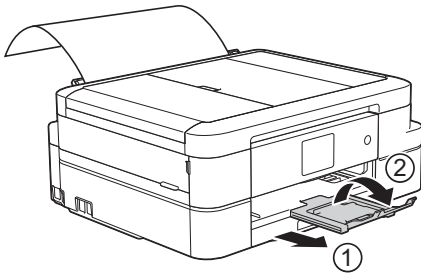

- If the document does not fit on one sheet, the machine will prompt you to load another sheet of paper. Place another sheet of paper in the manual feed slot, and then press [OK] on the touchscreen.
- Make sure printing has finished before you close the manual feed slot cover.
- When paper is placed in the manual feed slot, the machine always prints from the manual feed slot.
- The machine will eject paper loaded in the manual feed slot while a test page, fax, or report is being printed.
- The machine will eject paper loaded in the manual feed slot during the machine's cleaning process. Wait until the machine finishes its cleaning, and then load paper in the manual feed slot.



Related Information

- [Load Paper](#)
- [About Envelopes](#)
- [Choose the Right Print Media](#)
- [Error and Maintenance Messages](#)

Unprintable Area

The unprintable area depends on the settings in the application you are using. The figures below show the unprintable areas on cut-sheet paper and envelopes. The machine can print in the shaded areas of cut-sheet paper only when the Borderless print feature is available and turned on.

Cut-Sheet Paper

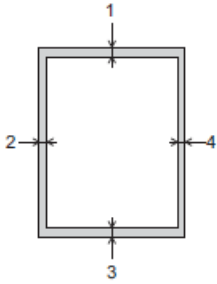

Envelopes

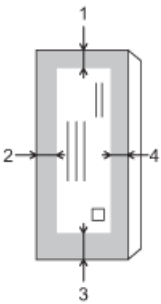

	Top (1)	Left (2)	Bottom (3)	Right (4)
Cut-Sheet	3 mm	3 mm	3 mm	3 mm
Envelopes	12 mm	3 mm	12 mm	3 mm



The Borderless print feature is not available for envelopes and 2-sided printing.



Related Information



- [Load Paper](#)
- [Paper Handling and Printing Problems](#)

Paper Settings

- [Change the Paper Size and Paper Type](#)
- [Change the Check Paper Size Setting](#)
- [Shrink Page Size of an Oversized Incoming Fax](#)

Change the Paper Size and Paper Type

Set the Paper Size and Paper Type settings for the paper tray.

- To get the best print quality, set the machine for the type of paper you are using.
 - When you change the size of the paper you load in the tray, you must change the Paper Size setting on the LCD at the same time.
1. Do one of the following:
 - (DCP-J785DW)
Press  [Settings] > [Paper Type].
 - (MFC-J985DW)
Press  [Settings] > [Tray Setting] > [Paper Type].
 2. Press ▲ or ▼ to display the [Plain Paper], [Inkjet Paper], [Brother BP71] or [Other Glossy] option, and then press the option you want.
 3. Press [Paper Size].
 4. Press ▲ or ▼ to display the paper size options, and then press the option you want.
 5. Press .



The machine ejects paper with the printed surface face up onto the paper tray at the front of the machine. When you use glossy paper, remove each sheet at once to prevent smudging or paper jams.





Related Information

- [Paper Settings](#)
- [Load Cut-Sheet Paper or Photo 2L Paper in the Paper Tray](#)
- [Load Photo Paper in the Paper Tray](#)
- [Load Envelopes in the Paper Tray](#)
- [Acceptable Paper and Other Print Media](#)
- [Error and Maintenance Messages](#)
- [Paper Handling and Printing Problems](#)

Change the Check Paper Size Setting

If the Check Paper setting is set to [On] and you pull the paper tray out of the machine, the LCD displays a message asking if you want to change the Paper Size and Paper Type settings.

The default setting is [On].

1. Press  [Settings] > [All Settings] > [General Setup] > [Check Paper].
2. Press [On] or [Off].
3. Press .

Related Information

- [Paper Settings](#)
- [Load Cut-Sheet Paper or Photo 2L Paper in the Paper Tray](#)
- [Load Photo Paper in the Paper Tray](#)
- [Load Envelopes in the Paper Tray](#)
- [Error and Maintenance Messages](#)

Acceptable Paper and Other Print Media

The print quality can be affected by the type of paper you use in the machine.

To get the best print quality for the settings you have chosen, always set the Paper Type to match the type of paper you load.

You can use plain paper, inkjet paper (coated paper), glossy paper, recycled paper and envelopes.

We recommend testing various paper types before buying large quantities.

For best results, use Brother paper.

- When you print on inkjet paper (coated paper) and glossy paper, be sure to choose the proper print media in the **Basic** tab of the printer driver or in the Paper Type setting on the machine.
- When you print on Brother Photo paper, load one extra sheet of the same photo paper in the paper tray.
- When using photo paper, remove each sheet at once to prevent smudging or paper jams.
- Avoid touching the printed surface of the paper immediately after printing; the surface may not be completely dry and may stain your fingers.



Related Information

- [Load Paper](#)
 - [Recommended Print Media](#)
 - [Handle and Use Print Media](#)
 - [About Envelopes](#)
 - [Choose the Right Print Media](#)
 - [Change the Paper Size and Paper Type](#)
 - [Paper Handling and Printing Problems](#)
-

Recommended Print Media

For the best print quality, we recommend using the Brother paper listed in the table.

If Brother paper is not available in your country, we recommend testing various paper types before purchasing large quantities.

Brother paper

Paper Type	Item
A4 Plain	BP60PA
A4 Glossy Photo	BP71GA4
A4 Inkjet (Matte)	BP60MA
10 x 15 cm Glossy Photo	BP71GP



Related Information

- [Acceptable Paper and Other Print Media](#)

Handle and Use Print Media

- Store paper in its original packaging and keep it sealed. Keep the paper flat and away from moisture, direct sunlight and heat.
- Avoid touching the shiny (coated) side of photo paper.

IMPORTANT

DO NOT use the following kinds of paper:

- Damaged, curled, wrinkled, or irregularly shaped

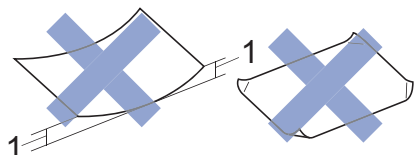

1. **2 mm or greater curl may cause jams to occur.**

- Extremely shiny or highly textured
- Paper that cannot be arranged uniformly when stacked
- Paper made with a short grain

Paper capacity of the output paper tray cover

Up to 50 sheets of A4 80 g/m² paper.

- Photo paper must be picked up from the output paper tray cover one page at a time to avoid smudging.



Related Information

- [Acceptable Paper and Other Print Media](#)

About Envelopes

- Use envelopes that weigh from 80 to 95 g/m².
- Some envelope sizes require that you set margins in the application. Make sure you do a test print first before printing many envelopes.

IMPORTANT

DO NOT use envelopes that:

- Are loosely constructed
- Have windows
- Are embossed (have raised writing on them)
- Have clasps or staples
- Are pre-printed on the inside
- Are self-adhesive
- Have double flaps

Self-adhesive Double flaps

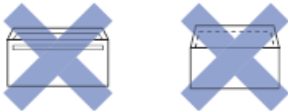

You may experience paper feed problems caused by the thickness, size and flap shape of the envelopes you are using.

- Before loading envelopes in the tray, press the flaps, edges and corners to make them as flat as possible, as shown in the illustrations.

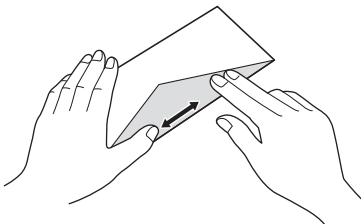
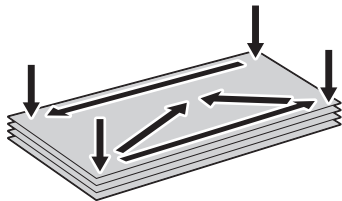

Fan the stack of envelopes well to avoid paper jams and misfeeds.



IMPORTANT

If envelopes are "double-feeding," load one envelope in the paper tray at a time.



Related Information

- [Acceptable Paper and Other Print Media](#)

-
- Load Envelopes in the Paper Tray
 - Load Paper in the Manual Feed Slot
-

Choose the Right Print Media

- Paper Type and Paper Size for Each Operation
- Paper Capacity of the Paper Trays
- Paper Weight and Thickness
- Load Cut-Sheet Paper or Photo 2L Paper in the Paper Tray
- Load Photo Paper in the Paper Tray
- Load Envelopes in the Paper Tray
- Load Paper in the Manual Feed Slot

Paper Type and Paper Size for Each Operation

Paper Type	Paper Size		Usage			
			Fax ¹	Copy	Photo Capture	Printer
Cut-Sheet	A4	210 x 297 mm	Yes	Yes	Yes	Yes
	Letter	215.9 x 279.4 mm	Yes	Yes	Yes	Yes
	Executive	184.1 x 266.7 mm	-	-	-	Yes
	A5	148 x 210 mm	-	Yes	-	Yes
	A6	105 x 148 mm	-	-	-	Yes
Cards	Photo	10 x 15 cm	-	Yes	Yes	Yes
	Photo L	9 x 13 cm	-	-	-	Yes
	Photo 2L	13 x 18 cm	-	-	Yes	Yes
	Index Card	13 x 20 cm	-	-	-	Yes
Envelopes	C5 Envelope	162 x 229 mm	-	-	-	Yes
	DL Envelope	110 x 220 mm	-	-	-	Yes
	Com-10	104.7 x 241.3 mm	-	-	-	Yes
	Monarch	98.4 x 190.5 mm	-	-	-	Yes

¹ MFC models only



Related Information

- [Choose the Right Print Media](#)

Paper Capacity of the Paper Trays

	Paper Size	Paper Types	No. of sheets
Paper Tray	A4, Executive, Letter, A5, A6, Envelopes (Com-10, DL, C5, Monarch), Photo (10 x 15 cm), Photo 2L (13 x 18 cm) and Index Card (127 x 203 mm)	Plain Paper, Recycled Paper	100 ¹
		Inkjet Paper	20
		Glossy Paper, Photo	20
		Index Card	30
		Envelopes	10
Photo Paper Tray	Photo (10 x 15 cm) and Photo L (89 x 127 mm)	Plain Paper, Inkjet Paper, Glossy Paper, Recycled Paper and Photo	20
Manual Feed Slot	A4, Executive, Letter, A5, A6, Envelopes (Com-10, DL, C5, Monarch), Photo (10 x 15 cm), Photo L (89 x 127 mm), Photo 2L (13 x 18 cm) and Index Card (127 x 203 mm)	Plain Paper, Inkjet Paper, Glossy Paper, Recycled Paper, Photo and Envelopes	1

¹ When using plain paper 80 g/m²



Related Information

- [Choose the Right Print Media](#)

Paper Weight and Thickness

Paper Type		Weight	Thickness
Cut-Sheet	Plain Paper ¹ , Recycled Paper ¹	64 to 120 g/m ²	0.08 to 0.15 mm
	Inkjet Paper	64 to 200 g/m ²	0.08 to 0.25 mm
	Glossy Paper ²	Up to 220 g/m ²	Up to 0.25 mm
Cards	Photo Card ²	Up to 220 g/m ²	Up to 0.25 mm
	Index Card	Up to 120 g/m ²	Up to 0.15 mm
Envelopes		80 to 95 g/m ²	Up to 0.52 mm

¹ Paper Weight and Thickness for automatic 2-sided printing is 64 to 105 g/m² and 0.08 to 0.13 mm.

² BP71 260 g/m² paper is specially designed for Brother inkjet machines.



Related Information

- [Choose the Right Print Media](#)
- [Paper Handling and Printing Problems](#)

Load Documents

- [Load Documents in the Automatic Document Feeder \(ADF\)](#)
- [Load Documents on the Scanner Glass](#)
- [Unscannable Area](#)

Load Documents in the Automatic Document Feeder (ADF)

The ADF can hold up to 20 pages, and feeds each sheet individually.

Documents that are longer than 297 mm must be fed one page at a time.

Use paper that is within the sizes and weights shown in the table. Always fan the pages before placing them in the ADF.

Document Sizes and Weights

Length	148 to 355.6 mm
Width	148 to 215.9 mm
Paper Weight	64 to 90 g/m ²

IMPORTANT

- DO NOT pull on the document while it is feeding.
- DO NOT use paper that is curled, wrinkled, folded, ripped, stapled, paper clipped, pasted or taped.
- DO NOT use cardboard, newspaper or fabric.
- Make sure documents with correction fluid or written in ink are completely dry.

1. Lift up and unfold the ADF document support (1).

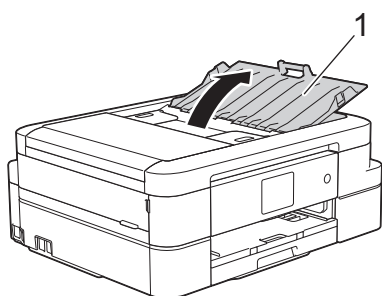

2. Fan the pages well.
3. Adjust the paper guides (1) to fit the width of your document.

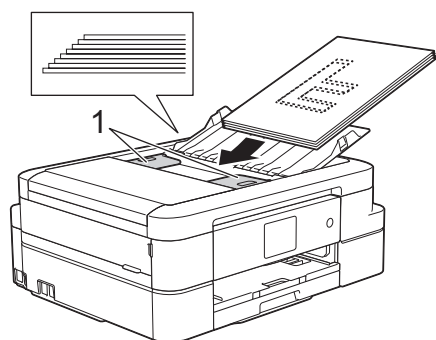

4. Place your document, **face down, top edge first** in the ADF underneath the paper guides until you feel the document touch the feed rollers and the LCD displays [ADF Ready.].

IMPORTANT

DO NOT leave any documents on the scanner glass. If you do this, the ADF may jam.

✓ Related Information

- [Load Documents](#)

-
- Copy a Document
 - Error and Maintenance Messages
 - Telephone and Fax problems
 - Other Problems
-

Load Documents on the Scanner Glass

Use the scanner glass to fax, copy, or scan one page at a time.

Document Sizes Supported

Length:	Up to 297 mm
Width:	Up to 215.9 mm
Weight:	Up to 2 kg



(ADF models)

To use the scanner glass, the ADF must be empty and the ADF document support must be closed.

1. Lift the document cover.
2. Place the document **face down** in the upper left corner of the scanner glass, aligned with the arrow.

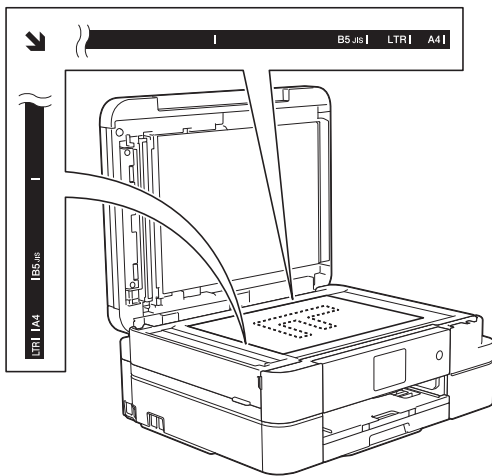

3. Close the document cover.

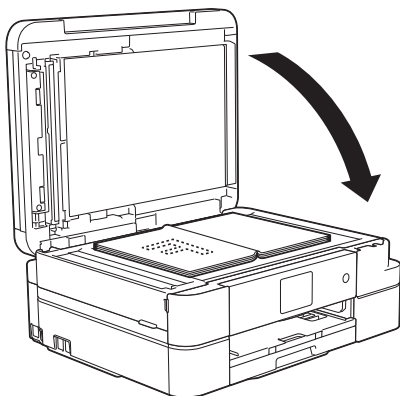

IMPORTANT

If you are scanning a book or thick document, DO NOT slam or press on the document cover.



Related Information

- [Load Documents](#)
- [Copy a Document](#)
- [Telephone and Fax problems](#)

-
- Other Problems
-

Unscannable Area

The unscannable area of a page depends on the settings in the application you are using. The figures below show the typical unscannable measurements.

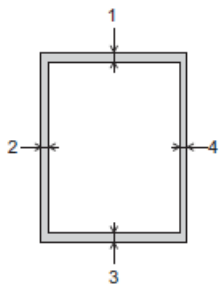

Usage	Document Size	Top (1) Bottom (3)	Left (2) Right (4)
Fax	A4	3 mm	3 mm ¹
	Letter		4 mm
	Legal		
Copy	All paper sizes		3 mm
Scan		1 mm	1 mm

¹ The unscannable area is 1 mm when using the ADF.



Related Information

- [Load Documents](#)

Print

- [Print from Your Computer \(Windows®\)](#)
- [Print from Your Computer \(Mac\)](#)

Print from Your Computer (Windows®)

- [Print a Photo \(Windows®\)](#)
- [Print a Document \(Windows®\)](#)
- [Cancel a Print Job \(Windows®\)](#)
- [Print More Than One Page on a Single Sheet of Paper \(N in 1\) \(Windows®\)](#)
- [Print as a Poster \(Windows®\)](#)
- [Print on Both Sides of the Paper Automatically \(Automatic 2-sided Printing\) \(Windows®\)](#)
- [Print as a Booklet Automatically \(Windows®\)](#)
- [Print a Colour Document in Greyscale \(Windows®\)](#)
- [Prevent Smudged Printouts and Paper Jams When Printing on Both Sides of the Paper \(Windows®\)](#)
- [Use a Preset Print Profile \(Windows®\)](#)
- [Change the Default Print Settings \(Windows®\)](#)
- [Print Settings \(Windows®\)](#)

Print a Photo (Windows®)



1. Select the print command in your application.
2. Select **Brother MFC-XXXX Printer** (where XXXX is the name of your model), and then click the printing properties or preferences button.
The printer driver window appears.
3. Make sure you have loaded the correct media in the paper tray.

IMPORTANT

- We recommend using the photo paper tray located on the top of the output tray cover to print on Photo (10 x 15 cm) and Photo L (9 x 13 cm) paper. (available only for certain models)
- For best results, use Brother paper.
- When you print on Brother photo paper, load one extra sheet of the same photo paper in the paper tray.

4. Click the **Media Type** drop-down list, and then select the type of paper you are using.

IMPORTANT

To get the best print quality for the settings you have selected, always set the **Media Type** option to match the type of paper you load.

5. Click the **Paper Size** drop-down list, and then select your paper size.
6. Select the **Borderless** check box, if needed.
7. For **Colour Mode**, select **Natural**.
8. In the **Orientation** field, select either the **Portrait** or **Landscape** option to set the orientation of your printout.



If your application software contains a similar layout feature, we recommend using the one in the application.

9. Type the number of copies (1-999) you want in the **Copies** field.
10. Change other printer settings if needed.
11. Click **OK**.
12. Complete your print operation.



Related Information

- [Print from Your Computer \(Windows®\)](#)
- [Print Settings \(Windows®\)](#)

Print a Document (Windows®)

1. Select the print command in your application.
2. Select **Brother MFC-XXXX Printer** (where XXXX is the name of your model), and then click the printing properties or preferences button.
The printer driver window appears.
3. Make sure you have loaded the correct size paper in the paper tray.
4. Click the **Media Type** drop-down list, and then select the type of paper you are using.

IMPORTANT

To get the best print quality for the settings you have selected, always set the **Media Type** option to match the type of paper you load.

5. Click the **Paper Size** drop-down list, and then select your paper size.
6. For **Colour Mode**, select the **Natural** or **Vivid** option.
7. In the **Orientation** field, select either the **Portrait** or **Landscape** option to set the orientation of your printout.



If your application software contains a similar layout feature, we recommend using the one in the application.

8. Type the number of copies (1-999) you want in the **Copies** field.
9. To print multiple pages on a single sheet of paper or print one page of your document on multiple sheets, click the **Multiple Page** drop-down list, and then select your options.
10. Change other printer settings if needed.
11. Click **OK**.
12. Complete your print operation.



Related Information

- [Print from Your Computer \(Windows®\)](#)
- [Check the Ink Volume](#)
- [Print Settings \(Windows®\)](#)

Cancel a Print Job (Windows®)

If a print job was sent to the print queue and did not print, or was sent to the print queue in error, you may have to delete it to allow subsequent jobs to print.

1. Double-click the printer icon  in the task tray.
2. Select the print job you want to cancel.
3. Click the **Document** menu.
4. Select **Cancel**.
5. Click **Yes**.



Related Information

- [Print from Your Computer \(Windows®\)](#)
 - [Monitor Machine Status from Your Computer \(Windows®\)](#)
-

Print More Than One Page on a Single Sheet of Paper (N in 1) (Windows®)



1. Select the print command in your application.
2. Select **Brother MFC-XXXX Printer** (where XXXX is the name of your model), and then click the printing properties or preferences button.
The printer driver window appears.
3. In the **Orientation** field, select either the **Portrait** or **Landscape** option to set the orientation of your printout.



If your application software contains a similar layout feature, we recommend using the one in the application.

4. Click the **Multiple Page** drop-down list, and then select the **2 in 1**, **4 in 1**, **9 in 1**, or **16 in 1** option.
5. Click the **Page Order** drop-down list, and then select your page order.
6. Click the **Border Line** drop-down list, and then select your border line type.
7. Change other printer settings if needed.
8. Click **OK**, and then complete your print operation.



Related Information

- [Print from Your Computer \(Windows®\)](#)
 - [Print Settings \(Windows®\)](#)
-

Print as a Poster (Windows®)

Enlarge your print size and print the document in poster mode.

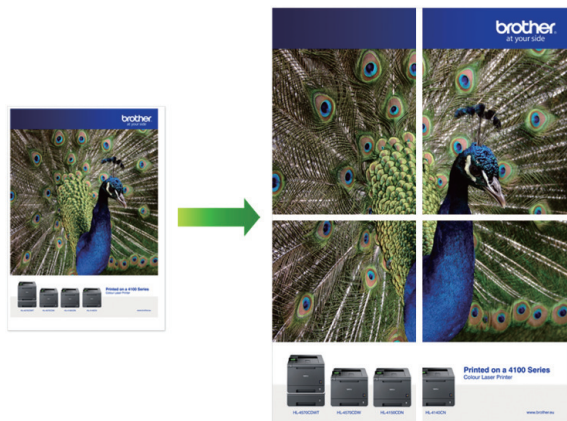

1. Select the print command in your application.
2. Select **Brother MFC-XXXX Printer** (where XXXX is the name of your model), and then click the printing properties or preferences button.
The printer driver window appears.
3. Click the **Multiple Page** drop-down list, and then select the **1 in 2x2 Pages** or **1 in 3x3 Pages** option.
4. Change other printer settings if needed.
5. Click **OK**.
6. Complete your print operation.

✓ Related Information

- [Print from Your Computer \(Windows®\)](#)
- [Print Settings \(Windows®\)](#)

Print on Both Sides of the Paper Automatically (Automatic 2-sided Printing) (Windows®)

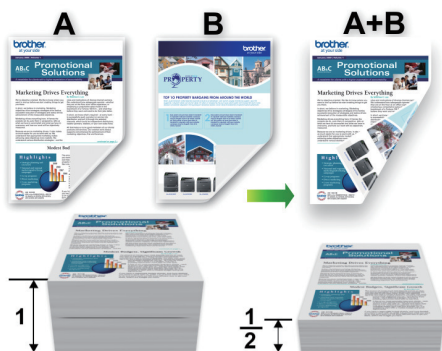

- Make sure the back cover is closed.
- If paper is curled, straighten it and put it back in the paper tray.
- Use regular paper or thin paper. DO NOT use bond paper.
- If the paper is thin, it may wrinkle.

1. Select the print command in your application.
2. Select **Brother MFC-XXXX Printer** (where XXXX is the name of your model), and then click the printing properties or preferences button.
The printer driver window appears.
3. In the **Orientation** field, select either the **Portrait** or **Landscape** option to set the orientation of your printout.



If your application software contains a similar layout feature, we recommend using the one in the application.

4. Click the **2-sided / Booklet** drop-down list, and then select **2-sided**.
5. Click the **2-sided Settings** button.
6. Select one of the options from the **2-sided Type** menu.

When 2-sided is selected, four types of 2-sided binding are available for each orientation:

Option for Portrait	Description
Long Edge (Left)	
Long Edge (Right)	

Option for Portrait	Description
---------------------	-------------

Short Edge (Top)

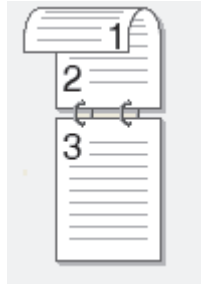

Short Edge (Bottom)

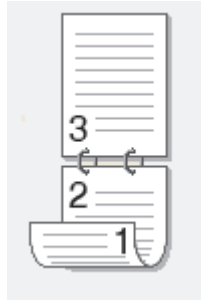

Option for Landscape	Description
----------------------	-------------

Long Edge (Top)



Long Edge (Bottom)



Short Edge (Right)

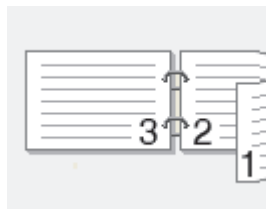

Short Edge (Left)

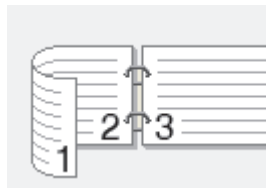

7. Select the **Binding Offset** check box if you want to specify the offset for binding in inches or millimetres.
8. Click **OK** to return to the printer driver window.
9. Change other printer settings if needed.



The Borderless feature is not available when using this option.

10. Click **OK** again, and then complete your print operation.



Related Information

- [Print from Your Computer \(Windows®\)](#)
- [Print Settings \(Windows®\)](#)
- [Print as a Booklet Automatically \(Windows®\)](#)

Print as a Booklet Automatically (Windows®)

Use this option to print a document in booklet format using 2-sided printing. The document's pages will be arranged according to the correct page number and will allow you to fold at the centre of the print output without having to change the order of the printed pages.

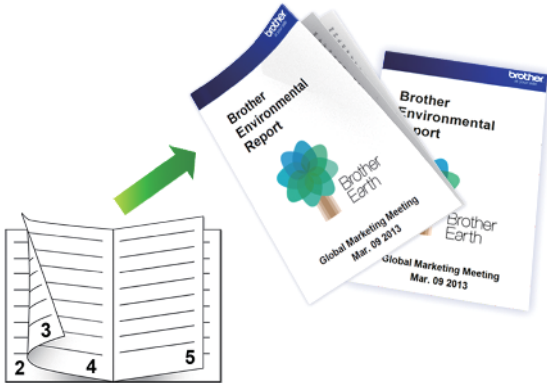

- Make sure the back cover is closed.
- If paper is curled, straighten it and put it back in the paper tray.
- Use regular paper or thin paper. DO NOT use bond paper.
- If the paper is thin, it may wrinkle.

1. Select the print command in your application.
2. Select **Brother MFC-XXXX Printer** (where XXXX is the name of your model), and then click the printing properties or preferences button.
The printer driver window appears.
3. In the **Orientation** field, select either the **Portrait** or **Landscape** option to set the orientation of your printout.



If your application software contains a similar layout feature, we recommend using the one in the application.

4. Click the **2-sided / Booklet** drop-down list, and then select the **Booklet** option.
5. Click the **2-sided Settings** button.
6. Select the one of the options from the **2-sided Type** menu.

There are two types of 2-sided binding directions available for each orientation:

Option for Portrait	Description
Left Binding	
Right Binding	

Option for Landscape	Description
----------------------	-------------

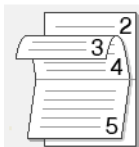

Top Binding

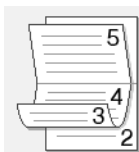

Bottom Binding



7. Select one of the options from the **Booklet Printing Method** menu.

Option	Description
All Pages at Once	Every page will be printed in booklet format (four pages to every piece of paper, two pages per side). Fold your printout in the middle to create the booklet. 
Divide into Sets	This option prints the whole booklet in smaller individual booklet sets, allowing you to fold at the centre of the smaller individual booklet sets without having to change the order of the printed pages. You can specify the number of sheets in each smaller booklet set (from 1-15). This option can be helpful when folding a printed booklet that has a large number of pages. 

8. Select the **Binding Offset** check box if you want to specify the offset for binding in inches or millimetres.

9. Click **OK** to return to the printer driver window.

10. Change other printer settings if needed.



The Borderless feature is not available when using this option.

11. Click **OK**.

12. Complete your print operation.



Related Information

- [Print from Your Computer \(Windows®\)](#)
- [Print Settings \(Windows®\)](#)
- [Print on Both Sides of the Paper Automatically \(Automatic 2-sided Printing\) \(Windows®\)](#)

Print a Colour Document in Greyscale (Windows®)

Greyscale mode makes the print processing speed faster than colour mode. If your document contains colour, selecting Greyscale mode prints your document in 256 levels of greyscale.

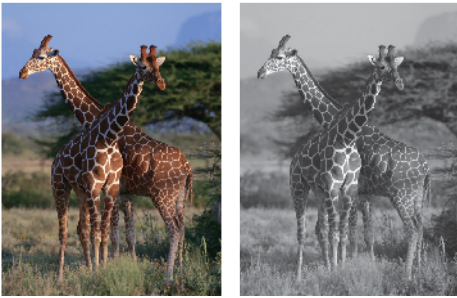

1. Select the print command in your application.
2. Select **Brother MFC-XXXX Printer** (where XXXX is the name of your model), and then click the printing properties or preferences button.
The printer driver window appears.
3. Click the **Advanced** tab.
4. For **Colour / Greyscale**, select **Greyscale**.
5. Change other printer settings if needed.
6. Click **OK**.
7. Complete your print operation.



Related Information

- [Print from Your Computer \(Windows®\)](#)

Prevent Smudged Printouts and Paper Jams When Printing on Both Sides of the Paper (Windows®)

Some types of print media may need more drying time when using the 2-sided feature. Change the **Advanced 2-sided Settings** option if you have problems with smudged 2-sided printouts or paper jams.

1. Select the print command in your application.
2. Select **Brother MFC-XXXX Printer** (where XXXX is the name of your model), and then click the printing properties or preferences button.
The printer driver window appears.
3. Click the **2-sided / Booklet** drop-down list, and then select **2-sided**.
4. Click the **Advanced** tab.
5. Click the **Other Print Options** button.
6. Select the **Advanced 2-sided Settings** option on the left side of the screen.
7. Select one of the following options:

Option	Description
Normal	Select this mode to print at normal speed, using a normal amount of ink.
2-sided 1 (Slower print speed)	Select this mode to print at a slower speed, using a normal amount of ink.
2-sided 2 (Slower print speed & less ink)	Select this mode to print at the same speed as 2-sided 1 (Slower print speed) , but using less ink.

8. Click **OK** to return to the printer driver window.
9. Click **OK**.
10. Complete your print operation.

✓ Related Information

- [Print from Your Computer \(Windows®\)](#)
- [Paper Handling and Printing Problems](#)

Use a Preset Print Profile (Windows®)

Print Profiles are presets designed to give you quick access to frequently-used printing configurations.

1. Select the print command in your application.
2. Select **Brother MFC-XXXX Printer** (where XXXX is the name of your model), and then click the printing properties or preferences button.
The printer driver window appears.
3. Click the **Print Profiles** tab.

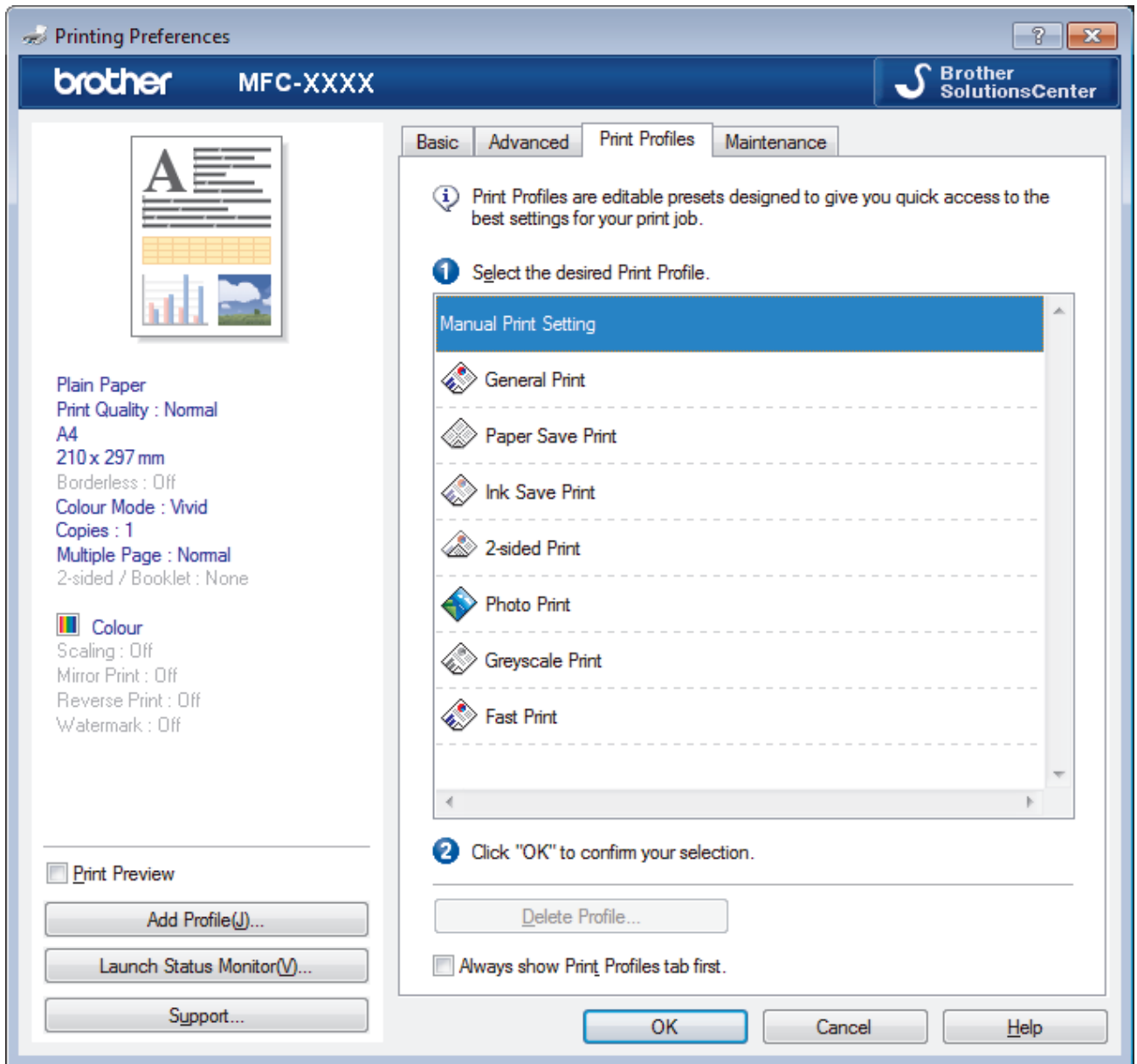

4. Select your profile from the print profile list.
The profile settings are shown on the left side of the printer driver window.
5. Do one of the following:
 - If the settings are correct for your print job, click **OK**.
 - To change the settings, go back to the **Basic** or **Advanced** tab, change settings, and then click **OK**.



To display the **Print Profiles** tab at the front of the window the next time you print, select the **Always show Print Profiles tab first**. check box.



Related Information

- [Print from Your Computer \(Windows®\)](#)
 - [Create or Delete Your Print Profile \(Windows®\)](#)
 - [Print Settings \(Windows®\)](#)
-

Create or Delete Your Print Profile (Windows®)

Add up to 20 new print profiles with customised settings.

1. Select the print command in your application.
2. Select **Brother MFC-XXXX Printer** (where XXXX is the name of your model), and then click the printing properties or preferences button.
The printer driver window appears.
3. Click the **Basic** tab and the **Advanced** tab, and configure the print settings you want for the new Print Profile.
4. Click the **Print Profiles** tab.
5. Do one of the following:

To create a new print profile:

- a. Click **Add Profile**.
The **Add Profile** dialog box appears.
- b. Type the new profile name in the **Name** field.
- c. Click the icon you want to use to represent this profile from the icon list.
- d. Click **OK**.

The new Print Profile name is added to the list in the **Print Profiles** tab.

To delete a print profile that you created:

- a. Click **Delete Profile**.
The **Delete Profile** dialog box appears.
- b. Select the profile you want to delete.
- c. Click **Delete**.
- d. Click **Yes**.
- e. Click **Close**.





Related Information

- [Use a Preset Print Profile \(Windows®\)](#)

Change the Default Print Settings (Windows®)

When you change an application's print settings, the changes only apply to documents printed with that application. To change print settings for all Windows® applications, you must configure the printer driver properties.

1. Do one of the following:
 - For Windows® XP and Windows Server® 2003
Click **Start > Printers and Faxes**.
 - For Windows Vista® and Windows Server® 2008
Click  (**Start**) > **Control Panel > Hardware and Sound > Printers**.
 - For Windows® 7 and Windows Server® 2008 R2
Click  (**Start**) > **Devices and Printers**.
 - For Windows® 8
Move your mouse to the lower right corner of your desktop. When the menu bar appears, click **Settings**, and then click **Control Panel**. In the **Hardware and Sound** group, click **View devices and printers**.
 - For Windows® 10
Click  > **All apps > Windows System > Control Panel**. In the **Hardware and Sound** group, click **View devices and printers**.
 - For Windows Server® 2012
Move your mouse to the lower right corner of your desktop. When the menu bar appears, click **Settings**, and then click **Control Panel**. In the **Hardware** group, click **View devices and printers**.
 - For Windows Server® 2012 R2
Click **Control Panel** on the **Start** screen. In the **Hardware** group, click **View devices and printers**.
2. Right-click the **Brother MFC-XXXX Printer** icon (where XXXX is your model name), and then select **Printer properties**. If printer driver options appear, select your printer driver.
3. Click the **General** tab, and then click the **Printing Preferences...** or **Preferences...** button.
The printer driver dialog box appears.
4. Select the print settings you want to use as defaults for all of your Windows® programs.
5. Click **OK**.
6. Close the printer properties dialog box.



Related Information

- [Print from Your Computer \(Windows®\)](#)
- [Print Settings \(Windows®\)](#)

Print Settings (Windows®)

Basic Tab

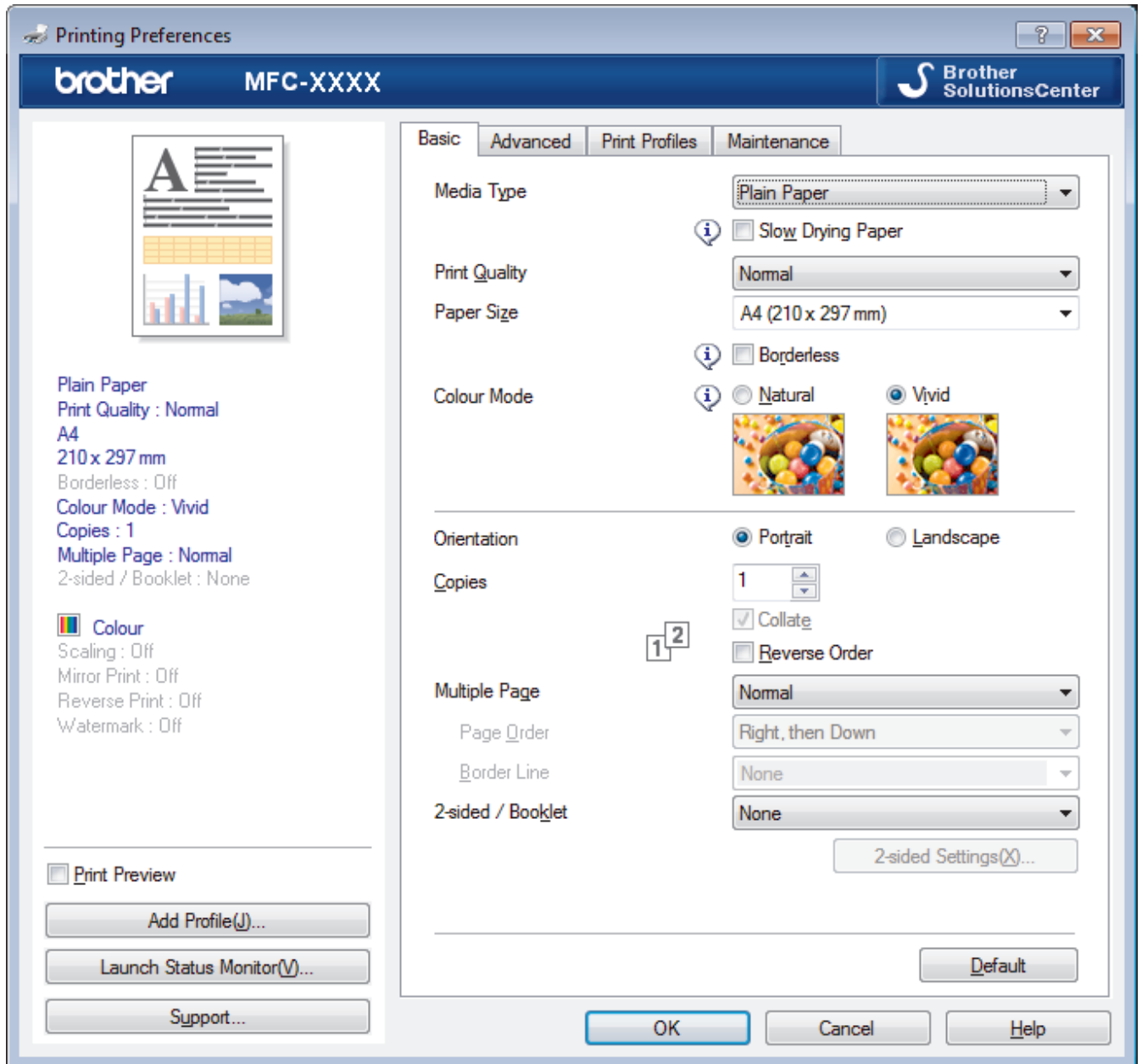

1. Media Type

Select the type of media you want to use. To achieve the best print results, the machine automatically adjusts its print settings according to the selected media type.

Slow Drying Paper

Select this option if you use a type of plain paper on which ink dries slowly. This option may cause slight blurring of the text.

2. Print Quality

Select the print resolution you want. Because print quality and speed are related, the higher the quality, the longer it will take to print the document.

3. Paper Size

Select the size of the paper you want to use. You can either choose from standard paper sizes or create a custom paper size.

Borderless

Select this option to print photos without borders. Because the image data is created slightly larger than the paper size you are using, this will cause some cropping of the photo edges.

You may not be able to select the Borderless option for some combinations of media type and quality, or from some applications.

4. Colour Mode

Select the colour mode to suit your preference.

5. Orientation

Select the orientation (portrait or landscape) of your printout.

If your application contains a similar setting, we recommend that you set the orientation using the application.

6. Copies

Type the number of copies (1-999) that you want to print in this field.

Collate

Select this option to print sets of multi-page documents in the original page order. When this option is selected, one complete copy of your document will print, and then reprint according to the number of copies you choose. If this option is not selected, then each page will print according to the number of copies chosen before the next page of the document is printed.

Reverse Order

Select this option to print your document in reverse order. The last page of your document will be printed first.

7. Multiple Page

Select this option to print multiple pages on a single sheet of paper or print one page of your document on multiple sheets.

Page Order

Select the page order when printing multiple pages on a single sheet of paper.

Border Line

Select the type of border to use when printing multiple pages on a single sheet of paper.

8. 2-sided / Booklet

Select this option to print on both sides of the paper or print a document in booklet format using 2-sided printing.

2-sided Settings button

Click this button to select the type of 2-sided binding. Four types of 2-sided bindings are available for each orientation.

Advanced Tab

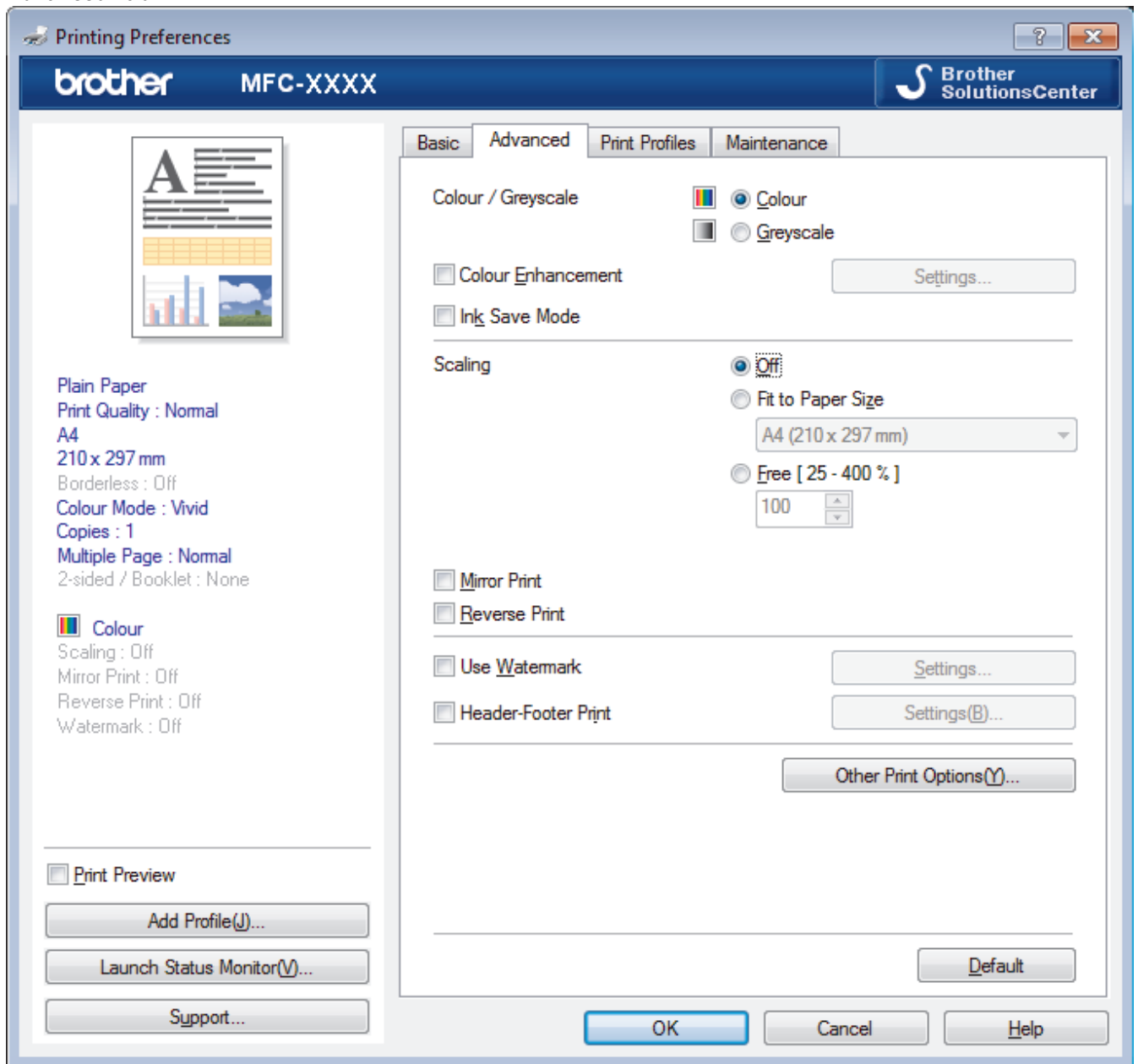

1. Colour / Greyscale

Select colour or greyscale printing. The print speed is faster in greyscale mode than it is in colour mode. If your document contains colour and you select greyscale mode, your document will be printed using 256 levels of greyscale.

Settings button

Click this button to select the Colour Enhancement feature. This feature analyses your image to improve its sharpness, white balance and colour density. This process may take several minutes depending on the image size and your computer's specifications.

2. Ink Save Mode

Select this option to print using lighter colours and emphasise image outlines. The amount of ink that is saved varies, depending on the type of documents printed. Ink Save Mode may make your printouts look different than they appear on your screen.

The Ink Save Mode feature is supported by technology from Reallusion, Inc.



3. Scaling

Select these options to enlarge or reduce the size of the pages in your document.

Fit to Paper Size

Select this option to enlarge or reduce the document pages to fit a specified paper size. When you select this option, select the paper size you want from the drop-down list.

Free

Select this option to enlarge or reduce the document pages manually. When you select this option, type a value into the field.

4. Mirror Print

Select this option to reverse the printed image on the page horizontally from left to right.

5. Reverse Print

Select this option to rotate the printed image 180 degrees.

6. Use Watermark

Select this option to print a logo or text on your document as a watermark. Select one of the preset watermarks, add a new watermark, or use an image file you have created.

7. Header-Footer Print

Select this option to print the date, time and PC login user name on the document.

8. Other Print Options button

Photo Paper Tray Help

Select this option to display the instructions for use of the photo paper tray.

Change Data Transfer Mode

Select the print data transfer mode to improve print quality or print speed.

Advanced Colour Settings

Select the method that the machine uses to arrange dots to express halftones.

The printout colour can be adjusted to achieve the closest match to what appears on your computer screen.

Advanced 2-sided Settings

Select the print speed for 2-sided printing. Some types of print media may need more drying time when using the 2-sided feature. Change this option if you have problems with smudged 2-sided printouts or paper jams.

Retrieve Printer's Colour Data

Select this option to optimise the print quality using the machine's factory settings, which are set specifically for your Brother machine. Use this option when you have replaced the machine or changed the machine's network address.

Print Archive

Select this option to save the print data as a PDF file to your computer.



Related Information

- [Print from Your Computer \(Windows®\)](#)
- [Error and Maintenance Messages](#)
- [Paper Handling and Printing Problems](#)
- [Print a Photo \(Windows®\)](#)
- [Print a Document \(Windows®\)](#)
- [Print More Than One Page on a Single Sheet of Paper \(N in 1\) \(Windows®\)](#)
- [Print as a Poster \(Windows®\)](#)
- [Print on Both Sides of the Paper Automatically \(Automatic 2-sided Printing\) \(Windows®\)](#)
- [Print as a Booklet Automatically \(Windows®\)](#)
- [Use a Preset Print Profile \(Windows®\)](#)

-
- Change the Default Print Settings (Windows®)
-

Print from Your Computer (Mac)

- [Print a Photo \(Mac\)](#)
- [Print a Document \(Mac\)](#)
- [Print on Both Sides of the Paper Automatically \(Automatic 2-sided Printing\) \(Mac\)](#)
- [Print More Than One Page on a Single Sheet of Paper \(N in 1\) \(Mac\)](#)
- [Print a Colour Document in Greyscale \(Mac\)](#)
- [Prevent Smudged Printouts and Paper Jams When Printing on Both Sides of the Paper \(Mac\)](#)
- [Print Options \(Mac\)](#)

Print a Photo (Mac)



1. Make sure you have loaded the correct media in the paper tray.

IMPORTANT

- We recommend using the photo paper tray located on the top of the output tray cover to print on Photo (10 x 15 cm) and Photo L (9 x 13 cm) paper. (available only for certain models)
- For best results, use Brother paper.
- When you print on Brother photo paper, load one extra sheet of the same photo paper in the paper tray.

2. From an application, such as Apple Preview, click the **File** menu, and then select **Print**.
3. Select **Brother MFC-XXXX** (where XXXX is your model name).



For more page setup options, click the **Show Details** button.

4. Click the **Paper Size** pop-up menu, and then select your paper size.



To print photographs without margins, select a borderless paper size option.

5. Click the **Orientation** button that matches the way you want the photo to print.
6. Click the application pop-up menu, and then select **Print Settings**.
The **Print Settings** options appear.
7. Click the **Media Type** pop-up menu, and then select the media type you want to use.

IMPORTANT

To get the best print quality for the settings you have selected, always set the **Media Type** option to match the type of paper you load.

8. Change other printer settings, if needed.
9. Click **Print**.



Related Information

- [Print from Your Computer \(Mac\)](#)
- [Paper Handling and Printing Problems](#)
- [Print Options \(Mac\)](#)

Print a Document (Mac)

1. Make sure you have loaded the correct size paper in the paper tray.
2. From an application, such as Apple TextEdit, click the **File** menu, and then select **Print**.
3. Select **Brother MFC-XXXX** (where XXXX is your model name).



For more page setup options, click the **Show Details** button.

4. Click the **Paper Size** pop-up menu, and then select your paper size.
5. Select the **Orientation** option that matches the way you want the document to print.
6. Click the application pop-up menu, and then select **Print Settings**.
The **Print Settings** options appear.
7. Click the **Media Type** pop-up menu, and then select the media type you want to use.

IMPORTANT

To get the best print quality for the settings you have selected, always set the **Media Type** option to match the type of paper you load.

8. Change other printer settings, if needed.
9. Click **Print**.



Related Information

- [Print from Your Computer \(Mac\)](#)
- [Check the Ink Volume](#)
- [Print Options \(Mac\)](#)

Print on Both Sides of the Paper Automatically (Automatic 2-sided Printing) (Mac)

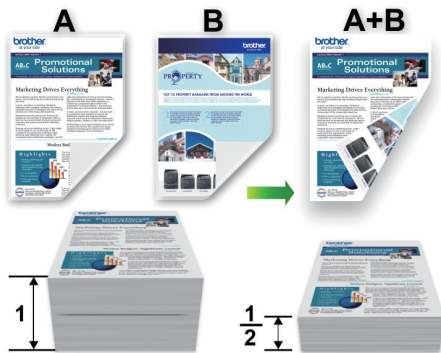

1. From an application, such as Apple TextEdit, click the **File** menu, and then select **Print**.
2. Select **Brother MFC-XXXX** (where XXXX is your model name).



For more page setup options, click the **Show Details** button.

3. Select the **Orientation** option that matches the way you want the document to print.
4. Click the application pop-up menu, and then select **Layout**.
The **Layout** setting options appear.
5. In the **Two-Sided** section, select the **Short-Edge binding** or **Long-Edge binding** option.
6. Change other printer settings, if needed.



The Borderless feature is not available when using this option.

7. Click **Print**.



Related Information

- [Print from Your Computer \(Mac\)](#)
- [Print Options \(Mac\)](#)

Print More Than One Page on a Single Sheet of Paper (N in 1) (Mac)



1. From an application, such as Apple TextEdit, click the **File** menu, and then select **Print**.
2. Select **Brother MFC-XXXX** (where XXXX is your model name).



For more page setup options, click the **Show Details** button.

3. Click the application pop-up menu, and then select **Layout**.
The **Layout** setting options appear.
4. Click the **Pages per Sheet** pop-up menu, and then select the number of pages to print on each sheet.
5. Select the **Layout Direction** option.
6. Click the **Border** pop-up menu, and then select your border line type.
7. Change other printer settings if needed.
8. Click **Print**.



Related Information

- [Print from Your Computer \(Mac\)](#)
- [Print Options \(Mac\)](#)

Print a Colour Document in Greyscale (Mac)

Greyscale mode makes the print processing speed faster than colour mode. If your document contains colour, selecting Greyscale mode prints your document in 256 levels of greyscale.

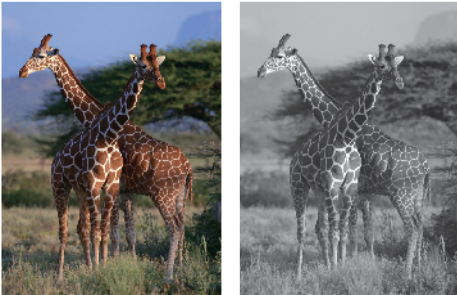

1. From an application, such as Apple TextEdit, click the **File** menu, and then select **Print**.
2. Select **Brother MFC-XXXX** (where XXXX is your model name).



For more page setup options, click the **Show Details** button.

3. Click the application pop-up menu, and then select **Print Settings**.
The **Print Settings** options appear.
4. Click the **Color/Grayscale** pop-up menu, and then select the **Grayscale** option.
5. Change other printer settings if needed.
6. Click **Print**.



Related Information

- [Print from Your Computer \(Mac\)](#)

Prevent Smudged Printouts and Paper Jams When Printing on Both Sides of the Paper (Mac)

Some types of print media may need more drying time when using the 2-sided feature. Change the **Advanced 2-sided Settings** option if you have problems with smudged 2-sided printouts or paper jams.

1. From an application, such as Apple TextEdit, click the **File** menu, and then select **Print**.
2. Select **Brother MFC-XXXX** (where XXXX is your model name).



For more page setup options, click the **Show Details** button.

3. Click the application pop-up menu, and then select **Layout**.
The **Layout** setting options appear.
4. In the **Two-Sided** section, select the **Short-Edge binding** or **Long-Edge binding** option.
5. Click the application pop-up menu, and then select **Print Settings**.
The **Print Settings** options appear.
6. Click the **Advanced** print settings list.
7. Click the **Advanced 2-sided Settings** menu.
8. Select one of the following options from the **Advanced 2-sided Settings** pop-up menu:

Option	Description
Normal	Select this mode to print at normal speed, using a normal amount of ink.
2-sided 1 (Slower print speed)	Select this mode to print at a slower speed, using a normal amount of ink.
2-sided 2 (Slower print speed & less ink)	Select this mode to print at the same speed as 2-sided 1 (Slower print speed) , but using less ink.

9. Change other printer settings, if needed.
10. Click **Print**.



Related Information

- [Print from Your Computer \(Mac\)](#)
- [Paper Handling and Printing Problems](#)

Print Options (Mac)

Page Setup

Settings: Page Attributes

Format For: Brother MFC-XXXX
Brother MFC- XXXX CUPS

Paper Size: A4
210 by 297 mm

Orientation: Portrait Landscape

Scale: 100 %

Cancel OK

1. Paper Size

Select the size of the paper you want to use. You can either choose from standard paper sizes or create a custom paper size.

2. Orientation

Select the orientation (portrait or landscape) of your printout.

If your application contains a similar setting, we recommend that you set the orientation using the application.

3. Scale

Type a value into the field to enlarge or reduce the pages in your document to fit the selected paper size.

Layout



Printer: Brother MFC-XXXX

Presets: Default Settings

Copies: 1 Two-Sided





Pages: All
 From: 1 to: 1

Paper Size: A4 210 by 297 mm

Orientation:  

Layout

Pages per Sheet: 1

Layout Direction:    

Border: None

Two-Sided: Off

Reverse page orientation

Flip horizontally

Cancel Print

1. Pages per Sheet

Select the number of pages to print on a single sheet of paper.

2. Layout Direction

Select the page order when printing multiple pages on a single sheet of paper.

3. Border

Select the type of border to use when printing multiple pages on a single sheet of paper.

4. Two-Sided (available only for certain models)

Select whether to print on both sides of the paper.

5. Reverse page orientation

Select this option to rotate the printed image 180 degrees.

6. Flip horizontally

Select this option to reverse the printed image on the page horizontally from left to right.

Paper Handling

Printer:

Presets:

Copies: Two-Sided

Pages: All
 From: to:

Paper Size: 210 by 297 mm

Orientation: Portrait Landscape

Collate pages

Pages to Print:

Page Order:

Scale to fit paper size

Destination Paper Size:

Scale down only

1. Collate pages

Select this option to print sets of multi-page documents in the original page order. When this option is selected, one complete copy of your document will print, and then reprint according to the number of copies you choose. If this option is not selected, then each page will print according to the number of copies chosen before the next page of the document is printed.

2. Page Order

Select the page order.

3. Scale to fit paper size

Select this option to enlarge or reduce the pages in your document to fit the selected paper size.

4. Destination Paper Size

Select the paper size to print on.

5. Scale down only

Select this option if you want to reduce the pages in your document when they are too large for the selected paper size. If this option is selected and the document is formatted for a paper size that is smaller than the paper size you are using, the document will be printed at its original size.

Print Settings

Printer:

Presets:

Copies: Two-Sided

Pages: All
 From: to:

Paper Size: 210 by 297 mm

Orientation: Portrait Landscape

Media Type:
 Slow Drying Paper

Print Quality:

Color / Grayscale:

▼ Advanced

Change Data Transfer Mode
 Advanced 2-sided Settings
 Other Print Options

Change Data Transfer Mode:

1. Media Type

Select the type of media you want to use. To achieve the best print results, the machine automatically adjusts its print settings according to the selected media type.

2. Slow Drying Paper

Select this option if you use a type of plain paper on which ink dries slowly. This option may cause slight blurring of the text.

3. Print Quality

Select the print resolution you want. Because print quality and speed are related, the higher the quality, the longer it will take to print the document.

4. Color/Grayscale

Select colour or greyscale printing. The print speed is faster in greyscale mode than it is in colour mode. If your document contains colour and you select greyscale mode, your document will be printed using 256 levels of greyscale.

5. Advanced

Change Data Transfer Mode

Select the print data transfer mode to improve print quality or print speed.

Advanced 2-sided Settings

Select the print speed for 2-sided printing. Some types of print media may need more drying time when using the 2-sided feature. Change this option if you have problems with smudged 2-sided printouts or paper jams.

Other Print Options

Paper Thickness

Select the appropriate paper thickness.

Bi-Directional Printing

Select this option to increase the print speed. When this option is selected, the print head prints in both directions. When this option is cleared, the print head prints in only one direction, resulting in higher quality printouts but causing slower print speeds.

Sometimes, the movement of the print head may vary due to environmental conditions. This may be seen when you print vertical lines and they do not align. If you encounter this problem, turn off the Bi-Directional Printing feature.

Color Settings

Color Settings

Color Mode: Natural Vivid None

▼ Advanced Color Settings

Color Enhancement

Brightness 0

Contrast 0

Red 0

Green 0

Blue 0

Halftone Pattern: Diffusion

Cancel Print

1. Color Mode

Select the colour mode to suit your preference.

2. Advanced Color Settings

Click the disclosure triangle to select the Colour Enhancement feature. This feature analyses your image to improve its sharpness, white balance and colour density. This process may take several minutes depending on the size of the image and the specifications of your computer.



Related Information

- [Print from Your Computer \(Mac\)](#)
 - [Error and Maintenance Messages](#)
 - [Paper Handling and Printing Problems](#)
 - [Print a Photo \(Mac\)](#)
 - [Print a Document \(Mac\)](#)
 - [Print on Both Sides of the Paper Automatically \(Automatic 2-sided Printing\) \(Mac\)](#)
 - [Print More Than One Page on a Single Sheet of Paper \(N in 1\) \(Mac\)](#)
-

Scan

- [Scan Using the Scan Button on Your Brother Machine](#)
- [Scan from Your Computer \(Windows®\)](#)
- [Scan from Your Computer \(Mac\)](#)

Scan Using the Scan Button on Your Brother Machine

- [Scan Photos and Graphics](#)
- [Save Scanned Data to a Folder as a PDF File](#)
- [Save Scanned Data to a Memory Card or USB Flash Drive](#)
- [Scan Multiple Business Cards and Photos \(Auto Crop\)](#)
- [Scan to an Editable Text File Using OCR](#)
- [Scan to E-mail Attachment](#)
- [Web Services for Scanning on Your Network \(Windows Vista® SP2 or greater, Windows® 7, Windows® 8 and Windows® 10\)](#)
- [Change Scan Button Settings from ControlCenter4 \(Windows®\)](#)
- [Change Scan Button Settings from ControlCenter2 \(Mac\)](#)

Scan Photos and Graphics

Send scanned photos or graphics directly to your computer.

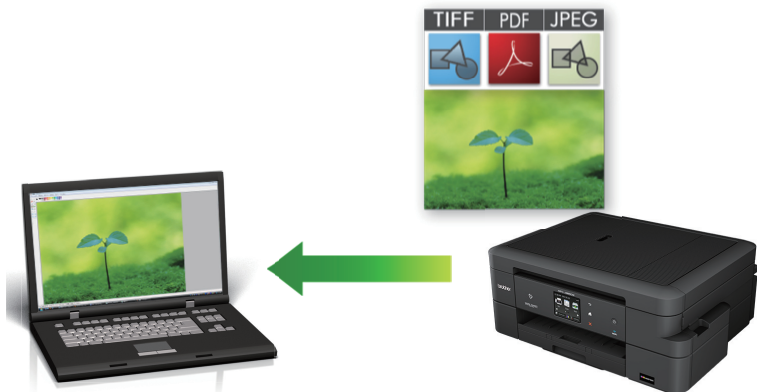

Use the Scan button on the machine to make temporary changes to the scan settings. To make permanent changes, use Brother's ControlCenter software.

1. Load your document.
2. Press [Scan] > [to Image].
3. If the machine is connected over the network, press ▲ or ▼ to display the computer where you want to send data, and then press the computer name.



If the LCD prompts you to enter a PIN, use the LCD to enter the four-digit PIN for the computer, and then press [OK].

4. Do one of the following:
 - To change the settings, press [Options], and then go to the next step.
 - Press [Start] to start scanning without changing additional settings.

The machine starts scanning. If using the machine's scanner glass, follow the LCD instructions to complete the scanning job.

5. Press the [Scan Settings] option, and then press [Set at Device].



To use the [Scan Settings] option, a computer with the ControlCenter software installed must be connected to the machine.

6. Select the scan settings you want to change, and then press [OK].

Option	Description
Scan Type	Select the scan type for your document.
Resolution	Select the scan resolution for your document.
File Type	Select the file format for your document.
Scan Size	Select the scan size for your document.
Remove Background Colour	Change the amount of background colour that is removed.

7. Press [Start].

The machine starts scanning. If using the machine's scanner glass, follow the LCD instructions to complete the scanning job.



Related Information

- [Scan Using the Scan Button on Your Brother Machine](#)
-

Save Scanned Data to a Folder as a PDF File

Scan documents and save them to a folder on your computer as PDF files.



Use the Scan button on the machine to make temporary changes to the scan settings. To make permanent changes, use Brother's ControlCenter software.

1. Load your document.
2. Press [Scan] > [to File].
3. If the machine is connected over the network, press ▲ or ▼ to display the computer where you want to send data, and then press the computer name.



If the LCD prompts you to enter a PIN, use the LCD to enter the four-digit PIN for the computer, and then press [OK].

4. Do one of the following:
 - To change the settings, press [Options], and then go to the next step.
 - Press [Start] to start scanning without changing additional settings.

The machine starts scanning. If using the machine's scanner glass, follow the LCD instructions to complete the scanning job.

5. Press the [Scan Settings] option, and then press [Set at Device].



To use the [Scan Settings] option, a computer with the ControlCenter software installed must be connected to the machine.

6. Select the scan settings you want to change, and then press [OK].

Option	Description
Scan Type	Select the scan type for your document.
Resolution	Select the scan resolution for your document.
File Type	Select the file format for your document.
Scan Size	Select the scan size for your document.
Remove Background Colour	Change the amount of background colour that is removed.

7. Press [Start].

The machine starts scanning. If using the machine's scanner glass, follow the LCD instructions to complete the scanning job.



Related Information

- [Scan Using the Scan Button on Your Brother Machine](#)
-

Save Scanned Data to a Memory Card or USB Flash Drive

Scan documents and save them directly to a memory card or USB flash drive without using a computer.

1. Load your document.
2. Open the machine's media slot cover.
3. Insert a memory card or USB flash drive into your machine.
The LCD screen automatically changes.
4. Press [Scan to Media].
5. Do one of the following:
 - To change the settings, press [Options], and then go to the next step.



- To set your own default settings: after making changes to settings, press the [Set New Default] option, and then press [Yes].
- To restore the factory settings: press the [Factory Reset] option, and then press [Yes].

- Press [Start] to start scanning without changing additional settings.
The machine starts scanning. If using the machine's scanner glass, follow the LCD instructions to complete the scanning job.
6. Select the scan settings you want to change, and then press [OK].

Option	Description
Scan Type	Select the scan type for your document.
Resolution	Select the scan resolution for your document.
File Type	Select the file format for your document.
Scan Size	Select the scan size for your document.
Scan Long Paper (available only for certain models)	Scan a long document using the ADF.
File Name	Rename the file.
Auto Crop (available only for certain models)	Scan multiple documents placed on the scanner glass to a memory card or USB Flash drive. The machine will scan each document and create separate files or a single multi-page file.
Remove Background Colour	Change the amount of background colour that is removed.



To save the settings as a shortcut, press [Save as Shortcut].

7. Press [Start].
8. If you are using the scanner glass, the LCD displays [Next Page?]. To add another page to this scan, press [Yes]. If there are no more pages to scan, press [No]. After you finish scanning, make sure you choose [No] before removing the memory card or USB flash drive from the machine.

IMPORTANT

The LCD displays a message while reading the data. DO NOT unplug the power cord or remove the memory card or USB flash drive from the machine while it is reading the data. You could lose your data or damage the memory card or USB flash drive.



Related Information

- [Scan Using the Scan Button on Your Brother Machine](#)
 - [Memory Card or USB Flash Drive Information](#)
 - [Scan-to Media Settings](#)
-

Memory Card or USB Flash Drive Information

Your Brother machine has media drives (slots) for use with common data storage and digital camera media.





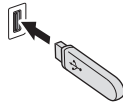

IMPORTANT

The USB direct interface supports only USB flash drives, PictBridge-compatible cameras, or digital cameras that use the USB mass storage standard. Other USB devices are not supported.

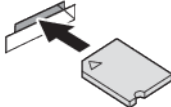
DCP-J785DW/MFC-J985DW

Compatible Memory Cards		Slot
USB flash drive		

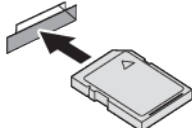
DCP-J785DW/MFC-J985DW

Compatible Memory Cards		Slot
Memory Stick Duo™ Memory Stick PRO Duo™		Upper slot 
Memory Stick Micro™ (M2™) (Adapter required)		
SD Memory Card SDHC Memory Card SDXC Memory Card MultiMediaCard MultiMediaCard plus	 	Lower slot 
miniSD (Adapter required) miniSDHC (Adapter required) microSD (Adapter required) microSDHC (Adapter required) MultiMediaCard mobile (Adapter required)		

✓ Related Information

- [Save Scanned Data to a Memory Card or USB Flash Drive](#)

Scan-to Media Settings

[Scan Type] / [Resolution] / [File Type]

Selecting a higher dots per inch (dpi) setting increases the details captured during the scan; however, file size and transfer time also increase. The table below shows the available quality settings and file types.

Recommended usage	Scan Type	Resolution	File Type	Default Setting of File Type
Best for scanning text documents at the smallest file size	Black and White	100 dpi	TIFF / PDF	PDF
Best for scanning text documents at better quality than 100 dpi		200 dpi		
Best for scanning text documents at better quality than 200 dpi		300 dpi		
Best for scanning text documents at the highest Monochrome quality and largest file size		600 dpi Auto		
Best for scanning Colour documents at the smallest file size	Colour	100 dpi	JPEG / PDF	PDF
Best for scanning Colour documents at better quality than 100 dpi		200 dpi		
Best for scanning Colour documents or photos in high quality at a smaller file size than 600 dpi		300 dpi		
Best for scanning photos at the highest quality and largest file size		600 dpi Auto		

[Scan Size]

Choose the scan size for your document.

[Scan Long Paper]

Scan documents printed on long paper using the ADF. (available only for certain models)

[File Name]

Change the default file name given to your scanned data. The default file name is six digits indicating the date plus a two-digit sequence number. For example, the first file from 3 May 2013 would be "03051301". You may replace the first six digits with up to six characters of your choice.

[Auto Crop]

(available only for certain models) Select [On] or [Off]. You can scan multiple documents placed on the scanner glass. The machine will scan each document and create separate files or a single multi-page file.

[Remove Background Colour]

Remove the base colour of documents to make the scanned data more recognisable. When you use this feature, select from three settings: high, medium and low.

[Set New Default]

Save your settings as the default.

[Factory Reset]

Restore all settings back to the factory settings.



Related Information

- [Save Scanned Data to a Memory Card or USB Flash Drive](#)

Scan Multiple Business Cards and Photos (Auto Crop)

Related Models: MFC-J985DW

You can scan multiple documents placed on the scanner glass. The machine will scan each document and use the Auto Crop feature to create separate files or a single multi-page file.

Guidelines for Auto Crop

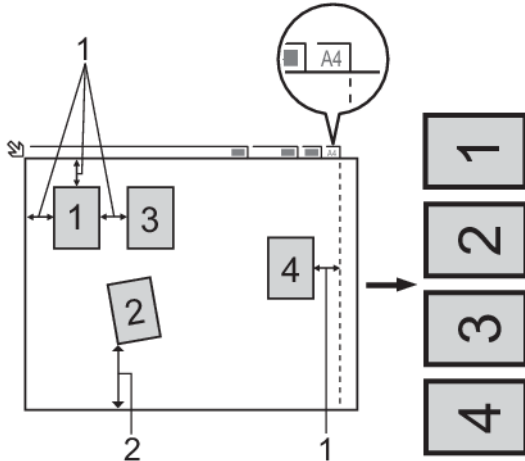

1. 10 mm or greater
2. 20 mm or greater (bottom)
 - This setting is available only for documents that are rectangular or square.
 - If your document is too long or wide, this feature will not work as described here.
 - You must place the documents away from the edges of the scanner glass as shown in the illustration.
 - You must place the documents at least 10 mm away from each other.
 - Auto Crop adjusts the skew of the document on the scanner glass; however, if your document is skewed more than 10 degrees, this feature will not work.
 - The ADF must be empty to use Auto Crop. (ADF models only)
 - The Auto Crop feature is available for a maximum of 16 documents, depending on the size of the documents.

1. Load documents on the scanner glass.



- To scan documents using the Auto Crop feature, you must put the documents on the scanner glass.
- The Auto Crop feature is supported by technology from Reallusion, Inc.



2. Open the machine's media slot cover.
3. Insert a memory card or USB flash drive into your machine.
The LCD screen automatically changes.
4. Press [Scan to Media] > [Options] > [Auto Crop].
5. Press [On].
6. Press [OK].
7. Press [Start].

The machine starts scanning. Follow the LCD instructions to complete the scanning job.



Related Information

- [Scan Using the Scan Button on Your Brother Machine](#)
-

Scan to an Editable Text File Using OCR

Your machine can convert characters in a scanned document to text data using optical character recognition (OCR) technology. You can edit this text using your preferred text-editing application.



- Mac
Presto! PageManager must be installed on your computer.
Download Presto! PageManager from nj.newsoft.com.tw/download/brother/PM9SEInstaller_BR_multilang2.dmg.



The Scan to OCR feature is available for certain languages.

- Use the Scan button on the machine to make temporary changes to the scan settings. To make permanent changes, use Brother's ControlCenter software.

1. Load your document.
2. Press [Scan] > [to OCR].
3. If the machine is connected over the network, press ▲ or ▼ to display the computer where you want to send data, and then press the computer name.



If the LCD prompts you to enter a PIN, use the LCD to enter the four-digit PIN for the computer, and then press [OK].

4. Do one of the following:
 - To change the settings, press [Options], and then go to the next step.
 - Press [Start] to start scanning without changing additional settings.

The machine starts scanning. If using the machine's scanner glass, follow the LCD instructions to complete the scanning job.

5. Press the [Scan Settings] option, and then press [Set at Device].



To use the [Scan Settings] option, a computer with the ControlCenter software installed must be connected to the machine.

6. Select the scan settings you want to change, and then press [OK].

Option	Description
Scan Type	Select the scan type for your document.
Resolution	Select the scan resolution for your document.

Option	Description
File Type	Select the file format for your document.
Scan Size	Select the scan size for your document.

7. Press [Start].

The machine starts scanning. If using the machine's scanner glass, follow the LCD instructions to complete the scanning job.



Related Information

- [Scan Using the Scan Button on Your Brother Machine](#)
-

Scan to E-mail Attachment

Send a scanned document as an email attachment.



- Use the Scan button on the machine to make temporary changes to the scan settings. To make permanent changes, use Brother's ControlCenter software.
- The Scan to E-mail feature does not support Webmail services. Use the Scan to Image or Scan to File feature to scan a document or a picture, and then attach the scanned file to an email message.

1. Load your document.
2. Press [Scan] > [to E-mail].
3. If the machine is connected over the network, press ▲ or ▼ to display the computer where you want to send data, and then press the computer name.



If the LCD prompts you to enter a PIN, use the LCD to enter the four-digit PIN for the computer, and then press [OK].

4. Do one of the following:
 - To change the settings, press [Options], and then go to the next step.
 - Press [Start] to start scanning without changing additional settings.
The machine scans the document and saves it as a file attachment. It then launches your email application and opens a new, blank email message with the scanned file attached.
5. Press the [Scan Settings] option, and then press [Set at Device].



To use the [Scan Settings] option, a computer with the ControlCenter software installed must be connected to the machine.

6. Select the scan settings you want to change, and then press [OK].

Option	Description
Scan Type	Select the scan type for your document.
Resolution	Select the scan resolution for your document.
File Type	Select the file format for your document.
Scan Size	Select the scan size for your document.
Remove Background Colour	Change the amount of background colour that is removed.

7. Press [Start].

The machine scans the document and saves it as a file attachment. It then launches your email application and opens a new, blank email message with the scanned file attached.



Related Information

- [Scan Using the Scan Button on Your Brother Machine](#)
-

Web Services for Scanning on Your Network (Windows Vista® SP2 or greater, Windows® 7, Windows® 8 and Windows® 10)

The Web Services protocol enables Windows Vista® (SP2 or greater), Windows® 7, Windows® 8 and Windows® 10 users to scan using a Brother machine on the network. You must install the driver via Web Services.

- [Use Web Services to Install Drivers Used for Scanning \(Windows Vista®, Windows® 7, Windows® 8 and Windows® 10\)](#)
- [Scan Using Web Services from the Brother Machine \(Windows Vista® SP2 or greater, Windows® 7, Windows® 8 and Windows® 10\)](#)
- [Configure Scan Settings for Web Services](#)

Use Web Services to Install Drivers Used for Scanning (Windows Vista®, Windows® 7, Windows® 8 and Windows® 10)

Use Web Services to monitor printers on the network.

- Make sure you have installed the Brother software and drivers.
- Verify that the host computer and the Brother machine are on the same subnet, or that the router is correctly configured to pass data between the two devices.
- You must configure the IP address on your Brother machine before you configure this setting.
- For Windows Server® 2008, Windows Server® 2012 and Windows Server® 2012 R2, you must install Print Services.

1. Do one of the following:

- Windows Vista®

Click  (**Start**) > **Network**.

The machine's Web Services Name appears with the printer icon.

Right-click the machine you want to install.

- Windows® 7

Click  (**Start**) > **Control Panel** > **Network and Internet** > **View network computers and devices**.

The machine's Web Services Name appears with the printer icon.

Right-click the machine you want to install.

- Windows® 8

Move your mouse to the lower right corner of your desktop. When the menu bar appears, click **Settings** > **Change PC settings** > **Devices** > **Add a device**.

The machine's Web Services Name appears.

- Windows® 8.1

Move your mouse to the lower right corner of your desktop. When the menu bar appears, click **Settings** > **Change PC settings** > **PC and devices** > **Devices** > **Add a device**.

The machine's Web Services Name appears.

- Windows® 10

Click  > **All apps** > **Windows System** > **Control Panel**. In the **Hardware and Sound** group, click **Add a device**.



- The Web Services Name for the Brother machine is your model name and the MAC Address (Ethernet Address) of your machine (for example, Brother MFC-XXXX (model name) [XXXXXXXXXXXX] (MAC Address / Ethernet Address)).

- Windows® 8/Windows® 10

Move your mouse over the machine name to display the machine's information.

2. Do one of the following:

- Windows Vista®/Windows® 7

Click **Install** in the displayed menu.

- Windows® 8/Windows® 10

Select the machine you want to install.



To uninstall drivers, click **Uninstall** or  (**Remove device**).



Related Information

- [Web Services for Scanning on Your Network \(Windows Vista® SP2 or greater, Windows® 7, Windows® 8 and Windows® 10\)](#)
-

■ [Home](#) > [Scan](#) > [Scan Using the Scan Button on Your Brother Machine](#) > [Web Services for Scanning on Your Network \(Windows Vista® SP2 or greater, Windows® 7, Windows® 8 and Windows® 10\)](#) > [Scan Using Web Services from the Brother Machine \(Windows Vista® SP2 or greater, Windows® 7, Windows® 8 and Windows® 10\)](#)

Scan Using Web Services from the Brother Machine (Windows Vista® SP2 or greater, Windows® 7, Windows® 8 and Windows® 10)

If you have installed the driver for scanning via Web Services, you can access the Web Services scanning menu on your Brother machine's LCD.

- Certain characters in the messages displayed on the LCD may be replaced with spaces if the language settings of your OS and your Brother machine are different.
- If the LCD displays an insufficient memory error message, choose a smaller size in the **Paper size** setting or a lower resolution in the **Resolution (DPI)** setting.

1. Load your document.
2. Press [Scan] > [WS Scan].
3. Press ▲ or ▼ to select the type of scan you want, and then press it.
4. Press ▲ or ▼ to display the computer where you want to send data, and then press the computer name.
5. Press [Start].



The machine starts scanning.



Related Information

- [Web Services for Scanning on Your Network \(Windows Vista® SP2 or greater, Windows® 7, Windows® 8 and Windows® 10\)](#)
-

Configure Scan Settings for Web Services

1. Do one of the following:
 - Windows Vista®
Click  (Start) > **Control Panel** > **Hardware and Sound** > **Scanners and Cameras**.
 - Windows® 7
Click  (Start) > **Devices and Printers**.
 - Windows® 8
Move your mouse to the lower right corner of your desktop. When the menu bar appears, click **Settings**, and then click **Control Panel**. In the **Hardware and Sound** group, click **View devices and printers**.
 - Windows® 10
Click  > **All apps** > **Windows System** > **Control Panel**. In the **Hardware and Sound** group, click **View devices and printers**.
2. Do one of the following:
 - Windows Vista®
Click your machine, and then click the **Scan Profiles** button. The **Scan Profiles** dialog box appears.
 - Windows® 7, Windows® 8 and Windows® 10
Right-click the machine icon, and then select **Scan profiles...**. The **Scan Profiles** dialog box appears.
3. Select the scan profile you want to use.
4. Make sure the scanner selected in the **Scanner** list is a Brother machine that supports Web Services for scanning, and then click the **Set as Default** button.
5. Click **Edit...**
The **Edit Default Profile** dialog box appears.
6. Select the **Source**, **Paper size**, **Colour format**, **File type**, **Resolution (DPI)**, **Brightness** and **Contrast** settings.
7. Click the **Save Profile** button.
These settings will be applied when you scan using the Web Services protocol.

If you are requested to select a scanning application, select Windows® Fax and Scan or Windows® Photo Gallery from the list.



Related Information

- [Web Services for Scanning on Your Network \(Windows Vista® SP2 or greater, Windows® 7, Windows® 8 and Windows® 10\)](#)

Change Scan Button Settings from ControlCenter4 (Windows®)

1. Click the  (ControlCenter4) icon in the task tray, and then click **Open**.
2. Click the **Device Settings** tab.
3. Click the **Device Scan Settings** button.

The **Device Scan Settings** dialog box appears.

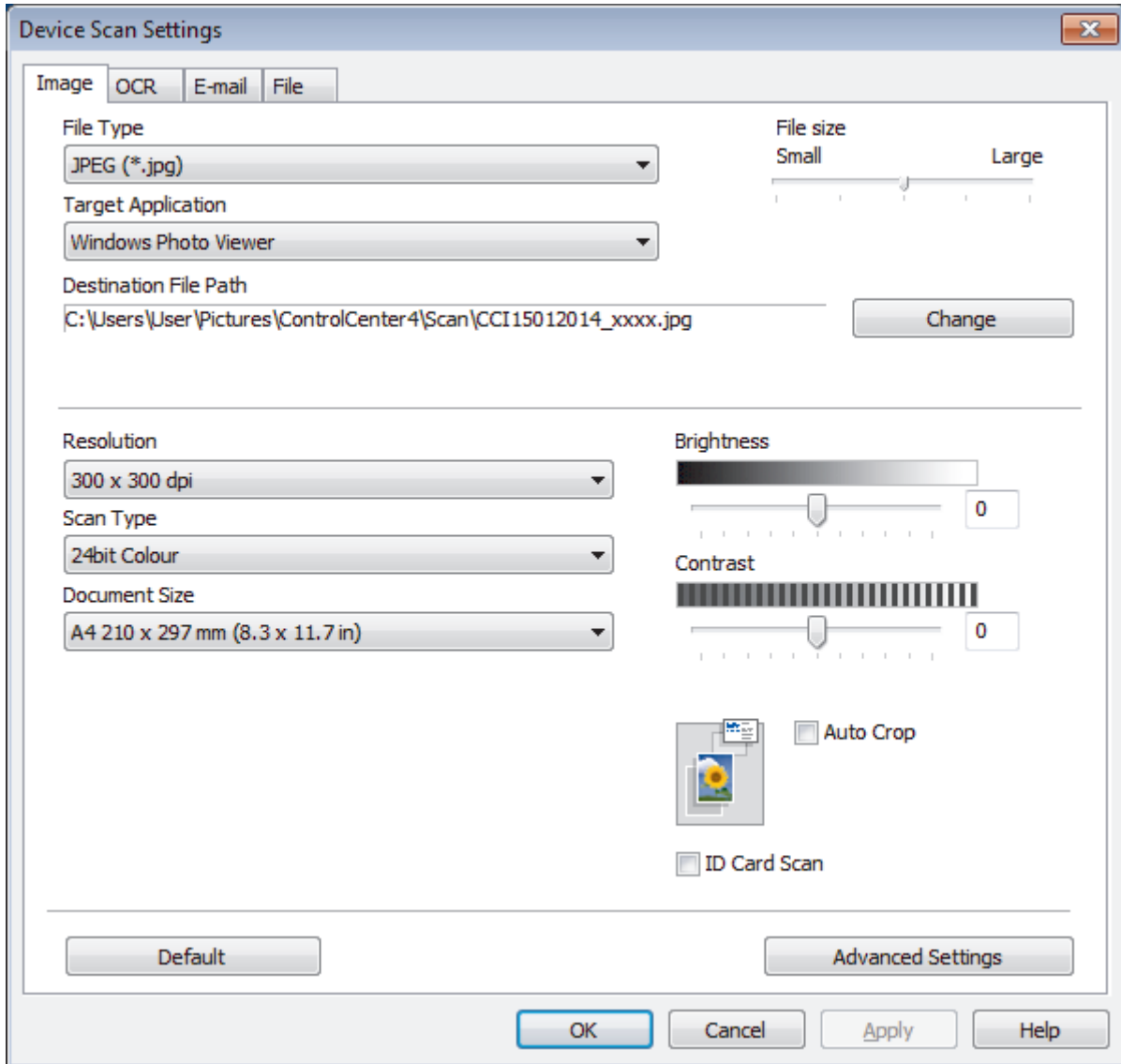

4. Click the tab for the Scan to action you want to change (**Image**, **OCR**, **E-mail**, or **File**).
5. Change the settings as needed.
6. Click **OK**.



Each tab corresponds to a scan feature, as described below.

These settings can be changed.

Click the tabs, and then change the settings.

Tab Name	Corresponding Feature
Image	Scan to Image
OCR	Scan to OCR
E-mail	Scan to E-mail
File	Scan to File

Settings	Applicable Features			
	Image	OCR	E-mail	File
File Type	Yes	Yes	Yes	Yes
Target Application	Yes	Yes	-	-
OCR Language (available only for certain models)	-	Yes	-	-
Destination File Path	Yes	Yes	Yes	-
File Name	Yes	Yes	Yes	Yes
Insert Date in File Name	Yes	Yes	Yes	Yes
Destination Folder	Yes	Yes	Yes	Yes
File size	Yes	-	Yes	Yes
Resolution	Yes	Yes	Yes	Yes
Scan Type	Yes	Yes	Yes	Yes
Document Size	Yes	Yes	Yes	Yes
Brightness	Yes	Yes	Yes	Yes
Contrast	Yes	Yes	Yes	Yes
Auto Crop	Yes	-	Yes	Yes
ID Card Scan	Yes	Yes	Yes	Yes
Advanced Settings	Yes	Yes	Yes	Yes
Default	Yes	Yes	Yes	Yes

File Type

Select the file type you want to use for the scanned data.

Target Application

Select the destination application from the drop-down list.

OCR Language

Set the optical character recognition (OCR) language to match the language of the scanned document's text (available only for certain models) .

Destination File Path

Click **Change** to change the file name's prefix and the destination folder path.

File Name

Type a prefix for your file name, if needed.

Insert Date in File Name

Select to automatically insert the date in the scanned image's file name.

Destination Folder

To change the folder for the **Image**, **OCR** and **E-mail** features, click **Change**. Click the folder icon, and then browse to the folder where you want to save your scanned document. Select the **Show Folder** option to automatically display the destination folder after scanning to a **File**.

File size

Adjust the data compression ratio of the scanned image. Change the file size by moving the **File size** slider to the right or left.

Resolution

Select a scanning resolution from the **Resolution** drop-down list. Higher resolutions take more memory and transfer time, but produce a finer scanned image.

Scan Type

Select from a range of scan colour depths.

- **Auto**
Use for any type of document. This mode automatically picks an appropriate colour depth for the document.
- **Black & White**
Use for text or line art images.
- **Grey (Error Diffusion)**
Use for photographic images or graphics. (Error Diffusion is a method for creating simulated grey images without using true grey dots. Black dots are put in a specific pattern to give a grey appearance.)
- **True Grey**
Use for photographic images or graphics. This mode is more accurate because it uses up to 256 shades of grey.
- **24bit Colour**
Use to create an image with the most accurate colour reproduction. This mode uses up to 16.8 million colours to scan the image, but it requires the most memory and has the longest transfer time.

Document Size

The document size is set to A4 by default. For faster scan speeds, select the exact size of your document from the **Document Size** drop-down list.

- If you select the **1 to 2 (A4)** option, the scanned image will be divided into two A5-size documents.

Brightness

Set the **Brightness** level by dragging the slider to the right or left to lighten or darken the image. If the scanned image is too light, set a lower brightness level and scan the document again. If the image is too dark, set a higher brightness level and scan the document again. You can also type a value into the field to set the **Brightness** level.

Contrast

Increase or decrease the **Contrast** level by moving the slider to the right or left. An increase emphasises dark and light areas of the image, while a decrease reveals more details in grey areas. You can also type a value into the field to set the **Contrast** level.

Auto Crop

Scan multiple documents placed on the scanner glass. The machine will scan each document and create separate files or a single multi-page file.

ID Card Scan

Select this check box to scan both sides of the identification card onto one page.

Advanced Settings

Click the **Advanced Settings** button in the scan settings dialog box to configure advanced settings.

- **Remove Background Colour**

Remove the base colour of documents to make the scanned data more recognisable. When you use this feature, choose from three settings: High, Medium and Low.

Default

Select this option to restore all settings to their factory setting values.



Related Information

- [Scan Using the Scan Button on Your Brother Machine](#)
-

Change Scan Button Settings from ControlCenter2 (Mac)

- In the **Finder** menu bar, click **Go > Applications > Brother**, and then double-click the  (**ControlCenter**) icon.
The **ControlCenter2** screen appears.
- Hold the **control** key on your keyboard and click the scan destination (**Image**, **OCR**, **E-mail**, or **File**) whose settings you want to change.
- Click the **Device Button** tab.
The settings for the scan destination that you selected appear.
The following example shows the **Scan to Image** settings.

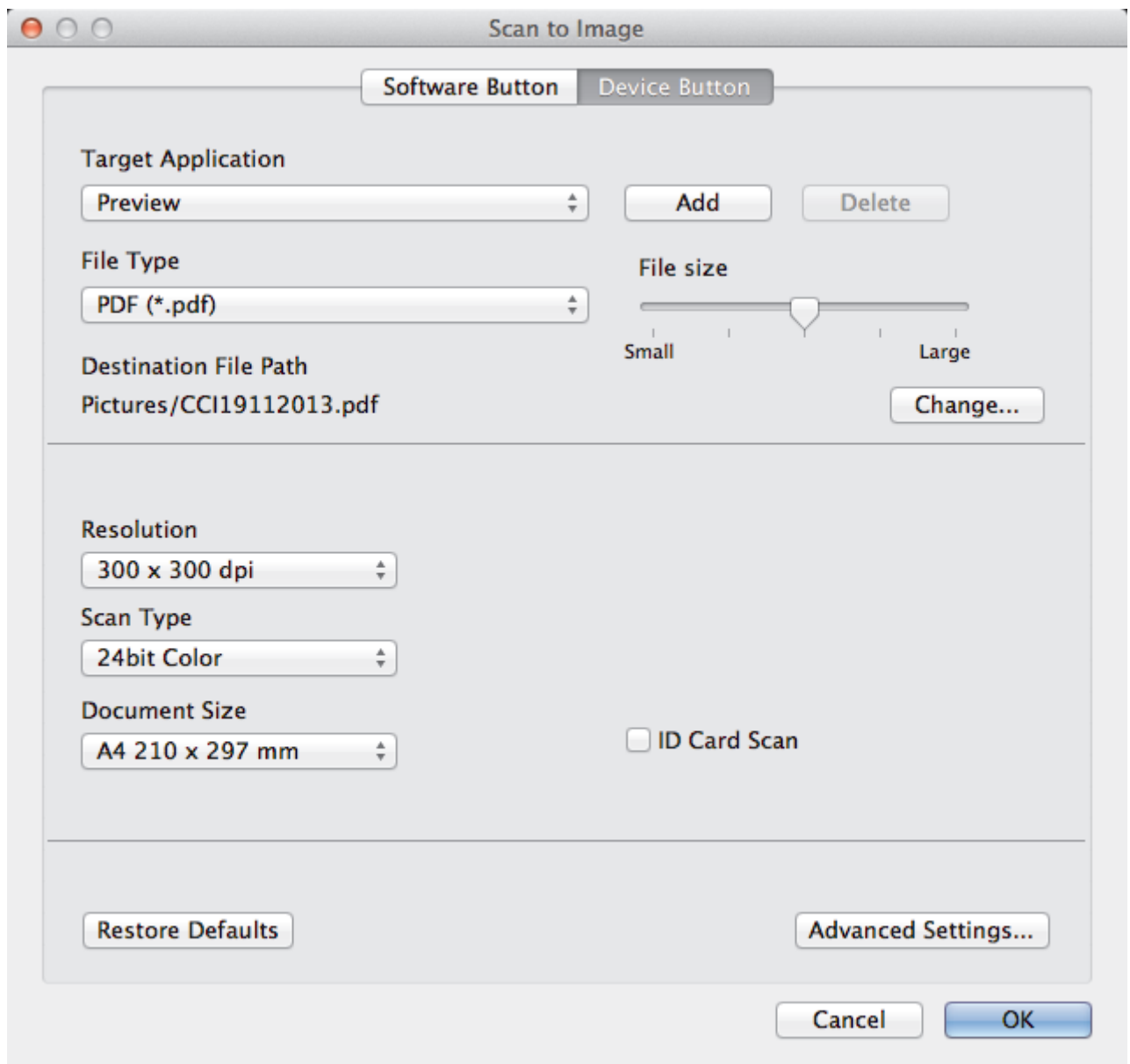

Settings	Applicable Features			
	Image	OCR	E-mail	File
Target Application /E-mail Application	Yes	Yes	Yes	-
File Type	Yes	Yes	Yes	Yes
File size	Yes	-	Yes	Yes

OCR Software (only available for certain models)	-	Yes	-	-
OCR Language (only available for certain models)	-	Yes	-	-
Destination File Path	Yes	Yes	Yes	-
File Name	Yes	Yes	Yes	Yes
Insert Date in File Name	Yes	Yes	Yes	Yes
Destination Folder	Yes	Yes	Yes	Yes
Resolution	Yes	Yes	Yes	Yes
Scan Type	Yes	Yes	Yes	Yes
Document Size	Yes	Yes	Yes	Yes
ID Card Scan	Yes	Yes	Yes	Yes
Advanced Settings	Yes	Yes	Yes	Yes
Restore Defaults	Yes	Yes	Yes	Yes

Target Application/E-mail Application

Select which application is used to open scanned data. Only applications installed on your computer can be selected.

- **Add**

Add an application to the pop-up menu.

Type the application name in the **Application Name** field (up to 30 characters) and select your preferred application by clicking the **Browse** button. Select the **File Type** option from the pop-up menu.

- **Delete**

Delete an application you have added to the pop-up menu.

Select the application from the **Application Name** pop-up menu, and then click **Delete**.

File Type

Select the file type you want to use for the scanned data.

File size

Change the file size by moving the **File size** slider to the right or left.

OCR Language

Set the optical character recognition (OCR) language to match the language of the scanned document's text (available only for certain models).

Destination File Path

Click the **Change** button to change the prefix of the file name and the path of the destination folder.

File Name

Type a prefix for your file name, if needed. To change the prefix for the **Image**, **OCR** and **E-mail** features, click **Change**.

Insert Date in File Name

Automatically inserts the date in the file name of the scanned image. To insert the date in the file name for the **Image**, **OCR** and **E-mail** features, click **Change**.

Destination Folder

To change the folder for the **Image**, **OCR** and **E-mail** features, click **Change**. Click **Browse** to select the folder where you want to save your scanned document. Select the **Show Folder** option to automatically display the destination folder after scanning to a **File**.

Resolution

Select a scanning resolution from the **Resolution** pop-up menu. Higher resolutions take more memory and transfer time, but produce a finer scanned image.

Scan Type

Select from a range of scan colour depths.

- **Black & White**
Use for text or line art images.
- **Gray (Error Diffusion)**
Use for photographic images or graphics. (Error Diffusion is a method for creating simulated grey images without using true grey dots. Black dots are put in a specific pattern to give a grey appearance.)
- **True Gray**
Use for photographic images or graphics. This mode is more accurate because it uses up to 256 shades of grey.
- **24bit Color**
Use to create an image with the most accurate colour reproduction. This mode uses up to 16.8 million colours to scan the image, but it requires the most memory and has the longest transfer time.
- **Auto**
Use for any type of document. This mode automatically picks an appropriate colour depth for the document.

Document Size

The document size is set to A4 by default. For faster scan speeds, select the exact size of your document from the **Document Size** drop-down list.

- If you select the **1 to 2 (A4)** option, the scanned image will be divided into two A5-size documents.

ID Card Scan

Select this check box to scan both sides of the identification card onto one page.

Advanced Settings

Click the **Advanced Settings** button in the scan settings dialog box to configure advanced settings.

- **Brightness**
Set the **Brightness** level by dragging the slider to the right or left to lighten or darken the image. If the scanned image is too light, set a lower brightness level and scan the document again. If the image is too dark, set a higher brightness level and scan the document again.
- **Contrast**
Increase or decrease the **Contrast** level by moving the slider to the right or left. An increase emphasises dark and light areas of the image, while a decrease reveals more details in grey areas.
- **Remove Background Color**
Remove the base colour of documents to make the scanned data more recognisable. When you use this feature, select from three settings: High, Medium and Low.

Restore Defaults

Select this option to restore all settings to their factory setting values.



Related Information

- [Scan Using the Scan Button on Your Brother Machine](#)
-

Scan from Your Computer (Windows®)

There are several ways you can use your computer to scan photos and documents on your Brother machine. Use the software applications provided by Brother, or use your favourite scanning application.

- [Scan Using ControlCenter4 Home Mode \(Windows®\)](#)
- [Scan Using ControlCenter4 Advanced Mode \(Windows®\)](#)
- [Scan Using Nuance™ PaperPort™ 14 or Other Windows® Applications](#)
- [Scan Using Windows® Photo Gallery or Windows® Fax and Scan](#)
- [Install BookScan Enhancer and Whiteboard Enhancer \(Windows®\)](#)

Scan Using ControlCenter4 Home Mode (Windows®)

Use ControlCenter4 Home Mode to access your machine's main features.

- [Scan Using ControlCenter4 Home Mode \(Windows®\)](#)
- [Save Scanned Data to a Folder as a PDF File Using ControlCenter4 Home Mode \(Windows®\)](#)
- [Scan Settings for ControlCenter4 Home Mode \(Windows®\)](#)
- [Change the Operation Mode in ControlCenter4 \(Windows®\)](#)

Scan Using ControlCenter4 Home Mode (Windows®)



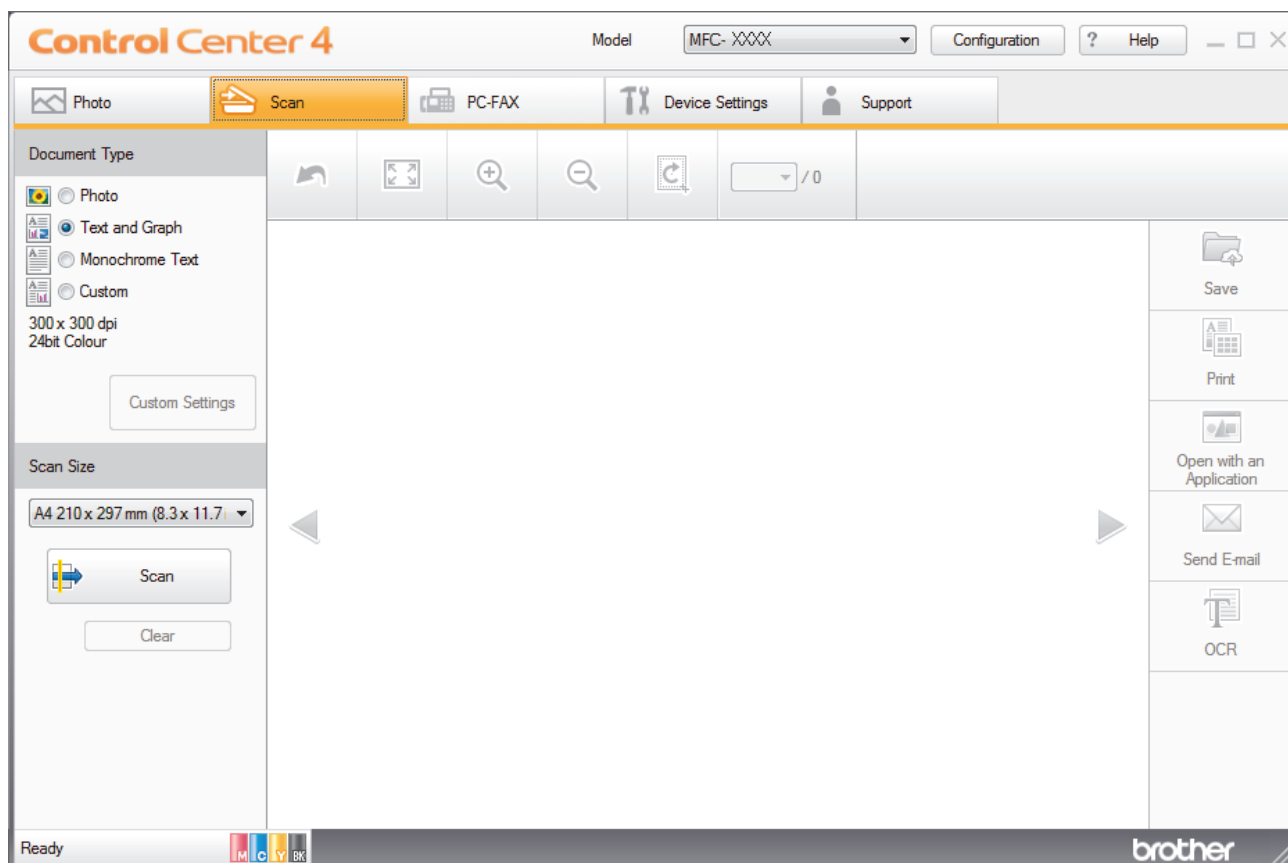

Select **Home Mode** as the mode setting for ControlCenter4.

1. Load your document.
2. Click the  (**ControlCenter4**) icon in the task tray, and then click **Open**.
3. Click the **Scan** tab.



4. Select the **Document Type**.
5. Change the document's **Scan Size**, if needed.
6. Click  (**Scan**).

The machine starts scanning, and the scanned image appears in the image viewer.

7. If you scanned multiple pages using the ADF, click the left or right arrow buttons to preview each scanned page. (ADF models only)
8. Crop the scanned image, if needed.
9. Do one of the following:
 - Click  (**Save**) to save scanned data.
 - Click  (**Print**) to print scanned data.
 - Click  (**Open with an Application**) to open scanned data in another application.
 - Click  (**Send E-mail**) to attach scanned data to an email.
 - Click  (**OCR**) to convert your scanned document to an editable text file. (available only for certain models)



Related Information

- [Scan Using ControlCenter4 Home Mode \(Windows®\)](#)
- [Select Document Type Using ControlCenter4 Home Mode \(Windows®\)](#)
- [Change Scan Size Using ControlCenter4 Home Mode \(Windows®\)](#)
- [Crop a Scanned Image Using ControlCenter4 Home Mode \(Windows®\)](#)
- [Print Scanned Data Using ControlCenter4 Home Mode \(Windows®\)](#)
- [Open with an Application Using ControlCenter4 Home Mode \(Windows®\)](#)

Home > Scan > Scan from Your Computer (Windows®) > Scan Using ControlCenter4 Home Mode (Windows®) > Scan Using ControlCenter4 Home Mode (Windows®) > Select Document Type Using ControlCenter4 Home Mode (Windows®)

Select Document Type Using ControlCenter4 Home Mode (Windows®)

- Select the **Document Type** option that matches the type of original you want to scan.

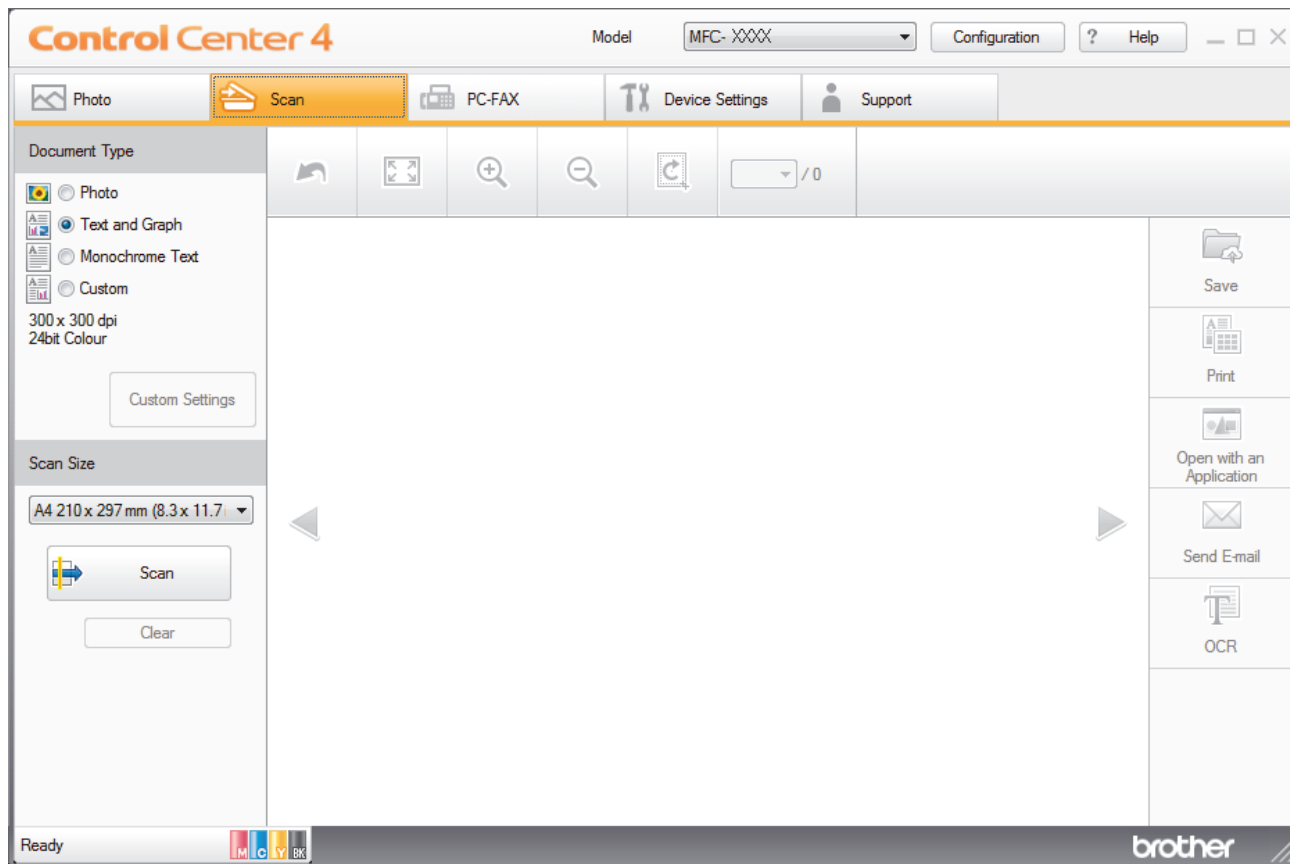

Option	Description
Photo	600 x 600 dpi 24bit Colour
Text and Graph	300 x 300 dpi 24bit Colour
Monochrome Text	200 x 200 dpi Black & White
Custom	300 x 300 dpi (24bit Colour as default) Select the scan settings you want from the Custom Settings button.

✓ Related Information

- [Scan Using ControlCenter4 Home Mode \(Windows®\)](#)
- [Custom Scan Settings \(Windows®\)](#)

Custom Scan Settings (Windows®)

Select **Custom** in the **Document Type** list to change advanced scan settings.

- Select **Custom**, and then click the **Custom Settings** button.

The **Custom Scan Settings** dialog box appears.

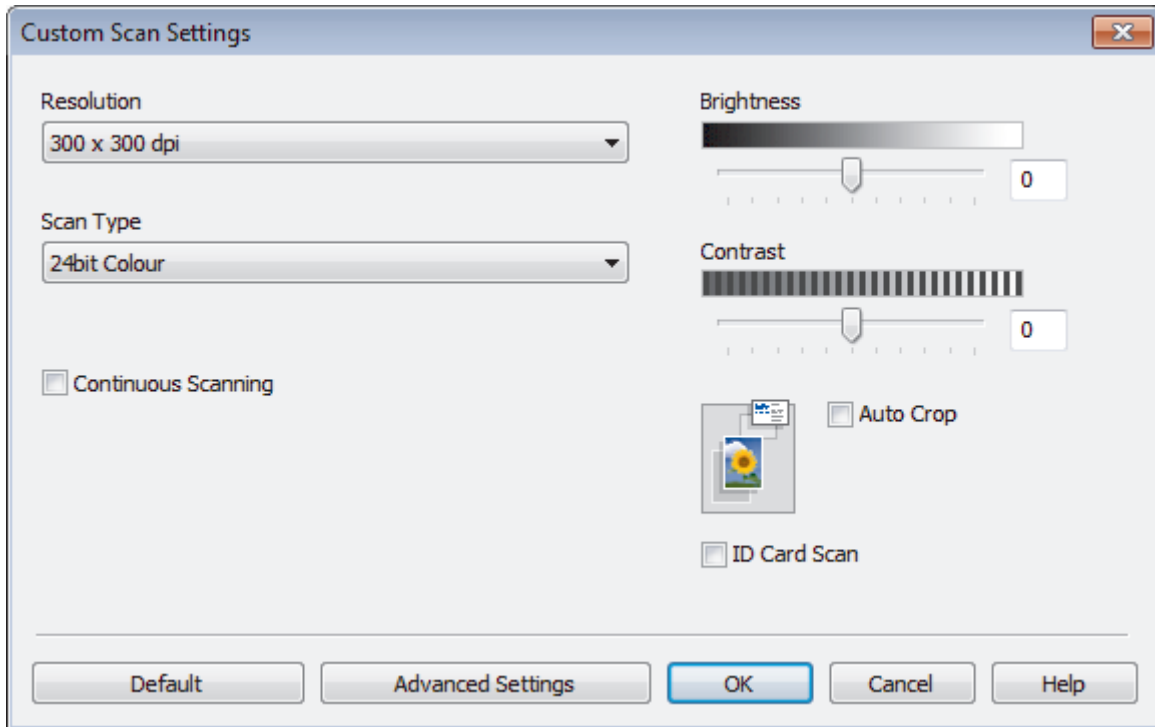

You can change the following settings:

Resolution

Select a scanning resolution from the **Resolution** drop-down list. Higher resolutions take more memory and transfer time, but produce a finer scanned image.

Scan Type

Select from a range of scan colour depths.

- Auto

Use for any type of document. This mode automatically picks an appropriate colour depth for the document.

- Black & White

Use for text or line art images.

- Grey (Error Diffusion)

Use for photographic images or graphics. (Error Diffusion is a method for creating simulated grey images without using true grey dots. Black dots are put in a specific pattern to give a grey appearance.)

- True Grey

Use for photographic images or graphics. This mode is more accurate because it uses up to 256 shades of grey.

- 24bit Colour

Use to create an image with the most accurate colour reproduction. This mode uses up to 16.8 million colours to scan the image, but it requires the most memory and has the longest transfer time.

Brightness

Set the **Brightness** level by dragging the slider to the right or left to lighten or darken the image. If the scanned image is too light, set a lower brightness level and scan the document again. If the image is too dark, set a higher brightness level and scan the document again. You can also type a value into the field to set the **Brightness** level.

Contrast

Increase or decrease the **Contrast** level by moving the slider to the right or left. An increase emphasises dark and light areas of the image, while a decrease reveals more details in grey areas. You can also type a value into the field to set the **Contrast** level.

Auto Crop

Scan multiple documents placed on the scanner glass. The machine will scan each document and create separate files or a single multi-page file.

Continuous Scanning

Select this option to scan multiple pages from the scanner glass or ADF (available only for certain models) . After a page is scanned, either continue scanning or finish. Use this method to scan more pages than the maximum ADF capacity.

ID Card Scan

Select this check box to scan both sides of the identification card onto one page.

Advanced Settings

Configure advanced settings by clicking the **Advanced Settings** button in the Scan Settings dialog box.

- **Remove Background Colour**

Remove the base colour of documents to make the scanned data more legible. Choose from three settings: high, medium, and low.



Related Information

- [Select Document Type Using ControlCenter4 Home Mode \(Windows®\)](#)
-

Home > Scan > Scan from Your Computer (Windows®) > Scan Using ControlCenter4 Home Mode (Windows®) > Scan Using ControlCenter4 Home Mode (Windows®) > Change Scan Size Using ControlCenter4 Home Mode (Windows®)

Change Scan Size Using ControlCenter4 Home Mode (Windows®)

For faster scan speeds, select the exact size of your document from the **Scan Size** drop-down menu. **Auto** means that the machine will automatically detect the document size.

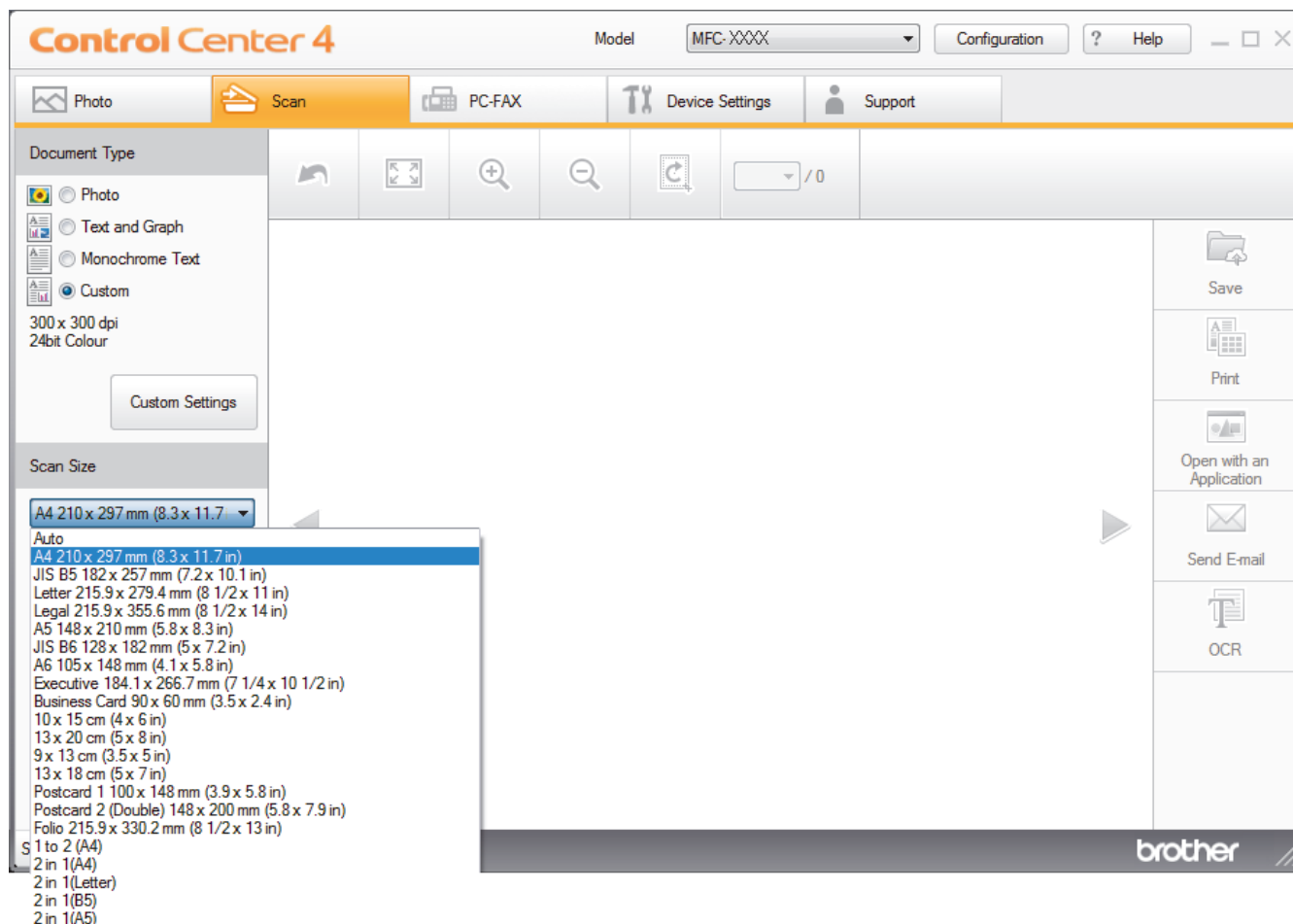

✓ Related Information

- [Scan Using ControlCenter4 Home Mode \(Windows®\)](#)

Crop a Scanned Image Using ControlCenter4 Home Mode (Windows®)

The crop tool on the Image Editing Toolbar lets you trim unwanted areas from your scanned image. Use the **Zoom In** and **Zoom Out** tools to help view the image to be cropped.

Image Editing Toolbar

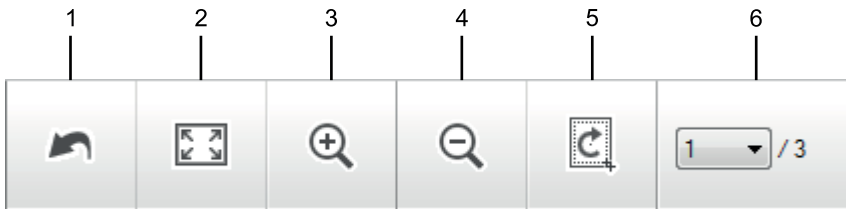

1. Restart

Cancels all the edits applied to the selected image. The edited image returns to its original state.

2. Fit to Window

Displays the scanned image so that the entire image fits in the window.

3. Zoom In

Zooms in on the scanned image.

4. Zoom Out

Zooms out of the scanned image.

5. Crop and Edit

Removes the outer parts of the image. Click the **Crop and Edit** button, and then change the frame to contain the area you want to keep after cropping.

6. Page Select

Indicates the page number of the scanned page currently shown in the image viewer. To display a different page, select the desired page number from the drop-down page number list.



If you have scanned multiple pages, you can see the next or previous scanned page by clicking the left or right arrow buttons in the preview window.

1. Scan a document.

2. Click  (**Crop and Edit**) to edit the scanned image.

The **Crop and Edit - ControlCenter4** window appears.

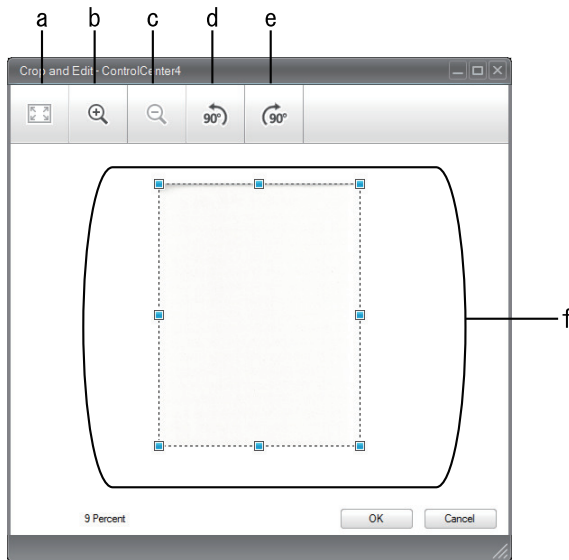

- a. Expands the scanned image so that the entire image fits in the window.
 - b. Zooms in on the image.
 - c. Zooms out of the image.
 - d. Rotates the image counter-clockwise 90 degrees.
 - e. Rotates the image clockwise 90 degrees.
 - f. Click and drag the frame to adjust the area to be cropped.
3. Click **OK**.
- The edited image is displayed in the image viewer.

✓ Related Information

- [Scan Using ControlCenter4 Home Mode \(Windows®\)](#)

Home > Scan > Scan from Your Computer (Windows®) > Scan Using ControlCenter4 Home Mode (Windows®) > Scan Using ControlCenter4 Home Mode (Windows®) > Print Scanned Data Using ControlCenter4 Home Mode (Windows®)

Print Scanned Data Using ControlCenter4 Home Mode (Windows®)

Scan a document on your Brother machine, and then print copies using the printer driver features that are available in ControlCenter4.

1. Scan a document.
2. Click **Print**.

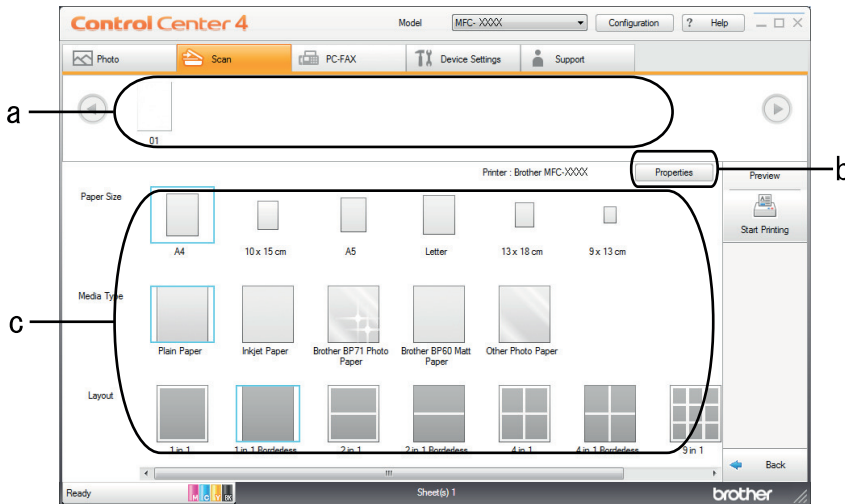

- a. Shows which images are currently selected, and how many copies of each image will print.
 - b. Click the **Properties** button to change specific printer settings.
 - c. Select the **Paper Size**, **Media Type** and **Layout** options. The current settings are enclosed in a blue square.
3. Configure the print settings, and then click the **Start Printing** button.



Related Information

- [Scan Using ControlCenter4 Home Mode \(Windows®\)](#)

🏠 [Home](#) > [Scan](#) > [Scan from Your Computer \(Windows®\)](#) > [Scan Using ControlCenter4 Home Mode \(Windows®\)](#) > [Scan Using ControlCenter4 Home Mode \(Windows®\)](#) > [Open with an Application Using ControlCenter4 Home Mode \(Windows®\)](#)

Open with an Application Using ControlCenter4 Home Mode (Windows®)

The **Open with an Application** button lets you scan an image directly into your graphics application for editing.

1. Click the **Open with an Application** button.
2. Select the application from the drop-down list, and then click **OK**.

The image will be opened in the application you have selected.



Related Information

- [Scan Using ControlCenter4 Home Mode \(Windows®\)](#)
-

Save Scanned Data to a Folder as a PDF File Using ControlCenter4 Home Mode (Windows®)

Select **Home Mode** as the mode setting for ControlCenter4.

1. Load your document.
2. Click the  (ControlCenter4) icon in the task tray, and then click **Open**.
3. Click the **Scan** tab.

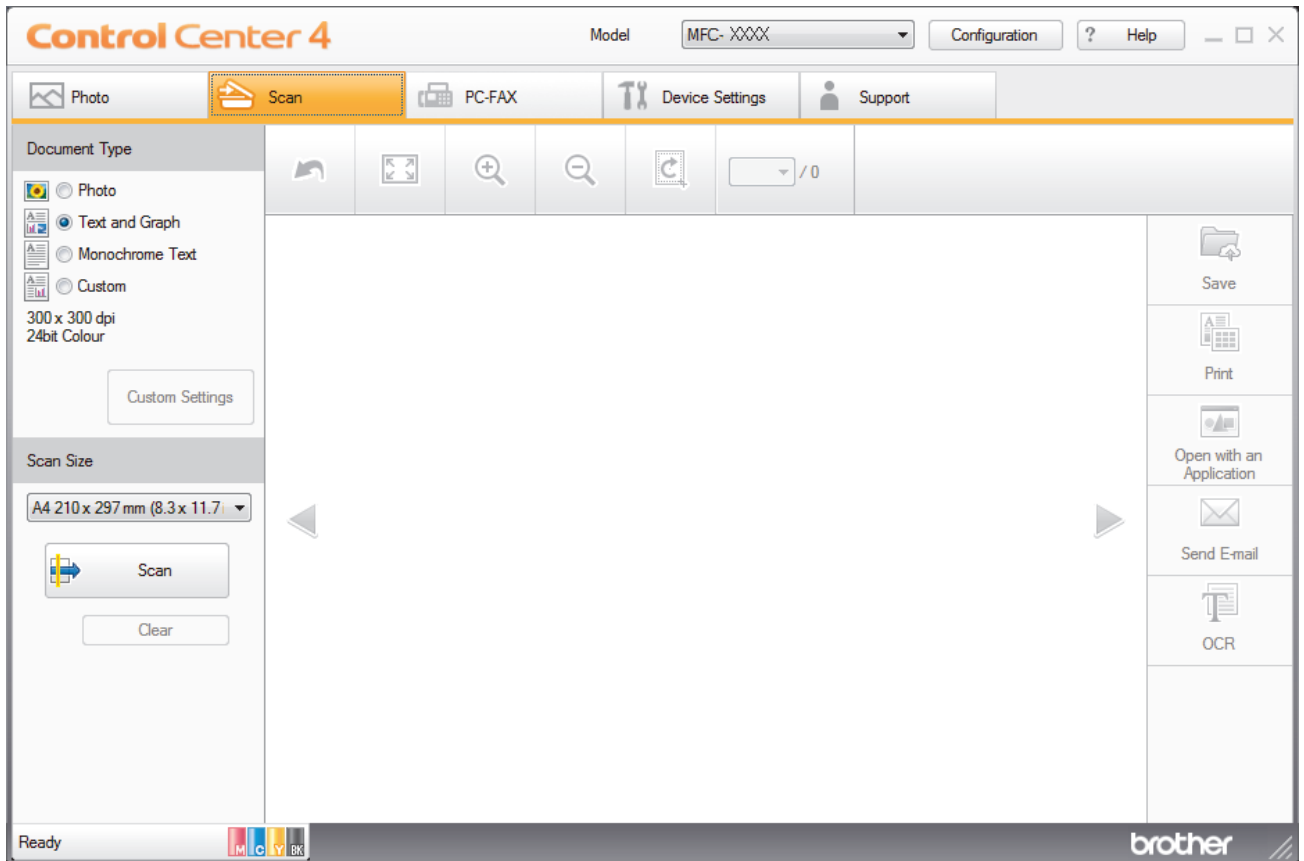

4. Select the **Document Type**.
5. Change the size of your document, if needed.
6. Click  (**Scan**).
The machine starts scanning, and the scanned image appears in the image viewer.
7. Click the left or right arrow buttons to preview each scanned page.
8. Click **Save**.
The **Save** dialog box appears.
9. Click the **File Type** drop-down list, and then select **PDF (*.pdf)**.

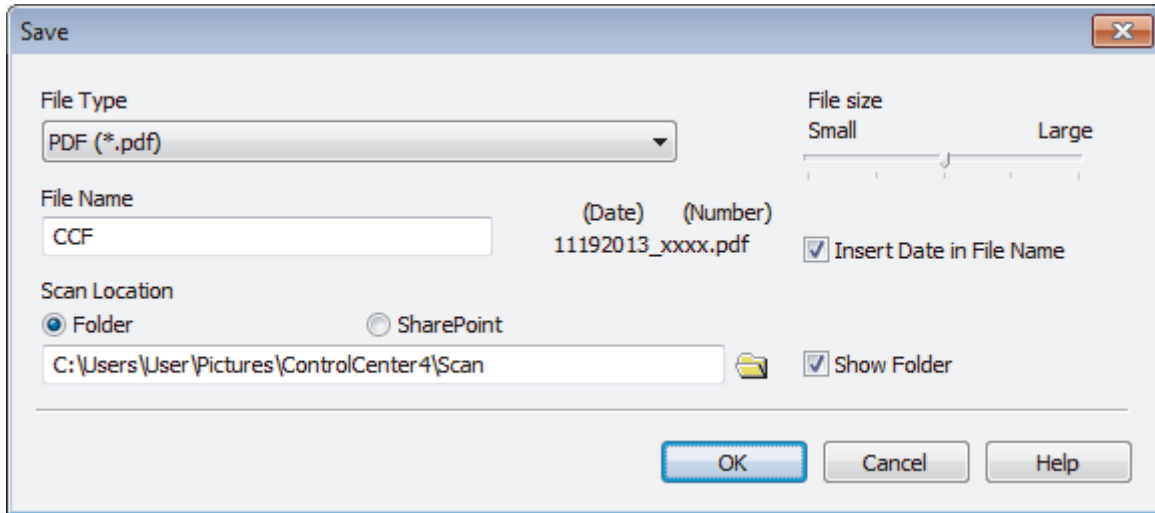

To save the document as a password-protected PDF, select **Secure PDF (*.pdf)** from the **File Type** drop-down list, click , and then type the password.

10. In the **File Name** field, type a prefix for your file name, if needed.
11. Click the folder icon to browse and select the folder where you want to save your scanned documents.
12. Click **OK**.

The scanned document is saved to the destination folder as a PDF.



Related Information

- [Scan Using ControlCenter4 Home Mode \(Windows®\)](#)

Scan Settings for ControlCenter4 Home Mode (Windows®)

Settings	Applicable Features			
	Open with an Application	OCR	Send E-mail	Save
File Type	-	Yes	Yes	Yes
Target Application	Yes	Yes	-	-
OCR Language (available only for certain models)	-	Yes	-	-
File Name	-	-	-	Yes
Insert Date in File Name	-	-	-	Yes
Scan Location	-	-	-	Yes
Show Folder	-	-	-	Yes
File size	-	-	Yes	Yes

File Type

Select the file type you want to use for the scanned data.

For **Send E-mail** and **Save**:

- **Windows Bitmap (*.bmp)**
- **JPEG (*.jpg)** (recommended for most users when scanning pictures)
- **TIFF (*.tif)**
- **TIFF Multi-Page (*.tif)**
- **Portable Network Graphics (*.png)**
- **PDF (*.pdf)** (recommended for scanning and sharing documents)
- **High Compression PDF (*.pdf)**
- **Secure PDF (*.pdf)**
- **Searchable PDF (*.pdf)** (available only for certain models)
- **XML Paper Specification (*.xps)** (the XML Paper Specification is available for Windows Vista®, Windows® 7, Windows® 8 and Windows® 10, or when using applications that support XML Paper Specification files)
- **Microsoft Office Word (*.docx)** (available only for certain models)
- **Microsoft Office PowerPoint (*.pptx)** (available only for certain models)

For **OCR**:

- **Text (*.txt)**
- **HTML 3.2 (*.htm)**
- **HTML 4.0 (*.htm)**
- **Searchable PDF (*.pdf)**
- **WordPad (*.rtf)**
- **RTF Word 2000 (*.rtf)**
- **WordPerfect 9, 10 (*.wpd)**
- **Microsoft Excel 2003, XP (*.xls)**

Target Application

Select the destination application from the drop-down list.

OCR Language

Set the optical character recognition (OCR) language to match the language of the scanned document's text (available only for certain models) .

File Name

Type a prefix for your file name, if needed.

Insert Date in File Name

Select to automatically insert the date in the scanned image's file name.

Scan Location

Select the **Folder** or **SharePoint** radio button to specify the destination where you want to save your scanned documents.

Show Folder

Select this option to automatically display the destination folder after scanning.

File size

Adjust the data compression ratio of the scanned image. Change the file size by moving the **File size** slider to the right or left.

Custom Settings

Select the **Custom** option, click the **Custom Settings** button, and then change settings.

Scan Size

Select the exact size of your document from the **Scan Size** drop-down menu.



Related Information

- [Scan Using ControlCenter4 Home Mode \(Windows®\)](#)

Scan Using ControlCenter4 Advanced Mode (Windows®)

ControlCenter4 Advanced Mode gives you more control over the details of your machine's features and allows you to customise one-button scan actions.

- [Scan Photos and Graphics Using ControlCenter4 Advanced Mode \(Windows®\)](#)
- [Save Scanned Data to a Folder as a PDF File Using ControlCenter4 Advanced Mode \(Windows®\)](#)
- [Scan Both Sides of an ID Card Using ControlCenter4 Advanced Mode \(Windows®\)](#)
- [Scan to E-mail Attachment Using ControlCenter4 Advanced Mode \(Windows®\)](#)
- [Scan to an Editable Text File \(OCR\) Using ControlCenter4 Advanced Mode \(Windows®\)](#)
- [Scan to an Office File Using ControlCenter4 Advanced Mode \(Windows®\)](#)
- [Scan Settings for ControlCenter4 Advanced Mode \(Windows®\)](#)
- [Change the Operation Mode in ControlCenter4 \(Windows®\)](#)

Scan Photos and Graphics Using ControlCenter4 Advanced Mode (Windows®)

Send scanned photos or graphics directly to your computer.



Select **Advanced Mode** as the mode setting for ControlCenter4.

1. Load your document.
2. Click the  (ControlCenter4) icon in the task tray, and then click **Open**.
3. Click the **Scan** tab.



4. Click the **Image** button.
The scan settings dialog box appears.

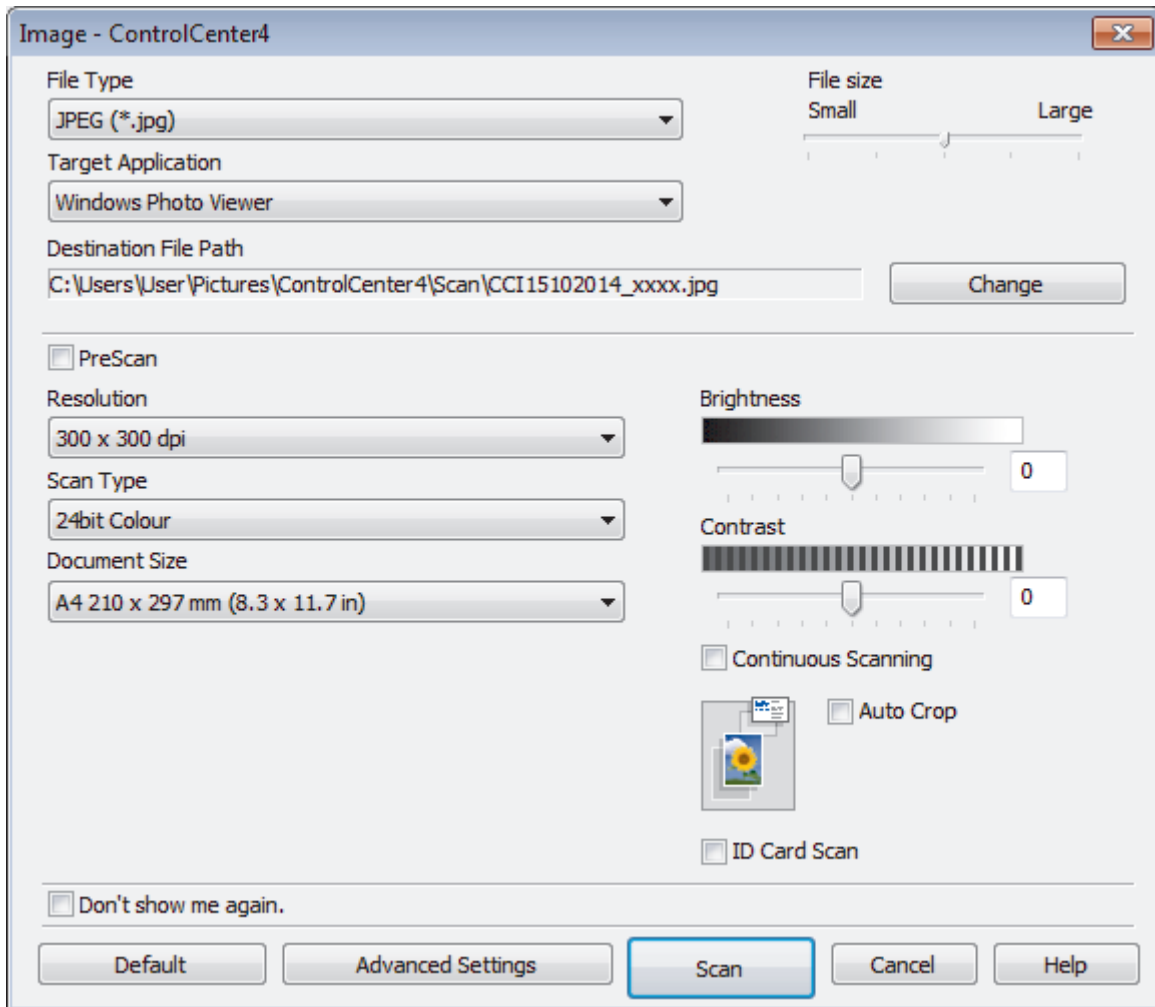

5. Change the scan settings, such as file format, file name, destination file path, resolution, or colour, if needed.



- To change the file name or **Destination File Path**, click **Change**.
- To preview and configure the scanned image, select the **PreScan** check box.

6. Click **Scan**.

The machine starts scanning. The image opens in the application you have selected.



Related Information

- [Scan Using ControlCenter4 Advanced Mode \(Windows®\)](#)

Home > Scan > Scan from Your Computer (Windows®) > Scan Using ControlCenter4 Advanced Mode (Windows®) > Save Scanned Data to a Folder as a PDF File Using ControlCenter4 Advanced Mode (Windows®)

Save Scanned Data to a Folder as a PDF File Using ControlCenter4 Advanced Mode (Windows®)

Scan documents and save them to a folder on your computer as PDF files.



Select **Advanced Mode** as the mode setting for ControlCenter4.

1. Load your document.
2. Click the  (ControlCenter4) icon in the task tray, and then click **Open**.
3. Click the **Scan** tab.



- Click the **File** button.

The scan settings dialog box appears.

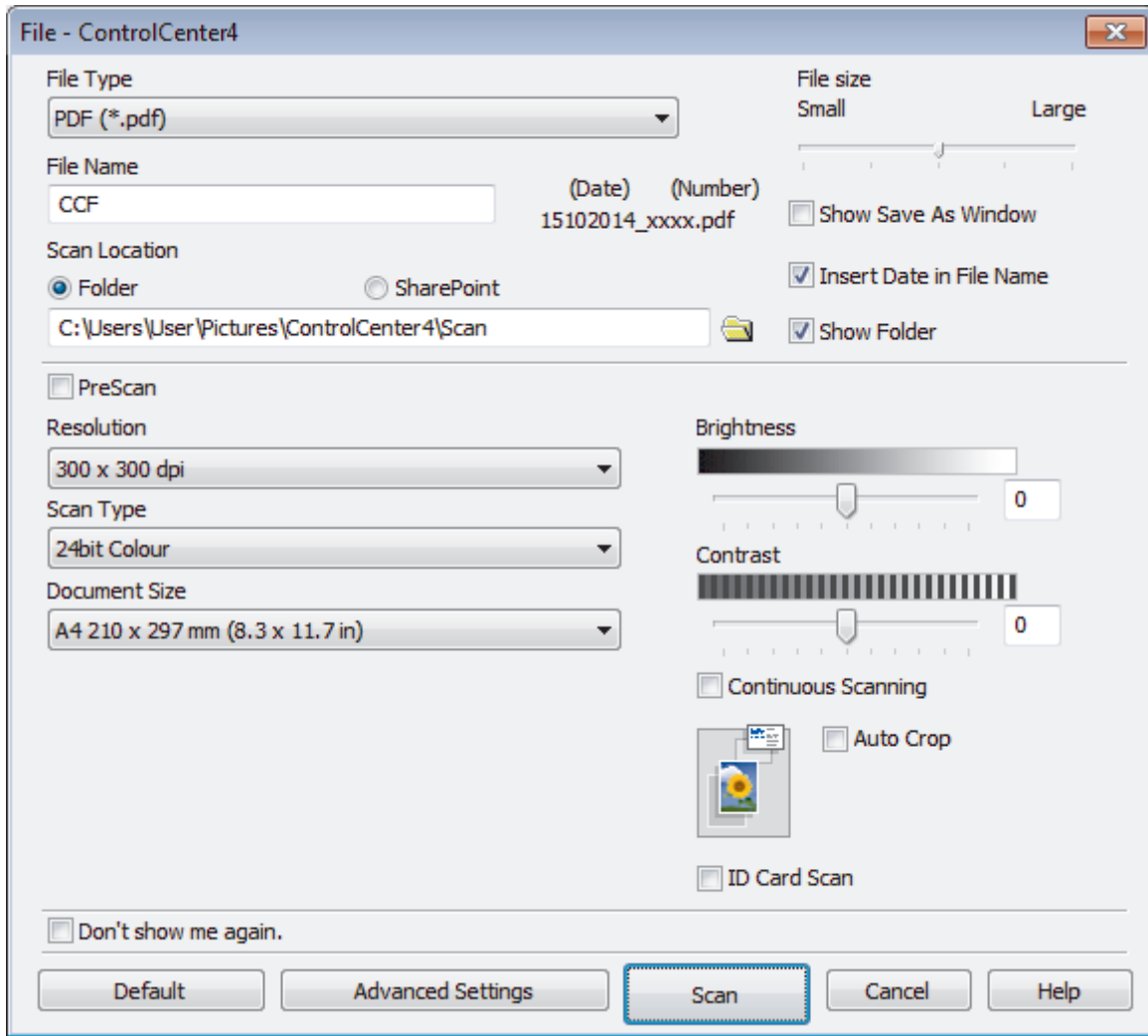

- Click the **File Type** drop-down list, and then select **PDF (*.pdf)**.



To save the document as a password-protected PDF, select **Secure PDF (*.pdf)** from the **File Type** drop-down list, click , and then type the password.

- Click the folder icon to browse and select the folder where you want to save your scanned documents.
- Change the scan settings, such as file format, file name, resolution or colour, if needed.



To preview and configure the scanned image, select the **PreScan** check box.

- Click **Scan**.

The machine starts scanning. The file is saved in the folder you selected.



Related Information

- [Scan Using ControlCenter4 Advanced Mode \(Windows®\)](#)

Scan Both Sides of an ID Card Using ControlCenter4 Advanced Mode (Windows®)

Select **Advanced Mode** as the mode setting for ControlCenter4.

1. Place an ID card on the scanner glass.
2. Click the  (ControlCenter4) icon in the task tray, and then click **Open**.
3. Click the **Scan** tab.

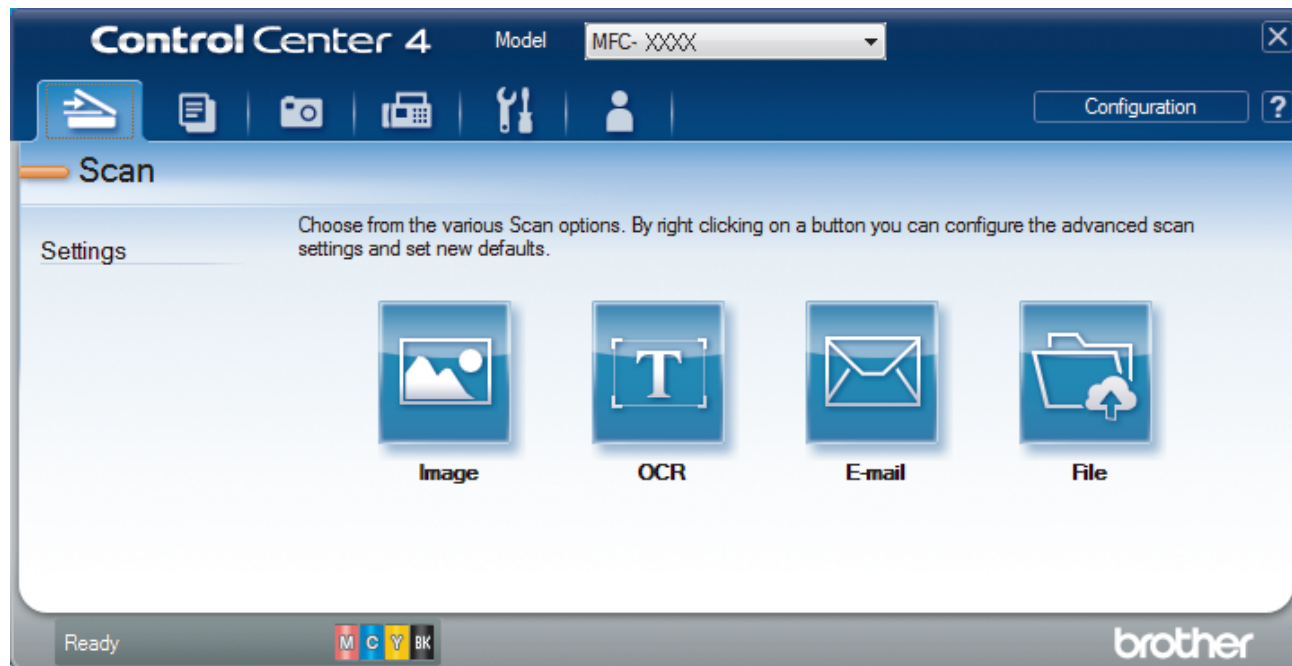

- Click the **File** button.

The scan settings dialog box appears.

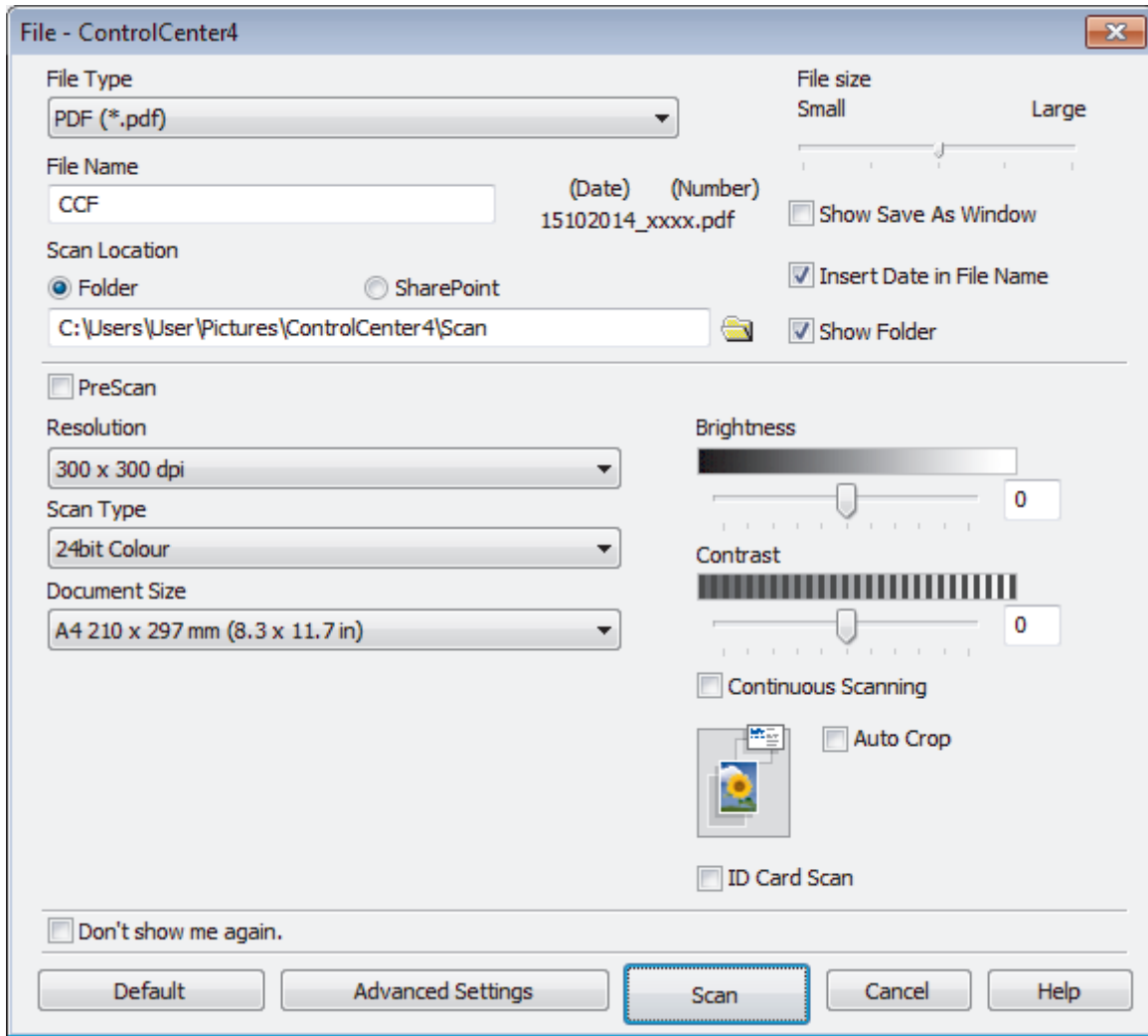

- Select the **ID Card Scan** check box.

The instruction dialog box appears.

- Read the instructions on the screen, and then press **OK**.
- Change the scan settings, such as file format, file name, scan location, resolution, or colour, if needed.
- Click **Scan**.

The machine starts scanning one side of the identification card.

- After the machine has scanned one side, turn over the identification card, and then click **Continue** to scan the other side.
- Click **Finish**.

✓ Related Information

- [Scan Using ControlCenter4 Advanced Mode \(Windows®\)](#)

Scan to E-mail Attachment Using ControlCenter4 Advanced Mode (Windows®)

Send a scanned document as an email attachment.



- Select **Advanced Mode** as the mode setting for ControlCenter4.
- The Scan to E-mail feature does not support Webmail services. Use the Scan to Image or Scan to File feature to scan a document or a picture, and then attach the scanned file to an email message.



The machine scans to your default email client.

1. Load your document.
2. Click the  (**ControlCenter4**) icon in the task tray, and then click **Open**.
3. Click the **Scan** tab.



4. Click the **E-mail** button.
The scan settings dialog box appears.

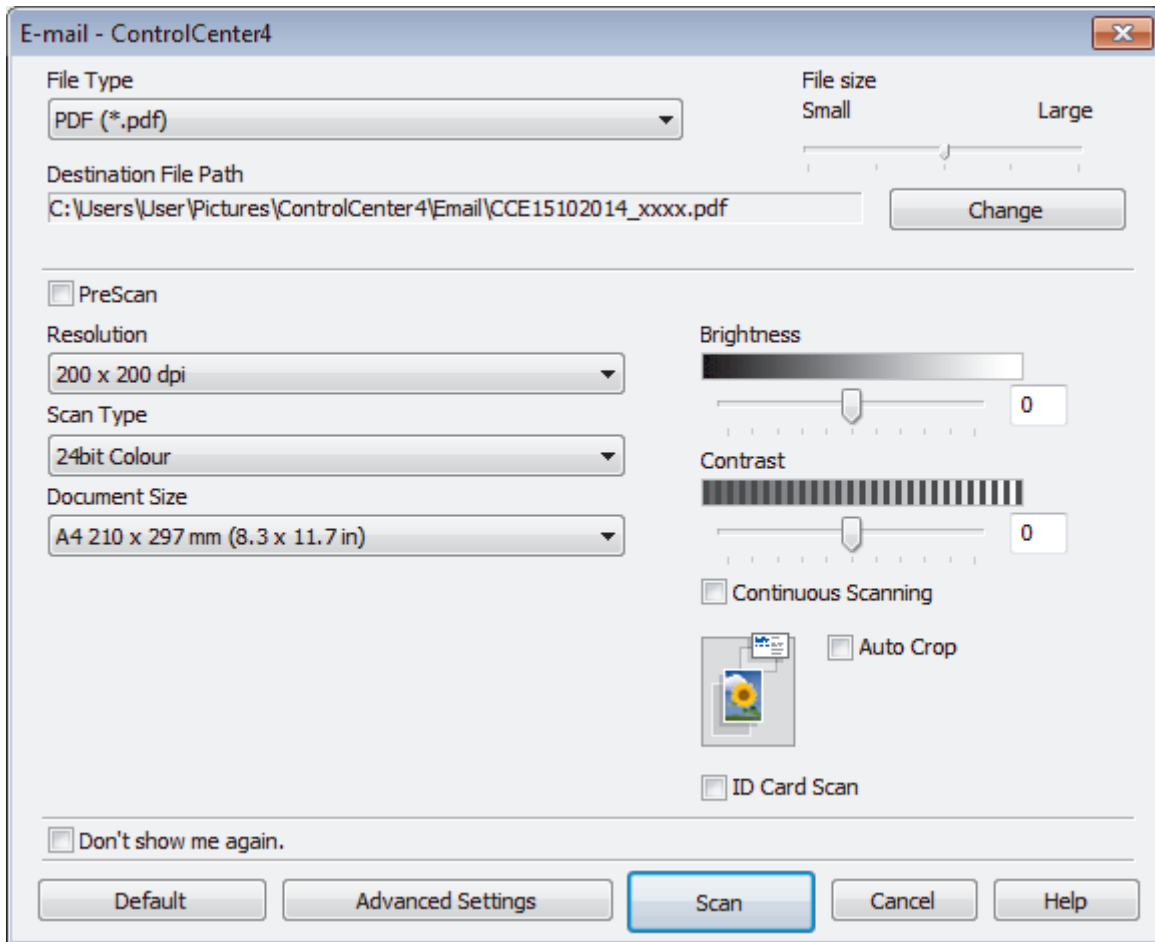

5. Change the scan settings, such as file format, file name, destination file path, resolution, or colour, if needed.



- To change the file name or **Destination File Path**, click **Change**.
- To preview and configure the scanned image, select the **PreScan** check box.

6. Click **Scan**.

The machine starts scanning. Your default email application opens and the scanned image is attached to a new, blank email message.



Related Information

- [Scan Using ControlCenter4 Advanced Mode \(Windows®\)](#)

Scan to an Editable Text File (OCR) Using ControlCenter4 Advanced Mode (Windows®)

Your machine can convert characters in a scanned document to text data using optical character recognition (OCR) technology. You can edit this text using your preferred text-editing application.



- Select **Advanced Mode** as the mode setting for ControlCenter4.

1. Load your document.
2. Click the  (ControlCenter4) icon in the task tray, and then click **Open**.
3. Click the **Scan** tab.

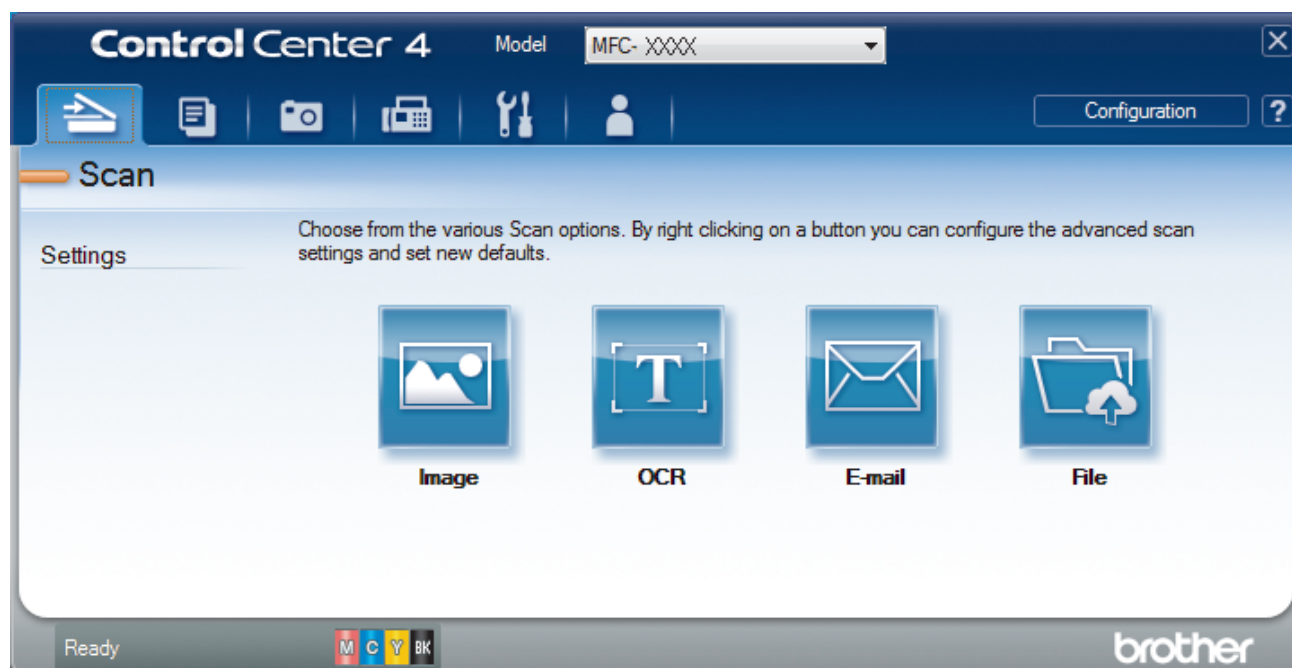

4. Click the **OCR** button.
The scan settings dialog box appears.

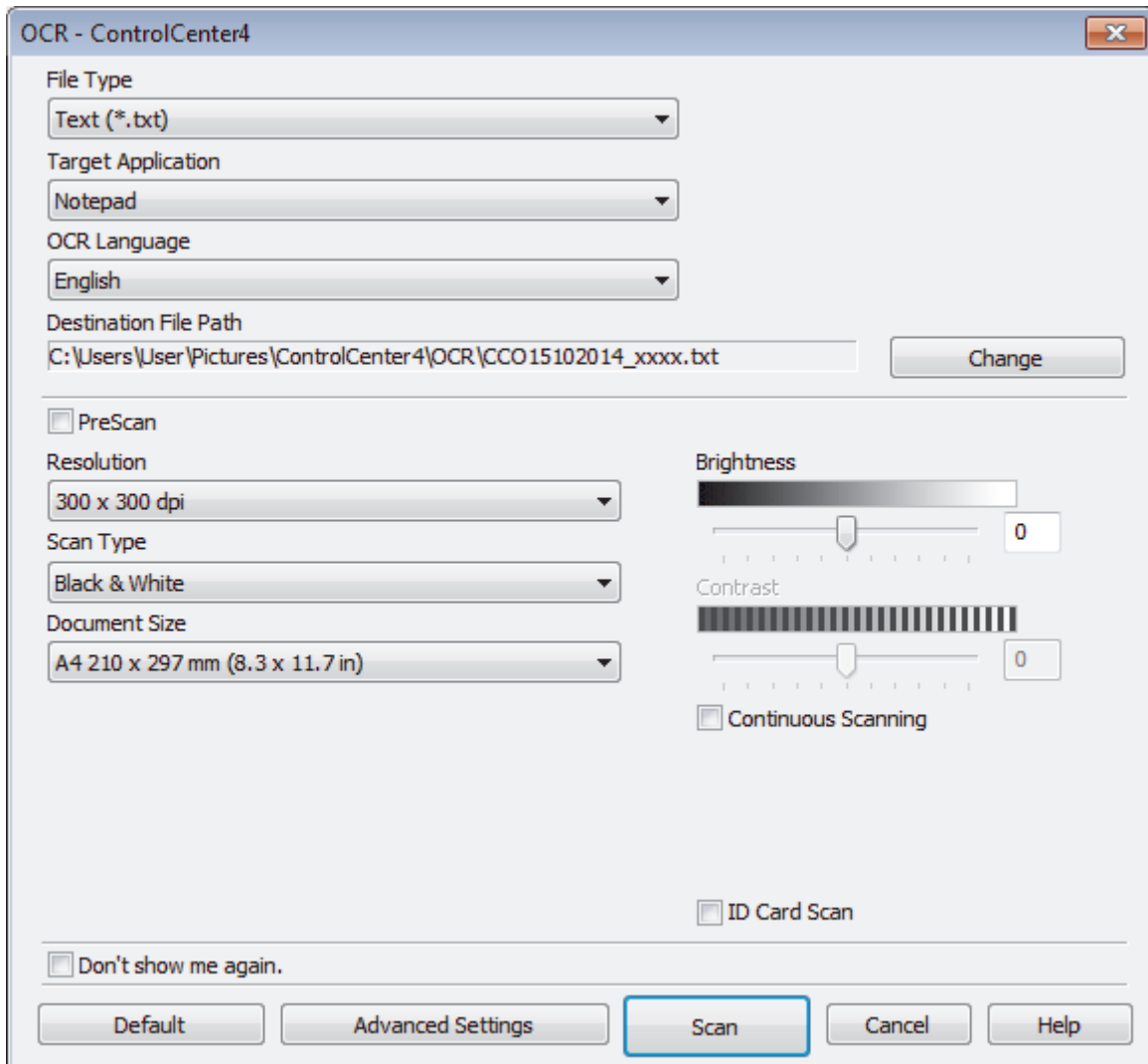

5. Change the scan settings, such as file format, file name, destination file path, resolution, or colour, if needed.



- To change the file name or **Destination File Path**, click **Change**.
- To preview and configure the scanned image, select the **PreScan** check box.

6. Click **Scan**.

The machine scans the document, converts it to editable text, and then sends it to your default word processing application.



Related Information

- [Scan Using ControlCenter4 Advanced Mode \(Windows®\)](#)

Scan to an Office File Using ControlCenter4 Advanced Mode (Windows®)

Your machine can convert scanned data to a Microsoft® Word file or a Microsoft® PowerPoint® file.

- Select **Advanced Mode** as the mode setting for ControlCenter4.
- In order to use this feature, your Brother machine must be connected to a network that has access to the Internet through either a wired or wireless connection.

1. Load your document.
2. Click the  (**ControlCenter4**) icon in the task tray, and then click **Open**.
3. Click the **Scan** tab.

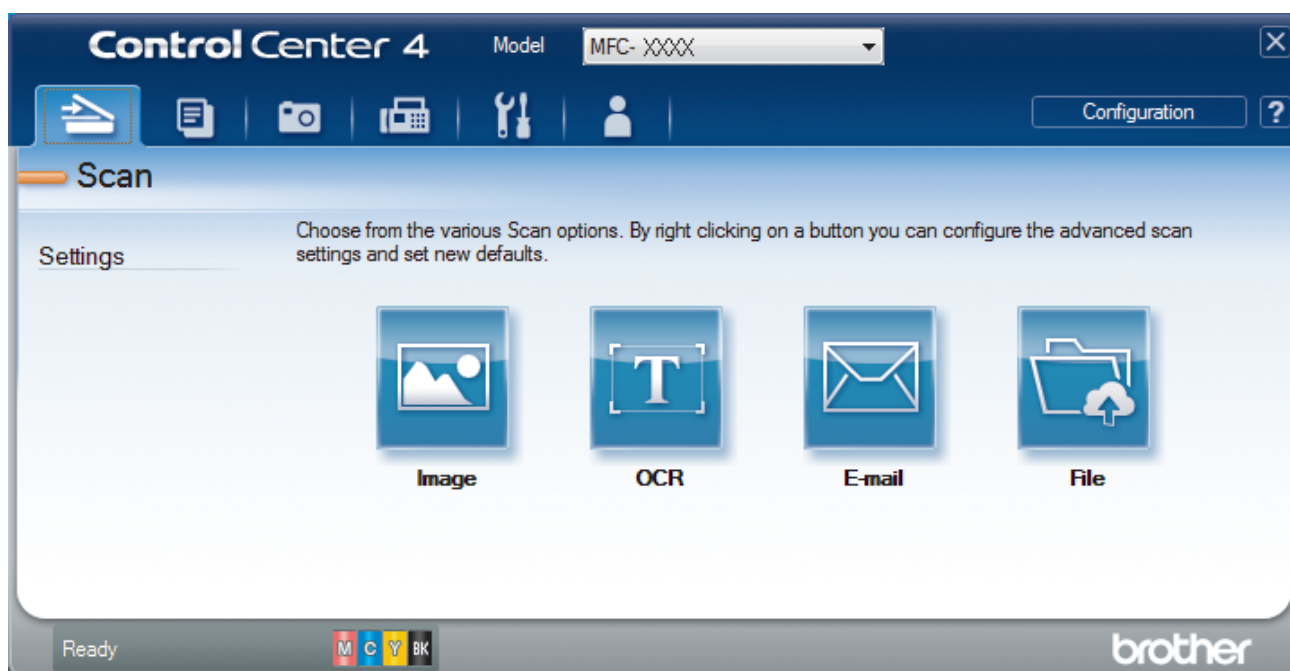

4. Click the **E-mail** or **File** button.
The scan settings dialog box appears.
5. Click the **File Type** drop-down list, and then select the **Microsoft Office Word (*.docx)** or **Microsoft Office PowerPoint (*.pptx)** option.
6. Change the scan settings, if needed.
7. Click the **Scan** button.
If a message dialog box regarding the Internet connection appears, read the information and click **OK**.

✓ Related Information

- [Scan Using ControlCenter4 Advanced Mode \(Windows®\)](#)

Scan Settings for ControlCenter4 Advanced Mode (Windows®)

Settings	Applicable Features			
	Image	OCR	E-mail	File
File Type	Yes	Yes	Yes	Yes
Target Application	Yes	Yes	-	-
OCR Language (available only for certain models)	-	Yes	-	-
Destination File Path	Yes	Yes	Yes	-
File Name	Yes	Yes	Yes	Yes
Insert Date in File Name	Yes	Yes	Yes	Yes
Show Save As Window	-	-	-	Yes
Destination Folder	Yes	Yes	Yes	-
Scan Location	-	-	-	Yes
Show Folder	-	-	-	Yes
File size	Yes	-	Yes	Yes
PreScan	Yes	Yes	Yes	Yes
Resolution	Yes	Yes	Yes	Yes
Scan Type	Yes	Yes	Yes	Yes
Document Size	Yes	Yes	Yes	Yes
Brightness	Yes	Yes	Yes	Yes
Contrast	Yes	Yes	Yes	Yes
Continuous Scanning	Yes	Yes	Yes	Yes
Auto Crop	Yes	-	Yes	Yes
ID Card Scan	Yes	Yes	Yes	Yes
Advanced Settings	Yes	Yes	Yes	Yes
Default	Yes	Yes	Yes	Yes

File Type

Select the file type you want to use for the scanned data.

For **Image**, **E-mail** and **File**:

- **Windows Bitmap (*.bmp)**
- **JPEG (*.jpg)** (recommended for most users when scanning pictures)
- **TIFF (*.tif)**
- **TIFF Multi-Page (*.tif)**
- **Portable Network Graphics (*.png)**
- **PDF (*.pdf)** (recommended for scanning and sharing documents)
- **High Compression PDF (*.pdf)**
- **Secure PDF (*.pdf)**
- **Searchable PDF (*.pdf)** (available only for certain models)
- **XML Paper Specification (*.xps)** (the XML Paper Specification is available for Windows Vista®, Windows® 7, Windows® 8 and Windows® 10, or when using applications that support XML Paper Specification files)

For **OCR**:

-
- **Text (*.txt)**
 - **HTML 3.2 (*.htm)**
 - **HTML 4.0 (*.htm)**
 - **Searchable PDF (*.pdf)**
 - **WordPad (*.rtf)**
 - **RTF Word 2000 (*.rtf)**
 - **WordPerfect 9, 10 (*.wpd)**
 - **Microsoft Excel 2003, XP (*.xls)**

For **E-mail** and **File**:

- **Microsoft Office Word (*.docx)** (available only for certain models)
- **Microsoft Office PowerPoint (*.pptx)** (available only for certain models)

Target Application

Select the destination application from the drop-down list.

OCR Language

Set the optical character recognition (OCR) language to match the language of the scanned document's text (available only for certain models).

Destination File Path

Click **Change** to change the file name's prefix and the destination folder path.

File Name

Type a prefix for your file name, if needed.

Insert Date in File Name

Select to automatically insert the date in the scanned image's file name.

Show Save As Window

Select this option to specify the scanned image's destination every time you scan.

Destination Folder

To change the folder for the **Image**, **OCR** and **E-mail** features, click **Change**. Click the folder icon, and then browse to the folder where you want to save your scanned document.

Scan Location

Select the **Folder** or **SharePoint** radio button to specify the destination where you want to save your scanned documents.

Show Folder

Select this option to automatically display the destination folder after scanning.

File size

Adjust the data compression ratio of the scanned image. Change the file size by moving the **File size** slider to the right or left.

PreScan

Select **PreScan** to preview your image and crop unwanted portions before scanning.

Resolution

Select a scanning resolution from the **Resolution** drop-down list. Higher resolutions take more memory and transfer time, but produce a finer scanned image.

Scan Type

Select from a range of scan colour depths.

- **Auto**

Use for any type of document. This mode automatically picks an appropriate colour depth for the document.

-
- **Black & White**
Use for text or line art images.
 - **Grey (Error Diffusion)**
Use for photographic images or graphics. (Error Diffusion is a method for creating simulated grey images without using true grey dots. Black dots are put in a specific pattern to give a grey appearance.)
 - **True Grey**
Use for photographic images or graphics. This mode is more accurate because it uses up to 256 shades of grey.
 - **24bit Colour**
Use to create an image with the most accurate colour reproduction. This mode uses up to 16.8 million colours to scan the image, but it requires the most memory and has the longest transfer time.

Document Size

The document size is set to A4 by default. For faster scan speeds, select the exact size of your document from the **Document Size** drop-down list.

- If you select the **1 to 2 (A4)** option, the scanned image will be divided into two A5-size documents.

Brightness

Set the **Brightness** level by dragging the slider to the right or left to lighten or darken the image. If the scanned image is too light, set a lower brightness level and scan the document again. If the image is too dark, set a higher brightness level and scan the document again. You can also type a value into the field to set the **Brightness** level.

Contrast

Increase or decrease the **Contrast** level by moving the slider to the right or left. An increase emphasises dark and light areas of the image, while a decrease reveals more details in grey areas. You can also type a value into the field to set the **Contrast** level.

Continuous Scanning

Select this option to scan multiple pages from the scanner glass or ADF (available only for certain models). After a page is scanned, either continue scanning or finish. Use this method to scan more pages than the maximum ADF capacity.

Auto Crop

Scan multiple documents placed on the scanner glass. The machine will scan each document and create separate files or a single multi-page file.

ID Card Scan

Select this check box to scan both sides of the identification card onto one page.

Advanced Settings

Configure advanced settings by clicking the **Advanced Settings** button in the scan settings dialog box.

- **Remove Background Colour**
Select this option to remove the base colour of documents to make the scanned data more recognisable. When you use this feature, select from three settings: high, medium and low.

Default

Select this option to restore all settings to their factory setting values.



Related Information

- [Scan Using ControlCenter4 Advanced Mode \(Windows®\)](#)
-



Scan Using Nuance™ PaperPort™ 14 or Other Windows® Applications

You can use the Nuance™ PaperPort™ 14 application for scanning.

- To download the Nuance™ PaperPort™ 14 application, click  (**Brother Utilities**), select **Do More** in the left navigation bar, and then click **PaperPort**.
- Nuance™ PaperPort™ 14 supports Windows® XP Home (SP3 or greater), Windows® XP Professional 32-bit (SP3 or greater), Windows Vista® (SP2 or greater), Windows® 7, Windows® 8, Windows® 8.1 and Windows® 10.
- For detailed instructions on using each application, click the application's **Help** menu, and then click **Getting Started Guide** in the **Help** ribbon.



The instructions for scanning in these steps are for PaperPort™ 14. For other Windows® applications, the steps will be similar. PaperPort™ 14 supports both TWAIN and WIA drivers; the TWAIN driver (recommended) is used in these steps.

- Depending on the model of your machine, Nuance™ PaperPort™ 14 may not be included. If it is not included, you can use other software applications that support scanning.
1. Load your document.
 2. Start PaperPort™ 14.
Do one of the following:
 - Windows® XP, Windows Vista® and Windows® 7
Using your computer, click  (**Start**) > **All Programs** > **Nuance PaperPort 14** > **PaperPort**.
 - Windows® 8
Click  (**PaperPort**).
 - Windows® 10
Click  > **All apps** > **Nuance PaperPort 14** > **PaperPort**.
 3. Click the **Desktop** menu, and then click **Scan Settings** in the **Desktop** ribbon.
The **Scan or Get Photo** panel appears on the left side of the screen.
 4. Click **Select**.
 5. From the available Scanners list, select **TWAIN: TW-Brother MFC-XXXX** or **TWAIN: TW-Brother MFC-XXXX LAN** (where MFC-XXXX is the model name of your machine). To use the WIA driver, select the Brother driver that has "WIA" as the prefix.
 6. Select the **Display scanner dialog box** check box in the **Scan or Get Photo** panel.
 7. Click **Scan**.
The Scanner Setup dialog box appears.

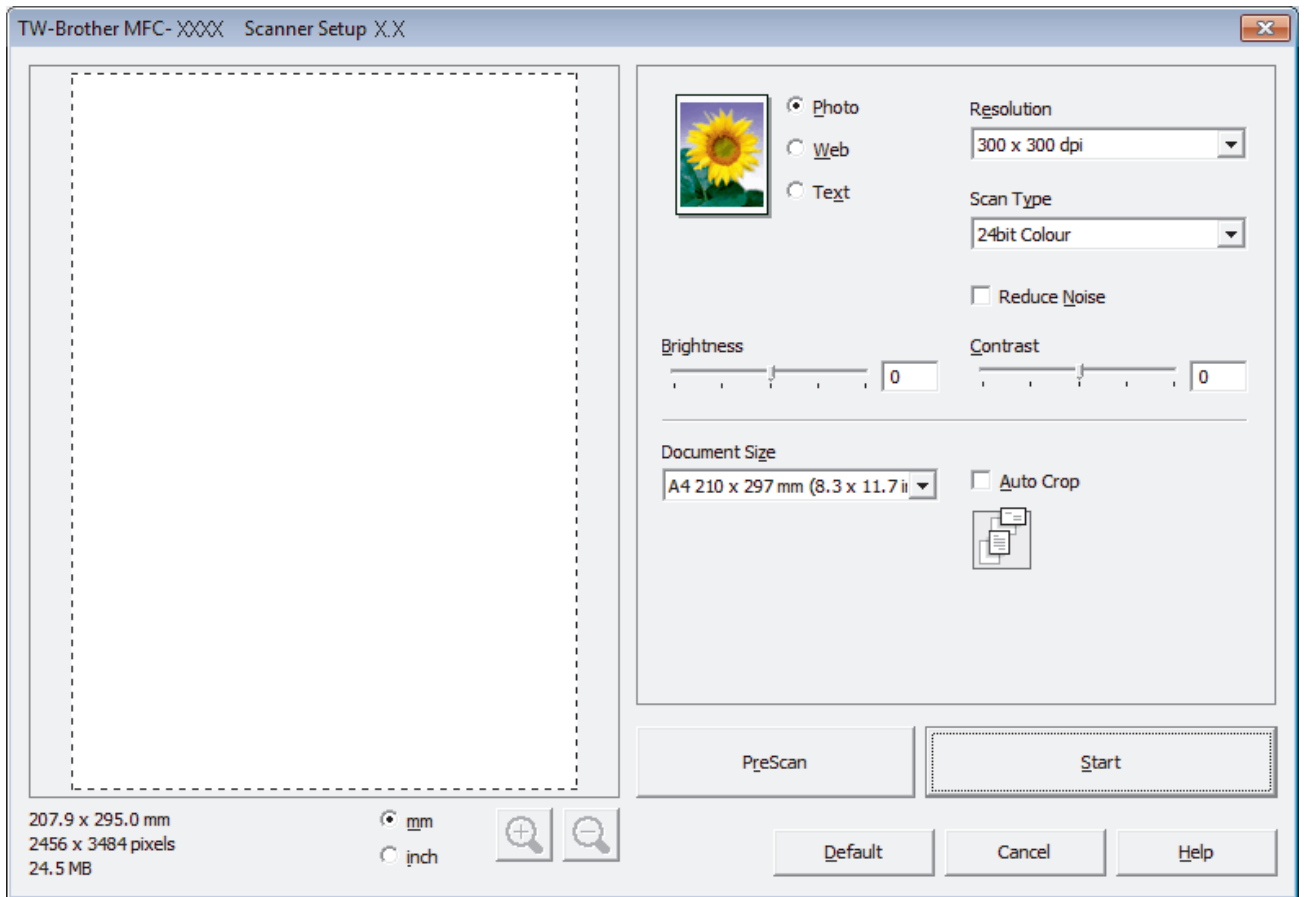

8. Adjust the settings in the Scanner Setup dialog box, if needed.
9. Click the **Document Size** drop-down list, and then select your document size.



- After you select a document size, adjust the scanning area by holding down the left mouse button and dragging your mouse pointer over the portion you want to scan.

10. Click **PreScan** if you want to preview your image and crop unwanted portions before scanning.
11. Click **Start**.

The machine starts scanning.



Related Information

- [Scan from Your Computer \(Windows®\)](#)
- [TWAIN Driver Settings \(Windows®\)](#)

TWAIN Driver Settings (Windows®)

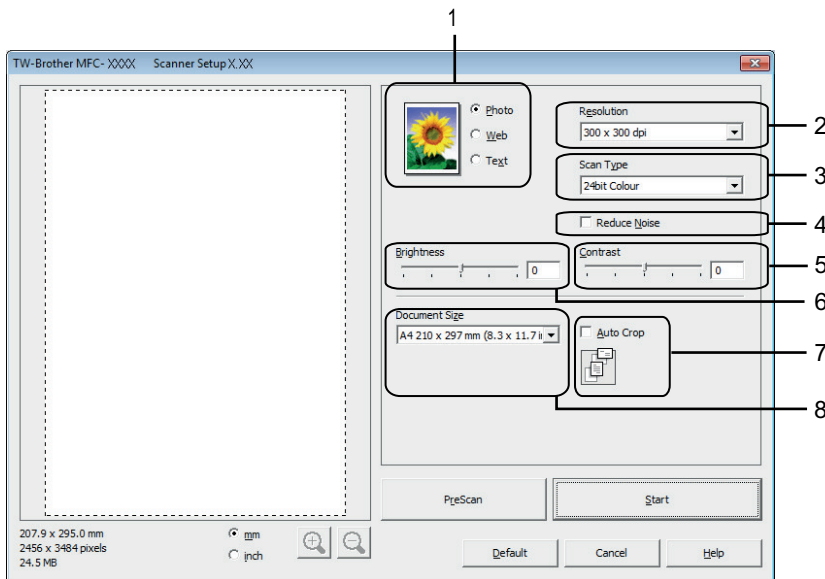

- Note that the item names and assignable values will vary depending on the machine.
- The **Brightness** option is available only when selecting the **Black & White**, **Grey (Error Diffusion)**, **True Grey**, or **24bit Colour** option from the **Scan Type** settings.
- The **Contrast** option is available only when selecting the **Grey (Error Diffusion)**, **True Grey**, or **24bit Colour** option from the **Scan Type** settings.

1. Scan

Select the **Photo**, **Web**, or **Text** option depending on the type of document you want to scan.

Scan (Image Type)		Resolution	Scan Type
Photo	Use for scanning photo images.	300 x 300 dpi	24bit Colour
Web	Use for attaching the scanned image to web pages.	100 x 100 dpi	24bit Colour
Text	Use for scanning text documents.	200 x 200 dpi	Black & White

2. Resolution

Select a scanning resolution from the **Resolution** drop-down list. Higher resolutions take more memory and transfer time, but produce a finer scanned image.

3. Scan Type

Select from a range of scan colour depths.

- **Black & White**
Use for text or line art images.
- **Grey (Error Diffusion)**
Use for photographic images or graphics. (Error Diffusion is a method for creating simulated grey images without using true grey dots. Black dots are put in a specific pattern to give a grey appearance.)
- **True Grey**
Use for photographic images or graphics. This mode is more accurate because it uses up to 256 shades of grey.

- **256 Colour**

Use for simple colour illustrations that do not need the full colour spectrum. This mode uses up to 256 colours to create images.

- **24bit Colour**

Use to create an image with the most accurate colour reproduction. This mode uses up to 16.8 million colours to scan the image, but it requires the most memory and has the longest transfer time.

4. Reduce Noise

Improve and enhance the quality of your scanned images with this selection. The **Reduce Noise** option is available when selecting the **24bit Colour** option and the **300 x 300 dpi**, **400 x 400 dpi**, or **600 x 600 dpi** scan resolution.

5. Contrast

Increase or decrease the **Contrast** level by moving the slider to the right or left. An increase emphasises dark and light areas of the image, while a decrease reveals more details in grey areas. You can also type a value in the field to set the contrast level.

6. Brightness

Set the **Brightness** level by dragging the slider to the right or left to lighten or darken the image. If the scanned image is too light, set a lower brightness level and scan the document again. If the image is too dark, set a higher brightness level and scan the document again.

7. Auto Crop

Scan multiple documents placed on the scanner glass. The machine will scan each document and create separate files or a single multi-page file.

8. Document Size

Select the exact size of your document from a selection of preset scan sizes. **Auto** means that the machine will automatically detect the **Document Size**.

If you select **Custom**, the **Custom Document Size** dialog box appears and you can specify the document size.

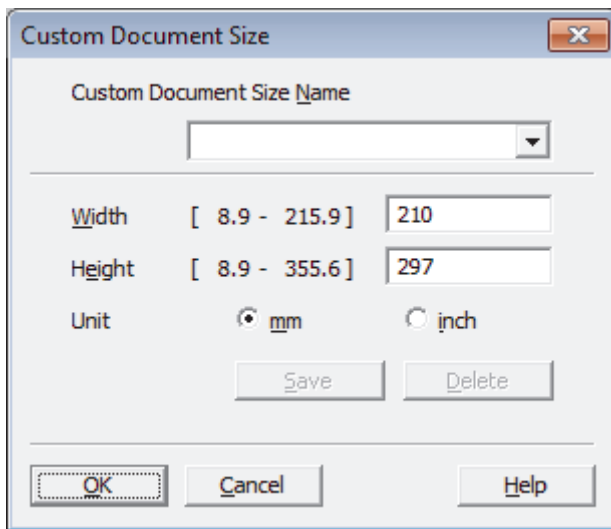

Related Information

- [Scan Using Nuance™ PaperPort™ 14 or Other Windows® Applications](#)

Scan Using Windows® Photo Gallery or Windows® Fax and Scan

Windows® Photo Gallery or Windows® Fax and Scan applications are other options that you can use for scanning.

- These applications use the WIA scanner driver.
- If you want to crop a portion of a page after pre-scanning the document, you must scan using the scanner glass (also called the flatbed).

1. Load your document.
2. Launch your scanning application. Do one of the following:
 - (Windows® Photo Gallery)
Click **File** > **Import from Camera or Scanner**.
 - (Windows® Fax and Scan)
Click **File** > **New** > **Scan**.
3. Select the scanner you want to use.
4. Click **Import** or **OK**.

The **New Scan** dialog box appears.

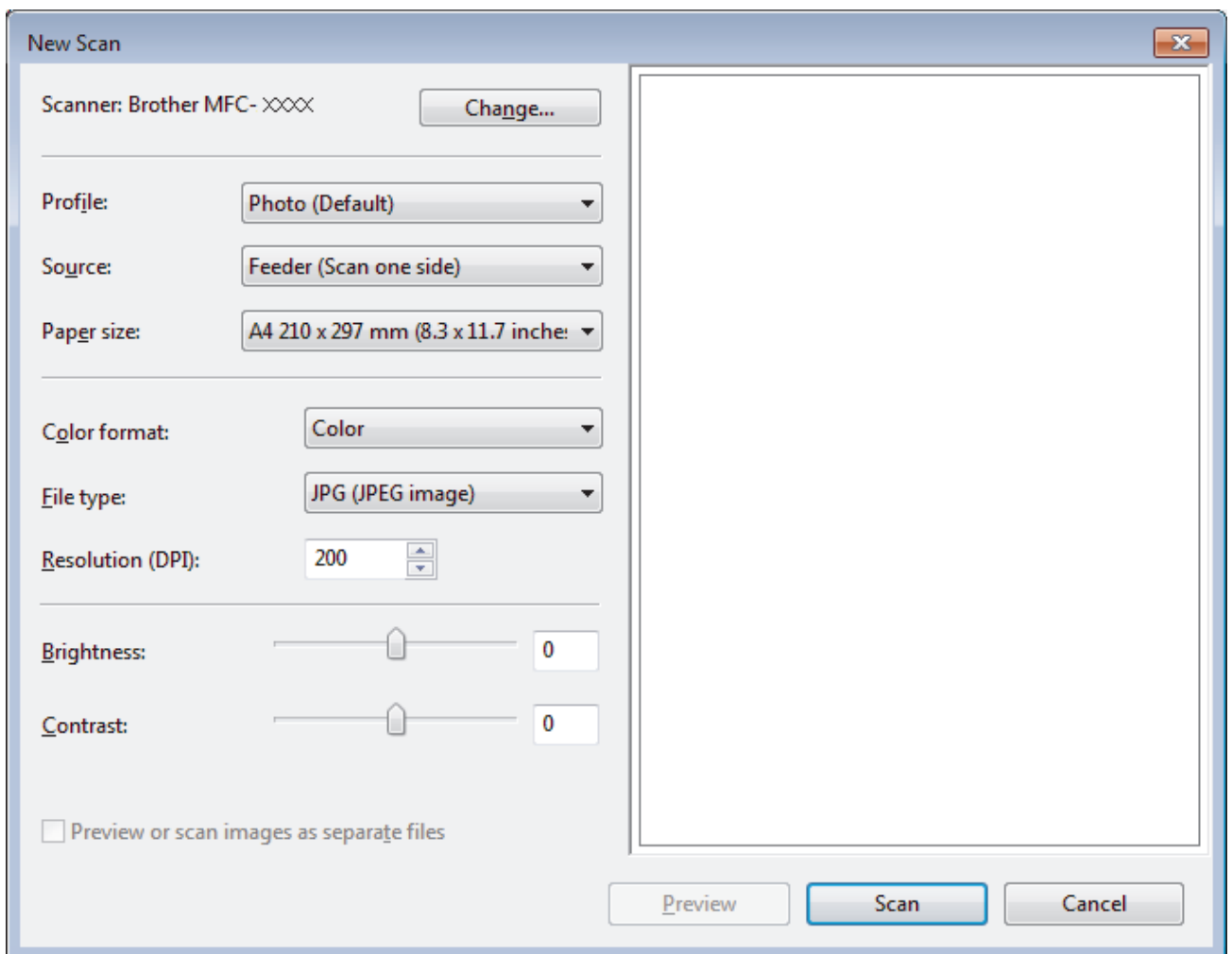

5. Adjust the settings in the Scanner Setup dialog box, if needed.
The scanner resolution can be set to a maximum of 1200 dpi. If you want to scan at higher resolutions, use the **Scanner Utility** software from **Brother Utilities**.
6. Click **Scan**.

The machine starts scanning the document.



Related Information

- [Scan from Your Computer \(Windows®\)](#)
 - [WIA Driver Settings \(Windows®\)](#)
-

WIA Driver Settings (Windows®)

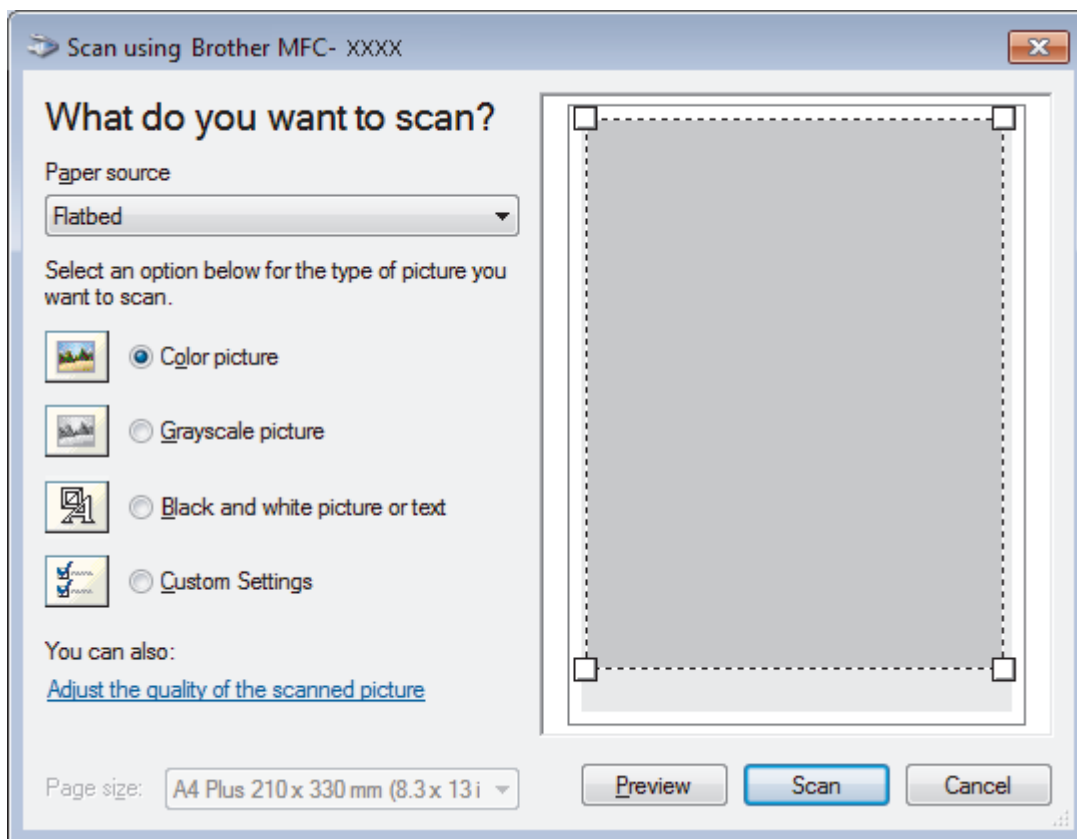

Paper source

Select the **Document Feeder** or **Flatbed** option from the drop-down list.

Picture Type (Image Type)

Select **Color picture**, **Grayscale picture**, **Black and white picture or text**, or **Custom Settings** for the type of document you want to scan.

To change advanced settings, click the **Adjust the quality of the scanned picture** link.

Page size

The **Page size** option is available when you selected the **Document Feeder** as the **Paper source** option.

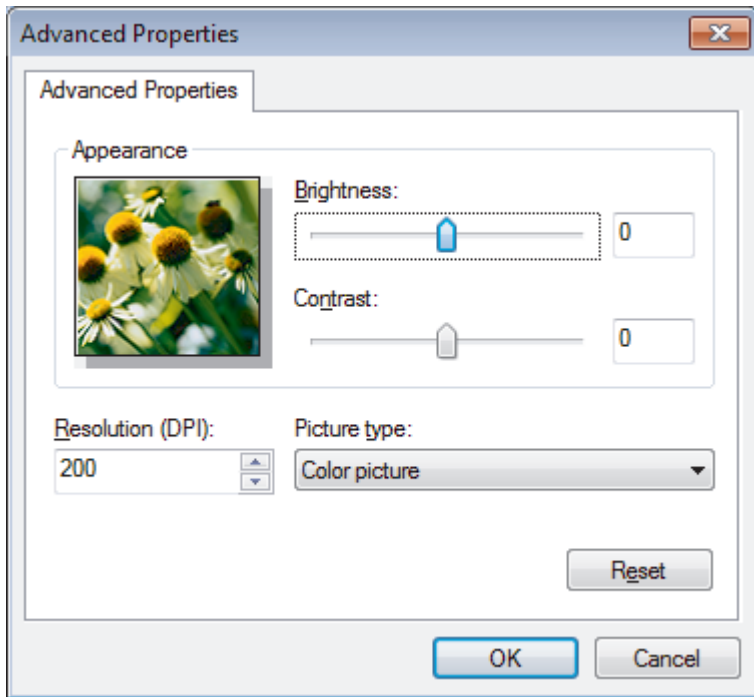

Brightness

Set the **Brightness** level by dragging the slider to the right or left to lighten or darken the image. If the scanned image is too light, set a lower brightness level and scan the document again. If the image is too dark, set a higher brightness level and scan the document again.

Contrast

Increase or decrease the **Contrast** level by moving the slider to the right or left. An increase emphasises dark and light areas of the image, while a decrease reveals more details in grey areas. You can also type a value in the field to set the contrast level.

Resolution (DPI)

Select a scanning resolution from the **Resolution (DPI)** list. Higher resolutions take more memory and transfer time, but produce a finer scanned image.



Related Information

- [Scan Using Windows® Photo Gallery or Windows® Fax and Scan](#)

Install BookScan Enhancer and Whiteboard Enhancer (Windows®)

BookScan Enhancer and Whiteboard Enhancer are image processing applications. BookScan Enhancer can automatically correct images scanned from books. Whiteboard Enhancer can clean up and enhance text and images in photos taken of a whiteboard.

These applications are not available for Windows Server® 2003/2008/2012 series.

- The machine must be turned on and connected to the computer.
- The computer must be connected to the Internet.
- You must be logged on with Administrator access privileges.

1. Click  (**Brother Utilities**).
2. Select your machine from the drop-down list.
3. Select **Do More** in the left navigation bar.
4. Click **BookScan&Whiteboard Suite** and follow the on-screen instructions to install.

Related Information

- [Scan from Your Computer \(Windows®\)](#)

Scan from Your Computer (Mac)

There are several ways you can use your Mac to scan photos and documents on your Brother machine. Use the software applications provided by Brother or your favourite scanning application.

- [Scan Using ControlCenter2 \(Mac\)](#)
- [Scan Using Presto! PageManager or other TWAIN-Compliant Applications \(Mac\)](#)

Scan Using ControlCenter2 (Mac)

Use Brother's ControlCenter software to scan photos and save them as JPEGs, PDFs, or other file formats.

- [Scan Using ControlCenter2 \(Mac\)](#)
- [Save Scanned Data to a Folder as a PDF File Using ControlCenter2 \(Mac\)](#)
- [Scan Both Sides of an ID Card Using ControlCenter2 \(Mac\)](#)
- [Scan to E-mail Attachment Using ControlCenter2 \(Mac\)](#)
- [Scan to an Editable Text File \(OCR\) Using ControlCenter2 \(Mac\)](#)
- [Scan to an Office File Using ControlCenter2 \(Mac\)](#)
- [Scan Settings for ControlCenter2 \(Mac\)](#)

Scan Using ControlCenter2 (Mac)

Send scanned photos or graphics directly to your computer.

1. Load your document.
2. In the **Finder** menu bar, click **Go > Applications > Brother**, and then double-click the  (**ControlCenter**) icon.
The **ControlCenter2** screen appears.
3. Click the **SCAN** tab.

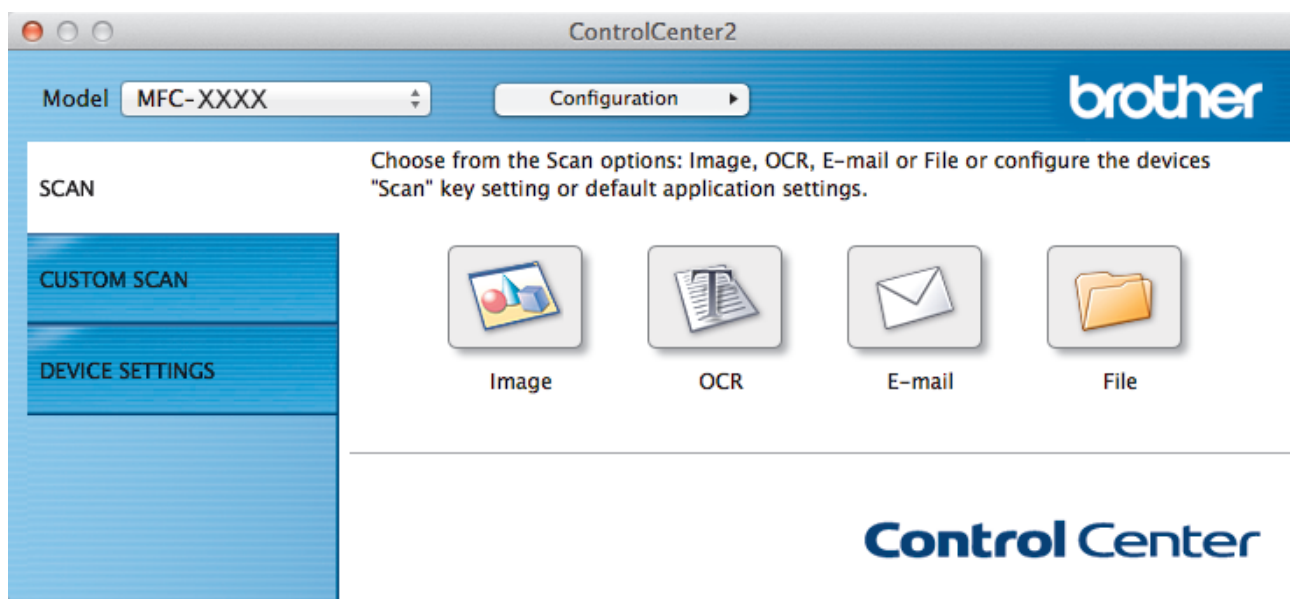

4. Click the **Image** button.
The scan settings dialog box appears.

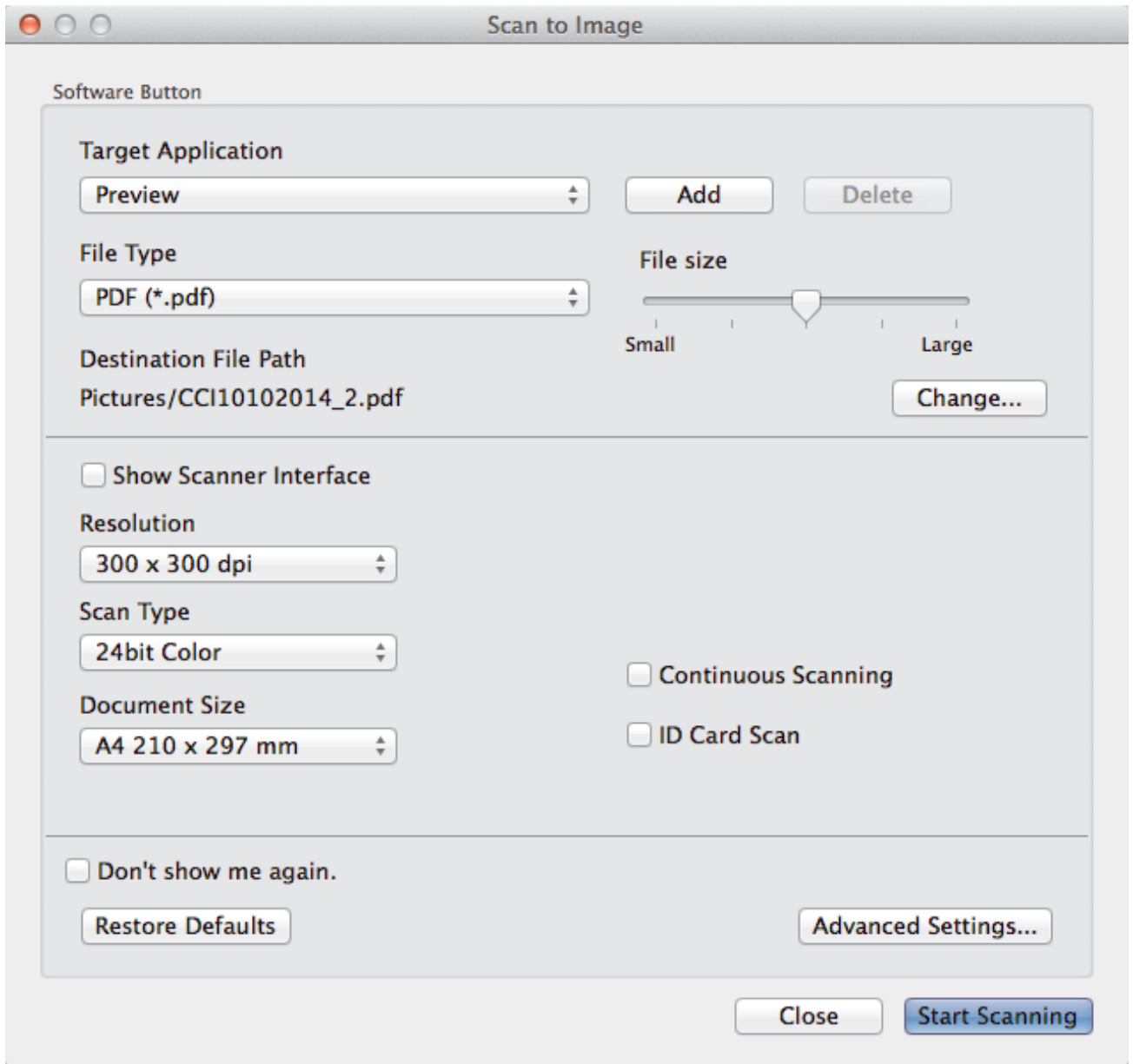

5. Change the scan settings, such as file format, file name, destination file path, resolution, or colour, if needed.



To change the file name or destination file path, click **Change**.

6. Click the **Start Scanning** button.

The machine starts scanning. The scanned image will open in the application you have selected.



Related Information

- [Scan Using ControlCenter2 \(Mac\)](#)

Save Scanned Data to a Folder as a PDF File Using ControlCenter2 (Mac)

1. Load your document.
2. In the **Finder** menu bar, click **Go > Applications > Brother**, and then double-click the  (**ControlCenter**) icon.
The **ControlCenter2** screen appears.
3. Click the **SCAN** tab.

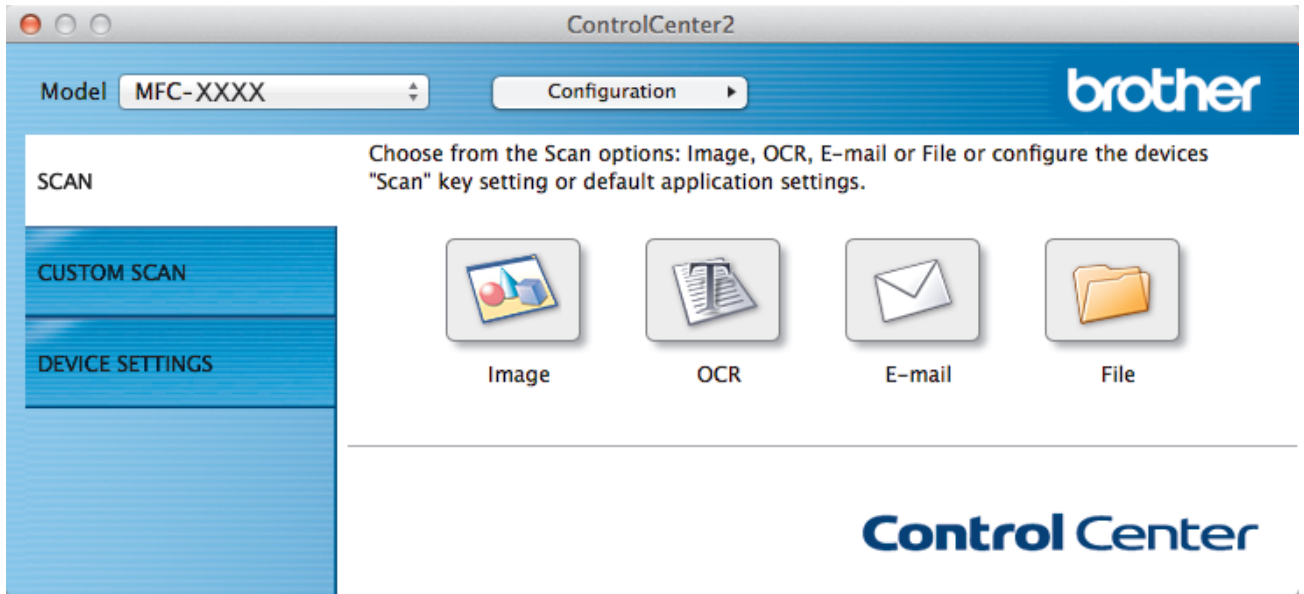

4. Click the **File** button.
The scan settings dialog box appears.

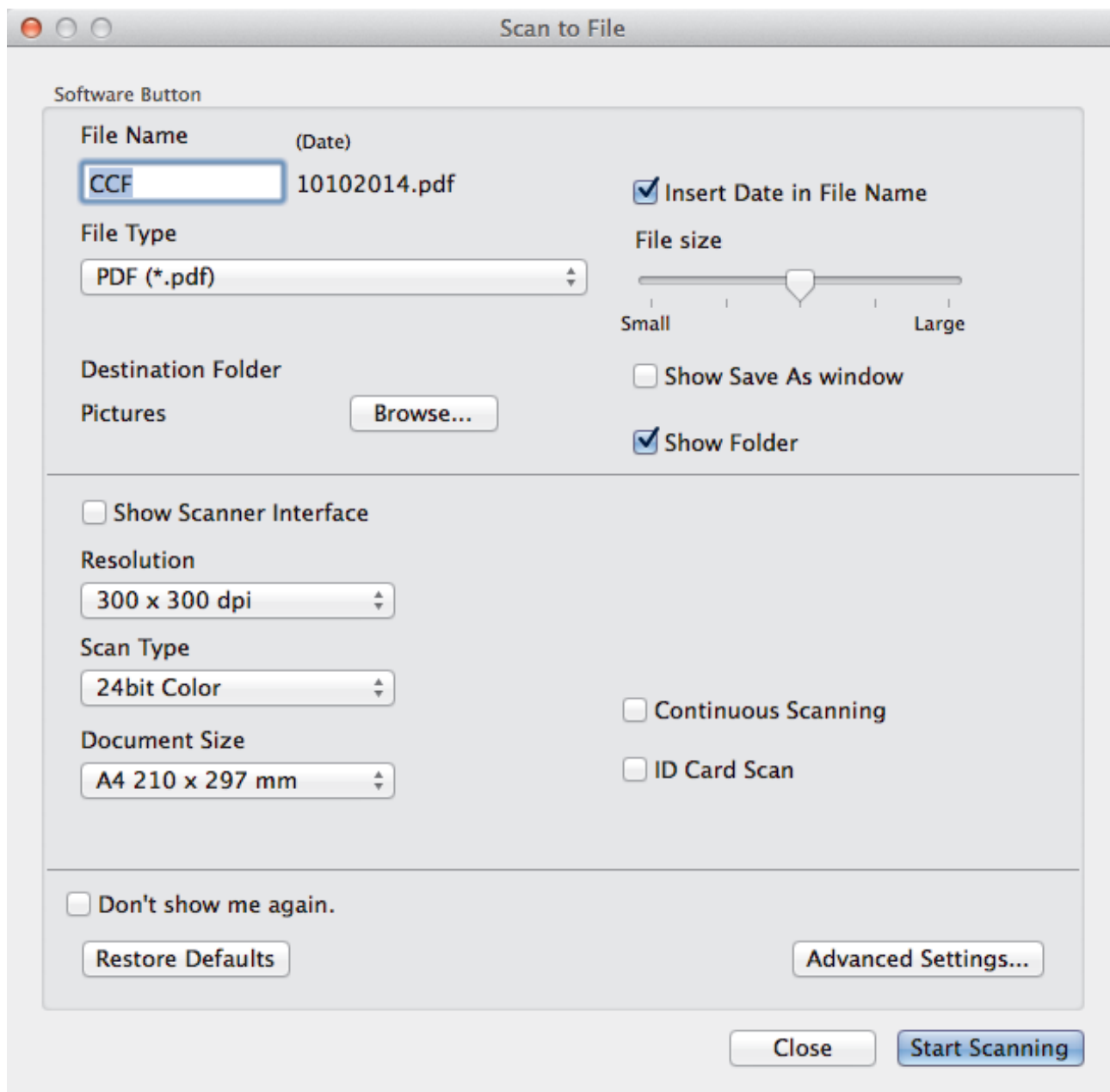

5. Click the **File Type** pop-up menu, and then select **PDF (*.pdf)**.



To save the document as a password-protected PDF, select **Secure PDF (*.pdf)** from the **File Type** pop-up menu, type your password in the **Password** and **Re-type Password** fields, and then click **OK**.

6. Change the scan settings, such as file format, file name, destination folder, resolution, or colour, if needed.
7. Click the **Start Scanning** button.

The machine starts scanning. The file will be saved in the folder you selected.



Related Information

- [Scan Using ControlCenter2 \(Mac\)](#)

Scan Both Sides of an ID Card Using ControlCenter2 (Mac)

1. Place an ID card on the scanner glass.
2. In the **Finder** menu bar, click **Go > Applications > Brother**, and then double-click the  (**ControlCenter**) icon.

The **ControlCenter2** screen appears.

3. Click the **SCAN** tab.

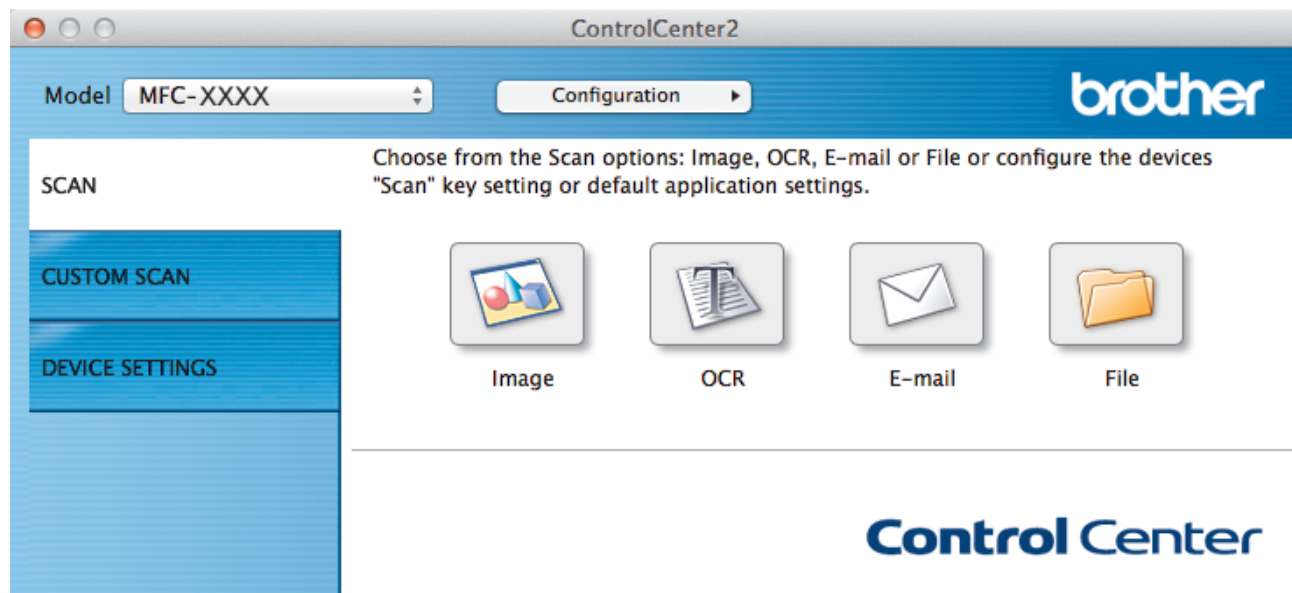

4. Click the **File** button.
The scan settings dialog box appears.

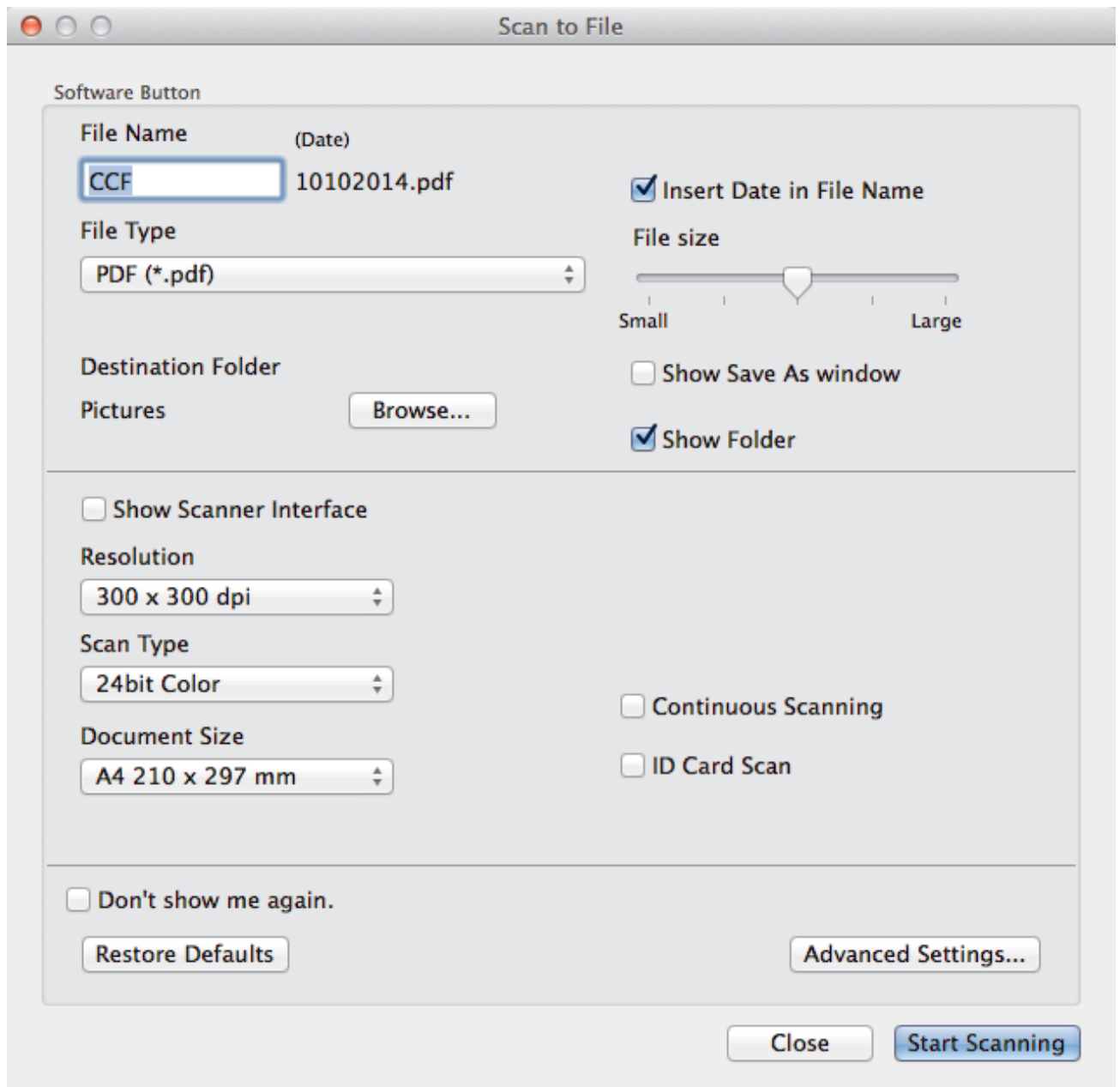

5. Select the **ID Card Scan** check box.
The instruction dialog box appears.
6. Read the instructions on the screen, and then press **OK**.
7. Configure other settings, if needed.
8. Click the **Start Scanning** button.
The machine starts scanning one side of the identification card.
9. After the machine has scanned one side, turn over the identification card, and then click **Continue** to scan the other side.
10. Click **Finish**.

✓ Related Information

- [Scan Using ControlCenter2 \(Mac\)](#)

Scan to E-mail Attachment Using ControlCenter2 (Mac)

Send a scanned document as an email attachment.

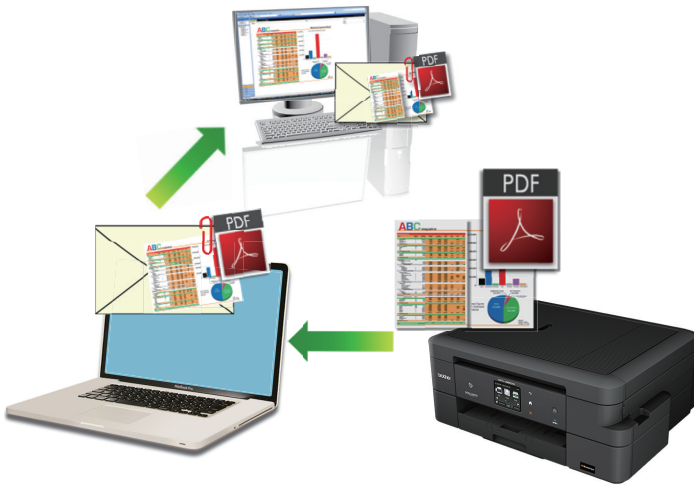

The Scan to E-mail feature does not support Webmail services. Use the Scan to Image or Scan to File feature to scan a document or a picture, and then attach the scanned file to an email message.

1. Load your document.
2. In the **Finder** menu bar, click **Go > Applications > Brother**, and then double-click the  (**ControlCenter**) icon.
The **ControlCenter2** screen appears.
3. Click the **SCAN** tab.

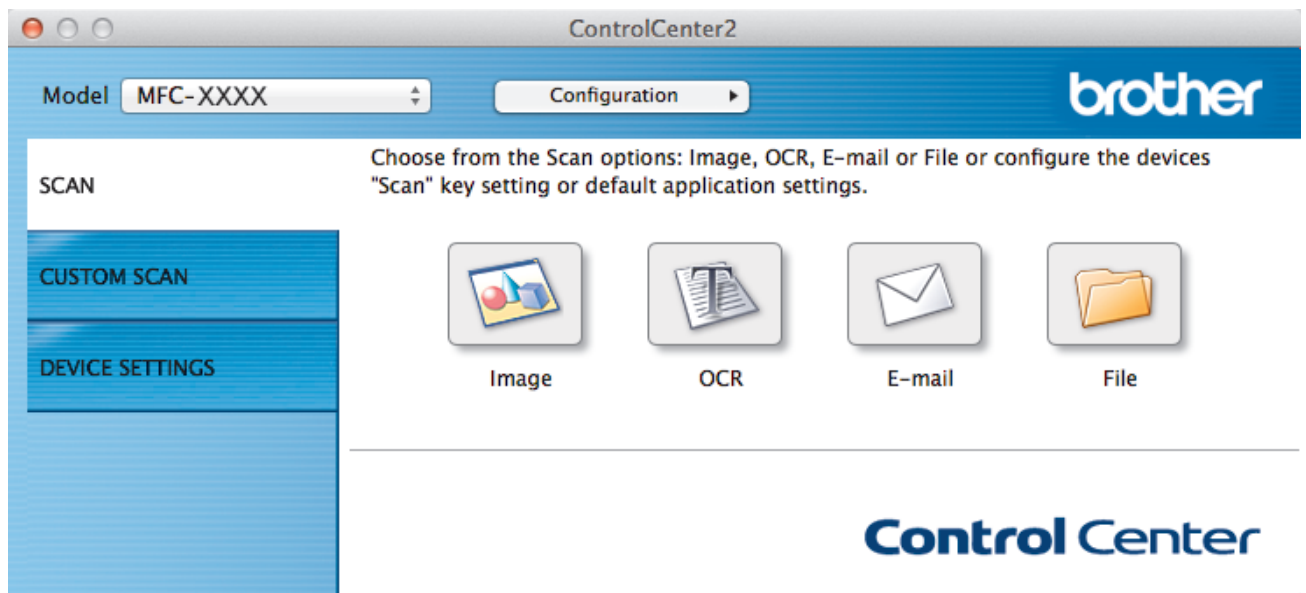

4. Click the **E-mail** button.
The scan settings dialog box appears.

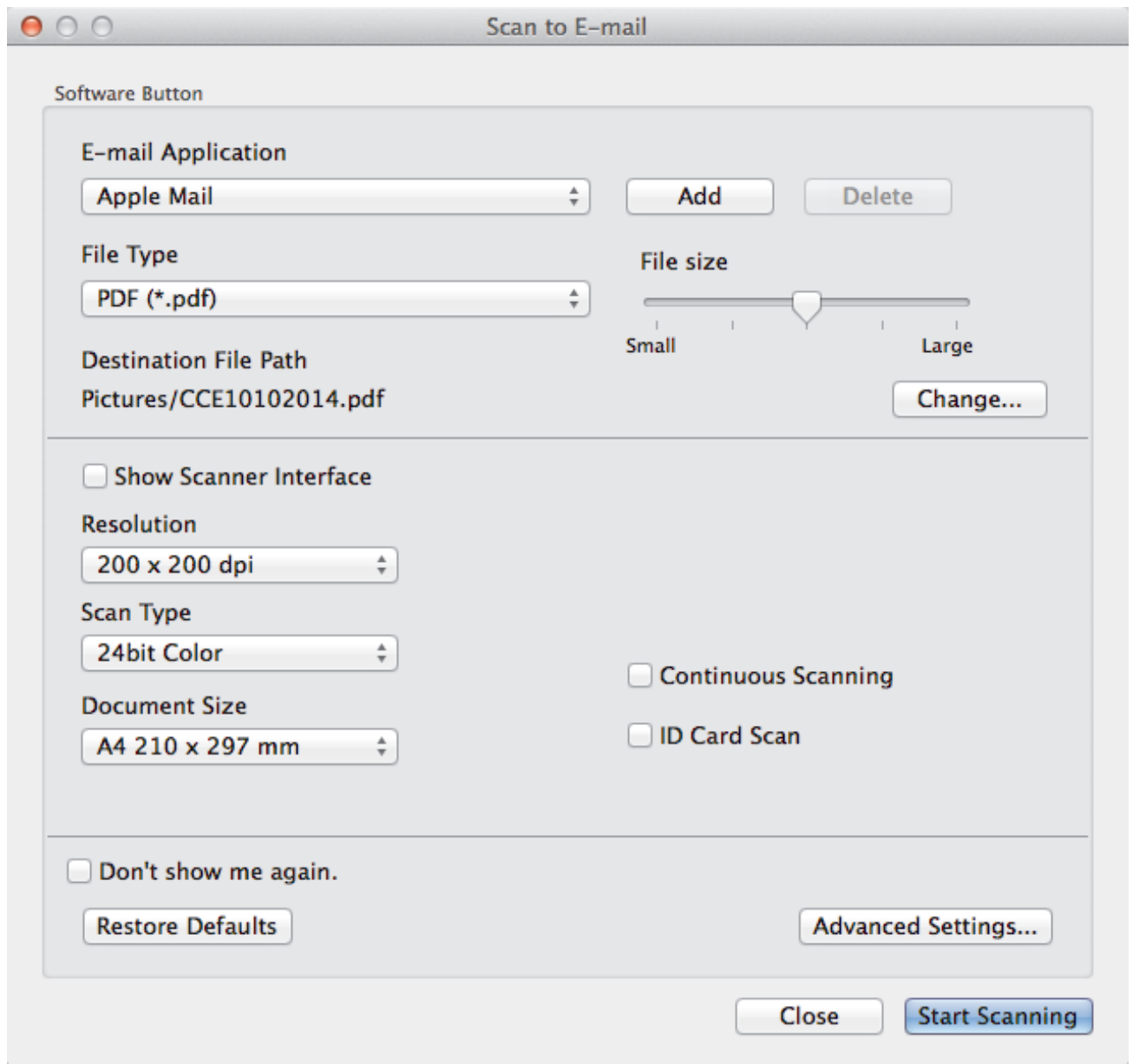

5. Change the scan settings, such as file format, file name, destination file path, resolution, or colour, if needed.



To change the file name or destination file path, click **Change**.

6. Click the **Start Scanning** button.

The machine starts scanning. Your default email application will open and the scanned image is attached to a new, blank email.



Related Information

- [Scan Using ControlCenter2 \(Mac\)](#)

Scan to an Editable Text File (OCR) Using ControlCenter2 (Mac)

Your machine can convert characters in a scanned document to text data using optical character recognition (OCR) technology. You can edit this text using your preferred text-editing application.



- Mac
Presto! PageManager must be installed on your computer.
Download Presto! PageManager from nj.newsoft.com.tw/download/brother/PM9SEInstaller_BR_multilang2.dmg.



The Scan to OCR feature is available for certain languages.

1. Load your document.
2. In the **Finder** menu bar, click **Go > Applications > Brother**, and then double-click the  (**ControlCenter**) icon.
The **ControlCenter2** screen appears.
3. Click the **SCAN** tab.

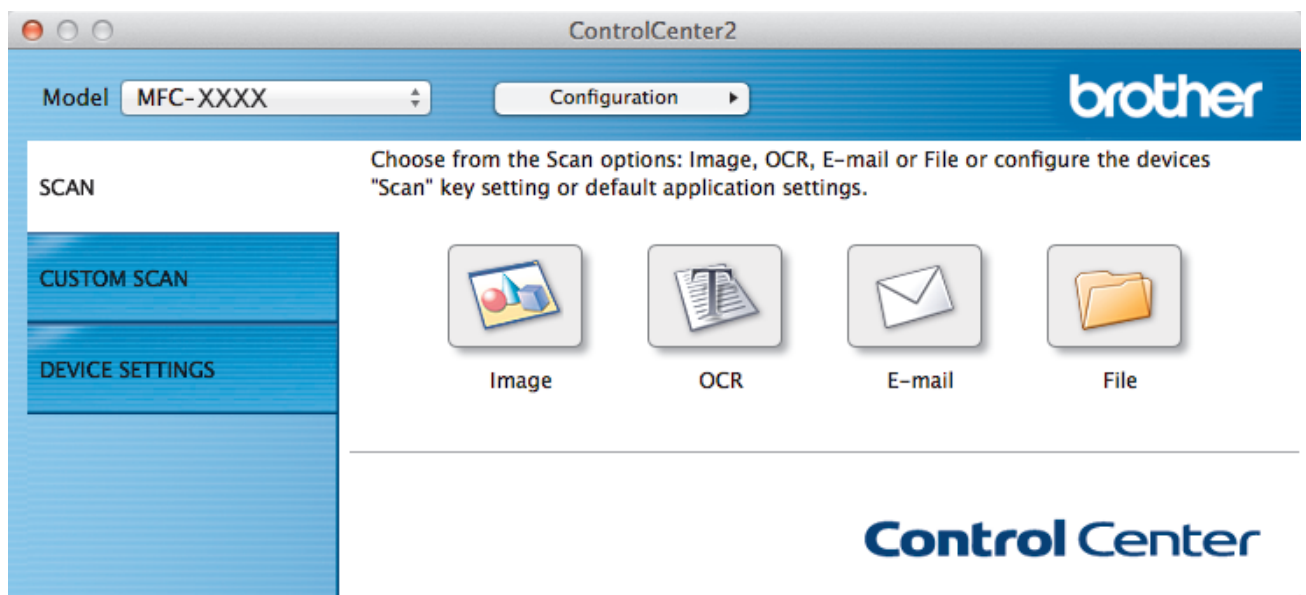

4. Click the **OCR** button.
The scan settings dialog box appears.

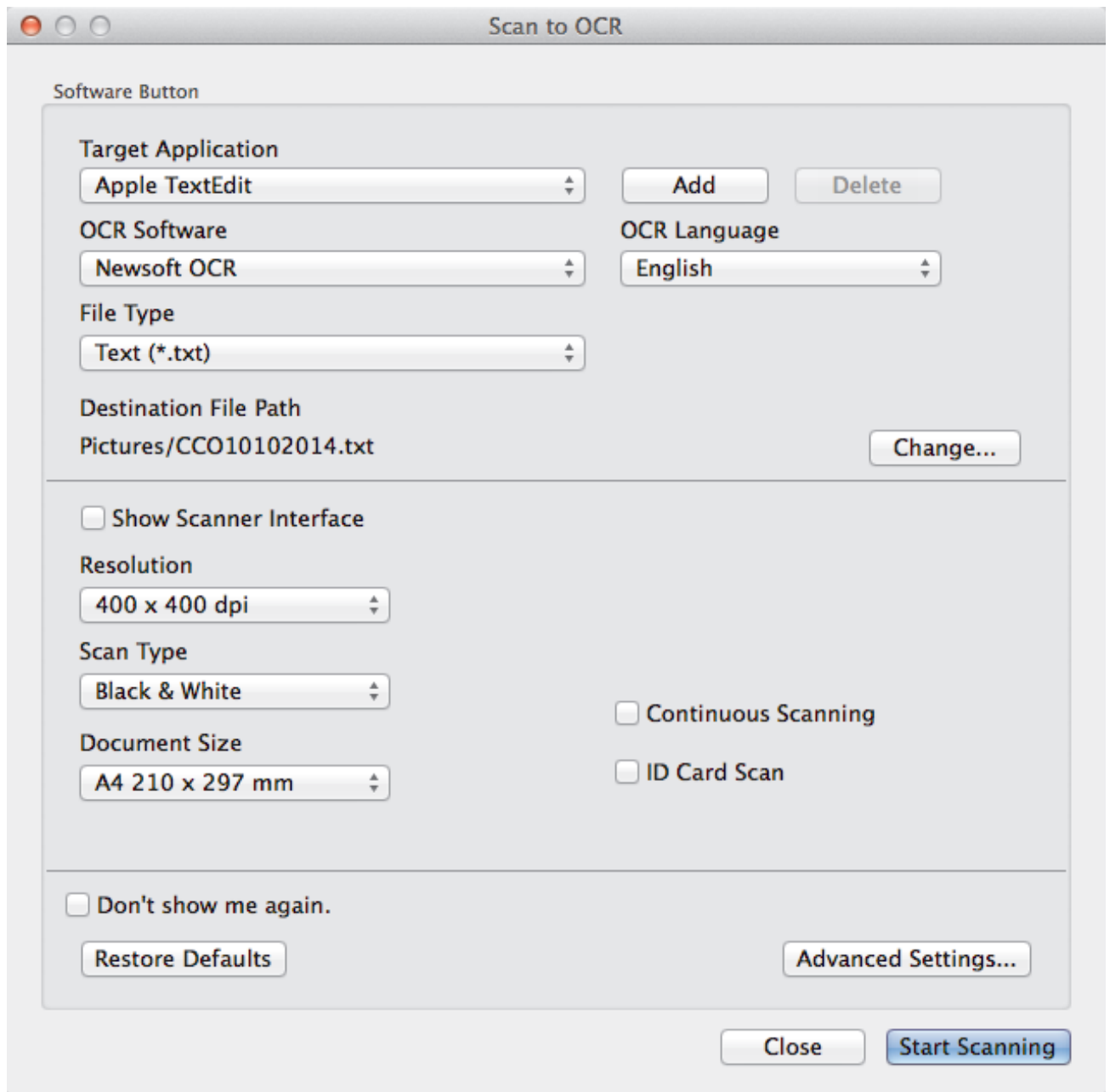

5. Change the scan settings, such as file format, file name, destination file path, resolution, or colour, if needed.



To change the file name or destination file path, click **Change**.

6. Click the **Start Scanning** button.

The machine scans the document, converts it to editable text, and then sends it to your default word processing application.



Related Information

- [Scan Using ControlCenter2 \(Mac\)](#)

Scan to an Office File Using ControlCenter2 (Mac)

Your machine can convert scanned data to a Microsoft® Word file or a Microsoft® PowerPoint® file.

In order to use this feature, your Brother machine must be connected to a network that has access to the Internet through either a wired or wireless connection.

1. Load your document.
2. In the **Finder** menu bar, click **Go > Applications > Brother**, and then double-click the  (**ControlCenter**) icon.

The **ControlCenter2** screen appears.

3. Click the **SCAN** tab.

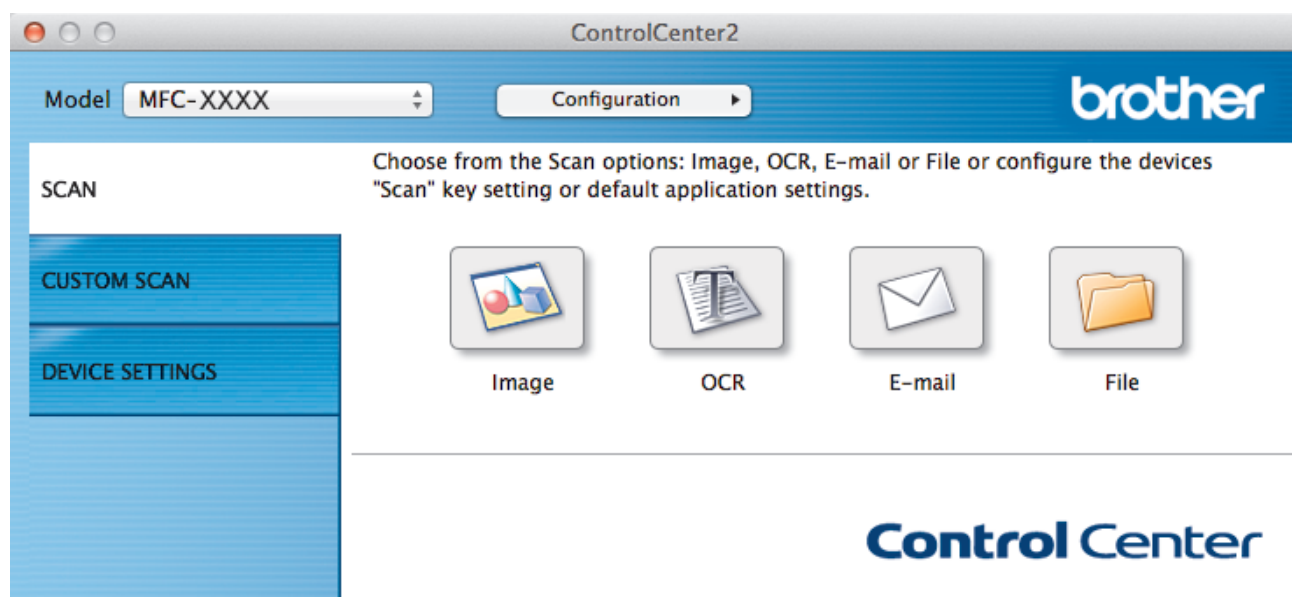

4. Click the **E-mail** or **File** button.
The scan settings dialog box appears.
5. Click the **File Type** pop-up menu, and then select the **Microsoft Office Word (*.docx)** or **Microsoft Office PowerPoint (*.pptx)** option.
If a message dialog box regarding the Internet connection appears, read the information and click **OK**.
6. Change the scan settings, if needed.
7. Click the **Start Scanning** button.

✓ Related Information

- [Scan Using ControlCenter2 \(Mac\)](#)

Scan Settings for ControlCenter2 (Mac)

Settings	Applicable Features			
	Image	OCR	E-mail	File
Target Application/E-mail Application	Yes	Yes	Yes	-
File Type	Yes	Yes	Yes	Yes
File size	Yes	-	Yes	Yes
OCR Software (only available for certain models)	-	Yes	-	-
OCR Language (only available for certain models)	-	Yes	-	-
Destination File Path	Yes	Yes	Yes	-
File Name	Yes	Yes	Yes	Yes
Insert Date in File Name	Yes	Yes	Yes	Yes
Destination Folder	Yes	Yes	Yes	Yes
Show Save As window	-	-	-	Yes
Resolution	Yes	Yes	Yes	Yes
Scan Type	Yes	Yes	Yes	Yes
Document Size	Yes	Yes	Yes	Yes
Continuous Scanning	Yes	Yes	Yes	Yes
ID Card Scan	Yes	Yes	Yes	Yes
Show Scanner Interface	Yes	Yes	Yes	Yes
Advanced Settings	Yes	Yes	Yes	Yes
Restore Defaults	Yes	Yes	Yes	Yes

Target Application/E-mail Application

Select which application is used to open scanned data. Only applications installed on your computer can be selected.

- **Add**

Add an application to the pop-up menu.

Type the application name in the **Application Name** field (up to 30 characters) and select your preferred application by clicking the **Browse** button. Select the **File Type** option from the pop-up menu.

- **Delete**

Delete an application you have added to the pop-up menu.

Select the application from the **Application Name** pop-up menu, and then click **Delete**.

File Type

Select the file type you want to use for the scanned data.

File size

Change the file size by moving the **File size** slider to the right or left.

OCR Language

Set the optical character recognition (OCR) language to match the language of the scanned document's text (available only for certain models).

Destination File Path

Click the **Change** button to change the prefix of the file name and the path of the destination folder.

File Name

Type a prefix for your file name, if needed. To change the prefix for the **Image**, **OCR**, and **E-mail** features, click **Change**.

Insert Date in File Name

Automatically inserts the date in the file name of the scanned image. To insert the date in the file name for the **Image**, **OCR** and **E-mail** features, click **Change**.

Destination Folder

To change the folder for the **Image**, **OCR** and **E-mail** features, click **Change**. Click **Browse** to select the folder where you want to save your scanned document. Select the **Show Folder** option to automatically display the destination folder after scanning to a **File**.

Show Save As window

Select this option to specify the scanned image's destination every time you scan.

Resolution

Select a scanning resolution from the **Resolution** pop-up menu. Higher resolutions take more memory and transfer time, but produce a finer scanned image.

Scan Type

Select from a range of scan colour depths.

- **Black & White**
Use for text or line art images.
- **Gray (Error Diffusion)**
Use for photographic images or graphics. (Error Diffusion is a method for creating simulated grey images without using true grey dots. Black dots are put in a specific pattern to give a grey appearance.)
- **True Gray**
Use for photographic images or graphics. This mode is more accurate because it uses up to 256 shades of grey.
- **24bit Color**
Use to create an image with the most accurate colour reproduction. This mode uses up to 16.8 million colours to scan the image, but it requires the most memory and has the longest transfer time.
- **Auto**
Use for any type of document. This mode automatically picks an appropriate colour depth for the document.

Document Size

The document size is set to A4 by default. For faster scan speeds, select the exact size of your document from the **Document Size** drop-down list.

- If you select the **1 to 2 (A4)** option, the scanned image will be divided into two A5-size documents.

Continuous Scanning

Select this option to scan multiple pages from the scanner glass or ADF (available only for certain models). After a page is scanned, you can either continue scanning or finish. Using this method, you can scan more pages than the maximum ADF capacity.

ID Card Scan

Select this check box to scan both sides of the identification card onto one page.

Show Scanner Interface

Select this check box to crop a portion of a scanned page after pre-scanning the document.

Advanced Settings

Configure advanced settings by clicking the **Advanced Settings** button in the scan settings dialog box.

- **Brightness**

Set the **Brightness** level by dragging the slider to the right or left to lighten or darken the image. If the scanned image is too light, set a lower brightness level and scan the document again. If the image is too dark, set a higher brightness level and scan the document again.

- **Contrast**

Increase or decrease the **Contrast** level by moving the slider to the right or left. An increase emphasises dark and light areas of the image, while a decrease reveals more details in grey areas.

- **Remove Background Color**

Select this option to remove the base colour of documents to make the scanned data more recognisable. When you use this feature, select from three settings: high, medium and low.

Restore Defaults

Select this option to restore all settings to their factory setting values.



Related Information

- [Scan Using ControlCenter2 \(Mac\)](#)
-

Scan Using Presto! PageManager or other TWAIN-Compliant Applications (Mac)

- Download Presto! PageManager from nj.newsoft.com.tw/download/brother/PM9SEInstaller_BR_multilang2.dmg.
- Your hard disk drive must have at least 400 MB of free disk space for installation.
- Presto! PageManager supports OS X v10.8.5, 10.9.x, 10.10.x.
- For more information about the application, see the Presto! PageManager help file. You can access this from the Presto! PageManager Help menu.



Follow these steps if you are using Presto! PageManager. Instructions for using other applications that support TWAIN specifications are very similar.

1. Start Presto! PageManager.

The first time you use the Brother TWAIN driver, you must set it as the default driver. To set the Brother TWAIN driver as the default driver, do the following:

- a. Click the **File** menu, and then select the **Select Source** option.
- b. Select the **Brother TWAIN** option, and then click **Select**.

2. Click the **File** menu, and then select the **Acquire Image Data** option.

The scanner setup dialog box appears.

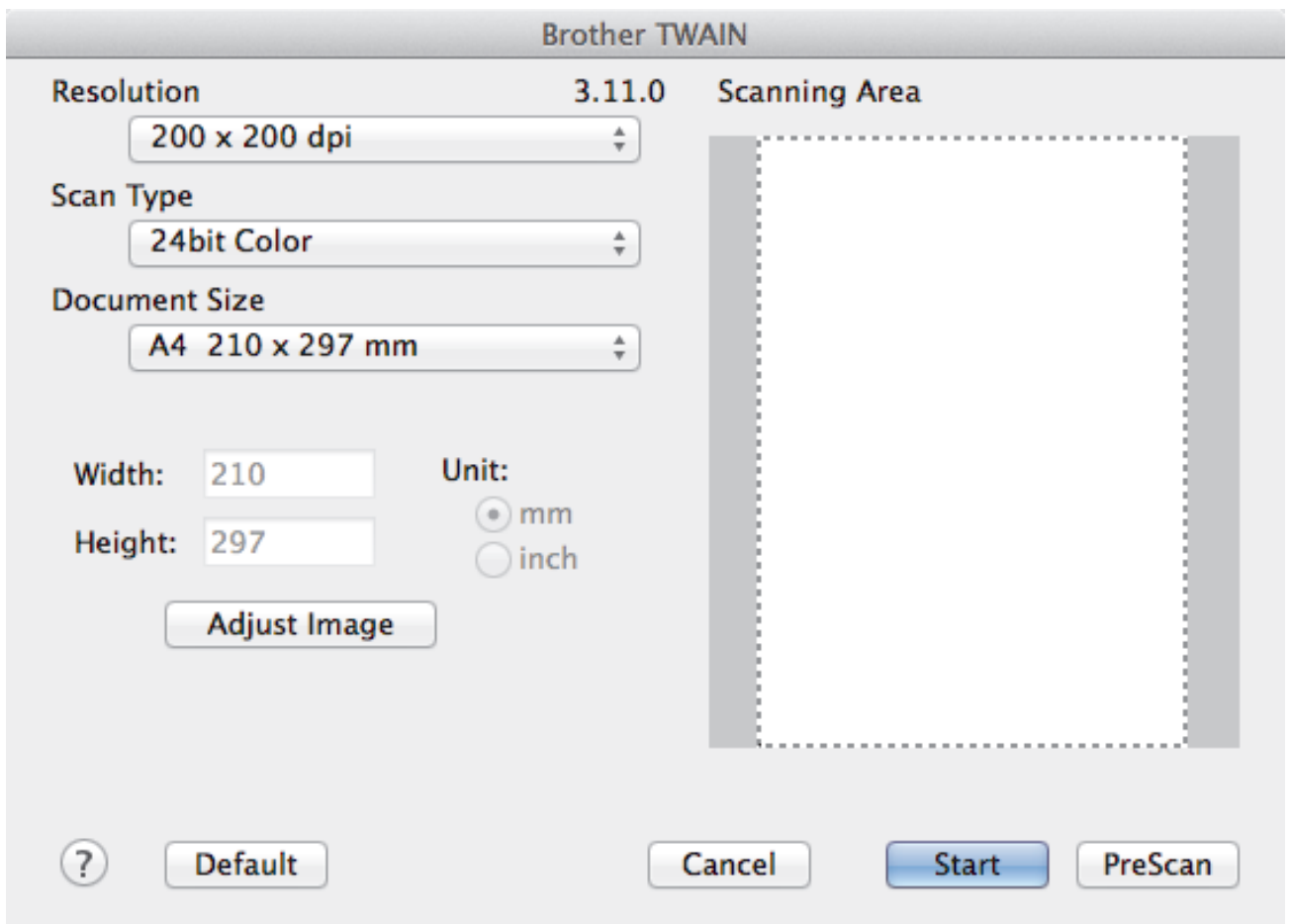

3. Change the scan settings, such as **Resolution**, **Scan Type**, or **Adjust Image**, if needed.
4. Click the **Document Size** pop-up menu, and then select your document size.
5. Click the **PreScan** option to preview your image and crop unwanted portions before scanning.



- After you select a document size, adjust the scanning area by holding down the mouse button and dragging your mouse pointer over the portion you want to scan.
-

6. Click **Start**.

The machine starts scanning.



Related Information

- [Scan from Your Computer \(Mac\)](#)
 - [TWAIN Driver Settings \(Mac\)](#)
-

TWAIN Driver Settings (Mac)

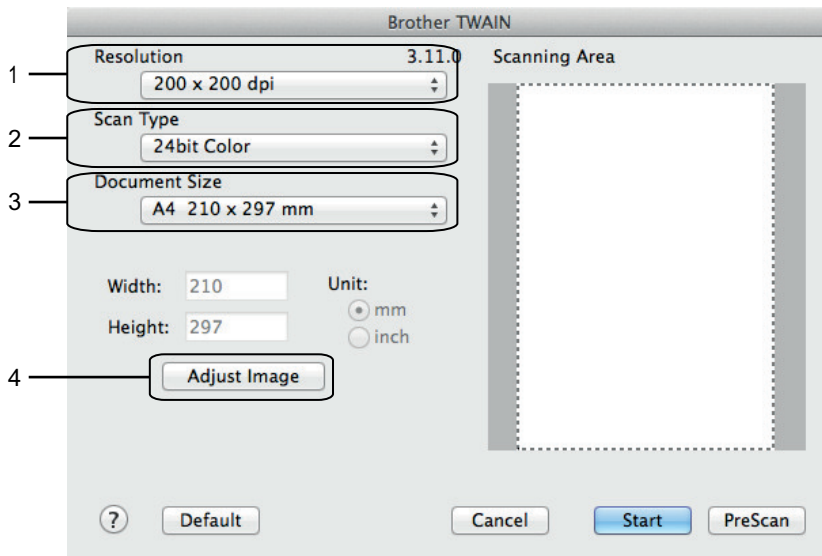

- Item names and assignable values will vary depending on the machine.
- The **Brightness** setting is available only when selecting **Black & White**, **Gray (Error Diffusion)**, **True Gray**, or **24bit Color** from the **Scan Type** options.
- The **Contrast** setting is available only when selecting **Gray (Error Diffusion)**, **True Gray**, or **24bit Color** from the **Scan Type** options.

1. Resolution

Select a scanning resolution from the **Resolution** pop-up menu. Higher resolutions take more memory and transfer time, but produce a finer scanned image.

2. Scan Type

Select from a range of scan colour depths.

- **Black & White**
Use for text or line art images.
- **Gray (Error Diffusion)**
Use for photographic images or graphics. (Error Diffusion is a method for creating simulated grey images without using true grey dots. Black dots are put in a specific pattern to give a grey appearance.)
- **True Gray**
Use for photographic images or graphics. This mode is more accurate because it uses up to 256 shades of grey.
- **256 Color**
(Not available for Brother's ControlCenter software and Presto! PageManager 9 or later)
Use for simple colour illustrations that do not use the full colour spectrum. This mode uses up to 256 colours to create images.
- **24bit Color**
Use to create an image with the most accurate colour reproduction. This mode uses up to 16.8 million colours to scan the image, but it requires the most memory and has the longest transfer time.

3. Document Size

Select the exact size of your document from a selection of preset scan sizes. **Auto** means that the machine will automatically detect the **Document Size**.

- If you select **Custom**, you can specify the document size.

Width:	<input type="text" value="210"/>	Unit:	<input checked="" type="radio"/> mm
Height:	<input type="text" value="297"/>		<input type="radio"/> inch

4. Adjust Image

Click the **Adjust Image** button to adjust other image qualities.

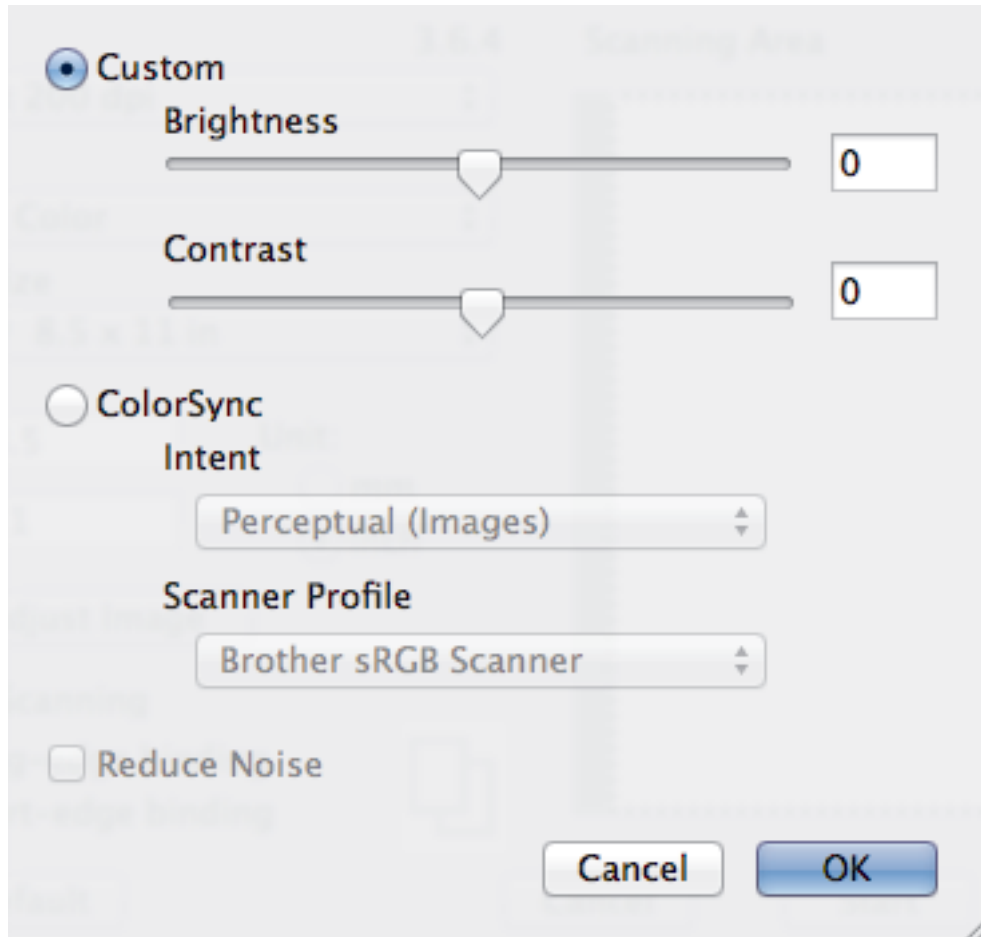

Brightness

Set the **Brightness** level by dragging the slider to the right or left to lighten or darken the image. If the scanned image is too light, set a lower brightness level and scan the document again. If the image is too dark, set a higher brightness level and scan the document again. You can also type a value in the box to set the brightness.

Contrast

Increase or decrease the **Contrast** level by moving the slider to the right or left. An increase emphasises dark and light areas of the image, while a decrease reveals more details in grey areas. You can also type a value in the box to set the contrast.

Reduce Noise

Improve and enhance the quality of your scanned images with this selection. The **Reduce Noise** option is available when selecting the **24bit Color** option and the **300 x 300 dpi**, **400 x 400 dpi**, or **600 x 600 dpi** scan resolutions.

✓ Related Information

- [Scan Using Presto! PageManager or other TWAIN-Compliant Applications \(Mac\)](#)

Copy

- [Copy a Document](#)
- [Enlarge or Reduce Copied Images](#)
- [Sort Copies](#)
- [Make Page Layout Copies \(N in 1 or Poster\)](#)
- [2-sided Copy](#)
- [Copy an ID Card](#)
- [Copy in Ink Save Mode](#)
- [Copy Options](#)

Copy a Document

1. Make sure you have loaded the correct size paper in the paper tray.
2. Do one of the following:
 - Place the document *face down* on the scanner glass.

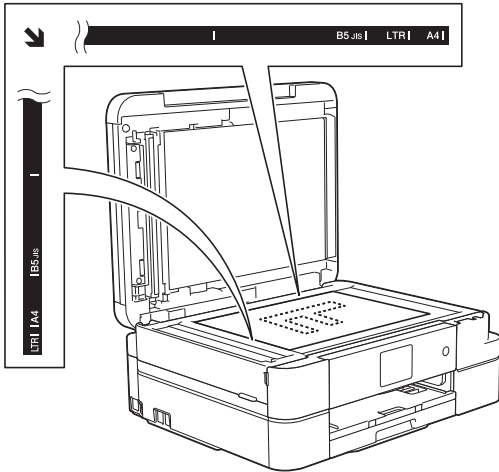

- Place the document *face down* in the ADF. (ADF models only)
(If you are copying multiple pages, we recommend using the ADF.)

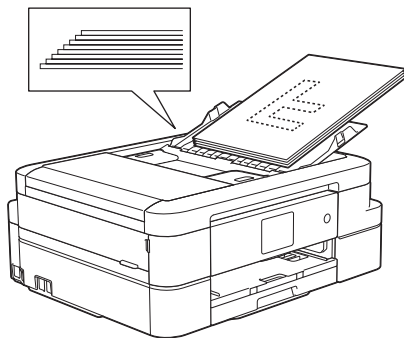

3. Press  [Copy].

The touchscreen displays:

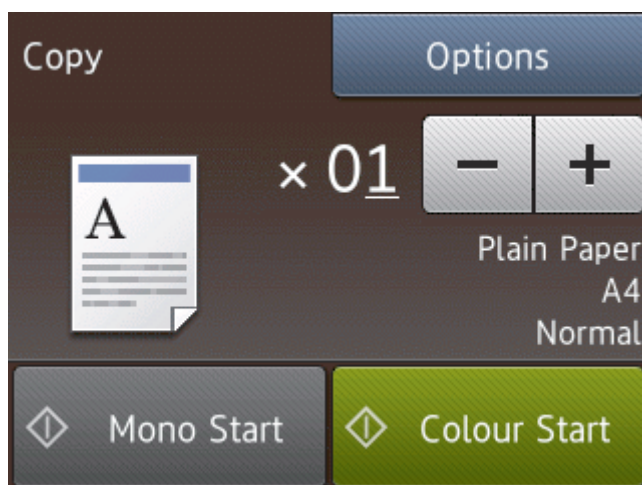

4. Change the copy settings, if needed.

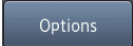

- When you load paper other than A4 size Plain Paper, you must change the [Paper Size] and [Paper Type] settings by pressing [Options].

Option	Description
×01 (No. of Copies)	Enter the number of copies in one of the following ways: <ul style="list-style-type: none"> • Press – or + on the touchscreen. • Press ×01 to display the keyboard on the touchscreen, and then enter the number of copies using the touchscreen keyboard. Press OK.
Options	Press  to change the copy settings for the next copy only. <ul style="list-style-type: none"> • When you have finished changing settings, press OK. • After you have finished choosing new options, you can save them by pressing the Save as Shortcut button.

5. Press [Mono Start] or [Colour Start].



To stop copying, press .



Related Information

- [Copy](#)
- [Load Documents in the Automatic Document Feeder \(ADF\)](#)
- [Load Documents on the Scanner Glass](#)
- [Copy Options](#)

Enlarge or Reduce Copied Images

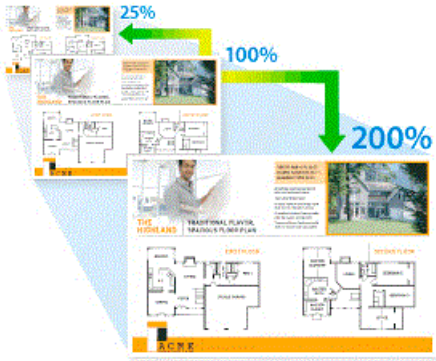
Select an enlargement or reduction ratio to resize your copied data.



1. Load your document.
2. Press  [Copy].
3. Enter the number of copies in one of the following ways:
 - Press [-] or [+] on the touchscreen.
 - Press  **01** to display the keyboard on the touchscreen, and then enter the number of copies using the touchscreen keyboard. Press [OK].
4. Press [Options] > [Enlarge/Reduce].
5. Press ▲ or ▼ to display the available options, and then press the option you want to change.
6. Do one of the following:
 - If you selected the [Enlarge] or [Reduce] option, press the enlargement or reduction ratio you want to use.
 - If you selected the [Custom (25-400%)] option, press  (backspace) to erase the displayed percentage, or press ◀ to move the cursor, and then enter an enlargement or reduction ratio from [25%] to [400%].
Press [OK].
 - If you selected [100%] or the [Fit to Page] option, go to the next step.
7. Read and confirm the displayed list of options you have selected, and then press [OK].
8. When you have finished changing settings, press [Mono Start] or [Colour Start].



If you selected the [Fit to Page] option, your machine adjusts the copy size to fit the paper size set in the machine.

- The [Fit to Page] option does not work correctly when the document on the scanner glass is skewed more than three degrees. Using the document guidelines on the left and top, place your document in the upper-left corner, with the document face down on the scanner glass.
- The [Fit to Page] option is not available when using the ADF. (ADF models only)
- The [Fit to Page] option is not available for Legal size documents.





Related Information

- [Copy](#)

Sort Copies

Sort multiple copies. Pages will be stacked in the order they are fed, that is: 1, 2, 3, and so on.

1. Load your document.
2. Press  [Copy].
3. Enter the number of copies in one of the following ways:
 - Press [-] or [+] on the touchscreen.
 - Press  to display the keyboard on the touchscreen, and then enter the number of copies using the touchscreen keyboard. Press [OK].
4. Press [Options] > [Stack/Sort] > [Sort].
5. Read and confirm the displayed list of settings you have selected, and then press [OK].
6. When you have finished changing settings, press [Mono Start] or [Colour Start]. If you placed the document in the ADF (ADF models only), the machine scans the document and starts printing.
If you are using the scanner glass, go to the next step.
7. After the machine scans the page, place the next page on the scanner glass. Press [Continue].
Repeat this step for each page of the document.
8. After all the pages have been scanned, press [Finish] to start printing.



Related Information

- [Copy](#)

Make Page Layout Copies (N in 1 or Poster)

The N in 1 copy feature saves paper by copying two or four pages of your document onto one page of the copy. The poster feature divides your document into sections, then enlarges the sections so you can assemble them into a poster. To print a poster, use the scanner glass.



- Make sure the paper size is set to A4, or Letter.
 - You can make only one Poster copy at a time.
1. Load your document.
 2. Press  [Copy].
 3. Enter the number of copies in one of the following ways:
 - Press [-] or [+] on the touchscreen.
 - Press **x01** to display the keyboard on the touchscreen, and then enter the number of copies using the touchscreen keyboard. Press [OK].
 4. Press [Options] > [Page Layout].
 5. Press ▲ or ▼ to display the options, and then press the option you want.
 6. Read and confirm the displayed list of settings you have selected, and then press [OK].
 7. When you have finished changing settings, press [Mono Start] or [Colour Start]. If you placed the document in the ADF (ADF models only) or are making a poster, the machine scans the pages and starts printing.

If you are using the scanner glass, go to the next step.
 8. After the machine scans the page, place the next page on the scanner glass. Press [Continue]. Repeat this step for each page of the document.
 9. After all the pages have been scanned, press [Finish] to start printing.











Related Information

- [Copy](#)
 - [Page Layout Options for Copies](#)
-

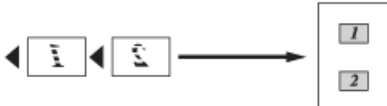
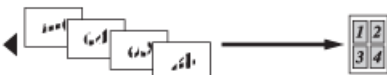
Page Layout Options for Copies

- If you are copying from the ADF, insert the document face down in the direction shown in the table. (ADF models only)
- If you are copying from the scanner glass, place the document face down in the direction shown in the table.

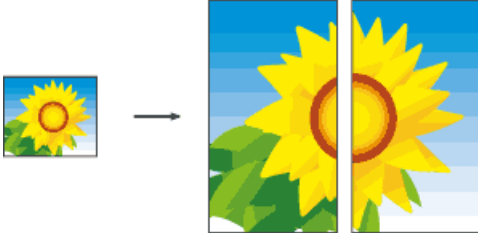
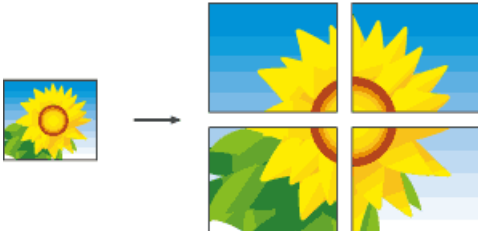
Option	Description
Off (1in1)	-
2in1 (Portrait)	<ul style="list-style-type: none"> • When using the ADF  • When using the scanner glass 
2in1 (Landscape)	<ul style="list-style-type: none"> • When using the ADF  • When using the scanner glass 
2in1 (ID) (Using the scanner glass)	
4in1 (Portrait)	<ul style="list-style-type: none"> • When using the ADF  • When using the scanner glass 
4in1 (Landscape)	<ul style="list-style-type: none"> • When using the ADF  • When using the scanner glass 
Poster (2x1) (Using the scanner glass)	
Poster (2x2) (Using the scanner glass)	

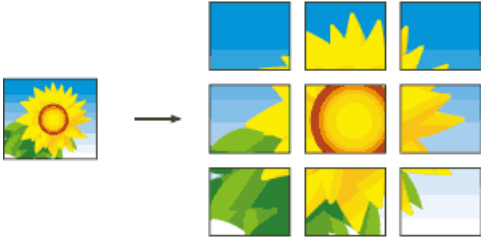
Option	Description
Poster (3x3) (Using the scanner glass)	

✓ Related Information

- Make Page Layout Copies (N in 1 or Poster)

2-sided Copy

- [Copy on Both Sides of the Paper \(1-sided to 2-sided/2-sided to 2-sided\)](#)

Copy on Both Sides of the Paper (1-sided to 2-sided/2-sided to 2-sided)

Reduce the amount of paper you use by copying onto both sides of the paper.

- We recommend loading single-sided documents in the ADF for 2-sided copying. (ADF models only)
 - For 2-sided documents use the scanner glass.
 - You can use only A4, A5, or Letter size plain paper.
1. Load your document.
 2. Press  [Copy].
 3. Enter the number of copies in one of the following ways:
 - Press [-] or [+] on the touchscreen.
 - Press **x01** to display the keyboard on the touchscreen, and then enter the number of copies using the touchscreen keyboard. Press [OK].
 4. To sort multiple copies, press [Options] > [Stack/Sort] > [Sort].
 5. Press ▲ or ▼ to display the [2-sided Copy] option, and then press it.
 6. Press the option you want.

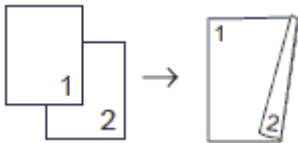
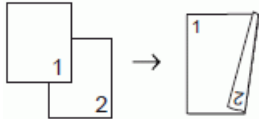
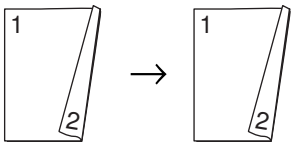
Option	Description
Off	-
1-sided⇒2-sided Long Edge Flip	
1-sided⇒2-sided Short Edge Flip	
2-sided⇒2-sided	

7. Review your settings on the Touchscreen, and then press [OK].
8. Press [Mono Start] or [Colour Start]. If you placed the document in the ADF (ADF models only), the machine scans the pages and starts printing.

If you are using the scanner glass, go to the next step.
9. Place the next page on the scanner glass, and then press [Continue].

The machine starts printing.
10. If you selected the [Sort] option, repeat the previous step for each page. After all the pages have been scanned, press [Finish]. The machine starts printing.

DO NOT touch the printed page until it is ejected the second time. The machine will print the first side and eject the paper, and then pull the paper in to print the second side.



- If you get a paper jam, press the [Advanced] button, and then press one of the jam prevention settings: [2-sided 1] or [2-sided 2].
 - The [2-sided 1] option uses a longer print time for the ink to dry.
 - The [2-sided 2] option uses a longer print time and will also print in lighter colours.
-



Related Information

- [2-sided Copy](#)
 - [Paper Handling and Printing Problems](#)
-



Copy an ID Card

Use the [2in1 (ID)] feature to copy both sides of an identification card onto one page, keeping the original card size.

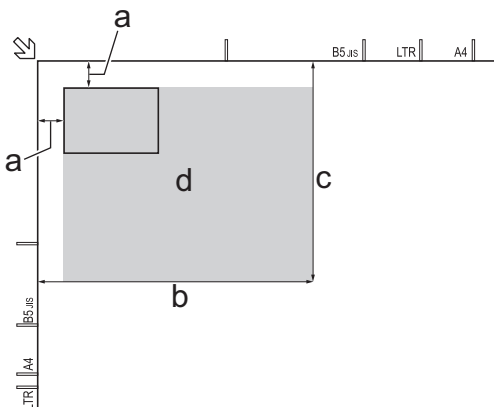

- Make sure the paper size is set to A4 or Letter.
 - You may copy an identification card to the extent permitted under applicable laws. For more detailed information, see the *Product Safety Guide*.
1. Place your identification card face down near the upper-left corner of the scanner glass.



- a. 3 mm or greater (top, left)
 - b. 207 mm
 - c. 145 mm
 - d. scannable area
2. Press  [Copy].
 3. Enter the number of copies in one of the following ways:
 - Press [-] or [+] on the touchscreen.
 - Press  to display the keyboard on the touchscreen, and then enter the number of copies using the touchscreen keyboard. Press [OK].
 4. Press [Options] > [Page Layout] > [2in1 (ID)].

-
5. Read and confirm the displayed list of settings you have selected. When you have finished changing settings, press [OK].
 6. Press [Mono Start] or [Colour Start].
The machine starts scanning one side of the identification card.
 7. After the machine has scanned the first side, turn over the identification card and press [Continue] to scan the other side.



Related Information

- [Copy](#)
-

Copy in Ink Save Mode



Related Models: MFC-J985DW

When you select Ink Save Mode, the machine prints the colours lighter and emphasises the outlines of the images.



- The amount of ink that is saved varies depending on the type of documents printed.
- Ink Save Mode may make your printouts look different from your original document.
- The Ink Save Mode feature is supported by technology from Reallusion, Inc.



1. Load your document.
2. Press  [Copy].
3. Enter the number of copies in one of the following ways:
 - Press [-] or [+] on the touchscreen.
 - Press  to display the keyboard on the touchscreen, and then enter the number of copies using the touchscreen keyboard. Press [OK].
4. Press [Options] > [Advanced Settings] > [Ink Save Mode].
5. Read and confirm the displayed list of settings you have selected, and then press [OK].
6. When you have finished changing settings, press [Mono Start] or [Colour Start].



✓ Related Information

- [Copy](#)

Copy Options

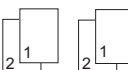
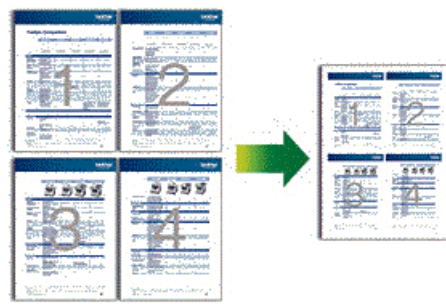
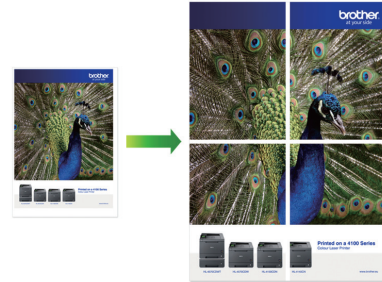
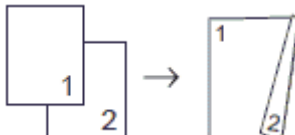
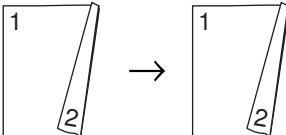
To change copy settings, press the [Options] button.

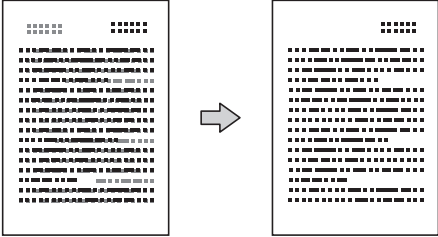
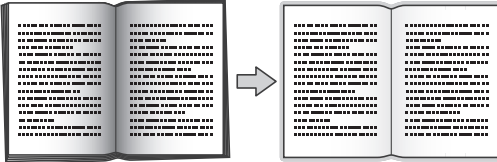
Option	Description	
Quality	Select the Copy resolution for your type of document. When you select the Normal or Fast option, Plain Paper is the only Paper Type option.	
Paper Type	Select a paper type. If you are copying on special paper, set the machine for the type of paper you are using to get the best print quality.	
Paper Size	Select a paper size. If you are copying on paper other than A4 size, you must change the Paper Size setting.	
Enlarge/Reduce	100%	-
	Enlarge	Select an enlargement ratio for the next copy.
	Reduce	Select a reduction ratio for the next copy.
	Fit to Page	Adjusts the copy size to fit on the paper size you have set.
Custom (25-400%)	Enter an enlargement or reduction ratio.	
Density	Increase the density to make the text darker. Decrease the density to make the text lighter.	
Stack/Sort	Select to stack or sort multiple copies.	
	Stack 	Sort 
Page Layout	Make N in 1, 2 in 1 ID, or Poster copies.	
	4 in 1 	Poster 
2-sided Copy	Select to copy on both sides of the paper.	
	1-sided→2-sided 	2-sided→2-sided 

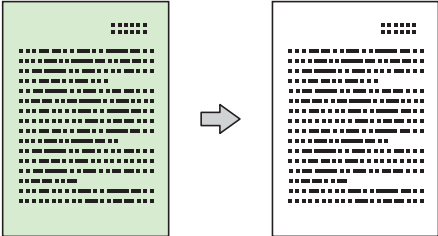
Option	Description
Advanced Settings	<p>Ink Save Mode (MFC-J985DW)</p> <p>Prints colours lighter and emphasises the outlines of images.</p> 
	<p>Thin Paper Copy (MFC-J985DW)</p> <p>Avoids bleeding through thin paper when copying.</p> 
	<p>Book Copy (MFC-J985DW)</p> <p>Corrects dark borders and skew when copying from the scanner glass.</p> 
	<p>Watermark Copy (MFC-J985DW)</p> <p>Places text in your document as a watermark.</p> 
	<p>Remove Background Colour</p> <p>Removes the document's background colour in copies. The white background becomes more apparent. This saves some ink and may make certain copies easier to read.</p> 
Set New Default	<p>Saves the copy settings that you use most often by setting them as the default settings.</p>
Factory Reset	<p>Restores any changed copy settings to the factory settings.</p>
Save as Shortcut	<p>Add the current settings as a shortcut.</p>



(MFC-J985DW)

The Ink Save Mode, Thin Paper Copy, Book Copy and Watermark Copy features are supported by technology from Reallusion, Inc.



Related Information

- [Copy](#)
 - [Copy a Document](#)
-

Fax

- [Send a Fax](#)
- [Receive a Fax](#)
- [Voice Operations and Fax Numbers](#)
- [Telephone Services and External Devices](#)
- [Fax Reports](#)
- [PC-FAX](#)

Send a Fax

- [Send a Fax from Your Brother Machine](#)
- [Send a Fax Manually](#)
- [Send a Fax at the End of a Conversation](#)
- [Send the Same Fax to More than One Recipient \(Broadcasting\)](#)
- [Send a Fax in Real Time](#)
- [Send a Fax at a Specified Time \(Delayed Fax\)](#)
- [Cancel a Fax in Progress](#)
- [Check and Cancel a Pending Fax](#)
- [Fax Polling](#)
- [Fax Options](#)

Send a Fax from Your Brother Machine

Related Models: MFC-J985DW

1. Load your document in the ADF or on the scanner glass.
2. Press  [Fax].



If [Fax Preview] is set to [On], press  [Fax] > [Sending Faxes].

The touchscreen displays:



3. Enter the fax number in one of the following ways:
 - Dial Pad (Enter the fax number manually.)
Press all digits of the number using the touchscreen.
 - [Redial] (Redial the last number you dialed.)
Press [Call History] > [Redial].
 - [Outgoing Call] (Select a number from the Outgoing Call history.)
Press [Call History] > [Outgoing Call].
Select the number you want, and then press [Apply].
 - [Caller ID history] (Select a number from the Caller ID history.)
Press [Call History] > [Caller ID history].
Select the number you want, and then press [Apply].
 - [Address Book] (Select a number from the Address Book.)
Press [Address Book].
Do one of the following:
 - Select the number you want, and then press [Apply].
 - Press , and then enter the first letter of the name and press [OK]. Press the name you want to dial. If the name has two numbers, press the number you want. Press [Apply].
4. To change the fax settings, press [Options].
5. Press ▲ or ▼ to display the setting you want to change, and then press it.
6. Press the option you want.
7. When finished, press [OK].
8. Press [Fax Start].

9. Do one of the following:

- If you are using the ADF, the machine starts scanning and sending the document.
- If you are using the scanner glass and selecting [Mono] in the [Colour Setting], the machine starts scanning the first page.

Go to the next step.

- If you are using the scanner glass and selecting [Colour] in the [Colour Setting], the touchscreen asks if you want to send a colour fax.

Press [Yes (Colour fax)] to confirm. The machine starts dialling and sending the document.

10. When the touchscreen displays [Next Page?], do one of the following:

- Press [No] when finished scanning pages. The machine starts sending the document.
- Press [Yes] to scan another page. Place the next page on the scanner glass, and then press [OK]. The machine starts scanning the page.

Repeat this step for each additional page.



Related Information

- [Send a Fax](#)
- [Fax Options](#)

Send a Fax Manually

Related Models: MFC-J985DW

Manual fax transmission lets you hear the dialling, ringing and fax-receiving tones while sending a fax.

1. Load your document.
2. To listen for a dial tone, pick up the handset of the external telephone.
3. Dial the fax number using the external telephone.
4. When you hear fax tones, press  and then press [Fax Start].
 - If using the scanner glass, press [Send].
5. Replace the handset of the external phone.



Related Information

- [Send a Fax](#)

Send a Fax at the End of a Conversation

Related Models: MFC-J985DW

At the end of a conversation, you can send a fax to the other party before you both hang up.

1. Ask the other party to wait for fax tones (beeps), and then press the Start or Send key before hanging up.
2. Load your document.
3. Press [Fax Start].
 - If using the scanner glass, press [Send].



If the touchscreen does not show [Fax Start], press  to display it.

4. Replace the handset of an external telephone.



Related Information

- [Send a Fax](#)

Send the Same Fax to More than One Recipient (Broadcasting)

Related Models: MFC-J985DW

Use the Broadcasting feature to send the same fax to multiple fax numbers at the same time.

- This feature is available only for monochrome faxes.
- Address Book numbers must be stored in the machine's memory before they can be used in a broadcast.
- Group numbers must also be stored in the machine's memory before they can be used in a broadcast. Group numbers include many stored Address Book numbers for easier dialling.

You can include Groups, Address Book numbers and up to 50 manually-dialled numbers in the same broadcast.

If you did not use any of the Address Book numbers for Groups, you can broadcast faxes to as many as 250 different numbers.

1. Load your document.

2. Press  [Fax].



If [Fax Preview] is set to [On], press  [Fax] > [Sending Faxes].

3. Press [Options] > [Broadcasting].

4. Press [Add Number].

You can add numbers to the broadcast in the following ways:

- Press [Add Number] and enter a fax number using the touchscreen. Press [OK].
- Press [Add from Address book]. Press ▲ or ▼ to display the numbers you want to add to the broadcast. Select the check boxes of the numbers you want to add.
When finished, press [OK].
- Press [Search in Address book]. Press the first letter of the name and press [OK]. Press the name, and then press the number you want to add.

Repeat this step to enter additional fax numbers.

5. When finished, press [OK].

6. Press [Fax Start].

7. Do one of the following:

- If you are using the ADF, the machine starts scanning and sending the document.
- If you are using the scanner glass, the machine starts scanning the first page.

When the touchscreen displays [Next Page?], do one of the following:

- Press [No] when finished scanning pages. The machine starts sending the document.
- Press [Yes] to scan another page. Place the next page on the scanner glass, and then press [OK]. The machine starts scanning the page.

Repeat this step for each additional page.



If the [Out of Memory] message appears, press  or [Quit] to cancel or [Send Now] to send the pages scanned so far.



Related Information



- [Send a Fax](#)

-
- [Cancel a Broadcast in Progress](#)
 - [Set up Groups for Broadcasting](#)
 - [Enter Text on Your Brother Machine](#)
-

Cancel a Broadcast in Progress

Related Models: MFC-J985DW

While broadcasting you can cancel the fax currently being sent or the whole broadcast job.

1. Press .
2. Do one of the following:
 - To cancel the entire broadcast, press [Entire Broadcast]. Press [Yes] to confirm or press [No] to exit without cancelling.
 - To cancel the current number being dialled, press the name or number on the touchscreen. Press [Yes] to confirm or press [No] to exit without cancelling.
 - To exit without cancelling, press .



Related Information

- [Send the Same Fax to More than One Recipient \(Broadcasting\)](#)

Send a Fax in Real Time

Related Models: MFC-J985DW

When sending a fax, the machine scans the document into the memory before sending it. As soon as the telephone line is free, the machine starts dialling and sending. If you want to send an important document immediately without waiting for the machine to retrieve the scan from its memory, transmit the fax quickly by turning on [Real Time TX].

- If you are sending a colour fax or if the machine's memory is full and you are sending a monochrome fax from the ADF, the machine sends the document in real time (even if [Real Time TX] is set to [Off]).
- In Real Time Transmission, the automatic redial feature does not work when using the scanner glass.

1. Load your document.

2. Press  [Fax].



If [Fax Preview] is set to [On], press  [Fax] > [Sending Faxes].

3. Press [Options] > [Real Time TX].

4. Press [On] (or [Off]).

5. Press [OK].

6. Enter the fax number.

7. Press [Fax Start].



Related Information

- [Send a Fax](#)

Send a Fax at a Specified Time (Delayed Fax)

Related Models: MFC-J985DW

You can store up to 50 faxes in the machine's memory to be sent within the next twenty-four hour period.

This feature is available only for monochrome faxes.

1. Load your document.

2. Press  [Fax].



If [Fax Preview] is set to [On], press  [Fax] > [Sending Faxes].

3. Press [Options] > [Delayed Fax].

4. Press [Delayed Fax].

5. Press [On].

6. Press [Set Time].

7. Enter the time you want the fax to be sent using the touchscreen. Press [OK].



The number of pages you can scan into the memory depends on the amount and type of data.

8. Press [OK].

9. Enter the fax number.

10. Press [Fax Start].

11. When the touchscreen displays [Next Page?], do one of the following:

- Press [No] when finished scanning pages. The machine starts sending the document.
- Press [Yes] to scan another page. Place the next page on the scanner glass, and then press [OK]. The machine starts scanning the page.

Repeat this step for each additional page.





Related Information

- [Send a Fax](#)

Cancel a Fax in Progress

Related Models: MFC-J985DW

1. Press  to cancel a fax that is already in process.
2. When you press  while the machine is dialling or sending, the touchscreen displays [Cancel Job?]. Press [Yes].





Related Information

- [Send a Fax](#)
- [Telephone and Fax problems](#)

Check and Cancel a Pending Fax

Related Models: MFC-J985DW

Follow these steps to view or to cancel faxes stored in the machine's memory and waiting to be sent. If there are no fax jobs in memory, the LCD displays [No Jobs Waiting]. You can cancel a fax job before it is sent.

1. Press  [Settings] > [All Settings] > [Fax] > [Remaining Jobs].
2. Do the following for each fax job you want to check or cancel:
 - a. Press ▲ or ▼ to scroll through the waiting jobs. If needed, press the job you want to cancel.
 - b. Press [OK].
 - c. Press [Yes] to confirm or press [No] to exit without cancelling.
3. When finished, press .



Related Information

- [Send a Fax](#)
- [Setup for Polled Transmit](#)
- [Telephone and Fax problems](#)

Fax Polling

Polling lets you set up your machine so the other party pays for the call when receiving a fax from you. It also lets you pay for the call when you call someone's fax machine to retrieve a fax. The polling feature must be set up on both machines to work. Not all fax machines support polling.

- [Polled Transmit](#)
- [Polling Receive](#)

Polled Transmit

Polled transmit lets you set up your machine to wait with a document so another fax machine can call and retrieve it.

The document will be stored and can be retrieved by any other fax machine until you delete it from the memory.

This feature is available only for monochrome faxes.

- [Setup for Polled Transmit](#)
- [Set Up Secure Polling](#)

Setup for Polled Transmit

Related Models: MFC-J985DW

This feature is available only for monochrome faxes.

1. Load your document.

2. Press  [Fax].



If [Fax Preview] is set to [On], press  [Fax] > [Sending Faxes].

3. Press [Options] > [Polled TX].

4. Press [Standard].

5. Press [Fax Start]. If you are using the ADF, the machine starts scanning the document.

6. If you are using the scanner glass, the touchscreen prompts you to select one of the following options:

- Press [No] when finished scanning pages.
- Press [Yes] to scan another page. Place the next page on the scanner glass, and then press [OK].

Repeat this step for each additional page.

7. Your machine automatically sends the fax when it is polled, and then prints the POLLED REPORT.



To delete the fax from memory, press  [Settings] > [All Settings] > [Fax] > [Remaining Jobs].



Related Information

- [Polled Transmit](#)
- [Check and Cancel a Pending Fax](#)

Set Up Secure Polling

Related Models: MFC-J985DW

Use the Secure Polling feature to restrict access to the documents you set up to be polled.

- This feature is available only for monochrome faxes.
- Secure Polling works only with Brother fax machines. To retrieve a fax from your machine, someone must enter the secure code.

1. Load your document.

2. Press  [Fax].



(MFC-J985DW)

If [Fax Preview] is set to [On], press  [Fax] > [Sending Faxes].

3. Press [Options] > [Polled TX].

4. Press [Secure].

5. Enter the four-digit secure code using the touchscreen. Press [OK].

6. Press [Fax Start].

7. If you are using the scanner glass, the touchscreen prompts you to select one of the following options:

- Press [No] when finished scanning pages.
- Press [Yes] to scan another page. Place the next page on the scanner glass, and then press [OK].

Repeat this step for each additional page.

8. Your machine automatically sends the fax when it is polled.



Related Information

- [Polled Transmit](#)

Fax Options

Related Models: MFC-J985DW

To change fax-sending settings, press the [Options] button.

Option	Description
Fax Resolution	Set the resolution for outgoing faxes. The fax quality often can be improved by changing the Fax Resolution.
Contrast	Adjust the contrast. If your document is very light or very dark, changing the contrast may improve the fax quality.
Broadcasting (monochrome only)	Send the same fax message to more than one fax number at the same time.
Preview (monochrome only)	<ul style="list-style-type: none"> Preview a fax message before you send it. You cannot send a colour fax when <i>Preview</i> is set to <i>On</i>.
Colour Setting	Set whether faxes are sent in monochrome or colour. <ul style="list-style-type: none"> Colour faxes cannot be stored in the machine's memory and the machine sends them immediately. Use the ADF to send colour faxes with multiple pages. You cannot send a colour fax when <i>Preview</i> is set to <i>On</i>.
Delayed Fax (monochrome only)	Set the time of day the delayed faxes will be sent.
Batch TX (monochrome only)	Economise by sending all delayed faxes scheduled for the same time and fax number as one fax to save transmission time.
Real Time TX	Send a fax immediately without waiting for the machine to retrieve the scan from its memory.
Polled TX (monochrome only)	Set the machine with a document to be retrieved by another fax machine.
Polling RX (monochrome only)	Set the machine to poll another fax machine.
Overseas Mode	Set to <i>On</i> if you have difficulty sending faxes overseas.
Glass Scan Size	Adjust the scan area of the scanner glass to the size of the document.
Call History	Select a number from the Call History.
Address Book	Select a number from the Address Book.
Set New Default	Save your settings as the default.
Factory Reset	Restore all settings back to the factory settings.



You can save the current settings by pressing [Save as Shortcut].



Related Information

- [Send a Fax](#)
- [Send a Fax from Your Brother Machine](#)

Receive a Fax

- [Receive Mode Settings](#)
- [Fax Preview](#)
- [Shrink Page Size of an Oversized Incoming Fax](#)
- [Set the Fax Receive Stamp](#)
- [Receive a Fax at the End of a Telephone Conversation](#)
- [Memory Receive Options](#)
- [Remote Fax Retrieval](#)
- [Fax Polling](#)

Receive Mode Settings

- [Receive Modes](#)
- [Choose the Correct Receive Mode](#)
- [Set the Number of Rings Before the Machine Answers \(Ring Delay\)](#)
- [Set the F/T Ring Time \(Pseudo/Double-ring\)](#)
- [Set Fax Detect](#)

Receive Modes

Related Models: MFC-J985DW

Some receive modes answer automatically ([Fax Only] and [Fax/Tel]). You may want to change the Ring Delay before using these modes.

Fax Only

[Fax Only] mode automatically will answer every call as a fax.

Fax/Tel

[Fax/Tel] mode helps you manage incoming calls, by recognising whether they are fax or voice calls and handling them in one of the following ways:

- Faxes will be received automatically.
- Voice calls will start the F/T ring to tell you to pick up the line. The F/T ring is a pseudo/double-ring made by your machine.

Manual

[Manual] mode turns off all automatic answering functions (unless you are using the BT Call Sign feature).

To receive a fax in [Manual] mode, lift the handset of the external telephone. When you hear fax tones (short repeating beeps), press the Start button, and then select [Receive] to receive a fax. You can also use the Fax Detect feature to receive faxes by lifting a handset on the same line as the machine.

External TAD

[External TAD] mode lets an external answering device manage your incoming calls.

Incoming calls will be handled in the following ways:

- Faxes will be received automatically.
- Voice callers can record a message on the external TAD.



Related Information

- [Receive Mode Settings](#)
- [Set the Number of Rings Before the Machine Answers \(Ring Delay\)](#)
- [Set the F/T Ring Time \(Pseudo/Double-ring\)](#)
- [Set Fax Detect](#)
- [Connect an External TAD](#)

Choose the Correct Receive Mode

Related Models: MFC-J985DW

You must choose a Receive Mode depending on the external devices and telephone services you have on your line.

By default, your machine automatically will receive any faxes that are sent to it. The diagram below will help you select the correct mode.

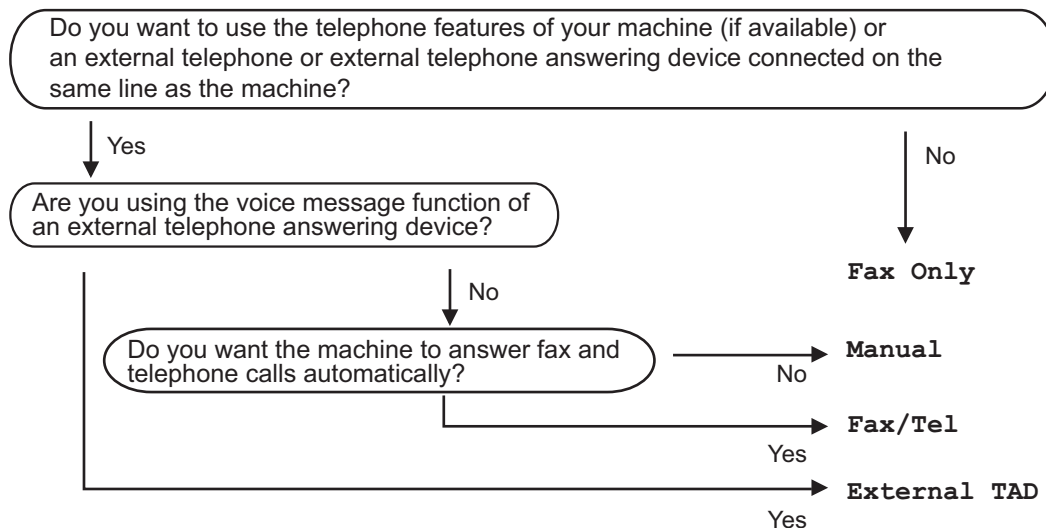

1. Press  [Settings] > [All Settings] > [Fax] > [Setup Receive] > [Receive Mode].



If the option to change the Receive Mode is unavailable, make sure the BT Call Sign feature is set to [Off].

2. Press ▲ or ▼ to display the [Fax Only], [Fax/Tel], [External TAD], or [Manual] option, and then press the option you want.
3. Press .



Related Information

- [Receive Mode Settings](#)
- [Remote Retrieval Commands](#)
- [Enable the Machine to Work with BT Call Sign \(with Your External Telephone only\)](#)
- [Connect an External TAD](#)
- [Telephone and Fax problems](#)

Set the Number of Rings Before the Machine Answers (Ring Delay)

Related Models: MFC-J985DW

When somebody calls your machine, you will hear the normal telephone ring sound. The number of rings is set in the Ring Delay option.

- The Ring Delay setting sets the number of times the machine rings before it answers in [Fax Only] and [Fax/Tel] modes.
- If you have external or extension telephones on the same line as the machine, select the maximum number of rings.

1. Press  [Settings] > [All Settings] > [Fax] > [Setup Receive] > [Ring Delay].
2. Press the number of times you want the line to ring before the machine answers.



- If you select [0], the machine will answer immediately and the line will not ring at all (available only for some countries).

3. Press .



Related Information



- [Receive Mode Settings](#)
- [Receive Modes](#)
- [Operation from External and Extension Telephones](#)
- [Set Fax Detect](#)
- [Telephone and Fax problems](#)

Set the F/T Ring Time (Pseudo/Double-ring)

Related Models: MFC-J985DW

When you set the Receive Mode to [Fax/Tel], if the call is a fax, your machine will receive it automatically. However, if it is a voice call, the machine will sound the F/T ring (pseudo/double-ring) for the time you set in the F/T Ring Time option. When you hear the F/T ring, it means that a voice caller is on the line.

Because the F/T ring is a setting only on your Brother machine, extension and external telephones will not ring; however, you can still answer the machine's call on any telephone.

1. Press  [Settings] > [All Settings] > [Fax] > [Setup Receive] > [F/T Ring Time].
2. Press how long the machine will double-ring to alert you to a voice call.
3. Press .



Even if the caller hangs up during the pseudo/double-ringing, the machine will continue to ring for the set time.



Related Information

- [Receive Mode Settings](#)
- [Receive Modes](#)
- [Operation from External and Extension Telephones](#)

Set Fax Detect



Related Models: MFC-J985DW

If Fax Detect is On: The machine receives a fax call automatically, even if you answer the call. When the message that your machine is receiving a fax appears on the LCD or when you hear “chirps” through the handset you are using, just replace the handset. Your machine will do the rest.

If Fax Detect is Off: If you are at the machine and answer a fax call by lifting the handset, press the Start button, and then select [Receive] to receive the fax. If you answered at an extension or external telephone, press *51.



- If Fax Detect is set to [On], but your machine does not connect a fax call when you lift an extension or external telephone handset, press the remote activation code *51.
- If you send faxes from a computer on the same telephone line and the machine intercepts them, set Fax Detect to [Off].

1. Press  [Settings] > [All Settings] > [Fax] > [Setup Receive] > [Fax Detect].
2. Press [On] (or [Off]).
3. Press .



Related Information

- [Receive Mode Settings](#)
- [Receive Modes](#)
- [Set the Number of Rings Before the Machine Answers \(Ring Delay\)](#)
- [Operation from External and Extension Telephones](#)
- [Use the Remote Codes](#)
- [Telephone and Fax problems](#)

Fax Preview

Use the Fax Preview feature to view received faxes on the LCD.

- [Set Fax Preview to On](#)
- [Preview New Faxes](#)

Set Fax Preview to On

Related Models: MFC-J985DW

- This feature is available only for monochrome faxes.
- When Fax Preview is turned on, a backup copy of received faxes will not be printed for Fax Forwarding, PC-Fax Receiving and Forward to Cloud operations, even if you set Backup Print to [On].
- Although printed faxes show the received date and time when Fax Receive Stamp is turned on, the Fax Preview screen will not display the received date and time.

1. Press  [Settings].

2. Press  [Fax Preview].

3. Press [On] (or [Off]).

4. Press [Yes].

The touchscreen displays a message saying future received faxes will not be printed.

5. Press [Yes].

6. Press .



If faxes are stored in the memory when you change Fax Preview to Off, do one of the following:

- If you do not want to print the stored faxes, press [Continue].
Press [Yes] to confirm.
Your faxes will be deleted.
- To print all the stored faxes, press [Print All Faxes Before Delete].
- If you do not want to turn off Fax Preview, press [Cancel].



Related Information

- [Fax Preview](#)

Preview New Faxes

Related Models: MFC-J985DW

When a fax is received, a message appears on the LCD.

- This feature is available only for monochrome faxes.
- To see a fax you already previewed, press  [Fax] and  [Received Faxes].

1. Press [View].

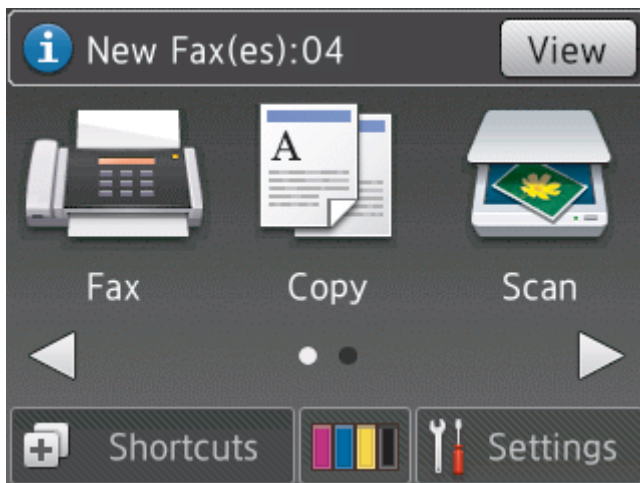

2. The fax list includes old and new faxes. A blue mark appears next to new faxes. Press the fax you want.

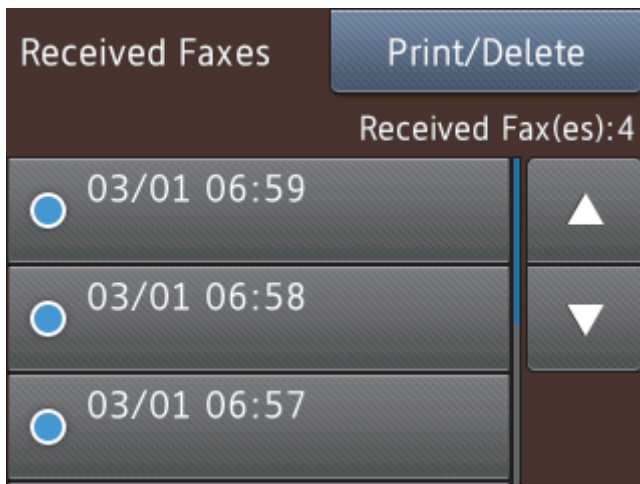







If you want to print or delete all the faxes in the list, press [Print/Delete].

Do one of the following:

- Press [Print All (New Faxes)] to print all faxes you have not yet viewed.
- Press [Print All (Old Faxes)] to print all faxes you have viewed.
- Press [Delete All (New Faxes)] to delete all faxes you have not yet viewed.
- Press [Delete All (Old Faxes)] to delete all faxes you have viewed.

3. Perform the following operations by pressing the buttons shown in the table:

Button	Result
	Enlarge the fax.
	Reduce the fax.
▲ or ▼	Scroll vertically.
◀ or ▶	Scroll horizontally.
	Rotate the fax clockwise.
	Delete the fax. Press Yes to confirm.
	Go back to the previous page.
	Go to the next page.
	Go back to the fax list.

Start Print the fax.
If the fax is a single page, it starts printing. A touchscreen message asks if you want to delete the fax from the machine's memory. To delete the fax, press **Yes**. To keep the fax in the machine's memory, press **No**.

If the fax has multiple pages, do one of the following:

- Press **Print All Pages** to print the whole message. A touchscreen message asks if you want to delete the fax from the machine's memory. To delete the fax, press **Yes**. To keep the fax in the machine's memory, press **No**.
- Press **Print Displayed Only** to print only the displayed page.
- Press **Print From Displayed** to print from the displayed page to the last page.

- If your fax is large there may be a delay before it is displayed.
- The Touchscreen displays the current page number and total pages of the fax message. If your fax message is over 99 pages, the total number of pages appears as "XX."

4. Press .



Related Information

- [Fax Preview](#)

Shrink Page Size of an Oversized Incoming Fax

Related Models: MFC-J985DW

When the [Auto Reduction] feature is [On], your Brother machine reduces any oversized incoming fax page to fit on your paper. The machine calculates the reduction ratio using the page size of the fax and your Paper Size setting.

1. Press  [Settings] > [All Settings] > [Fax] > [Setup Receive] > [Auto Reduction].
2. Press [On] (or [Off]).
3. Press .

Related Information



- [Receive a Fax](#)
- [Paper Settings](#)
- [Paper Handling and Printing Problems](#)

Set the Fax Receive Stamp

Related Models: MFC-J985DW

Set the machine to print the date and time of receipt at the top of each incoming fax page. Make sure you have set the current date and time on the machine.

This feature is available only for monochrome faxes.

1. Press  [Settings] > [All Settings] > [Fax] > [Setup Receive] > [Fax Rx Stamp].
2. Press [On] (or [Off]).
3. Press .

Related Information

- [Receive a Fax](#)

Receive a Fax at the End of a Telephone Conversation

Related Models: MFC-J985DW

If you are speaking on the telephone connected to your Brother machine and the other party is also speaking on a telephone connected to his fax machine, at the end of the conversation, the other party can send you a fax before you both hang up.

- Your machine's ADF must be empty.
1. Ask the other party to load the fax and to press the Start or Send key.
 2. When you hear CNG tones (slow, repeated beeps), press [Fax Start].



- If the Touchscreen is dark (in Sleep Mode), touch it to display [Fax Start].
- If the touchscreen does not show [Fax Start], press  to display it.

3. Press [Receive] to receive the fax.
4. Replace the external handset.



Related Information

- [Receive a Fax](#)

Memory Receive Options

Use Memory Receive options to direct incoming faxes while you are away from the machine. You can use only one Memory Receive option at a time.

Memory Receive can be set to:

- Fax Forwarding
- Fax Storage
- PC-Fax Receive
- Forward to Cloud

The machine forwards your received faxes to the online services. For more detailed information, see the *Web Connect Guide*.

- Off

This feature is available only for monochrome faxes.



- [Forward Incoming Faxes to Another Machine](#)
- [Store Incoming Faxes in the Machine's Memory](#)
- [Use PC-Fax Receive to Transfer Received Faxes to Your Computer \(Windows® only\)](#)
- [Change Memory Receive Options](#)
- [Turn Off Memory Receive](#)
- [Print a Fax Stored in the Machine's Memory](#)

Forward Incoming Faxes to Another Machine

Related Models: MFC-J985DW

Use the Fax Forwarding feature to automatically forward your incoming faxes to another machine.

This feature is available only for monochrome faxes.

1. Press  [Settings] > [All Settings] > [Fax] > [Setup Receive] > [Memory Receive].
2. Press  or  to display the [Fax Forward] option, and then press it.
3. Enter the forwarding fax number (up to 20 digits) using the touchscreen.
Press [OK].
4. Press [Backup Print: On] or [Backup Print: Off].



- If you select [Backup Print: On], the machine prints a copy of each received fax at your machine.
- When Fax Preview is turned on, a backup copy of received faxes will not be printed, even if you select [Backup Print: On].
- If you receive a colour fax, your machine only prints the colour fax and does not forward it to the Fax Forwarding number you programmed.

5. Press .



Related Information





- [Memory Receive Options](#)

Store Incoming Faxes in the Machine's Memory

Related Models: MFC-J985DW

Use the Fax Storage feature to store incoming faxes in the machine's memory. Retrieve your stored fax messages from a fax machine at another location using the Remote Retrieval commands. Your machine prints a backup copy of each stored fax.

- This feature is available only for monochrome faxes.

1. Press  [Settings] > [All Settings] > [Fax] > [Setup Receive] > [Memory Receive].
2. Press  or  to display the [Fax Storage] option, and then press it.
3. Press .

Related Information

- [Memory Receive Options](#)
- [Forward Faxes Remotely](#)
- [Print a Fax Stored in the Machine's Memory](#)
- [Remote Retrieval Commands](#)



Use PC-Fax Receive to Transfer Received Faxes to Your Computer (Windows® only)

Related Models: MFC-J985DW

Turn on the PC-Fax Receive feature, automatically store incoming faxes to your machine's memory, and then send them to your computer. Use your computer to view and store these faxes.

- This feature is available only for monochrome faxes. When you receive a colour fax, your machine prints the colour fax but does not send the fax to your computer.
- Before you can set up PC-Fax Receive, you must install the Brother software and drivers on your computer. Make sure your computer is connected and turned on. You must have the PC-FAX Receiving software running on your computer.

Even if your computer is turned off, your machine will receive and store faxes in its memory. When you start your computer and the PC-FAX Receiving software runs, your machine transfers faxes to your computer automatically.

1. Press  [Settings] > [All Settings] > [Fax] > [Setup Receive] > [Memory Receive].
2. Press  or  to display the [PC Fax Receive] option, and then press it.
The touchscreen displays the message [Run PC-Fax on your computer.]
3. Press [OK].
4. Press [<USB>] or press the name of the computer you want to receive faxes if you are on a network. Press [OK].
5. Press [Backup Print: On] or [Backup Print: Off].



When Fax Preview is turned on, a backup copy of received faxes will not be printed, even if you select [Backup Print: On].

6. Press .

To change the destination computer, repeat these steps.



Related Information

- [Memory Receive Options](#)
- [Transfer Your Faxes or Fax Journal Report](#)
- [Transfer Faxes to Your Computer](#)
- [Receive Faxes Using PC-FAX Receive \(Windows®\)](#)

Change Memory Receive Options

Related Models: MFC-J985DW

If there are faxes in your machine's memory when you change any Memory Receive option, the LCD displays one of the following questions:

- **If received faxes have already been printed, the touchscreen displays [Erase all documents?]**
 - If you press [Yes], faxes in the memory will be erased before the setting changes.
 - If you press [No], faxes in the memory will not be erased and the setting will be unchanged.
- **If unprinted faxes are in the machine's memory, the touchscreen displays [Print all faxes?]**
 - If you press [Yes], faxes in the memory will be printed before the setting changes.
 - If you press [No], faxes in the memory will not be printed and the setting will be unchanged.
- If received faxes are left in the machine's memory when you change to [PC Fax Receive] from another option ([Fax Forward], [Forward to Cloud], or [Fax Storage]), press [<USB>] or the name of the computer if you are on a network, and then press [OK].

The touchscreen displays:

[Send Fax to PC?]

- If you press [Yes], faxes in the memory will be sent to your computer before the setting changes. You will be asked if you want to turn on Backup Print.
- If you press [No], faxes in the memory will not be erased and the setting will be unchanged.

✓ Related Information

- [Memory Receive Options](#)
- [Turn Off Memory Receive](#)

Turn Off Memory Receive

Related Models: MFC-J985DW

Turn off Memory Receive if you do not want the machine to save or transfer incoming faxes.

1. Press  [Settings] > [All Settings] > [Fax] > [Setup Receive] > [Memory Receive].
2. Press [Off].



The touchscreen displays [Print all faxes?] or [Erase all documents?] if received faxes are in your machine's memory.

3. Press .



Related Information

- [Memory Receive Options](#)
- [Change Memory Receive Options](#)
- [Error and Maintenance Messages](#)
- [Telephone and Fax problems](#)

Print a Fax Stored in the Machine's Memory

Related Models: MFC-J985DW

- This feature is available only for monochrome faxes.
- After you print the fax, it is erased from the machine's memory.

If you select [Fax Storage], you can print all faxes from the memory.

1. Press  [Settings] > [All Settings] > [Fax] > [Print Document].



When [Fax Preview] is set to [Off], you can also print a fax from the memory by pressing [Print] on the touchscreen.

2. Press [OK].
3. Press .

Related Information

- [Memory Receive Options](#)
- [Store Incoming Faxes in the Machine's Memory](#)
- [Error and Maintenance Messages](#)
- [Telephone and Fax problems](#)

Remote Fax Retrieval

Use Remote Retrieval to call your machine from any touch-tone telephone or fax machine, and use a remote access code and remote commands to retrieve fax messages.

- [Set a Remote Access Code](#)
- [Use Your Remote Access Code](#)
- [Remote Retrieval Commands](#)
- [Forward Faxes Remotely](#)
- [Change the Fax Forwarding Number](#)

Set a Remote Access Code

Related Models: MFC-J985DW

Set a Remote Access Code to access and control your Brother machine even when you are away from it.

1. Press  [Settings] > [All Settings] > [Fax] > [Remote Access].
2. Enter a three-digit code using the numbers [0] through [9], [*], or [#] using the touchscreen (The preset '*' cannot be changed).
Press [OK].



- DO NOT use the same code used for your Remote Activation Code (*51) or Remote Deactivation Code (#51).
- To delete your code, press and hold  to restore the inactive setting (- - - *), and then press [OK].

3. Press .



Related Information

- [Remote Fax Retrieval](#)
- [Use Your Remote Access Code](#)
- [Operation from External and Extension Telephones](#)
- [Use the Remote Codes](#)

Use Your Remote Access Code

Related Models: MFC-J985DW

1. When away from your Brother machine, dial your fax number from a touch-tone telephone or fax machine.
2. When your machine answers, immediately enter your three-digit Remote Access Code, followed by *.
3. Your Brother machine signals if it has received faxes:
 - One long beep - the machine received at least one fax
 - No beeps - the machine has not received a fax
4. When the machine gives two short beeps, enter a command.
 - The machine will hang up if you wait longer than 30 seconds to enter a command.
 - The machine will beep three times if you enter an invalid command.
5. When finished, press 9, and then press 0 to deactivate your machine.
6. Hang up.



- If your machine is set to [Manual] mode and you are using Remote Retrieval, wait for about 100 seconds after your fax number starts ringing, and enter your Remote Access Code within 30 seconds.
- This feature may not be available in some countries or supported by your local telephone company.



Related Information

- [Remote Fax Retrieval](#)
- [Set a Remote Access Code](#)

Remote Retrieval Commands

Related Models: MFC-J985DW

Use the Remote Commands in this table to access fax commands and options when you are away from your Brother machine. When you call the machine and enter your remote access code (three digits followed by *), the system will sound two short beeps and you must enter a Remote Command (column 1), followed by one of the options (column 2) for that command.

Remote commands	Options	Operation details
95	Change the Fax Forwarding, or Fax Storage settings	
	1 OFF	You can select <i>Off</i> after you retrieve or erase all your messages.
	2 Fax Forwarding	One long beep means the change is accepted. If you hear three short beeps, you cannot make a change because something has not been set up (for example, a Fax Forwarding number has not been registered). You can register your Fax Forwarding number by entering 4. After you register the number, Fax Forwarding will work.
	4 Fax Forwarding number	
6 Fax Storage		
96	Retrieve a fax	
	2 Retrieve all faxes	Enter the fax number of a remote fax machine to receive stored fax messages.
	3 Erase faxes from memory	If you hear one long beep, fax messages have been erased from memory.
97	Check the receiving status	
	1 Fax	Check whether your machine has received any faxes. If yes, you will hear one long beep. If not, you will hear three short beeps.
98	Change the Receive Mode	
	1 External TAD	One long beep means the change has been accepted.
	2 Fax/Tel	
	3 Fax Only	
90	Exit	Press 9 0 to stop remote retrieval. Wait for the long beep, then hang up.



Related Information

- [Remote Fax Retrieval](#)
- [Change the Fax Forwarding Number](#)
- [Store Incoming Faxes in the Machine's Memory](#)
- [Forward Faxes Remotely](#)
- [Choose the Correct Receive Mode](#)

Forward Faxes Remotely

Related Models: MFC-J985DW

Call your Brother machine from any touch-tone telephone or fax machine to forward incoming faxes to another machine.

- You must turn on Fax Storage , or Fax Preview before you use this feature.

1. Dial your fax number.
2. When your machine answers, enter your Remote Access Code (three digits followed by *). If you hear one long beep, you have messages.
3. When you hear two short beeps, press 9 6 2.
4. Wait for the long beep, and then use the dial pad to enter the fax number (up to 20 digits) of the remote fax machine where you want your fax messages sent, followed by # #.



You cannot use * and # as dial numbers but you can press # to insert a pause in the fax number.

5. Hang up after you hear one long beep. Your Brother machine will forward any incoming faxes to the fax number you entered. The other fax machine will then print your fax messages.



Related Information

- [Remote Fax Retrieval](#)
- [Store Incoming Faxes in the Machine's Memory](#)
- [Remote Retrieval Commands](#)

Change the Fax Forwarding Number

Related Models: MFC-J985DW

1. Dial your fax number.
2. When your machine answers, enter your Remote Access Code (three digits followed by *). If you hear one long beep, you have messages.
3. When you hear two short beeps, press 9 5 4.
4. Wait for the long beep, enter the new number (up to 20 digits) of the remote fax machine you want your fax messages forwarded to using the dial pad, then enter # #.



You cannot use * and # as dial numbers but you can press # to insert a pause in the fax number.

5. Press 9 0 to stop Remote Access when finished.
6. Hang up after you hear one long beep.



Related Information

- [Remote Fax Retrieval](#)
- [Remote Retrieval Commands](#)

Fax Polling

Polling lets you set up your machine so the other party pays for the call when receiving a fax from you. It also lets you pay for the call when you call someone's fax machine to retrieve a fax. The polling feature must be set up on both machines to work. Not all fax machines support polling.

- [Polled Transmit](#)
- [Polling Receive](#)

Polling Receive

Polling Receive lets you call another fax machine to receive a fax.

- [Setup for Polling Receive](#)
- [Setup for Polling Receive with Secure Code](#)
- [Setup for Delayed Polling Receive](#)
- [Setup for Sequential Polling Receive](#)
- [Cancel a Sequential Polling Job](#)
- [Stop Polling](#)

Setup for Polling Receive

Related Models: MFC-J985DW

1. Press  [Fax].



If [Fax Preview] is set to [On], press  [Fax] > [Sending Faxes].

2. Press [Options] > [Polling RX].
3. Press [Standard].
4. Enter the fax number you are polling using the Address Book or keyboard.
5. Press [Fax Start].



Related Information

- [Polling Receive](#)

Setup for Polling Receive with Secure Code

Related Models: MFC-J985DW

Secure Polling lets you poll another fax machine to receive a fax the other party has set up with a security code.

- Secure Polling only works with Brother fax machines. To get a fax from a secured Brother machine you must enter the secure code.

1. Press  [Fax].



(MFC-J985DW)

If [Fax Preview] is set to [On], press  [Fax] > [Sending Faxes].

2. Press [Options] > [Polling RX].
3. Press [Secure].
4. Enter the four-digit secure code using the touchscreen. This code is the security code of the fax machine you are polling. Press [OK].
5. Enter the fax number you are polling using the Address Book or keyboard.
6. Press [Fax Start].



Related Information

- [Polling Receive](#)

Setup for Delayed Polling Receive

Related Models: MFC-J985DW

Delayed Polling Receive lets you set your machine to begin polling receive at a later time. You can set up only one delayed polling operation.

1. Press  [Fax].



(MFC-J985DW)

If [Fax Preview] is set to [On], press  [Fax] > [Sending Faxes].

2. Press [Options] > [Polling RX].
3. Press [Timer].
4. Enter the time you want to start polling. Press [OK].
5. Enter the fax number you are polling using the Address Book or keyboard.
6. Press [Fax Start]. The machine makes the polling call at the time you entered.



Related Information

- [Polling Receive](#)

Setup for Sequential Polling Receive

Related Models: MFC-J985DW

Sequential Polling Receive lets you request documents from several fax machines in one operation. Afterwards, a Sequential Polling Report will be printed.

This feature is available only for monochrome faxes.

1. Press  [Fax].



If [Fax Preview] is set to [On], press  [Fax] > [Sending Faxes].

2. Press [Options] > [Polling RX].

3. Press [Standard], [Secure], or [Timer].

4. Do one of the following:

- If you selected [Standard], go to the next step.
- If you selected [Secure], enter the four-digit secure code using the touchscreen. Press [OK].
- If you selected [Timer], enter the time you want to start polling. Press [OK].

5. Press [Options] > [Broadcasting].

6. Press [Add Number].

You can add numbers to the broadcast in the following ways:

- Press [Add Number] and enter a fax number using the touchscreen. Press [OK].
- Press [Add from Address book]. Press ▲ or ▼ to display the numbers you want to add to the broadcast. Select the check boxes of the numbers you want to add.
When finished, press [OK].
- Press [Search in Address book]. Press the first letter of the name and press [OK]. Press the name, and then press the number you want to add.

Repeat this step to enter additional fax numbers.

7. When finished, press [OK].

8. Press [Fax Start].

The machine polls each number or Group number in turn for a document.





Related Information

- [Polling Receive](#)

Cancel a Sequential Polling Job

Related Models: MFC-J985DW

1. Press .
2. Do one of the following:
 - To cancel the entire sequential polling job, press [Entire Seq. Poll]. Press [Yes] to confirm or press [No] to exit without cancelling.
 - To cancel the current number being dialled, press the name or number on the touchscreen. Press [Yes] to confirm or press [No] to exit without cancelling.
 - To exit without cancelling, press .

Related Information

- [Polling Receive](#)

Stop Polling

Related Models: MFC-J985DW

To cancel the polling process, press  while the machine is dialling.



Related Information

- [Polling Receive](#)

Voice Operations and Fax Numbers

- [Voice Operations](#)
- [Store Fax Numbers](#)
- [Set up Groups for Broadcasting](#)

Voice Operations

- [Pick up a Voice Call in Fax/Tel Receive Mode](#)

Pick up a Voice Call in Fax/Tel Receive Mode

Related Models: MFC-J985DW

When the machine is in Fax/Tel mode, it will use the F/T Ring (pseudo/double-ringing) to alert you to pick up a voice call.

If you are at the machine, lift the external telephone's handset, and then press **Tel/R** button or [Pickup] button to answer.

If you are at an extension telephone, lift the handset during the F/T Ring and then press #51 between the pseudo/double rings. If no one is on the line, or if someone wants to send you a fax, send the call back to the machine by pressing *51.



Related Information

- [Voice Operations](#)

Store Fax Numbers

- [Store Address Book Numbers](#)
- [Store Address Book Numbers from Outgoing Calls](#)
- [Store Address Book Numbers from Caller ID History](#)
- [Change or Delete Address Book Names or Numbers](#)

Store Address Book Numbers

Related Models: MFC-J985DW

You can store up to 100 Addresses with a name, and each name can have two numbers.

1. Press  [Fax] > [Address Book].
2. Do the following steps:
 - a. Press [Edit] > [Add New Address] > [Name].
 - b. Enter the name (up to 16 characters) using the touchscreen. Press [OK].
 - c. Press [Address 1].
 - d. Enter the first fax or telephone number (up to 20 digits) using the touchscreen. Press [OK].



- Press [Pause] to insert a pause between numbers. You can press [Pause] as many times as needed to increase the length of the pause.
- Be sure to include the area code when entering a fax or telephone number. Depending on the country, the Caller ID names and history may not be displayed correctly if the area code is not registered with the fax or telephone number.

- e. To store the second fax or telephone number, press [Address 2]. Enter the second fax or telephone number (up to 20 digits) using the touchscreen. Press [OK].
- f. Press [OK] to confirm.

To store another Address Book number, repeat these steps.

3. Press .



Related Information

- [Store Fax Numbers](#)
- [Set up Groups for Broadcasting](#)

Store Address Book Numbers from Outgoing Calls

Related Models: MFC-J985DW

You can store Address Book numbers from the Outgoing Call history.

1. Press  [Fax] > [Call History] > [Outgoing Call].
2. Press ▲ or ▼ to display the number you want to store, and then press it.
3. Press [Edit] > [Add to Address Book] > [Name].



To delete the number from the Outgoing Call history list, press [Edit] > [Delete]. Press [Yes] to confirm.

4. Enter the name (up to 16 characters) using the touchscreen. Press [OK].
5. To store the second fax or telephone number, press [Address 2]. Enter the second fax or telephone number (up to 20 digits) using the touchscreen. Press [OK].
6. Press [OK] to confirm the fax or telephone number you want to store.
7. Press .



Related Information

- [Store Fax Numbers](#)
- [Enter Text on Your Brother Machine](#)

Store Address Book Numbers from Caller ID History

Related Models: MFC-J985DW

If you have Caller ID subscriber service from your telephone company, you can store Address Book numbers from incoming calls in the Caller ID history.

1. Press  [Fax] > [Call History] > [Caller ID history].
2. Press ▲ or ▼ to display the name or number you want to store, and then press it.
3. Press [Edit] > [Add to Address Book] > [Name].



To delete the number from the Caller ID history list, press [Edit] > [Delete]. Press [Yes] to confirm.

4. Enter the name (up to 16 characters) using the touchscreen. Press [OK].
5. To store the second fax or telephone number, press [Address 2]. Enter the second fax or telephone number (up to 20 digits) using the touchscreen. Press [OK].
6. Press [OK] to confirm the fax or telephone number you want to store.
7. Press .



Related Information

- [Store Fax Numbers](#)
- [Caller ID](#)
- [Enter Text on Your Brother Machine](#)

Change or Delete Address Book Names or Numbers

Related Models: MFC-J985DW

You can change or delete an Address Book name or number that has already been stored.

1. Press  [Fax] > [Address Book] > [Edit].
2. Press ▲ or ▼ to display [Change], and then press it.





To delete numbers, press ▲ or ▼ to display [Delete], and then press it. Select the numbers you want to delete by pressing them to display a red check mark, then press [OK]. Press [Yes] to confirm.

3. Press ▲ or ▼ to display the number you want to change, and then press it.
4. Do one of the following:
 - To change the name, press [Name].
Enter the new name (up to 16 characters) using the touchscreen.
Press [OK].
 - To change the first fax or telephone number, press [Address 1].
Enter the new fax or telephone number (up to 20 digits) using the touchscreen.
Press [OK].
 - To change the second fax or telephone number, press [Address 2].
Enter the new fax or telephone number (up to 20 digits) using the touchscreen.
Press [OK].



How to change the stored name or number:

To change a character, press ◀ or ▶ to position the cursor to highlight the character you want to change, and then press . Enter the new character.

5. Press [OK] to finish.
6. Press .



Related Information

- [Store Fax Numbers](#)

Set up Groups for Broadcasting

Related Models: MFC-J985DW

A Group, which can be stored in the Address Book, allows you to send the same fax message to many fax numbers.

First, you must store each fax number in the Address Book. Then you can include them as numbers in the Group. Each Group uses up an Address Book number. You can store up to six Groups.

1. Press  [Fax] > [Address Book].
2. Do the following steps:
 - a. Press [Edit] > [Setup Groups] > [Name].
 - b. Enter the Group name (up to 16 characters) using the touchscreen. Press [OK].
 - c. Press [Add/Delete].
 - d. Add Address Book numbers to the Group by pressing them to display a red checkmark. Press [OK].
 - e. Read and confirm the displayed list of names and numbers you have selected, and then press [OK] to save your Group.

To store another Group for broadcasting, repeat these steps.

3. Press .



Related Information

- [Voice Operations and Fax Numbers](#)
- [Change a Group Name](#)
- [Delete a Group](#)
- [Add or Delete Group Members](#)
- [Send the Same Fax to More than One Recipient \(Broadcasting\)](#)
- [Store Address Book Numbers](#)

Change a Group Name

Related Models: MFC-J985DW

1. Press  [Fax] > [Address Book] > [Edit] > [Change].
2. Press ▲ or ▼ to display the Group you want to change, and then press it.
3. Press [Name].
4. Enter the new Group name (up to 16 characters) using the touchscreen. Press [OK].



How to change the stored name:

To change a character, press ◀ or ▶ to position the cursor to highlight the incorrect character, and then press .

Enter the new character.

5. Press [OK].
6. Press .





Related Information

- [Set up Groups for Broadcasting](#)
- [Enter Text on Your Brother Machine](#)

Delete a Group

Related Models: MFC-J985DW

1. Press  [Fax] > [Address Book] > [Edit] > [Delete].
2. Press ▲ or ▼ to display the Group you want to delete, and then press it.
3. Press [OK].
4. When the touchscreen displays [Erase this data?], press [Yes].
5. Press .





Related Information

- [Set up Groups for Broadcasting](#)

Add or Delete Group Members

Related Models: MFC-J985DW

1. Press  [Fax] > [Address Book] > [Edit] > [Change].
2. Press ▲ or ▼ to display the Group you want to change, and then press it.
3. Press ▲ or ▼ to display [Add/Delete], and then press it.
4. Press ▲ or ▼ to display the number you want to add or delete.
5. Do the following for each number you want to change:
 - To add a number to the Group, press the check box of the number to add a check mark.
 - To delete a number from the Group, press the check box of the number to remove the check mark.
6. Press [OK].
7. Press [OK].
8. Press .



Related Information

- [Set up Groups for Broadcasting](#)

Telephone Services and External Devices

- [Use BT Call Sign](#)
- [Caller ID](#)
- [Set the Telephone Line Type](#)
- [Voice Over Internet Protocol \(VoIP/Telephone Line Interference\)](#)
- [External TAD \(Telephone Answering Device\)](#)
- [External and Extension Telephones](#)

Use BT Call Sign

Related Models: MFC-J985DW

This feature of the machine lets you use the BT Call Sign subscriber service which allows you to have at least two separate telephone numbers on one telephone line. Each telephone number has its own distinctive ringing pattern, so you know which telephone number is ringing. This is one way you can have a separate telephone number for your machine.

Your machine has a BT Call Sign compatible distinctive ringing function, allowing you to dedicate a second telephone number (on the same telephone line) just for receiving faxes.



- This feature is available only in the U.K.
- You can switch BT Call Sign Off temporarily, then turn it back on. When you get a new fax number, make sure you reset this function. This machine will automatically answer incoming calls that use your new fax number.
- When you set the BT Call Sign feature to On, the receive mode is set to [Manual] automatically. [Manual] mode will not respond to incoming telephone calls, since the number you use for telephone calls will use the normal ring pattern.





Related Information

- [Telephone Services and External Devices](#)
- [Enable the Machine to Work with BT Call Sign \(with Your External Telephone only\)](#)

Enable the Machine to Work with BT Call Sign (with Your External Telephone only)

Related Models: MFC-J985DW

This feature is available only in the U.K.

1. Press  [Settings] > [All Settings] > [Fax] > [Miscellaneous] > [BT Call Sign].
2. Press [On] (or [Off]).
3. Press .

When you turn off BT Call Sign, the receive mode stays in [Manual]. You must set the receive mode again.

Related Information

- [Use BT Call Sign](#)
- [Choose the Correct Receive Mode](#)
- [Error and Maintenance Messages](#)

Caller ID

Related Models: MFC-J985DW

The Caller ID feature lets you use the Caller ID subscriber service offered by many local telephone companies. This service displays the telephone number, or name if it is available, of your caller as the line rings.

- The [ID Unknown] message means the call originated outside your Caller ID service area.
- The [ID Withheld] message means the caller has intentionally blocked transmission of Caller ID information.

Call your telephone company for more information.

Once you answer a call, the Caller ID information disappears from the LCD and is stored in Caller ID memory.

View the list or select a number and fax to it, add it to the Address Book, or delete it from the history.

You can print a list of the Caller ID information received by your machine.



- This feature is not available in some countries.
- The Caller ID service varies with different carriers. Contact your local telephone company to learn about the service available in your area.



Related Information



- [Telephone Services and External Devices](#)
- [Set Caller ID to On](#)
- [Store Address Book Numbers from Caller ID History](#)
- [Print a Report](#)
- [Error and Maintenance Messages](#)

Set Caller ID to On

Related Models: MFC-J985DW

This feature is available only in the U.K. and Ireland.

If you subscribe to the Caller ID service on your phone line, set Caller ID to On to display the caller's telephone number on the LCD as the telephone rings.

1. Press  [Settings] > [All Settings] > [Fax] > [Miscellaneous] > [Caller ID].
2. Press [On].
3. Press .



Related Information

- [Caller ID](#)

Set the Telephone Line Type

Related Models: MFC-J985DW

If you are connecting the machine to a line that features PBX or ISDN to send and receive faxes, you must select a Telephone Line Type that matches your line's features.

1. Press  [Settings] > [All Settings] > [Initial Setup] > [Phone Line Set].
2. Press [Normal], [PBX], or [ISDN].
3. Press .

Related Information

- [Telephone Services and External Devices](#)
- [PBX and TRANSFER](#)
- [Telephone and Fax problems](#)

PBX and TRANSFER

Related Models: MFC-J985DW

The machine's [Phone Line Set] default setting is [Normal], which lets the machine connect to a standard Public Switched Telephone Network (PSTN) line. However, many offices use a central telephone system or Private Branch Exchange (PBX). Your machine can be connected to most types of PBX. The machine's recall feature supports timed break recall only (TBR). TBR will work with most PBX systems allowing you to gain access to an outside line, or transfer calls to another extension. Press [R] or the **Tel/R** button to use this feature.



Program a press of the [R] button (or the **Tel/R** button) as part of a number stored in the Address Book. When programming the Address Book number, press [R] (or the **Tel/R** button) first (the LCD displays '!'), then enter the telephone number. This avoids having to press [R] (or the **Tel/R** button) each time before you dial from the Address Book. However, your Telephone Line Type must be set to PBX on the machine for you to use this feature.



Related Information

- [Set the Telephone Line Type](#)

Voice Over Internet Protocol (VoIP/Telephone Line Interference)

Related Models: MFC-J985DW

VoIP is a type of phone system that uses an Internet connection instead of a traditional telephone line. Telephone providers frequently bundle VoIP together with Internet and cable services.

Your machine may not work with some VoIP systems. If you want to use your machine to send and receive faxes on a VoIP system, make sure one end of your telephone cord is connected to the socket labelled LINE on your machine. The other end of the telephone cord may be connected to a modem, phone adapter, splitter, or other such device.

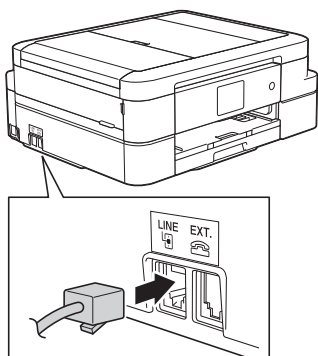

If you have questions about how to connect your machine to the VoIP system, please contact your VoIP provider.

After you have connected your machine to the VoIP system, check for a dial tone. Lift the external telephone's handset and listen for a dial tone. If there is no dial tone, please contact your VoIP provider.

If you are having problems sending or receiving faxes over a VoIP system, we recommend changing the machine's modem speed to the [Basic (for VoIP)] setting.



Related Information

- [Telephone Services and External Devices](#)
- [Telephone Line Interference/VoIP](#)

External TAD (Telephone Answering Device)

Related Models: MFC-J985DW

You can connect an external Telephone Answering Device (TAD) to the same line as your machine. When the TAD answers a call, your machine will “listen” for the CNG (fax calling) tones sent by a sending fax machine. If it hears them it will take over the call and receive the fax. If it does not hear them, it will let your TAD take a voice message and the LCD will show [Telephone].

The external TAD must answer within four rings (we recommend setting it to two rings). This is because your machine cannot hear the CNG tones until the external TAD has picked up the call. The sending machine will send CNG tones for only eight to ten seconds longer. We do not recommend using the toll saver feature on your external TAD if it needs more than four rings to activate it.

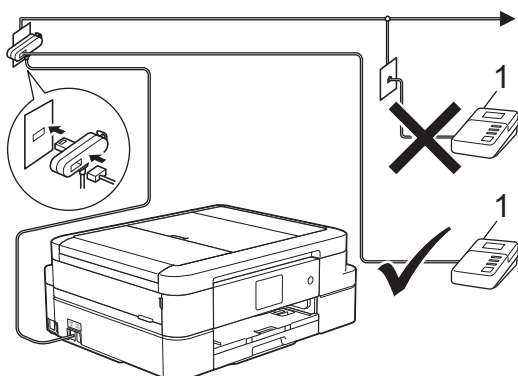

1 TAD

IMPORTANT

DO NOT connect a TAD elsewhere on the same telephone line.



If you have problems receiving faxes, reduce the Ring Delay setting on your external TAD.



Related Information

- [Telephone Services and External Devices](#)
- [Connect an External TAD](#)
- [Record an Outgoing Message \(OGM\) on the External TAD](#)
- [Multi-line Connections \(PBX\)](#)
- [Telephone and Fax problems](#)

Connect an External TAD

Related Models: MFC-J985DW

1. Set your external TAD to one or two rings.
The machine's Ring Delay setting does not apply.
2. Record the outgoing message on your external TAD.
3. Set the TAD to answer calls.
4. Set the Receive Mode on your machine to [External TAD].



Related Information

- [External TAD \(Telephone Answering Device\)](#)
- [Receive Modes](#)
- [Choose the Correct Receive Mode](#)
- [Telephone and Fax problems](#)

Record an Outgoing Message (OGM) on the External TAD

Related Models: MFC-J985DW

1. Record five seconds of silence at the beginning of your message. This allows your machine time to listen for fax tones.



We recommend beginning your OGM with an initial five second silence because the machine cannot hear fax tones over a loud voice. You may try leaving out this pause, but if your machine has trouble receiving faxes, then you should re-record the OGM to include it.

2. Limit your speaking to 20 seconds.



Related Information

- [External TAD \(Telephone Answering Device\)](#)

Multi-line Connections (PBX)

Related Models: MFC-J985DW

We suggest you ask the company that installed your PBX to connect your machine. If you have a multi line system we suggest you ask the installer to connect the unit to the last line on the system. This prevents the machine being activated each time the system receives telephone calls. If all incoming calls will be answered by a switchboard operator we recommend setting the Receive Mode to [Manual].

We cannot guarantee that your machine will operate correctly under all circumstances when connected to a PBX. Any difficulties with sending or receiving faxes should be reported first to the company that handles your PBX.



Related Information

- [External TAD \(Telephone Answering Device\)](#)

External and Extension Telephones

- [Connect an External or Extension Telephone](#)
- [Operation from External and Extension Telephones](#)
- [Use Extension Telephones](#)
- [Use the Remote Codes](#)

Connect an External or Extension Telephone

Related Models: MFC-J985DW

You can connect a separate telephone to your machine as shown in the diagram below.

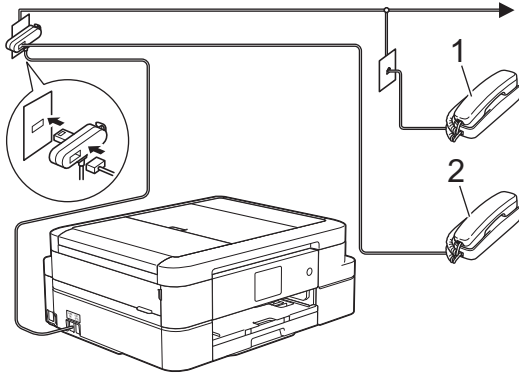

- 1 Extension telephone
- 2 External telephone



Please make sure you use an external telephone with a cable no more than three metres long.



Related Information

- [External and Extension Telephones](#)

Operation from External and Extension Telephones

Related Models: MFC-J985DW

If you answer a fax call at an extension or an external telephone, you can make your machine take the call by using the Remote Activation Code. When you press the Remote Activation Code ***51**, the machine starts to receive the fax.

If the machine answers a voice call and pseudo/double-rings for you to take over, you can take the call at an extension telephone by pressing the Remote Deactivation Code **#51**.

If you answer a call and no one is on the line:

You should assume that you're receiving a manual fax.

Press ***51** and wait for the chirp or until the LCD shows [Receiving], and then hang up.



You can also use the Fax Detect feature to make your machine automatically take the call.



Related Information

- [External and Extension Telephones](#)
- [Set the Number of Rings Before the Machine Answers \(Ring Delay\)](#)
- [Set Fax Detect](#)
- [Set a Remote Access Code](#)
- [Set the F/T Ring Time \(Pseudo/Double-ring\)](#)

Use Extension Telephones

Related Models: MFC-J985DW

Your premises may already be wired with parallel extension telephones, or you may plan to add extension telephones to your line, as well as your machine. While the simplest arrangement is a straightforward parallel connection, there are some problems with this. The most obvious is inadvertent interruption of a fax transmission caused by someone picking up an extension telephone to make an outgoing call. Also, the remote activation code feature may not operate reliably in such a simple configuration.

This machine also may be set to make a delayed transmission (i.e. a transmission at a pre-set time). This pre-set job may coincide with someone picking up an extension handset.

These problems can easily be eliminated, if you arrange modification of your extension wiring circuit, such that extension devices are connected “downstream” of your machine in a master/slave configuration (see fig. 2). In this configuration the machine can always detect whether a telephone is in use. Thus it will not attempt to seize the line during that time. This is known as “telephone off-hook detection.”

The inadvisable configuration is shown in figure 1, and the recommended master/slave configuration is shown in figure 2.

This new connection configuration can be arranged by contacting BT, Kingston upon Hull Telecommunications, your PBX maintainer or a qualified telephone installation company as appropriate. Simply explained, the extension telephone circuit should be terminated on a normal modular plug (BT 431A style), which in turn should be put into the modular socket of the white “T”-shaped connector provided as part of the line cord assembly.

Inadvisable connection of extension sockets (Fig. 1.)

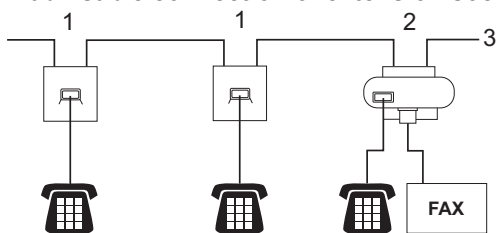

1. Extension socket
2. Master socket
3. Incoming line

Recommended connection of extension sockets (Fig. 2.)

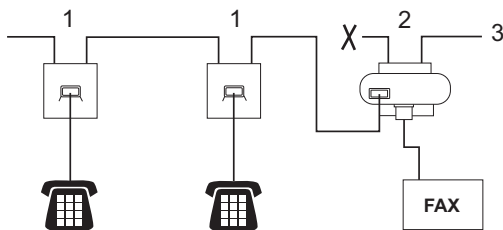

1. Extension socket
2. Master socket
3. Incoming line

The fax machine must be plugged into the master socket.



These telephones are now connected as external devices, because they are connected to the fax machine via the T-connector.



Related Information

- [External and Extension Telephones](#)

Use the Remote Codes

Related Models: MFC-J985DW

Remote Activation Code

If you answer a fax call on an extension or external telephone, you can tell your machine to receive it by pressing the Remote Activation Code ***51**. Wait for the chirping sounds then replace the handset.

If you answer a fax call at the external telephone, you can make the machine receive the fax by pressing the Start button and then selecting the option to receive.

Remote Deactivation Code

If you receive a voice call and the machine is in F/T mode, it will start to sound the F/T ring (pseudo/double-ring) after the initial Ring Delay. If you pick up the call on an extension telephone you can turn the F/T ring off by pressing **#51** (make sure you press this between the rings).

If the machine answers a voice call and pseudo/double-rings for you to take over, you can take the call at the external telephone by pressing [Pickup] or by pressing **Tel/R**.





Related Information

- [External and Extension Telephones](#)
- [Change the Remote Codes](#)
- [Set a Remote Access Code](#)
- [Set Fax Detect](#)

Change the Remote Codes

Related Models: MFC-J985DW

The preset Remote Activation Code is ***51**. The preset Remote Deactivation Code is **#51**. If you are always disconnected when accessing your External TAD remotely, try changing the three-digit remote codes using the numbers 0-9, *, #.

1. Press  [Settings] > [All Settings] > [Fax] > [Setup Receive] > [Remote Codes].
2. Do one of the following:
 - To change the Remote Activation Code, press [Act. Code]. Enter the new code, and then press [OK].
 - To change the Remote Deactivation Code, press [Deact. Code]. Enter the new code, and then press [OK].
 - If you do not want to change the Codes, go to the next step.
 - To turn the Remote Codes [Off] (or [On]), press [Remote Codes]. Press [Off] (or [On]).
3. Press .



Related Information

- [Use the Remote Codes](#)

Fax Reports

- [Set the Transmission Verification Report's Style](#)
- [Set the Fax Journal's Interval Period](#)
- [Print Reports](#)
- [Set the Machine to Power Off Automatically](#)

Set the Transmission Verification Report's Style

Related Models: MFC-J985DW

You can use the Transmission Verification Report as proof that you sent a fax. This report lists the receiving party's name or fax number, the time and date of transmission, duration of transmission, number of pages sent, and whether or not the transmission was successful.

There are several settings available for the Transmission Verification Report:

Option	Description
On	Prints a report after every fax you send.
On+Image	Prints a report after every fax you send. A portion of the fax's first page appears on the report.
Off	Prints a report if your fax is unsuccessful due to a transmission error.
Off+Image	Prints a report if your fax is unsuccessful due to a transmission error. A portion of the fax's first page appears on the report.

1. Press  [Settings] > [All Settings] > [Fax] > [Report Setting] > [XMIT Report].

2. Press the option you want.

If you select [On+Image] or [Off+Image], the image will not appear on the Transmission Verification Report if Real Time Transmission is set to [On]. The image will not appear on the report when you send a colour fax.

3. Press .

If the transmission is successful, [OK] appears next to [RESULT] on the Transmission Verification Report. If the transmission is not successful, [ERROR] appears next to [RESULT].



Related Information

- [Fax Reports](#)

Set the Fax Journal's Interval Period

Related Models: MFC-J985DW

You can set the machine to print a Fax Journal at specific intervals (every 50 faxes, 6, 12 or 24 hours, 2 or 7 days).

1. Press  [Settings] > [All Settings] > [Fax] > [Report Setting] > [Journal Period].
2. Press [Journal Period].
3. Press ▲ or ▼ to select an interval.
 - 6, 12, 24 hours, 2 or 7 days
The machine will print the report at the selected interval and then erase all fax jobs from the Journal's memory. If the memory becomes full with 200 jobs before the time you selected has passed, the machine will print the Journal early and then erase all fax jobs from the memory. If you want an extra report before it is due to print, you can print it without erasing the jobs.
 - Every 50 Faxes
The machine will print the Journal when the machine has stored 50 fax jobs.
4. If you selected 6, 12, 24 hours, 2 or 7 days, press [Time] and enter the time of day using the touchscreen. Press [OK].
5. If you selected [Every 7 Days], press [Day]. Press ▲ or ▼ to display the [Every Monday], [Every Tuesday], [Every Wednesday], [Every Thursday], [Every Friday], [Every Saturday] or [Every Sunday] option, and then press the first day of the seven-day countdown.
6. Press .



Related Information

- [Fax Reports](#)
- [Set the Machine to Power Off Automatically](#)

PC-FAX

- [PC-FAX for Windows®](#)
- [PC-FAX for Mac](#)

PC-FAX for Windows®

- [PC-FAX Overview \(Windows®\)](#)
- [Send a Fax Using PC-FAX \(Windows®\)](#)
- [Receive Faxes on Your Computer \(Windows®\)](#)

PC-FAX Overview (Windows®)

Reduce paper consumption and save time by using Brother's PC-FAX software to send faxes directly from your machine.



- [Configure PC-FAX \(Windows®\)](#)
- [Configure your PC-Fax Address Book \(Windows®\)](#)

Configure PC-FAX (Windows®)

Related Models: MFC-J985DW

Before sending faxes using PC-FAX, personalise the send options in each tab of the **PC-FAX Setup** dialog box.

1. Do one of the following:

- Windows® XP, Windows Vista® and Windows® 7

Click  (**Start**) > **All Programs** > **Brother** > **Brother Utilities**.

Click the drop-down list and select your model name (if not already selected). Click **PC-FAX** in the left navigation bar, and then click **Setup Sending**.

- Windows® 8 and Windows® 10

Launch  (**Brother Utilities**), and then click the drop-down list and select your model name (if not already selected). Click **PC-FAX** in the left navigation bar, and then click **Setup Sending**.

The **PC-FAX Setup** dialog box appears.

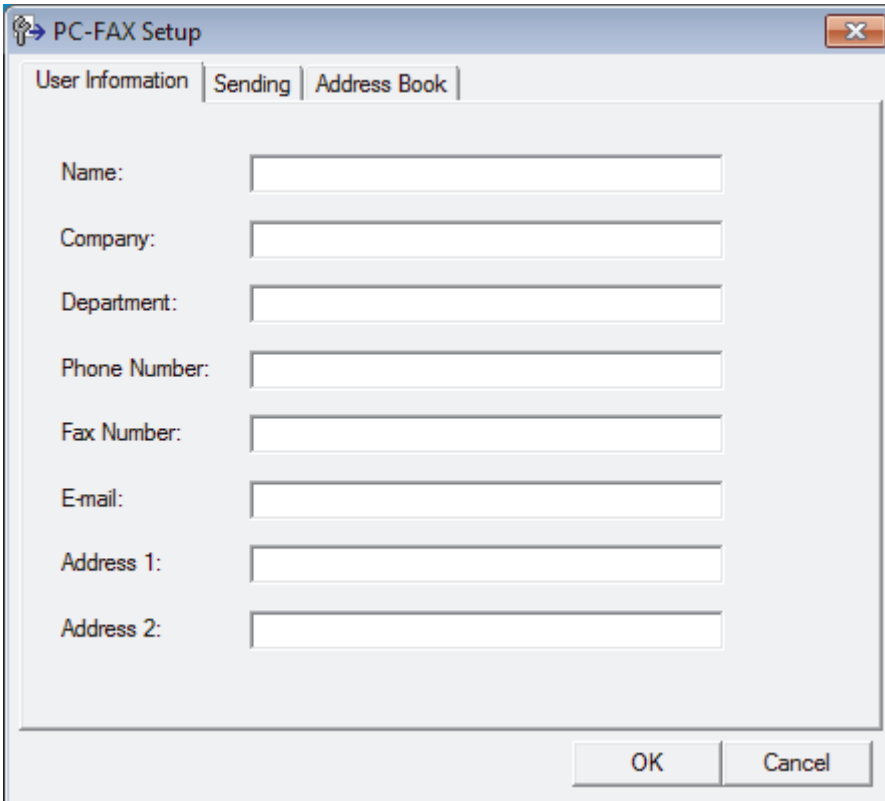

The screenshot shows the 'PC-FAX Setup' dialog box with the 'User Information' tab selected. The dialog box contains the following fields:

- Name:
- Company:
- Department:
- Phone Number:
- Fax Number:
- E-mail:
- Address 1:
- Address 2:

At the bottom right, there are 'OK' and 'Cancel' buttons.

2. Do one of the following:

- Click the **User Information** tab, and then type your user information in the fields.



Each Microsoft® account can have its own customised **User Information** screen for custom fax headers and cover pages.

- Click the **Sending** tab, and then type the number needed to access an outside line (if needed) in the **Outside line access** field. Select the **Include header** check box to include the header information.
- Click the **Address Book** tab, and then select the address book you want to use for PC-FAX from the **Select Address Book** drop-down list.

3. Click **OK**.



Related Information

- [PC-FAX Overview \(Windows®\)](#)

Configure your PC-Fax Address Book (Windows®)

Add, edit and delete members and groups to personalise your Brother **Address Book**.

- [Add a Member to the Address Book \(Windows®\)](#)
- [Create a Group in the Address Book \(Windows®\)](#)
- [Edit Member or Group Information \(Windows®\)](#)
- [Delete a Member or Group \(Windows®\)](#)
- [Export the Address Book \(Windows®\)](#)
- [Import Information to the Address Book \(Windows®\)](#)

Add a Member to the Address Book (Windows®)

Related Models: MFC-J985DW

Add new people and their fax information to the PC-Fax Address Book if you want to send a fax using Brother PC-Fax software.

1. Do one of the following:

- Windows® XP, Windows Vista® and Windows® 7

Click  (**Start**) > **All Programs** > **Brother** > **Brother Utilities**.

Click the drop-down list and select your model name (if not already selected). Click **PC-FAX** in the left navigation bar, and then click **Address Book (Send)**.

- Windows® 8 and Windows® 10

Launch  (**Brother Utilities**), and then click the drop-down list and select your model name (if not already selected). Click **PC-FAX** in the left navigation bar, and then click **Address Book (Send)**.

The **Address Book** dialog box appears.

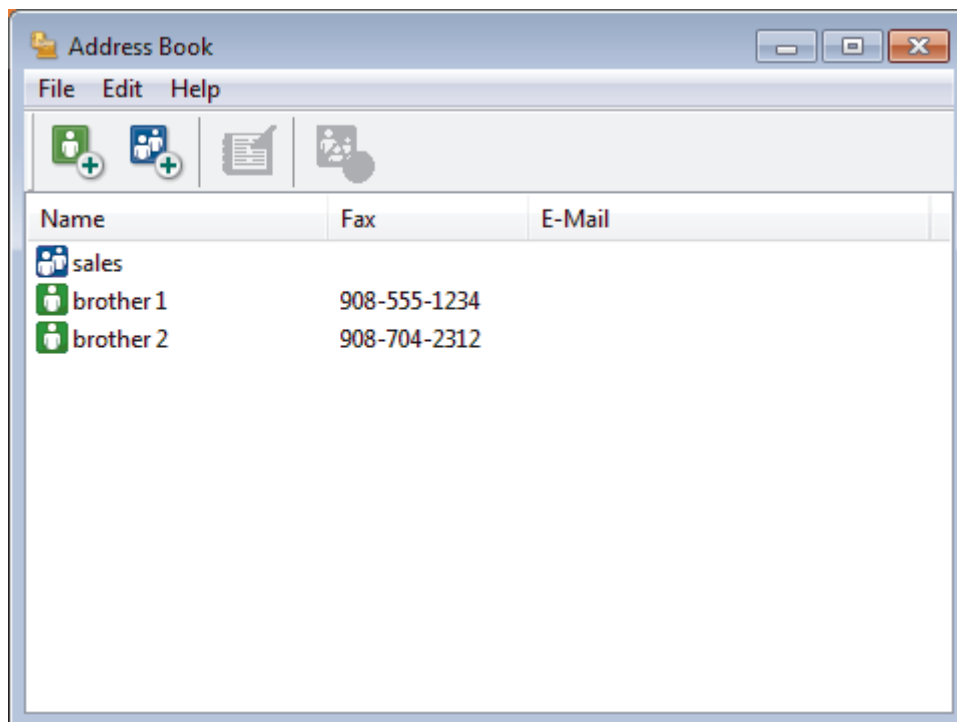

2. Click .

The **Address Book Member Setup** dialog box appears.

The screenshot shows a 'Address Book Member Setup' dialog box with the following fields:

- Name: (with a person icon)
- Title:
- Company:
- Department: Job Title:
- Street Address:
- City: State/Province:
- Zip Code/Post Code: Country/Region:
- Business Phone: Home Phone:
- Fax: Mobile Phone:
- E-Mail:

Buttons: OK, Cancel

3. Type the member's information in the corresponding fields. Only the **Name** field is required.
4. Click **OK**.



Related Information

- [Configure your PC-Fax Address Book \(Windows®\)](#)

Create a Group in the Address Book (Windows®)

Related Models: MFC-J985DW

Create a group to broadcast the same PC-FAX to several recipients at one time.

1. Do one of the following:

- Windows® XP, Windows Vista® and Windows® 7

Click  (**Start**) > **All Programs** > **Brother** > **Brother Utilities**.

Click the drop-down list and select your model name (if not already selected). Click **PC-FAX** in the left navigation bar, and then click **Address Book (Send)**.

- Windows® 8 and Windows® 10

Launch  (**Brother Utilities**), and then click the drop-down list and select your model name (if not already selected). Click **PC-FAX** in the left navigation bar, and then click **Address Book (Send)**.

The **Address Book** dialog box appears.

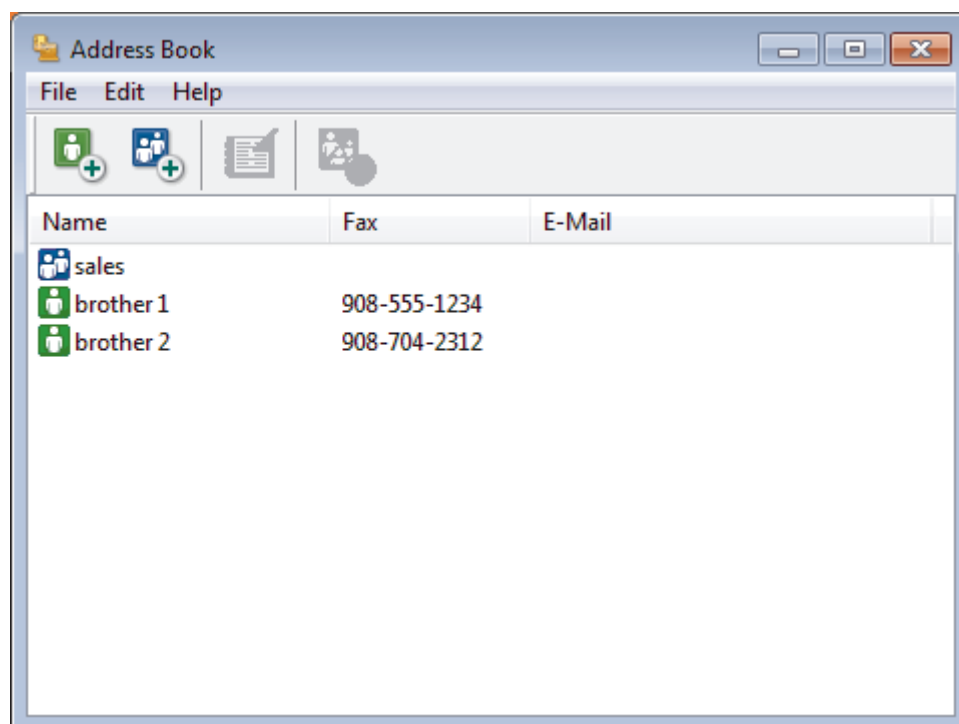

2. Click .

The **Address Book Group Setup** dialog box appears.

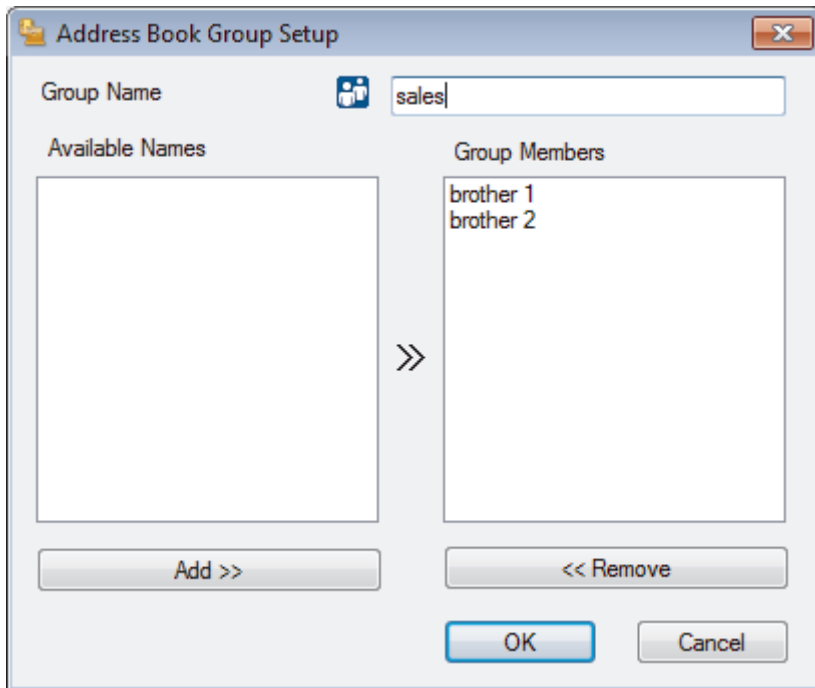

3. Type the name of the new group in the **Group Name** field.
4. In the **Available Names** field, select each name you want to include in the group, and then click **Add >>**.
Members added to the group appear in the **Group Members** box.
5. When finished, click **OK**.



Each group can contain up to 50 members.



Related Information

- [Configure your PC-Fax Address Book \(Windows®\)](#)

Edit Member or Group Information (Windows®)

Related Models: MFC-J985DW

1. Do one of the following:

- Windows® XP, Windows Vista® and Windows® 7

Click  (**Start**) > **All Programs** > **Brother** > **Brother Utilities**.

Click the drop-down list and select your model name (if not already selected). Click **PC-FAX** in the left navigation bar, and then click **Address Book (Send)**.

- Windows® 8 and Windows® 10

Launch  (**Brother Utilities**), and then click the drop-down list and select your model name (if not already selected). Click **PC-FAX** in the left navigation bar, and then click **Address Book (Send)**.

The **Address Book** dialog box appears.

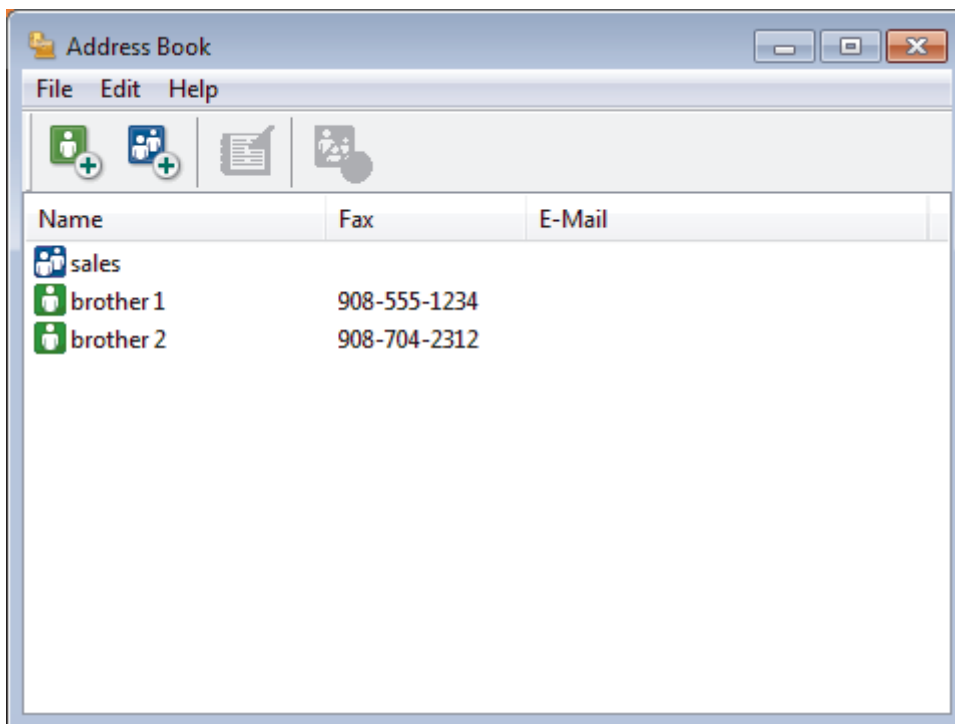

- Select the member or group you want to edit.
- Click  (**Properties**).
- Change the member or group information.
- Click **OK**.

Related Information

- [Configure your PC-Fax Address Book \(Windows®\)](#)

Delete a Member or Group (Windows®)

Related Models: MFC-J985DW

1. Do one of the following:

- Windows® XP, Windows Vista® and Windows® 7

Click  (**Start**) > **All Programs** > **Brother** > **Brother Utilities**.

Click the drop-down list and select your model name (if not already selected). Click **PC-FAX** in the left navigation bar, and then click **Address Book (Send)**.

- Windows® 8 and Windows® 10

Launch  (**Brother Utilities**), and then click the drop-down list and select your model name (if not already selected). Click **PC-FAX** in the left navigation bar, and then click **Address Book (Send)**.

The **Address Book** dialog box appears.

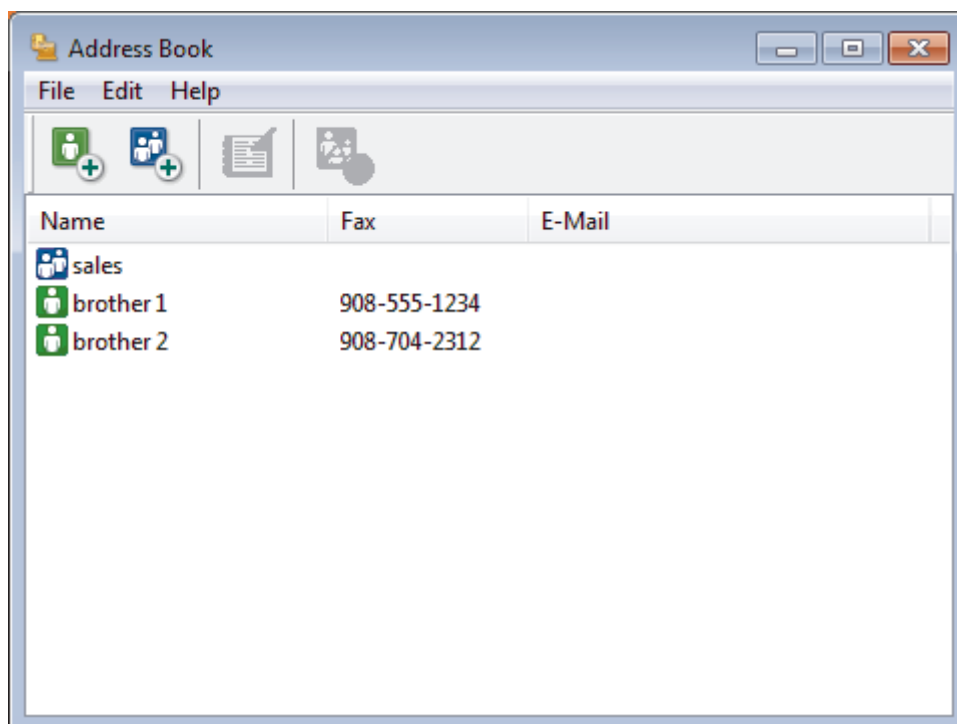

2. Select the member or group you want to delete.

3. Click  (**Delete**).

4. When the confirmation dialog box appears, click **OK**.

Related Information

- [Configure your PC-Fax Address Book \(Windows®\)](#)

Export the Address Book (Windows®)

Related Models: MFC-J985DW

You can export the Address Book as an ASCII text file (*.csv), a vCard (an electronic business card), or **Remote Setup Dial Data** and save it on your computer.

- You cannot export the group settings when you export the **Address Book** data.

1. Do one of the following:

- Windows® XP, Windows Vista® and Windows® 7

Click  (**Start**) > **All Programs** > **Brother** > **Brother Utilities**.

Click the drop-down list and select your model name (if not already selected). Click **PC-FAX** in the left navigation bar, and then click **Address Book (Send)**.

- Windows® 8 and Windows® 10

Launch  (**Brother Utilities**), and then click the drop-down list and select your model name (if not already selected). Click **PC-FAX** in the left navigation bar, and then click **Address Book (Send)**.

The **Address Book** dialog box appears.

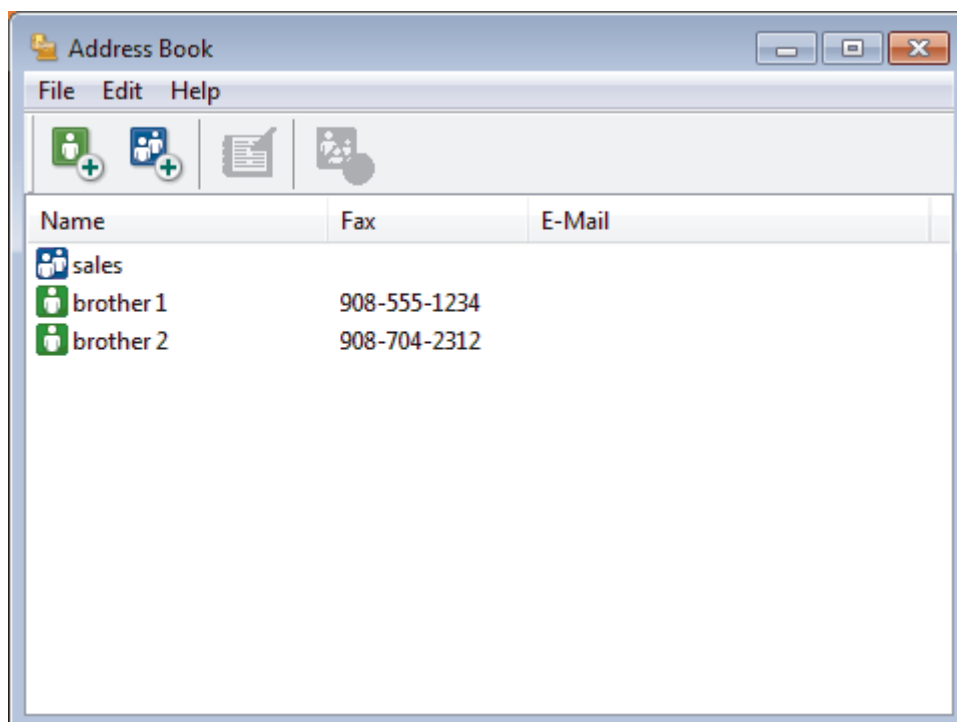

2. Click the **File** menu, and then select **Export**.

3. Select one of the following:

- Text**

The **Select Items** dialog box appears. Go to step 4.

- vCard**

You must select the member you want to export from your address book before selecting this option.

Browse to the folder where you want to save the vCard, type the vCard name in the **File name** field, and then click **Save**.

- **Remote Setup Dial Data**

Browse to the folder where you want to save the data, type the file name in the **File name** field, and then click **Save**.

4. In the **Available Items** field, select the data you want to export, and then click **Add >>**.

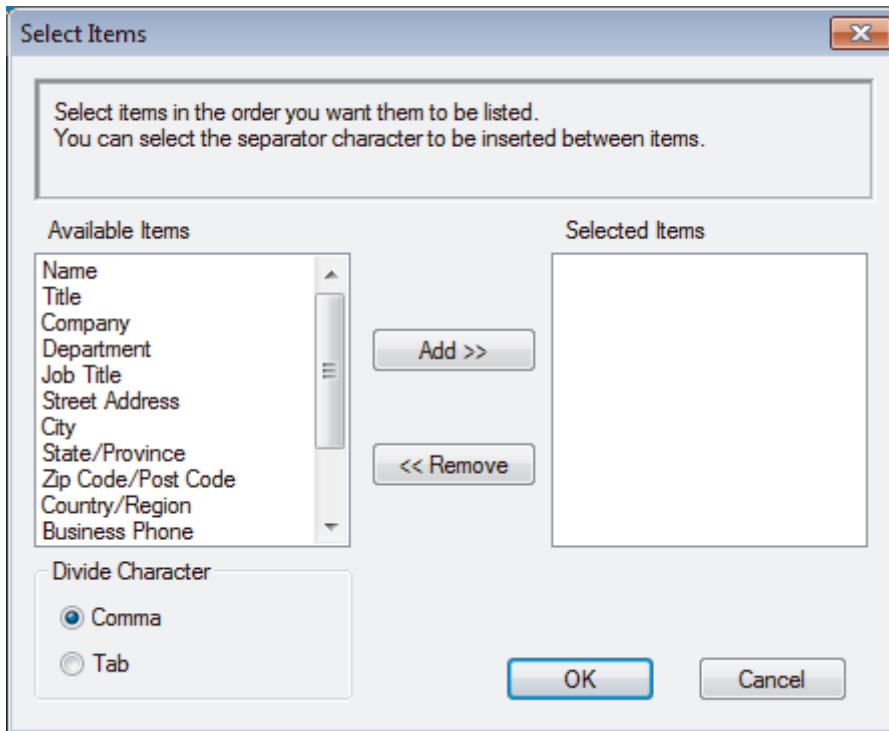

Select and add the items in the order you want them listed.

5. If you are exporting to an ASCII file, under the **Divide Character** section, select the **Tab** or **Comma** option to separate the data fields.
6. Click **OK**.
7. Browse to the folder on your computer where you want to save the data, type the file name, and then click **Save**.



Related Information

- [Configure your PC-Fax Address Book \(Windows®\)](#)

Import Information to the Address Book (Windows®)

Related Models: MFC-J985DW

You can import ASCII text files (*.csv), vCards (electronic business cards), or **Remote Setup Dial Data** into your Address Book.

1. Do one of the following:

- Windows® XP, Windows Vista® and Windows® 7

Click  (**Start**) > **All Programs** > **Brother** > **Brother Utilities**.

Click the drop-down list and select your model name (if not already selected). Click **PC-FAX** in the left navigation bar, and then click **Address Book (Send)**.

- Windows® 8 and Windows® 10

Launch  (**Brother Utilities**), and then click the drop-down list and select your model name (if not already selected). Click **PC-FAX** in the left navigation bar, and then click **Address Book (Send)**.

The **Address Book** dialog box appears.

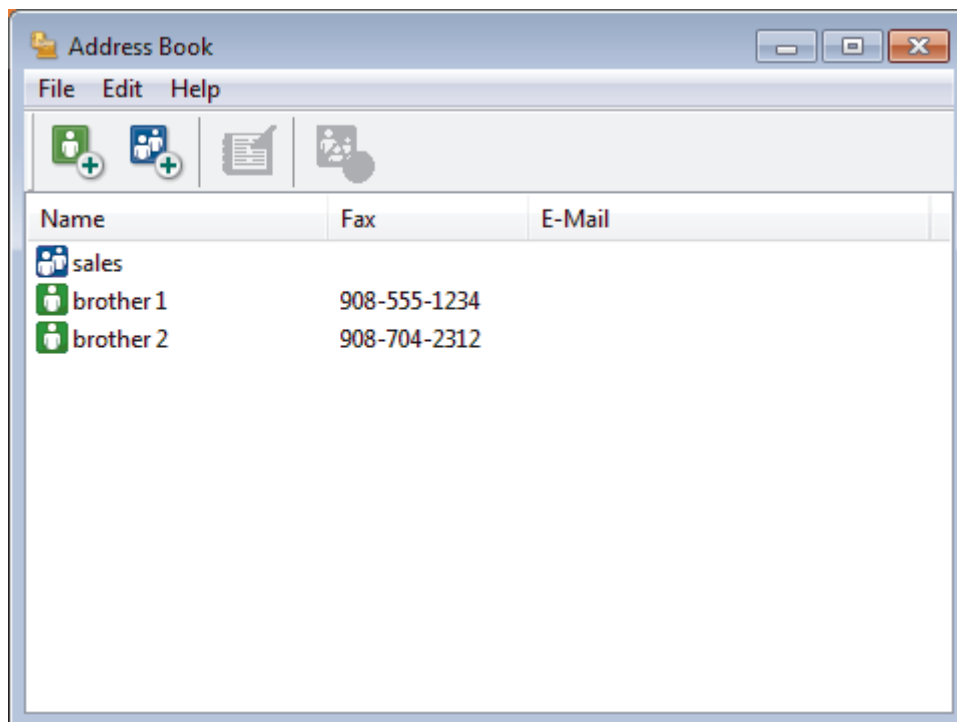

2. Click the **File** menu, and then select **Import**.

3. Select one of the following:

- Text**

The **Select Items** dialog box appears. Go to step 4.

- vCard**

Go to step 7.

- Remote Setup Dial Data**

Go to step 7.

4. In the **Available Items** field, select the data you want to import, and then click **Add >>**.

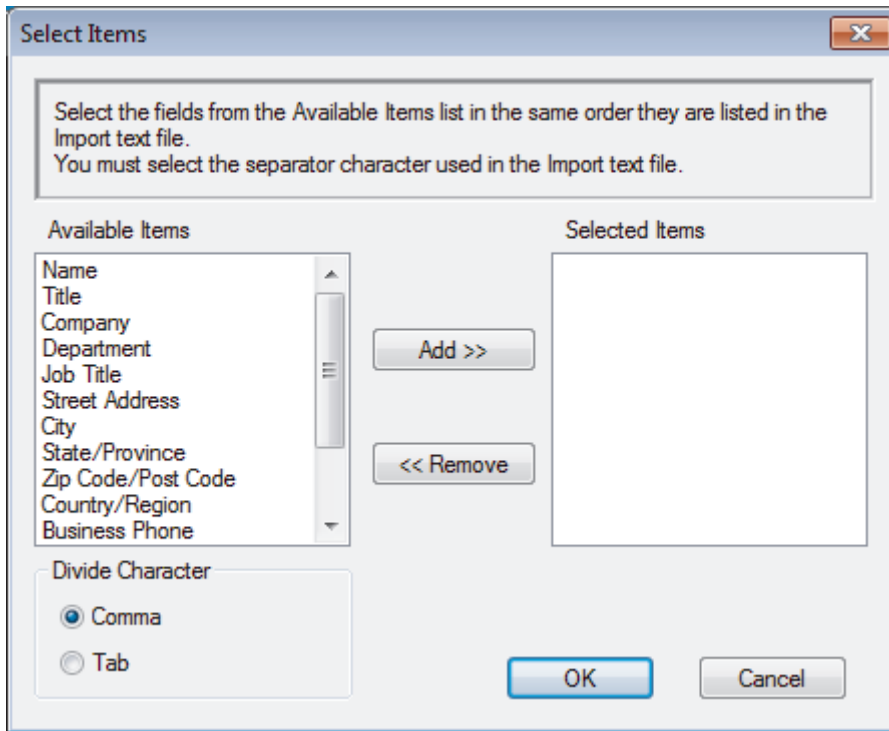

You must select and add fields from the **Available Items** list in the same order they are listed in the import text file.

5. If you are importing an ASCII file, under the **Divide Character** section, select the **Tab** or **Comma** option to separate the data fields.
6. Click **OK**.
7. Browse to the folder where you want to import the data, type the file name, and then click **Open**.

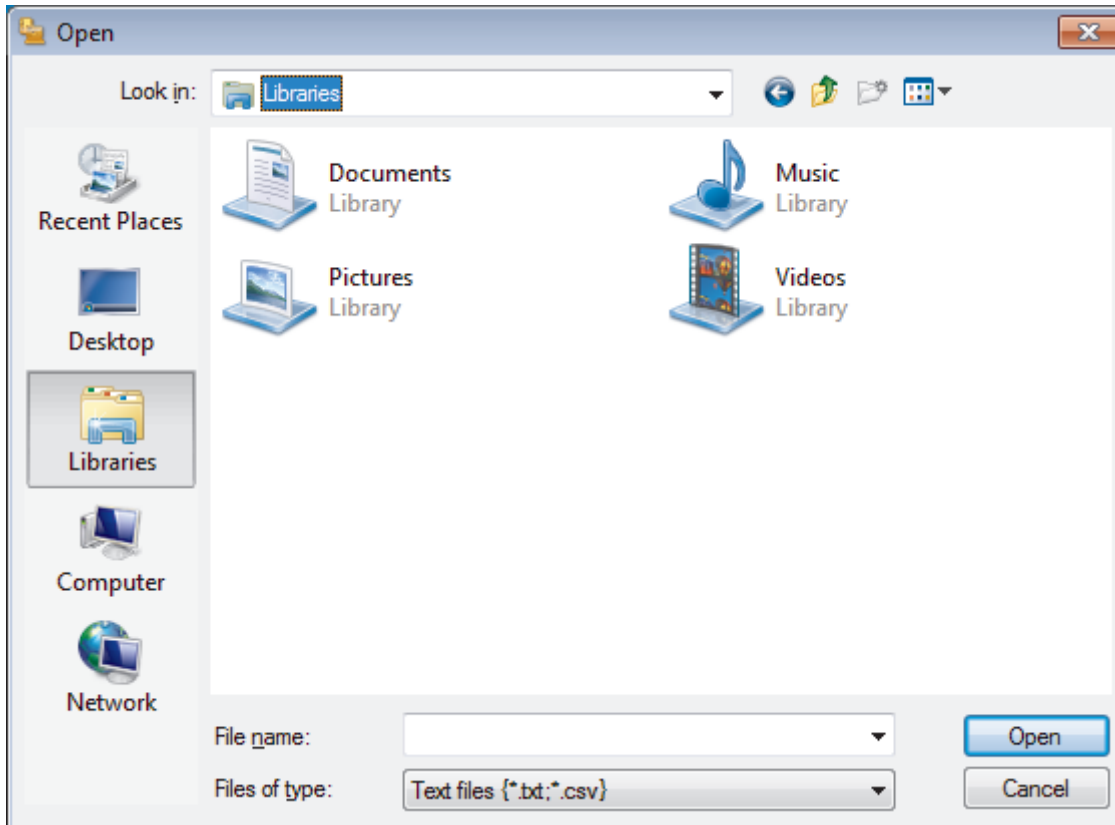

Related Information

- [Configure your PC-Fax Address Book \(Windows®\)](#)

Send a Fax Using PC-FAX (Windows®)

Related Models: MFC-J985DW

PC-FAX supports only monochrome faxes. A monochrome fax will be sent even if the original data is colour and the receiving fax machine supports colour faxes.

1. Create a file in any application on your computer.
2. Select the print command in your application.
3. Select **Brother PC-FAX** as your printer, and then complete your print operation.

The **Brother PC-FAX** dialog box appears.

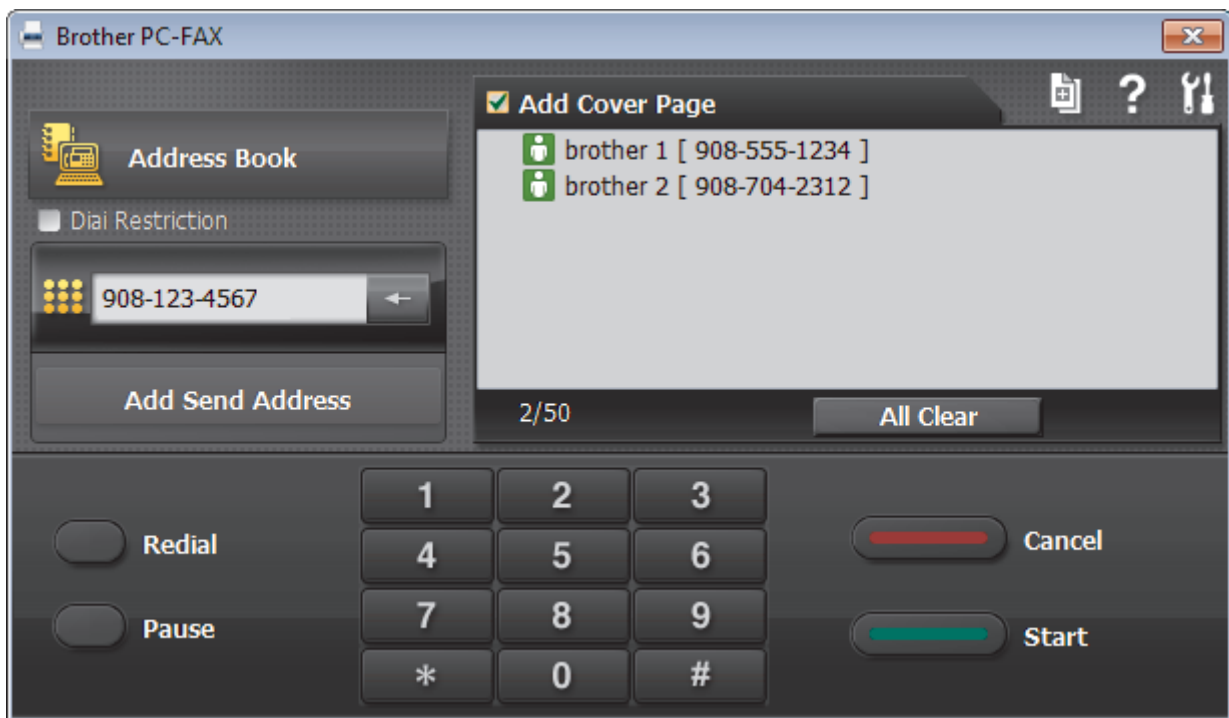

4. Type a fax number using one of the following methods:
 - Click the numbers on the dial pad to type the number, and then click **Add Send Address**.

 If you select the **Dial Restriction** check box, a confirmation dialog box will appear for you to re-type the fax number using the keyboard. This feature helps to prevent transmissions to the wrong destination.

- Click the **Address Book** button, and then select a member or group from the Address Book.

 If you make a mistake, click **All Clear** to delete all entries.

5. To include a cover page, select the **Add Cover Page** check box. You can also click  to create or edit a cover page.
6. Click **Start** to send the fax.

 To cancel the fax, click **Cancel**.

- To redial a number, click **Redial** to show the last five fax numbers, select a number, and then click **Start**.

Related Information

- [PC-FAX for Windows®](#)

Receive Faxes on Your Computer (Windows®)

Use Brother's PC-FAX software to receive faxes on your computer, screen them and print only those faxes you want.



- [Receive Faxes Using PC-FAX Receive \(Windows®\)](#)

Receive Faxes Using PC-FAX Receive (Windows®)

Related Models: MFC-J985DW

Brother's PC-FAX Receive software lets you view and store faxes on your computer. It is automatically installed when you install the Brother software and drivers and works on locally- or network-connected machines.

- PC-FAX Receive supports only monochrome faxes. When you receive a colour fax, your machine prints the colour fax at your machine but does not send the fax to your computer.

When you turn off your computer, your machine will continue to receive and store faxes in your Brother machine's memory. The machine's LCD will display the number of stored faxes received. When you start this application, the software will transfer all received faxes to your computer at once. You can enable the Backup Print option if you want the machine to print a copy of the fax before the fax is sent to your computer, or before the computer is switched off. You can configure the Backup Print settings from your Brother machine.



Related Information

- [Receive Faxes on Your Computer \(Windows®\)](#)
- [Run Brother's PC-FAX Receive on Your Computer \(Windows®\)](#)
- [View Received Messages \(Windows®\)](#)
- [Use PC-Fax Receive to Transfer Received Faxes to Your Computer \(Windows® only\)](#)

Run Brother's PC-FAX Receive on Your Computer (Windows®)

Related Models: MFC-J985DW



We recommend selecting the **Start PC-FAX Receive on computer startup** check box so that the software runs automatically and can transfer any faxes upon computer startup.

1. Do one of the following:

- Windows® XP, Windows Vista® and Windows® 7

Click  (**Start**) > **All Programs** > **Brother** > **Brother Utilities**.

Click the drop-down list and select your model name (if not already selected). Click **PC-FAX** in the left navigation bar, and then click **Receive**.

- Windows® 8 and Windows® 10

Launch  (**Brother Utilities**), and then click the drop-down list and select your model name (if not already selected). Click **PC-FAX** in the left navigation bar, and then click **Receive**.

2. Confirm the message and click **Yes**.

The **PC-FAX Receive** window appears. The  (**PC-FAX Receive**) icon also appears in your computer task tray.



Related Information

- [Receive Faxes Using PC-FAX Receive \(Windows®\)](#)
- [Set Up Your Computer for PC-FAX Receiving \(Windows®\)](#)
- [Add Your Brother Machine to PC-FAX Receiving \(Windows®\)](#)

Set Up Your Computer for PC-FAX Receiving (Windows®)

Related Models: MFC-J985DW

1. Double-click the  (**PC-FAX Receive**) icon in your computer task tray.
The **PC-FAX Receive** window appears.
2. Click **Settings**.
3. Configure these options as needed:

Preferences

Configure to start PC-FAX Receive automatically when you start Windows®.

Save

Configure the path to save PC-FAX files and select the received document format.

Device

Select the Brother machine that you want to receive PC-FAX.

Lock (available only for Administrators)

Restrict users who do not have administrator privileges from configuring the settings options shown above.

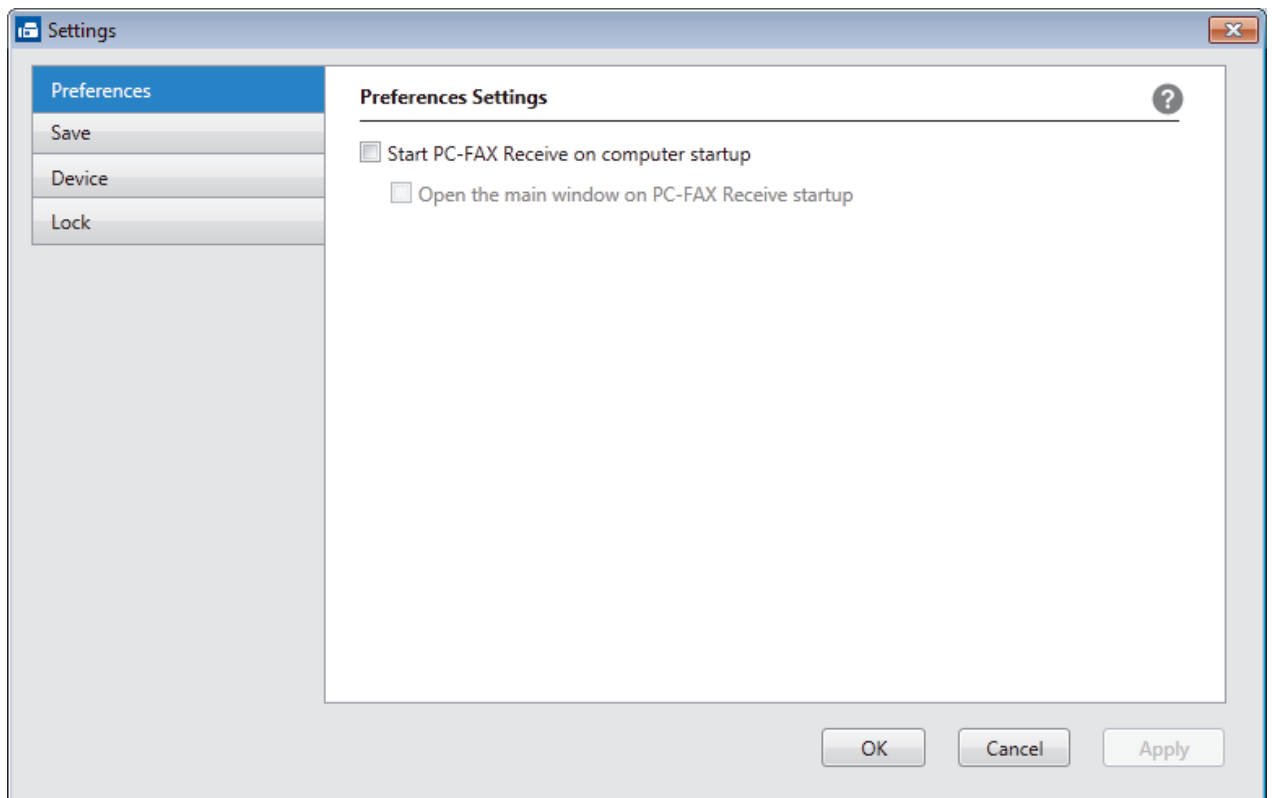

4. Click **OK**.

Related Information

- [Run Brother's PC-FAX Receive on Your Computer \(Windows®\)](#)

Add Your Brother Machine to PC-FAX Receiving (Windows®)

Related Models: MFC-J985DW

- If you installed the machine following the instructions for a network user, then the machine should already be configured for your network.

1. Double-click the  (**PC-FAX Receive**) icon in your computer task tray.

The **PC-FAX Receive** window appears.

2. Click **Settings**.
3. Click **Device** > **Add**.

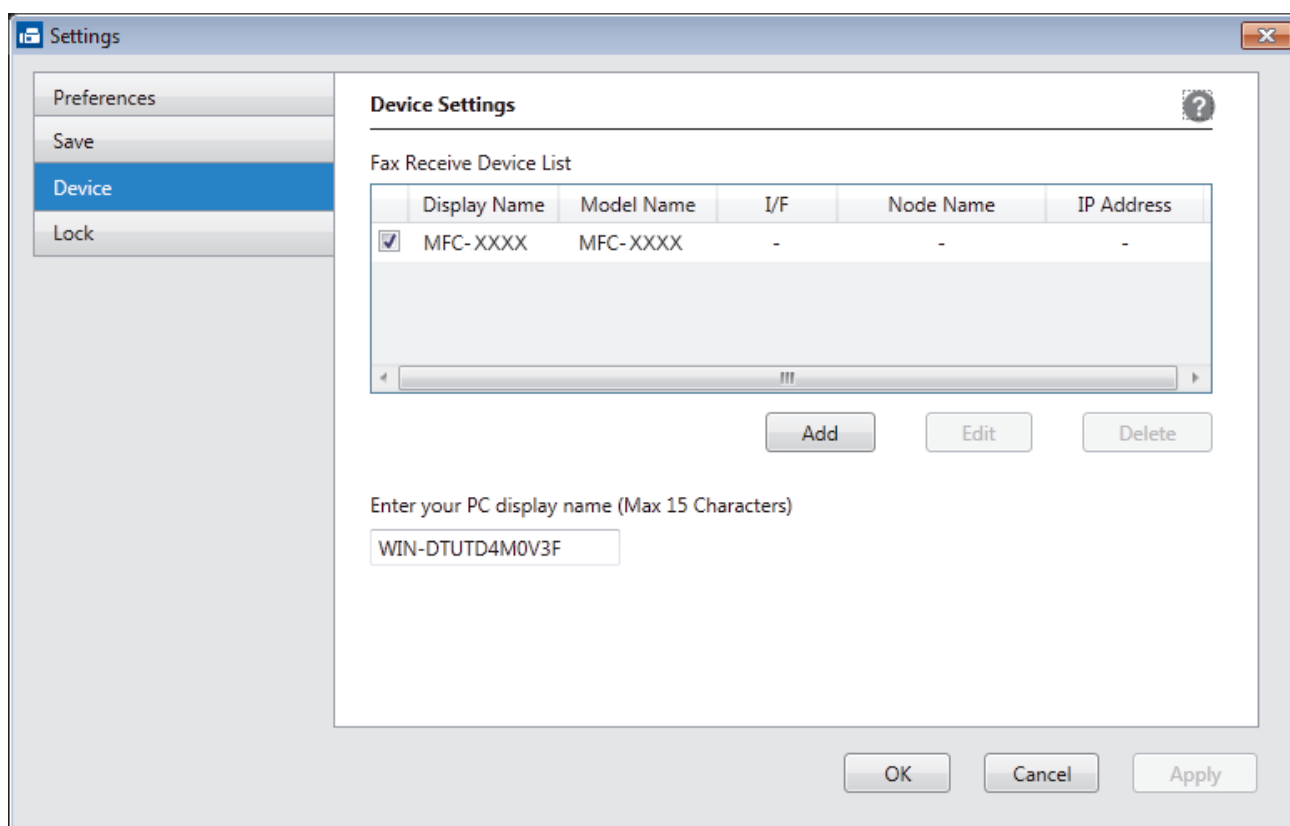

4. Select the appropriate connection method.

Select your machine from the automatic search results below.

Connected Brother machines will be displayed. Select a device from the list. Click **OK**.

Specify your machine by IP address

Type the machine's IP address in the **IP Address** field, and then click **OK**.

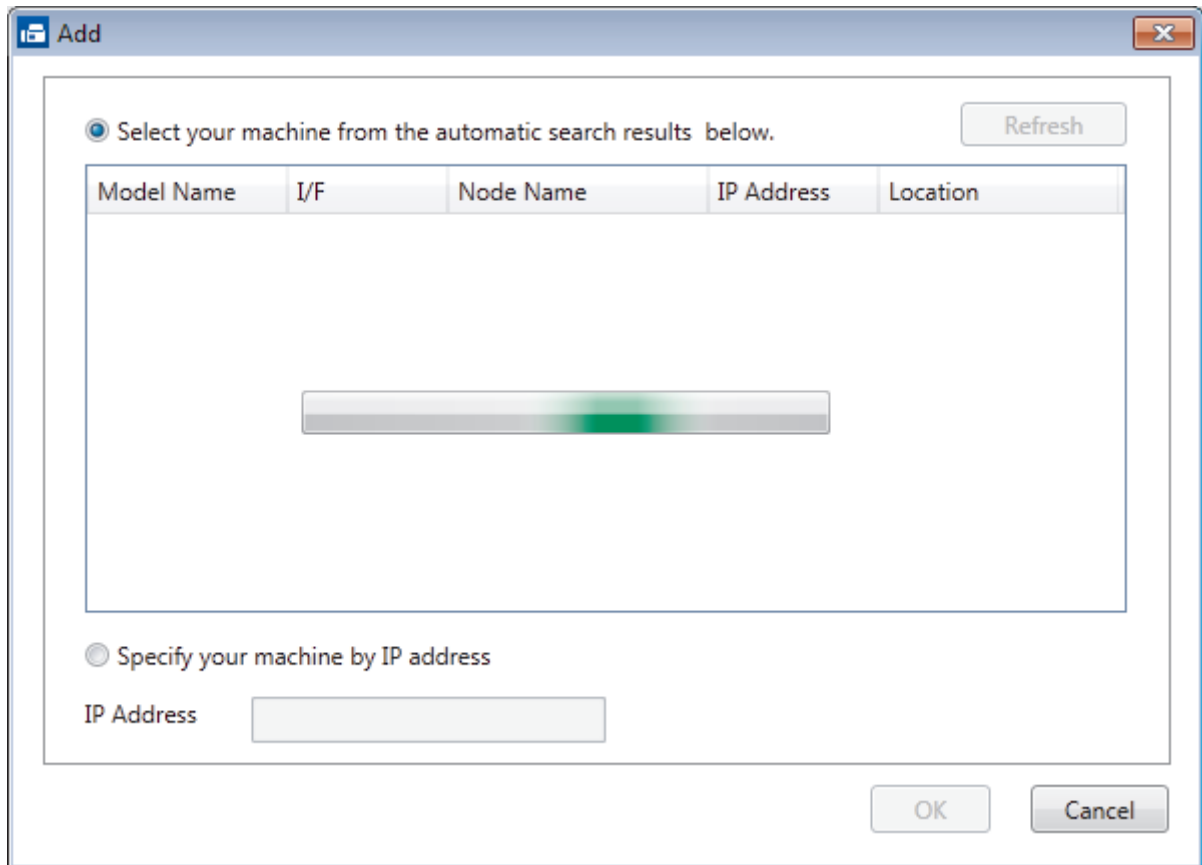

5. To change the computer name that will appear on the machine's LCD, type the new name in the **Enter your PC display name (Max 15 Characters)** field.
6. Click **OK**.



Related Information

- [Run Brother's PC-FAX Receive on Your Computer \(Windows®\)](#)

View Received Messages (Windows®)

Related Models: MFC-J985DW

Receiving Status

Icon	Indicated Status
	Standby mode No unread messages
	Receiving messages
	Messages received Unread messages

1. Double-click the  (PC-FAX Receive) icon in your computer task tray.

The PC-FAX Receive window appears.

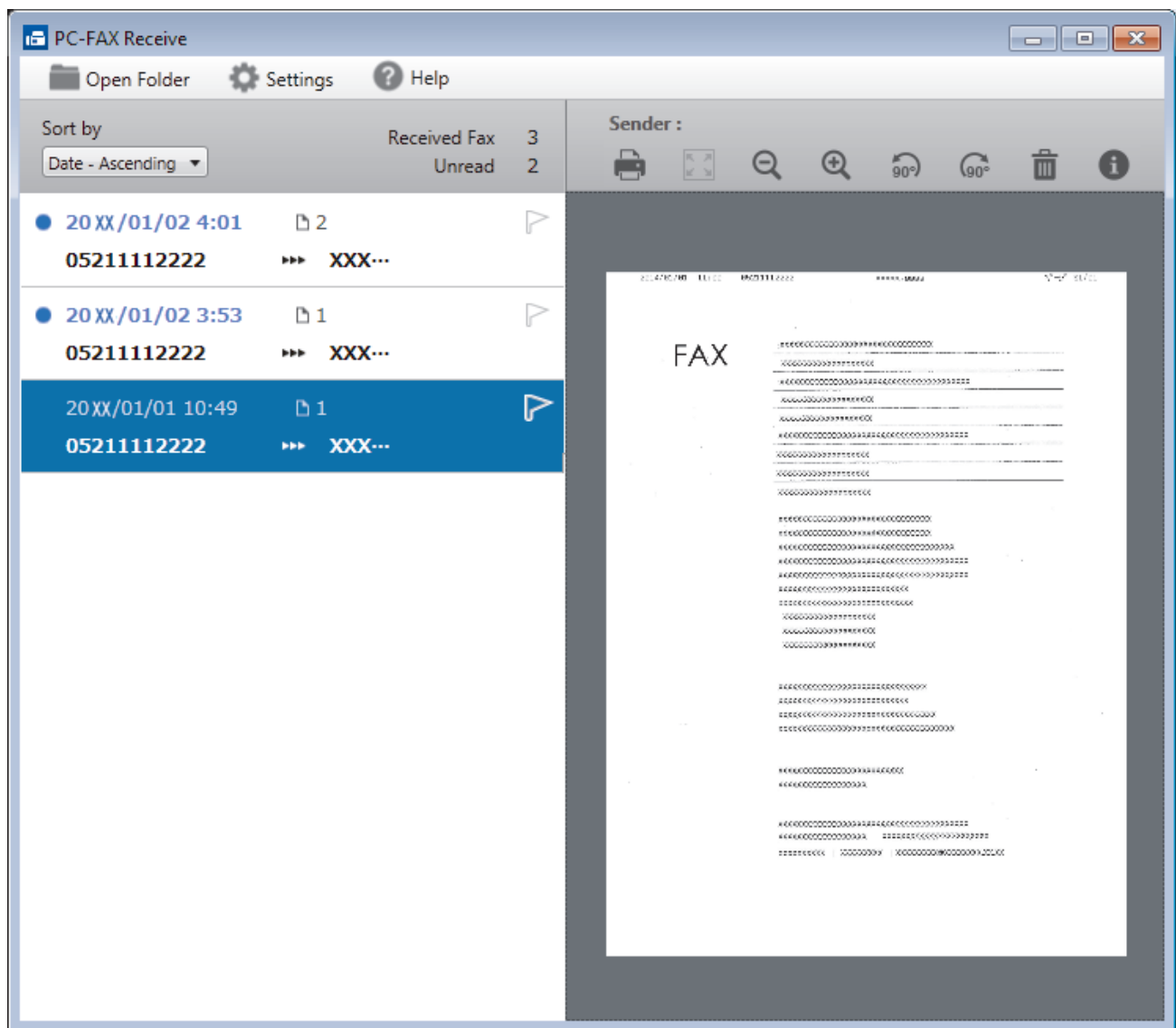

2. Click any faxes in the list to view them.
3. When finished, click  in the right top corner of the window to close it.



Even after closing the window, PC-FAX Receive is active and the  (PC-FAX Receive) icon will remain in your computer task tray. To close PC-FAX Receive, click the icon in the computer task tray and click **Close**.



Related Information

- [Receive Faxes Using PC-FAX Receive \(Windows®\)](#)
-

PC-FAX for Mac

Use Brother's PC-FAX software to send faxes directly from your Mac without printing them. This feature helps reduce your paper consumption and save time.

- [Send Faxes from Your Application \(Mac\)](#)

Send Faxes from Your Application (Mac)

Related Models: MFC-J985DW

PC-FAX supports only monochrome faxes. A monochrome fax will be sent even if the original data is colour and the receiving fax machine supports colour faxes.

1. Create a document in a Mac application.
2. From an application, such as Apple TextEdit, click the **File** menu, and then select **Print**.
3. Click the application pop-up menu, and then select the **Send Fax** option.

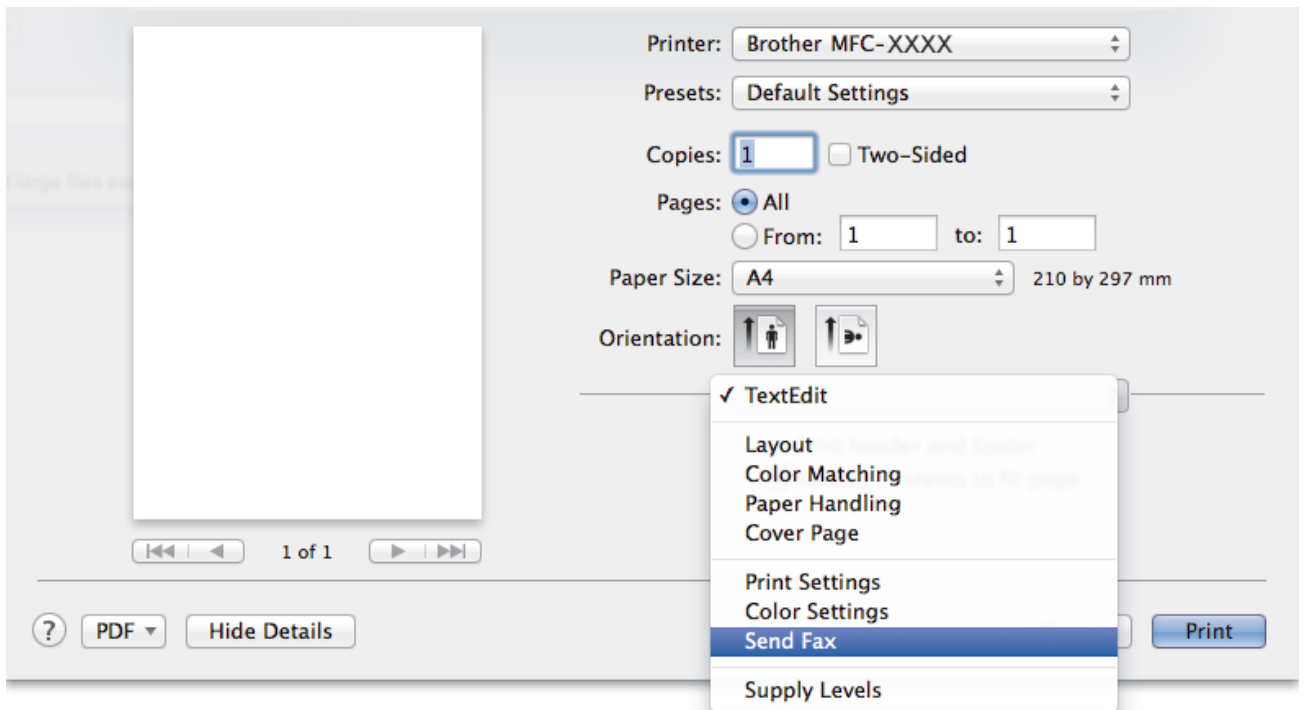

4. Click the **Output** pop-up menu, and then select the **Facsimile** option.

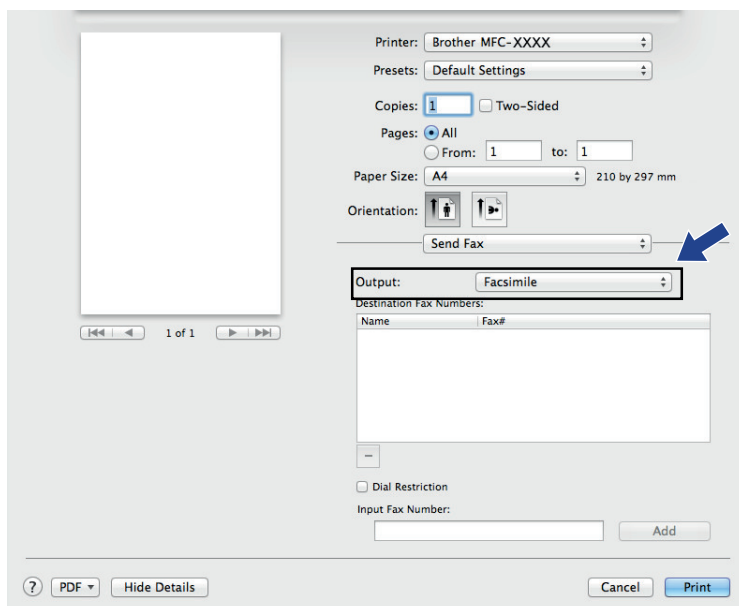

5. Type a fax number in the **Input Fax Number** field, and then click **Add**.
The fax number is displayed in the **Destination Fax Numbers** field.



To send a fax to more than one number, click the **Add** button after entering the first fax number and type the next fax number. The destination fax numbers will be listed in the **Destination Fax Numbers** field.

The screenshot shows a fax software interface with the following elements:

- Printer:** Brother MFC-XXXX
- Presets:** Default Settings
- Copies:** 1, with a checkbox for Two-Sided.
- Pages:** All (selected), with options for From: 1 to: 1.
- Paper Size:** A4 (210 by 297 mm)
- Orientation:** Portrait (selected)
- Send Fax:** Send Fax (button)
- Output:** Facsimile
- Destination Fax Numbers:** A table with columns Name and Fax#. One entry is visible: Name (blank), Fax# 222-111-3333.
- Input Fax Number:** A text field with an **Add** button next to it. A blue arrow points to this button.
- Buttons:** PDF, Hide Details, Cancel, Print.

6. Click **Print** to send the fax.



Related Information

- [PC-FAX for Mac](#)

PhotoCapture Center

- [Print Photos Directly from Media](#)
- [Copy Photos from Media to a Computer](#)
- [Print Photos from ControlCenter4 \(Windows®\)](#)

Print Photos Directly from Media

When your machine is *not* connected to your computer, you can print photos directly from digital camera media or a USB Flash memory drive, scan documents and save them directly to a memory card or USB flash drive. When your machine is connected to a computer, you can use your computer to access a memory card or USB flash drive inserted in the front of the machine.







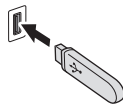

- [Compatible Memory Cards and USB Flash Drives](#)
- [Important Information about PhotoCapture Center](#)
- [Print Photos from Media Using the Photo Button on the Brother Machine](#)

Compatible Memory Cards and USB Flash Drives

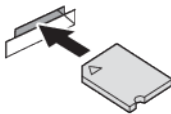
Your Brother machine has media drives (slots) for use with common data storage and digital camera media.

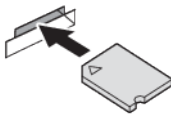
IMPORTANT

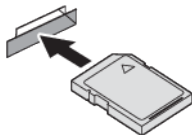
The USB direct interface supports only USB flash drives, PictBridge-compatible cameras and digital cameras that use the USB mass storage standard. Other USB devices are not supported.

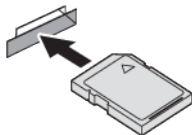
Compatible Memory Cards		Slot
USB flash drive		USB slot 
Memory Stick Duo™ Memory Stick PRO Duo™		Upper slot 
Memory Stick Micro™ (M2™)(Adapter required)		
SD Memory Card SDHC Memory Card SDXC Memory Card MultiMediaCard MultiMediaCard plus	 	Lower slot 
miniSD (Adapter required) miniSDHC (Adapter required) microSD (Adapter required) microSDHC (Adapter required) MultiMediaCard mobile (Adapter required)		

✓ Related Information

- [Print Photos Directly from Media](#)

Important Information about PhotoCapture Center



USB flash drives are available only for certain models.

Your machine is designed to be compatible with modern digital camera image files, memory cards and USB flash drives. Read the points below to avoid errors:

- The image file extension must be .JPG (other image file extensions like .JPEG, .TIF, .GIF and so on will not be recognised).
- Direct PhotoCapture Center printing must be performed separately from PhotoCapture Center operations using the computer. (Simultaneous operation is not available.)
- The machine can read up to 999 files ¹ on a memory card or USB flash drive.
- The Digital Print Order Format (DPOF) file on the memory cards must be in a valid DPOF format.

Be aware of the following:

- When printing an index or image, the PhotoCapture Center will print all the valid images, even if one or more images have been corrupted. Corrupted images will not be printed.
- (Memory card users)

Your machine is designed to read memory cards that have been formatted by a digital camera.

When a digital camera formats a memory card, it creates a special folder into which it copies image data. If you must use your computer to modify the image data stored on a memory card, we recommend that you do not modify the folder structure created by the digital camera. When saving new or modified image files to the memory card, we also recommend you use the same folder your digital camera uses. If the data is not saved to the same folder, the machine may not be able to read the file or print the image.

- (USB flash drive users)

Your machine supports USB flash drives that have been formatted by Windows®.



Related Information

- [Print Photos Directly from Media](#)
- [Print Photos from Media in Digital Print Order Format \(DPOF\)](#)

¹ The folder inside memory cards or USB flash drives is also counted.

Print Photos from Media Using the Photo Button on the Brother Machine

- [Preview and Print Photos and Movie Files from Media](#)
- [Print a Photo Index Sheet \(Thumbnails\) from Media](#)
- [Print Photos by Image Number](#)
- [Enhance Photos Using Advanced Editing Options](#)
- [Print Photos with Custom Cropping](#)
- [Print ID Photos](#)
- [Print Photos from Media in Digital Print Order Format \(DPOF\)](#)
- [Print Photos with Auto Cropping](#)
- [Print Borderless Photos from Media](#)
- [Print the Date from Your Photo's Data](#)
- [Print Settings for Photos](#)

Preview and Print Photos and Movie Files from Media

Preview your photos on the LCD before you print them. Print images from movie files that are stored on a memory card or USB flash drive.

- If your photos are large files, there may be a delay before each photo is displayed.
 - A movie file is divided into nine parts by movie recording times and is placed in three lines. You can see and print the scenes that are divided.
 - You cannot select a particular movie scene.
 - Use AVI or MOV movie file formats (Motion JPEG only). If an AVI file size is 1 GB or more (the shooting time is about 30 minutes) or a MOV file size is 2 GB or more (the shooting time is about 60 minutes), they are too large to be printed.
 - If the movie file for a divided scene is corrupted, the part for that scene will be blank.
1. Open the media slot cover.

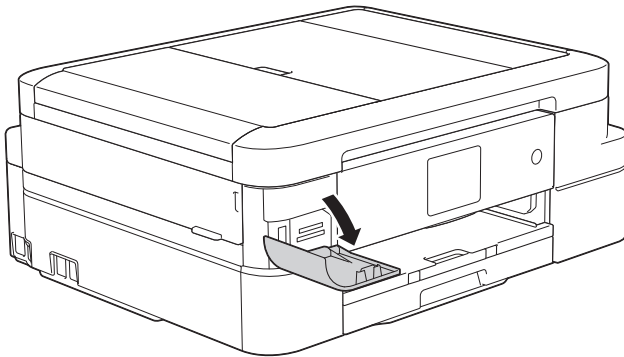

2. Put the memory card or USB flash drive in the correct slot.
3. Press [Photo] > [View Photos].
4. Press ◀ or ▶ to display the photo you want to print, and then press it.



If you want to print all the photos, press [Print All], and then press the [Yes] button to confirm.

5. Enter the number of copies in one of the following ways:
 - Press [-] or [+] on the touchscreen.
 - Press **x01** to display the keyboard on the touchscreen, and then enter the number of copies using the touchscreen keyboard. Press [OK].
6. Press [OK].
7. Repeat the last three steps until you have selected all the photos you want to print.
8. Press [OK].
9. Read and confirm the displayed list of options.
10. To change the print settings, press [Print Settings].
11. Press [Start].



Related Information

- [Print Photos from Media Using the Photo Button on the Brother Machine](#)
- [Print Settings for Photos](#)

Print a Photo Index Sheet (Thumbnails) from Media

Print a photo Index Sheet to see small preview versions of all pictures on your memory card or USB flash drive.



- The PhotoCapture Center assigns numbers for images (such as No.1, No.2, No.3, and so on). The PhotoCapture Center does not recognise any other numbers or file names that your digital camera or computer has used to identify the pictures.
- Only file names that are 20 characters or less will be printed correctly on the index sheet.
- File names cannot be printed correctly if they contain non-alphanumeric characters, but non-alphanumeric characters do not affect PhotoCapture Center settings.

1. Open the media slot cover.
2. Put the memory card or USB flash drive in the correct slot.
3. Press [Photo] > [Index Print] > [Print Index Sheet].
4. If you want to change the print settings, press [Print Settings].

Option	Description
Paper Type	Select the paper type.
Paper Size	Select the paper size.

5. Press [Start].



Related Information

- [Print Photos from Media Using the Photo Button on the Brother Machine](#)
- [Print Photos by Image Number](#)

Print Photos by Image Number

Before you can print an individual image, you must print the photo Index Sheet (thumbnails) to know the image number.

1. Open the media slot cover.
2. Put the memory card or USB flash drive in the correct slot.
3. Press [Photo] > [Index Print] > [Print Photos].
4. Enter the image numbers you want to print using the photo Index Sheet. After you have selected the image numbers, press [OK].



- Enter multiple numbers at one time using a comma or a hyphen. For example, enter **1, 3, 6** to print images No.1, No.3 and No.6. Print a range of images using a hyphen. For example, enter **1-5** to print images No.1 to No.5.
- Enter up to 12 characters (including commas and hyphens) for the image numbers you want to print.

5. Enter the number of copies in one of the following ways:
 - Press [-] or [+] on the touchscreen.
 - Press **x01** to display the keyboard on the touchscreen, and then enter the number of copies using the touchscreen keyboard. Press [OK].
6. To change the print settings, press [Print Settings].
7. Press [Start].



Related Information

- [Print Photos from Media Using the Photo Button on the Brother Machine](#)
- [Print a Photo Index Sheet \(Thumbnails\) from Media](#)
- [Print Settings for Photos](#)

Enhance Photos Using Advanced Editing Options

Related Models: MFC-J985DW

Edit and add effects to your photos and view them on the LCD before printing.

The Enhance Photos feature is supported by technology from Reallusion, Inc.









1. Open the media slot cover.
2. Put the memory card or USB flash drive in the correct slot.
3. Press [Photo] > [Enhance Photos].





- Four thumbnails are displayed at a time, along with the page number and total page count.
- Press ◀ or ▶ to scroll through all the photos. Hold down ◀ or ▶ to fast-forward and fast-rewind through the thumbnail pages.

4. Press the thumbnail you want to enhance.
5. Press [Enhance], and then press [OK].
6. Press the effect you want to add, and then press [OK].

There are 10 ways to add effects to your photo.

Option	Description
	Auto Correct The machine decides the appropriate effect for your photo.
	Enhance Skin Use for adjusting portrait photographs. It adjusts skin colour. Press ◀ or ▶ to adjust the level of contrast.
	Enhance Scenery Use for adjusting landscape photographs. It highlights green and blue areas in your photo. Press ◀ or ▶ to adjust the level of contrast.
	Remove Red-Eye The machine will attempt to remove red-eye from your photo. If red-eye detection fails, press Try Again to re-detect.
	Night Scene Use Night Scene to make night view photographs more vivid. Press ◀ or ▶ to adjust the level of contrast.
	Fill Light Fill Light is used for adjusting photographs taken against the light. Press ◀ or ▶ to adjust the level of contrast.
	Whiteboard Whiteboard is used for adjusting photographs. It detects letters on a whiteboard in your photo and makes them more legible.

Option	Description
	Monochrome Convert your photo to monochrome.
	Sepia Convert the colour of your photo to sepia.
	Auto Correct & Remove Red-Eye The machine decides the appropriate effects for your photo and attempts to remove red-eye.



- There are some cases when red-eye may not be removed.
 - When the face is too small in the image.
 - When the face is turning too far up, down, left, or right.
- Press [Cancel] to return to the list of effects.
- If your photo is very small or has irregular proportions, the touchscreen displays [Image Too Small] or [Image Too Long]. You may not be able to crop or enhance the photo.

7. Enter the number of copies in one of the following ways:
 - Press [-] or [+] on the touchscreen.
 - Press **x01** to display the keyboard on the touchscreen, and then enter the number of copies using the touchscreen keyboard. Press [OK].
8. Press [OK].
9. To change the print settings, press [Print Settings].
10. Press [Start].



Related Information

- [Print Photos from Media Using the Photo Button on the Brother Machine](#)
- [Print Settings for Photos](#)

Print Photos with Custom Cropping

Related Models: MFC-J985DW

Crop your photos and view them on the LCD before printing.



The Crop Photos feature is supported by technology from Reallusion, Inc.



1. Open the media slot cover.
2. Put the memory card or USB flash drive in the correct slot.
3. Press [Photo] > [Enhance Photos].



- Four thumbnails are displayed at a time, along with the page number and total page count.
- Press ◀ or ▶ to scroll through all the photos. Hold down ◀ or ▶ to fast-forward and fast-rewind through the thumbnail pages.

4. Press a photo thumbnail.
5. Press [Crop], and then press [OK].
6. Adjust the red frame to surround the portion of the photo you want to print.
 - Press  or  to enlarge or reduce the frame size.
 - Press ▲, ▼, ◀, or ▶ to move the position of the frame.
 - Press  to rotate the frame.

When finished, press [OK].



If your photo is very small or has irregular proportions, the touchscreen displays [Image Too Small] or [Image Too Long]. You may not be able to crop or enhance the photo.

7. Press [OK] to confirm.
8. Enter the number of copies in one of the following ways:
 - Press [-] or [+] on the touchscreen.
 - Press  01 to display the keyboard on the touchscreen, and then enter the number of copies using the touchscreen keyboard. Press [OK].
9. Press [OK].
10. To change the print settings, press [Print Settings].
11. Press [Start].



Related Information

- [Print Photos from Media Using the Photo Button on the Brother Machine](#)
- [Print Settings for Photos](#)

Print ID Photos

Select a photo stored in a memory card or USB flash drive and print ID photos for your resume, passport and so on. You can print four ID photos on one sheet of paper, and crop large images to preset sizes.

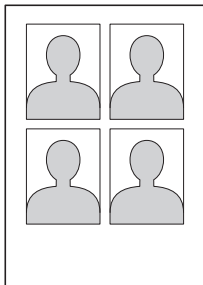

Only one photo will be printed when you select the [2x2inch] or [50x70mm] option in the ID Photo Size setting, and the [10x15cm] option in the Paper Size setting.

1. Open the media slot cover.
2. Put the memory card or USB flash drive in the correct slot.
3. Press [Photo] > [ID Photo Print].
4. Press ◀ or ▶ to display the photo you want, and then press it.
5. Press ▲ or ▼ to adjust the size of the crop you want, and then press it.



The machine crops the photo to the selected size. To crop to a different size, repeat these steps.

6. Confirm the displayed image. Rotate the image if needed by pressing .
7. Press [OK].
8. To change the print settings, press [Print Settings].

Option	Description
Print Quality	Select the print resolution for your type of document.
Paper Type	Select the paper type.
Paper Size	Select the paper size.
Photo Enhance (MFC-J985DW)	Print a more vivid photo.

9. Press [Start].



Related Information

- [Print Photos from Media Using the Photo Button on the Brother Machine](#)

Print Photos from Media in Digital Print Order Format (DPOF)

Major digital camera manufacturers (Canon, Inc., Eastman Kodak Company, FUJIFILM Corporation, Panasonic Corporation and Sony Corporation) created this standard to make it easier to print images from a digital camera.

If your digital camera supports DPOF printing, you can use the display of the digital camera to select the images and number of copies you want to print.

When a memory card (Memory Stick Duo™, Memory Stick PRO Duo™, SD Memory Card, SDHC Memory Card, SDXC Memory Card, MultiMediaCard, or MultiMediaCard plus) containing DPOF information is put into your machine, you can print the selected image.



A DPOF File error can occur if the print order that was created on the camera has been corrupted. Delete and recreate the print order using your camera to correct this problem. For instructions on how to delete or recreate the print order, see your camera manufacturer's support website or accompanying documentation.

1. Open the media slot cover.
2. Put the memory card or USB flash drive in the correct slot.
3. Press ▲ or ▼ to display the [DPOF] option, and then press it.
4. To change the print settings, press [Print Settings].
5. Press [Start].



Related Information

- [Print Photos from Media Using the Photo Button on the Brother Machine](#)
- [Important Information about PhotoCapture Center](#)
- [Print Settings for Photos](#)

Print Photos with Auto Cropping

If your photo is too long or too wide to fit the space in your layout, part of the image will be cropped.

- The factory setting is On. To print the whole image, change this setting to Off.
- If you set the [Cropping] setting to Off, set the [Borderless] setting to Off, also.

Cropping: On

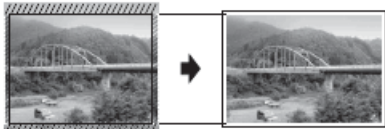

Cropping: Off



1. Open the media slot cover.
2. Put the memory card or USB flash drive in the correct slot.
3. Press [Photo] > [View Photos].
4. Press ◀ or ▶ to display each photo. When the photo you want is displayed, press it, and then press [OK].
5. Press [OK].
6. Press [Print Settings] > [Cropping].
7. Press [On] (or [Off]).
8. When finished, press  or [OK].
9. Press [Start].

✓ Related Information

- [Print Photos from Media Using the Photo Button on the Brother Machine](#)
- [Other Problems](#)

Print Borderless Photos from Media

This feature expands the printable area to the edges of the paper. Printing time will be slower.

1. Open the media slot cover.
2. Put the memory card or USB flash drive in the correct slot.
3. Press [Photo] > [View Photos].
4. Press ◀ or ▶ to display each photo. When the photo you want is displayed, press it, and then press [OK].
5. Press [OK].
6. Press [Print Settings] > [Borderless].
7. Press [On] (or [Off]).
8. When finished, press  or [OK].
9. Press [Start].

Related Information

- [Print Photos from Media Using the Photo Button on the Brother Machine](#)
- [Other Problems](#)

Print the Date from Your Photo's Data

Print the date if it is already in your photo's information. The date will be printed on the lower-right corner. To use this setting, the photo must include the date.

The Digital Print Order Format (DPOF) setting on your camera must be turned off to use the Print Date feature.

1. Open the media slot cover.
2. Put the memory card or USB flash drive in the correct slot.
3. Press [Photo] > [View Photos].
4. Press ◀ or ▶ to display each photo. When the photo you want is displayed, press it, and then press [OK].
5. Press [OK].
6. Press [Print Settings] > [Date Print].
7. Press [On] (or [Off]).
8. When finished, press  or [OK].
9. Press [Start].



Related Information

- [Print Photos from Media Using the Photo Button on the Brother Machine](#)

Print Settings for Photos

Press the [Print Settings] option to display the settings shown in the table.

Option	Description
Print Quality (Does not appear when Digital Print Order Format (DPOF) Print is selected)	Select the print resolution for your type of document. <ul style="list-style-type: none"> When you select the Inkjet Paper option in the Paper Type setting, you can select only Photo.
Paper Type	Select the paper type.
Paper Size	Select the paper size.
Print Size (When A4 or Letter is selected)	Select the print size when using A4 or Letter size paper. The Printed Position differs depending on the Print Size option. For more detailed information, see the following table.
Print Layout	Select the print layout.
Auto Correct (MFC-J985DW) (Does not appear when Digital Print Order Format (DPOF) Print is selected) (View Photos and Slide Show only)	Set the machine to decide the appropriate effect for your photo. <ul style="list-style-type: none"> Images that are very small or very elongated may not be corrected.
Brightness (Does not appear when Enhance is selected)	Adjust the brightness.
Contrast (Does not appear when Enhance is selected)	Adjust the contrast. Increasing the contrast makes an image look sharper and more vivid.
Colour Enhance (Does not appear when Enhance is selected)	Print a more vivid photo. Print time becomes slower, and depending on the image, this feature may use more ink.
Cropping	Crop the image around the margin to fit the paper size or print size. Turn this feature off when you want to print whole images or prevent unwanted cropping.
Borderless	Expand the printable area to fit the edges of the paper.
Date Print (Does not appear when Digital Print Order Format (DPOF) Print is selected)	Print the date on your photo.
Set New Default	Save the print settings you use most often by setting them as defaults.
Factory Reset	Restore any changed print settings back to the factory settings.

Printed Position for A4 Size Paper

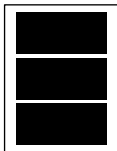
Print Size Option	Printed Position
8x10cm	
9x13cm	

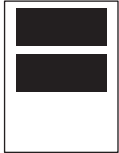
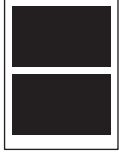
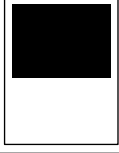
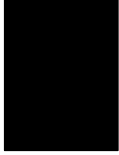
Print Size Option	Printed Position
10x15cm	
13x18cm	
15x20cm	
Max. Size	



Related Information

- [Print Photos from Media Using the Photo Button on the Brother Machine](#)
- [Enhance Photos Using Advanced Editing Options](#)
- [Preview and Print Photos and Movie Files from Media](#)
- [Print Photos by Image Number](#)
- [Print Photos with Custom Cropping](#)
- [Print Photos from Media in Digital Print Order Format \(DPOF\)](#)

Copy Photos from Media to a Computer

If you would like to copy photos stored in a memory card or USB flash drive to a folder on your computer, follow the steps for your connection type and Operating System.

- [Before Copying Photos](#)
- [Copy Photos from Media Over a Local Connection](#)
- [Copy Photos from Media Over a Network Connection](#)

Before Copying Photos

IMPORTANT

DO NOT start your computer with a memory card or USB flash drive in the media drive of the machine. You could lose your data or damage the media.



- The PhotoCapture Center will read only the media that was put in first.
- While the machine is printing from the PhotoCapture Center, your computer cannot access the PhotoCapture Center for any other operation.



Related Information

- [Copy Photos from Media to a Computer](#)

Copy Photos from Media Over a Local Connection

You can copy photos from media to your computer when it is locally connected (via USB) to your machine.

1. Open the machine's media slot cover.
2. Insert a memory card or USB flash drive into your machine.
3. Do one of the following:
 - (Windows®)
In Windows® Explorer, double-click the **Removable Disk** icon.
 - (Mac)
Double-click the removable disk icon.



If you create a name for the volume label of the memory card or USB flash drive, this name appears.

The files and folders on the memory card or USB flash drive appear on your computer screen.

4. You can edit a file and save it to another drive on your computer.
5. Quit all applications that are running stored data on the memory card or USB flash drive.
6. Do one of the following:
 - (Windows®)
In Windows® Explorer, right-click the removable disk icon and select **Eject**.
 - (Mac)
Drag the removable disk icon into the **Trash** icon.
7. Wait until the LCD message disappears before removing the media.

IMPORTANT

DO NOT remove the memory card or USB flash drive while the message is displayed on the LCD. Otherwise, the card, USB flash drive, or data stored on the card could be damaged.

If you remove the memory card or USB flash drive while the LCD is displaying the message, you must restart your computer before inserting the same memory card or USB flash drive into the machine. If you do not restart your computer, the data on your media could be destroyed.



Related Information

- [Copy Photos from Media to a Computer](#)

Copy Photos from Media Over a Network Connection

You can copy photos from media to your computer when it is connected to the machine using a Network connection.

1. Open the machine's media slot cover.
2. Insert a memory card or USB flash drive into your machine.
3. Type the IP address of your Brother machine in your web browser (where XXX.XXX.XXX.XXX is your Brother machine's IP address).

ftp://XXX.XXX.XXX.XXX



- Your web browser must support the FTP protocol.
- The IP address can be found on the Network Configuration Report or in the machine's Network Menu.

Your web browser accesses the media using the FTP protocol and the network Host Name of the machine.

4. Click the name of the file you want to copy and save it to your computer.

NOTE

When saving files, certain characters or symbols may cause a problem accessing the file. We recommend using combinations of these characters in a file name:

1234567890
ABCDEFGHIJKLMN OPQRSTUVWXYZ
abcdefghijklmnopqrstu vwxyz
!#\$%&'()-.,@^_`{|}~

5. Close the web browser.
6. Wait until the LCD message disappears before removing the media.

IMPORTANT

DO NOT remove the memory card or USB flash drive while the message is displayed on the LCD. Otherwise, the card, USB flash drive, or data stored on the card could be damaged.

If you remove the memory card or USB flash drive while the LCD is displaying the message, you must restart your computer before inserting the same memory card or USB flash drive into the machine. If you do not restart your computer, the data on your media could be destroyed.



Related Information

- [Copy Photos from Media to a Computer](#)
- [Print the Network Configuration Report](#)

Print Photos from ControlCenter4 (Windows®)

You can print and edit photos using various ControlCenter features.

1. Make sure you have loaded the correct media in the paper tray.

IMPORTANT

- We recommend using the photo paper tray located on the top of the output tray cover to print on Photo (10 x 15 cm) and Photo L (9 x 13 cm) paper. (available only for certain models)
- For best results, use Brother paper.
- When you print on Brother photo paper, load one extra sheet of the same photo paper in the paper tray.

2. Click the  (ControlCenter4) icon in the task tray, and then click **Open**.
3. Do one of the following:
 - If you are using **Advanced Mode**, click the **Photo** tab, and then click the **Photo Print** button.
 - If you are using **Home Mode**, click the **Photo** tab.



4. Select the folder that contains the image you want to print.

Option	Description
My CC4 Folder	The My CC4 Folder button lets you open the ControlCenter4 folder located in the My Pictures folder on your computer.
Desktop	The Desktop button lets you open the folder tree from your desktop to select images you want to print.

5. Select images you want to print by selecting the check box under the thumbnail in the image viewer.

Option	Description
Select All	Selects all thumbnails in the current view.
Deselect All	Deselects all thumbnails in the current view.

- Specify the number of copies you want to print (1-99) by clicking .
- To trim the photo before printing, click **Edit**.
- Click **Print**.
The print settings window appears.
- Configure the settings for the **Paper Size**, **Media Type**, and **Layout** options.

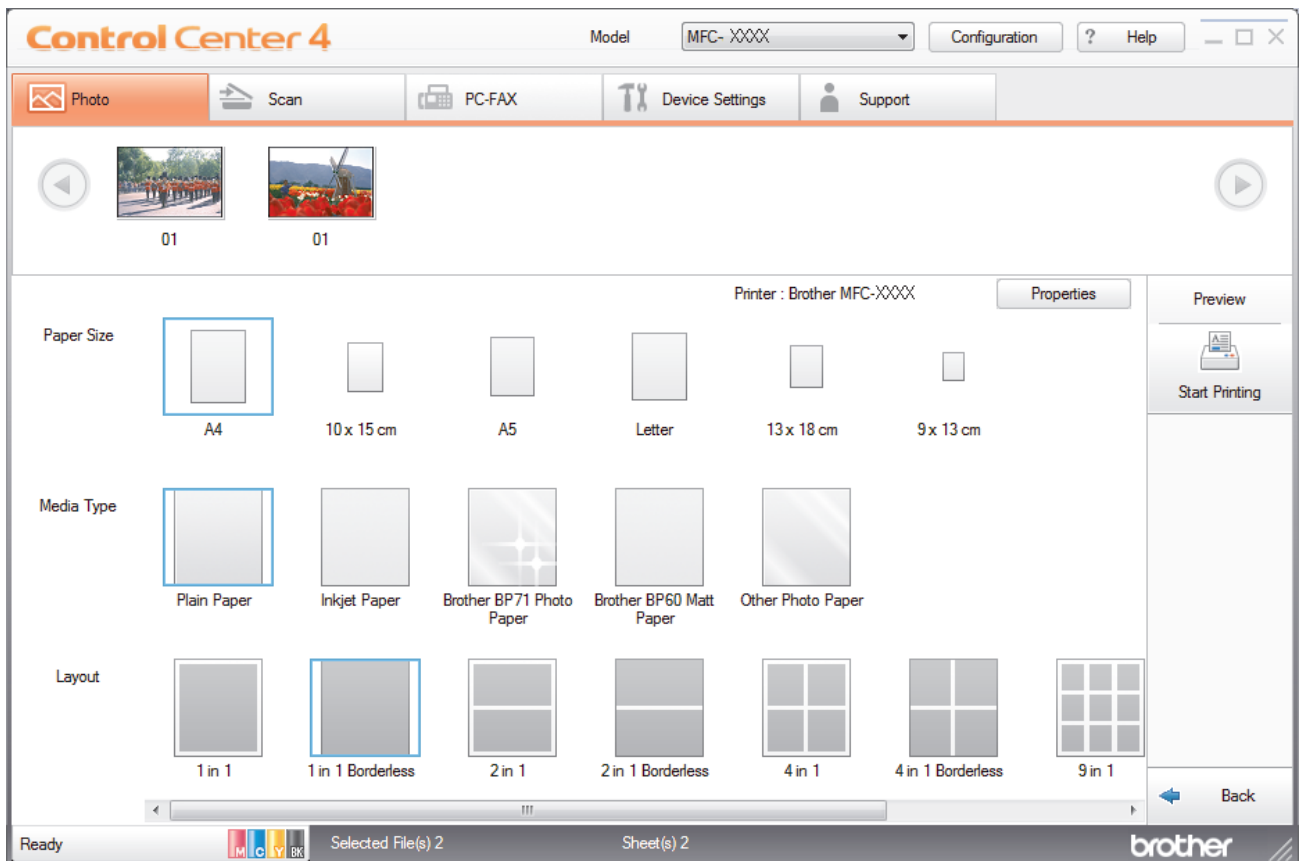

- Click the **Properties** button to configure the **Print Quality**, **Colour / Greyscale** and **Colour Mode** options, if needed. To print the image's timestamp in the lower-right corner of the image, select the **Print Date** check box.
- To change other printer settings, click the **Print Options...** button. (For Advanced Mode only)
- Click **OK**.
- Click the **Preview** button to view the image on screen before printing.
- Click the **Start Printing** button.



Related Information

- [PhotoCapture Center](#)
- [Edit Photos Using ControlCenter4 \(Windows®\)](#)

Edit Photos Using ControlCenter4 (Windows®)

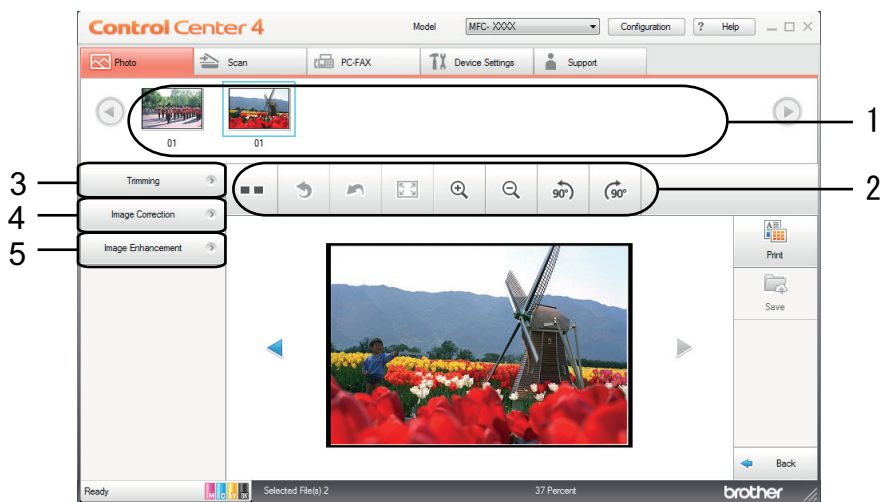

1. This area shows which images are currently selected, and how many copies of each image will be printed.
2. These buttons allow you to control how you view the selected image.

Buttons	Description
(Compare)	Compare the edited image with the original.
(Undo)	Cancel the last edit applied to the selected image.
(Restart)	Cancel all the edits applied to the selected image. The edited image reverts to its original state.
(Fit to Window)	Set the zoom level so that the image fits the window.
(Zoom In/Zoom Out)	Enlarge or reduce the selected image.
(Rotate Counterclockwise/Rotate Clockwise)	Rotate the image by 90 degrees, clockwise or counter-clockwise.
(Previous/Next)	Display the previous or next image.

3. **Trimming**
This feature allows you to remove unwanted areas from your photos.
4. **Image Correction**

Auto Correction

Select this option to apply a range of automatic corrections that can enhance an image.

Red-Eye Removal

Select this option to correct red eye in photo images, which is sometimes caused by a camera's flash.

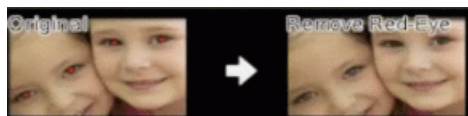

Monochrome

Select this option to remove colour information from the image.

Sepia

Select this option to remove colour information from the image and add a sepia tone.

5. Image Enhancement

Nature Scene

Select this option to enhance natural colours, such as green and blue.

Night Scene

Select this option to optimise the image adjustments for a night scene photo.

Soft Light

Select this option to soften bright edges.



Related Information

- [Print Photos from ControlCenter4 \(Windows®\)](#)
-

Network

- [Get Started](#)
- [Network Management Software and Utilities](#)
- [Additional Methods of Configuring Your Brother Machine for a Wireless Network](#)
- [Advanced Network Features](#)
- [Technical Information for Advanced Users](#)

Get Started

We recommend setting up and connecting to your network using the Brother installation CD-ROM. This section provides more information on network connection types, introduces various methods to manage your network and explains some useful network features of your Brother machine.

- [Supported Basic Network Features](#)

Supported Basic Network Features

The print server supports various features depending on the operating system. Use this chart to see what network features and connections are supported by each operating system.

Operating Systems	Windows® XP Windows Vista® Windows® 7 Windows® 8 Windows® 10	Windows Server® 2003/2008/2012/2012 R2	OS X v10.8.5 OS X v10.9.x OS X v10.10.x
Printing	Yes	Yes	Yes
Scanning	Yes		Yes
PC Fax Send (available only for certain models) ¹	Yes		Yes
PC Fax Receive (available only for certain models) ¹	Yes		
Photo Capture (available only for certain models)	Yes		Yes
BRAdmin Light ²	Yes	Yes	
BRAdmin Professional ³	Yes	Yes	
Remote Setup (available only for certain models) ¹	Yes		Yes
Status Monitor	Yes		Yes
Driver Deployment Wizard	Yes	Yes	
Vertical Pairing (Windows® 7, Windows® 8 and Windows® 10 only)	Yes		



Related Information

- [Get Started](#)

¹ Not available for DCP models.

² BRAdmin Light is available as a download from your model's page at support.brother.com.

³ BRAdmin Professional is available as a download from your model's page at support.brother.com.

Network Management Software and Utilities

Configure and change your Brother machine's network settings using a management utility.

- [Learn about Network Management Software and Utilities](#)
- [Change Machine Settings from Your Computer](#)

Learn about Network Management Software and Utilities

BRAdmin Light (Windows®)

BRAdmin Light is a utility for the initial setup of Brother network-connected devices. This utility can search for Brother products on your network, view the status and configure the basic network settings, such as IP address.

Go to your model's **Downloads** page on the Brother Solutions Center at support.brother.com to download BRAdmin Light.



- If using Windows® Firewall, or the firewall function of an anti-spyware or antivirus application, temporarily disable them. When you are sure you can print, configure the software settings following the instructions.

BRAdmin Professional (Windows®)

BRAdmin Professional is a utility for more advanced management of network-connected Brother devices. This utility can search for Brother products on your network and view the device status from an easy-to-read Windows® Explorer-style screen that changes colour to identify the status of each device. You can configure network and device settings, and update device firmware from a Windows® computer on your LAN. BRAdmin Professional can also log activity of Brother devices on your network and export the log data.



- Go to your model's **Downloads** page on the Brother Solutions Center at support.brother.com to download the latest version of Brother's BRAdmin Professional utility.
- Node name: The node name appears in the current BRAdmin Professional window. The default node name is "BRNxxxxxxxxxxxx" for a wired network or "BRWxxxxxxxxxxxx" for a wireless network (where "xxxxxxxxxxxx" is your machine's MAC Address / Ethernet address).
- If using Windows® Firewall, or the firewall function of an anti-spyware or antivirus application, temporarily disable them. When you are sure you can print, configure the software settings following the instructions.

Remote Setup (Windows® and Mac)

Remote Setup is a program for configuring many machine and network settings from either a Windows® or a Mac application. When you start this application, the settings on your machine are automatically downloaded to your computer and displayed on your computer screen. If you change the settings, you can upload them directly to the machine.



This utility can be used with either a USB or a network connection.



Related Information

- [Network Management Software and Utilities](#)

Additional Methods of Configuring Your Brother Machine for a Wireless Network

To connect your machine to your wireless network, we recommend using the Installation CD-ROM.

- [Before Configuring Your Brother Machine for a Wireless Network](#)
- [Configure Your Machine for a Wireless Network Using the One Push Method of Wi-Fi Protected Setup™ \(WPS\) or AOSS™](#)
- [Configure Your Machine for a Wireless Network Using the PIN Method of Wi-Fi Protected Setup™ \(WPS\)](#)
- [Configure Your Machine for a Wireless Network in Ad-Hoc Mode Using a New SSID](#)
- [Configure Your Machine for a Wireless Network When the SSID is Not Broadcast](#)
- [Use Wi-Fi Direct®](#)

Before Configuring Your Brother Machine for a Wireless Network

Before attempting to configure a wireless network, confirm the following:

- To achieve optimum results with normal everyday document printing, place the Brother machine as close to the wireless LAN access point/router as possible with minimal obstructions. Large objects and walls between the two devices and interference from other electronic devices can affect the data transfer speed of your documents.

Due to these factors, wireless may not be the best method of connection for all types of documents and applications. If you are printing large files, such as multi-page documents with mixed text and large graphics, you may want to consider selecting wired Ethernet for faster data transfer (supported models only), or USB for the fastest throughput speed.

- Although the Brother machine can be used in both a wired and wireless network, only one connection method can be used at a time (supported models only). However, a wireless network connection and Wi-Fi Direct connection, or a wired network connection (supported models only) and Wi-Fi Direct connection can be used at the same time.
- Before configuring wireless settings, you must know your Network name (SSID) and Network Key.



Related Information

- [Additional Methods of Configuring Your Brother Machine for a Wireless Network](#)

Configure Your Machine for a Wireless Network Using the One Push Method of Wi-Fi Protected Setup™ (WPS) or AOSS™

If your wireless access point/router supports either WPS (Push Button Configuration) or AOSS™, you can use WPS or AOSS™ from your machine's control panel menu to configure your wireless network settings.



- Routers or access points that support WPS are marked with this symbol:



- Routers or access points that support AOSS™ are marked with this symbol:



1. Press  [Settings] > [All Settings] > [Network] > [WLAN] > [WPS/AOSS].
2. When [Switch Network interface to wireless?] or [Enable WLAN?] appears, press [Yes]. The wireless setup wizard starts. To cancel, press [No].
3. When the touchscreen instructs you to start WPS or AOSS™, press the WPS or AOSS™ button on your wireless access point/router. Then press [OK] on your machine. Your machine will automatically detect which mode (WPS or AOSS™) your wireless access point/router uses and try to connect to your wireless network.

If your wireless device is connected successfully, the LCD displays [Connected].

You have completed the wireless network setup. To install drivers and software necessary for operating your device, insert the Brother installation disc into your computer or go to your model's **Downloads** page on the Brother Solutions Center at support.brother.com.



Related Information

- [Additional Methods of Configuring Your Brother Machine for a Wireless Network](#)

Configure Your Machine for a Wireless Network Using the PIN Method of Wi-Fi Protected Setup™ (WPS)

If your wireless LAN access point/router supports WPS, you can use the Personal Identification Number (PIN) Method to configure your wireless network settings.

The PIN Method is one of the connection methods developed by the Wi-Fi Alliance®. By submitting a PIN created by an Enrollee (your machine) to the Registrar (a device that manages the wireless LAN), you can set up the wireless network and security settings. For more information on how to access WPS mode, see the instructions provided with your wireless access point/router.

Type A

Connection when the wireless LAN access point/router (1) doubles as the Registrar.

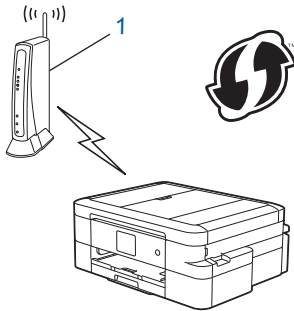

Type B

Connection when another device (2), such as a computer, is used as the Registrar.

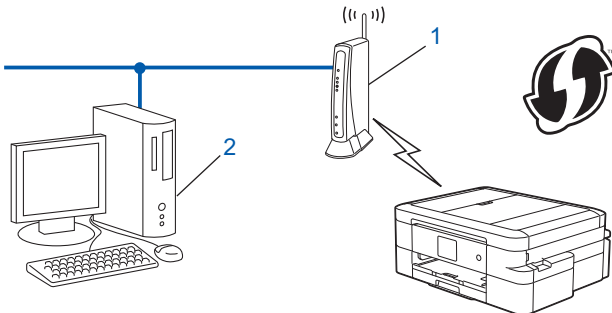

 Routers or access points that support WPS are marked with this symbol:



1. Press  [Settings] > [All Settings] > [Network] > [WLAN] > [WPS w/ PIN Code].
2. When [Switch Network interface to wireless?] or [Enable WLAN?] appears, press [Yes].
The wireless setup wizard starts. To cancel, press [No].
3. The LCD displays an eight-digit PIN and the machine starts searching for a wireless LAN access point/router.
4. Using a computer connected to the network, type in your browser's address bar the IP address of the device you are using as the Registrar. (For example: <http://192.168.1.2>)
5. Go to the WPS settings page and type the PIN, and then follow the on-screen instructions.



- The Registrar is usually the wireless LAN access point/router.
- The settings page will differ depending on the brand of wireless LAN access point/router. For more information, see the instructions supplied with your wireless LAN access point/router.

If you are using a Windows Vista[®], Windows[®] 7, Windows[®] 8, or Windows[®] 10 computer as a Registrar, complete the following steps:

6. Do one of the following:

- Windows Vista[®]

Click  (**Start**) > **Network** > **Add a wireless device**.

- Windows[®] 7

Click  (**Start**) > **Devices and Printers** > **Add a device**.

- Windows[®] 8

Move your mouse to the lower right corner of your desktop. When the menu bar appears, click **Settings** > **Control Panel** > **Hardware and Sound** > **Devices and Printers** > **Add a device**.

- Windows[®] 10

Click  > **All apps** > **Windows System** > **Control Panel**. In the **Hardware and Sound** group, click **Add a device**.



- To use a Windows Vista[®], Windows[®] 7, Windows[®] 8, or Windows[®] 10 computer as a Registrar, you must register it to your network in advance. For more information, see the instructions supplied with your wireless LAN access point/router.
- If you use Windows[®] 7, Windows[®] 8, or Windows[®] 10 as a Registrar, you can install the printer driver after the wireless configuration by following the on-screen instructions. To install the full driver and software package, use the Brother installation disc.

7. Select your machine and click **Next**.

8. Type the PIN displayed on the machine's LCD, and then click **Next**.

9. Select your network, and then click **Next**.

10. Click **Close**.



Related Information

- [Additional Methods of Configuring Your Brother Machine for a Wireless Network](#)

Configure Your Machine for a Wireless Network in Ad-Hoc Mode Using a New SSID

You must connect to a new SSID from your computer when it is configured for Ad-Hoc mode.

1. Press  [Settings] > [All Settings] > [Network] > [WLAN] > [Setup Wizard].
2. When [Switch Network interface to wireless?] or [Enable WLAN?] appears, press [Yes]. The wireless setup wizard starts. To cancel, press [No].
3. The machine searches for your network and displays a list of available SSIDs. Press ▲ or ▼ to display the [<New SSID>] option, and then press it.
4. Press [OK].
5. Enter the SSID name, and then press [OK].



For more information about how to enter text, see the *Appendix*.

6. Press [Ad-hoc].
7. Press either [None] or [WEP].
8. If you selected the [WEP] option for Encryption type, enter the WEP key, and then press [OK].



Your Brother machine supports the use of the first WEP key only.

9. To apply the settings, press [Yes]. To cancel, press [No].
10. The machine attempts to connect to the wireless device you have selected.

If your wireless device is connected successfully, the LCD displays [Connected].

You have completed the wireless network setup. To install drivers and software necessary for operating your device, insert the Brother installation disc into your computer or go to your model's **Downloads** page on the Brother Solutions Center at support.brother.com.



Related Information

- [Additional Methods of Configuring Your Brother Machine for a Wireless Network](#)
- [Wireless LAN Report Error Codes](#)

Configure Your Machine for a Wireless Network When the SSID is Not Broadcast

Before configuring your machine, we recommend writing down your wireless network settings. You will need this information before you continue with the configuration.

1. Check and write down the current wireless network settings.

Network Name (SSID)				
Communication Mode	Authentication Method	Encryption Mode	Network Key	
Infrastructure	Open System	NONE	-	
		WEP		
	Shared Key	WEP		
		WPA/WPA2-PSK	AES	
			TKIP (TKIP is supported for WPA-PSK only.)	

For example:

Network Name (SSID)			
HELLO			
Communication Mode	Authentication Method	Encryption Mode	Network Key
Infrastructure	WPA2-PSK	AES	12345678



If your router uses WEP encryption, enter the key used as the first WEP key. Your Brother machine supports the use of the first WEP key only.

2. Press  [Settings] > [All Settings] > [Network] > [WLAN] > [Setup Wizard].
3. When [Switch Network interface to wireless?] or [Enable WLAN?] appears, press [Yes].
The wireless setup wizard starts. To cancel, press [No].
4. The machine searches for your network and displays a list of available SSIDs. Press ▲ or ▼ to display the [<New SSID>] option, and then press it.
5. Press [OK].
6. Enter the SSID name, and then press [OK].



For more information about how to enter text, see the *Appendix*.

7. Press [Infrastructure].
8. Select the Authentication Method, and then press it.
9. Do one of the following:
 - If you selected the [Open System] option, press either [None] or [WEP].
If you selected the [WEP] option for Encryption type, enter the WEP key, and then press [OK].
 - If you selected the [Shared Key] option, enter the WEP key, and then press [OK].
 - If you selected the [WPA/WPA2-PSK] option, press either [TKIP+AES] or [AES].
Enter the WPA key, and then press [OK].



- For more information about how to enter text, see the *Appendix*.
- Your Brother machine supports the use of the first WEP key only.

10. To apply the settings, press [Yes]. To cancel, press [No].

11. The machine attempts to connect to the wireless device you have selected.

If your wireless device is connected successfully, the LCD displays [Connected].

You have completed the wireless network setup. To install drivers and software necessary for operating your device, insert the Brother installation disc into your computer or go to your model's **Downloads** page on the Brother Solutions Center at support.brother.com.



Related Information

- [Additional Methods of Configuring Your Brother Machine for a Wireless Network](#)
 - [I Cannot Complete the Wireless Network Setup Configuration](#)
-

Use Wi-Fi Direct®

- [Print or Scan from Your Mobile Device Using Wi-Fi Direct](#)
- [Configure Your Wi-Fi Direct Network](#)
- [I Cannot Complete the Wireless Network Setup Configuration](#)

Print or Scan from Your Mobile Device Using Wi-Fi Direct

Wi-Fi Direct is one of the wireless configuration methods developed by the Wi-Fi Alliance®. It allows you to configure a secured wireless network between your Brother machine and a mobile device, such as an Android™ device, Windows Phone® device, iPhone, iPod touch, or iPad, without using an access point. Wi-Fi Direct supports wireless network configuration using the one-push or PIN Method of Wi-Fi Protected Setup™ (WPS). You can also configure a wireless network by manually setting a SSID and password. Your Brother machine's Wi-Fi Direct feature supports WPA2™ security with AES encryption.

To print or scan directly from your mobile device, download Brother iPrint&Scan from the Google Play™ Store (Android Market™) or the App Store.

For more detailed information, see the *Mobile Print/Scan Guide for Brother iPrint&Scan*. Go to your model's **Manuals** page on the Brother Solutions Center at support.brother.com to download the guide.



1. Mobile device
2. Your Brother machine



- Although the Brother machine can be used in both a wired (supported models only) and wireless network, only one connection method can be used at a time. However, a wireless network connection and Wi-Fi Direct connection, or a wired network connection and Wi-Fi Direct connection can be used at the same time.
- The Wi-Fi Direct supported device can become a Group Owner (G/O). When configuring the Wi-Fi Direct network, the Group Owner (G/O) serves as an access point.
- Ad-hoc mode and Wi-Fi Direct cannot be used at the same time. Disable one function to enable the other. To use Wi-Fi Direct while you are using Ad-hoc mode, set Network I/F to Wired LAN or disable Ad-hoc mode and connect your Brother machine to the access point.



Related Information

- [Use Wi-Fi Direct®](#)

Configure Your Wi-Fi Direct Network

Configure your Wi-Fi Direct network settings from your machine's control panel.

- [Wi-Fi Direct Network Configuration Overview](#)
- [Configure Your Wi-Fi Direct Network Using the One-Push Method](#)
- [Configure Your Wi-Fi Direct Network Using the One-Push Method and Wi-Fi Protected Setup™ \(WPS\)](#)
- [Configure Your Wi-Fi Direct Network Using the PIN Method](#)
- [Configure Your Wi-Fi Direct Network Using the PIN Method of Wi-Fi Protected Setup™ \(WPS\)](#)
- [Configure Your Wi-Fi Direct Network Manually](#)

Wi-Fi Direct Network Configuration Overview

The following instructions offer five methods for configuring your Brother machine in a wireless network environment. Select the method you prefer for your environment.

Check your mobile device for configuration.

1. Does your mobile device support Wi-Fi Direct?

Option	Description
Yes	Go to Step 2
No	Go to Step 3

2. Does your mobile device support one-push configuration for Wi-Fi Direct?

Option	Description
Yes	See <i>Related Information</i> : Configure Your Wi-Fi Direct Network Using the One-Push Method
No	See <i>Related Information</i> : Configure Your Wi-Fi Direct Network Using the PIN Method

3. Does your mobile device support Wi-Fi Protected Setup™ (WPS)?

Option	Description
Yes	Go to Step 4
No	See <i>Related Information</i> : Configure Your Wi-Fi Direct Network Manually

4. Does your mobile device support one-push configuration for Wi-Fi Protected Setup™ (WPS)?

Option	Description
Yes	See <i>Related Information</i> : Configure Your Wi-Fi Direct Network Using the One-Push Method and Wi-Fi Protected Setup™ (WPS)
No	See <i>Related Information</i> : Configure Your Wi-Fi Direct Network Using the PIN Method of Wi-Fi Protected Setup™ (WPS)

To use Brother iPrint&Scan functionality in a Wi-Fi Direct network configured by one-push configuration using Wi-Fi Direct or by PIN Method configuration using Wi-Fi Direct, the device you use to configure Wi-Fi Direct must be running Android™ 4.0 or greater.

✓ Related Information

- [Configure Your Wi-Fi Direct Network](#)
- [Configure Your Wi-Fi Direct Network Using the One-Push Method](#)
- [Configure Your Wi-Fi Direct Network Using the PIN Method](#)
- [Configure Your Wi-Fi Direct Network Manually](#)
- [Configure Your Wi-Fi Direct Network Using the One-Push Method and Wi-Fi Protected Setup™ \(WPS\)](#)
- [Configure Your Wi-Fi Direct Network Using the PIN Method of Wi-Fi Protected Setup™ \(WPS\)](#)

Configure Your Wi-Fi Direct Network Using the One-Push Method

If your mobile device supports Wi-Fi Direct, follow these steps to configure a Wi-Fi Direct network:



When the machine receives the Wi-Fi Direct request from your mobile device, the message [Wi-Fi Direct connection request received. Press [OK] to connect.] will appear on the LCD. Press [OK] to connect.

1. Press  [Settings] > [All Settings] > [Network] > [Wi-Fi Direct] > [Push Button].
2. When [Wi-Fi Direct On?] appears, press [On] to accept. To cancel, press [Off].
3. Activate Wi-Fi Direct on your mobile device (see your mobile device's user's guide for instructions) when [Activate Wi-Fi Direct on other device. Then Press [OK].] appears. Press [OK] on your Brother machine. This will start the Wi-Fi Direct setup.
4. Do one of the following:
 - When your Brother machine is the G/O (Group Owner), connect your mobile device to the machine directly.
 - When your Brother machine is not the G/O, it will display available device names with which to configure a Wi-Fi Direct network. Select the mobile device to which you want to connect and press [OK]. Search for available devices again by pressing [Rescan].
5. If your mobile device connects successfully, the machine displays [Connected]. You have completed the Wi-Fi Direct network setup. For more information on printing from or scanning to your mobile device, download the *Mobile Print/Scan Guide for Brother iPrint&Scan* or the *AirPrint Guide* from your model's **Manuals** page on the Brother Solutions Center at support.brother.com.



Related Information

- [Configure Your Wi-Fi Direct Network](#)
- [Wi-Fi Direct Network Configuration Overview](#)

Configure Your Wi-Fi Direct Network Using the One-Push Method and Wi-Fi Protected Setup™ (WPS)

If your mobile device supports WPS (PBC; Push Button Configuration), follow these steps to configure a Wi-Fi Direct network:



When the machine receives the Wi-Fi Direct request from your mobile device, the message [Wi-Fi Direct connection request received. Press [OK] to connect.] will appear on the LCD. Press [OK] to connect.

1. Press  [Settings] > [All Settings] > [Network] > [Wi-Fi Direct] > [Group Owner] > [On].
2. Press [Push Button].
3. When [Wi-Fi Direct On?] appears, press [On] to accept. To cancel, press [Off].
4. Activate your mobile device's WPS one-push configuration method (see your mobile device's user's guide for instructions). When [Activate Wi-Fi Direct on other device. Then Press [OK].] appears on the machine's LCD, press [OK] on your machine.
This will start the Wi-Fi Direct setup.
5. If your mobile device connects successfully, the machine displays [Connected]. You have completed the Wi-Fi Direct network setup. For more information on printing from or scanning to your mobile device, download the *Mobile Print/Scan Guide for Brother iPrint&Scan* or the *AirPrint Guide* from your model's **Manuals** page on the Brother Solutions Center at support.brother.com.



Related Information



- [Configure Your Wi-Fi Direct Network](#)
- [Wi-Fi Direct Network Configuration Overview](#)

Configure Your Wi-Fi Direct Network Using the PIN Method

If your mobile device supports the PIN Method of Wi-Fi Direct, follow these steps to configure a Wi-Fi Direct network:



When the machine receives the Wi-Fi Direct request from your mobile device, the message [Wi-Fi Direct connection request received. Press [OK] to connect.] will appear on the LCD. Press [OK] to connect.

1. Press  [Settings] > [All Settings] > [Network] > [Wi-Fi Direct] > [PIN Code].
2. When [Wi-Fi Direct On?] appears, press [On] to accept. To cancel, press [Off].
3. Activate Wi-Fi Direct on your mobile device (see your mobile device's user's guide for instructions) when [Activate Wi-Fi Direct on other device. Then Press [OK].] appears. Press [OK] on your Brother machine. This will start the Wi-Fi Direct setup.
4. Do one of the following:
 - When your Brother machine is the G/O (Group Owner), it will wait for a connection request from your mobile device. When [PIN Code] appears, enter the PIN displayed on your mobile device in the machine. Press [OK]. Follow the instructions and go to next step.
If the PIN is displayed on your Brother machine, enter the PIN in your mobile device.
 - When your Brother machine is not the G/O, it will display available device names with which to configure a Wi-Fi Direct network. Select the mobile device to which you want to connect and press [OK]. Search for available devices again by pressing [Rescan].
Do one of the following:
 - Press [Display PIN Code] to display the PIN on your machine and enter the PIN in your mobile device. Follow the instructions, and then go to next step.
 - Press [Input PIN Code] to enter a PIN shown on your mobile device in the machine, and then press [OK]. Follow the instructions, and then go to next step.If your mobile device does not display a PIN, press  on your Brother machine. Go back to step 1 and try again.
5. If your mobile device connects successfully, the machine displays [Connected]. You have completed the Wi-Fi Direct network setup. For more information on printing from or scanning to your mobile device, download the *Mobile Print/Scan Guide for Brother iPrint&Scan* or the *AirPrint Guide* from your model's **Manuals** page on the Brother Solutions Center at support.brother.com.



Related Information

- [Configure Your Wi-Fi Direct Network](#)
- [Wi-Fi Direct Network Configuration Overview](#)

Configure Your Wi-Fi Direct Network Using the PIN Method of Wi-Fi Protected Setup™ (WPS)

If your mobile device supports the PIN Method of Wi-Fi Protected Setup™ (WPS), follow these steps to configure a Wi-Fi Direct network:



When the machine receives the Wi-Fi Direct request from your mobile device, the message [Wi-Fi Direct connection request received. Press [OK] to connect.] will appear on the LCD. Press [OK] to connect.

1. Press  [Settings] > [All Settings] > [Network] > [Wi-Fi Direct] > [Group Owner] > [On] > [PIN Code].
2. When [Wi-Fi Direct On?] appears, press [On] to accept. To cancel, press [Off].
3. When [Activate Wi-Fi Direct on other device. Then Press [OK].] is displayed, activate your mobile device's WPS PIN configuration method (see your mobile device's user's guide for instructions), and then press [OK] on your Brother machine. This will start the Wi-Fi Direct setup.
4. The machine will wait for a connection request from your mobile device. When [PIN Code] appears, enter the PIN displayed on your mobile device in the machine. Press [OK].
5. If your mobile device connects successfully, the machine displays [Connected]. You have completed the Wi-Fi Direct network setup. For more information on printing from or scanning to your mobile device, download the *Mobile Print/Scan Guide for Brother iPrint&Scan* or the *AirPrint Guide* from your model's **Manuals** page on the Brother Solutions Center at support.brother.com.



Related Information

- [Configure Your Wi-Fi Direct Network](#)
- [Wi-Fi Direct Network Configuration Overview](#)

Configure Your Wi-Fi Direct Network Manually

If your mobile device does not support Wi-Fi Direct or WPS, you must configure a Wi-Fi Direct network manually.

1. Press  [Settings] > [All Settings] > [Network] > [Wi-Fi Direct] > [Manual].
2. When [Wi-Fi Direct On?] appears, press [On] to accept. To cancel, press [Off].
3. The machine will display the SSID name and Password. Go to your mobile device's wireless network settings screen and enter the SSID name and password.
4. If your mobile device connects successfully, the machine displays [Connected]. You have completed the Wi-Fi Direct network setup. For more information on printing from or scanning to your mobile device, download the *Mobile Print/Scan Guide for Brother iPrint&Scan* or the *AirPrint Guide* from your model's **Manuals** page on the Brother Solutions Center at support.brother.com.



Related Information

- [Configure Your Wi-Fi Direct Network](#)
- [Wi-Fi Direct Network Configuration Overview](#)

Advanced Network Features

- [Print the Network Configuration Report](#)

Print the Network Configuration Report

The Network Configuration Report lists the network configuration, including the network print server settings.



- **Node Name:** The Node Name appears on the current Network Configuration Report. The default Node Name is "BRNxxxxxxxxxxx" for a wired network or "BRWxxxxxxxxxxx" for a wireless network (where "xxxxxxxxxxx" is your machine's MAC Address / Ethernet Address.)
- If the [IP Address] on the Network Configuration Report shows 0.0.0.0, wait for one minute and try printing it again.
- You can find your machine's settings, such as the IP address, subnet mask, node name, and MAC Address on the report, for example:
 - IP address: 192.168.0.5
 - Subnet mask: 255.255.255.0
 - Node name: BRN000ca0000499
 - MAC Address: 00-0c-a0-00-04-99

1. Press  [Settings] > [All Settings] > [Print Reports] > [Network Configuration] > [OK].

The machine prints the current Network Configuration Report.



Related Information

- [Advanced Network Features](#)
- [Copy Photos from Media Over a Network Connection](#)
- [Where Can I Find My Brother Machine's Network Settings?](#)
- [Use the Network Connection Repair Tool \(Windows®\)](#)
- [I Want to Check that My Network Devices are Working Correctly](#)
- [Error and Maintenance Messages](#)

Technical Information for Advanced Users

- [Reset the Network Settings to Factory Default](#)
- [Print the WLAN Report](#)

Reset the Network Settings to Factory Default

You can use your machine's control panel to reset the print server to its default factory settings. This resets all information, such as the password and IP address.



- This feature restores all wired (supported models only) and wireless network settings to the factory settings.
- You can also reset the print server to its factory default settings using BRAdmin Light or BRAdmin Professional.

1. Press  [Settings] > [All Settings] > [Network] > [Network Reset].
2. [Reset Network?] will be displayed. Press [Yes].
3. [Reboot OK?] will be displayed. Press [Yes] for two seconds to confirm.

The machine will restart.



Related Information

- [Technical Information for Advanced Users](#)
- [Transfer Your Faxes or Fax Journal Report](#)

Print the WLAN Report

The WLAN Report reflects your machine's wireless status. If the wireless connection fails, check the error code on the printed report.

1. Press  [Settings] > [All Settings] > [Print Reports] > [WLAN Report] > [OK].

The machine will print the WLAN Report.

If the WLAN Report does not print, check your machine for errors. If there are no visible errors, wait for one minute and then try to print the report again.

Related Information

- [Technical Information for Advanced Users](#)
- [Wireless LAN Report Error Codes](#)
- [My Brother Machine Cannot Print, Scan, or PC-FAX Receive over the Network](#)
- [I Want to Check that My Network Devices are Working Correctly](#)

Wireless LAN Report Error Codes

If the Wireless LAN Report shows that the connection failed, check the error code on the printed report and see the corresponding instructions in the table:

Error Code	Problem and Recommended Solutions
TS-01	<p>The wireless setting is not activated, change the wireless setting to ON.</p> <p>If a network cable is connected to your machine, disconnect it and change the wireless setting of your machine to ON.</p>
TS-02	<p>The wireless access point/router cannot be detected.</p> <ol style="list-style-type: none"> Check the following two points: <ul style="list-style-type: none"> Unplug the power to your wireless access point/router, wait for 10 seconds, and then plug it back in. If your WLAN access point/router is using MAC address filtering, confirm that the MAC address of the Brother machine is allowed in the filter. If you manually entered the SSID and security information (SSID/authentication method/encryption method/Network Key), the information may be incorrect. Reconfirm the SSID and security information and re-enter the correct information if needed.
TS-04	<p>The Authentication/Encryption methods used by the selected wireless access point/router are not supported by your machine.</p> <p>For infrastructure mode, change the authentication and encryption methods of the wireless access point/router. Your machine supports the following authentication methods:</p> <ul style="list-style-type: none"> WPA-Personal TKIP or AES WPA2-Personal AES Open WEP or None (without encryption) Shared key WEP <p>If your problem is not solved, the SSID or network settings you entered may be incorrect. Confirm the wireless network settings.</p> <p>For Ad-Hoc Mode, change the authentication and encryption methods of your computer for the wireless setting. Your machine supports Open authentication only, with optional WEP encryption.</p>
TS-05	<p>The security information (SSID/Network Key) is incorrect.</p> <p>Confirm the SSID and Network Key. If your router uses WEP encryption, enter the key used as the first WEP key. Your Brother machine supports the use of the first WEP key only.</p>
TS-06	<p>The wireless security information (Authentication method/Encryption method/Network Key) is incorrect.</p> <p>Confirm the wireless security information (Authentication method/Encryption method/Network Key) listed in TS-04. If your router uses WEP encryption, enter the key used as the first WEP key. Your Brother machine supports the use of the first WEP key only.</p>
TS-07	<p>The machine cannot detect a wireless access point/router that has WPS or AOSS™ enabled.</p> <p>If you would like to configure your wireless settings using WPS or AOSS™, you must operate both your machine and the wireless access point/router. Confirm that your wireless access point/router supports WPS or AOSS™ and try starting again.</p> <p>If you do not know how to operate your wireless access point/router using WPS or AOSS™, see the documentation provided with your wireless access point/router, ask the manufacturer of your wireless access point/router, or ask your network administrator.</p>

Error Code	Problem and Recommended Solutions
TS-08	<p>Two or more wireless access points that have WPS or AOSS™ enabled are detected.</p> <ul style="list-style-type: none">• Confirm that only one wireless access point/router within range has the WPS or AOSS™ method active and try again.• Try starting again after a few minutes to avoid interference from other access points.



Related Information

- [Print the WLAN Report](#)
 - [My Brother Machine Cannot Print, Scan, or PC-FAX Receive over the Network](#)
 - [I Want to Check that My Network Devices are Working Correctly](#)
 - [Configure Your Machine for a Wireless Network in Ad-Hoc Mode Using a New SSID](#)
-

Security

- [Lock the Machine Settings](#)

Lock the Machine Settings

Before turning on the machine's access lock feature, make a careful note of your password. If you forget the password, you must reset all passwords stored in the machine by calling your administrator or Brother customer service.

- [About Using Memory Security](#)

About Using Memory Security

Related Models: MFC-J985DW

Memory Security lets you prevent unauthorised access to the machine.

Although you cannot schedule Delayed Faxes or Polling jobs, any pre-scheduled Delayed Faxes will be sent.



You must turn off PC Fax Receive before you can turn on Memory Security.

While Memory Security is On, the following operations are available:

- Receiving faxes into memory (limited by memory capacity)
- Fax Forwarding (if Fax Forwarding was already On)
- Remote Retrieval (if Fax Storage was already On)

While Memory Security is On, the following operations are NOT available:

- Operation from the control panel
- Printing received faxes
- PC printing
- PC Fax Receive
- Printing with NFC
- Scanning with NFC



To print the faxes in memory, you must turn off Memory Security.





Related Information

- [Lock the Machine Settings](#)
- [Set the Memory Security Password](#)
- [Change the Memory Security Password](#)
- [Turn Memory Security On/Off](#)

Set the Memory Security Password

Related Models: MFC-J985DW

Make a careful note of your password.



1. Press  [Settings] > [All Settings] > [Fax] > [Miscellaneous] > [Memory Security].
2. Enter a four-digit number for the password using the touchscreen. Press [OK].
3. When the touchscreen displays [Verify], re-enter the password using the touchscreen. Press [OK].
4. Press .

Related Information

- [About Using Memory Security](#)

Change the Memory Security Password

Related Models: MFC-J985DW

1. Press  [Settings] > [All Settings] > [Fax] > [Miscellaneous] > [Memory Security] > [Set Password].
2. Enter the registered four-digit number for the current password using the touchscreen. Press [OK].
3. Enter a four-digit number for a new password using the touchscreen. Press [OK].
4. When the touchscreen displays [Verify], re-enter the new password using the touchscreen. Press [OK].
5. Press .

Related Information

- [About Using Memory Security](#)

Turn Memory Security On/Off

Related Models: MFC-J985DW

1. Press  [Settings] > [All Settings] > [Fax] > [Miscellaneous] > [Memory Security] > [Set Security].
2. Enter the registered four-digit password using the keyboard on the touchscreen. Press [OK].
The machine goes offline and the touchscreen displays [Memory Security].



Turning off Memory Security:

- a. Press [Unlock].
- b. Enter the current four-digit password, and then press [OK].
If you enter the wrong password, the touchscreen displays [Wrong Password] and stays offline. The machine will stay in Secure Mode until the correct password is entered.



Related Information

- [About Using Memory Security](#)

Mobile/Web Connect

- [Use Web Services from Your Brother Machine](#)
- [Use Brother Web Services](#)
- [Print with Google Cloud Print™](#)
- [Print with AirPrint](#)
- [Print with Mopria®](#)
- [Print and Scan from a Mobile Device](#)
- [Print and Scan Using Near-Field Communication \(NFC\)](#)

Use Web Services from Your Brother Machine

Certain websites provide services that allow users to upload and view images and files on the website. Your Brother machine can scan images and upload them to these services, and also download from and print images that are already uploaded to these services.

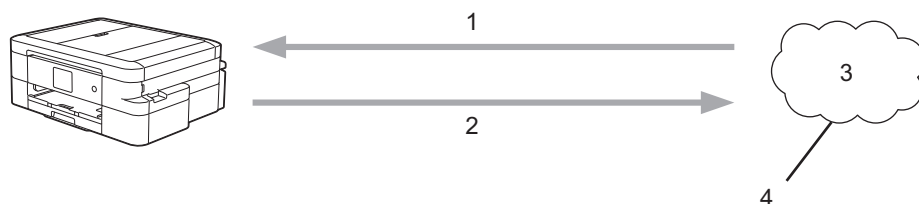

1. Printing
2. Scanning
3. Photos, images, documents and other files
4. Web Service

The following services can be accessed from your Brother machine: Picasa Web Albums™, Google Drive™, Flickr®, Facebook, Evernote®, Dropbox, OneNote®, OneDrive® and Box.

For more detailed information, see the *Web Connect Guide*. Go to your model's **Manuals** page on the Brother Solutions Center at support.brother.com to download the guide.



Related Information

- [Mobile/Web Connect](#)

Use Brother Web Services

Brother Web Services allow you to scan, print, and perform other features that help you save files to the Cloud, upload to other services. Brother Web Services also manage cloud servers, so you can transfer received faxes.

- Outline and Scan

Use a red pen to outline sections of your document, and then scan the document. The red outlined areas are captured and processed based on your settings: save the areas to media or to a cloud service.

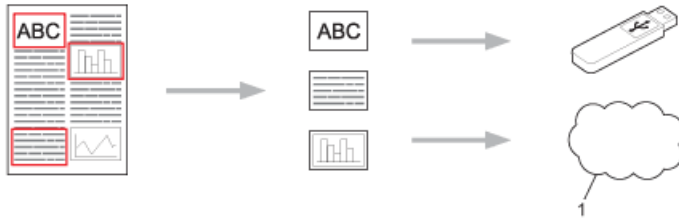

1. Web Service

- Copy Outlined Area

Use a red pen to outline sections of your document, and then scan the document. The red outlined areas are extracted and printed together.

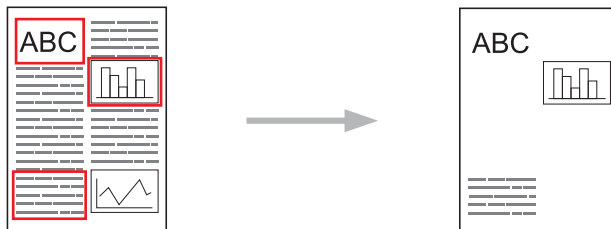

- Cut Outlined Area

Use a red pen to outline sections of your document, and then scan the document. The red outlined areas are deleted and the remaining information is printed.

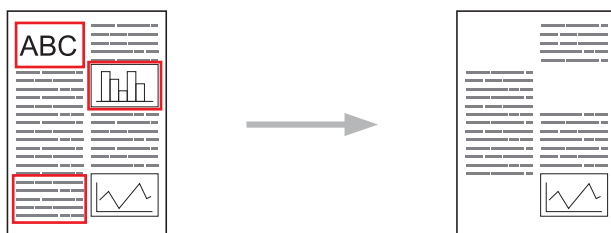

- NotePrint and NoteScan

Print different types of note sheets and folders designed to hold them. After taking notes, scan the note sheets and save them to media or a cloud service.

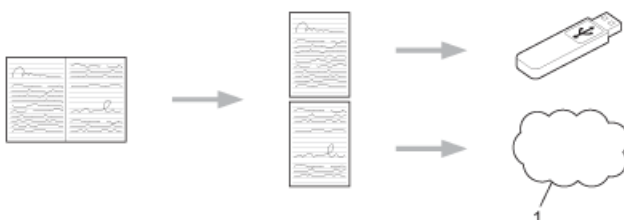

1. Web Service

For more detailed information, see the *Web Connect Guide*. Go to your model's **Manuals** page on the Brother Solutions Center at support.brother.com to download the guide.



Related Information

- [Mobile/Web Connect](#)
-

Print with Google Cloud Print™

Google Cloud Print™ is a Google-provided service that allows you to print to a printer registered to your Google account using a network-compatible device (such as a mobile phone or computer) without installing the printer driver on the device.

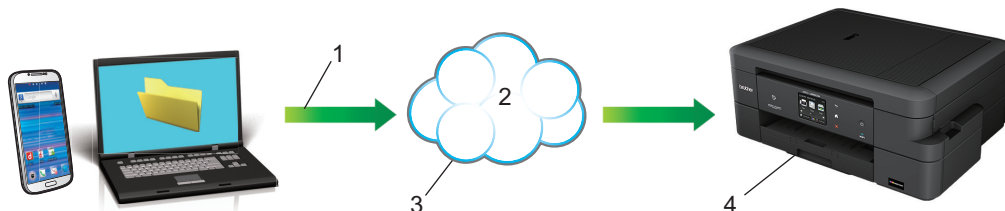

1. Print request
2. Internet
3. Google Cloud Print™
4. Printing

For more detailed information, see the *Google Cloud Print Guide*. Go to your model's **Manuals** page on the Brother Solutions Center at support.brother.com to download the guide.



Related Information

- [Mobile/Web Connect](#)

Print with AirPrint

Use Brother AirPrint to wirelessly print photos, emails, web pages, and documents from your iPad, iPhone and iPod touch without installing a printer driver on the device.



1. Print request
 2. Printed photos, emails, web pages, and documents
- AirPrint also lets you send faxes directly from your Mac computer without printing them.

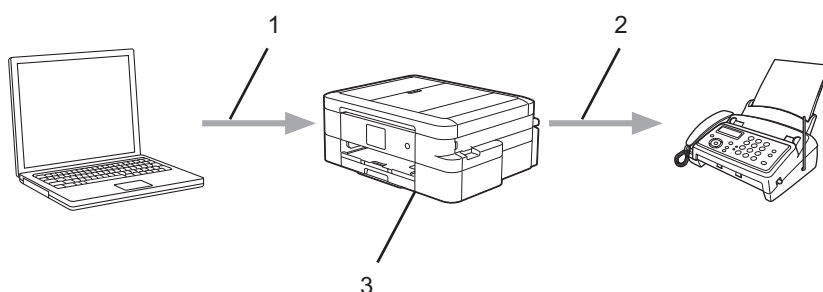

1. Wired or wireless network
 2. Telephone line
 3. Your Brother machine
- AirPrint also lets you scan documents to your Mac computer without installing a driver on the device (requires OS X 10.9 or later).

For more detailed information, see the *AirPrint Guide*. Go to your model's **Manuals** page on the Brother Solutions Center at support.brother.com to download the guide.

✓ Related Information

- [Mobile/Web Connect](#)

Print with Mopria®

Mopria® Print Service is a print feature on Android™ phones or tablets (Android™ version 4.4 or later) developed by the Mopria® Alliance. With this service, you can connect to the same network as the printer and print without additional setup. Many native Android™ apps, including Google Chrome™, Gmail™ and Gallery, support printing.



1. Android™ 4.4 or later
2. Wi-Fi® Connection
3. Your Brother machine

You must download the Mopria® Plug-in from the Google Play™ Store app and install it on your Android™ device. Before using this service, you must turn it on.



Related Information

- [Mobile/Web Connect](#)

Print and Scan from a Mobile Device

Use Brother iPrint&Scan to print and scan from various mobile devices.

- For Android™ Devices

Brother iPrint&Scan allows you to use features of your Brother machine directly from your Android™ device, without using a computer.

Download and install Brother iPrint&Scan from the Google Play™ Store app.

- For iOS Devices

Brother iPrint&Scan allows you to use features of your Brother machine directly from your iPhone, iPod touch, iPad, and iPad mini.

Download and install Brother iPrint&Scan from the App Store.

- For Windows Phone® Devices

Brother iPrint&Scan allows you to use features of your Brother machine directly from your Windows Phone®, without using a computer.

Download and install Brother iPrint&Scan from the Windows Phone® Store (Windows Phone® Marketplace).

For more detailed information, see the *Mobile Print/Scan Guide for Brother iPrint&Scan*. Go to your model's **Manuals** page on the Brother Solutions Center at support.brother.com to download the guide.



Related Information

- [Mobile/Web Connect](#)

Print and Scan Using Near-Field Communication (NFC)

Related Models: MFC-J985DW

Near-Field Communication (NFC) allows for simple transactions, data exchange and wireless connections between two devices that are close to each other.

If your Android™ device is NFC-enabled, you can print data (photos, PDF files, text files, web pages and email messages) from the device or scan photos and documents to the device by touching it to the NFC logo on the machine's control panel.

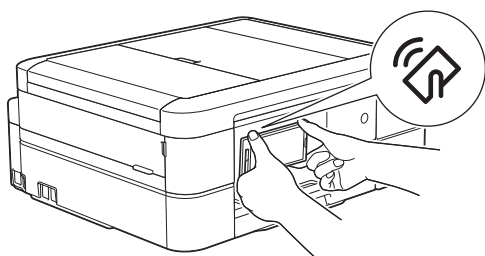

You must download and install Brother iPrint&Scan to your Android™ device to use this feature. For more detailed information, see the *Mobile Print/Scan Guide for Brother iPrint&Scan*. Go to your model's **Manuals** page on the Brother Solutions Center at support.brother.com to download the guide.



Related Information

- [Mobile/Web Connect](#)
- [Control Panel Overview](#)

ControlCenter

Use Brother's ControlCenter software utility to quickly access your frequently-used applications. Using ControlCenter gives you direct access to specific applications.

- [ControlCenter4 \(Windows®\)](#)
- [ControlCenter2 \(Mac\)](#)

ControlCenter4 (Windows®)

- [Change the Operation Mode in ControlCenter4 \(Windows®\)](#)
- [Scan Using ControlCenter4 Home Mode \(Windows®\)](#)
- [Scan Using ControlCenter4 Advanced Mode \(Windows®\)](#)
- [Set Up the Brother Machine Using ControlCenter4 \(Windows®\)](#)
- [Create a Custom Tab Using ControlCenter4 Advanced Mode \(Windows®\)](#)
- [Set Up the Brother Machine from Your Computer \(Windows®\)](#)
- [Set Up Your Brother Address Book Using ControlCenter4 \(Windows®\)](#)

Change the Operation Mode in ControlCenter4 (Windows®)

ControlCenter4 has two operation modes: **Home Mode** and **Advanced Mode**. You can change modes at any time.

Home Mode

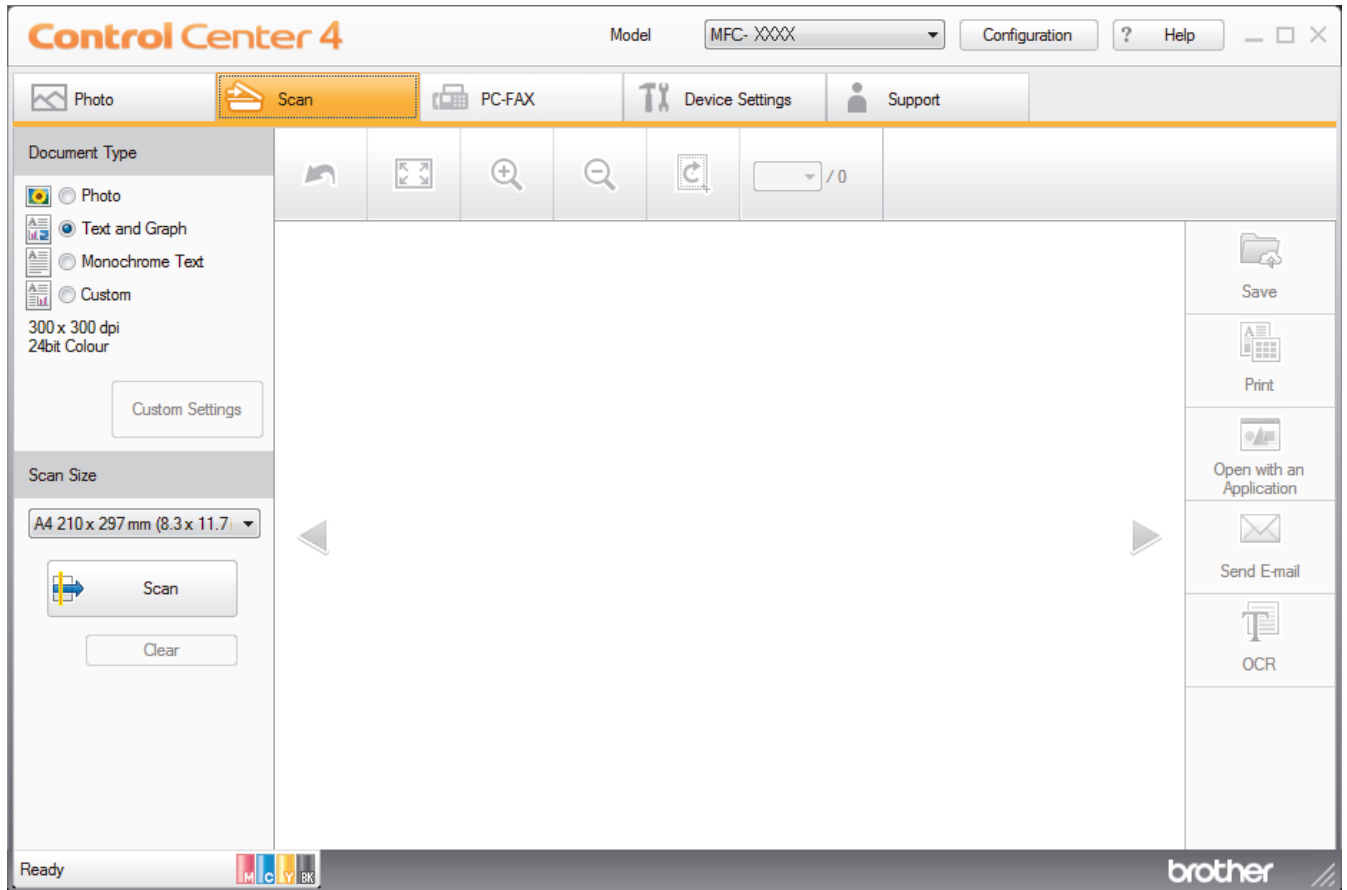

Advanced Mode



- **Home Mode**

ControlCenter4 Home Mode lets you access your machine's main features easily.

- **Advanced Mode**

ControlCenter4 Advanced Mode gives you more control over the details of your machine's features and allows you to customise one-button scan actions.

To change operation mode:

1. Click the  (**ControlCenter4**) icon in the task tray, and then select **Open**.
2. Click the **Configuration** button, and then select **Mode Select**.
3. The mode selection dialog box appears. Select either the **Home Mode** or **Advanced Mode** option.

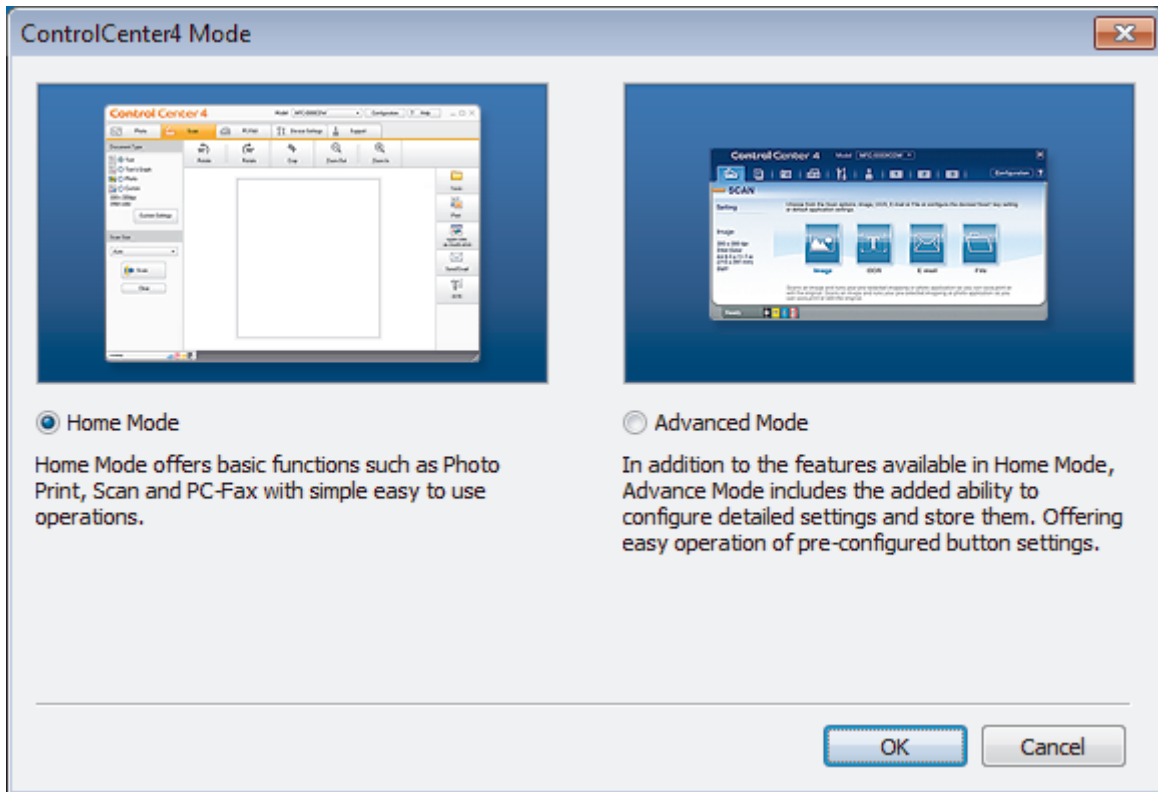

4. Click **OK**.

Related Information

- [ControlCenter4 \(Windows®\)](#)
- [Scan Using ControlCenter4 Home Mode \(Windows®\)](#)
- [Scan Using ControlCenter4 Advanced Mode \(Windows®\)](#)

Scan Using ControlCenter4 Home Mode (Windows®)

Use ControlCenter4 Home Mode to access your machine's main features.

- [Scan Using ControlCenter4 Home Mode \(Windows®\)](#)
- [Save Scanned Data to a Folder as a PDF File Using ControlCenter4 Home Mode \(Windows®\)](#)
- [Scan Settings for ControlCenter4 Home Mode \(Windows®\)](#)
- [Change the Operation Mode in ControlCenter4 \(Windows®\)](#)

Scan Using ControlCenter4 Advanced Mode (Windows®)

ControlCenter4 Advanced Mode gives you more control over the details of your machine's features and allows you to customise one-button scan actions.

- [Scan Photos and Graphics Using ControlCenter4 Advanced Mode \(Windows®\)](#)
- [Save Scanned Data to a Folder as a PDF File Using ControlCenter4 Advanced Mode \(Windows®\)](#)
- [Scan Both Sides of an ID Card Using ControlCenter4 Advanced Mode \(Windows®\)](#)
- [Scan to E-mail Attachment Using ControlCenter4 Advanced Mode \(Windows®\)](#)
- [Scan to an Editable Text File \(OCR\) Using ControlCenter4 Advanced Mode \(Windows®\)](#)
- [Scan to an Office File Using ControlCenter4 Advanced Mode \(Windows®\)](#)
- [Scan Settings for ControlCenter4 Advanced Mode \(Windows®\)](#)
- [Change the Operation Mode in ControlCenter4 \(Windows®\)](#)

Set Up the Brother Machine Using ControlCenter4 (Windows®)

Related Models: MFC-J985DW

1. Click the  (ControlCenter4) icon in the task tray, and then click **Open**.
2. Click the **Device Settings** tab.
3. Click the **Remote Setup** button.
4. Configure the settings as needed.

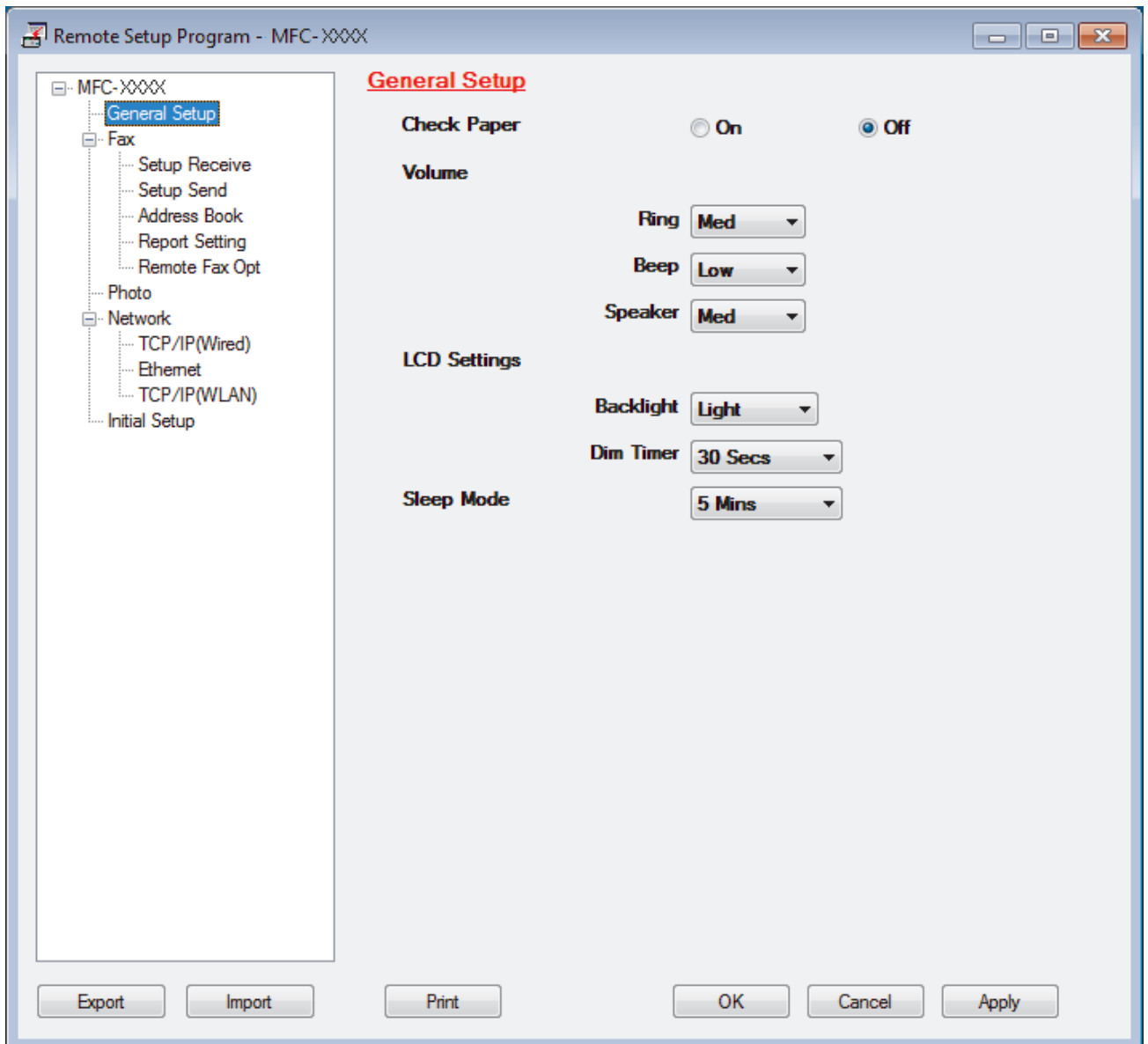

Export

Click to save the current configuration settings to a file.



Click **Export** to save your address book or all settings for your machine.

Import

Click to read the settings from a file.

Print

Click to print the selected items on the machine. You cannot print the data until it is uploaded to the machine. Click **Apply** to upload the new data to the machine, and then click **Print**.

OK

Click to start uploading data to the machine, and then exit the Remote Setup Program. If an error message appears, confirm that your data is correct, and then click **OK**.

Cancel

Click to exit the Remote Setup Program without uploading data to the machine.

Apply

Click to upload data to the machine without exiting the Remote Setup Program.

5. Click **OK**.

- If your computer is protected by a firewall and is unable to use Remote Setup, you may need to configure the firewall settings to allow communication through port numbers 137 and 161.
- If you are using Windows® Firewall and you installed the Brother software and drivers from the CD-ROM, the necessary firewall settings have already been set.

**Related Information**

- [ControlCenter4 \(Windows®\)](#)
- [Remote Setup \(Windows®\)](#)

Create a Custom Tab Using ControlCenter4 Advanced Mode (Windows®)

You can create up to three customised tabs, each including up to five customised buttons, with your preferred settings.

Select **Advanced Mode** as the mode setting for ControlCenter4.

1. Click the  (**ControlCenter4**) icon in the task tray, and then click **Open**.
2. Click the **Configuration** button, and then select **Create custom tab**.
A custom tab is created.
3. To change the name of a custom tab, right-click the custom tab, and then select **Rename custom tab**.
4. Click the **Configuration** button, select **Create custom button**, and then select the button you want to create.
The settings dialog box appears.
5. Type the button name, and then change the settings, if needed. Click **OK**.

The setting options vary depending on the button you select.

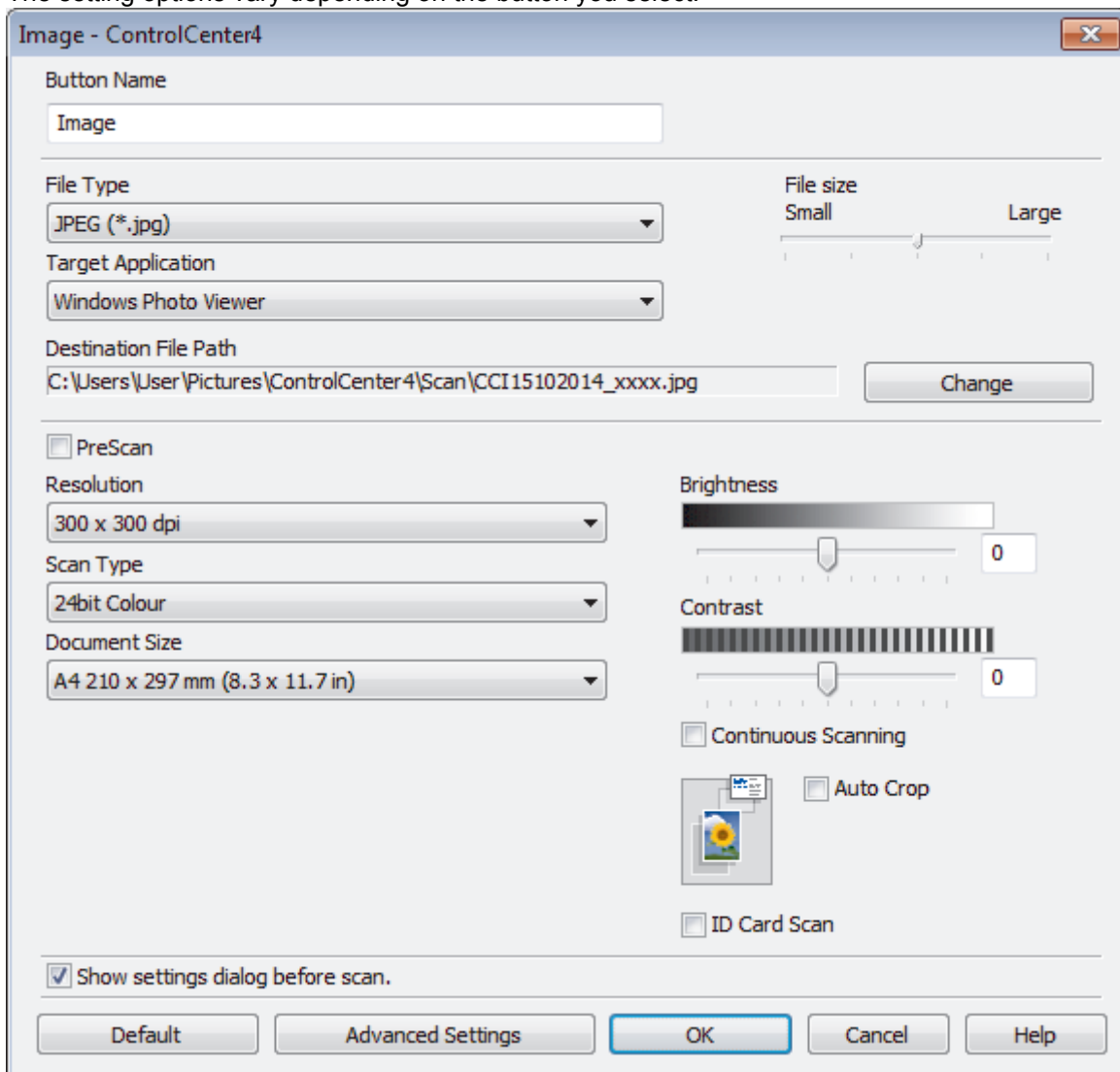

 You can change or remove the created tab, button, or settings. Click the **Configuration** button, and then follow the menu.



Related Information

- [ControlCenter4 \(Windows®\)](#)

ControlCenter2 (Mac)

- [Scan Using ControlCenter2 \(Mac\)](#)
- [Set Up the Brother Machine Using ControlCenter2 \(Mac\)](#)
- [Turn the AutoLoad Feature On \(Mac\)](#)
- [Set Up Your Brother Address Book Using ControlCenter2 \(Mac\)](#)

Scan Using ControlCenter2 (Mac)

Use Brother's ControlCenter software to scan photos and save them as JPEGs, PDFs, or other file formats.

- [Scan Using ControlCenter2 \(Mac\)](#)
- [Save Scanned Data to a Folder as a PDF File Using ControlCenter2 \(Mac\)](#)
- [Scan Both Sides of an ID Card Using ControlCenter2 \(Mac\)](#)
- [Scan to E-mail Attachment Using ControlCenter2 \(Mac\)](#)
- [Scan to an Editable Text File \(OCR\) Using ControlCenter2 \(Mac\)](#)
- [Scan to an Office File Using ControlCenter2 \(Mac\)](#)
- [Scan Settings for ControlCenter2 \(Mac\)](#)

Set Up the Brother Machine Using ControlCenter2 (Mac)

Related Models: MFC-J985DW

1. In the **Finder** menu bar, click **Go > Applications > Brother**, and then double-click the  (**ControlCenter**) icon.

The **ControlCenter2** screen appears.

2. Click the **DEVICE SETTINGS** tab.
3. Click the **Remote Setup** button.

The Remote Setup Program screen appears.

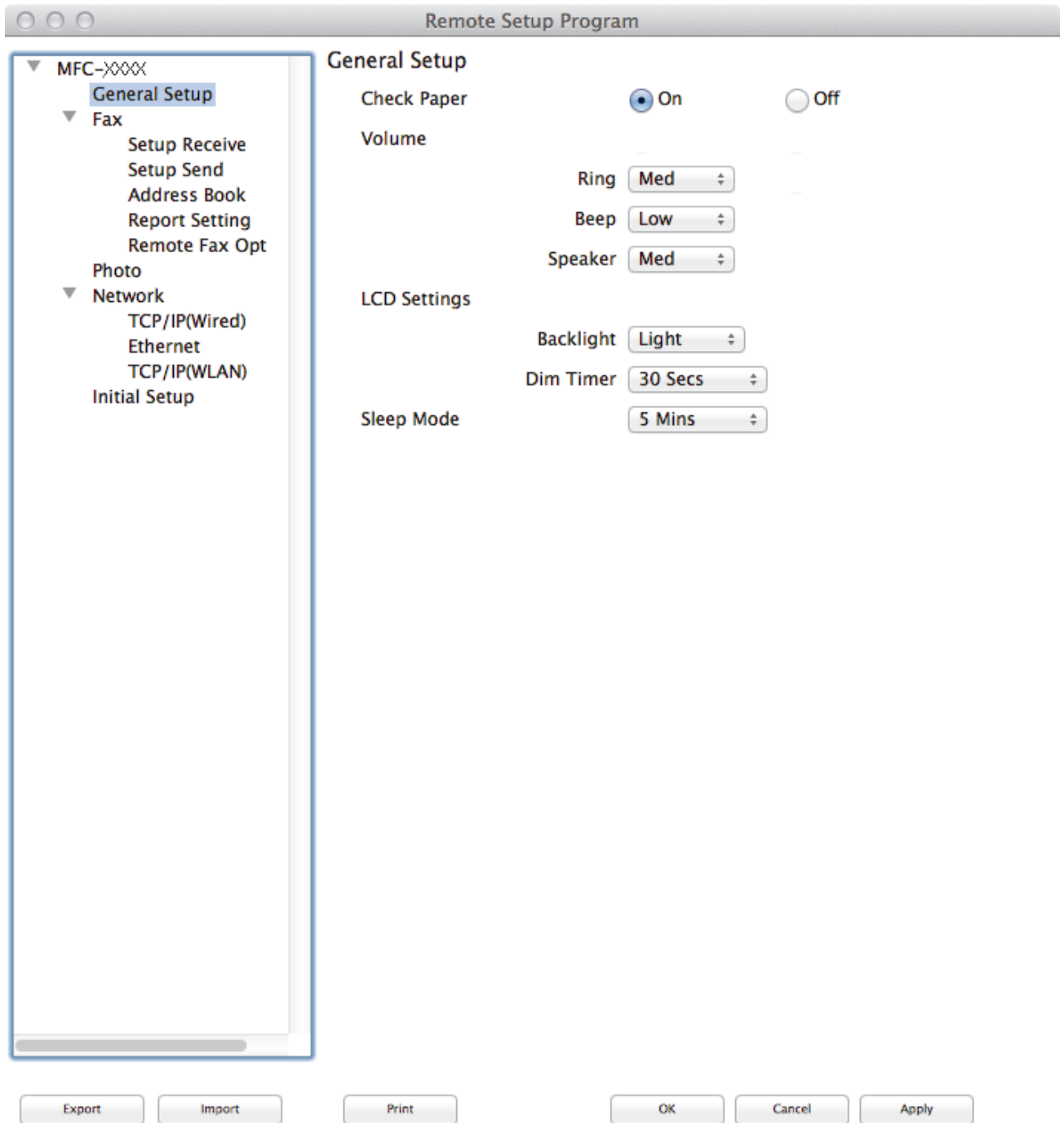

4. Configure the settings as needed.



Export

Click to save the current configuration settings to a file.



Click **Export** to save your address book or all settings for your machine.

Import

Click to read the settings from a file.

Print

Click to print the selected items on the machine. You cannot print the data until it is uploaded to the machine. Click **Apply** to upload the new data to the machine, and then click **Print**.

OK

Click to start uploading data to the machine, and then exit the Remote Setup Program. If an error message appears, enter the correct data again, and then click **OK**.

Cancel

Click to exit the Remote Setup Program without uploading data to the machine.

Apply

Click to upload data to the machine without exiting the Remote Setup Program.

5. When finished, click **OK**.



Related Information

- [ControlCenter2 \(Mac\)](#)
 - [Remote Setup \(Mac\)](#)
-

Turn the AutoLoad Feature On (Mac)

Turn AutoLoad on to launch ControlCenter2 automatically each time you start your Mac.

1. In the **Finder** menu bar, click **Go > Applications > Brother**, and then double-click the  **(ControlCenter)** icon.

The **ControlCenter2** screen appears.

2. Click the **Configuration** button, and then select **Preferences**.
3. Select the **Start ControlCenter on computer startup** check box.
4. Click **OK**.



Related Information

- [ControlCenter2 \(Mac\)](#)
-

Troubleshooting

If you think there is a problem with your machine, first check each of the items below, then try to identify the problem, and follow our troubleshooting tips.

You can correct most problems yourself. If you need additional help, the Brother Solutions Center offers the latest FAQs and troubleshooting tips.

Visit us at support.brother.com.

Click **FAQs & Troubleshooting** and search for your model name.

First, check the following:

- The machine's power cord is connected correctly and the machine's power is on.
- All of the machine's orange protective parts have been removed.
- The ink cartridges are installed correctly.
- The Scanner Cover and the Jam Clear Cover are fully closed.
- Paper is inserted correctly in the paper tray.
- The interface cables are securely connected to the machine and the computer, or the wireless connection is set up on both the machine and your computer.
- (For network models) The access point (for wireless), router, or hub is turned on and its link button is blinking.
- The machine's LCD is displaying messages.

If you did not solve the problem with the checks, identify the problem and then see *Related Information*.



Related Information

- [Error and Maintenance Messages](#)
- [Document Jams](#)
- [Printer Jam or Paper Jam](#)
- [If You Are Having Difficulty with Your Machine](#)
- [Check the Machine Information](#)
- [Reset Your Brother Machine](#)
- [Paper Handling and Printing Problems](#)
- [Telephone and Fax problems](#)
- [Other Problems](#)
- [Network Problems](#)

Error and Maintenance Messages

As with any sophisticated office product, errors may occur and supply items may have to be replaced. If this happens, your machine identifies the error or required routine maintenance and shows the appropriate message. The most common error and maintenance messages are shown in the table.

You can correct most errors and perform routine maintenance yourself. If you need more tips, go to your model's [FAQs & Troubleshooting](#) page on the Brother Solutions Center at support.brother.com.



- (MFC-J985DW)



If the Touchscreen displays errors and your Android™ device supports the NFC feature, touch your device to the NFC logo on the control panel to access the Brother Solutions Center and browse the latest FAQs from your device. (Your mobile telephone provider's message and data rates may apply.)

Make sure the NFC settings of both your Brother machine and your Android™ device are set to On.

- *Related Information* references are at the bottom of this page.

Error Message	Cause	Action
A device is already connected. Press [OK]. (Wi-Fi Direct)	Two mobile devices are already connected to the Wi-Fi Direct network when the Brother machine is the Group Owner (G/O).	After the current connection between your Brother machine and another mobile device has shut down, try to configure the Wi-Fi Direct settings again. You can confirm the connection status by printing the Network Configuration Report.
B&W 1-sided Print Only Replace ink.	<p>One or more of the colour ink cartridges have reached the end of their lives.</p> <p>You can use the machine in monochrome mode for approximately four weeks depending on the number of pages you print.</p> <p>While this message appears on the touchscreen, each operation works in the following way:</p> <ul style="list-style-type: none"> • Printing If the media type is set to Plain Paper in the Basic tab, and Greyscale is selected in the Advanced tab of the printer driver, you can use the machine as a monochrome printer. 2-sided print is not available when this message appears. • Copying If the paper type is set to Plain Paper, you can make copies in monochrome. 2-sided copy is not available when this message appears. • Faxing If the paper type is set to Plain Paper or Inkjet Paper, the machine will receive and print the faxes in monochrome. If a sending machine has a colour fax, the machine's "handshake" will ask that the fax be sent as monochrome. 	<p>Replace the ink cartridges.</p> <p>See <i>Related Information: Replace the Ink Cartridges</i>.</p> <p>Although the Cause column lists options for using the machine after this error appears, you will not be able to use the machine until you replace the ink cartridges under the following conditions:</p> <ul style="list-style-type: none"> • If you unplug the machine or take out the ink cartridge. • (Windows®) If you select Slow Drying Paper in the Basic tab of the printer driver. • (Mac) If you select Slow Drying Paper in the Print Settings drop-down list of the printer driver.

Error Message	Cause	Action
BT Call Sign On (U.K. only)	BT Call Sign is set to On. You cannot change the Receive Mode from Manual to another mode.	Set BT Call Sign to Off. See <i>Related Information: Enable the Machine to Work with BT Call Sign (with Your External Telephone only)</i> .
Cannot Detect	The machine cannot detect a new ink cartridge because it was installed too quickly.	Take out the new ink cartridge and reinstall it slowly and firmly until it locks into place.
	An ink cartridge is not installed correctly.	See <i>Related Information: Replace the Ink Cartridges</i> .
	A used ink cartridge was reinstalled.	Remove the used ink cartridge and install a new one.
	If you are using non Brother Original ink, the machine may not detect the ink cartridge.	Replace the cartridge with a Brother Original ink cartridge. If the error message remains, contact Brother customer service or your local Brother dealer.
	The ink cartridge must be replaced.	Replace the cartridge with a Brother Original ink cartridge.
	The new ink cartridge has an air bubble.	Slowly turn the ink cartridge so that the ink supply port is pointing downwards, and then reinstall the cartridge.
Cannot Detect Ink Volume	If you are using non Brother Original ink, the machine may not detect the ink volume.	Replace the cartridge with a Brother Original ink cartridge. If the error message remains, contact Brother customer service or your local Brother dealer.
Cannot Print Replace ink.	One or more of the ink cartridges have reached the end of their lives. The machine will stop all print operations. While memory is available, monochrome faxes will be stored in the memory. If a sending machine has a colour fax, the machine's "handshake" will ask that the fax be sent as monochrome. If the sending machine has the ability to convert it, the colour fax will be stored in the memory as a monochrome fax.	Replace the ink cartridges. See <i>Related Information: Replace the Ink Cartridges</i> . <ul style="list-style-type: none"> You can still scan even if the ink is low or needs to be replaced.
Comm. Error	Poor telephone line quality caused a communication error.	Send the fax again or connect the machine to another telephone line. If the problem continues, contact the telephone company and ask them to check your telephone line.
Connection Error (Wi-Fi Direct)	Other devices are trying to connect to the Wi-Fi Direct network at the same time.	Make sure there are no other devices trying to connect to the Wi-Fi Direct network, and then try to configure the Wi-Fi Direct settings again.
Connection Failed	You tried to poll a fax machine that is not in Polled Waiting mode.	Check the other fax machine's polling setup.
Connection Failed (Wi-Fi Direct)	The Brother machine and your mobile device cannot communicate during the Wi-Fi Direct network configuration.	<ul style="list-style-type: none"> Move the mobile device closer to your Brother machine. Move your Brother machine and the mobile device to an obstruction-free area. If you are using the PIN Method of WPS, make sure you have entered the correct PIN.
Cover is Open.	The scanner cover is not locked in the closed position.	Lift the scanner cover and then close it again.

Error Message	Cause	Action
		Make sure the USB or network cable (if used) have been guided correctly through the cable channel and out the back of the machine.
	The ink cartridge cover is not locked in the closed position.	Firmly close the ink cartridge cover until it locks into place.
Data Remaining in Memory	Print data is left in the machine's memory.	Press  . The machine will cancel the job and clear it from the memory. Try to print again.
Disconnected	The other person or other person's fax machine stopped the call.	Try to send or receive again. If calls are stopped repeatedly and you are using a VoIP (Voice over IP) system, try changing the Compatibility to Basic (for VoIP). <i>See Related Information: Telephone Line Interference/VoIP.</i>
Document Jam/too Long	The document was not inserted or fed correctly, or the document scanned from the ADF was too long.	Remove the jammed document, and then press  . Set the document in the ADF correctly. <i>See Related Information: Load Documents in the Automatic Document Feeder (ADF).</i> <i>See Related Information: Document Jams.</i>
High Temperature	The room temperature is too high.	After cooling the room, allow the machine to cool down to room temperature. Try again when the machine has cooled down.
Hub is Unusable.	A hub or USB flash drive with hub has been connected to the USB direct interface.	Hubs, including a USB flash drive with a built-in hub, are not supported. Unplug the device from the USB direct interface.
Image Too Long	The proportions of your photo are irregular so effects could not be added.	Choose a regularly proportioned image.
Image Too Small	The size of your photo is too small to trim.	Choose a larger image.
Ink Absorber Pad Full	The ink absorber box or flushing box is full. These components are periodic maintenance items that may require replacement after a period of time to ensure optimum performance from your Brother machine. Because these components are periodic maintenance items, the replacement is not covered under the warranty. The need to replace these items and the time period before replacement is dependent on the number of purges and flushes required to clean the ink system. These boxes acquire amounts of ink during the different purging and flushing operations. The number of times a machine purges and flushes for cleaning varies depending on different situations. For example, frequently powering the machine on and off will cause numerous cleaning cycles since the machine automatically cleans upon power up. The use of non-Brother ink may cause frequent cleanings because non-Brother	The ink absorber box or flushing box must be replaced. Contact Brother customer service or your local Brother Authorised Service Centre to have your machine serviced. Reasons for cleaning are: 1. The machine automatically cleans itself after you remove the power cord and plug it back in. 2. After a paper jam has been cleared, the machine automatically cleans itself before the next received page is printed. 3. The machine automatically cleans itself after sitting idle for more than 30 days (infrequent use). 4. The machine automatically cleans itself after ink cartridges of the same colour have been replaced 12 times.

Error Message	Cause	Action
	ink could cause poor print quality which is resolved by cleaning. The more cleaning the machine requires, the faster these boxes will fill up. Repairs resulting from the use of non-Brother supplies may not be covered under the stated product warranty.	
Ink Absorber Pad NearFull	The ink absorber box or flushing box is nearly full.	The ink absorber box or flushing box must be replaced soon. Contact Brother customer service or your local Brother dealer.
Ink Low	One or more of the ink cartridges are near the end of their lives. If one of the colour ink cartridges is near the end of its life and someone is sending you a colour fax, your machine's "handshake" will ask that the fax be sent as monochrome. If the sending machine has the ability to convert it, the colour fax will be printed at your machine as a monochrome fax.	Order a new ink cartridge. You can continue printing until the touchscreen displays <code>Cannot Print</code> . <i>See Related Information: Replace the Ink Cartridges.</i> <ul style="list-style-type: none"> You can still scan even if the ink is low or needs to be replaced.
Jam A Inside/Front Repeat Jam A Inside/Front	The paper is jammed in the machine.	Remove the jammed paper. <i>See Related Information: Paper is Jammed Inside and in the Front of the Machine (Jam A Inside/Front).</i> Make sure the paper length guide is set to the correct paper size.
	More than one sheet of paper was placed in the manual feed slot. -OR- Another sheet of paper was placed in the manual feed slot before the touchscreen displayed <code>Where to Place the Paper</code> .	Do not put more than one sheet of paper in the manual feed slot at any time. Wait until the touchscreen displays <code>Where to Place the Paper</code> before you feed the next sheet of paper in the manual feed slot. Remove the jammed paper. <i>See Related Information: Paper is Jammed Inside and in the Front of the Machine (Jam A Inside/Front).</i>
Jam B Front Repeat Jam B Front	The paper is jammed in the machine.	Remove the jammed paper. <i>See Related Information: Paper is Jammed in the Front of the Machine (Jam B Front).</i> Make sure the paper length guide is set to the correct paper size.
Jam C Rear	The paper is jammed in the machine.	Remove the jammed paper. <i>See Related Information: Paper is Jammed in the Back of the Machine (Jam C Rear).</i> Make sure the paper length guide is set to the correct paper size.
	Paper dust has accumulated on the surface of the paper pick-up rollers.	Clean the paper pick-up rollers. <i>See Related Information: Clean the Paper Pick-up Rollers.</i>
Low Temperature	The room temperature is too low.	After warming the room, allow the machine to warm up to room temperature. Try again when the machine has warmed up.

Error Message	Cause	Action
Media card error	Multiple data storage devices were in the machine when it was turned on. The machine can read only one memory card or USB flash drive at a time.	Remove the memory cards or USB flash drives that you are not using.
Media Error	The memory card is either corrupted, incorrectly formatted, or there is a problem with the memory card.	Remove the memory card from the media drive (slot) of the machine and format it correctly.
		Put the card firmly into the slot again to make sure it is in the correct position. If the error remains, check the media drive (slot) of the machine by putting in another memory card that you know is working.
Media is Full.	The memory card or USB flash drive you are using already contains 999 files.	Your machine can only save to your memory card or USB flash drive if it contains fewer than 999 files. Delete unused files and try again.
	The memory card or USB flash drive you are using does not have enough free space to scan the document.	Delete unused files from your memory card or USB flash drive to make some free space, and then try again.
No Caller ID	There is no incoming call history. You did not receive calls or you have not subscribed to the Caller ID service from your telephone company.	To use the Caller ID feature, contact your telephone company. <i>See Related Information: Caller ID.</i>
No Device (Wi-Fi Direct)	When configuring the Wi-Fi Direct network, the Brother machine cannot find your mobile device.	<ul style="list-style-type: none"> • Make sure your machine and mobile device are in the Wi-Fi Direct mode. • Move the mobile device closer to your Brother machine. • Move your Brother machine and the mobile device to an obstruction-free area. • If you are manually configuring the Wi-Fi Direct network, make sure you have entered the correct password. • If your mobile device has a configuration page for how to obtain an IP address, make sure the IP address of your mobile device has been configured via DHCP.
No File	The memory card or USB flash drive in the media drive does not contain a .JPG file.	Put the correct memory card or USB flash drive into the slot again.
No Ink Cartridge	An ink cartridge is not installed correctly.	Remove the new ink cartridge and re-install it slowly and firmly until it locks into place. <i>See Related Information: Replace the Ink Cartridges.</i>
No Paper Fed	The machine is out of paper or paper is not correctly loaded in the paper tray.	Do one of the following: <ul style="list-style-type: none"> • Refill the paper tray, and then follow the on-screen instructions. • Remove and reload the paper, and then follow the on-screen instructions. <i>See Related Information: Load Paper.</i>
	The photo paper tray is in the wrong position.	Return the photo paper tray to the Normal printing position when you use cut sheet paper.

Error Message	Cause	Action
		See <i>Related Information: Load Photo or Photo L Paper in Photo Paper Tray.</i>
	The paper was not inserted in the centre position of the manual feed slot.	Remove the paper and reinsert it in the centre of the manual feed slot, and then follow the on-screen instructions. See <i>Related Information: Load Paper in the Manual Feed Slot.</i>
	The Jam Clear Cover is not closed correctly.	Make sure the Jam Clear Cover is closed evenly at both ends. See <i>Related Information: Printer Jam or Paper Jam.</i>
	Paper dust has accumulated on the surface of the paper pick-up rollers.	Clean the paper pick-up rollers. See <i>Related Information: Clean the Paper Pick-up Rollers.</i>
No Response/Busy	The number you dialled does not answer or is busy.	Verify the number and try again.
Out of Fax Memory	The fax memory is full.	Do one of the following: <ul style="list-style-type: none"> • Clear the data from the memory. To gain extra memory, you can turn off Memory Receive. See <i>Related Information: Turn Off Memory Receive.</i> • Print the faxes that are in the memory. See <i>Related Information: Print a Fax Stored in the Machine's Memory.</i>
Out of Memory	The machine's memory is full.	If a fax-sending or copy operation is in progress: <ul style="list-style-type: none"> • Press  or Quit or Close and wait until the other operations that are in progress finish, and then try again. • Press Send Now to send the pages scanned so far. • Press Partial Print to copy the pages scanned so far. • Clear the data in the memory. To gain extra memory, you can turn Memory Receive off. (MFC models only) See <i>Related Information: Turn Off Memory Receive.</i> • Print the faxes stored in the memory. (MFC models only) See <i>Related Information: Print a Fax Stored in the Machine's Memory.</i>
Paper Size Mismatch	The paper size setting does not match the size of paper in the tray. -OR- You did not set the paper guides in the tray to the indicators for the paper size you are using.	<ol style="list-style-type: none"> 1. Check that the paper size you selected on the machine's display matches the size of the paper in the tray. See <i>Related Information: Change the Paper Size and Paper Type.</i> 2. Make sure you loaded the paper in a Portrait position, by setting the paper guides at the indicators for your paper size. See <i>Related Information: Load Paper.</i>

Error Message	Cause	Action
		<p>3. After you have checked the paper size and the paper position, follow the on-screen instructions.</p> <p>If printing from your computer, make sure the paper size you selected in the printer driver matches the size of paper in the tray.</p> <p>See <i>Related Information: Print Settings (Windows®) or Print Options (Mac)</i>.</p>
Paper Tray not detected	The paper tray is not completely inserted.	Slowly push the paper tray completely into the machine.
	Paper or a foreign object has prevented the paper tray from being inserted correctly.	Pull the paper tray out of the machine, and remove the jammed paper or foreign object. If you cannot find or remove the jammed paper, see <i>Related Information: Printer Jam or Paper Jam</i> .
Repetitive No Paper Fed	Paper dust has accumulated on the surface of the paper pick-up rollers.	Clean the paper pick-up rollers. See <i>Related Information: Clean the Paper Pick-up Rollers</i> .
Touchscreen Init. Failed	The touchscreen was pressed before the power on initialisation was completed.	Make sure nothing is touching or resting on the touchscreen, especially when plugging the machine in.
	Debris may be stuck between the lower part of the touchscreen and its frame.	Insert a piece of stiff paper between the lower part of the touchscreen and its frame and slide it back and forth to push out the debris.
Tray removed	This message is displayed when the setting to confirm the paper type and size is enabled.	To not display this confirmation message, change the setting to Off. See <i>Related Information: Change the Check Paper Size Setting</i> .
Unable to Clean XX Unable to Initialize XX Unable to Print XX	The machine has a mechanical problem. -OR- A foreign object, such as a paper clip or a piece of ripped paper, is in the machine.	<p>Open the scanner cover and remove any foreign objects and paper scraps from inside the machine.</p> <p>See <i>Related Information: Paper is Jammed Inside and in the Front of the Machine (Jam A Inside/Front)</i>.</p> <p>(For MFC Model) If the error message continues:</p> <ul style="list-style-type: none"> MFC models <p>Transfer your faxes to another fax machine or your computer before disconnecting the machine so you will not lose any important messages. Then, disconnect the machine from the power for several minutes and reconnect it.</p> <p>(The machine can be turned off without losing faxes stored in the memory.)</p> <p>See <i>Related Information: Transfer Your Faxes or Fax Journal Report</i>.</p> DCP models <p>Disconnect the machine from the power for several minutes, and then reconnect it.</p>

Error Message	Cause	Action
Unable to Scan XX	The machine has a mechanical problem.	<ul style="list-style-type: none"> Transfer your faxes to another fax machine or your computer before disconnecting the machine so you will not lose any important messages. Then, disconnect the machine from the power for several minutes and reconnect it. <p>(The machine can be turned off without losing faxes stored in the memory.)</p> <p>See <i>Related Information: Transfer Your Faxes or Fax Journal Report.</i></p>
Unusable Device Disconnect device from front connector & turn machine off & then on	A broken device is connected to the USB direct interface.	Unplug the device from the USB direct interface, and then press  to turn the machine off and then on again.
Unusable Device Please disconnect USB device.	A USB device or USB flash drive that is not supported has been connected to the USB direct interface.	Unplug the device from the USB direct interface. Turn the machine off and then on again.
Wrong Ink Cartridge	The ink cartridge model number is not compatible with your machine.	Verify whether the cartridge model number will work with your machine. <i>See Related Information: Supply Specifications.</i>
Wrong Ink Colour	An ink cartridge has been installed in the wrong position.	Check which ink cartridges are not matched by colour to their ink cartridge positions and move them to their correct positions.



Related Information

- [Troubleshooting](#)
- [Transfer Your Faxes or Fax Journal Report](#)
- [LCD Overview](#)
- [Print the Network Configuration Report](#)
- [Replace the Ink Cartridges](#)
- [Supply Specifications](#)
- [Change the Check Paper Size Setting](#)
- [Telephone Line Interference/VoIP](#)
- [Load Documents in the Automatic Document Feeder \(ADF\)](#)
- [Document Jams](#)
- [Enable the Machine to Work with BT Call Sign \(with Your External Telephone only\)](#)
- [Caller ID](#)
- [Load Paper](#)
- [Load Photo or Photo L Paper in Photo Paper Tray](#)
- [Load Paper in the Manual Feed Slot](#)
- [Printer Jam or Paper Jam](#)
- [Clean the Paper Pick-up Rollers](#)
- [Turn Off Memory Receive](#)
- [Print a Fax Stored in the Machine's Memory](#)
- [Paper is Jammed Inside and in the Front of the Machine \(Jam A Inside/Front\)](#)

-
- Paper is Jammed in the Front of the Machine (Jam B Front)
 - Paper is Jammed in the Back of the Machine (Jam C Rear)
 - Change the Paper Size and Paper Type
 - Print Settings (Windows®)
 - Print Options (Mac)
 - Paper Handling and Printing Problems
-

Transfer Your Faxes or Fax Journal Report

Related Models: MFC-J985DW

If the LCD shows:

- [Unable to Clean XX]
- [Unable to Initialize XX]
- [Unable to Print XX]
- [Unable to Scan XX]

We recommend transferring your faxes to another fax machine or to your computer.

See *Related Information: Transfer Faxes to Another Fax Machine*.

See *Related Information: Transfer Faxes to Your Computer*.

You can also transfer the Fax Journal report to see if there are any faxes you must transfer.

See *Related Information: Transfer the Fax Journal Report to Another Fax Machine*.





Related Information

- [Error and Maintenance Messages](#)
- [Transfer Faxes to Another Fax Machine](#)
- [Transfer Faxes to Your Computer](#)
- [Transfer the Fax Journal Report to Another Fax Machine](#)
- [Use PC-Fax Receive to Transfer Received Faxes to Your Computer \(Windows® only\)](#)
- [Reset the Network Settings to Factory Default](#)
- [Reset Your Brother Machine](#)
- [Reset Functions](#)
- [Paper is Jammed Inside and in the Front of the Machine \(Jam A Inside/Front\)](#)
- [Paper is Jammed in the Front of the Machine \(Jam B Front\)](#)
- [Paper is Jammed in the Back of the Machine \(Jam C Rear\)](#)

Transfer Faxes to Another Fax Machine

Related Models: MFC-J985DW

If you have not set up your Station ID, you cannot enter fax transfer mode.

1. Press  to interrupt the error temporarily.
2. Press  [Settings] > [All Settings] > [Service] > [Data Transfer] > [Fax Transfer].
3. Do one of the following:
 - If the touchscreen displays [No Data], there are no faxes left in the machine's memory.
Press [Close], and then press .
 - Enter the fax number where faxes will be forwarded.
4. Press [Fax Start].



Related Information

- [Transfer Your Faxes or Fax Journal Report](#)
- [Set Your Station ID](#)

Transfer Faxes to Your Computer

Related Models: MFC-J985DW

You can transfer the faxes from your machine's memory to your computer.

1. Press  to interrupt the error temporarily.
2. Make sure you have installed the Brother driver on your computer, and then turn on **PC-FAX Receive** on the computer. Do one of the following:

- Windows® XP, Windows Vista® and Windows® 7

From the  (**Start**) menu, select **All Programs > Brother > Brother Utilities**.

Click the drop-down list and select your model name (if not already selected). Click **PC-FAX** in the left navigation bar, and then click **Receive**.

- Windows® 8 and Windows® 10

Launch  (**Brother Utilities**), and then click the drop-down list and select your model name (if not already selected). Click **PC-FAX** in the left navigation bar, and then click **Receive**.

3. Read and confirm the instructions on your computer.

Faxes in the machine's memory will be sent to your computer automatically.



When faxes in the machine's memory are not sent to your computer:

Make sure you have set [PC Fax Receive] on the machine.

If faxes are in the machine's memory when you set up PC-Fax Receive, the touchscreen will ask if you want to transfer the faxes to your computer.

Press [Yes] to transfer all faxes in the memory to your computer. If Fax Preview is set to Off, you will be asked if you want to print backup copies.





Related Information

- [Transfer Your Faxes or Fax Journal Report](#)
- [Use PC-Fax Receive to Transfer Received Faxes to Your Computer \(Windows® only\)](#)

Transfer the Fax Journal Report to Another Fax Machine

Related Models: MFC-J985DW

If you have not set up your Station ID, you cannot enter fax transfer mode.

1. Press  to interrupt the error temporarily.
2. Press  [Settings] > [All Settings] > [Service] > [Data Transfer] > [Report Transfer].
3. Enter the fax number where the Fax Journal report will be forwarded.
4. Press [Fax Start].

Related Information

- [Transfer Your Faxes or Fax Journal Report](#)
- [Set Your Station ID](#)

Document Jams

- [Document is Jammed in the Top of the ADF Unit](#)
- [Document is Jammed inside the ADF Unit](#)
- [Remove Paper Scraps Jammed in the ADF](#)
- [Error and Maintenance Messages](#)

Document is Jammed in the Top of the ADF Unit

1. Remove any paper from the ADF.
2. Open the ADF cover.
3. Remove the jammed document by pulling it upwards.

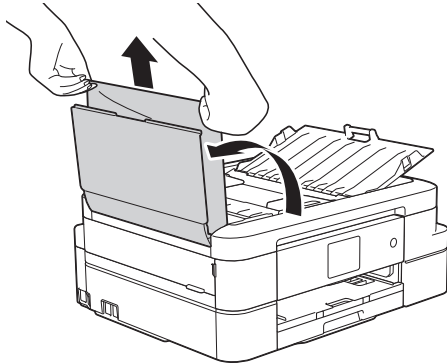

4. Close the ADF cover.
5. Press .

IMPORTANT

To avoid future document jams, close the ADF cover correctly by pressing it down in the centre.

Related Information

- [Document Jams](#)

Document is Jammed inside the ADF Unit

1. Remove any paper that is not jammed from the ADF.
2. Lift the document cover.
3. Pull the jammed document out to the left.

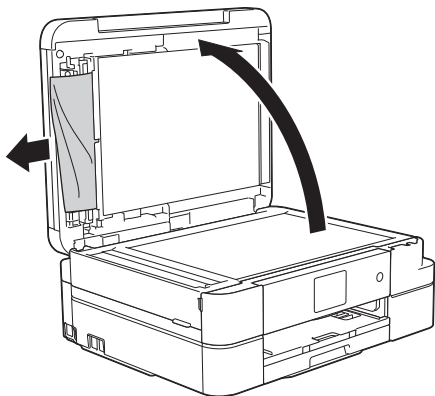

4. Close the document cover.
5. Press .

Related Information

- [Document Jams](#)

Remove Paper Scraps Jammed in the ADF

1. Lift the document cover.
2. Insert a piece of stiff paper, such as cardstock, into the ADF to push any small paper scraps through.

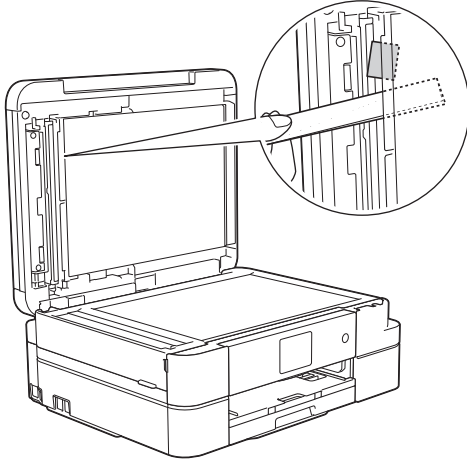

3. Close the document cover.
4. Press .

Related Information

- [Document Jams](#)

Printer Jam or Paper Jam

Locate and remove the jammed paper.

- [Paper is Jammed Inside and in the Front of the Machine \(Jam A Inside/Front\)](#)
- [Paper is Jammed in the Front of the Machine \(Jam B Front\)](#)
- [Paper is Jammed in the Back of the Machine \(Jam C Rear\)](#)
- [Error and Maintenance Messages](#)
- [Paper Handling and Printing Problems](#)

Paper is Jammed Inside and in the Front of the Machine (Jam A Inside/Front)

If the LCD displays [Jam A Inside/Front] or [Repeat Jam A Inside/Front], follow these steps:

1. Unplug the machine from the electrical socket.
2. Pull the paper tray (1) completely out of the machine.

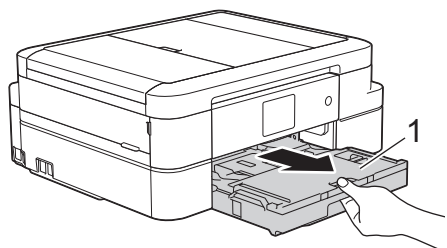

3. Pull the two green levers inside the machine to release the jammed paper.

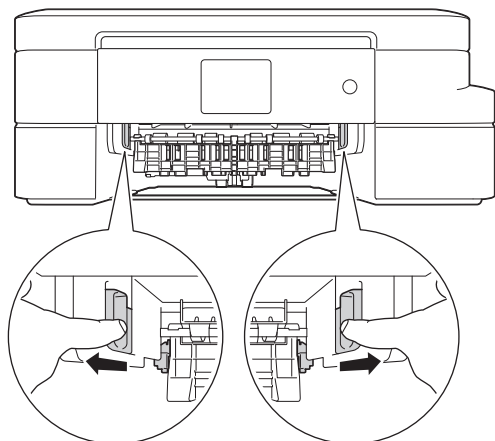

4. Place both hands under the plastic tabs on both sides of the machine to lift the scanner cover (1) into the open position.

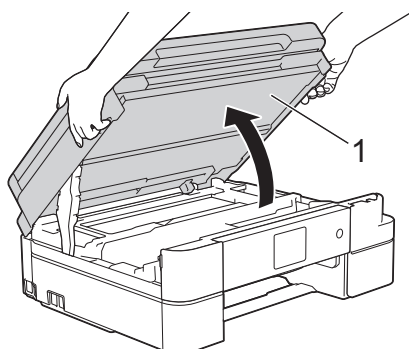

5. Slowly pull the jammed paper (1) out of the machine.

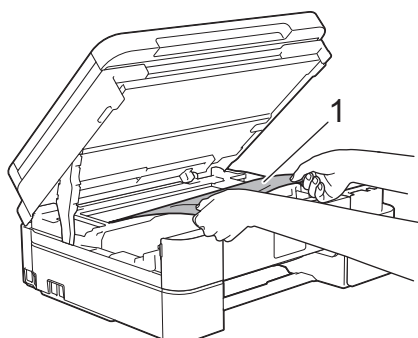



If your LCD error message was [Repeat Jam A Inside/Front], move the print head (if needed) to take out any paper remaining in this area. Make sure scraps of paper are not left in the corners of the machine (1) and (2).

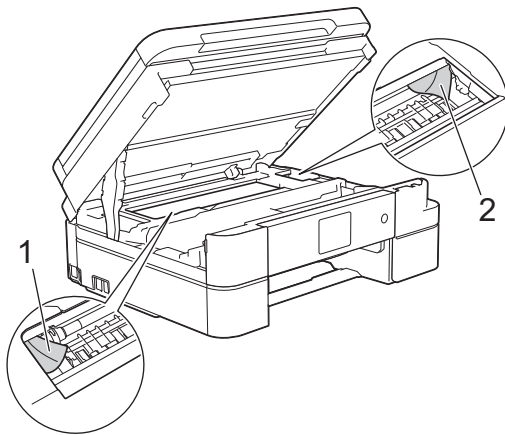

When finished, continue with the next step.

IMPORTANT

- DO NOT touch the encoder strip, a thin strip of plastic that stretches across the width of the machine (1). Doing this may cause damage to the machine.

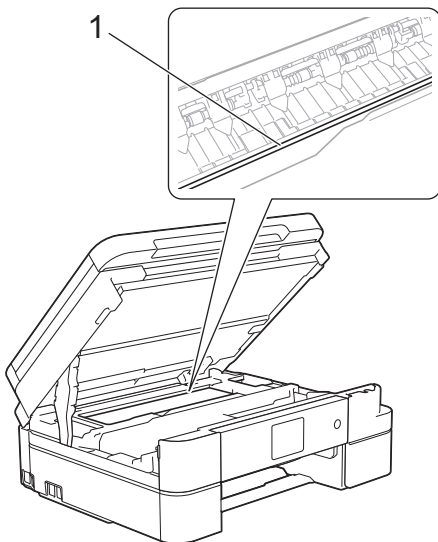

- If the print head is in the right corner as shown in the illustration (2), you cannot move the print head. Close the scanner cover, and then reconnect the power cord. Open the scanner cover again, and then hold down  until the print head moves to the centre. Then unplug the machine from the power source and take out the paper.
- If the paper is jammed under the print head, unplug the machine from the power source, and then move the print head to take out the paper. Hold the concave areas with the triangle marks shown in the illustration (3) to move the print head.

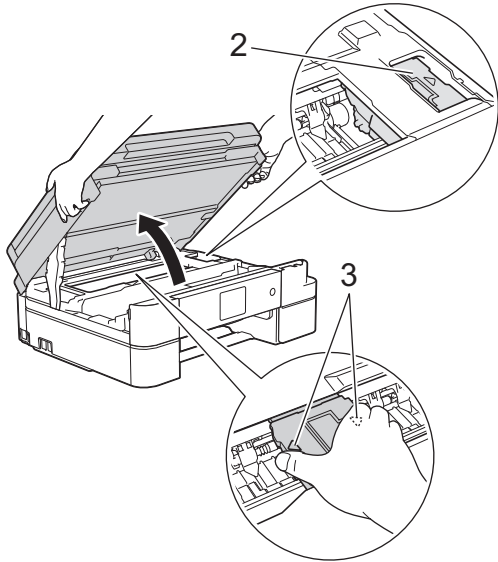

- If ink gets on your skin or clothing, immediately wash it off with soap or detergent.

6. Gently close the scanner cover using both hands.

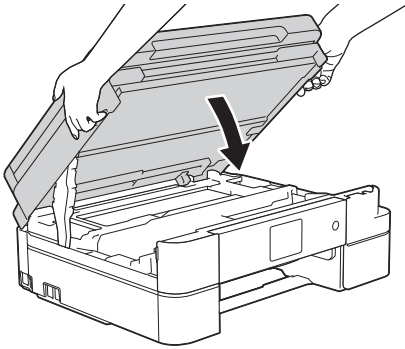

7. Slowly pull the jammed paper (1) out of the machine.

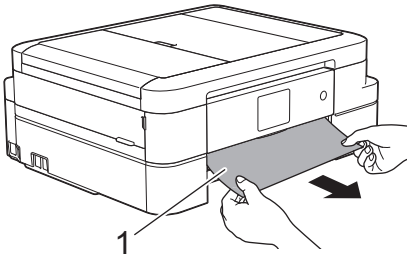



If your LCD error message was [Repeat Jam A Inside/Front], do the following:

- a. Make sure you look carefully inside (1) for any scraps of paper.

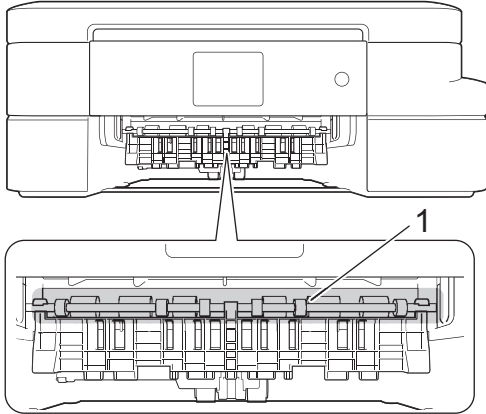

- b. Squeeze both levers (1), and then open the Jam Clear Cover at the back of the machine.

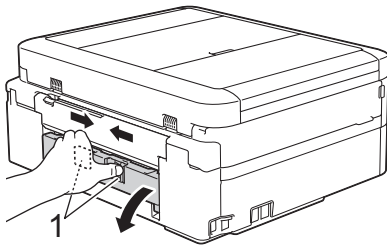

- c. Slowly pull the jammed paper out of the machine.

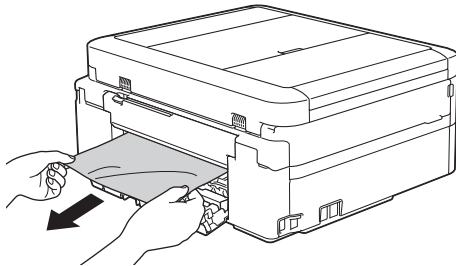

- d. Close the Jam Clear Cover. Make sure the cover is closed completely.

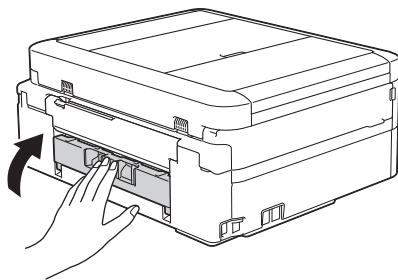

When finished, continue with the next step.

8. Put the paper tray firmly back in the machine.

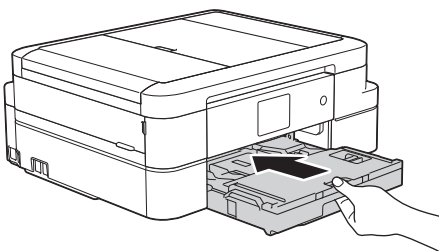

-
9. While holding the paper tray in the machine, pull out the paper support (1) until it locks into place, and then unfold the paper support flap (2).

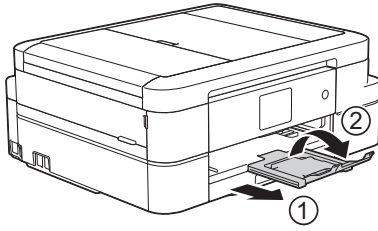

10. Reconnect the power cord.



Related Information

- [Printer Jam or Paper Jam](#)
 - [Transfer Your Faxes or Fax Journal Report](#)
 - [Error and Maintenance Messages](#)
-

Paper is Jammed in the Front of the Machine (Jam B Front)

If the LCD displays [Jam B Front] or [Repeat Jam B Front], follow these steps:

1. Unplug the machine from the electrical socket.
2. Pull the paper tray (1) completely out of the machine.

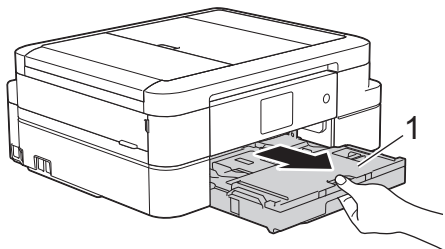

3. Pull the two green levers inside the machine to release the jammed paper.

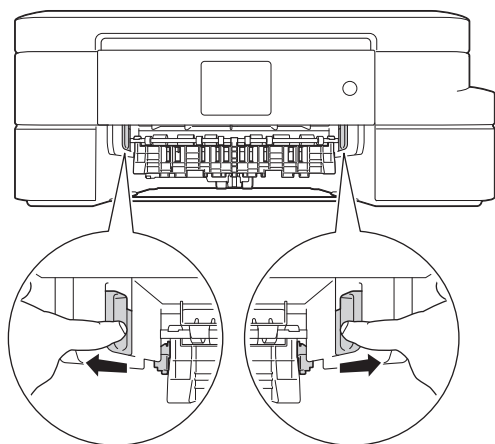

4. Slowly pull out the jammed paper (1).

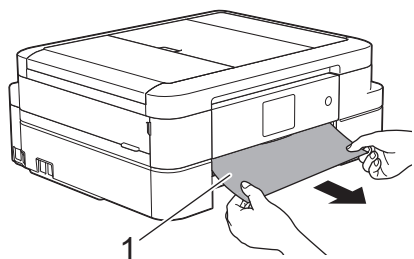



If your LCD error message was [Repeat Jam B Front], do the following:

- a. Make sure you look carefully inside (1) for any scraps of paper.

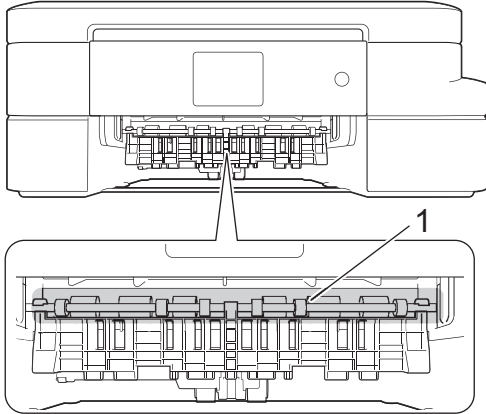

- b. Squeeze both levers (1), and then open the Jam Clear Cover at the back of the machine.

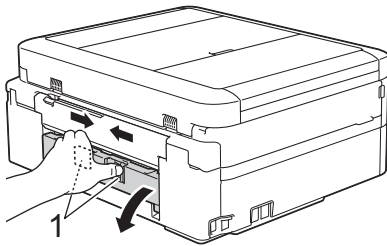

- c. Slowly pull the jammed paper out of the machine.

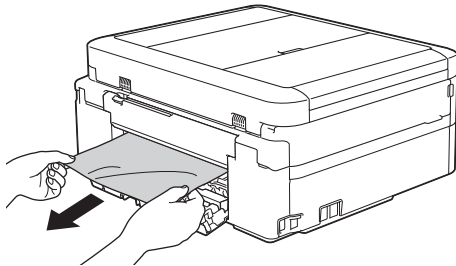

- d. Close the Jam Clear Cover. Make sure the cover is closed completely.

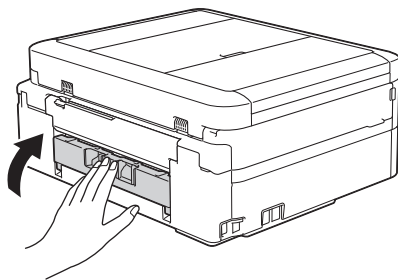

When finished, continue with the next step.

5. Put the paper tray firmly back in the machine.

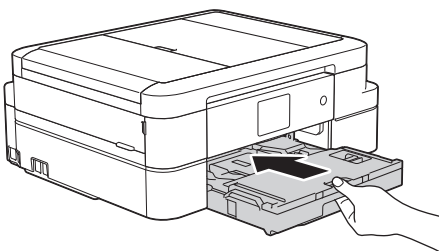

-
6. While holding the paper tray in the machine, pull out the paper support (1) until it locks into place, and then unfold the paper support flap (2).

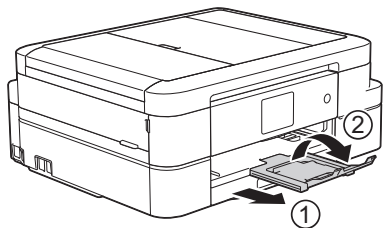

7. Reconnect the power cord.



Related Information

- [Printer Jam or Paper Jam](#)
 - [Transfer Your Faxes or Fax Journal Report](#)
 - [Error and Maintenance Messages](#)
-

Paper is Jammed in the Back of the Machine (Jam C Rear)

If the LCD displays [Jam C Rear], follow these steps:

1. Unplug the machine from the electrical socket.
2. Pull the paper tray (1) completely out of the machine.

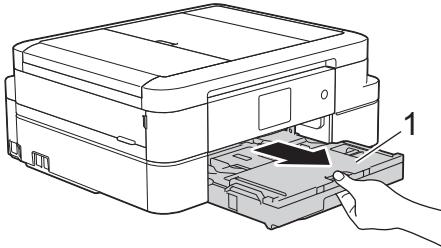

3. Pull the two green levers inside the machine to release the jammed paper.

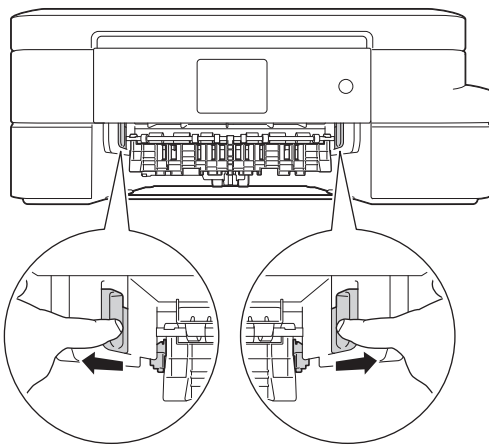

Depending on the paper size, it is easier to remove the jammed paper from the front of the machine rather than from the back of the machine.

4. Squeeze both levers (1), and then open the Jam Clear Cover at the back of the machine.

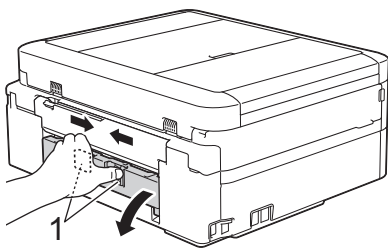

5. Slowly pull the jammed paper out of the machine.

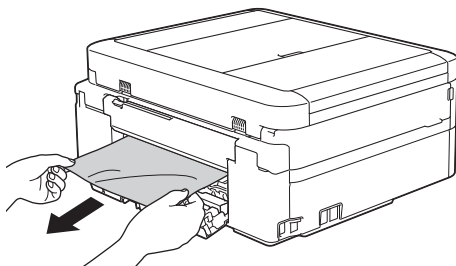

6. Close the Jam Clear Cover. Make sure the cover is closed completely.

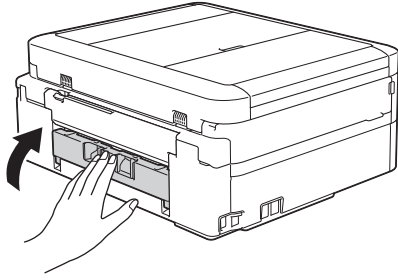

7. Put the paper tray firmly back in the machine.

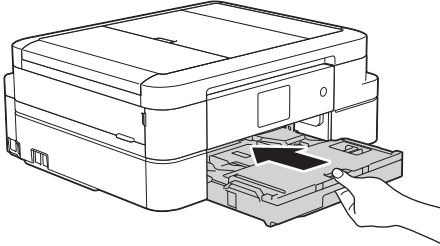

8. While holding the paper tray in the machine, pull out the paper support (1) until it locks into place, and then unfold the paper support flap (2).

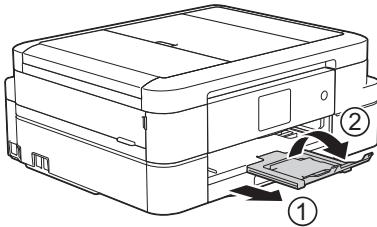

9. Reconnect the power cord.

Related Information

- [Printer Jam or Paper Jam](#)
- [Transfer Your Faxes or Fax Journal Report](#)
- [Error and Maintenance Messages](#)

If You Are Having Difficulty with Your Machine



For technical help, you must contact Brother customer support.

If you think there is a problem with your machine, check the following topics. You can correct most problems yourself.

If you need additional help, the Brother Solutions Center offers the latest FAQs and troubleshooting tips.



Visit support.brother.com.



Using non-Brother supplies may affect the print quality, hardware performance, and machine reliability.

- [Paper Handling and Printing Problems](#)
- [Telephone and Fax problems](#)
- [Other Problems](#)
- [Network Problems](#)

Paper Handling and Printing Problems





Printing Difficulties

Difficulties	Suggestions
No printout	Check that the correct printer driver has been installed and selected.
	Check to see if the machine's display is showing an error message. See <i>Related Information: Error and Maintenance Messages</i> .
	Check that the machine is online: <ul style="list-style-type: none"> Windows® XP and Windows Server® 2003 Click the Start > Printers and Faxes. Right-click Brother MFC-XXXX Printer (where XXXX is your model name). Make sure Use Printer Online is not listed. If it is listed, click this option to set the driver Online. Windows Vista® and Windows Server® 2008 Click /Start > Control Panel > Hardware and Sound > Printers. Right-click Brother MFC-XXXX Printer (where XXXX is your model name). Make sure Use Printer Online is not listed. If it is listed, click this option to set the driver Online. Windows® 7 and Windows Server® 2008 R2 Click /Start > Devices and Printers. Right-click Brother MFC-XXXX Printer (where XXXX is your model name) and click See what's printing. Click Printer in the menu bar. Make sure Use Printer Offline is not selected. Windows® 8 Move your mouse to the lower right corner of your desktop. When the menu bar appears, click Settings > Control Panel. In the Hardware and Sound group, click View devices and printers. Right-click the Brother MFC-XXXX Printer (where XXXX is your model name). Click See what's printing. If printer driver options appear, select your printer driver. Click Printer in the menu bar and make sure Use Printer Offline is not selected. Windows® 10 Click  > All apps > Windows System > Control Panel. In the Hardware and Sound group, click View devices and printers. Right-click the Brother MFC-XXXX Printer (where XXXX is your model name). Click See what's printing. If printer driver options appear, select your printer driver. Click Printer in the menu bar and make sure Use Printer Offline is not selected. Windows Server® 2012 Move your mouse to the lower right corner of your desktop. When the menu bar appears, click Settings > Control Panel. In the Hardware group, click View devices and printers. Right-click the Brother MFC-XXXX Printer (where XXXX is your model name). Click See what's printing. If printer driver options appear, select your printer driver. Click Printer in the menu bar and make sure Use Printer Offline is not selected. Windows Server® 2012 R2 Click Control Panel on the Start screen. In the Hardware group, click View devices and printers. Right-click the Brother MFC-XXXX Printer (where XXXX is your model name). Click See what's printing. If printer driver options appear, select your printer driver. Click Printer in the menu bar and make sure Use Printer Offline is not selected.
	One or more ink cartridges have reached the end of their life. See <i>Related Information: Replace the Ink Cartridges</i> .
	If old, unprinted data remains in the printer driver spooler, it will prevent new print jobs from printing. Open the printer icon and delete all data as follows:

Difficulties	Suggestions
	<ul style="list-style-type: none"> • Windows® XP and Windows Server® 2003 Click the Start > Printers and Faxes. • Windows Vista® and Windows Server® 2008 Click /Start > Control Panel > Hardware and Sound > Printers. • Windows® 7 and Windows Server® 2008 R2 Click /Start > Devices and Printers > Printers and Faxes. • Windows® 8 Move your mouse to the lower right corner of your desktop. When the menu bar appears, click Settings > Control Panel. In the Hardware and Sound group, click View devices and printers > Printers. • Windows® 10 Click  > All apps > Windows System > Control Panel. In the Hardware and Sound group, click View devices and printers > Printers. • Windows Server® 2012 Move your mouse to the lower right corner of your desktop. When the menu bar appears, click Settings > Control Panel. In the Hardware group, click View devices and printers > Printers. • Windows Server® 2012 R2 Click Control Panel on the Start screen. In the Hardware group, click View devices and printers > Printers. • OS X v10.8.5 Click the System Preferences > Print & Scan. • OS X v10.9.x, 10.10.x Click the System Preferences > Printers & Scanners.
The headers or footers appear when the document is displayed on the screen but do not appear when the document is printed.	There is an unprintable area on the top and bottom of the page. Adjust the top and bottom margins in your document to allow for this. See <i>Related Information: Unprintable Area</i> .
Cannot perform 'Page Layout' printing.	Check that the paper size setting in the application and in the printer driver are the same.
Print speed is too slow.	<p>Try changing the printer driver setting. The highest resolution needs longer data processing, sending and printing time. Try the other quality settings in the printer driver as follows:</p> <ul style="list-style-type: none"> • Windows® In the printer driver, clear the Colour Enhancement check box on the Advanced tab. • Mac In the printer driver, select Color Settings, click Advanced Color Settings, and make sure you clear the Color Enhancement check box. <p>Turn the Borderless feature off. Borderless printing is slower than normal printing. See <i>Related Information: Print Settings (Windows®)</i> or <i>Print a Photo (Mac)</i>.</p>

Print Quality Difficulties

Difficulties	Suggestions
Poor print quality	<p>Check the print quality. See <i>Related Information: Check the Print Quality</i>.</p> <p>Make sure the Media Type setting in the printer driver or the Paper Type setting in the machine's menu matches the type of paper you are using. See <i>Related Information: Change the Paper Size and Paper Type</i>.</p>

Difficulties	Suggestions
	<p>See <i>Related Information: Print Settings (Windows®)</i> or <i>Print Options (Mac)</i>.</p> <p>Make sure your ink cartridges are fresh. The following may cause ink to clog:</p> <ul style="list-style-type: none"> • The expiration date written on the cartridge package has passed. (Brother Original cartridges stay usable for up to two years if kept in their original packaging.) • The ink cartridge has been in your machine for over six months. • The ink cartridge may not have been stored correctly before use. <p>Make sure you are using Brother Original Innobella ink. Brother does not recommend the use of cartridges other than Brother Original cartridges or the refilling of used cartridges with ink from other sources.</p> <p>Make sure you are using one of the recommended types of paper. See <i>Related Information: Acceptable Paper and Other Print Media</i>.</p> <p>The recommended environment for your machine is between 20 °C and 33 °C.</p>
<p>White horizontal lines appear in text or graphics.</p> 	<p>Clean the print head. See <i>Related Information: Clean the Print Head from Your Brother Machine</i>.</p> <p>See <i>Related Information: Clean the Print Head from Your Computer (Windows®)</i> or <i>Clean the Print Head from Your Computer (Mac)</i>.</p> <p>Make sure you are using Brother Original Innobella ink.</p> <p>Try using the recommended types of paper. See <i>Related Information: Acceptable Paper and Other Print Media</i>.</p> <p>To prolong print head life, provide the best ink cartridge economy and maintain print quality, we do not recommend frequently unplugging the machine and/or leaving the machine unplugged for extended periods of time. We recommend using  to power down the machine. Using  allows minimal power to the machine, resulting in periodic, but less frequent, cleaning of the print head.</p>
<p>The machine prints blank pages.</p>	<p>Check the print quality. See <i>Related Information: Check the Print Quality</i>.</p> <p>Make sure you are using Brother Original Innobella ink.</p> <p>To prolong print head life, provide the best ink cartridge economy and maintain print quality, we do not recommend frequently unplugging the machine and/or leaving the machine unplugged for extended periods of time. We recommend using  to power down the machine. Using  allows minimal power to the machine, resulting in periodic, but less frequent, cleaning of the print head.</p>
<p>Characters and lines are blurred.</p>	<p>Check the printing alignment. See <i>Related Information: Check the Print Alignment from Your Brother Machine</i>.</p>
<p>Printed text or images are skewed.</p>	<p>Make sure the paper is loaded correctly in the paper tray and the paper guides are adjusted correctly. See <i>Related Information: Load Paper</i>.</p> <p>Make sure the Jam Clear Cover is closed correctly.</p>
<p>Smudge or stain at the top centre of the printed page.</p>	<p>Make sure the paper is not too thick or curled. See <i>Related Information: Acceptable Paper and Other Print Media</i>.</p>
<p>Printing appears dirty or ink seems to run.</p>	<p>Make sure you are using the recommended types of paper. Do not handle the paper until the ink is dry. See <i>Related Information: Acceptable Paper and Other Print Media</i>.</p> <p>Make sure the printing surface is face down in the paper tray.</p> <p>Make sure you are using Brother Original Innobella ink.</p>

Difficulties	Suggestions
	If you are using photo paper, make sure the glossy side of the photo paper is face down in the tray and you have set the correct paper type. If you are printing a photo from your computer, set the Media Type in the printer driver.
Ink is smudged or wet when using glossy photo paper.	Be sure to check the front and back of the paper. Place the glossy surface (printing surface) face down. <i>See Related Information: Change the Paper Size and Paper Type.</i>
	If you use glossy photo paper, make sure the paper type setting is correct.
Stains appear on the reverse side or at the bottom of the page.	Make sure the printer platen is not dirty with ink. <i>See Related Information: Clean the Machine's Printer Platen.</i>
	Make sure you are using Brother Original Innobella ink.
	Make sure you are using the paper support flap. <i>See Related Information: Load Paper.</i>
	Make sure the paper feed rollers are not dirty with ink. <i>See Related Information: Clean the Paper Feed Rollers.</i>
The machine prints dense lines on the page.	Windows® Select Reverse Order in the Basic tab of the printer driver.
The printouts are wrinkled.	<ul style="list-style-type: none"> • Windows® In the printer driver, select the Advanced tab, click Other Print Options, and then click Advanced Colour Settings. Clear the Bi-Directional Printing check box. • Mac In the printer driver, select Print Settings, click Advanced, select Other Print Options, and clear the Bi-Directional Printing check box.
	Make sure you are using Brother Original Innobella ink.

Paper Handling Difficulties

Difficulties	Suggestions
The machine does not feed paper.	Make sure the paper tray is pushed in all the way until it locks into place.
	Make sure the Jam Clear Cover at the back of the machine is closed.
	Return the photo paper tray to the Normal printing position when you use cut sheet paper. <i>See Related Information: Load Photo or Photo L Paper in Photo Paper Tray.</i>
	If the machine's LCD displays a Paper Jam message and you still have a problem, see <i>Related Information: Error and Maintenance Messages</i> .
	If the paper tray is empty, load a new stack of paper into the paper tray.
	If there is paper in the paper tray, make sure it is straight. If the paper is curled, straighten it. Sometimes it is helpful to remove the paper, turn the stack over and put it back in the paper tray.
	Reduce the amount of paper in the paper tray, and then try again.
	Clean the paper pick-up rollers. <i>See Related Information: Clean the Paper Pick-up Rollers.</i>
	Make sure that the paper is within specifications for the machine. <i>See Related Information: Paper Weight and Thickness.</i>
Photo paper does not feed correctly.	When you print on Brother Photo paper, load one extra sheet of the same photo paper in the paper tray. An extra sheet has been included in the paper package for this purpose.
Machine feeds multiple pages.	<ul style="list-style-type: none"> • Make sure the paper is loaded correctly in the paper tray.

Difficulties	Suggestions
	<ul style="list-style-type: none"> Remove all the paper from the tray and fan the stack of paper well, then put it back in the tray. Make sure you do not push the paper in too far. <p>See <i>Related Information: Load Paper</i>.</p>
	<p>Make sure the Jam Clear Cover is closed correctly.</p> <p>See <i>Related Information: Printer Jam or Paper Jam</i>.</p>
	<p>Make sure the Base Pad in the paper tray is not dirty.</p> <p>See <i>Related Information: Clean the Paper Pick-up Rollers</i>.</p>
There is a paper jam.	<p>See <i>Related Information: Printer Jam or Paper Jam</i>.</p> <p>Make sure the paper guides are set to the correct paper size.</p>
The paper jams when you use 2-sided copy or 2-sided print.	<p>Use one of the jam prevention settings, 2-sided 1 or 2-sided 2.</p> <p>For copying</p> <p>See <i>Related Information: Copy on Both Sides of the Paper (1-sided to 2-sided/2-sided to 2-sided)</i>.</p> <p>For printing</p> <p>See <i>Related Information: Prevent Smudged Printouts and Paper Jams When Printing on Both Sides of the Paper (Windows®) or Prevent Smudged Printouts and Paper Jams When Printing on Both Sides of the Paper (Mac)</i>.</p>
	<p>If paper jams occur frequently during 2-sided copying or 2-sided printing, the paper feed rollers may be stained with ink. Clean the paper feed rollers.</p> <p>See <i>Related Information: Clean the Paper Feed Rollers</i>.</p>

Printing Received Faxes (MFC models)

Difficulties	Suggestions
<ul style="list-style-type: none"> Condensed print Horizontal streaks Top and bottom sentences are cut off Missing lines 	<p>This is usually caused by a poor telephone connection. Make a copy; if your copy looks good, you probably had a bad connection, with static or interference on the telephone line. Ask the other party to send the fax again.</p>
Vertical black lines when receiving	<p>The sender's scanner may be dirty. Ask the sender to make a copy to see if the problem is with the sending machine. Try receiving from another fax machine.</p>
Left and right margins are cut off or a single page is printed on two pages.	<p>If the received faxes are divided and printed on two pages or if you get an extra blank page, your paper size setting may not be correct for the paper you are using.</p> <p>See <i>Related Information: Change the Paper Size and Paper Type</i>.</p>
	<p>Turn on Auto Reduction.</p> <p>See <i>Related Information: Shrink Page Size of an Oversized Incoming Fax</i>.</p>
Received colour fax prints only in monochrome.	<p>Replace the colour ink cartridges that have reached the end of their life, and then ask the other person to send the colour fax again.</p> <p>See <i>Related Information: Replace the Ink Cartridges</i>.</p>



Related Information

- [If You Are Having Difficulty with Your Machine](#)
- [Troubleshooting](#)
- [Error and Maintenance Messages](#)
- [Replace the Ink Cartridges](#)
- [Load Photo or Photo L Paper in Photo Paper Tray](#)
- [Unprintable Area](#)

-
- Check the Print Quality
 - Change the Paper Size and Paper Type
 - Acceptable Paper and Other Print Media
 - Clean the Print Head from Your Brother Machine
 - Clean the Print Head from Your Computer (Windows®)
 - Clean the Print Head from Your Computer (Mac)
 - Check the Print Alignment from Your Brother Machine
 - Load Paper
 - Clean the Machine's Printer Platen
 - Clean the Paper Feed Rollers
 - Clean the Paper Pick-up Rollers
 - Printer Jam or Paper Jam
 - Copy on Both Sides of the Paper (1-sided to 2-sided/2-sided to 2-sided)
 - Shrink Page Size of an Oversized Incoming Fax
 - Paper Weight and Thickness
 - Print Settings (Windows®)
 - Print Options (Mac)
 - Print a Photo (Mac)
 - Prevent Smudged Printouts and Paper Jams When Printing on Both Sides of the Paper (Windows®)
 - Prevent Smudged Printouts and Paper Jams When Printing on Both Sides of the Paper (Mac)
-

Telephone and Fax problems

Related Models: MFC-J985DW

Telephone Line or Connections

Difficulties	Suggestions
Dialling does not work. (No dial tone)	Check all line cord connections. Make sure the telephone line cord is plugged into the telephone wall socket and the LINE socket of the machine. If you subscribe to DSL or VoIP services, contact your service provider for connection instructions. If you are using a VoIP system, try changing the VoIP setting to <i>Basic (for VoIP)</i> . This will lower modem speed and turn off Error Correction Mode (ECM). See <i>Related Information: Telephone Line Interference/VoIP</i> .
	(Available only for some countries.) Change the Tone/Pulse setting. See <i>Related Information: Set Tone or Pulse Dialling Mode</i> .
	If an external phone is connected to the machine, send a manual fax by lifting the handset of the external telephone and dialling the number using the external telephone. Wait to hear the fax receiving tones before sending the fax.
	If there is no dial tone, connect a known working telephone and telephone line cord to the socket. Then lift the external telephone's handset and listen for a dial tone. If there is still no dial tone, ask your telephone company to check the line and/or wall socket.
The machine does not answer when called.	Make sure the machine is in the correct receive mode for your setup. See <i>Related Information: Choose the Correct Receive Mode</i> . Check for a dial tone. If possible, call your machine to hear it answer. If there is still no answer, check that the telephone line cord is plugged into the telephone wall socket and the LINE socket of the machine. If there is no ringing when you call your machine, ask your telephone company to check the line.

Handling Incoming Calls

Difficulties	Suggestions
The machine 'Hears' a voice as a CNG Tone.	If Fax Detect is set to On, your machine is more sensitive to sounds. It may mistakenly interpret certain voices or music on the line as a fax machine calling and respond with fax receiving tones. Deactivate the machine by pressing  . Try avoiding this problem by turning Fax Detect to Off. See <i>Related Information: Set Fax Detect</i> .
Sending a Fax Call to the machine.	If you answered on an extension or external telephone, press your Remote Activation Code (the factory setting is *51). If you answered on the external telephone, press the Start button to receive the fax. When your machine answers, hang up.
Custom features on a single line.	If you have Call Waiting, Call Waiting/Caller ID, Caller ID, Voice Mail, an answering machine, an alarm system or other custom feature on a single telephone line with your machine, it may create a problem sending or receiving faxes. For Example: If you subscribe to Call Waiting or some other custom service and its signal comes through the line while your machine is sending or receiving a fax, the signal can temporarily interrupt or disrupt the faxes. Brother's ECM (Error Correction Mode) feature should help overcome this problem. This condition is related to the telephone system industry and is common to all devices that send and receive information on a single, shared line with custom features. If avoiding

Difficulties	Suggestions
	a slight interruption is crucial to your business, we recommend using a separate telephone line with no custom features.

Receiving Faxes

Difficulties	Suggestions
Cannot receive a fax.	<p>Check all line cord connections. Make sure the telephone line cord is plugged into the telephone wall socket and the LINE socket of the machine. If you subscribe to DSL or VoIP services, contact your service provider for connection instructions. If you are using a VoIP system, try changing the VoIP setting to <i>Basic (for VoIP)</i>. This will lower modem speed and turn off Error Correction Mode (ECM).</p> <p>See <i>Related Information: Telephone Line Interference/VoIP</i>.</p> <p>Make sure the machine is in the correct Receive Mode. This is determined by the external devices and telephone subscriber services you have on the same line as the Brother machine.</p> <p>See <i>Related Information: Choose the Correct Receive Mode</i>.</p> <ul style="list-style-type: none"> • If you have a dedicated fax line and want your Brother machine to automatically answer all incoming faxes, you should select Fax only mode. • If your Brother machine shares a line with an external answering machine, you should select the External TAD mode. In External TAD mode, your Brother machine will receive incoming faxes automatically and voice callers will be able to leave a message on your answering machine. • If your Brother machine shares a line with other telephones and you want it to automatically answer all incoming faxes, you should select the Fax/Tel mode. In Fax/Tel mode, your Brother machine will receive faxes automatically and produce a pseudo/double-ring to alert you to answer voice calls. • If you do not want your Brother machine to answer any incoming faxes automatically, you should select the Manual mode. In Manual mode, you must answer every incoming call and activate the machine to receive faxes. <p>Another device or service at your location may be answering the call before your Brother machine answers. To test this, lower the Ring Delay setting:</p> <ul style="list-style-type: none"> • If the Receive Mode is set to Fax Only or Fax/Tel, reduce the Ring Delay to one ring. <p>See <i>Related Information: Set the Number of Rings Before the Machine Answers (Ring Delay)</i>.</p> <ul style="list-style-type: none"> • If the Receive Mode is set to External TAD, reduce the number of rings programmed on your answering machine to two. • If the Receive Mode is set to Manual, DO NOT adjust the Ring Delay setting. <p>Have someone send you a test fax:</p> <ul style="list-style-type: none"> • If you received the test fax successfully, your machine is operating correctly. Remember to reset your Ring Delay or answering machine setting back to your original setting. If receiving problems recur after resetting the Ring Delay, then a person, device, or subscriber service is answering the fax call before the machine has a chance to answer. • If you were not able to receive the fax, then another device or subscriber service may be interfering with your fax reception or there may be a problem with your fax line. <p>If you are using a telephone answering machine (External TAD mode) on the same line as the Brother machine, make sure your answering machine is set up correctly.</p> <p>See <i>Related Information: Connect an External TAD</i>.</p> <ol style="list-style-type: none"> 1. Connect the external TAD as shown in the illustration. See <i>Related Information: External TAD (Telephone Answering Device)</i>. 2. Set your answering machine to answer in one or two rings. 3. Record the outgoing message on your answering machine.

Difficulties	Suggestions
	<ul style="list-style-type: none"> • Record five seconds of silence at the beginning of your outgoing message. • Limit your speaking to 20 seconds. • End your outgoing message with your Remote Activation Code for people sending manual faxes. For example: "After the beep, leave a message or press *51 and Start to send a fax." <p>4. Set your answering machine to answer calls.</p> <p>5. Set your Brother machine's Receive Mode to External TAD. See <i>Related Information: Choose the Correct Receive Mode.</i></p>
	<p>Make sure your Brother machine's Fax Detect feature is turned On. Fax Detect is a feature that allows you to receive a fax even if you answered the call on an external or extension telephone. See <i>Related Information: Set Fax Detect.</i></p>
	<p>If you often get transmission errors due to possible interference on the telephone line or if you are using a VoIP system, try changing the Compatibility setting to <i>Basic(for VoIP)</i>. See <i>Related Information: Telephone Line Interference/VoIP.</i></p>
	<p>If you connect your machine to a PBX or ISDN line, set the menu setting of Telephone Line Type to your telephone line type. See <i>Related Information: Set the Telephone Line Type.</i></p>

Sending Faxes

Difficulties	Suggestions
Cannot send a fax.	<p>Check all line cord connections. Make sure the telephone line cord is plugged into the telephone wall socket and the LINE socket of the machine. If you subscribe to DSL or VoIP services, contact your service provider for connection instructions.</p> <p>If you are using a VoIP system, try changing the VoIP setting to <i>Basic (for VoIP)</i>. This will lower modem speed and turn off Error Correction Mode (ECM). See <i>Related Information: Telephone Line Interference/VoIP.</i></p>
	<p>Print the Transmission Verification Report and check for an error. See <i>Related Information: Print Reports.</i></p>
	<p>Ask the other party to check that the receiving machine has paper.</p>
Poor sending quality.	<p>Try changing your resolution to Fine or S.Fine. Make a copy to check your machine's scanner operation. If the copy quality is poor, clean the scanner. See <i>Related Information: Clean the Scanner.</i></p>
Transmission Verification Report says RESULT:NG.	<p>There is probably temporary noise or static on the line. Try sending the fax again. If you are sending a PC-Fax message and get RESULT:NG on the Transmission Verification Report, your machine may be out of memory. To free up extra memory, you can turn off Fax Storage, print fax messages in memory or cancel a delayed fax or polling job. If the problem continues, ask the telephone company to check your telephone line.</p> <p>See <i>Related Information: Turn Off Memory Receive.</i> See <i>Related Information: Print a Fax Stored in the Machine's Memory.</i> See <i>Related Information: Cancel a Fax in Progress.</i> See <i>Related Information: Check and Cancel a Pending Fax.</i></p>
	<p>If you connect your machine to a PBX or ISDN line, set the menu setting of Telephone Line Type to your telephone line type. See <i>Related Information: Set the Telephone Line Type.</i></p>
	<p>If you often get transmission errors due to possible interference on the telephone line or if you are using a VoIP system, try changing the Compatibility setting to <i>Basic(for VoIP)</i>. See <i>Related Information: Telephone Line Interference/VoIP.</i></p>

Difficulties	Suggestions
Sent faxes are blank.	Make sure you are loading the document correctly. See <i>Related Information: Load Documents in the Automatic Document Feeder (ADF)</i> . See <i>Related Information: Load Documents on the Scanner Glass</i> .
Vertical black lines when sending.	Black vertical lines on faxes you send are typically caused by dirt or correction fluid on the glass strip. Clean the glass strip. See <i>Related Information: Clean the Scanner</i> .





Related Information

- [If You Are Having Difficulty with Your Machine](#)
 - [Set Dial Tone Detection](#)
 - [Telephone Line Interference/VoIP](#)
 - [Troubleshooting](#)
 - [Set Tone or Pulse Dialling Mode](#)
 - [Choose the Correct Receive Mode](#)
 - [Set Fax Detect](#)
 - [Set the Number of Rings Before the Machine Answers \(Ring Delay\)](#)
 - [Connect an External TAD](#)
 - [External TAD \(Telephone Answering Device\)](#)
 - [Set the Telephone Line Type](#)
 - [Print Reports](#)
 - [Clean the Scanner](#)
 - [Turn Off Memory Receive](#)
 - [Print a Fax Stored in the Machine's Memory](#)
 - [Cancel a Fax in Progress](#)
 - [Check and Cancel a Pending Fax](#)
 - [Load Documents in the Automatic Document Feeder \(ADF\)](#)
 - [Load Documents on the Scanner Glass](#)
-

Set Dial Tone Detection

Related Models: MFC-J985DW

Setting the Dial Tone to [Detection] will shorten the Dial Tone detect pause.

1. Press  [Settings] > [All Settings] > [Initial Setup] > [Dial Tone].
2. Press [Detection] or [No Detection].
3. Press .



Related Information

- [Telephone and Fax problems](#)

Telephone Line Interference/VoIP

Related Models: MFC-J985DW

If you are having problems sending or receiving a fax due to possible interference on the telephone line or if you are using a VoIP system, we recommend changing the modem speed to minimise errors in fax operations.

1. Press  [Settings] > [All Settings] > [Initial Setup] > [Compatibility].
2. Press [Normal] or [Basic (for VoIP)].
 - [Basic (for VoIP)] reduces the modem speed to 9,600 bps and turns off colour fax receiving and ECM, except for colour fax-sending. Unless interference is a recurring problem on your telephone line, you may prefer to use it only when needed.
To improve compatibility with most VoIP services, Brother recommends changing the compatibility setting to [Basic (for VoIP)].
 - [Normal] sets the modem speed at 14,400 bps.
3. Press .



-
- VoIP (Voice over IP) is a type of phone system that uses an Internet connection, rather than a traditional phone line.
-



Related Information

- [Telephone and Fax problems](#)
 - [Voice Over Internet Protocol \(VoIP/Telephone Line Interference\)](#)
 - [Error and Maintenance Messages](#)
-

Other Problems

Copying Difficulties

Difficulties	Suggestions
Vertical black lines or streaks appear in copies.	Black vertical lines on copies are typically caused by dirt or correction fluid on the glass strip. Clean the glass strip, scanner glass, and the white bar and white plastic above them. See <i>Related Information: Clean the Scanner.</i>
Black marks or spots appear in copies.	Black marks or spots on copies are typically caused by dirt or correction fluid on the scanner glass. Clean the scanner glass and white plastic above it. See <i>Related Information: Clean the Scanner.</i>
Copies are blank.	Make sure you are loading the document correctly. See <i>Related Information: Load Documents in the Automatic Document Feeder (ADF).</i> See <i>Related Information: Load Documents on the Scanner Glass.</i>
Poor copy results when using the ADF. (ADF models)	Try using the scanner glass. See <i>Related Information: Load Documents on the Scanner Glass.</i>
Fit to Page does not work correctly.	Make sure the document is not skewed on the scanner glass. Reposition the document and try again.

Scanning Difficulties

Difficulties	Suggestions
TWAIN or WIA errors appear when starting to scan. (Windows®)	Make sure the Brother TWAIN or WIA driver is selected as the primary source in your scanning application. For example, in Nuance™ PaperPort™ 14 ¹ , click Desktop > Scan Settings > Select to select the Brother TWAIN/WIA driver.
TWAIN or ICA errors appear when starting to scan. (Mac)	Make sure the Brother TWAIN driver is selected as the primary source. In PageManager ¹ , click File > Import From Scanner and select the Brother TWAIN driver. You can also scan documents using the ICA Scanner Driver.
OCR does not work. (DCP-J785DW/MFC-J985DW)	Try increasing the scanning resolution. (Mac) Make sure you downloaded and installed Presto! PageManager from nj.newsoft.com.tw/download/brother/PM9SEInstaller_BR_multilang2.dmg .
Poor scanning results when using the ADF. (Vertical black lines appear in the scanned data.) (ADF models)	Clean the white bar and the glass strip underneath it. See <i>Related Information: Clean the Scanner.</i>
	Try using the scanner glass. See <i>Related Information: Load Documents on the Scanner Glass.</i>

¹ DCP-J785DW is not available.

PhotoCapture Center Difficulties

Difficulties	Suggestions
Removable Disk does not work correctly.	<ol style="list-style-type: none"> 1. Take out the memory card or USB Flash drive and put it back in again. 2. If you have tried "Eject" from within Windows®, take out the memory card or USB Flash drive before you continue. 3. If an error message appears when you try to eject the memory card or USB Flash drive, it means the card is being accessed. Wait a while, and then try again.

Difficulties	Suggestions
	4. If all of the above do not work, turn off your computer and machine, and then turn them on again.
Cannot access Removable Disk from the computer.	Make sure you have correctly inserted the memory card or USB Flash drive.
Part of my photo is missing when printed.	Make sure Borderless printing and Cropping are turned off. See <i>Related Information: Print Borderless Photos from Media.</i> See <i>Related Information: Print Photos with Auto Cropping.</i>

Software Difficulties

Difficulties	Suggestions
Cannot print.	Uninstall and reinstall the Brother driver.
“Device Busy” appears on the computer screen.	Make sure the machine's display shows no error messages.



Related Information

- [If You Are Having Difficulty with Your Machine](#)
- [Troubleshooting](#)
- [Clean the Scanner](#)
- [Load Documents in the Automatic Document Feeder \(ADF\)](#)
- [Load Documents on the Scanner Glass](#)
- [Print Borderless Photos from Media](#)
- [Print Photos with Auto Cropping](#)

Network Problems



- [Use the Network Connection Repair Tool \(Windows®\)](#)
- [Where Can I Find My Brother Machine's Network Settings?](#)
- [I Cannot Complete the Wireless Network Setup Configuration](#)
- [My Brother Machine Cannot Print, Scan, or PC-FAX Receive over the Network](#)
- [I Want to Check that My Network Devices are Working Correctly](#)
- [Troubleshooting](#)

Use the Network Connection Repair Tool (Windows®)

Use the Network Connection Repair Tool to fix the Brother machine's network settings. It will assign the correct IP address and Subnet Mask.

- Windows® XP/XP Professional x64 Edition/Windows Vista®/Windows® 7/Windows® 8/Windows® 10
You must log on with Administrator rights.
- Make sure the Brother machine is turned on and is connected to the same network as your computer.

1. Do one of the following:

Option	Description
Windows® XP	Click Start > All Programs > Accessories > Windows Explorer > My Computer .
Windows Vista®/Windows® 7	Click  (Start) > Computer .
Windows® 8/Windows® 10	Click the  (File Explorer) icon on the taskbar, and then click Computer (This PC) in the left navigation bar.

2. Double-click **XXX(C:)** (where XXX is the name of your local disk drive) > **Program Files** > **Browny02** > **Brother** > **BrotherNetTool.exe**.



- For 64-bit OS users, double-click **XXX(C:)** (where XXX is the name of your local disk drive) > **Program Files (x86)** > **Browny02** > **Brother** > **BrotherNetTool.exe**.
- If the **User Account Control** screen appears, do one of the following:
 - Windows Vista®: Click **Allow**.
 - Windows® 7/Windows® 8/Windows® 10: Click **Yes**.

3. Follow the on-screen instructions.

4. Check the diagnosis by printing the Network Configuration Report.



The Network Connection Repair Tool will start automatically if you select the **Enable Connection Repair Tool** option in the Status Monitor. Right-click the Status Monitor screen, and then click **Other Settings** > **Enable Connection Repair Tool**. This is not recommended when your network administrator has set the IP address to Static, since it will automatically change the IP address.

If the correct IP address and the Subnet Mask are still not assigned even after using the Network Connection Repair Tool, ask your network administrator for this information.



Related Information

- [Network Problems](#)
- [Print the Network Configuration Report](#)
- [My Brother Machine Cannot Print, Scan, or PC-FAX Receive over the Network](#)
- [I Want to Check that My Network Devices are Working Correctly](#)

Where Can I Find My Brother Machine's Network Settings?

- [Change Machine Settings from Your Computer](#)
- [Print the Network Configuration Report](#)

I Cannot Complete the Wireless Network Setup Configuration

Turn your wireless router off and back on. Then try to configure the wireless settings again. If you are unable to resolve the problem, follow the instructions below:

Investigate the problem using the WLAN Report.

Cause	Action	Interface
Your security settings (SSID/ Network Key) are not correct.	<ul style="list-style-type: none"> • Confirm the security settings using the Wireless Setup Helper utility. For more information and to download the utility, go to your model's Downloads page on the Brother Solutions Center at support.brother.com. • Select and confirm that you are using the correct security settings. <ul style="list-style-type: none"> - See the instructions supplied with your wireless LAN access point/router for information on how to find the security settings. - The manufacturer's name or model number of the wireless LAN access point/router may be used as the default security settings. - Consult with the access point/router manufacturer, your Internet provider, or network administrator. • For definitions of SSID and Network Key, see the entries SSID, Network Key and Channels in the Glossary. 	Wireless
Your Brother machine's MAC address is not allowed.	Confirm that the Brother machine's MAC Address is allowed in the filter. You can find the MAC Address in your Brother machine's control panel.	Wireless
Your wireless LAN access point/router is in stealth mode (not broadcasting the SSID).	<ul style="list-style-type: none"> • Enter the correct SSID name or Network Key manually. • Check the SSID name or the Network Key in the instructions supplied with your wireless LAN access point/router and reconfigure the wireless network setup. 	Wireless
Your security settings (SSID/ password) are not correct.	<ul style="list-style-type: none"> • Confirm the SSID and password. <ul style="list-style-type: none"> - When you are configuring the network manually, the SSID and password are displayed on your Brother machine. If your mobile device supports the manual configuration, the SSID and password will be displayed on your mobile device's screen. • For the definition of SSID, see the Glossary. 	Wi-Fi Direct
You are using Android™ 4.0.	If your mobile device disconnects (approximately six minutes after using Wi-Fi Direct), try the one-push configuration using WPS (recommended) and set the Brother machine as a G/O.	Wi-Fi Direct
Your Brother machine is placed too far from your mobile device.	Move your Brother machine within about 3.3 feet (1 metre) of the mobile device when you configure the Wi-Fi Direct network settings.	Wi-Fi Direct
There are some obstructions (walls or furniture, for example) between your machine and the mobile device.	Move your Brother machine to an obstruction-free area.	Wi-Fi Direct
There is a wireless computer, Bluetooth-supported device, microwave oven, or digital cordless phone near the Brother machine or the mobile device.	Move other devices away from the Brother machine or the mobile device.	Wi-Fi Direct

Cause	Action	Interface
If you have checked and tried all of the above, but still cannot complete the Wi-Fi Direct configuration, do the following:	<ul style="list-style-type: none">• Turn your Brother machine off and back on. Then try to configure the Wi-Fi Direct settings again.• If you are using your Brother machine as a client, confirm how many devices are allowed in the current Wi-Fi Direct network, and then check how many devices are connected.	Wi-Fi Direct

For Windows®

If your wireless connection has been interrupted, and you have checked and tried all of the above, we recommend using the Network Connection Repair Tool.





Related Information

- [Network Problems](#)
 - [Configure Your Machine for a Wireless Network When the SSID is Not Broadcast](#)
 - [Use Wi-Fi Direct®](#)
-

My Brother Machine Cannot Print, Scan, or PC-FAX Receive over the Network

Cause	Action	Interface
Your security software blocks your machine's access to the network. (The Network scanning feature does not work.)	<ul style="list-style-type: none"> Windows® Configure the third-party Security/Firewall Software to allow Network scanning. To add port 54925 for Network scanning, type the information below: <ul style="list-style-type: none"> - In Name: Type any description, for example Brother NetScan. - In Port number: Type 54925. - In Protocol: UDP is selected. See the instruction manual that came with your third-party Security/Firewall Software or contact the software manufacturer. Mac Launch ControlCenter2. Click the Model pop-up menu, and then select Other... The Device Selector window appears. Reselect your network machine, make sure Status is idle, and then click OK. 	Wired/Wireless
Your security software blocks your machine's access to the network. (The network PC-Fax Receive feature does not work.) (Windows®)	<p>Set the third-party Security/Firewall Software to allow PC-FAX Rx. To add port 54926 for Network PC-FAX Rx, type the information below:</p> <ul style="list-style-type: none"> • In Name: Type any description, for example Brother PC-FAX Rx. • In Port number: Type 54926. • In Protocol: UDP is selected. <p>See the instruction manual that came with your third-party Security/Firewall Software or contact the software manufacturer.</p>	Wired/Wireless
Your security software blocks your machine's access to the network.	<p>Some security software might block access without showing a security alert dialog box even after successful installation.</p> <p>To allow access, see the instructions for your security software or ask the software manufacturer.</p>	Wired/Wireless
Your Brother machine was not assigned an available IP address.	<ul style="list-style-type: none"> • Confirm the IP address and the Subnet Mask. Verify that both the IP addresses and Subnet Masks of your computer and the Brother machine are correct and located on the same network. For more information about how to verify the IP address and the Subnet Mask, ask your network administrator. • Windows® Confirm the IP address and the Subnet Mask using the Network Connection Repair Tool. • Mac Check your network devices using the ping command. For more information on how to confirm your network settings, see <i>Related Information: Check Network Devices Using the Ping Command</i>. 	Wired/Wireless
The failed print job is still in your computer's print queue.	<ul style="list-style-type: none"> • If the failed print job is still in your computer's print queue, delete it. • Otherwise, double-click the printer icon in the following folder and cancel all documents: 	Wired/Wireless

Cause	Action	Interface
	<ul style="list-style-type: none"> - Windows® XP/Windows Server® 2003 Click Start > Printers and Faxes. - Windows Vista® Click  (Start) > Control Panel > Hardware and Sound > Printers. - Windows® 7 Click  (Start) > Devices and Printers > Printers and Faxes. - Windows® 8 Move your mouse to the lower right corner of your desktop. When the menu bar appears, click Settings > Control Panel. In the Hardware and Sound group, click View devices and printers > Printers. - Windows® 10 Click  > All apps > Windows System > Control Panel. In the Hardware and Sound group, click View devices and printers > Printers. - Windows Server® 2008 Click Start > Control Panel > Printers. - Windows Server® 2012 Move your mouse to the lower right corner of your desktop. When the menu bar appears, click Settings > Control Panel. In the Hardware group, click View devices and printers > Printers. - Windows Server® 2012 R2 Click Control Panel on the Start screen. In the Hardware group, click View devices and printers. - OS X v10.8.5 Click System Preferences > Print & Scan. - OS X v10.9.x, 10.10.x Click System Preferences > Printers & Scanners. 	
Your Brother machine is not connected to the wireless network.	Print the WLAN Report to check the error code on the printed report.	Wireless

If you have checked and tried all of the above, but your Brother machine still cannot print and scan, uninstall the Brother software and drivers and reinstall them.

Related Information

- [Network Problems](#)
- [Print the WLAN Report](#)
- [Use the Network Connection Repair Tool \(Windows®\)](#)
- [Wireless LAN Report Error Codes](#)
- [Check Network Devices Using the Ping Command](#)
- [I Want to Check that My Network Devices are Working Correctly](#)

I Want to Check that My Network Devices are Working Correctly

Check	Action	Interface
Check that your Brother machine, access point/router, or network hub is turned on.	<p>Check the following:</p> <ul style="list-style-type: none"> The power cord is connected correctly and the Brother machine is turned on. The access point/router or hub is turned on and its link button is blinking. All protective packaging has been removed from the machine. The ink cartridges are installed correctly. The Scanner Cover and the Jam Clear Cover are fully closed. Paper is inserted correctly in the paper tray. (For wired networks) A network cable is securely connected to the Brother machine and to the router or hub. 	Wired/Wireless
Check that you can "ping" the Brother machine from your computer.	<p>Ping the Brother machine from your computer using the IP address or the node name in the Windows® command prompt or Mac Terminal application:</p> <p>ping <ipaddress> or <nodename>.</p> <ul style="list-style-type: none"> Successful: Your Brother machine is working correctly and connected to the same network as your computer. Unsuccessful: Your Brother machine is not connected to the same network as your computer. <p>(Windows®) Ask the network administrator and use the Network Connection Repair Tool to fix the IP address and the subnet mask.</p> <p>(Mac) Confirm that the IP address and the Subnet Mask are set correctly.</p>	Wired/Wireless
Check that your Brother machine is connected to the wireless network.	Print the WLAN Report to check the error code on the printed report.	Wireless

If you have checked and tried all of the above but you are still having problems, see the instructions supplied with your wireless LAN access point/router to find the SSID and the Network Key information and set them correctly.

Related Information



- [Network Problems](#)
- [Check Network Devices Using the Ping Command](#)
- [Print the Network Configuration Report](#)
- [Print the WLAN Report](#)
- [Use the Network Connection Repair Tool \(Windows®\)](#)
- [My Brother Machine Cannot Print, Scan, or PC-FAX Receive over the Network](#)
- [Wireless LAN Report Error Codes](#)

Check Network Devices Using the Ping Command

Check the IP addresses of both your computer and your Brother machine, and then confirm whether the network is operating correctly.

- >> [Configure the IP Address on your computer \(Windows®\)](#)
- >> [Configure the IP Address on your computer \(Mac\)](#)
- >> [Configure the IP Address on your Brother machine](#)

Configure the IP Address on your computer (Windows®)

- Do one of the following:
 - Windows® XP, Windows Vista® and Windows® 7
Click /Start > All Programs > Accessories > Command Prompt
 - Windows® 8
Move your mouse to the lower right corner of your desktop. When the menu bar appears, click **Search** > **Command Prompt**.
 - Windows® 10
Click  > All apps > Windows System > Command Prompt.
- Type "ipconfig" and then press the Enter key on your keyboard.
- Confirm the values for the IPv4 address and subnet mask.
- Type "exit" and then press the Enter key on your keyboard.

Configure the IP Address on your computer (Mac)

- Select **System Preferences** from the Apple Menu.
- Click **Network** > **Advanced** > **TCP/IP**
- Confirm the values for the IPv4 address and subnet mask.

Configure the IP Address on your Brother machine

Print the Network Configuration Report, and confirm the values for the IP address and subnet mask.

```
<IP Settings >
IP Address      192.168.11.250    (set manually)
Subnet Mask    255.255.255.0
IP Gateway     192.168.100.200
Boot Method    STATIC
Boot Tries     3
IP Filter      Disabled
```

Check the IP addresses for both your computer and your Brother machine. Confirm that the network address portions are the same. For example, if the subnet mask is "255.255.255.0", it is normal for only the host address portions to be different.

	Network Address	Host Address	
IP Address	192.168.100.	250	Set the final number, which corresponds to "0" in the subnet mask, to 1–254.
Subnet Mask	255.255.255.	0	Usually, there are no problems when the subnet mask is "255.255.255.0". Use the same value for all of your computers.

✓ Related Information

- [I Want to Check that My Network Devices are Working Correctly](#)

-
- My Brother Machine Cannot Print, Scan, or PC-FAX Receive over the Network
-

Check the Machine Information

Follow these instructions to check your Brother machine's serial number, firmware version and firmware update.

1. Press  [Settings] > [All Settings] > [Machine Info.].
2. Press one of the following options:

Option	Description
Serial No.	Check your machine's serial number.
Firmware Version > Main Version	Check your machine's firmware version.
Firmware Update	Update your machine to the latest firmware.
Firmware Auto Check	View firmware information on the Home screen.

3. Press .

Related Information

- [Troubleshooting](#)

Reset Your Brother Machine

1. Press  [Settings] > [All Settings] > [Initial Setup] > [Reset].
2. Press the reset option you want to use.
3. Press [Yes] to confirm.
4. Press [Yes] for two seconds to reboot the machine.

Related Information

- [Troubleshooting](#)
 - [Reset Functions](#)
 - [LCD Overview](#)
 - [Transfer Your Faxes or Fax Journal Report](#)
-

Reset Functions

The following reset functions are available:

1. [Machine Reset]

You can reset all the machine's settings that you have changed, such as Date and Time and Ring Delay. The Address Book, fax reports, and Call history will remain.

2. [Network]

You can reset the print server back to its default factory settings, such as the password and IP address information.

3. [Address Book & Fax]

(MFC models)

Address book & Fax resets the following settings:

- Address Book
(Address Book and Setup Groups)
- Programmed fax jobs in the memory
(Polled Transmit, Delayed Fax and Delayed Batch Transmission)
- Station ID
(Name and Number)
- Remote Fax Options
(Fax Forwarding)
- Report
(Transmission Verification Report, Address Book and Fax Journal)
- History
(Caller ID history and Outgoing Call)
- Faxes in memory

4. [All Settings]

Use the Settings Reset function to reset all machine's settings to the settings originally set at the factory. Brother strongly recommends you perform this operation when you dispose of the machine.



(MFC-J985DW)

Unplug the interface cable before you select [Network] or [All Settings].



Related Information

- [Reset Your Brother Machine](#)
- [LCD Overview](#)
- [Transfer Your Faxes or Fax Journal Report](#)

Routine Maintenance

- [Replace the Ink Cartridges](#)
- [Clean Your Brother Machine](#)
- [Check Your Brother Machine](#)
- [Correct the Paper Feed to Clear Vertical Lines](#)
- [Pack and Ship Your Brother Machine](#)

Replace the Ink Cartridges

Your Brother machine is equipped with an ink dot counter. The ink dot counter automatically monitors the level of ink in each of the four cartridges. When the machine detects an ink cartridge is running out of ink, the machine will display a message.

The LCD displays which ink cartridge is low or needs replacing. Be sure to follow the LCD prompts to replace the ink cartridges in the correct order.

Even though the machine tells you to replace an ink cartridge, there will be a small amount of ink left in the ink cartridge. It is necessary to keep some ink in the ink cartridge to prevent air from drying out and damaging the print head assembly.

CAUTION

If the ink gets into your eye, rinse it with water immediately. If left as is, it may cause redness or mild inflammation of the eye. In case of any abnormality, consult your doctor.

IMPORTANT

Brother strongly recommends that you do not refill the ink cartridges provided with your machine. We also strongly recommend that you continue to use only Genuine Brother Brand replacement ink cartridges. Use or attempted use of potentially incompatible ink and/or cartridges in the Brother machine may cause damage to the machine and/or may result in unsatisfactory print quality. Our warranty coverage does not apply to any problem that is caused by the use of unauthorised third-party ink and/or cartridges. To protect your investment and obtain premium performance from the Brother machine, we strongly recommend the use of Genuine Brother Supplies.

1. Open the ink cartridge cover (1).

If one or more of the ink cartridges needs replacing, the LCD displays [B&W 1-sided Print Only] or [Cannot Print].

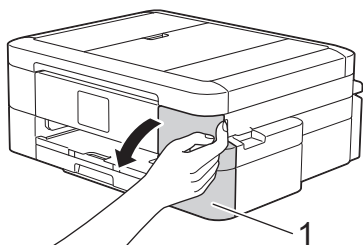

If the black cartridge is empty, the only message that will appear is [Cannot Print]. You must replace the black cartridge.

2. Press the lock release lever to release the cartridge colour indicated on the LCD and remove the cartridge from the machine, as shown in the illustration.

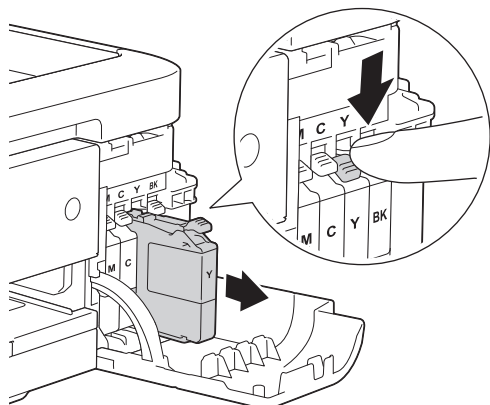

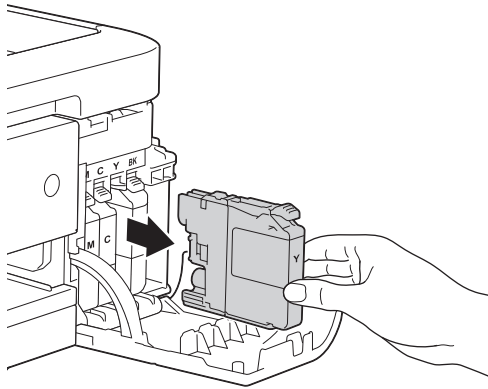

3. Open the new ink cartridge bag for the colour indicated on the LCD, and take out the ink cartridge.
4. Turn the green release lever on the orange protective packing (1) counterclockwise until it clicks to release the vacuum seal. Then remove the orange protective packing as shown.

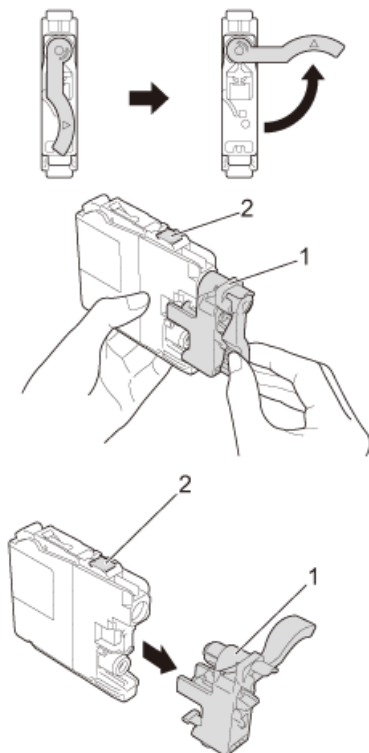

IMPORTANT

- DO NOT shake the ink cartridges. If your skin or clothes come into contact with the ink, wash your skin or clothes with water and soap immediately.
- DO NOT touch the cartridge in the area indicated (2); this can prevent the machine from detecting the cartridge.

5. Insert the ink cartridge in the direction of the arrow on the label.
Each colour has its own correct position.



6. Gently push the area marked "PUSH" until the ink cartridge latches, and then close the ink cartridge cover.

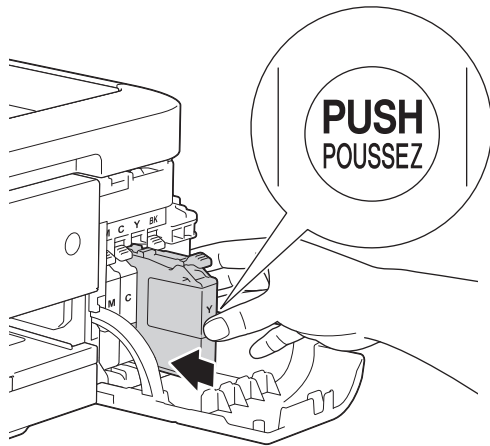

The machine will automatically reset the ink dot counter.



- If you replaced an ink cartridge, for example, the Black cartridge, the LCD may ask you to verify that it is a brand new one (for example, [Did you change Black]). For each new cartridge you installed, select [Yes] to reset the ink dot counter for that colour. If the ink cartridge you installed is not a brand new one, be sure to select [No].
- If the LCD displays [No Ink Cartridge] or [Cannot Detect] after you install the ink cartridge, check that the ink cartridge is installed correctly. Remove the ink cartridge and reinstall it slowly until it locks into place.

IMPORTANT

- DO NOT take out ink cartridges if you do not need to replace them; the machine will not know the quantity of ink left in the cartridge.
- DO NOT touch the cartridge insertion slots; the ink may stain your skin.
- If you mix the colours by installing an ink cartridge in the wrong position, the LCD shows [Wrong Ink Colour].
Check which ink cartridges are not matched by colour to their ink cartridge positions and move them to their proper positions.
- When you open an ink cartridge, install it in the machine and use it up within six months of installation. Use unopened ink cartridges by the expiration date written on the cartridge package.
- DO NOT dismantle or tamper with the ink cartridge; this can cause the ink to leak out of the cartridge.



Related Information

- [Routine Maintenance](#)
- [Error and Maintenance Messages](#)
- [Paper Handling and Printing Problems](#)
- [Pack and Ship Your Brother Machine](#)

Clean Your Brother Machine

- [Clean the Scanner](#)
- [Clean the Print Head from Your Brother Machine](#)
- [Clean the Print Head from Your Computer \(Windows®\)](#)
- [Clean the Print Head from Your Computer \(Mac\)](#)
- [Clean the Machine's LCD](#)
- [Clean the Outside of the Machine](#)
- [Clean the Machine's Printer Platen](#)
- [Clean the Paper Feed Rollers](#)
- [Clean the Paper Pick-up Rollers](#)

Clean the Scanner

1. Unplug the machine from the electrical socket.
2. Lift the document cover (1). Clean the scanner glass (2) and the white plastic (3) with a soft lint-free cloth moistened with a non-flammable glass cleaner.

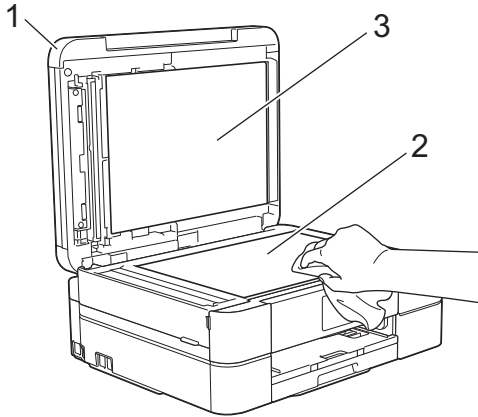

3. In the ADF unit, clean the white bar (1) and the glass strip (2) with a lint-free cloth moistened with a non-flammable glass cleaner. (ADF models only)

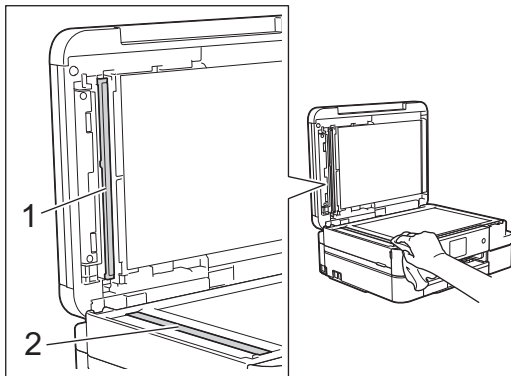

(ADF models only)

In addition to cleaning the scanner glass and glass strip with a non-flammable glass cleaner, run your fingertip over the glass to see if you can feel anything on it. If you feel dirt or debris, clean the glass again concentrating on that area. You may need to repeat the cleaning process three or four times. To test, make a copy after each cleaning attempt.



When there is a spot of dirt or correction fluid on the glass strip, the printed sample shows a vertical line.



After the glass strip is cleaned, the vertical line is gone.



Related Information

- [Clean Your Brother Machine](#)
 - [Telephone and Fax problems](#)
 - [Other Problems](#)
-

Clean the Print Head from Your Brother Machine

To maintain good print quality, the machine automatically cleans the print head when needed. If there is a print quality problem, start the cleaning process manually.

- Clean the print head if there is a horizontal line or a blank space in the text or graphics on printed pages. Depending on the problem colour, select to clean Black only, three colours at a time (Yellow/Cyan/Magenta), or all four colours at once.
- Cleaning the print head consumes ink.
- Cleaning too often uses ink unnecessarily.

IMPORTANT

DO NOT touch the print head. Touching the print head may cause permanent damage and may void the print head's warranty.

1. Press  [Ink] > [Print Head Cleaning].



You can also press  [Settings] > [Maintenance] > [Print Head Cleaning].

2. Press [Black only], [Colour only], or [All].
3. Press [Normal], [Strong], or [Strongest].
4. Press [Start].

The machine cleans the print head.



- If you clean the print head and the print has not improved, try installing a new Genuine Brother Brand replacement ink cartridge for each problem colour. Try cleaning the print head again. If the print has not improved, contact Brother customer service or your local Brother dealer.
- You can also clean the print head from your computer.





Related Information

- [Clean Your Brother Machine](#)
- [Paper Handling and Printing Problems](#)
- [Clean the Print Head from Your Computer \(Windows®\)](#)
- [Clean the Print Head from Your Computer \(Mac\)](#)

Clean the Print Head from Your Computer (Windows®)

To maintain good print quality, the machine automatically cleans the print head when needed. If there is a print quality problem, start the cleaning process manually.

- Do one of the following:
 - For Windows® XP and Windows Server® 2003
Click **Start > Printers and Faxes**.
 - For Windows Vista® and Windows Server® 2008
Click  (**Start**) > **Control Panel > Hardware and Sound > Printers**.
 - For Windows® 7 and Windows Server® 2008 R2
Click  (**Start**) > **Devices and Printers**.
 - For Windows® 8
Move your mouse to the lower right corner of your desktop. When the menu bar appears, click **Settings**, and then click **Control Panel**. In the **Hardware and Sound** group, click **View devices and printers**.
 - For Windows® 10
Click  > **All apps > Windows System > Control Panel**. In the **Hardware and Sound** group, click **View devices and printers**.
 - For Windows Server® 2012
Move your mouse to the lower right corner of your desktop. When the menu bar appears, click **Settings**, and then click **Control Panel**. In the **Hardware** group, click **View devices and printers**.
 - For Windows Server® 2012 R2
Click **Control Panel** on the **Start** screen. In the **Hardware** group, click **View devices and printers**.
- Right-click the **Brother MFC-XXXX Printer** icon (where XXXX is your model name), and then select **Printing preferences**. If printer driver options appear, select your printer driver.
The printer driver dialog box appears.
- Click the **Maintenance** tab.
- Select one of the following options:

Option	Description
Check Print Quality...	Use to print the test page and check the print quality.
Print Head Cleaning...	Use to start the cleaning process manually. Select if a line or blank spaces appear in text or graphics on the test page.

- Do one of the following:
 - If you selected the **Check Print Quality...** option, click **Start**.
The machine prints the test page.
 - If you selected the **Print Head Cleaning...** option, select the **Black only**, **Colour only**, or **All** option for the cleaning type, and then click **Next**.
- Select the **Normal**, **Strong**, or **Strongest** option for the cleaning strength, and then click **Next**.
- Click **Start**.
The machine starts cleaning.

Related Information

- [Clean Your Brother Machine](#)

-
- Paper Handling and Printing Problems
 - Clean the Print Head from Your Brother Machine
-

Clean the Print Head from Your Computer (Mac)

To maintain good print quality, the machine automatically cleans the print head when needed. If there is a print quality problem, start the cleaning process manually.

1. Select **System Preferences** from the Apple Menu.
2. Do one of the following:
 - (OS X v10.8.5)
Select **Print & Scan**, and then select the machine.
 - (OS X v10.9.x, 10.10.x)
Select **Printers & Scanners**, and then select the machine.
3. Click the **Options & Supplies** button.
4. Click the **Utility** tab, and then click the **Open Printer Utility** button.
The Status Monitor screen appears.
5. Click the **Control** menu, and then select **Maintenance**.
6. Select one of the following options:

Option	Description
Check Print Quality...	Use to print the test page and check the print quality.
Print Head Cleaning...	Use to start the cleaning process manually. Select if a line or blank spaces appear in text or graphics on the test page.

7. Do one of the following:
 - If you selected the **Check Print Quality...** option, click **Start**.
The machine prints the test page.
 - If you selected the **Print Head Cleaning...** option, select **Black only**, **Color only**, or **All** option for the cleaning type, and then click **Next**.
8. Select the **Normal**, **Strong**, or **Strongest** option for the cleaning strength, and then click **Next**.
9. Click **Start**.
The machine starts cleaning.



Related Information

- [Clean Your Brother Machine](#)
- [Paper Handling and Printing Problems](#)
- [Clean the Print Head from Your Brother Machine](#)

Clean the Machine's LCD

IMPORTANT

DO NOT use liquid cleaners (including ethanol).

1. Press and hold down  to turn off the machine. The LCD displays [Shutting Down] for a few seconds before the power goes off.
2. Clean the LCD with a dry, soft lint-free cloth.

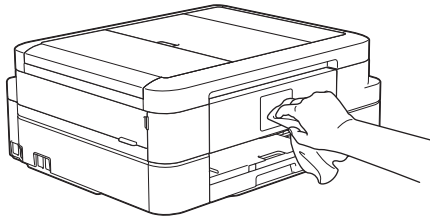

Related Information

- [Clean Your Brother Machine](#)

Clean the Outside of the Machine

IMPORTANT

- Use neutral detergents. Cleaning with volatile liquids such as thinner or benzine will damage the outside surface of the machine.
- DO NOT use cleaning materials that contain ammonia.
- DO NOT use isopropyl alcohol to remove dirt from the control panel. It may crack the panel.

1. If the paper support flap is open, close it, and then close the paper support.
2. Pull the paper tray (1) completely out of the machine.

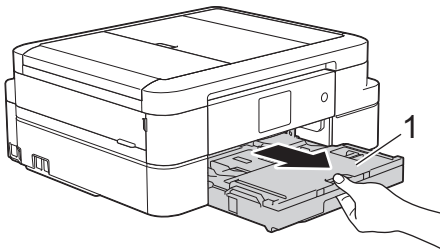

3. Wipe the outside of the machine with a dry, lint-free cloth to remove dust.

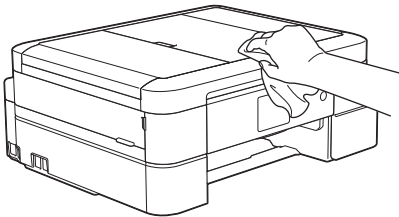

4. Lift the output paper tray cover and remove anything that is stuck inside the paper tray.

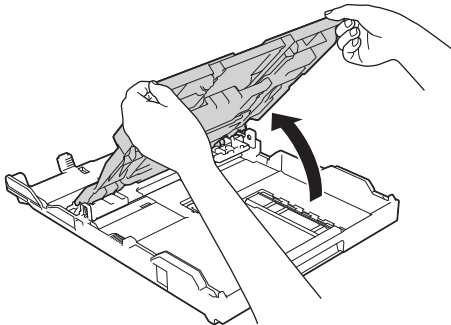

5. Wipe the inside and the outside of the paper tray with a dry, lint-free cloth to remove dust.

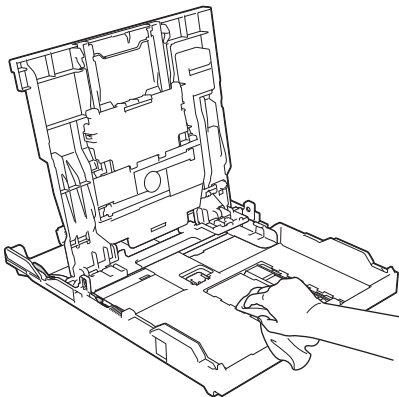

6. Close the output paper tray cover and put the paper tray firmly back in the machine.



Related Information

- [Clean Your Brother Machine](#)
-

Clean the Machine's Printer Platen

WARNING

 Be sure to unplug the machine from the electrical socket before cleaning the printer platen to avoid an electrical shock.

1. Place both hands under the plastic tabs on both sides of the machine to lift the scanner cover into the open position.
2. Clean the machine's printer platen (1) and the area around it, wiping off scattered ink with a dry, soft lint-free cloth.

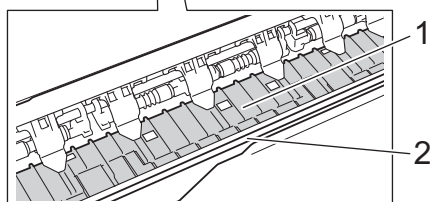
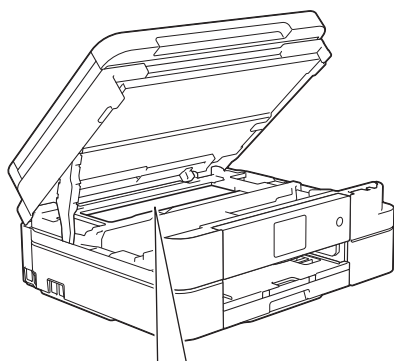

IMPORTANT

DO NOT touch the encoder strip, the thin strip of plastic that stretches across the width of the machine (2). Doing this will cause damage to the machine.

3. Gently close the scanner cover using both hands.

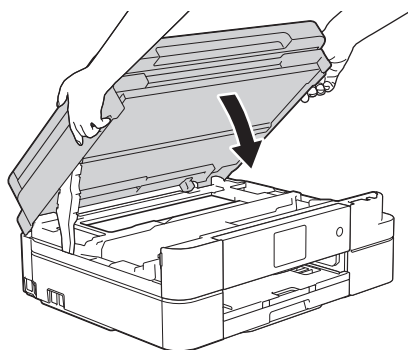

4. Reconnect the power cord.

Related Information

- [Clean Your Brother Machine](#)
- [Paper Handling and Printing Problems](#)

Clean the Paper Feed Rollers

If the paper feed rollers are stained with ink or have a buildup of paper dust, it may cause paper feed problems.

1. Unplug the machine from the electrical socket.
2. If the paper support flap is open, close it, and then close the paper support.
3. Pull the paper tray (1) completely out of the machine.

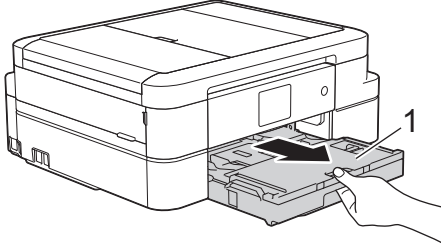

4. Clean the front side of the Paper Feed Rollers (1) with a soft lint-free cloth moistened with water, using a side-to-side motion. After cleaning, wipe the rollers with a dry, soft lint-free cloth to remove all moisture.

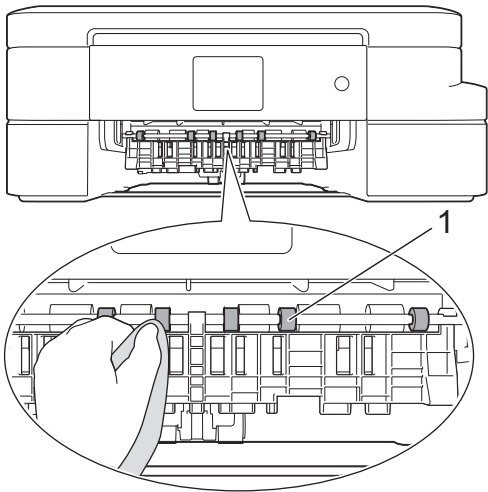

5. Lift the Jam Clear Flap (2), and then clean the back side of the Paper Feed Rollers (1) with a soft lint-free cloth moistened with water. After cleaning, wipe the rollers with a dry, soft lint-free cloth to remove all moisture.

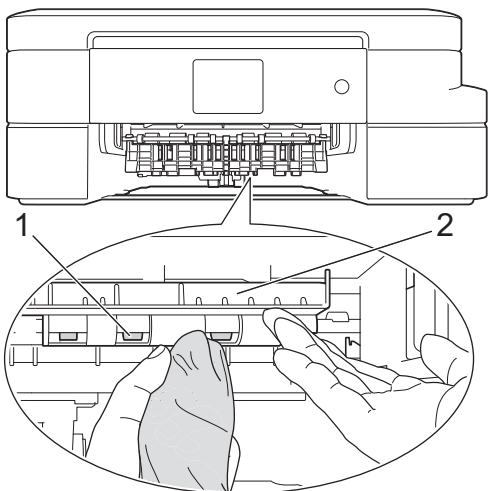

6. Put the paper tray firmly back in the machine.
7. Reconnect the power cord.



Do not use the machine again until the rollers are dry. Using the machine before the rollers are dry may cause paper feed problems.



Related Information

- [Clean Your Brother Machine](#)
 - [Paper Handling and Printing Problems](#)
-

Clean the Paper Pick-up Rollers

Cleaning the paper pick-up rollers periodically may prevent paper jams by ensuring that paper feeds properly.

1. Unplug the machine from the electrical socket.
2. If the paper support flap is open, close it, and then close the paper support.
3. Pull the paper tray completely out of the machine.



- If the machine has been feeding multiple pages when there are only a few sheets of paper left in the tray, clean the paper tray Base Pad (1) and the photo paper tray Base Pad (2) with a soft lint-free cloth moistened with water.

After cleaning, wipe the pad with a dry, soft lint-free cloth to remove all moisture.

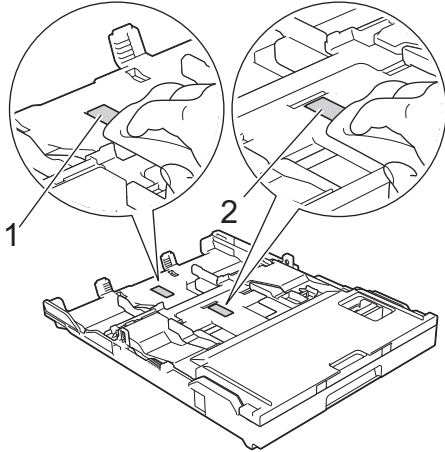

4. Clean the Paper Pick-up Rollers (1) with a soft lint-free cloth moistened with water. Slowly turn the rollers so that the whole surface is cleaned. After cleaning, wipe the rollers with a dry, soft lint-free cloth to remove all moisture.

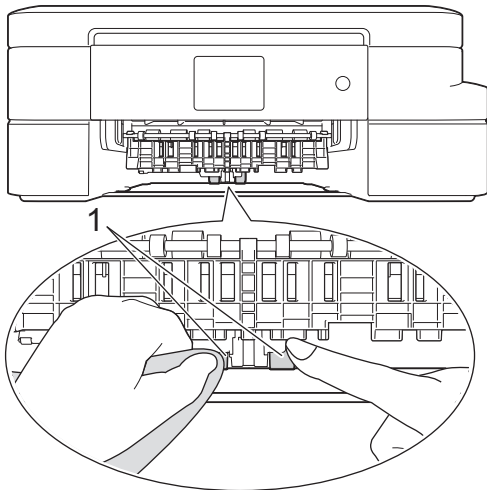

5. Put the paper tray firmly back in the machine.
6. Reconnect the power cord.



Related Information

- [Clean Your Brother Machine](#)
- [Error and Maintenance Messages](#)
- [Paper Handling and Printing Problems](#)

Check Your Brother Machine

- [Check the Print Quality](#)
- [Check the Print Alignment from Your Brother Machine](#)
- [Check the Ink Volume](#)
- [Monitor Machine Status from Your Computer \(Windows®\)](#)
- [Monitor Machine Status from Your Computer \(Mac\)](#)

Check the Print Quality

If faded or streaked colours and text appear or if text is missing on your printouts, the print head nozzles may be clogged. Print the Print Quality Check Sheet and look at the nozzle check pattern.

>> [DCP-J785DW](#)

>> [MFC-J985DW](#)

DCP-J785DW

1. Press  [Ink] > [Improve Print Quality] > [Check Print Quality].



You can also press  [Settings] > [Maintenance] > [Improve Print Quality] > [Check Print Quality].

2. Press [Start].

The machine prints the Print Quality Check Sheet.

3. Check the quality of the four colour blocks on the sheet.

4. The touchscreen asks about the print quality. Do one of the following:

- If all lines are clear and visible, press [No], and then press  to finish the Print Quality check.
- If lines are missing (see **Poor**, below), press [Yes].

OK

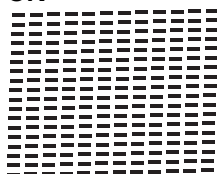

Poor

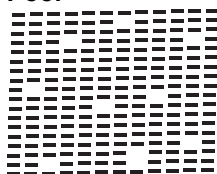

5. The touchscreen asks you to check the print quality of each colour. Press the number of the pattern (1–4) that most closely matches the printing result.

6. Do one of the following:

- If print head cleaning is needed, press [Start] to start the cleaning procedure.
- If print head cleaning is not needed, the Maintenance screen reappears on the LCD. Press .

7. After the cleaning procedure is finished, the touchscreen asks if you want to print the Print Quality Check Sheet again. Press [Yes], and then press [Start].

The machine prints the Print Quality Check Sheet again. Check the quality of the four colour blocks on the sheet again.

If you clean the print head and the print has not improved, try installing a new Genuine Brother Brand replacement ink cartridge for each problem colour. Try cleaning the print head again. If the print has not improved, contact Brother customer service or your local Brother dealer.

IMPORTANT

DO NOT touch the print head. Touching the print head may cause permanent damage and may void the print head's warranty.



When a print head nozzle is clogged, the printed sample looks like this.



After the print head nozzle is cleaned, the horizontal lines are gone.



MFC-J985DW

1. Press  [Ink] > [Improve Print Quality] > [Check Print Quality].



You can also press  [Settings] > [Maintenance] > [Improve Print Quality] > [Check Print Quality].

2. Press [Start].
The machine prints the Print Quality Check Sheet.
3. Check the quality of the four colour blocks on the sheet.
4. The touchscreen asks about the print quality. Do one of the following:
 - If all lines are clear and visible, press [No], and then press  to finish the Print Quality check.
 - If lines are missing (see **Poor**, below), press [Yes].

OK

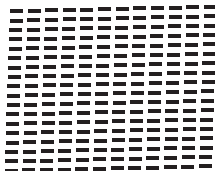

Poor

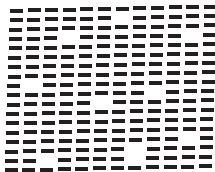

5. The touchscreen asks you to check the print quality of each colour. Press the number of the pattern (1–4) that most closely matches the printing result.
6. Do one of the following:
 - If print head cleaning is needed, press [Start] to start the cleaning procedure.
 - If print head cleaning is not needed, the Maintenance screen reappears on the LCD. Press .
7. After the cleaning procedure is finished, the touchscreen asks if you want to print the Print Quality Check Sheet again. Press [Yes], and then press [Start].

The machine prints the Print Quality Check Sheet again. Check the quality of the four colour blocks on the sheet again.

If you clean the print head and the print has not improved, try installing a new Genuine Brother Brand replacement ink cartridge for each problem colour. Try cleaning the print head again. If the print has not improved, contact Brother customer service or your local Brother dealer.

IMPORTANT

DO NOT touch the print head. Touching the print head may cause permanent damage and may void the print head's warranty.



When a print head nozzle is clogged, the printed sample looks like this.



After the print head nozzle is cleaned, the horizontal lines are gone.



Related Information

- [Check Your Brother Machine](#)
 - [Paper Handling and Printing Problems](#)
-

Check the Print Alignment from Your Brother Machine

If your printed text becomes blurred or images become faded after transporting the machine, adjust the print alignment.

1. Press  [Ink] > [Improve Print Quality] > [Alignment].



You can also press  [Settings] > [Maintenance] > [Improve Print Quality] > [Alignment].

2. Press [Next], and then press [Start].

The machine starts printing the Alignment Check Sheet.

(A)

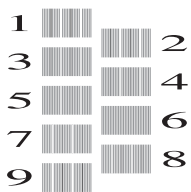

3. For the (A) pattern, press ▲ or ▼ to display the number of the test print with the fewest visible vertical stripes (1-9), and then press it (in the example above, row number 6 is the best choice). Press [OK].

Repeat this step for the rest of the patterns.



When the print alignment is not adjusted correctly, text looks blurry or crooked, like this.

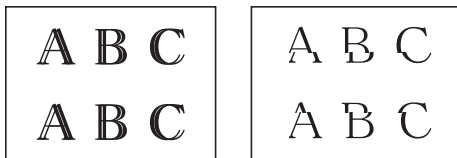

After the print alignment is adjusted correctly, text looks like this.



4. Press .



Related Information

- [Check Your Brother Machine](#)
- [Paper Handling and Printing Problems](#)



Check the Ink Volume

Although an ink volume icon appears on the machine's LCD, you can use the ink menu to see a large graph showing the ink left in each cartridge.

1. Press  [Ink] > [Ink Volume]. The touchscreen displays the ink volume.



- You can also press  [Settings] > [Maintenance] > [Ink Volume].
- When the ink cartridge is near the end of its life or having a problem, one of the following icons is displayed.

	The ink level is low.
	The ink cartridge is at the end of its life.
	There is a problem with the ink cartridge.

- To check or print the model numbers of the ink cartridges, press  (Back) to go back to the [Ink] menu screen.
Press [Ink Cartridge Model], and follow the instruction on the touchscreen.

2. Press .



You can also check the ink volume from your computer.



Related Information

- [Check Your Brother Machine](#)
- [LCD Overview](#)
- [Settings Screen Overview](#)
- [Print a Document \(Windows®\)](#)
- [Print a Document \(Mac\)](#)
- [Monitor Machine Status from Your Computer \(Windows®\)](#)

Monitor Machine Status from Your Computer (Windows®)

The Status Monitor utility is a configurable software tool for monitoring the status of one or more devices; it allows you to get immediate notification of errors.

• Do one of the following:

- Double-click the  icon in the task tray.
- Windows® XP, Windows Vista® and Windows® 7

Click  (**Start**) > **All Programs** > **Brother** > **Brother Utilities**.

Click the drop-down list and select your model name (if not already selected). Click **Tools** in the left navigation bar, and then click **Status Monitor**.

- Windows® 8 and Windows® 10

Launch  (**Brother Utilities**), and then click the drop-down list and select your model name (if not already selected). Click **Tools** in the left navigation bar, and then click **Status Monitor**.





Troubleshooting

Click the **Troubleshooting** button to access the troubleshooting website.

Looking for replacement supplies?

Click the **Looking for replacement supplies?** button for more information on Brother original supplies.

Error icons

Icon	Description
	The ink level is low.
	The ink cartridge is at the end of its life.
	There is a problem with the ink cartridge.



Related Information

- [Check Your Brother Machine](#)
- [Status Monitor Indicators and What They Mean \(Windows®\)](#)

-
- Turn Off the Show Status Monitor Feature (Windows®)
 - Turn Off the Status Monitor (Windows®)
 - Cancel a Print Job (Windows®)
 - Check the Ink Volume
-

Status Monitor Indicators and What They Mean (Windows®)

When you start up your computer, the **Brother Status Monitor** icon appears on the task tray.

- A green icon indicates the normal stand-by condition.



- A yellow icon indicates a warning.



- A red icon indicates an error has occurred.



- A grey icon indicates the machine is offline.



✓ Related Information

- [Monitor Machine Status from Your Computer \(Windows®\)](#)

Turn Off the Show Status Monitor Feature (Windows®)

The Show Status Monitor feature lets you know if there is a problem with a device that your computer is monitoring. The default setting is **Only when printing from this PC**. To turn it off, follow these steps:

1. Right-click the  (**Brother Status Monitor**) icon or window, select the **Status Monitor Settings** option, and then click **Options**.
The **Options** window appears.
2. Select the **Basic** tab, and then select **Off** for **Show Status Monitor**.
3. Click **OK**.



Even if the Show Status Monitor feature is turned off, you can check the machine's status at any time by displaying the Status Monitor.



Related Information

- [Monitor Machine Status from Your Computer \(Windows®\)](#)

Turn Off the Status Monitor (Windows®)

1. Right-click the  (Brother Status Monitor) icon or window, and then select **Exit**.
2. Click **OK**.



Related Information

- [Monitor Machine Status from Your Computer \(Windows®\)](#)

Monitor Machine Status from Your Computer (Mac)

Brother's Status Monitor utility program is a configurable software tool for monitoring the status of a device and notifying you immediately in the event of an error.

1. Select **System Preferences** from the Apple Menu.
2. Do one of the following:
 - (OS X v10.8.5)
Select **Print & Scan**, and then select the machine.
 - (OS X v10.9.x, 10.10.x)
Select **Printers & Scanners**, and then select the machine.
3. Click the **Options & Supplies** button.
4. Click the **Utility** tab, and then click the **Open Printer Utility** button.
The Status Monitor screen appears.

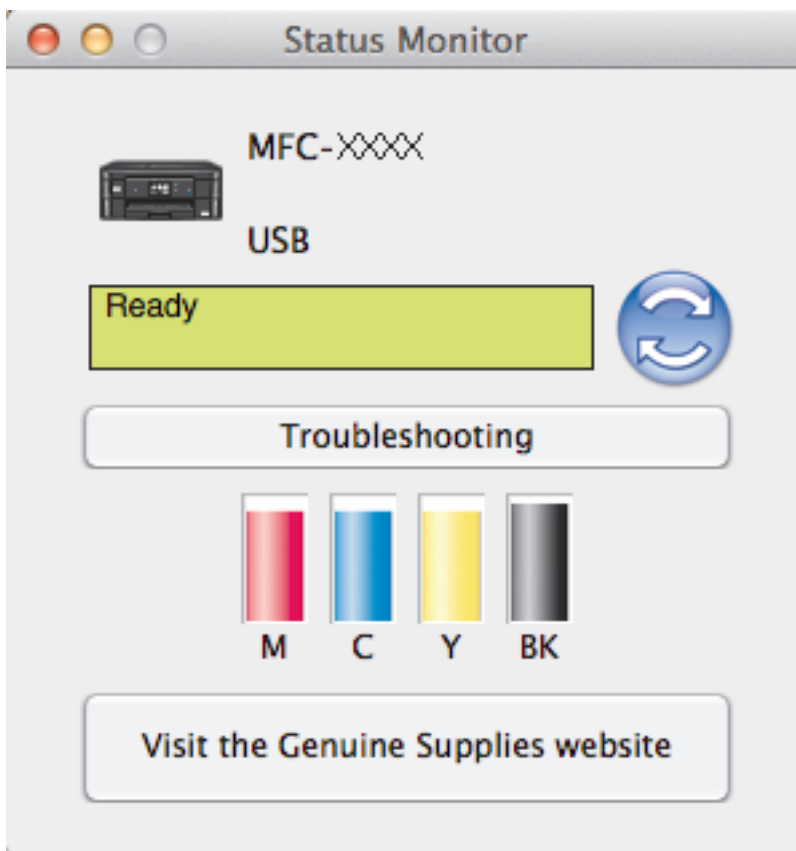

Troubleshooting

Click the **Troubleshooting** button to access the Brother Solutions Center, offering FAQs and troubleshooting tips.



Visit the Genuine Supplies website

Click the **Visit the Genuine Supplies website** button for more information about Brother genuine supplies.

Updating the machine's status

To view the latest machine status while the **Status Monitor** window is open, click the  icon. To set the interval at which the software updates the machine status information, click the **Brother Status Monitor** menu, and then select **Preferences**.

Error icons

Icon	Description
	The ink level is low.
	The ink cartridge is at the end of its life.
	There is a problem with the ink cartridge.



Related Information

- [Check Your Brother Machine](#)
-

Correct the Paper Feed to Clear Vertical Lines

Adjust the paper feed to reduce vertical lines. (This feature is available only for Plain paper.)

1. Press  [Ink] > [Improve Print Quality] > [Correct Paper Feed].



You can also press  [Settings] > [Maintenance] > [Improve Print Quality] > [Correct Paper Feed].

2. Press the [Next] button, and then follow the instructions on the touchscreen.



Related Information

- [Routine Maintenance](#)

Pack and Ship Your Brother Machine

- When you transport the machine, use the packing materials that came with your machine. If you do not pack the machine correctly, any damage that may occur in transit may not be covered by your warranty.
- The machine should be adequately insured with the carrier.

IMPORTANT

It is important to allow the machine to “park” the print head after a print job. Listen carefully to the machine before unplugging it to make sure that all mechanical noises have stopped. Not allowing the machine to finish this parking process may lead to print problems and possible damage to the print head.

1. Unplug the machine from the electrical socket.
2. Unplug the machine from the telephone wall socket and take the telephone line cord out of the machine.
3. Place both hands under the plastic tabs on both sides of the machine to lift the scanner cover into the open position. Then unplug the interface cable from the machine, if it is connected.
4. Gently close the scanner cover using both hands.

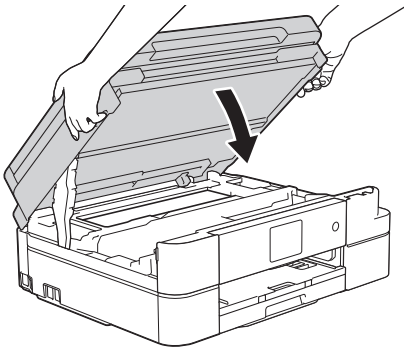

5. Open the ink cartridge cover.
6. Press the ink release levers to release the ink cartridges, and then take out the ink cartridges.
7. Install the orange protective part, and then close the ink cartridge cover.

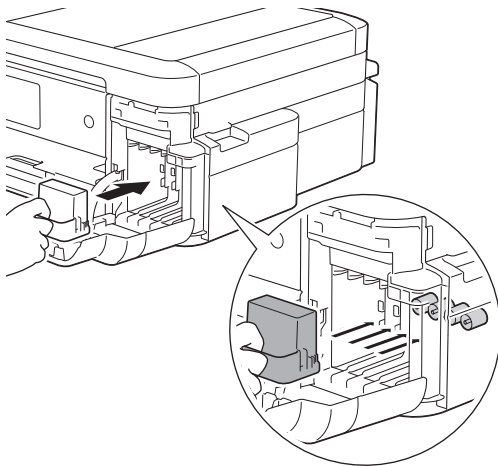

IMPORTANT

- Make sure the plastic tab on the left side of the orange protective part (1) locks securely into place (2).

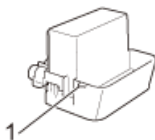

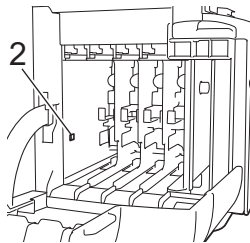

- If you are not able to find the orange protective part, ship the machine without it. DO NOT leave the ink cartridges in the machine during shipping.

8. Wrap the machine in the bag.

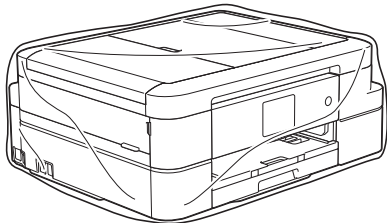

9. Pack the machine and the printed materials in the original carton with the original packing material as shown below. Do not pack the used ink cartridge in the carton.

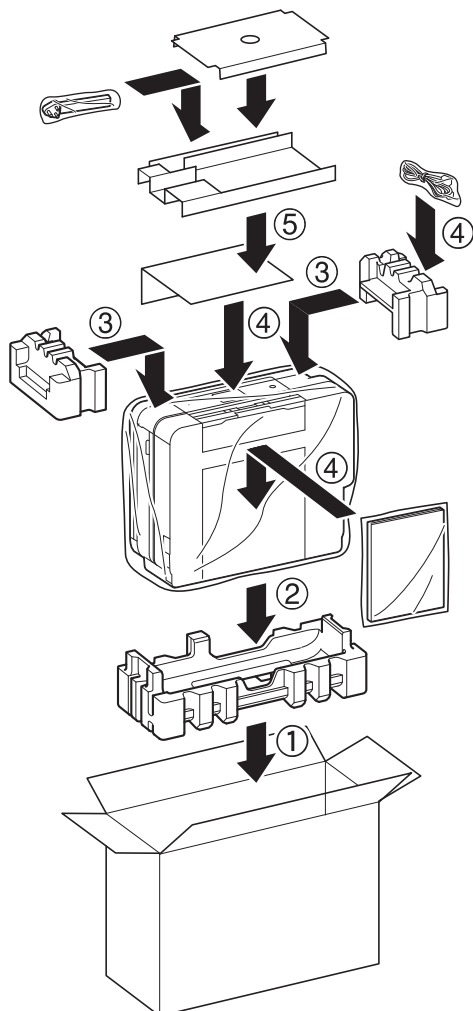

10. Close the carton and tape it shut.



Related Information

- [Routine Maintenance](#)
- [Replace the Ink Cartridges](#)

Machine Settings

Customise settings and features, create shortcuts, and work with options displayed on the machine's LCD to make your Brother machine a more efficient work tool.

- [Change Machine Settings from the Control Panel](#)
- [Change Machine Settings from Your Computer](#)

Change Machine Settings from the Control Panel

- [In the Event of Power Failure \(Memory Storage\)](#)
- [General Settings](#)
- [Save Your Favourite Settings as a Shortcut](#)
- [Print Reports](#)
- [Settings and Features Tables](#)

In the Event of Power Failure (Memory Storage)

DCP-J785DW

- Your menu settings are stored permanently and will not be lost.
- Temporary settings will be lost.
- The date and time must be re-entered.

MFC-J985DW

- Your menu settings are stored permanently and will not be lost.
- Temporary settings will be lost.
- The date and time and programmed fax timer jobs (for example: Delayed Fax) will be retained for approximately 24 hours.
- Other fax jobs in the machine's memory will not be lost.



Related Information

- [Change Machine Settings from the Control Panel](#)
-

General Settings

- [Adjust the Machine Volume](#)
- [Change for Daylight Saving Time Automatically](#)
- [Set Sleep Mode Countdown](#)
- [Set the Machine to Power Off Automatically](#)
- [Set the Date & Time](#)
- [Adjust the LCD Backlight Brightness](#)
- [Change How Long the LCD Backlight Stays On](#)
- [Set Your Station ID](#)
- [Set Tone or Pulse Dialling Mode](#)
- [Reduce Printing Noise](#)
- [Change the Language Displayed on the LCD](#)
- [Change the Keyboard Setting](#)

Adjust the Machine Volume

1. Do one of the following:

- For MFC models:

Press  [Settings] > [All Settings] > [General Setup] > [Volume].

- For DCP models:

Press  [Settings] > [All Settings] > [General Setup] > [Beep].

2. Press one of the following options (MFC models):

Option	Description
Ring	Adjust the ring volume.
Beep	Adjust the volume when you press a button, make a mistake, or after you send or receive a fax.
Speaker	Adjust the speaker volume.

3. Press ▲ or ▼ to display the [Off], [Low], [Med], or [High] option, and then press the option you want.

4. Press .

Related Information



- [General Settings](#)

Change for Daylight Saving Time Automatically

Related Models: MFC-J985DW

You can program the machine to change automatically for Daylight Saving Time.

It will reset itself forward one hour in the spring, and backward one hour in the autumn. Make sure you have set the correct date and time in the [Date & Time] setting.



1. Press  [Settings].
2. Press  [Date & Time] > [Auto Daylight].
3. Press [On] or [Off].
4. Press .

✓ Related Information

- [General Settings](#)

Set Sleep Mode Countdown

The Sleep Mode (or Power Save Mode) setting can reduce power consumption. When the machine is in Sleep Mode, it acts as though it is turned off. The machine will wake up and start printing when it receives a print job or a fax. Use these instructions to set a time delay to send the machine into Sleep Mode.

- The timer will restart if any operation is carried out on the machine, such as receiving a fax or a print job.
 - The factory setting is five minutes.
 - When the machine goes into Sleep Mode, the LCD backlight turns off.
1. Press  [Settings] > [All Settings] > [General Setup] > [Sleep Mode].
 2. Press ▲ or ▼ to display the [1Min], [2Mins], [3Mins], [5Mins], [10Mins], [30Mins], or [60Mins] option, and then press the option you want.
 3. Press .



Related Information

- [General Settings](#)
- [Set the Machine to Power Off Automatically](#)

Set the Machine to Power Off Automatically



The Auto Power Off feature can save power consumption. Set the amount of time that the machine will be in Sleep Mode before it automatically powers off. When this feature is set to [Off], you must power off the machine manually.

To turn on the machine after the Auto Power Off feature has turned it Off, press .



The machine will not power off automatically when:

- The machine is connected to a wired network. (MFC-J985DW)
- The machine is connected to a wireless network.
- [WLAN Enable] is set to [On] or [WLAN] is selected in the [Network I/F] setting.

1. Press  [Settings] > [All Settings] > [General Setup] > [Auto Power Off].
2. Press ▲ or ▼ to display the [Off], [1hour], [2hours], [4hours], or [8hours] option, and then press the option you want.
3. Press .



Related Information

- [General Settings](#)
- [Set the Fax Journal's Interval Period](#)
- [Set Sleep Mode Countdown](#)
- [Fax Reports](#)



Set the Date & Time

(MFC models)

The LCD displays the date and time. If they are not current, re-enter them. You can add the date and time to each fax you send by setting your Station ID.

(DCP models)

If the machine's power has been off, the machine's date and time may not be current. Re-enter them.

1. Press  [Settings].
2. Press  [Date & Time].
3. Press [Date].
4. Enter the last two digits of the year on the touchscreen, and then press [OK].
5. Enter two digits for the month on the touchscreen, and then press [OK].
6. Enter two digits for the day on the touchscreen, and then press [OK].
7. Press [Time].
8. Enter the time (in 24-hour format) using the touchscreen.
Press [OK].
9. Press .





Related Information

- [General Settings](#)
- [Set Your Station ID](#)

Adjust the LCD Backlight Brightness

If you are having difficulty reading the LCD, try changing the brightness setting.

1. Press  [Settings] > [All Settings] > [General Setup] > [LCD Settings] > [Backlight].
2. Press the [Light], [Med], or [Dark] option.
3. Press .





Related Information

- [General Settings](#)
-

Change How Long the LCD Backlight Stays On

You can set how long the LCD backlight stays on after the last finger press.

1. Press  [Settings] > [All Settings] > [General Setup] > [LCD Settings] > [Dim Timer].
2. Press ▲ or ▼ to display the [Off], [10Secs], [20Secs], or [30Secs] option, and then press the option you want.
3. Press .



Related Information

- [General Settings](#)
-



Set Your Station ID

Related Models: MFC-J985DW

Set the machine's Station ID if you want the date and time to appear on each fax you send.

1. Press  [Settings] > [All Settings] > [Initial Setup] > [Station ID].
2. Press [Fax].
3. Enter your fax number (up to 20 digits) on the touchscreen, and then press [OK].
4. Press [Name].
5. Enter your name (up to 20 characters) using the touchscreen, and then press [OK].



- Press  to cycle between letters, numbers and special symbols. (The available characters may differ depending on your country.)
- If you entered an incorrect character and want to change it, press ◀ or ▶ to move the cursor to it. Press  and then enter the correct character.
- To enter a space, press [Space].

6. Press .



Related Information



- [General Settings](#)
- [Transfer Faxes to Another Fax Machine](#)
- [Transfer the Fax Journal Report to Another Fax Machine](#)
- [Enter Text on Your Brother Machine](#)
- [Set the Date & Time](#)

Set Tone or Pulse Dialling Mode

Related Models: MFC-J985DW

Your Brother machine is set for a Tone dialling service. If you have a Pulse dialling (rotary) service, you must change the dialling mode.

This feature is not available in some countries.

1. Press  [Settings] > [All Settings] > [Initial Setup] > [Tone/Pulse].
2. Press [Tone] or [Pulse].
3. Press .

Related Information

- [General Settings](#)
- [Telephone and Fax problems](#)



Reduce Printing Noise

The Quiet Mode setting can reduce printing noise. When Quiet Mode is turned on, the print speed becomes slower.

The factory setting is [Off].



- When the Quiet Mode setting is turned on,  is displayed on the Home screen.

1. Press  [Settings] > [Quiet Mode].
2. Press [On] or [Off].
3. Press .





Related Information

- [General Settings](#)
- [LCD Overview](#)

Change the Language Displayed on the LCD

Change the LCD language if needed.

This feature is not available in some countries.



1. Press  [Settings] > [All Settings] > [Initial Setup] > [Local Language].
2. Press your language.
3. Press .

Related Information

- [General Settings](#)
-

Change the Keyboard Setting

You can choose the type of keyboard for the LCD.

1. Press  [Settings] > [All Settings] > [General Setup] > [Keyboard Settings].
2. Press [QWERTY] or [ABC].
3. Press .



Related Information

- [General Settings](#)

Save Your Favourite Settings as a Shortcut

- [Add Shortcuts](#)
- [Change or Delete Shortcuts](#)



Add Shortcuts

You can add the fax, copy, scan and Web Connect settings you use most frequently by saving them as your Shortcuts. Later you can recall and apply these settings instead of re-entering them.



Some Shortcut menus are not available depending on your model.

These instructions describe how to add a Copy Shortcut. The steps for adding a Fax, Scan, or Web Connect shortcut are very similar.

1. Press  [Shortcuts].
2. Press  where you have not added a Shortcut.
3. Press ▲ or ▼ to display [Copy].
4. Press [Copy].
5. Read the information on the touchscreen, and then confirm it by pressing [OK].
6. Press ▲ or ▼ to display the available settings, and then press the setting you want to change.
7. Press ▲ or ▼ to display the available options for the setting, and then press the option you want.
Repeat the previous and this steps until you have selected all the settings for this Shortcut.
8. When you are finished changing the settings, press [Save as Shortcut].
9. Read and confirm the displayed list of settings you have selected, and then press [OK].
10. Enter a name for the Shortcut using the touchscreen.
Press [OK].
11. Press [OK] to save your Shortcut.



Related Information

- [Save Your Favourite Settings as a Shortcut](#)

Change or Delete Shortcuts

You can change the settings in a Shortcut.

You cannot change a Web Connect Shortcut. If you need to change a Web Connect Shortcut, delete it, and then add a new Shortcut.

1. Press  [Shortcuts].
2. Press ◀ or ▶ to display the Shortcut you want to change.
3. Press the Shortcut you want to change. The settings for the Shortcut you selected are displayed.



To delete the Shortcut or edit the name, press and hold the Shortcut until the options appear and then follow the on-screen menus.

4. Press [Options].
5. Change the settings for the Shortcut you selected.
6. Press [Save as Shortcut] when you are finished changing the settings.
7. Press [OK] to confirm.
8. Do one of the following:
 - If you want to overwrite the Shortcut, press [Yes].
Press [OK] to finish.
 - If you do not want to overwrite the Shortcut, press [No] to enter a new Shortcut name. Go to the next step.
9. To edit the name, hold down  to delete the current name, and then enter a new name using the touchscreen. Press [OK].
10. Press [OK] to confirm.



Related Information

- [Save Your Favourite Settings as a Shortcut](#)
- [Enter Text on Your Brother Machine](#)

Print Reports

- [Reports](#)
- [Print a Report](#)
- [Fax Reports](#)
- [Telephone and Fax problems](#)

Reports

The following reports are available:

Transmission Verify (MFC models)

The Transmission Verify prints a Transmission Verification Report for your last transmission.

Address Book (MFC models)

The Address Book report prints an alphabetical list of names and numbers stored in the Address Book memory.

Fax Journal (MFC models)

The Fax Journal prints a list of information about your last 200 incoming and outgoing faxes. (TX means Transmit, RX means Receive)

User Settings

The User Settings report prints a list of your current settings.

Network Configuration

The Network Configuration report prints a list of your current network settings.

WLAN Report

The WLAN Report prints the wireless LAN connectivity diagnosis.

Caller ID history (MFC models)



The Caller ID history report prints a list of the available Caller ID information for the last 30 received faxes and telephone calls.



Related Information

- [Print Reports](#)

Print a Report

1. Press  [Settings] > [All Settings] > [Print Reports].
2. Press ▲ or ▼ to display the report you want to print, and then press it.
3. Press [OK].
4. Press .



Related Information

- [Print Reports](#)
 - [Caller ID](#)
-

Settings and Features Tables

- [Settings Tables \(2.7"\(67.5 mm\) Touchpanel models\)](#)
- [Features Tables \(2.7"\(67.5 mm\) Touchpanel models\)](#)

Settings Tables (2.7"(67.5 mm) Touchpanel models)

These tables will help you understand your machine's menu selections and options.



[Settings]

Level 1	Level 2	Descriptions
 (Date & Time)	Date	(MFC models)
	Time	Add the date and time on the screen and in the headings of the faxes you send. (DCP models) Set the date and time on your machine.
	Auto Daylight (MFC models)	Set the machine to change automatically for Daylight Saving Time.
Maintenance	Improve Print Quality	Check and correct the print quality, alignment and paper feeding according to the on-screen instructions.
	Print Head Cleaning	Clean the print head according to the on-screen instructions.
	Ink Volume	Check the available ink volume.
	Ink Cartridge Model	Check your ink cartridge numbers.
Wi-Fi	TCP/IP	Set TCP/IP protocol.
	WLAN Assistant	Configure your wireless network settings using the Brother CD-ROM.
	Setup Wizard	Configure your internal print server manually.
	WPS/AOSS	Configure your wireless network settings using the one-button push method.
	WPS w/ PIN Code	Configure your wireless network settings using WPS with a PIN.
	WLAN Status	View the current wireless network status.
	MAC Address	View the machine's MAC address.
Paper Type (DCP-J785DW)	-	Set the type of paper in the paper tray.
Paper Size (DCP-J785DW)	-	Set the size of paper in the paper tray.
Quiet Mode	-	Decrease printing noise.
Tray Setting (MFC-J985DW)	Paper Type	Set the type of paper in the paper tray.
	Paper Size	Set the size of paper in the paper tray.
Fax Preview (MFC-J985DW)	-	View faxes you receive on the LCD.
All Settings	-	Configure the detailed settings.



[Settings] > [All Settings] > [General Setup]

Level 1	Level 2	Descriptions
Maintenance	Improve Print Quality	Check and correct the print quality, alignment and paper feeding according to the on-screen instructions.

Level 1	Level 2	Descriptions
Maintenance	Print Head Cleaning	Clean the print head according to the on-screen instructions.
	Ink Volume	Check the available ink volume.
	Ink Cartridge Model	Check your ink cartridge numbers.
Paper Type	-	Set the type of paper in the paper tray.
Paper Size	-	Set the size of paper in the paper tray.
Check Paper	-	Check the paper type and paper size when you pull the tray out of the machine.
Quiet Mode	-	Decrease printing noise.
Beep (DCP models)	-	Adjust the beeper volume.
Volume (MFC models)	Ring	Adjust the ring volume.
	Beep	Adjust the beeper volume.
	Speaker	Adjust the speaker volume.
LCD Settings	Backlight	Adjust the brightness of the LCD backlight.
	Dim Timer	Set how long the LCD backlight stays on after the last finger press.
Keyboard Settings	-	Select the type of keyboard for the LCD.
Sleep Mode	-	Select how long the machine must be idle before it goes into Sleep Mode.
Auto Power Off	-	Select how long the machine must wait before it automatically turns itself off after entering Sleep Mode. When set to Off, the machine will not power off automatically.



[Settings] > [All Settings] > [Shortcut Settings]

Level 1	Level 2	Descriptions
(Select shortcut button.)	Edit Shortcut Name	Change the shortcut name.
	Delete	Delete the shortcut.



[Settings] > [All Settings] > [Fax] (MFC models)

Level 1	Level 2	Level 3	Descriptions
Setup Receive	Ring Delay	-	Set the number of rings before the machine answers in Fax Only or Fax/Tel mode.
	Receive Mode	-	Select the Receive Mode that best suits your needs.
	F/T Ring Time	-	Set the length of the pseudo/double-ring time in Fax/Tel mode.
	Fax Preview	-	View faxes you receive on the LCD.
	Fax Detect	-	Receive fax messages automatically when you answer a call and hear fax tones.
	Remote Codes	-	Answer calls at an extension or external telephone and use codes to turn the machine on or off. You can personalise the codes.
	Auto Reduction	-	Reduce the size of incoming faxes.
	Memory Receive	-	Set the machine to forward fax messages, to store incoming faxes in the memory (so you can retrieve them while you are away from your machine), or to send faxes to your computer or the cloud service.

Level 1	Level 2	Level 3	Descriptions
Setup Receive			If you select Fax Forward, PC-Fax Receive, or Forward to Cloud, you can turn on the Backup Print safety feature.
	Fax Rx Stamp	-	Print the received time and date on the top of the received faxes.
Report Setting	XMIT Report	-	Select the initial setup for the Transmission Verification Report.
	Journal Period	-	Set the interval for automatic printing of the Fax Journal. If you select other than Off and Every 50 Faxes, you can set the time for the option. If you select Every 7 Days, you can set the day of the week.
Print Document	-	-	Print received faxes stored in the memory.
Remote Access	-	-	Set your own code for Remote Retrieval.
Remaining Jobs	-	-	Check which scheduled jobs are in the memory and cancel selected jobs.
Miscellaneous	Memory Security	-	Prohibit most functions except receiving faxes into memory.
	BT Call Sign (U.K. only)	-	Use with BT Call Sign.
	Caller ID (U.K. and Ireland only)	-	View or print a list of the last 30 Caller IDs stored in the memory.



[Settings] > [All Settings] > [Network]

Level 1	Level 2	Level 3	Descriptions
Wired LAN (MFC-J985DW)	TCP/IP	BOOT Method	Select the BOOT method that best suits your needs.
		IP Address	Enter the IP address.
		Subnet Mask	Enter the Subnet mask.
		Gateway	Enter the Gateway address.
		Node Name	Enter the Node name.
		WINS Configuration	Select the WINS configuration mode.
		WINS Server	Specify the IP address of the primary or secondary WINS server.
		DNS Server	Specify the IP address of the primary or secondary DNS server.
		APIPA	Set the machine to allocate the IP address from the link-local address range automatically.
	IPv6	Turn the IPv6 protocol on or off. To use the IPv6 protocol, go to the Brother Solutions Center at support.brother.com for more information.	
	Ethernet	-	Select the Ethernet link mode.
Wired Status	-	View the current wired status.	
MAC Address	-	View the machine's MAC address.	
WLAN	TCP/IP	BOOT Method	Select the BOOT method that best suits your needs.
		IP Address	Enter the IP address.
		Subnet Mask	Enter the Subnet mask.

Level 1	Level 2	Level 3	Descriptions
WLAN	TCP/IP	Gateway	Enter the Gateway address.
		Node Name	Enter the Node name.
		WINS Configuration	Select the WINS configuration mode.
		WINS Server	Specify the IP address of the primary or secondary WINS server.
		DNS Server	Specify the IP address of the primary or secondary DNS server.
		APIPA	Set the machine to allocate the IP address from the link-local address range automatically.
		IPv6	Turn the IPv6 protocol on or off for a wireless LAN. To use the IPv6 protocol, go to the Brother Solutions Center at support.brother.com for more information.
	WLAN Assistant	-	Configure your wireless network settings using the Brother CD-ROM.
	Setup Wizard	-	Configure your internal print server manually.
	WPS/AOSS	-	Configure your wireless network settings using the one-button push method.
	WPS w/ PIN Code	-	Configure your wireless network settings using WPS with a PIN.
	WLAN Status	Status	View the current wireless network status.
		Signal	View the current wireless network signal strength.
		SSID	View the current SSID.
		Comm. Mode	View the current Communication Mode.
	MAC Address	-	View the machine's MAC address.
Wi-Fi Direct	Push Button	-	Configure your Wi-Fi Direct network settings using the one-button push method.
	PIN Code	-	Configure your Wi-Fi Direct network settings using WPS with a PIN code.
	Manual	-	Configure your Wi-Fi Direct network settings manually.
	Group Owner	-	Set your machine as the Group Owner.
	Device Information	Device Name	View your machine's device name.
		SSID	View the Group Owner's SSID. When the machine is not connected, the LCD displays Not Connected.
		IP Address	View your machine's current IP Address.
	Status Information	Status	View the current Wi-Fi Direct network status.
		Signal	View the current Wi-Fi Direct network signal strength. When your machine acts as Group Owner, the LCD always indicate a strong signal.
	I/F Enable	-	Turn the Wi-Fi Direct connection on or off.
NFC (MFC-J985DW)	-	-	Turn the NFC function on or off.

Level 1	Level 2	Level 3	Descriptions
New Function Notice	New Function Notice	-	View the latest information about cloud services on the Home screen via the Internet.
	Status	-	Receive status notifications about available web services.
Web Connect Settings	Proxy Settings	Proxy Connection	Change the Web connection settings.
		Address	
		Port	
		User Name	
		Password	
Network I/F (MFC-J985DW)	-	-	Select the network connection type.
WLAN Enable (DCP-J785DW)	-	-	Turn wireless network connection On or Off.
Network Reset	-	-	Restore all network settings back to the factory settings.



[Settings] > [All Settings] > [Print Reports]

Level 1	Descriptions
XMIT Verify (MFC models)	Print a Transmission Verification Report for your last transmission.
Address Book (MFC models)	Print a list of names and numbers stored in the Address Book.
Fax Journal (MFC models)	Print a list of information about your last 200 incoming and outgoing faxes. (TX means Transmit. RX means Receive.)
User Settings	Print a list of your settings.
Network Configuration	Print a list of your Network settings.
WLAN Report	Print the wireless LAN connection results.
Caller ID history (MFC models)	Print a list of the available Caller ID information about the last 30 received faxes and telephone calls.



[Settings] > [All Settings] > [Machine Info.]

Level 1	Level 2	Descriptions
Serial No.	-	Check your machine's serial number.
Firmware Version	Main Version	Check your machine's firmware version.
Firmware Update	-	Update your machine to the latest firmware.
Firmware Auto Check	-	View firmware information on the Home screen.



[Settings] > [All Settings] > [Initial Setup]

Level 1	Level 2	Descriptions
Date & Time	Date	(MFC models)
	Time	Add the date and time on the screen and in the headings of the faxes you send. (DCP models)

Level 1	Level 2	Descriptions
Date & Time		Set the date and time on your machine.
	Auto Daylight (MFC models)	Set the machine to change automatically for Daylight Saving Time.
Station ID (MFC models)	Fax	Enter your name and fax number to appear on each page you fax.
	Name	
Tone/Pulse (MFC models) (Available only for some countries.)	-	Select the dialling mode.
Dial Tone (MFC models)	-	Shorten the dial tone detect pause.
Phone Line Set (MFC models)	-	Select the telephone line type.
Compatibility (MFC models)	-	Adjust the equalisation for transmission difficulties. VoIP service providers offer fax support using various standards. If you regularly experience fax transmission errors, select Basic(for VoIP).
Reset	Machine Reset	Restore all the machine's settings that you have changed, such as Date and Time and Ring Delay.
	Network	Restore all network settings back to the factory settings.
	Address Book & Fax (MFC models)	Erase all stored phone numbers and fax settings.
	All Settings	Restore all the machine's settings back to the factory settings.
Local Language (Available only for some countries.)	-	Change your LCD language.



Related Information

- [Settings and Features Tables](#)

Features Tables (2.7"(67.5 mm) Touchpanel models)



[Fax] (When [Fax Preview] is [Off]) (MFC models)



Level 1	Level 2	Level 3	Descriptions	
Address Book	(Search:)	-	Search within the Address Book.	
	Edit	-	Store Address Book numbers, set up Group numbers for Broadcasting, and change and delete Address Book numbers.	
	-	Apply	Start sending a fax using the Address Book.	
Call History	Redial	-	Redial the last number you dialed.	
	Outgoing Call	Apply	Select a number from the Outgoing Call history and then send a fax to it, add it to the Address Book, or delete it.	
		Edit		
	Caller ID history	Apply	Select a number from the Caller ID history and then send a fax to it, add it to the Address Book, or delete it.	
Edit				
Options	Fax Resolution	-	Set the resolution for outgoing faxes.	
	Contrast	-	Adjust the contrast.	
	Broadcasting	Add Number	Send the same fax message to more than one fax number.	
	Preview	-	Preview a fax message before you send it.	
	Colour Setting	-	Set whether faxes are sent in monochrome or colour.	
	Delayed Fax	Delayed Fax	Set the time of day the delayed faxes will be sent.	
		Set Time		
	Batch TX	-	Combine delayed faxes to the same fax number at the same time of day into one transmission.	
	Real Time TX	-	Send a fax without using the memory.	
	Polled TX	-	Set the machine with a document to be retrieved by another fax machine.	
	Polling RX	-	Set the machine to poll another fax machine.	
	Overseas Mode	-	Set to On if you have difficulty sending faxes overseas.	
	Glass Scan Size	-	Adjust the scan area of the scanner glass to the size of the document.	
	Call History	Redial	Redial	Redial the last number you dialed.
		Outgoing Call	Outgoing Call	Select a number from the Outgoing Call history and then send a fax to it, add it to the Address Book, or delete it.
		Caller ID history	Caller ID history	Select a number from the Caller ID history and then send a fax to it, add it to the Address Book, or delete it.
Address Book	(Search:)	-	Search within the Address Book.	
	Edit	-	Store Address Book numbers, set up Group numbers for Broadcasting, and change and delete Address Book numbers.	
	Set New Default	-	Save your settings as the default.	

Level 1	Level 2	Level 3	Descriptions
Options	Factory Reset	-	Restore all settings back to the factory settings.
Save as Shortcut	-	-	Save the current settings as a shortcut.



[Fax] (When [Fax Preview] is [On])

Level 1	Level 2	Level 3	Level 4	Descriptions
Sending Faxes	Address Book	(Search:)	-	Search within the Address Book.
		Edit	-	Store Address Book numbers, set up Group numbers for Broadcasting, and change and delete Address Book numbers.
		-	Apply	Start sending a fax using the Address Book.
	Call History	Redial	-	Redial the last number you dialled.
		Outgoing Call	Apply	Select a number from the Outgoing Call history and then send a fax to it, add it to the Address Book, or delete it.
			Edit	
	Caller ID history	Apply	Select a number from the Caller ID history and then send a fax to it, add it to the Address Book, or delete it.	
		Edit		
	Options	Fax Resolution	-	Set the resolution for outgoing faxes.
		Contrast	-	Adjust the contrast.
		Broadcasting	Add Number	Send the same fax message to more than one fax number.
		Preview	-	Preview a fax message before you send it.
		Colour Setting	-	Set whether faxes are sent in monochrome or colour.
		Delayed Fax	Delayed Fax	Set the time of day the delayed faxes will be sent.
			Set Time	
		Batch TX	-	Combine delayed faxes to the same fax number at the same time of day into one transmission.
		Real Time TX	-	Send a fax without using the memory.
		Polled TX	-	Set the machine with a document to be retrieved by another fax machine.
		Polling RX	-	Set the machine to poll another fax machine.
		Overseas Mode	-	Set to On if you have difficulty sending faxes overseas.
		Glass Scan Size	-	Adjust the scan area of the scanner glass to the size of the document.
	Call History	Redial	Redial the last number you dialled.	
		Outgoing Call	Select a number from the Outgoing Call history and then send a fax to it, add it to the Address Book, or delete it.	
		Caller ID history	Select a number from the Caller ID history and then send a fax to it, add it to the Address Book, or delete it.	

Level 1	Level 2	Level 3	Level 4	Descriptions	
Sending Faxes	Options	Address Book	 (Search:)	Search within the Address Book.	
			Edit	Store Address Book numbers, set up Group numbers for Broadcasting, and change and delete Address Book numbers.	
			Set New Default	-	Save your settings as the default.
			Factory Reset	-	Restore all settings back to the factory settings.
	Save as Shortcut	-	-	Save the current settings as a shortcut.	
Received Faxes	Print/Delete	Print All (New Faxes)	-	Print the new received faxes.	
		Print All (Old Faxes)	-	Print the old received faxes.	
		Delete All (New Faxes)	-	Delete the new received faxes.	
		Delete All (Old Faxes)	-	Delete the old received faxes.	
Address Book	 (Search:)	-	-	Search within the Address Book.	
	Edit	-	-	Store Address Book numbers, set up Group numbers for Broadcasting, and change and delete Address Book numbers.	
	-	Apply	-	Start sending a fax using the Address Book.	
Call History	Redial	-	-	Redial the last number you dialed.	
	Outgoing Call	Apply	-	Select a number from the Outgoing Call history and then send a fax to it, add it to the Address Book, or delete it.	
		Edit	-		
	Caller ID history	Apply	-	Select a number from the Caller ID history and then send a fax to it, add it to the Address Book, or delete it.	
Edit		-			



[Copy]

Level 1	Level 2	Level 3	Descriptions	
Options	Quality	-	Select the Copy resolution for your type of document.	
	Paper Type	-	Select the paper type that matches the paper in the tray.	
	Paper Size	-	Select the paper size that matches the paper in the tray.	
	Enlarge/Reduce	100%	-	
		Enlarge	-	Select an enlargement ratio for the next copy.
		Reduce	-	Select a reduction ratio for the next copy.
		Fit to Page	-	Adjusts the copy size to fit on the paper size you have set.
	Custom (25-400%)	-	Enter an enlargement or reduction ratio.	
	Density	-	Adjust the density.	
Stack/Sort	-	Select to stack or sort multiple copies.		
Page Layout	-	Make N in 1, 2 in 1 ID, or Poster copies.		

Level 1	Level 2	Level 3	Descriptions
Options	2-sided Copy	-	Turn off or turn on 2-sided copying and select flip on long edge or flip on short edge.
	Advanced Settings (MFC-J985DW)	-	Select various copy settings such as Ink Save Mode or Watermark Copy.
	Advanced Settings (DCP-J785DW)	-	Change the amount of background colour that is removed.
	Set New Default	-	Save your settings as the default.
	Factory Reset	-	Restore all settings back to the factory settings.
	Save as Shortcut	-	Save the current settings as a shortcut.



[Scan]

Level 1	Level 2	Level 3	Descriptions
to OCR (Available after Presto! PageManager is downloaded and installed for Mac.)	PC Select	Options	Convert your scanned document to an editable text file.
		Save as Shortcut	
to File	PC Select	Options	Scan documents and save them to a folder on your computer.
		Save as Shortcut	
to Image	PC Select	Options	Scan photos or graphics into your graphics applications.
		Save as Shortcut	
to Media (When a memory card or USB Flash drive is inserted)	-	Options	Scan documents and save them directly to a memory card or USB flash drive without using a computer.
		Save as Shortcut	
to E-mail	PC Select	Options	Send a scanned document as an email attachment.
		Save as Shortcut	
to Web	-	-	Upload the scanned data to an Internet service.
WS Scan (Appears when you install a Web Services Scanner, which is displayed in your computer's Network explorer.)	Scan	PC Select	Scan data using the Web Service protocol.
	Scan for E-mail		
	Scan for Fax		
	Scan for Print		



[Photo]

Level 1	Level 2	Level 3	Level 4	Descriptions
Index Print	Print Index Sheet	Print Settings	-	Print a thumbnail page.
	Print Photos	Print Settings	-	Print photos by choosing the index numbers.
View Photos	OK	Print Settings	-	Adjust your photos with the options.
	Print All	-	-	Print all photos in your memory card or USB flash drive.

Level 1	Level 2	Level 3	Level 4	Descriptions
Enhance Photos (MFC-J985DW)	Enhance	Auto Correct	Print Settings	Adjust your photos with these settings.
		Enhance Skin		
Enhance Scenery				
Remove Red-Eye				
Night Scene				
Fill Light				
Whiteboard				
Monochrome				
Sepia				
	Crop	Print Settings	-	Crop your photo and print a part of the image.
ID Photo Print	Select ID Photo Size	-	Print Settings	Print ID photos for your resume, passport and so on.
Slide Show	Show Each Photo for	-	-	Set the time each photo in the Slide Show is shown before the machine switches to the next photo.
	Start	-	-	Start a Slide Show of your photos. Select a photo during the Slide show and change the print settings.



[Web]

Level 1	Descriptions
OneNote® OneDrive® Box Google Drive™ Evernote® Dropbox Facebook Picasa Web Albums™ Flickr®	Connect the Brother machine to an Internet service. Web services may have been added and service names may have been changed by the provider since this document was published. For more detailed information, see the <i>Web Connect Guide</i> . Go to your model's Manuals page on the Brother Solutions Center at support.brother.com to download the guide.



[Shortcuts]

Level 1	Level 2	Level 3	Level 4	Descriptions
Add Shortcut	Copy	Quality	-	Change the settings in the Copy Options.
		Paper Type	-	
		Paper Size	-	
		Enlarge/Reduce	-	
		Density	-	
		Stack/Sort	-	
		Page Layout	-	

Level 1	Level 2	Level 3	Level 4	Descriptions
Add Shortcut	Copy	2-sided Copy	-	Change the settings in the Copy Options.
		Advanced Settings	-	
	Fax (Options) (MFC models)	Fax Resolution	-	Set the resolution for outgoing faxes.
		Contrast	-	Adjust the contrast.
		Broadcasting	Add Number	Send the same fax message to more than one fax number.
		Preview	-	Preview a fax message before you send it.
		Colour Setting	-	Set whether faxes are sent in monochrome or colour.
		Real Time TX	-	Send a fax without using the memory.
		Overseas Mode	-	Set to On if you have difficulty sending faxes overseas.
		Glass Scan Size	-	Adjust the scan area of the scanner glass to the size of the document.
		Call History	Redial	Redial the last number you dialed.
			Outgoing Call	Select a number from the Outgoing Call history and then send a fax to it, add it to the Address Book, or delete it.
			Caller ID history	Select a number from the Caller ID history and then send a fax to it, add it to the Address Book, or delete it.
	Address Book	-	Select a number from the Address Book.	
	Scan	to File	-	Scan documents and save them to a folder on your computer.
		to OCR (Available after Presto! PageManager is downloaded and installed for Mac.)	-	Convert your scanned document to an editable text file.
		to Image	-	Scan photos or graphics into your graphics applications.
		to Media	-	Scan documents and save them directly to a memory card or USB flash drive without using a computer.
		to E-mail	-	Send a scanned document as an email attachment.
	Web	OneNote®	-	Connect the Brother machine to an Internet service.
		OneDrive®	-	Web services may have been added and service names may have been changed by the provider since this document was published.
		Box	-	
		Google Drive™	-	For more detailed information, see the <i>Web Connect Guide</i> . Go to your model's Manuals page on the Brother Solutions Center at support.brother.com to download the guide.
		Evernote®	-	
		Dropbox	-	
		Facebook	-	
		Picasa Web Albums™	-	
Flickr®		-		

Level 1	Level 2	Level 3	Level 4	Descriptions
Add Shortcut	Apps	-	-	Connect the Brother machine to the Brother Apps service.
This list appears when each Shortcut icon is pressed for 2 seconds.	Edit Shortcut Name	-	-	Change the shortcut name.
	Delete	-	-	Delete the shortcut.
Edit/Delete	(Select shortcut button.)	Edit Shortcut Name	-	Change the shortcut name.
		Delete	-	Delete the shortcut.



[Ink]

Level 1	Descriptions
Ink Volume	Check the available ink volume.
Ink Cartridge Model	Check your ink cartridge numbers.
Improve Print Quality	Check and correct the print quality, alignment and paper feeding according to the on-screen instructions.
Print Head Cleaning	Clean the print head according to the on-screen instructions.

WiFi WiFi

Level 1	Descriptions
Setup Wizard	Configure your internal print server manually.
WPS/AOSS	Configure your wireless network settings using the one-button push method.
WLAN Assistant	Configure your wireless network settings using the Brother CD-ROM.

When you have put the memory card or USB Flash drive in the correct slot

Level 1	Descriptions
Photo	Select photo menu.
Scan to Media	Scan documents into a memory card or USB flash drive.
Web	Connect the Brother machine to an Internet service.
DPOF	View the DPOF setting screen.



Related Information

- [Settings and Features Tables](#)

Change Machine Settings from Your Computer

- [Change the Machine Settings Using Remote Setup](#)
- [Where Can I Find My Brother Machine's Network Settings?](#)
- [Network Management Software and Utilities](#)

Change the Machine Settings Using Remote Setup

The Remote Setup program lets you configure many of your Brother machine's machine settings from your computer. When you start Remote Setup, the settings on your Brother machine will be downloaded to your computer and displayed on your screen. If you change the settings on your computer, you can upload them directly to the machine.

- [Remote Setup \(Windows®\)](#)
- [Remote Setup \(Mac\)](#)

Remote Setup (Windows®)

- [Set Up the Brother Machine from Your Computer \(Windows®\)](#)
- [Set Up the Brother Machine Using ControlCenter4 \(Windows®\)](#)
- [Set Up Your Brother Address Book Using ControlCenter4 \(Windows®\)](#)

Set Up the Brother Machine from Your Computer (Windows®)

Related Models: MFC-J985DW

1. Do one of the following:

- Windows® XP, Windows Vista® and Windows® 7

Click  (**Start**) > **All Programs** > **Brother** > **Brother Utilities**.

Click the drop-down list and select your model name (if not already selected). Click **Tools** in the left navigation bar, and then click **Remote Setup**.

- Windows® 8/Windows® 10

Launch  (**Brother Utilities**), and then click the drop-down list and select your model name (if not already selected). Click **Tools** in the left navigation bar, and then click **Remote Setup**.

The Remote Setup Program window appears.



When your machine is connected via a Network, type the password if required.

2. Configure the settings as needed.

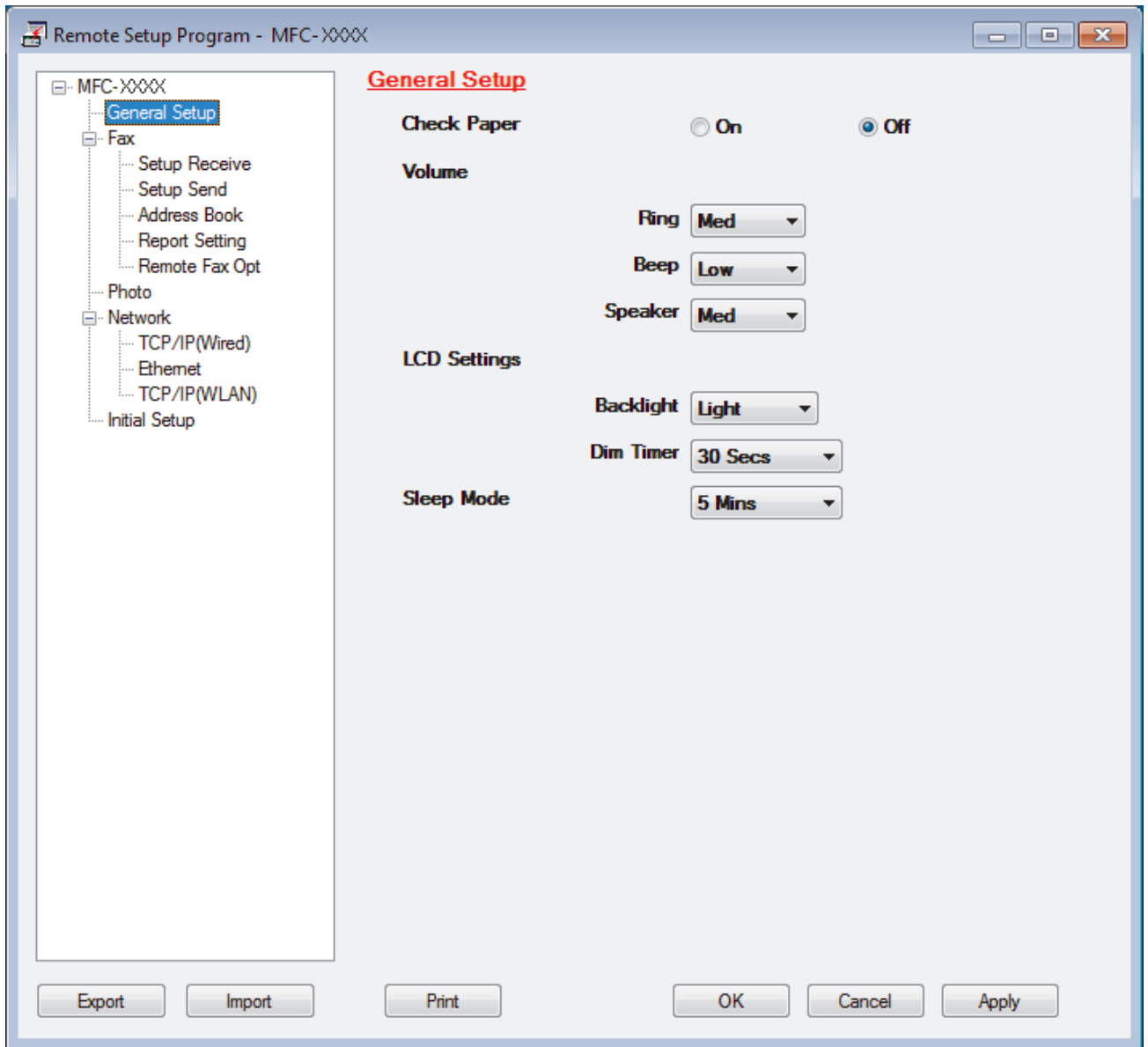

Export

Click to save the current configuration settings to a file.



Click **Export** to save your address book or all settings for your machine.

Import

Click to read the settings from a file.

Print

Click to print the selected items on the machine. You cannot print the data until it is uploaded to the machine. Click **Apply** to upload the new data to the machine, and then click **Print**.

OK

Click to start uploading data to the machine, and then exit the Remote Setup Program. If an error message appears, confirm that your data is correct, and then click **OK**.

Cancel

Click to exit the Remote Setup Program without uploading data to the machine.

Apply

Click to upload data to the machine without exiting the Remote Setup Program.

3. Click **OK**.

-
- If your computer is protected by a firewall and is unable to use Remote Setup, you may need to configure the firewall settings to allow communication through port numbers 137 and 161.
 - If you are using Windows® Firewall and you installed the Brother software and drivers from the CD-ROM, the necessary firewall settings have already been set.



Related Information

- [Remote Setup \(Windows®\)](#)
 - [ControlCenter4 \(Windows®\)](#)
-

Set Up the Brother Machine Using ControlCenter4 (Windows®)

Related Models: MFC-J985DW

1. Click the  (ControlCenter4) icon in the task tray, and then click **Open**.
2. Click the **Device Settings** tab.
3. Click the **Remote Setup** button.
4. Configure the settings as needed.

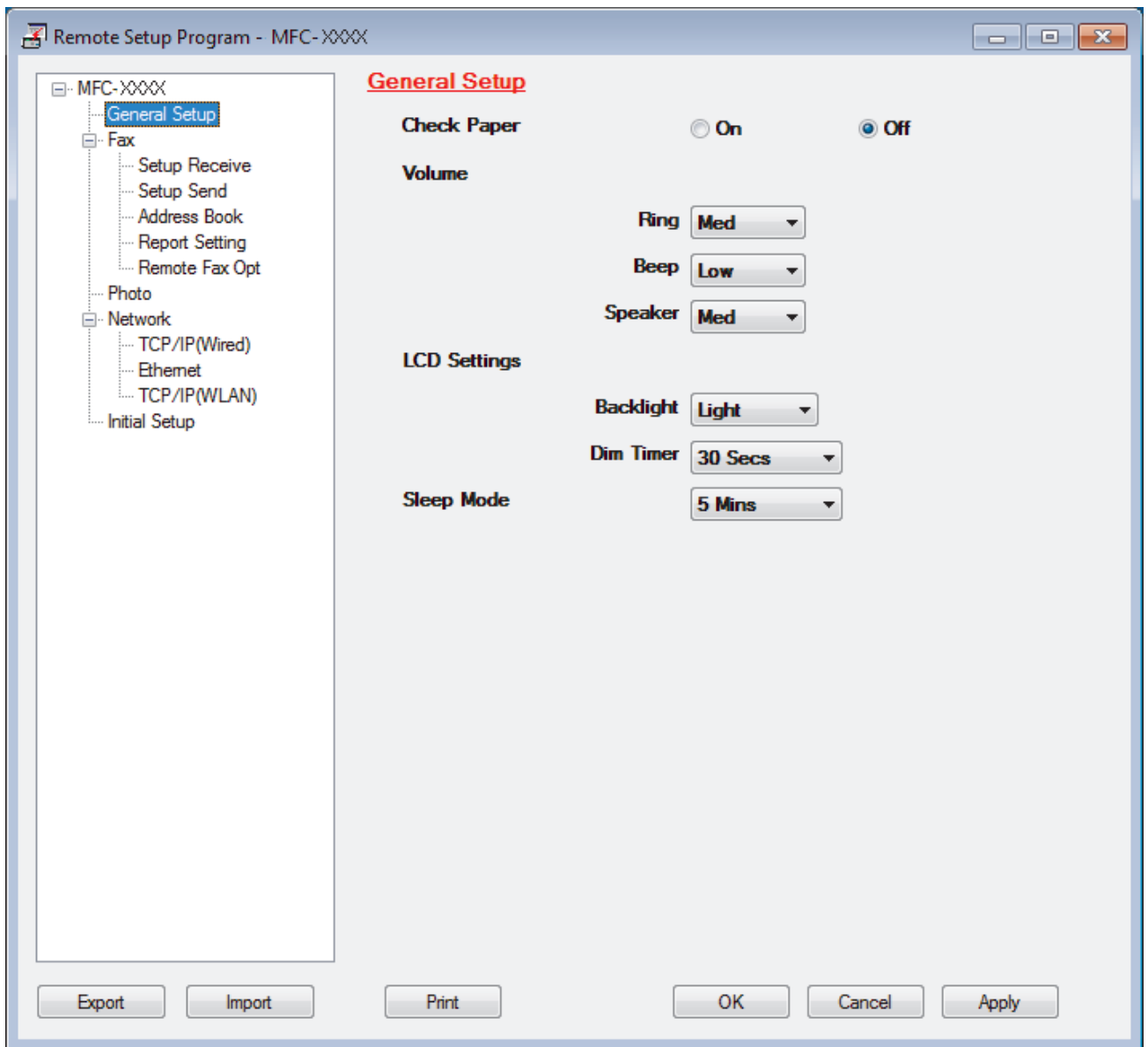

Export

Click to save the current configuration settings to a file.



Click **Export** to save your address book or all settings for your machine.

Import

Click to read the settings from a file.

Print

Click to print the selected items on the machine. You cannot print the data until it is uploaded to the machine. Click **Apply** to upload the new data to the machine, and then click **Print**.

OK

Click to start uploading data to the machine, and then exit the Remote Setup Program. If an error message appears, confirm that your data is correct, and then click **OK**.

Cancel

Click to exit the Remote Setup Program without uploading data to the machine.

Apply

Click to upload data to the machine without exiting the Remote Setup Program.

5. Click **OK**.

- If your computer is protected by a firewall and is unable to use Remote Setup, you may need to configure the firewall settings to allow communication through port numbers 137 and 161.
- If you are using Windows® Firewall and you installed the Brother software and drivers from the CD-ROM, the necessary firewall settings have already been set.

**Related Information**

- [ControlCenter4 \(Windows®\)](#)
- [Remote Setup \(Windows®\)](#)

Set Up Your Brother Address Book Using ControlCenter4 (Windows®)

Related Models: MFC-J985DW

Use Remote Setup through CC4 to add or change Address Book numbers on your computer.

1. Click the  (**ControlCenter4**) icon in the task tray, and then click **Open**.
2. Click the **Device Settings** tab.
3. Click the **Address Book** button.
The **Address Book** opens in a Remote Setup window.
4. Add or update the Address Book information as needed.
5. Click **OK**.



Related Information

- [Remote Setup \(Windows®\)](#)
- [ControlCenter4 \(Windows®\)](#)

Remote Setup (Mac)

- [Set Up the Brother Machine Using ControlCenter2 \(Mac\)](#)
- [Set Up Your Brother Address Book Using ControlCenter2 \(Mac\)](#)

Set Up the Brother Machine Using ControlCenter2 (Mac)

Related Models: MFC-J985DW

1. In the **Finder** menu bar, click **Go > Applications > Brother**, and then double-click the  (**ControlCenter**) icon.

The **ControlCenter2** screen appears.

2. Click the **DEVICE SETTINGS** tab.
3. Click the **Remote Setup** button.

The Remote Setup Program screen appears.

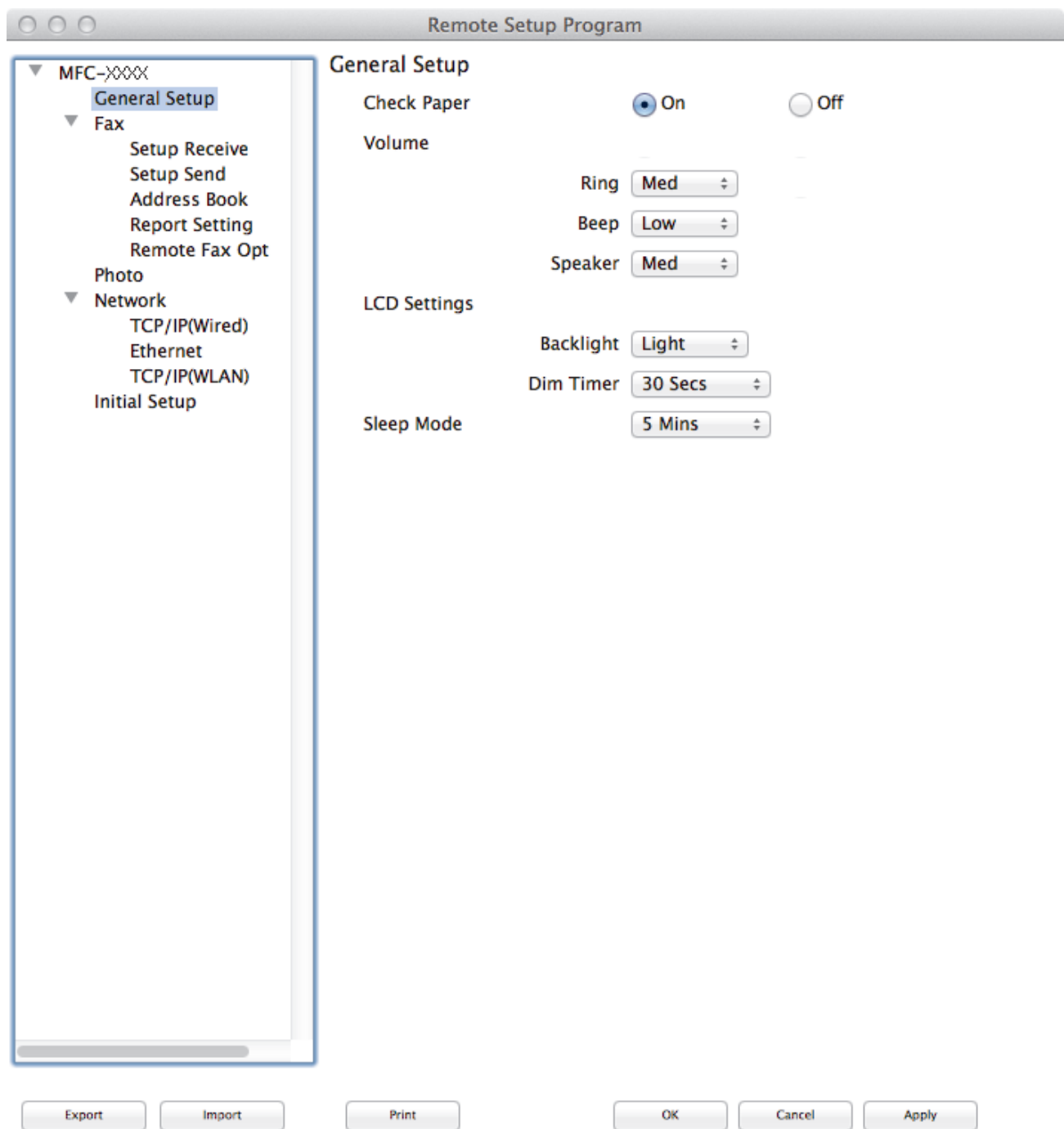

4. Configure the settings as needed.

Export

Click to save the current configuration settings to a file.



Click **Export** to save your address book or all settings for your machine.

Import

Click to read the settings from a file.

Print

Click to print the selected items on the machine. You cannot print the data until it is uploaded to the machine. Click **Apply** to upload the new data to the machine, and then click **Print**.

OK

Click to start uploading data to the machine, and then exit the Remote Setup Program. If an error message appears, enter the correct data again, and then click **OK**.

Cancel

Click to exit the Remote Setup Program without uploading data to the machine.

Apply

Click to upload data to the machine without exiting the Remote Setup Program.

5. When finished, click **OK**.



Related Information

- [ControlCenter2 \(Mac\)](#)
 - [Remote Setup \(Mac\)](#)
-

Set Up Your Brother Address Book Using ControlCenter2 (Mac)

Related Models: MFC-J985DW

Use Remote Setup through ControlCenter2 to add or change Address Book numbers on your computer.

1. In the **Finder** menu bar, click **Go > Applications > Brother**, and then double-click the  (**ControlCenter**) icon.
The **ControlCenter2** screen appears.
2. Click the **DEVICE SETTINGS** tab.
3. Click the **Address Book** button.
The **Address Book** opens in a Remote Setup window.
4. Add or update the Address Book information as needed.
5. When finished, click **OK**.



Related Information

- [Remote Setup \(Mac\)](#)
- [ControlCenter2 \(Mac\)](#)

Appendix

- [Specifications](#)
- [Enter Text on Your Brother Machine](#)
- [Supply Specifications](#)
- [Information Regarding Recycled Paper](#)

Specifications

General Specifications

Printer Type		Inkjet	
Print Head	Mono	Piezo with 210 nozzles x 1	
	Colour	Piezo with 210 nozzles x 3	
Memory Capacity		128 MB	
LCD (liquid crystal display) ¹		2.7 in. (67.5 mm) TFT Colour Touchscreen LCD and Touchpanel	
Power Source		AC 220 to 240 V 50/60 Hz	
Power Consumption ²		Copying ³ : Approx. 19 W Ready ⁴ : Approx. 3.5 W Sleep ⁴ : Approx. 1.3 W Power Off ^{4 5} : Approx. 0.2 W	
Dimensions			
Weights		<ul style="list-style-type: none"> • DCP-J785DW 8.4 kg • MFC-J985DW 8.5 kg 	
Noise Level	Sound Pressure	Operating	50 dB (A) (Approx.) ⁶
	Sound Power ^{7 8}	Copying ⁹	LWAd =6.04 B(A) (Mono)
			LWAd =6.00 B(A) (Colour)
		Ready	LWAd =2.97 B(A) (Mono/Colour)
Temperature	Operating	between 10°C and 35°C	
	Best Print Quality	between 20°C and 33°C	
Humidity	Operating	between 20% and 80% (without condensation)	
	Best Print Quality	between 20% and 80% (without condensation)	
ADF (automatic document feeder) ¹⁰		Up to 20 pages Paper: 80 g/m ²	

¹ Measured diagonally

² Measured when the machine is connected to the USB interface. Power consumption varies slightly depending on the usage environment or part wear.

- 3 When using ADF, single-sided printing, resolution: standard / document: ISO/IEC 24712 printed pattern.
- 4 Measured according to IEC 62301 Edition 2.0.
- 5 Even when the machine is turned off, it will automatically turn itself on periodically for print head maintenance, and then turn itself off.
- 6 Noise depends on printing conditions.
- 7 In accordance with ISO9296
- 8 Office equipment with LWAd>6.30 B(A) is not appropriate for use in room where people require high levels of concentration. Such equipment should be placed in separate rooms because of noise emissions.
- 9 Copy speed: 7 cpm (Mono) / 7 cpm (Colour)
These copy speeds were measured in accordance with the Blue Angel (RAL-UZ171) specification.
- 10 ADF models only

Document Size Specifications

Document Size	ADF Width ¹	148 to 215.9 mm
	ADF Length ^{1 2}	148 to 355.6 mm
	Scanner Glass Width	Max. 215.9 mm
	Scanner Glass Length	Max. 297 mm

¹ ADF models only

² Documents that are longer than 297 mm must be fed one page at a time.

Print Media Specifications

Paper Input	Paper Tray	Paper Type ¹	Plain Paper, Inkjet Paper (coated paper), Glossy Paper, Recycled Paper
		Paper Size	A4, Executive, Letter, A5, A6, Envelopes (Com-10, DL, C5, Monarch), Photo (10 x 15 cm), Photo 2L (13 x 18 cm) and Index Card (127 x 203 mm)
		Maximum Paper Capacity	Up to 100 sheets of 80 g/m ² plain paper
	Photo Paper Tray	Paper Type ¹	Plain Paper, Inkjet Paper (coated paper), Glossy Paper, Recycled Paper
		Paper Size	Photo (10 x 15 cm) and Photo L (89 x 127 mm)
		Maximum Paper Capacity	Up to 20 sheets thickness: 0.25 mm
	Manual Feed Slot	Paper Type ¹	Plain Paper, Inkjet Paper (coated paper), Glossy Paper, Recycled Paper
		Paper Size	A4, Executive, Letter, A5, A6, Envelopes (Com-10, DL, C5, Monarch), Photo (10 x 15 cm), Photo L (89 x 127 mm), Photo 2L (13 x 18 cm) and Index Card (127 x 203 mm)
		Maximum Paper Capacity	Up to 1 sheet
Paper Output		Up to 50 sheets of 80 g/m ² Plain Paper (face up print delivery to the output paper tray) ¹	

¹ For glossy paper, remove printed pages from the output paper tray immediately after they exit the machine to avoid smudging.

Fax Specifications



This feature is available for MFC models.

Compatibility	ITU-T Group 3
Modem Speed	Automatic Fallback: 14,400 bps
Scanning Width	ADF: 208 mm (A4)

(Single-sided document)	Scanner Glass: 204 mm (A4)
Printing Width	204 mm (A4)
Greyscale	Monochrome: 8 bit (256 levels) Colour: 24 bit (8 bit per colour/256 levels)
Resolution (Horizontal)	203 dpi
Resolution (Vertical)	Standard: 98 dpi (Mono) 196 dpi (Colour)
	Fine: 196 dpi (Mono) 196 dpi (Colour)
	Superfine: 392 dpi (Mono)
	Photo: 196 dpi (Mono)
Address Book	100 names x 2 numbers
Groups	Up to 6
Broadcasting	250 (200 Address Book/50 Manual Dial)
Automatic Redial	3 times at 5 minute intervals
Memory Transmission	Up to 200 pages ¹
Out of Paper Reception	Up to 200 pages ¹

¹ 'Pages' refers to the 'ITU-T Test Chart #1' (a typical business letter, Standard resolution, MMR code).

Copy Specifications

Colour/Monochrome	Yes/Yes	
Copy Width	204 mm ¹	
Multiple Copies	Stacks/Sorts up to 99 pages	
Enlarge/Reduce	25% to 400% (in increments of 1%)	
Resolution	Prints up to 1200 × 2400 dpi	
2-sided	Paper Type	Plain Paper, Recycled Paper
	Paper Size	A4, Letter, A5

¹ When copying on A4 size paper.

PhotoCapture Center Specifications

Compatible Media ¹	Memory Stick Duo™ (16 MB - 128 MB) Memory Stick PRO Duo™ (256 MB - 32 GB) Memory Stick Micro™ (M2™) with Adapter (256 MB - 32 GB) MultiMediaCard (32 MB - 2 GB) MultiMediaCard plus (128 MB - 4 GB) MultiMediaCard mobile with Adapter (64 MB - 1 GB) SD Memory Card (16 MB - 2 GB) miniSD with Adapter (16 MB - 2 GB) microSD with Adapter (16 MB - 2 GB)
--------------------------------------	--

		SDHC Memory Card (4 GB - 32 GB) miniSDHC with Adapter (4 GB - 32 GB) microSDHC with Adapter (4 GB - 32 GB) SDXC Memory Card (48 GB - 256 GB) USB Flash drive ²
Resolution		Up to 1200 x 6000 dpi
File Extension	Media Format	DPOF (ver. 1.0, ver. 1.1), Exif DCF (up to ver. 2.1)
	Image Format	<ul style="list-style-type: none"> • Photo Print JPEG (Progressive JPEG format is not supported) AVI, MOV (Motion JPEG only) • Scan to Media JPEG, PDF (Colour) TIFF, PDF (Monochrome)
Number of Files		Up to 999 files (Folders inside memory cards or USB Flash drives are also counted as files.)
Folder		Files can be stored up to four folder levels deep on the memory card or USB Flash drive.
Borderless		A4, Letter, Photo (10 x 15 cm), Photo 2L (13 x 18 cm)

¹ Memory cards, adapters and USB Flash drives are not included.

² Full-Speed USB 2.0. USB Mass Storage standard up to 256 GB. Supported formats: FAT12/FAT16/FAT32/exFAT

PictBridge Specifications

Compatibility	Supports the Camera & Imaging Products Association PictBridge standard CIPA DC-001. Visit www.cipa.jp/pictbridge for more information.
Interface	USB direct interface

Scanner Specifications

Colour/Monochrome	Yes/Yes
TWAIN Compliant	Yes (Windows [®] XP ¹ / Windows Vista [®] / Windows [®] 7 / Windows [®] 8 / Windows [®] 10) (OS X v10.8.5 / 10.9.x /10.10.x)
WIA Compliant	Yes (Windows [®] XP ¹ / Windows Vista [®] / Windows [®] 7 / Windows [®] 8 / Windows [®] 10)
ICA Compliant	Yes (OS X v10.8.5 / 10.9.x /10.10.x)
Colour Depth	30 bit colour processing (Input) 24 bit colour processing (Output) / 256 levels per colour
Greyscale	10 bit colour processing (Input) 8 bit colour processing (Output) / 256 levels
Resolution	Up to 19200 × 19200 dpi (interpolated) ² Up to 1200 × 2400 dpi (optical) (from Scanner Glass) Up to 1200 × 600 dpi (optical) (from ADF)

Scanning Width and Length (Single-sided document)	(Scanner Glass)
	Width: Up to 213.9 mm
	Length: Up to 295 mm
	(ADF)
	Width: Up to 213.9 mm
	Length: Up to 353.6 mm

- Windows® XP in this Guide includes Windows® XP Home Edition, Windows® XP Professional, and Windows® XP Professional x64 Edition.
- Maximum 1200 × 1200 dpi scanning with the WIA driver in Windows® XP, Windows Vista®, Windows® 7, Windows® 8 and Windows® 10 (resolution up to 19200 × 19200 dpi can be selected using the scanner utility).

Printer Specifications

Resolution	Up to 1200 × 6000 dpi	
Printing Width ¹	204 mm [210 mm (borderless)] ²	
Borderless	A4, Letter, A6, Photo (10 x 15 cm), Photo L (89 x 127 mm), Photo 2L (13 x 18 cm), Index card (127 x 203 mm)	
Automatic 2-sided	Paper Type	Plain Paper, Recycled Paper
	Paper Size	A4, Letter, A5, Executive
Print Speed	For detailed specifications visit www.brother.com .	

- When printing on A4 size paper.
- When the Borderless feature is set to On.

Interface Specifications

USB ^{1 2}	Use a USB 2.0 interface cable that is no longer than 2 m.
LAN (MFC-J985DW)	Use an Ethernet UTP cable category 5 or greater.
Wireless LAN	IEEE 802.11b/g/n (Infrastructure/Ad-hoc Mode) IEEE 802.11g/n (Wi-Fi Direct)
NFC (MFC-J985DW)	Yes

- Your machine has a USB 2.0 Hi-Speed interface. The machine can also be connected to a computer that has a USB 1.1 interface.
- Third-party USB ports are not supported.

Network Specifications



You can connect your machine to a network for Network Printing, Network Scanning, PC-Fax Send, PC-Fax Receive (Windows® only), Remote Setup, and to access photos from PhotoCapture Center. Also included is Brother BRAdmin Light (Windows® only) ¹ Network Management software.

(Windows®) If you require more advanced machine management, use the latest Brother BRAdmin Professional utility version. Go to your model's **Downloads** page on the Brother Solutions Center at support.brother.com to download the software.

Wireless Network Security	SSID (32 characters), WEP 64/128 bit, WPA-PSK (TKIP/AES), WPA2-PSK (AES)
Wireless Setup Support Utility	AOSS™
	Yes

- Brother BRAdmin Light is available as a download from Brother Solutions Center. Go to your model's **Downloads** page on the Brother Solutions Center at support.brother.com to download the software.

Computer Requirements Specifications

Supported Operating Systems And Software Functions

Computer Platform & Operating System Version		PC Interface			Processor	Hard Disk Space to install				
		USB ¹	10/100 Base-TX (Ethernet) ²	Wireless 802.11b/g/n		For Drivers	For Applications (Including Drivers)			
Windows® Operating System	Windows® XP Home (SP3 or greater) ^{3 4} Windows® XP Professional (SP3 or greater) ^{3 4}	Printing PC Fax ⁵ Scanning Removable Disk (USB or Memory Card) Network Media Access (LAN)			32 bit (x86) or 64 bit (x64) processor	150 MB	1 GB			
	Windows Vista® ^{3 4}					500 MB	1.3 GB			
	Windows® 7 ^{3 4}					650 MB				
	Windows® 8 ^{3 4}									
	Windows® 8.1 ^{3 4}									
	Windows® 10 Home ^{3 4} Windows® 10 Pro ^{3 4} Windows® 10 Education ^{3 4} Windows® 10 Enterprise ^{3 4}									
	Windows Server® 2003 Windows Server® 2003 R2 Windows Server® 2008				N/A	Printing			64 bit (x64) processor	50 MB
Windows Server® 2008 R2 Windows Server® 2012 Windows Server® 2012 R2										
Mac Operating	OS X v10.8.5 OS X v10.9.x	Printing PC-Fax (Send) ⁵			Intel® Processor	80 MB	550 MB			

System	OS X v10.10.x	Scanning Removable Disk (USB or Memory Card) Network Media Access (LAN)			
--------	---------------	---	--	--	--

- 1 Third-party USB ports are not supported.
- 2 MFC-J985DW only
- 3 For WIA, 1200 x 1200 resolution. Brother Scanner Utility enables enhancing up to 19200 x 19200 dpi.
- 4 Nuance™ PaperPort™ 14 supports Windows® XP Home (SP3 or greater), Windows® XP Professional 32-bit (SP3 or greater), Windows Vista® (SP2 or greater), Windows® 7, Windows® 8, Windows® 8.1 and Windows® 10.
- 5 PC-Fax supports monochrome only. (MFC models)

For the latest driver updates, visit support.brother.com and go to your model's **Downloads** page.

All trademarks, brand and product names are the property of their respective companies.



Related Information



- [Appendix](#)

Enter Text on Your Brother Machine

- The characters that are available may differ depending on your country.
- For touchscreen models, the keyboard layout may differ depending on the function you are setting.

When you need to enter text on your Brother machine, a keyboard will appear on the touchscreen.





- Press  to cycle between letters, numbers and special characters.
- Press  to cycle between lowercase and uppercase letters.
- To move the cursor to the left or right, press ◀ or ▶.

Inserting spaces

- To enter a space, press [Space]. Or, you can press ▶ to move the cursor.

Making corrections

- If you entered an incorrect character and want to change it, press ◀ or ▶ to highlight the incorrect character. Press , and then enter the correct character.
- To insert a character, press ◀ or ▶ to move the cursor to the correct place, and then enter the character.
- Press  for each character you want to erase, or press and hold  to erase all the characters.

✓ Related Information

- [Appendix](#)
- [Send the Same Fax to More than One Recipient \(Broadcasting\)](#)
- [Store Address Book Numbers from Outgoing Calls](#)
- [Store Address Book Numbers from Caller ID History](#)
- [Change a Group Name](#)
- [Set Your Station ID](#)
- [Change or Delete Shortcuts](#)

Supply Specifications

Ink	The machine uses individual Black, Yellow, Cyan and Magenta ink cartridges that are separate from the print head assembly.
Service Life of Ink Cartridge	The first time you install a set of ink cartridges, the machine will use an amount of ink to fill the ink delivery tubes for high-quality printouts. This process will only happen once. After this process is complete, the cartridges provided with your machine will have a lower yield than regular capacity cartridges (approximately 90% (black) and 60% (colour)). With all following ink cartridges you can print the specified number of pages:
Replacement Supplies	<p><Super High Yield Black> LC22UBK <Super High Yield Yellow> LC22UY <Super High Yield Cyan> LC22UC <Super High Yield Magenta> LC22UM</p> <p>Black - Approximately 2400 pages ¹ Yellow, Cyan and Magenta - Approximately 1200 pages ¹</p> <p>For more information about replacement supplies, visit www.brother.com/pageyield</p>
What is Innobella? 	<p>Innobella is a range of genuine supplies offered by Brother. The name "Innobella" derives from the words "Innovation" and "Bella" (meaning "Beautiful" in Italian) and is a representation of the "innovative" technology providing you with "beautiful" and "long lasting" print results.</p> <p>When you print photo images, Brother recommends Innobella glossy photo paper (BP71 series) for high quality. Brilliant prints are made easier with Innobella Ink and paper.</p>

¹ Approx. cartridge yield is declared in accordance with ISO/IEC 24711



Related Information

- [Appendix](#)
- [Error and Maintenance Messages](#)

Information Regarding Recycled Paper

- Recycled paper is of the same quality of paper made from original forest sources. Standards governing modern recycled paper ensure that it meets the highest quality requirements for different printing processes. The imaging equipment supplied by the VA signatories is suitable for using with recycled paper meeting the EN 12281:2002 standard.
- Purchasing recycled paper saves natural resources and promotes the circular economy. Paper is made using cellulose fibres from wood. Collecting and recycling paper extends the life of fibres over multiple life cycles making the best use of the resources.
- The recycled paper production process is shorter. The fibres have already been processed; so less water, chemicals and energy are used.
- Paper recycling has the benefit of saving carbon by diverting paper products from alternative disposal routes such as landfill and incineration. Landfill waste emits methane gas which has a powerful greenhouse effect.



Related Information

- [Appendix](#)
-

Glossary

This is a comprehensive list of features and terms that appear in Brother manuals. Availability of these features depends on the model you purchased.

A B C D E F G H I J K L M N O P Q R S T U V W X

A

- Ad-Hoc Mode
- Address Book
- Address Book List
- ADF (Automatic Document Feeder)
- AES
- AOSS™
- APIPA
- ARP
- ASCII
- Authentication
- Auto Reduction
- Automatic Fax Transmission
- Automatic Redial

B

- Backup Print
- Batch Transmission
- Beeper Volume
- BOOTP
- BRAdmin Light (Windows®)
- BRAdmin Professional (Windows®)

- [Broadcasting](#)
- [BT Call Sign](#)

C

- [Caller ID](#)
- [Channels](#)
- [CNG Tones](#)
- [Coding Method](#)
- [Colour Enhancement](#)
- [Communication Error \(or Comm. Error\)](#)
- [Compatibility Group](#)
- [Contrast](#)
- [Custom Raw Port](#)

D

- [Delayed Fax](#)
- [Density](#)
- [DHCP](#)
- [DNS Client](#)
- [DNS Server](#)
- [Domain Name](#)
- [Driver Deployment Wizard](#)

E

- [ECM \(Error Correction Mode\)](#)
- [Encryption](#)
- [Extension Telephone](#)
- [External Phone](#)

F

- [F/T Ring Time](#)
- [Fax Detect](#)
- [Fax Forwarding](#)
- [Fax Journal](#)
- [Fax Storage](#)
- [Fax Tones](#)
- [Fax/Tel](#)
- [Fine Resolution](#)

G

- [Gateway](#)
- [Grey Scale](#)
- [Group Number](#)

I

- [IEEE 802.11b/g/n](#)
- [Infrastructure Mode](#)
- [Innobella](#)
- [IP Address](#)
- [IPv6](#)

J

- [Journal Period](#)

L

- [LAN](#)
- [LLMNR](#)
- [LPD](#)

- [LPR](#)

M

- [MAC Address](#)
- [MAC Address Filtering](#)
- [Manual Fax](#)
- [mDNS](#)
- [Memory Receive](#)

N

- [NetBIOS Name Resolution](#)
- [Network Configuration Report](#)
- [Network Connection Repair Tool](#)
- [Network Key](#)
- [Network PC-FAX](#)
- [Network PhotoCapture Center](#)
- [Network Remote Setup](#)
- [Network Shared Printing](#)
- [Node Name](#)

O

- [OCR \(Optical Character Recognition\)](#)
- [Open System](#)
- [Overseas Mode](#)

P

- [Pause](#)
- [Peer-to-Peer](#)
- [Photo resolution \(Mono only\)](#)

- [PhotoCapture Center](#)
- [PictBridge](#)
- [Ping](#)
- [Polling](#)
- [Protocols](#)
- [Pulse](#)

R

- [RARP](#)
- [Real Time Transmission](#)
- [Remaining Jobs](#)
- [Remote Access Code](#)
- [Remote Activation Code \(Fax/Tel Mode Only\)](#)
- [Remote Deactivation Code \(Fax/Tel Mode only\)](#)
- [Remote Retrieval Access](#)
- [Remote Setup](#)
- [Resolution](#)
- [Ring Delay](#)
- [Ring Volume](#)

S

- [Scanning](#)
- [Search](#)
- [Settings Tables](#)
- [SNMP](#)
- [SSID](#)
- [Standard resolution](#)

- [Station ID](#)
- [Status Monitor](#)
- [Subnet Mask](#)
- [Super Fine resolution \(Mono only\)](#)
- [Switching Hub](#)

T

- [TAD \(Telephone Answering Device\)](#)
- [TCP/IP](#)
- [Temporary Settings](#)
- [TKIP](#)
- [Tone](#)
- [Transmission](#)
- [Transmission Verification Report](#)

U

- [User Settings List](#)

V

- [Vertical Pairing](#)

W

- [Web Services](#)
- [WEP](#)
- [Wi-Fi Direct®](#)
- [WINS](#)
- [WINS Server](#)
- [Wireless LAN Access Point/Router](#)
- [WLAN Report](#)

▲ Home > Glossary

- [WPA-PSK/WPA2-PSK Authentication Method](#)
- [WPS](#)

X

- [Xmit Report \(Transmission Verification Report\)](#)

Ad-Hoc Mode

The mode of operation in a wireless network, in which all devices (machines and computers) are connected without an access point/router.

Address Book

Names and numbers you have stored for easy dialling.

Address Book List

A listing of names and numbers stored in the Address Book memory, in alphabetical order.

ADF (Automatic Document Feeder)

The document can be placed in the ADF and scanned one page at a time automatically.

AES

Advanced Encryption Standard (AES) is the Wi-Fi®-authorised strong encryption standard.

AOSS™

AirStation One-Touch Secure System (AOSS™) is a system provided by Buffalo Technology. AOSS™ allows you to configure a secure wireless connection with the push of a button.

APIPA

If you do not assign an IP address manually or automatically (using a DHCP, BOOTP, or RARP server), the Automatic Private IP Addressing (APIPA) protocol will automatically assign an IP address from the range 169.254.1.0 to 169.254.254.255.

ARP

Address Resolution Protocol (ARP) performs mapping of an IP address to a MAC address in a TCP/IP network.

ASCII

The acronym for American Standard Code for Information Interchange. ASCII codes were established by the American National Standards Institute to serve as numerical representations of characters and symbols for information exchange. For example, the ASCII code "41" is the character "A" in the English alphabet.

Authentication

Most wireless networks use some kind of security settings. These security settings define the authentication (how the device identifies itself to the network) and encryption (how the data is encrypted as it is sent on the network). If you do not correctly specify these options when you are configuring your Brother wireless machine, it will not be able to connect to the wireless network. Therefore, care must be taken when configuring these options.

Authentication Methods for a Personal Wireless Network

A personal wireless network is a small network (such as a home wireless network) without IEEE 802.1x support.

- Open system

Wireless devices are allowed to access the network without any authentication.

- Shared key

A secret pre-determined key is shared by all devices that will access the wireless network. The Brother wireless machine uses the WEP key as the pre-determined key.

- WPA-PSK/WPA2-PSK

Enables a Wi-Fi Protected Access® Pre-shared key (WPA-PSK/WPA2-PSK), which enables the Brother wireless machine to associate with access points using TKIP for WPA-PSK or AES for WPA-PSK and WPA2-PSK (WPA-Personal).

Auto Reduction

Reduces the size of incoming faxes.

Automatic Fax Transmission

Sending a fax without picking up the handset of the external telephone.

Automatic Redial

A feature that enables your machine to redial the last fax number after five minutes if the fax did not go through because the line was busy.

Backup Print

Your machine prints a copy of every fax that is received and stored in memory. This is a safety feature so you will not lose messages during a power failure.

Batch Transmission

As a cost saving feature, all delayed faxes to the same fax number will be sent as one transmission.

Beeper Volume

Volume setting for the sound when you press a button or make an error.

BOOTP

The Bootstrap Protocol (BOOTP) is a network protocol used by a network client to obtain an IP Address from a configuration server.



To use BOOTP, contact your network administrator.

BRAdmin Light (Windows®)

BRAdmin Light is a utility for the initial setup of Brother network-connected devices. This utility can search for Brother products on your network, view the status and configure the basic network settings, such as IP address.

Go to your model's **Downloads** page on the Brother Solutions Center at support.brother.com to download BRAdmin Light.

BRAdmin Professional (Windows®)

BRAdmin Professional is a utility for more advanced management of network-connected Brother devices. This utility can search for Brother products on your network and view the device status from an easy-to-read Windows® Explorer-style screen that changes colour to identify the status of each device. You can configure network and device settings, and update device firmware from a Windows® computer on your LAN. BRAdmin Professional can also log activity of Brother devices on your network and export the log data.

Go to your model's **Downloads** page on the Brother Solutions Center at support.brother.com to download the software.



- This utility is available only for Windows®.
- Go to your model's **Downloads** page on the Brother Solutions Center at support.brother.com to download the latest version of Brother's BRAdmin Professional utility.
- Node name: The node name appears in the current BRAdmin Professional window. The default node name is "BRNxxxxxxxxxxxx" for a wired network or "BRWxxxxxxxxxxxx" for a wireless network (where "xxxxxxxxxxxx" is your machine's MAC Address / Ethernet address).
- If using Windows® Firewall, or the firewall function of an anti-spyware or antivirus application, temporarily disable them. When you are sure you can print, configure the software settings following the instructions.

Broadcasting

The ability to send the same fax message to more than one location.

BT Call Sign

A subscriber service purchased from the telephone company in the U.K. that gives you another phone number on an existing phone line. The Brother machine uses the new number to simulate a dedicated fax line.

Caller ID

A service purchased from the telephone company that lets you see the number (or name) of the party calling you.

Channels

Wireless networks use channels. Each wireless channel is on a different frequency. There are up to 14 different channels that can be used when using a wireless network. However, in many countries the number of channels available is restricted.

CNG Tones

The special tones (beeps) sent by fax machines during automatic transmission to tell the receiving machine that a fax machine is calling.

Coding Method

Method of coding the information contained in the document. All fax machines must use a minimum standard of Modified Huffman (MH). Your machine is capable of greater compression methods, Modified Read (MR), Modified Modified Read (MMR) and JPEG, if the receiving machine has the same capability.

Colour Enhancement

Adjusts the colour in the image for better print quality by improving sharpness, white balance and colour density.

Communication Error (or Comm. Error)

An error during fax sending or receiving, usually caused by line noise or static.

Compatibility Group

The ability of one fax unit to communicate with another. Compatibility is assured between ITU-T Groups.

Contrast

Setting to compensate for dark or light documents, by making faxes or copies of dark documents lighter and light documents darker.

Custom Raw Port

Custom raw port is a commonly used printing protocol on a TCP/IP network that enables interactive data transmission. Default is Port 9100.

Delayed Fax

Sends your fax at a specified later time that day.

Density

Changing the Density makes the whole image lighter or darker.

DHCP

The Dynamic Host Configuration Protocol (DHCP) is a network protocol that is used to configure network devices so that they can communicate on an IP Network.



To use DHCP, contact your network administrator.

DNS Client

The Brother print server supports the Domain Name System (DNS) client feature. This feature allows the print server to communicate with other devices using its DNS name.

DNS Server

The Domain Name System (DNS) is a technology to manage the names of web sites and internet domains. A DNS server allows your computer to find its IP address automatically.

Domain Name

Generally, in an e-mail address such as "taro@brother.co.jp", the domain name is the "brother.co.jp" portion of the address after the @ mark.

Driver Deployment Wizard

Brother's Installation CD-ROM includes the Windows® printer driver and Brother network port driver (LPR and NetBIOS). If an administrator installs the printer driver and port driver using this application, the administrator can save the file to the file server or send the file by email to users. Then, each user just clicks that file to have the printer driver, port driver, IP address, etc. automatically copied to their computer.

ECM (Error Correction Mode)

Detects errors during fax transmission and resends the pages of the fax that had an error.

Encryption

Most wireless networks use some kind of security settings. These security settings define the authentication (how the device identifies itself to the network) and encryption (how the data is encrypted as it is sent on the network). If you do not correctly specify these options when you are configuring your Brother wireless machine, it will not be able to connect to the wireless network. Therefore, care must be taken when configuring these options.

Encryption Methods for a Personal Wireless Network

A personal wireless network is a small network (such as a home wireless network) without IEEE 802.1x support.

- None
No encryption method is used.
- WEP
When using Wired Equivalent Privacy (WEP) the data is transmitted and received with a secured key.
- TKIP
Temporal Key Integrity Protocol (TKIP) provides per-packet key mixing a message integrity check and rekeying mechanism.
- AES
Advanced Encryption Standard (AES) provides stronger data protection using a symmetric-key encryption.



- IEEE 802.11n does not support either WEP or TKIP as an encryption method.
- To connect to your wireless network using IEEE 802.11n, we recommend selecting AES.

Extension Telephone

A telephone on the fax number that is plugged into a separate wall socket.

External Phone

A TAD (telephone answering device) or telephone that is connected to your machine.

F/T Ring Time

The length of time that the Brother machine pseudo/double-rings (when the Receive Mode setting is Fax/Tel) to notify you to pick up a voice call that it answered.

Fax Detect

Enables your machine to respond to CNG tones if you interrupt a fax call by answering it.

Fax Forwarding

Sends a fax received into the memory to another pre-programmed fax number.

Fax Journal

Lists information about the last 200 incoming and outgoing faxes. TX means Transmit. RX means Receive.

Fax Storage

You can store faxes in the memory.

Fax Tones

The signals sent by sending and receiving fax machines while communicating information.

Fax/Tel

You can receive faxes and telephone calls. Do not use this mode if you are using a telephone answering device (TAD).

Fine Resolution

Resolution is 203 × 196 dpi. It is used for small print and graphs.

Gateway

A gateway is a network point that acts as an entrance to another network and sends data transmitted via the network to an exact destination. The router knows where to direct data that arrives at the gateway. If a destination is located on an external network, the router transmits data to the external network. If your network

communicates with other networks, you may need to configure the Gateway IP address. If you do not know the Gateway IP address, then contact your Network Administrator.

Grey Scale

The shades of grey available for copying and faxing photographs.

Group Number

A combination of Address Book numbers that are stored in Address Book for Broadcasting.

IEEE 802.11b/g/n

Wireless LAN standards that were established by IEEE (Institute of Electrical and Electronics Engineers). IEEE802.11n standards are backward compatible with IEEE802.11g and IEEE802.11b standards. The transmission speeds are 11 Mbit/sec or lower for IEEE802.11b, 54 Mbit/sec or lower for IEEE802.11g, and 100 Mbit/sec or higher for IEEE802.11n. The wireless LAN features of this product comply with the IEEE802.11b, IEEE802.11g, and IEEE802.11n standards.

Infrastructure Mode

The mode of operation in a wireless network, in which all devices (machines and computers) are connected via an access point/router.

Innobella

Innobella is a range of genuine supplies offered by Brother. For best quality results, Brother recommends Innobella ink and paper.

IP Address

An Internet Protocol (IP) address is a series of numbers that identifies each device connected to a network. An IP address consists of four numbers separated by dots. Each number is between 0 and 255.

Example: In a small network, you would normally change the final number.

192.168.1.1

192.168.1.2

192.168.1.3

How the IP address is assigned to your print server:

If you have a DHCP/BOOTP/RARP server in your network, the print server will automatically obtain its IP address from that server.



On smaller networks, the DHCP server may also be the Router.

If you do not have a DHCP/BOOTP/RARP server, the Automatic Private IP Addressing (APIPA) protocol will automatically assign an IP address from the range 169.254.1.0 to 169.254.254.255.

IPv6

IPv6 is the next generation Internet protocol. For more information on the IPv6 protocol, go to your model's page on the Brother Solutions Center at support.brother.com.

Journal Period

The pre-programmed time period between automatically printed Fax Journal Reports. You can print the Fax Journal on demand without interrupting the cycle.

LAN

The acronym for Local Area Network. Refers to a network of computers that are located in the same building, on the same floor, and so on, and are connected using an Ethernet or other connection method. This type of network is considered a closed network.

LLMNR

The Link-Local Multicast Name Resolution (LLMNR) protocol resolves the names of neighboring computers, if the network does not have a Domain Name System (DNS) server. The LLMNR Responder feature works in both the IPv4 or IPv6 environment when using Windows Vista® or greater.

LPD

Line Printer Daemon (LPD or LPR) protocol is a commonly-used printing protocol on a TCP/IP network, mainly for UNIX®-based operating systems.

LPR

Line Printer Daemon (LPR or LPD) protocol is a commonly-used printing protocol on a TCP/IP network.

MAC Address

The MAC Address (Ethernet Address) is a unique number assigned for the machine's network interface.

MAC Address Filtering

This security method controls access to the network by registering MAC addresses to a wireless LAN access point so that only authorised wireless LAN devices will be able to connect to the network.

Manual Fax

When you lift the handset of your external telephone so you can hear the receiving fax machine answer before you press Fax Start to begin transmission.

mDNS

Multicast DNS (mDNS) allows the Brother print server to configure itself to work in an OS X Simple Network Configuration system automatically.

Memory Receive

Receives faxes into the machine's memory when the machine is out of paper.

NetBIOS Name Resolution

Network Basic Input/Output System (NetBIOS) name resolution enables you to obtain the IP address of the other device using its NetBIOS name during the network connection.

Network Configuration Report

The Network Configuration Report prints a report listing the current network configuration, including the network print server settings.

Network Connection Repair Tool

The Network Connection Repair Tool is a program Brother provides to correct the driver's settings so that they match the machine's network settings. To use the Network Connection Repair Tool, ask your network administrator.

Network Key

The Network Key is a password, which is used when the data is encrypted or decrypted. The Network Key is also described as the Password, Security Key, or Encryption Key. The table shows the number of characters of the key to use for each setting.

Open system/Shared key with WEP

This key is a 64-bit or a 128-bit value that must be entered in an ASCII or hexadecimal format.

	ASCII	Hexadecimal
64 (40) bit	Uses five text characters. For example, "WSLAN" (case-sensitive).	Uses 10 digits of hexadecimal data. For example, "71f2234aba" (not case-sensitive).
128 (104) bit	Uses 13 text characters. For example, "Wirelesscomms" (case-sensitive).	Uses 26 digits of hexadecimal data. For example, "71f2234ab56cd709e5412aa2ba" (not case-sensitive).

WPA-PSK/WPA2-PSK and TKIP or AES

Uses a Pre-Shared Key (PSK) that is eight or more characters in length, up to a maximum of 63 characters.

Network PC-FAX

Use Network PC-FAX to send a file from your computer as a fax. Windows® users can also receive faxes via PC-FAX.

Network PhotoCapture Center

Use Brother's Network PhotoCapture Center to view, retrieve and save data from a USB flash drive or a media card inserted into the Brother machine. The software is automatically installed when you select Network Connection during the software installation. For Windows®, select the **Photo** tab in ControlCenter4. For Mac, launch any web browser that supports FTP connections, and type FTP://xxx.xxx.xxx.xxx (where xxx.xxx.xxx.xxx is the IP address of your Brother machine).

Network Remote Setup

The Remote Setup software allows you to configure network settings from either a Windows® or Mac computer.

Network Shared Printing

Network Shared Printing is a type of printing in a network shared environment. In a network shared environment, each computer sends data via a server or print server.

Node Name

The Node Name is a machine name on the network. This name is often referred to as a NetBIOS name; it will be the name that is registered by the WINS server on your network. Brother recommends the name "BRNxxxxxxxxxxxx" for a wired network or "BRWxxxxxxxxxxxx" for a wireless network (where "xxxxxxxxxxxx" is your machine's MAC address / ethernet address.)

OCR (Optical Character Recognition)

Nuance™ PaperPort™ or Presto! PageManager software application converts an image of text to text you can edit.

Open System

Open System is one of the network authentication methods. Under open system authentication, any wireless devices are allowed to access the network without requiring a WEP key.

Overseas Mode

Makes temporary changes to the fax tones to accommodate noise and static on overseas telephone lines.

Pause

Allows you to place a delay in the dialling sequence while you are dialling or while you are storing Address Book numbers. Press Pause on the LCD as many times as needed for longer pauses.

Peer-to-Peer

Peer-to-Peer is a type of printing in a peer-to-peer environment. In a peer-to-peer environment, each computer sends and receives data directly to and from each device. There is no central server controlling access or machine sharing.

Photo resolution (Mono only)

A resolution setting that uses varying shades of grey for the best representation of photographs.

PhotoCapture Center

Use Brother's PhotoCapture Center to view, retrieve and save data from a USB flash drive or a media card inserted into the Brother machine. For Windows®, select the **Photo** tab in ControlCenter4.

PictBridge

Allows you to print photos directly from your digital camera at high resolution for photo quality printing.

Ping

This is a computer network administration utility to test whether sent data can reach a specified host.

Polling

The process of a fax machine calling another fax machine to retrieve waiting fax messages.

Protocols

Protocols are the standardised sets of rules for transmitting data on a network. Protocols allow users to gain access to network-connected resources. The print server used on your Brother machine supports the Transmission Control Protocol/Internet Protocol (TCP/IP) protocol.

Pulse

This feature is not available in some countries.

A form of rotary dialling on a telephone line.

RARP

Reverse Address Resolution Protocol (RARP) finds the logical address for a machine that knows only its physical address.



To use RARP, contact your network administrator.

Real Time Transmission

When memory is full, you can send faxes in real time.

Remaining Jobs

You can check which programmed fax jobs are waiting in the memory and cancel the jobs individually.

Remote Access Code

Your own four-digit code (– – –*) that allows you to call and access your machine from a remote location.

Remote Activation Code (Fax/Tel Mode Only)

Press this code (*51) when you answer a fax call on an extension or external telephone.

Remote Deactivation Code (Fax/Tel Mode only)

When the machine answers a voice call, it pseudo/double-rings. You can pick up at an extension telephone by pressing this code (# 5 1).

Remote Retrieval Access

The ability to access your machine remotely from a touch tone telephone.

Remote Setup

The Remote Setup program lets you configure many machine and network settings from a computer application. When you start this application, the settings on your machine will be downloaded automatically to your computer and displayed on your computer screen. If you change the settings, you can upload them directly to the machine.

Resolution

The number of vertical and horizontal lines per inch.

Ring Delay

The number of rings before the machine answers in Fax Only and Fax/Tel modes.

Ring Volume

Volume setting for the machine's ring.

Scanning

The process of sending an electronic image of a paper document into your computer.

Search

An alphabetical electronic listing of stored Address Book and Group numbers.

Settings Tables

At-a-glance instructions that show all the settings and options that are available for setting up your machine.

SNMP

The Simple Network Management Protocol (SNMP) is used to manage network devices including computers, routers and Brother network-ready machines.

SSID

Each wireless network has its own unique network name and it is technically referred to as a Service Set Identifier (SSID). The SSID is a 32-byte or less value and is assigned to the access point. The wireless network devices you want to associate to the wireless network should match the access point. The access point and wireless network devices regularly send wireless packets (referred to as beacons), which contain the SSID information. When your wireless network device receives a beacon, you can identify the wireless network that is close enough for the radio waves to reach your device.

Standard resolution

203 × 98 dpi (monochrome). 203 × 196 dpi (colour). It is used for regular sized text and the quickest transmission.

Station ID

The stored information that appears on the top of faxed pages. It includes the sender's name and fax number.

Status Monitor

The Status Monitor utility is a configurable utility to monitor the status of one or more devices, allowing you to get immediate notification when there is a problem, for example, when the machine runs out of paper or jams.

Subnet Mask

A subnet mask allows you to identify which part of an IP address is used as the network address and which part is used as the host address.

In the following example, the last segment of the IP address is known as the host address and the first three segments are the network address.

Example: Computer 1 can talk to Computer 2

- Computer 1
IP Address: 192.168.1.2
Subnet Mask: 255.255.255.0
- Computer 2
IP Address: 192.168.1.3
Subnet Mask: 255.255.255.0



0 denotes that there is no limit to communication at this part of the address.

Super Fine resolution (Mono only)

203 × 392 dpi. Best for very small print and line art.

Switching Hub

A central device (hub) that has a switching function. This hub distributes packets to the specified destinations, localizes network traffic, and can increase the communication bandwidth of the entire network. Although network devices are interconnected using a hub in 10BASE-T, 100BASE-TX, and other networks, the effective bandwidth will quickly become saturated due to the Ethernet communication method when the number of nodes increases. Therefore, switching technology was developed to directly connect only the ports that are actually communicating without sending data to other ports. A hub that incorporates this technology is called a switching hub.

TAD (Telephone Answering Device)

You can connect an external TAD to your machine.

TCP/IP

Transmission Control Protocol/Internet Protocol (TCP/IP) is the most popular set of protocols used for communication, such as Internet and email. This protocol can be used in almost all operating systems, including Windows®, Windows Server®, OS X and Linux®.

Temporary Settings

You can choose certain options for each fax transmission and copy without changing the default settings.

TKIP

Temporal Key Integrity Protocol (TKIP) is one of the encryption methods adopted by WPA™ to be used in a wireless network. TKIP provides per-packet key mixing, a message integrity check and rekeying mechanism.

Tone

This feature is not available in some countries.

A form of dialling on the telephone line used for Touch Tone telephones.

Transmission

The process of sending faxes over the telephone lines from your machine to the receiving fax machine.

Transmission Verification Report

A report for each transmission, that shows its date, time and number.

User Settings List

A printed report that shows the current settings of the machine.

Vertical Pairing

Vertical Pairing is a technology for Windows® that allows your Vertical Pairing-supported wireless machine to connect to your Infrastructure network using the PIN Method of Wi-Fi Protected Setup™ and the Web Services feature. It also enables printer driver installation from the printer icon in the **Add a device** screen.

Web Services

The Web Services protocol enables Windows Vista®, Windows® 7, Windows® 8, or Windows® 10 users to install the drivers used for printing and scanning by using the machine icon in the **Network** folder. Web Services also lets you check the current status of the machine from your computer.

WEP

Wired Equivalent Privacy (WEP) is one of the encryption methods used in a wireless network. When using WEP, the data is transmitted and received with a secure key.

Wi-Fi Direct®

Wi-Fi Direct is one of the wireless configuration methods developed by the Wi-Fi Alliance®. This type of connection is a Wi-Fi standard that allows devices to connect with each other without a wireless access point, using secured method.

WINS

Windows® Internet Name Service (WINS) is an information-providing service for NetBIOS name resolution. It consolidates an IP address and a NetBIOS name that is in the local network.

WINS Server

Windows® Internet Name Service (WINS) Server maps IP addresses to computer names (NetBIOS names) in a Windows® network.

Wireless LAN Access Point/Router

A central device in a network that allows individual wireless LAN devices to connect to the network to communicate. In addition, the wireless LAN access point/router also manages the security.

WLAN Report

The WLAN Report prints your machine's wireless status report. If the wireless connection fails, check the error code on the printed report.

WPA-PSK/WPA2-PSK Authentication Method

WPA-PSK/WPA2-PSK authentication method enables a Wi-Fi Protected Access® Pre-shared key (WPA-PSK/WPA2-PSK), which enables the Brother wireless machine to associate with access points using TKIP for WPA-PSK or AES for WPA-PSK and WPA2-PSK (WPA-Personal).

WPS

Wi-Fi Protected Setup™ (WPS) is a standard that allows the setup of secured wireless networks. WPS was created by the Wi-Fi Alliance® in 2007.

Xmit Report (Transmission Verification Report)

A listing for each transmission, that shows its date, time and number.

brother

Visit us on the World Wide Web
www.brother.com



UK
Version A