

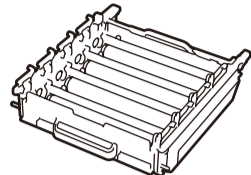

Unpack the machine and check the components

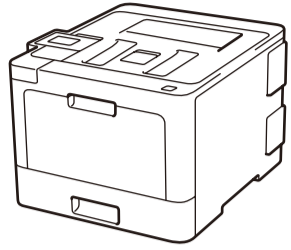

Drum Unit*

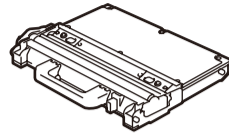

Waste Toner Box*

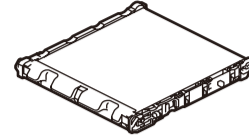

Belt Unit*

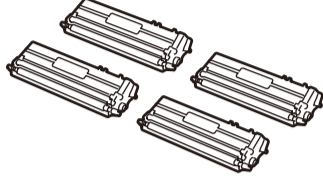

Toner Cartridges*
(Black, Cyan, Magenta and Yellow)



Brother Installation Disc



AC Power Cord



Quick Setup Guide



Product Safety Guide

* Already installed in the machine

NOTE:

- Manuals in Spanish for this model are available on the Brother Solutions Center. (USA only): solutions.brother.com/manuals
Los manuales en español de este modelo están disponibles en el Brother Solutions Center. (Solamente en los Estados Unidos): solutions.brother.com/manuals
- The components included in the box may differ depending on your country.
- The available connection interfaces vary depending on the model.
- Interface cables are not included. If you require one, it will need to be purchased. Use one of the following cables:

USB cable

We recommend using a USB 2.0 cable (Type A/B) that is no more than 6 feet (2 meters) long.

Network cable

Use a straight-through Category 5e (or greater) twisted-pair cable.



Watch our Video FAQs for help with setting up your Brother machine:
solutions.brother.com/videos.

1 Remove the packing materials and install the drum unit and toner cartridge assembly

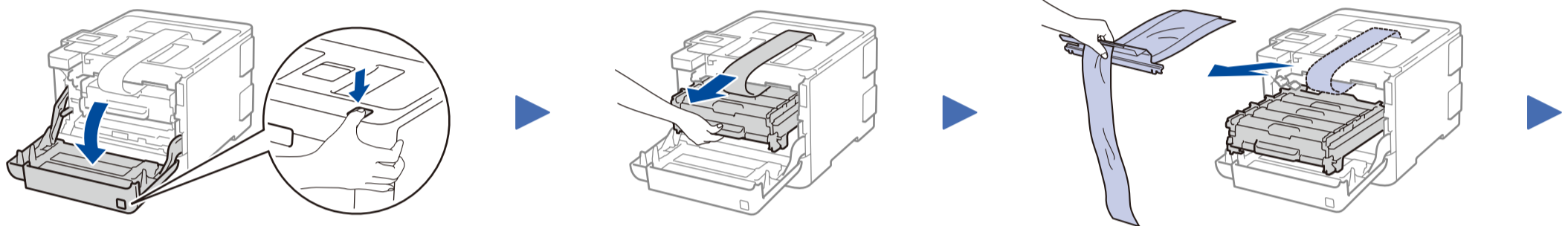

Remove the packing tape.

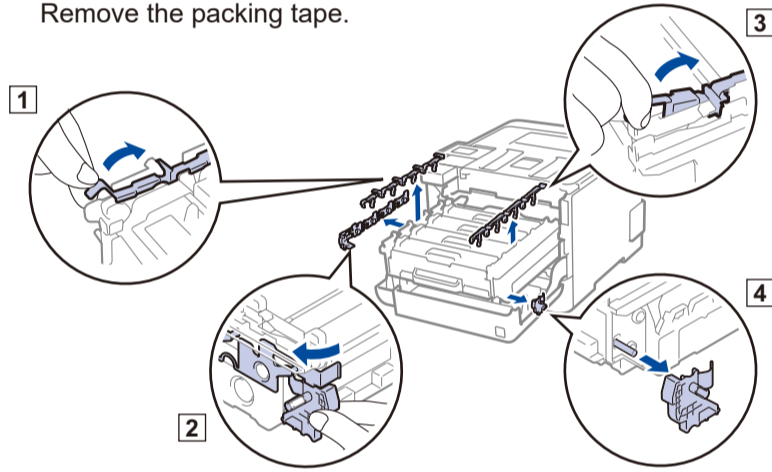

2 Load paper in the paper tray

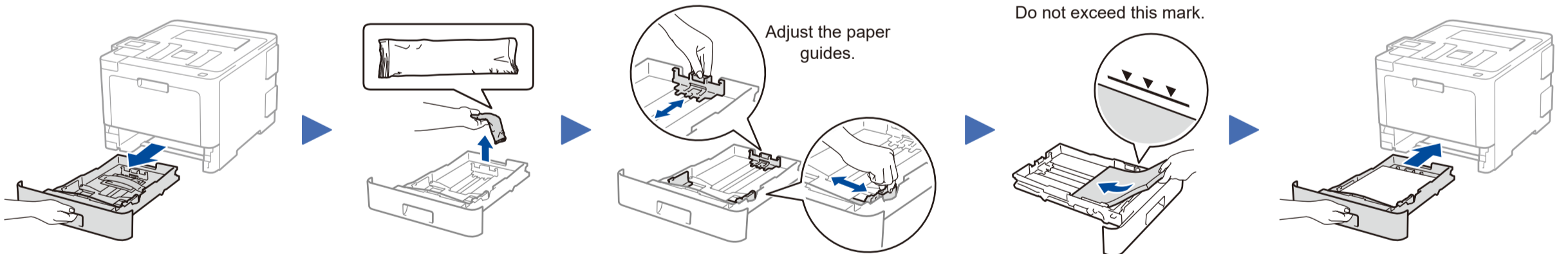

3 Connect the power cord and turn the machine on

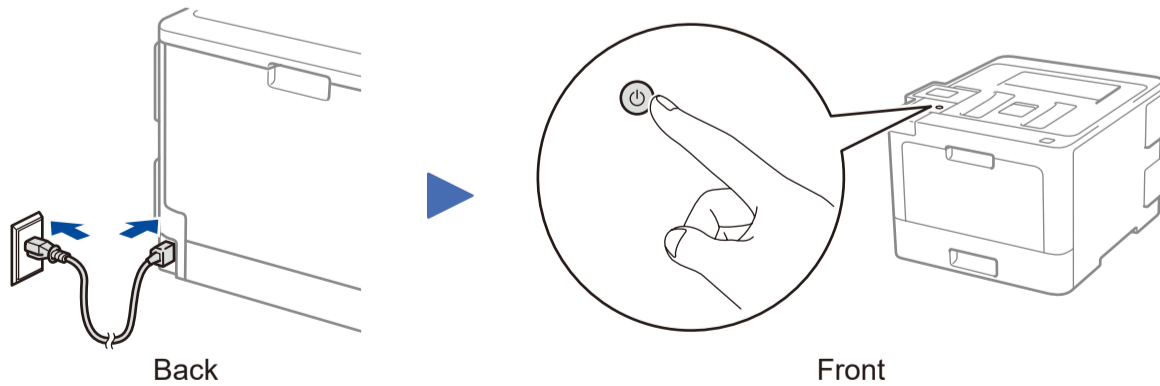

4 Select your language (if needed)

1. On the machine's Touchscreen, press [Settings] > [All Settings] > [Initial Setup] > [Local Language].
2. Press your language.
3. Press .

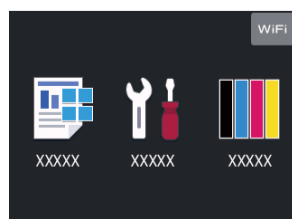

5 Select a device to connect to your machine

Computer

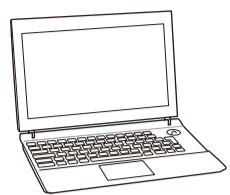

Go to **6** and follow the instructions.

Mobile Device

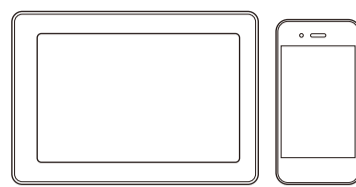

Go to **7** and follow the instructions.

6 Connect your computer

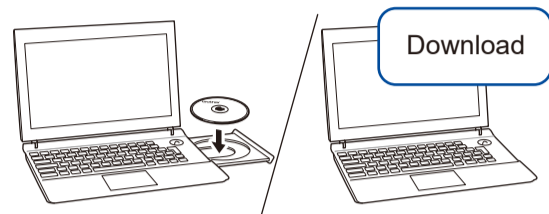

Put the installation disc into your CD/DVD drive, or download the Full Driver & Software Package at:

For Windows®: solutions.brother.com/windows
For Macintosh: solutions.brother.com/mac

If you are using a recently released operating system on your computer, visit the above websites for updated driver and software information.

Brother regularly updates firmware to add features and apply bug fixes. To check for the latest firmware, visit solutions.brother.com/up3.

Follow the on-screen instructions and prompts.

For Windows®:
If the Brother screen does not appear automatically, go to **Computer (This PC)**. Double-click the CD/DVD-ROM icon, and then double-click **start.exe**.

For Macintosh:
For full driver functionality, we recommend choosing the **CUPS driver** when adding a printer.

Finished

For Network Users: Important Notice for Network Security
The default Web Based Management password is located on the back of the machine and marked "Pwd". We recommend immediately changing the default password to use network tools/utilities securely and to protect your machine from unauthorized access.

Can't Connect? Check the following:

Wireless network

Restart your wireless access point/router (if possible).

Wired network

USB connection

Disconnect the cable.

Restart your machine and computer, and then go to **6**.

If still not successful, go to **7**.

If still not successful, visit support.brother.com for FAQs & Troubleshooting.

7 Alternative wireless setup

Find your SSID (Network Name) and Network Key (Password) on your wireless access point/router and write them in the table provided below.

SSID (Network Name)	
Network Key (Password)	

SSID: XXXXXXXX
Network key: XXXX

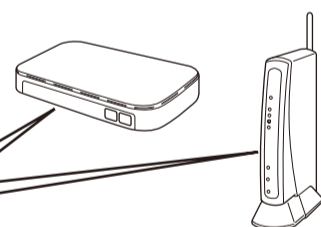

Press **WiFi** > [Setup Wizard] > [Yes].

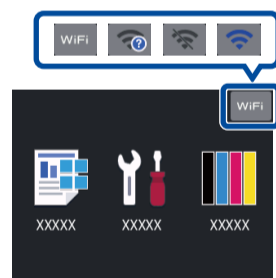

Even if you do not have a wireless access point/router, you can connect your device and your machine directly. For additional wireless network support, go to solutions.brother.com/wireless-support.

Select the SSID (Network Name) for your access point/router and enter the Network Key (Password).

When the wireless setup is successful, the Touchscreen displays [Connected].

If setup is not successful, restart your Brother machine and your wireless access point/router, and repeat **7**.

For Computer

Go to **6** to install software.

For Mobile Device

Go to **8** to install apps.

8 Print using your mobile device

Your mobile device must be connected to the same wireless network as your Brother machine.

Brother SupportCenter is a mobile app that provides the latest support information for your Brother product. Visit the App Store or Google Play™ to download.

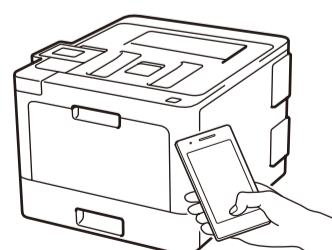

AirPrint is available for Apple device users. You do not need to download any software to use AirPrint. For more information, see the *Online User's Guide*.



Download and install our free application **Brother iPrint&Scan** from a mobile application store, such as the App Store, Google Play™ or Microsoft® Store using your mobile device.

Optional apps

You can print from your mobile device using various apps. (USA only) For more information on apps, visit www.brother-usa.com/connect. For instructions, see the *Online User's Guide*.



Additional Wireless Support: solutions.brother.com/wireless-support

For FAQs, Troubleshooting, and to download software and manuals, visit support.brother.com.

© 2017 Brother Industries, Ltd. All rights reserved.