

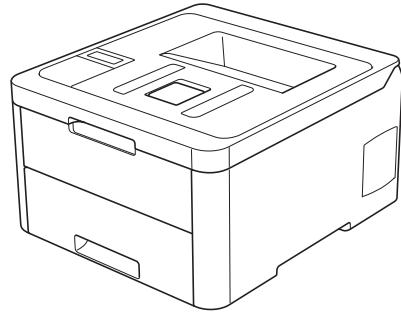

Reference Guide

Brief explanations for routine operations

HL-L3210CW
HL-L3230CDN
HL-L3230CDW
HL-L3270CDW



Brother recommends keeping this guide next to your Brother machine for quick reference.



Online User's Guide

For more advanced instructions, information, and product specifications, see the *Online User's Guide* at support.brother.com/manuals



User's Guides and Where to Find Them

Which Guide?	What's in It?	Where Is It?
Product Safety Guide	Read this Guide first. Please read the Safety Instructions before you set up your machine. See this Guide for trademarks and legal limitations.	Printed / In the box
Quick Setup Guide	Follow the instructions for setting up your machine, and installing the Full Driver & Software Package for the operating system and connection type you are using.	Printed / In the box
Reference Guide	Learn the basic operations and basic machine maintenance. See troubleshooting tips.	Printed or on Brother Installation Disc / In the Box
Online User's Guide	In addition to information about the Print operations, mobile device functions, troubleshooting, and other useful information is included about using the machine on a network.	Brother Solutions Center ¹

¹ Visit support.brother.com/manuals.

The Online User's Guide Helps You Get the Most Out of Your Machine

We hope that you find this guide helpful. To learn more about your machine's features, please take a look at our *Online User's Guide*. It offers:

Quicker Navigation!

- ✓ Search box
- ✓ Navigation index in a separate panel

Comprehensive Format!

- ✓ Every topic in one guide

Simplified Layout!

- ✓ Step-by-step instructions
- ✓ Feature summary at the top of the page



1. Search Box
2. Navigation
3. Summary
4. Step-by-Step Instructions

To View Online User's Guides

To view the *Online User's Guide* and other available guides, visit support.brother.com/manuals.

(Windows®)

You can also access your machine's guides using Brother Utilities. The Brother Utilities tool is included in the standard installation and, when installed, you can find it either as a shortcut on your desktop, or from the Windows® **Start** menu.

Questions or Problems? Take a Look at our FAQs, Solutions, and Videos Online.

Go to your model's **FAQs & Troubleshooting** page on the Brother Solutions Center at support.brother.com

- **Provides several ways to search**
- **Displays related questions for more information**
- **Receives regular updates based on customer feedback**

©2018 Brother Industries, Ltd. All rights reserved.

1

General Information

Control Panel Overview

The control panel may vary depending on your model.

HL-L3210CW/HL-L3230CDN/HL-L3230CDW

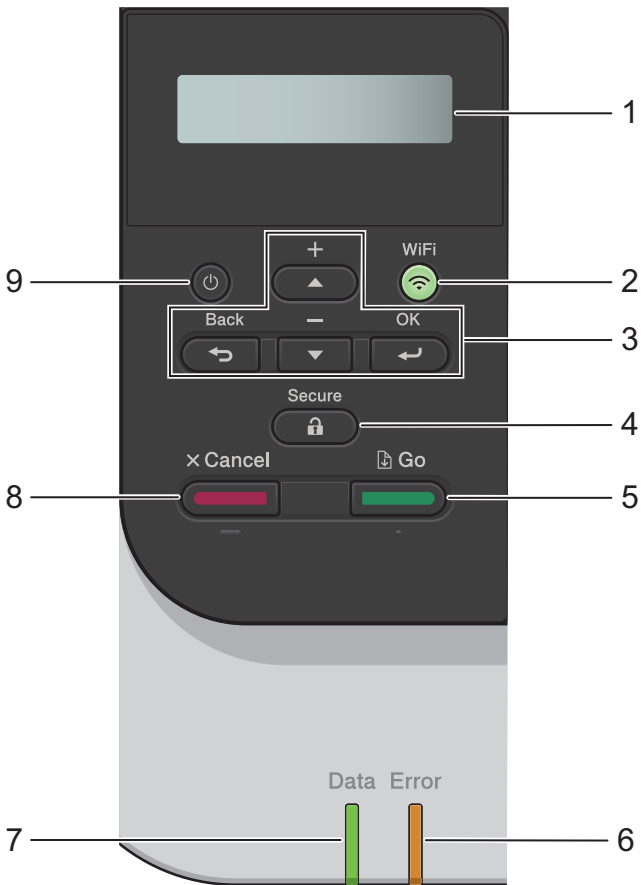

1. Liquid Crystal Display (LCD)

Displays messages to help you set up and use the machine.

- Wireless Network Models

A four-level indicator shows the wireless signal strength if you are using a wireless connection.



2. WiFi or Network Buttons

- Wired Network Models:

Network

Press the **Network** button to set up wired network settings.

- Wireless Network Models:

WiFi

Launch the wireless installer on your computer and press the **WiFi** button. Follow the on-screen instructions to set up a wireless connection between your machine and your network.

When the **WiFi** light is on, your Brother machine is connected to a wireless access point. When the **WiFi** light blinks, the wireless connection is down, or your machine is in the process of connecting to a wireless access point.

3. Menu Buttons

OK

Press to select the displayed option. After you change a setting, the machine returns to the previous menu level.

Back

- Press to go back one level in the menu.
- Press to select the previous digit when entering numbers.

▲ or ▼ (+ or -)

- Press to scroll through menus and options.
- Press to enter or change a letter or number. Hold down ▲ or ▼ to scroll faster. When you see the letter or number you want, press **OK**.

4. Secure

Press to print jobs saved in the memory when you enter your four-digit password.

5. Go

- Press to clear certain error messages. To clear all other errors, follow the LCD instructions.
- Press to print any data remaining in the machine's memory.
- Press to select the displayed option. After you change a setting, the machine returns to Ready Mode.

6. Error LED

The **Error** LED blinks when the LCD displays an error or an important status message.

7. Data LED

The **Data** LED blinks depending on the machine's status.

When the **Data** LED is on, data is in the machine's memory. When the **Data** LED blinks, the machine is receiving or processing data.

8. Cancel

- Press to cancel the current setting.
- Press to cancel a programmed print job and clear it from the machine's memory. To cancel multiple print jobs, hold down **Cancel** until the LCD displays [Cancel All Jobs].

9. Power On/Off

- Turn the machine on by pressing .

- Turn the machine off by pressing and holding down .

HL-L3270CDW

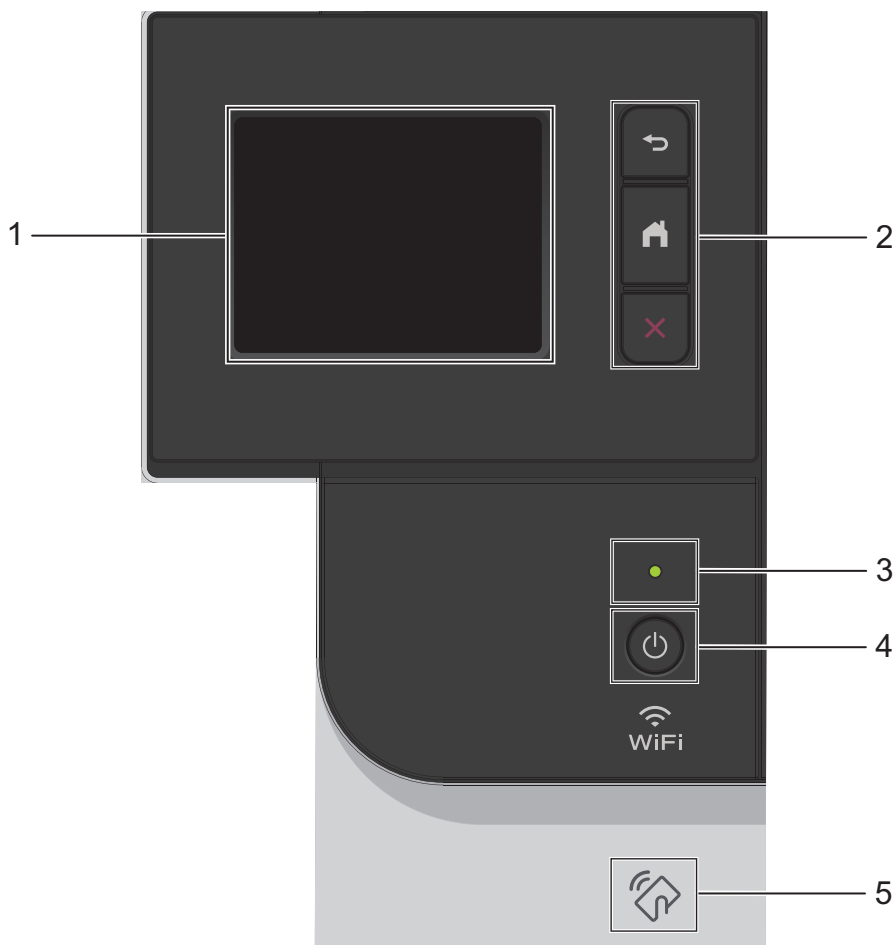

1. Touchscreen Liquid Crystal Display (LCD)

Access menus and options by pressing them on the touchscreen.

2. Menu buttons



Press to go back to the previous menu.



Press to return to the Home screen.





Press to cancel an operation. Press to cancel a programmed print job and clear it from the machine's memory.

3. LED Power Indicator

The LED lights up depending on the machine's power status.

4. Power On/Off

- Turn the machine on by pressing .
- Turn the machine off by pressing and holding down .

5. Near Field Communication (NFC)

If your Android™ device supports the NFC feature, you can print from your mobile device by touching it to the NFC symbol on the control panel.

Touchscreen LCD Overview

Related Models:
HL-L3270CDW

From the Home screen, you can access the WiFi setup, Toner level, Settings, and Functions screens.

The Home screen displays the machine's status when the machine is idle. When displayed, this screen indicates that your machine is ready for the next command.

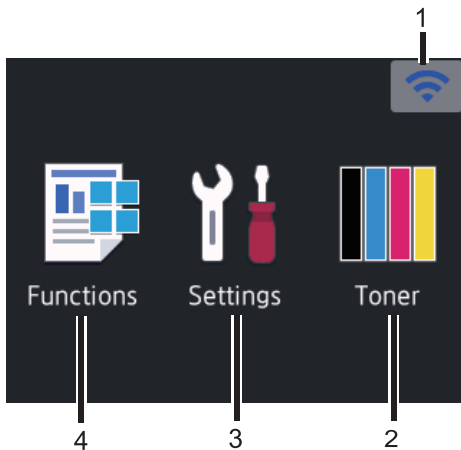

1. (Wireless Status)

If you are using a wireless connection, a four-level indicator in the Home screen displays the current wireless signal strength.



- If you see  at the top on the screen, press to select a wireless connection method, or edit an existing wireless connection.

2. [Toner]

Displays the remaining toner life. Press to access the [Toner] menu.

3. [Settings]

Press to access the [Settings] menu.

Use the Settings menu to access all of your Brother machine's settings.

If Setting Lock has been turned on, a lock icon  appears on the LCD. You must unlock the machine to change any settings.

4. [Functions]

Press to access the Functions screen.

-  [Secure Print]

Press to access the Secure Print option.

-  [Web]

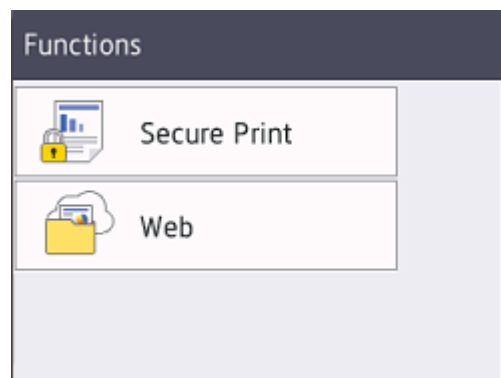

Press to connect the Brother machine to an Internet service.

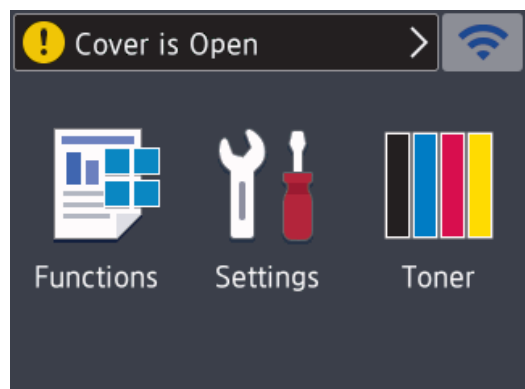

Warning icon



The warning icon  appears when there is an error or maintenance message; press

 to view it, and then press  to return to Ready Mode.

NOTE

This product adopts the font of ARPHIC TECHNOLOGY CO.,LTD.

2

Load Paper

Load Paper in the Paper Tray

Use the paper tray when printing on the following media:

Plain paper
Thin paper
Recycled paper
Thick paper

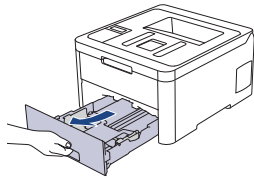

- Adjust the guides
- Fan the paper
- Do not exceed this mark

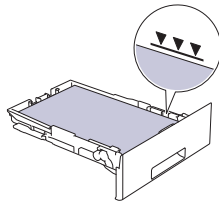

For more detailed information, see the *Online User's Guide: Load Paper in the Paper Tray*.

Load Paper in the Manual Feed Slot

Use the Manual Feed Slot when printing on the following media:

Plain paper
Thin paper
Recycled paper
Bond paper
Thick paper
Labels ¹
Envelopes ¹
Glossy paper

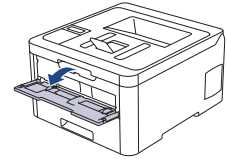

- Adjust the guides
- Use both hands to insert one sheet of paper
- Continue pressing the paper against the rollers for about two seconds, or until the machine grabs the paper and pulls it in further

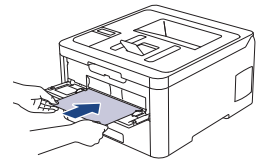

¹ Open the back cover (face up output tray) before printing to let the printed paper exit onto the face up output tray.

For more detailed information, see the *Online User's Guide: Load and Print Paper in the Manual Feed Slot*.





Use this section to resolve problems you may encounter when using your Brother machine.

Identify the Problem

Even if there seems to be a problem with your machine, you can correct most problems yourself.

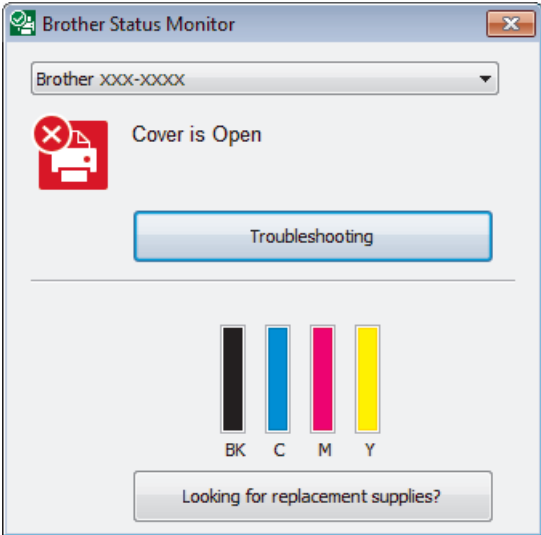
First, check the following:

- The machine's power cord is connected correctly and the machine's power is on.
- All of the machine's orange protective parts have been removed.
- (For network models) The access point (for wireless network), router, or hub is turned on and its link indicator is blinking.
- Paper is inserted correctly in the paper tray.
- The interface cables are securely connected to the machine and the computer.
- Check the machine's status on your machine or in **Brother Status Monitor** on your computer.

Find the Error	Find the Solution
<p>Using the Status Monitor</p> <ul style="list-style-type: none"> • Double-click the  icon in the task tray.  <ul style="list-style-type: none"> • (Windows®) If you select the Load Status Monitor on Startup check box, the Status Monitor will launch automatically each time you start your computer. 	<ul style="list-style-type: none"> • A green icon indicates the normal stand-by condition. <ul style="list-style-type: none">  • A yellow icon indicates a warning. <ul style="list-style-type: none">  • A red icon indicates an error has occurred. <ul style="list-style-type: none">  • A grey icon indicates the machine is offline. <ul style="list-style-type: none">  • Click the Troubleshooting button to access Brother's troubleshooting website.

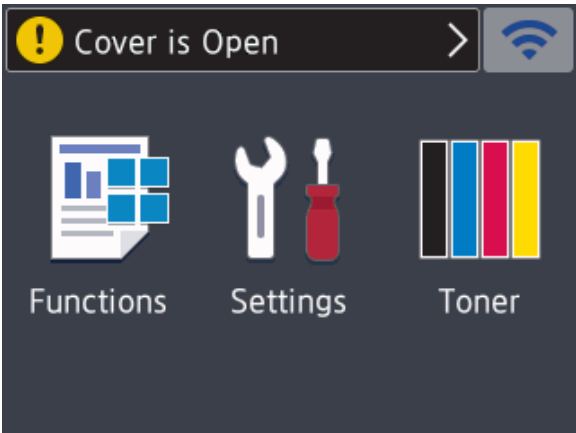
Find the Error	Find the Solution
<p>Using the LCD</p> <div data-bbox="120 208 436 262" style="border: 1px solid black; padding: 2px;">Cover is Open</div> 	<ol style="list-style-type: none"> 1. Follow the messages on the LCD. 2. If you cannot resolve the error, refer to the following: <i>Online User's Guide: Error and Maintenance Messages</i> FAQs & Troubleshooting page at support.brother.com

Error and Maintenance Messages

For information on the most common error and maintenance messages, see the *Online User's Guide*.

To view the *Online User's Guide* and other available guides, visit support.brother.com/manuals.

Paper Jams

An error message indicates where the paper is stuck in your machine.

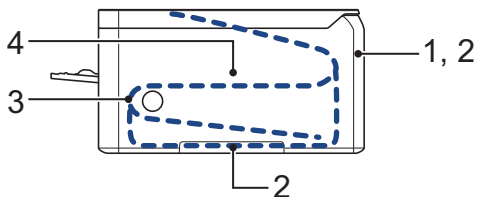

Error messages:

1. Jam Rear
2. Jam 2-sided
3. Jam Tray
4. Jam Inside

See the messages in **Brother Status Monitor** on your computer.

Solutions for Wireless Connection

If you cannot connect your Brother machine to the wireless network, see the following:

- *Online User's Guide: Print the WLAN Report*
- *Quick Setup Guide: Alternative wireless setup*

To view the *Online User's Guide* and other available guides, visit support.brother.com/manuals.

Supplies

When the time comes to replace supplies, such as the toner or drum, an error message will appear on your machine's control panel or in the Status Monitor. For more information about the supplies for your machine, visit www.brother.com/original/index.html or contact your local Brother dealer.

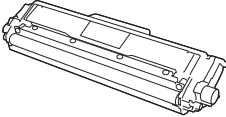
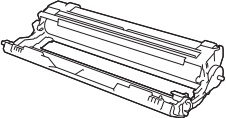
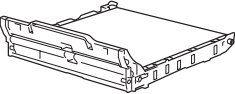

The Supply Model Name will vary depending on your country and region.

For Australia		
Supply Items	Supply Model Name	Approximate Life (Page Yield)
Toner Cartridge 	Standard Toner: TN-253	<ul style="list-style-type: none"> Black: Approximately 2,500 pages ^{1 2} Cyan / Magenta / Yellow: Approximately 1,300 pages ^{1 2}
	High Yield Toner: <ul style="list-style-type: none"> Cyan / Magenta / Yellow: TN-257 	<ul style="list-style-type: none"> Cyan / Magenta / Yellow: Approximately 2,300 pages ^{1 2}
	Inbox Toner: (Supplied with your machine)	<ul style="list-style-type: none"> Black: Approximately 1,000 pages ^{1 2} Cyan / Magenta / Yellow: Approximately 1,000 pages ^{1 2}
Drum Unit 	DR-253CL ³ DR-253CL-BK ⁴ DR-253CL-CMY ⁵	Approximately 18,000 pages ⁶
Belt Unit 	BU-223CL	Approximately 50,000 pages ⁷

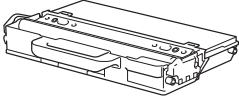
For Australia		
Supply Items	Supply Model Name	Approximate Life (Page Yield)
Waste Toner Box 	WT-223CL	Approximately 50,000 pages ²

- 1 Approximate cartridge yield is declared in accordance with ISO/IEC 19798.
- 2 A4 or Letter size single-sided pages
- 3 Contains four drum units; one black and three colours.
- 4 Contains one black drum unit.
- 5 Contains one colour drum unit.
- 6 Approximately 18,000 pages based on one page per job [A4/Letter single-sided pages]. The number of pages may be affected due to a variety of factors including but not limited to media type and media size.
- 7 Approximately 50,000 pages based on two pages per job [A4/Letter single-sided pages]. The number of pages may be affected due to a variety of factors including but not limited to media type and media size.

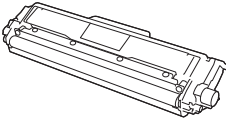
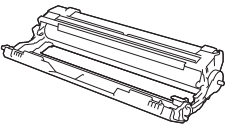
For New Zealand		
Supply Items	Supply Model Name	Approximate Life (Page Yield)
Toner Cartridge 	Standard Toner: TN-233	<ul style="list-style-type: none"> • Black: Approximately 1,400 pages^{1 2} • Cyan / Magenta / Yellow: Approximately 1,300 pages^{1 2}
	High Yield Toner: TN-237	<ul style="list-style-type: none"> • Black: Approximately 3,000 pages^{1 2} • Cyan / Magenta / Yellow: Approximately 2,300 pages^{1 2}
	Inbox Toner: (Supplied with your machine)	<ul style="list-style-type: none"> • Black: Approximately 1,000 pages^{1 2} • Cyan / Magenta / Yellow: Approximately 1,000 pages^{1 2}
Drum Unit 	DR-233CL ³ DR-233CL-BK ⁴ DR-233CL-CMY ⁵	Approximately 18,000 pages ⁶

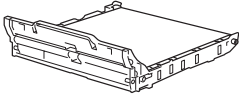
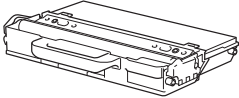
For New Zealand		
Supply Items	Supply Model Name	Approximate Life (Page Yield)
Belt Unit 	BU-223CL	Approximately 50,000 pages ⁷
Waste Toner Box 	WT-223CL	Approximately 50,000 pages ²

1 Approximate cartridge yield is declared in accordance with ISO/IEC 19798.

2 A4 or Letter size single-sided pages

3 Contains four drum units; one black and three colours.

4 Contains one black drum unit.

5 Contains one colour drum unit.

6 Approximately 18,000 pages based on one page per job [A4/Letter single-sided pages]. The number of pages may be affected due to a variety of factors including but not limited to media type and media size.

7 Approximately 50,000 pages based on two pages per job [A4/Letter single-sided pages]. The number of pages may be affected due to a variety of factors including but not limited to media type and media size.

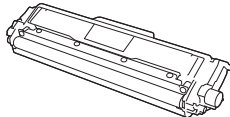
For Middle Eastern and African countries		
Supply Items	Supply Model Name	Approximate Life (Page Yield)
Toner Cartridge 	Standard Toner: TN-273	<ul style="list-style-type: none"> • Black: Approximately 1,400 pages^{1 2} • Cyan / Magenta / Yellow: Approximately 1,300 pages^{1 2}
	High Yield Toner: TN-277	<ul style="list-style-type: none"> • Black: Approximately 3,000 pages^{1 2} • Cyan / Magenta / Yellow: Approximately 2,300 pages^{1 2}
	Inbox Toner: (Supplied with your machine)	<ul style="list-style-type: none"> • Black: Approximately 1,000 pages^{1 2} • Cyan / Magenta / Yellow: Approximately 1,000 pages^{1 2}
Drum Unit	DR-273CL ³	Approximately 18,000 pages ⁶

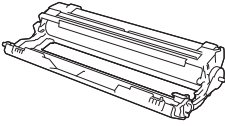
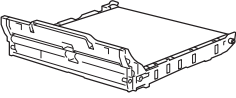
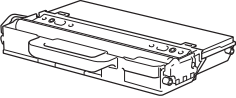
For Middle Eastern and African countries		
Supply Items	Supply Model Name	Approximate Life (Page Yield)
	DR-273CL-BK ⁴ DR-273CL-CMY ⁵	
Belt Unit 	BU-223CL	Approximately 50,000 pages ⁷
Waste Toner Box 	WT-223CL	Approximately 50,000 pages ²

- 1 Approximate cartridge yield is declared in accordance with ISO/IEC 19798.
- 2 A4 or Letter size single-sided pages
- 3 Contains four drum units; one black and three colours.
- 4 Contains one black drum unit.
- 5 Contains one colour drum unit.
- 6 Approximately 18,000 pages based on one page per job [A4/Letter single-sided pages]. The number of pages may be affected due to a variety of factors including but not limited to media type and media size.
- 7 Approximately 50,000 pages based on two pages per job [A4/Letter single-sided pages]. The number of pages may be affected due to a variety of factors including but not limited to media type and media size.

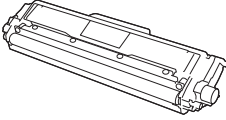
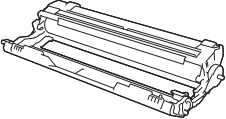
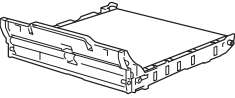
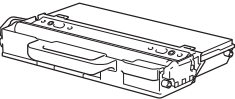
For Asian countries		
Supply Items	Supply Model Name	Approximate Life (Page Yield)
Toner Cartridge 	Standard Toner: TN-263	<ul style="list-style-type: none"> Black: Approximately 1,400 pages^{1 2} Cyan / Magenta / Yellow: Approximately 1,300 pages^{1 2}
	High Yield Toner: TN-267	<ul style="list-style-type: none"> Black: Approximately 3,000 pages^{1 2} Cyan / Magenta / Yellow: Approximately 2,300 pages^{1 2}
	Inbox Toner: (Supplied with your machine)	<ul style="list-style-type: none"> Black: Approximately 1,000 pages^{1 2} Cyan / Magenta / Yellow: Approximately 1,000 pages^{1 2}
Drum Unit 	DR-263CL ³ DR-263CL-BK ⁴ DR-263CL-CMY ⁵	Approximately 18,000 pages ⁶
Belt Unit 	BU-223CL	Approximately 50,000 pages ⁷
Waste Toner Box 	WT-223CL	Approximately 50,000 pages ²

¹ Approximate cartridge yield is declared in accordance with ISO/IEC 19798.

² A4 or Letter size single-sided pages

³ Contains four drum units; one black and three colours.

⁴ Contains one black drum unit.

⁵ Contains one colour drum unit.

⁶ Approximately 18,000 pages based on one page per job [A4/Letter single-sided pages]. The number of pages may be affected due to a variety of factors including but not limited to media type and media size.

7 Approximately 50,000 pages based on two pages per job [A4/Letter single-sided pages]. The number of pages may be affected due to a variety of factors including but not limited to media type and media size.



If you are using Windows[®], double-click the **Brother Creative Center** icon  on your desktop to access our **FREE** website designed as a resource to help you easily create and print customised materials for business and home use with photos, text and creativity.

Mac users can access Brother CreativeCenter at this web address:

www.brother.com/creativecenter

For Australia Only:

Support – For technical support of your Brother Product other than what you can resolve through the User's Guide, please visit our website or Solutions website (see below) to find an answer to FAQs/Troubleshooting, locating Drivers & Software.

Alternatively, please contact the Product Support Centre for any customer care/technical support enquiry.

To contact Brother International (Aust) Pty Ltd for support on a Brother product please see the details listed below:

Product Support Centre:

Australia

Brother International

(Aust) Pty Ltd

Phone: 02 8875 6000

Solutions Site: support.brother.com

Website: <http://www.brother.com.au>

Email: To submit an e-mail enquiry, visit <http://www.brother.com.au> go to Service and Support area and follow the prompts.

Our Technical Support Consultants are available 5 days a week by phone during the hours of 8.30am to 5.00pm (EST/EDST) Monday to Friday.

For New Zealand Only:

For technical support for your Brother Product please refer to this user guide and the FAQ's available on our Brother Solutions website, support.brother.com.

Drivers, software, user guides and technical references are all available on our Brother Solutions website.

If you require further assistance please contact Brother International (NZ) Limited on the following numbers

Technical Brother Support	0800 329 111
Technical Support for those not using Genuine Consumables	0900 552 152
Fax Assistance	0800 837 822

Our Technical Support Consultants are available 7 days a week by phone during the hours of 8.30am to 5pm Monday to Friday and 9am to 5pm Saturday and Sunday.

Email Assistance

Please visit <http://www.brother.co.nz> and submit a helpdesk enquiry from our Service and Support page.

Web Assistance

Please visit <http://www.brother.co.nz> under Service and Support for Frequently Asked Questions, Driver downloads, Warranty information and Service Centres.

brother

Visit us on the World Wide Web
www.brother.com

These machines are approved for use in the country of purchase only. Local Brother companies or their dealers will support only machines purchased in their own countries.



OCE/ASA/SAF/GLF/TWN
Version 0