

- Not all models are available in all countries.
- Unless otherwise specified, illustrations in this guide show the ADS-1700W.

The latest manuals and FAQs are available at the Brother Solutions Center: support.brother.com

Please read the **Product Safety Guide**, located later in this document before you set up your machine.

⚠ WARNING	WARNING indicates a potentially hazardous situation which, if not avoided, could result in death or serious injuries.
------------------	--

1 Unpack the machine and check the components

The components included in the box may differ depending on your country.

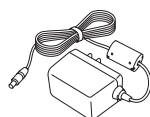
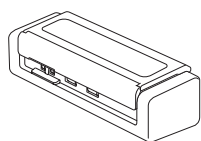

AC Adapter

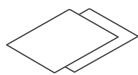

Warranty Card

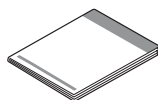

Quick Setup Guide/Product Safety Guide



Micro USB 3.0 Cable



Installation Disc

⚠ WARNING

- This product is packaged in a plastic bag. To avoid suffocation, keep plastic bags away from babies and children. The bag is not a toy.
- Use only the AC adapter supplied with this product.

NOTE

- We recommend saving the original packaging in case you must ship your machine.
- To establish a local connection to a computer, use a micro USB 2.0 or micro USB 3.0 cable.
- See the *Online User's Guide* for more details.
- Use of a micro USB 3.0 cable to scan in Bus Power Mode is recommended (ADS-1200).

Secure Network Access

Your machine's default password is on the label on the bottom of the scanner (preceded by "Pwd"). We strongly recommend you change it to protect your machine from unauthorised access.

2 Prepare your machine

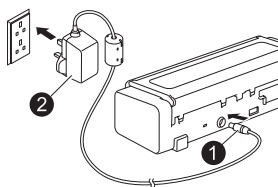

Connect the AC adapter (Example for Singapore).

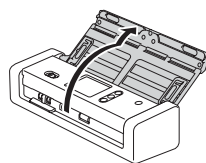

Open the Top Cover.

NOTE

Before loading documents into the Automatic Document Feeder (ADF), fan the paper and stagger the pages as shown in the illustration on the machine's Top Cover.

3 Configure your machine (ADS-1700W only)

- Select language
Press (Settings) > Initial Setup > Local Language.
- Set Date & Time
Press (Settings) > Initial Setup > Date & Time.

4 Connect your machine and install software

Select your preferred scanning method.

If you are using the ADS-1200, network connections are not supported.

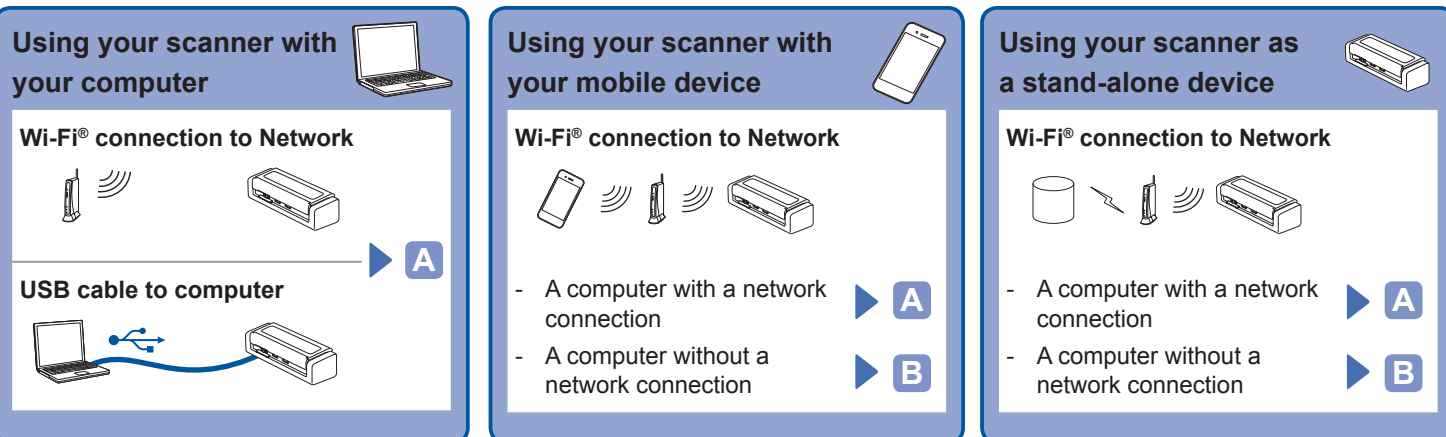

A Using your scanner with your computer

Mac and Windows computers



Download the full driver and software package from the Brother Solutions Center.
For Windows: support.brother.com/windows
For Mac: support.brother.com/mac
Double-click the downloaded file to begin the installation, and then follow the on-screen instructions.

When finished, restart your computer.

To scan using your computer, install the software supplied with your scanner. See the *Online User's Guide* for more details.

Finish

B Using your scanner with your mobile device or as a stand-alone device (Wi-Fi® connection to network (ADS-1700W only))

1. WiFi > Setup Wizard > Yes.
2. Select the SSID. Enter the Network key.
3. The LCD displays Connected.

If using your scanner with your mobile device





Download and install our free mobile app **Brother iPrint&Scan** from the App Store or Google Play™ using your mobile device.

Finish

If using your scanner as a stand-alone device

Finish

NOTE

- If you cannot find the SSID or network key, ask your network administrator or wireless access point/router manufacturer.
- If you cannot connect to the network:
 1. Confirm the WLAN settings.
 2. Enable WLAN: Press  (Settings), Network, WLAN, WLAN Enable and then On.
-  **Brother SupportCenter** is a mobile app that provides the latest support information for your Brother product. Visit the App Store or Google Play™ to download and install it on your mobile device.

Symbols and conventions used in this guide

The following symbols and conventions are used throughout this guide:

WARNING

WARNING indicates a potentially hazardous situation which, if not avoided, could result in death or serious injuries.

CAUTION







CAUTION indicates a potentially hazardous situation which, if not avoided, may result in minor or moderate injuries.

IMPORTANT

IMPORTANT indicates a potentially hazardous situation which, if not avoided, may result in damage to property or loss of product functionality.

NOTE

NOTE tells you how you should respond to a situation that may arise or give tips about other scanning features.

-  Prohibition icons indicate actions that must not be performed.
-  This icon indicates that flammable sprays may not be used.
-  This icon indicates that organic solvents, such as alcohol or other liquids, may not be used.
-  Electrical Hazard icons alert you to possible electrical shocks.
-  Fire Hazard icons alert you to the possibility of fire.
-  Unplug icons indicate that you should unplug the machine.

ADS-1700W only
Courier New

Text in Courier New font identifies messages on the LCD of the machine.

Follow all warnings and instructions marked on the machine and AC adapter (from now on collectively referred to as "the unit").

NOTE

The illustrations in this guide show the ADS-1700W.

Compilation and Publication Notice

This manual has been compiled and published to provide the latest product safety information at the time of publication. The information contained in this manual may be subject to change.

For the latest manual, please visit us at support.brother.com/manuals

Choose a safe location for the unit

Put the unit on a flat, stable surface that is free from shocks and vibrations, such as a desk. Choose a dry, well-ventilated location where the temperature remains between 5°C and 35°C and the humidity is between 20% to 80% (without condensation).

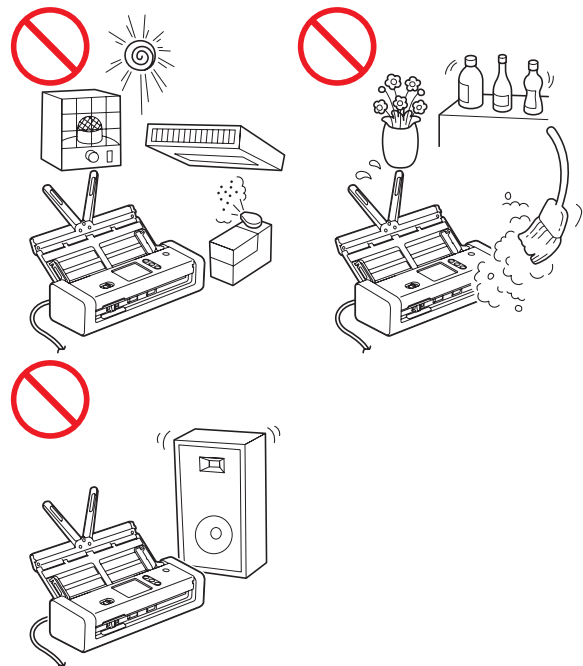

WARNING



DO NOT expose the unit to direct sunlight, excessive heat, open flames, corrosive gasses, moisture or dust. DO NOT place the unit on a carpet or rug, as this will expose it to dust. Doing so may create a risk of an electrical short or fire. It may also damage the unit and/or render it inoperable.



DO NOT place the unit near radiators, heaters, air conditioners, water, chemicals or devices that contain magnets or generate magnetic fields. Doing so may create the risk of a short circuit or fire should water come into contact with the unit (including condensation from heating, air conditioning, and/or ventilation equipment that may be sufficient to create a short circuit or fire).



DO NOT place the unit near chemicals or in a place where chemical spillage could occur. In particular, organic solvents or liquids may cause the casing and/or cables to melt or dissolve, risking a fire or electrical shock. They may also cause the unit to malfunction or become discoloured.



Slots and openings in the casing, back or bottom of the product are provided for ventilation. The product should be placed so as not to come into contact with any wall or other device so these openings are not blocked or covered. Blocking the unit's ventilation could create a risk of overheating and/or fire.

IMPORTANT

- Always place the unit on a solid surface, never on a bed, sofa, rug, or similar soft surfaces.
- DO NOT place the unit in a "built-in" installation.

CAUTION

Avoid placing the unit in a high-traffic area. If you must place it in a high-traffic area, ensure that the unit is in a safe location where it cannot be accidentally knocked over, which could cause injury to you or others and serious damage to the unit.

Ensure that cables and cords leading to the unit are secured so as not to pose a tripping hazard.

Make sure that no part of the unit protrudes from the desk or stand where the unit is located. Make sure that the unit is located on a flat, level, and stable surface free from vibration. Failure to observe these precautions could cause the unit to fall, causing an injury.

DO NOT place the unit on an unstable or tilted cart, stand, or table, or on any tilted/slanted surface. The machine may fall, causing injury to you and serious damage to the unit. There is an added risk of injury if the scanner glass should break.

IMPORTANT

- DO NOT put objects on top of the unit.
- DO NOT place the unit next to sources of interference, such as speakers or the base units of non-Brother cordless telephones. Doing so may interfere with the operation of the unit's electronic components.

General precautions

WARNING

Plastic bags are used in the packaging of the unit. To avoid danger of suffocation, keep these plastic bags away from babies and children. Plastic bags are not toys.



Never insert any objects into the slots in the machine's casing, since they may touch dangerous voltage points or short out parts resulting in the risk of fire or electrical shock. If metal objects, water or other liquids get inside the machine, immediately unplug the unit from the electrical socket. Contact your Brother dealer or Brother customer service.



DO NOT use flammable substances, any type of spray, or an organic solvent/liquid that contains alcohol or ammonia to clean the inside or outside of the unit. Doing this may cause a fire or electrical shock.



DO NOT disassemble or modify the unit, otherwise a fire or electric shock may occur. If the unit requires repair, contact your Brother dealer or Brother customer service.



DO NOT use a damaged AC adapter.



DO NOT place heavy objects on, damage, or modify the AC adapter. Do not forcibly bend or pull the cord.



DO NOT drop, hit, or otherwise damage the AC adapter.

Product Safety Guide



DO NOT touch the unit during a thunderstorm. There may be a remote risk of electrical shock from lightning when the machine is used during a thunderstorm.



DO NOT use the unit near any liquids, for example, near a bath tub, wash bowl, kitchen sink or washing machine, in a wet basement or near a swimming pool.

CAUTION

DO NOT put pressure or weight on the unit or use it for any purpose beyond its intended purpose.

Wait until the machine ejects the pages to avoid trapping your fingers in the rollers.

Some areas of the machine can cause injury if covers (shaded) are closed with force. Take care when placing your hand in the areas shown in the illustrations.

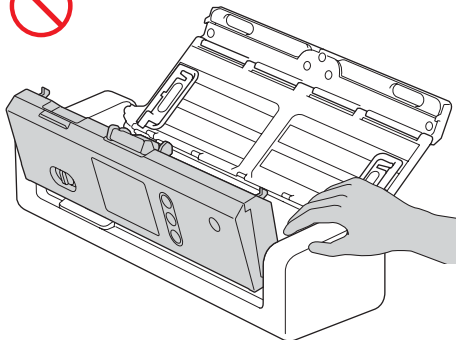

DO NOT carry the machine by holding the Top Cover. Doing this may cause the machine to slip out of your hands. Only carry the machine by placing your hands under the entire machine.

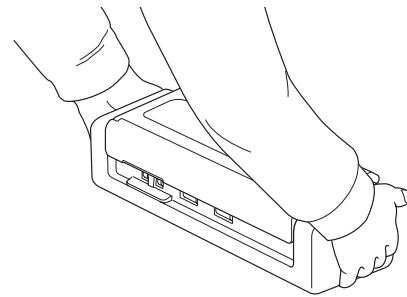
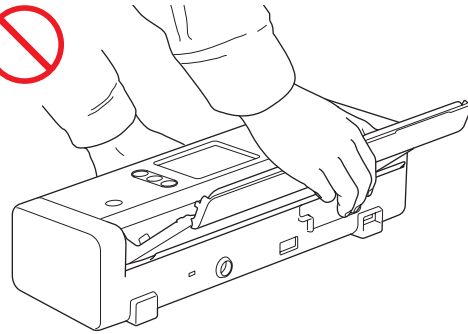

Use caution when operating the machine to prevent clothing (particularly sleeves, neckties, etc.), hair, or accessories from being drawn into the machine, otherwise an injury may occur. In the event that an object is drawn into the machine, immediately disconnect the unit from the power source.

DO NOT swing the AC adapter around or play with it. Doing so may result in injury to yourself or others.

IMPORTANT

(ADS-1700W only)

DO NOT touch the touchscreen immediately after plugging in the AC adapter or turning the machine on. Doing this may cause an error.

Connecting the unit safely

WARNING



There are high-voltage electrodes inside the unit. Before you access the inside of the machine, (for routine maintenance, such as cleaning), make sure you have unplugged the AC adapter from the electrical socket from the machine.

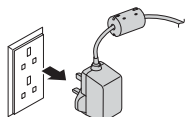

(Example for Singapore)



DO NOT touch the AC adapter with wet hands. Doing this might cause an electrical shock.

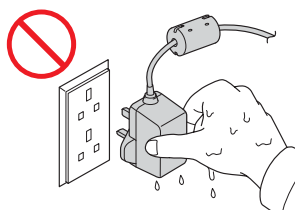

(Example for Singapore)



DO NOT connect it to a DC power source or inverter. Doing this may cause an electrical shock. If you are not sure what kind of power source you have, contact a qualified electrician.



DO NOT use the unit if the power cord is frayed or damaged, doing so may cause an electrical shock or fire.



DO NOT pull on the middle of the power cord. DO NOT allow anything to rest on the power cord. DO NOT place the unit where people can walk on the cord. Doing this may cause an electrical shock or fire.



Brother strongly recommends that you DO NOT use any type of extension cord. Failure to observe these precautions could cause a fire, electrical shock, or damage to the unit.



When disconnecting the AC adapter from the machine or from the electrical socket, always hold the connector, not the cable, and pull firmly. Failure to do so may result in exposed or broken power cord wires, fire, or electrical shock.



Make sure that the AC adapter is firmly plugged into a standard electrical socket. Do not use an electrical socket that is loose. If the AC adapter is not completely plugged into the power socket, there is a danger of the adapter becoming hot and catching fire.



Always use the supplied AC adapter, and plug the adapter into a power socket within the voltage range indicated in *Specifications* in the *Online User's Guide*. Failure to do so may result in an injury to yourself or others, or damage to the machine or other property. Brother does not assume any responsibility for any accident or damage resulting from not using the supplied AC adapter.



DO NOT connect the supplied AC adapter to other products.



DO NOT overload the AC adapter.

CAUTION

If you do not intend to use the unit for an extended period of time, disconnect the AC adapter from the electrical socket.

Servicing the unit

DO NOT attempt to service the unit yourself. Opening or removing covers may expose you to dangerous voltages and other risks, and may void your warranty. Contact your Brother dealer or Brother customer service.

WARNING



If the unit has been dropped or the casing has been damaged, there may be the possibility of an electrical shock or fire. Unplug the unit from the electrical socket and contact your Brother dealer or Brother customer service.



If the unit becomes unusually hot, releases smoke, generates any strong smells, or if you accidentally spill any liquid on it, immediately unplug the unit from the electrical socket. Contact your Brother dealer or Brother customer service.

IMPORTANT

If the machine does not operate normally when the operating instructions are followed, adjust only those controls that are covered by the operating instructions. Incorrect adjustment of other controls may result in damage, and will often require extensive work by a qualified technician to restore the unit to normal operation.

Important Information for Australia

Important safety instructions

1. Read all of these instructions.
 2. Save them for later reference.
 3. Follow all warnings and instructions marked on the machine.
 4. Unplug this machine from the wall socket before cleaning the outside of the machine. Do not use liquid or aerosol cleaners. Use a damp cloth for cleaning.
 5. Do not use this machine near water.
 6. Do not place this machine on an unstable cart, stand, or table. The machine may fall, causing serious damage to the machine.
7. Slots and openings in the cabinet and the back or bottom are provided for ventilation; to ensure reliable operation of the machine and to protect it from overheating, these openings must not be blocked or covered. The openings should never be blocked by placing the machine on a bed, sofa, rug, or other similar surface. This machine should never be placed near or over a radiator or heater. This machine should never be placed in a built-in installation unless adequate ventilation is provided.
 8. This machine should be connected to an AC power source within the range indicated on *Specifications* in the *Online User's Guide*. Do not connect it to a DC power source. If you are not sure, contact a qualified electrician.
 9. Do not place anything on top of the power cord including this machine. Do not allow the power cord to be stepped on.
 10. Do not place anything in front of the machine that will block scanned documents. Do not place anything in the path of documents.
 11. Do not touch a document during scanning.
 12. Never push objects of any kind into this machine through cabinet slots, since they may touch dangerous voltage points or short out parts resulting in a risk of fire or electric shock. Never spill liquid of any kind on the machine.
 13. Do not attempt to service this machine yourself. Opening or removing covers may expose you to dangerous voltage points and/or other risks. Refer all servicing to service personnel.
 14. Do not try and pick up pages that have not yet finished scanning and exited the machine.
 15. Unplug this machine from the electrical socket and refer servicing to Authorized Service Personnel under the following conditions:
 - When the power cord is damaged or frayed.
 - If liquid has been spilled into the machine.
 - If the machine has been exposed to rain or water.
 - If the machine does not operate normally when the operating instructions are followed. Adjust only those controls that are covered by the operating instructions. Improper adjustment of other controls may result in damage and will often require extensive work by a qualified technician to restore the machine to normal operation.
 - If the machine has been dropped or the cabinet has been damaged.
 - If the machine exhibits a distinct change in performance, indicating a need for service.

Product Warranty & Liability

Nothing in this guide shall affect any existing product warranty or be construed as granting any additional product warranty. Failure to follow the safety instructions in this guide may invalidate your product's warranty.

WARNING

Use only the AC adapter supplied with this machine.

This product must be installed near an electrical socket that is easily accessible. In case of an emergency, you must unplug the AC adapter from the electrical socket to shut off the power completely.

For Singapore

Complies with
IMDA Standards
DB02405

Complies with
IMDA Standards
DB02405

For Thailand

This telecommunication equipment conforms to NTC technical requirement.

Trademarks

BROTHER is either a trademark or a registered trademark of Brother Industries, Ltd.

Android and Google Play are trademarks of Google Inc.

Apple, App Store, Mac, macOS and Safari are trademarks of Apple Inc., registered in the United States and other countries.

Nuance, the Nuance logo, Power PDF and PaperPort are trademarks or registered trademarks of Nuance Communications, Inc. or its affiliates in the United States and/or other countries.

WPA, WPA2, Wi-Fi Protected Access and Wi-Fi Protected Setup are marks of the Wi-Fi Alliance.

Wi-Fi, Wi-Fi Alliance and Wi-Fi Direct are registered marks of the Wi-Fi Alliance.

Intel is a trademark of Intel Corporation in the U.S. and/or other countries.

Each company whose software title is mentioned in this manual has a Software License Agreement specific to its proprietary programs.

Any trade names and product names of companies appearing on Brother products, related documents and any other materials are all trademarks or registered trademarks of those respective companies.

Compilation and Publication

Under the supervision of Brother Industries, Ltd., this manual has been compiled and published, covering the latest product descriptions and specifications.

The contents of this manual and the specifications of this product are subject to change without notice.

Brother reserves the right to make changes without notice in the specifications and materials contained herein and shall not be responsible for any damages (including consequential) caused by reliance on the materials presented, including but not limited to typographical and other errors relating to the publication.

Copyright and License

© 2019 Brother Industries, Ltd. All rights reserved.

Open Source Licensing Remarks

This product includes open-source software. Please visit the Brother Solutions Center at support.brother.com to see the open source licensing remarks.

Brother customer service

Customer service

Visit www.brother.com for contact information for your local Brother office.

Service centre locations

Visit www.brother.com for contact information for your local Brother office.

Unlawful use of scanning equipment

It is an offence to make reproductions of certain items or documents with the intent to commit fraud. The following is a non-exhaustive list of documents which it may be unlawful to produce copies of. We suggest you check with your legal adviser and/or the relevant legal authorities if in doubt about a particular item or document:

- Currency
- Bonds or other certificates of debt
- Certificates of deposit
- Armed forces service or draft papers
- Passports
- Postage stamps (cancelled or uncanceled)
- Immigration papers
- Welfare documents
- Cheques or drafts drawn by governmental agencies
- Identifying badges or insignias

Copyrighted works cannot be copied lawfully, subject to the "fair dealing" exception relating to sections of a copyrighted work. Multiple copies would indicate improper use. Works of art should be considered the equivalent of copyrighted works.

For Australia Only:

Support – For technical support of your Brother Product other than what you can resolve through the User's Guide, please visit our Web Site or Solutions Web Site (see below) to find an answer to FAQs/ Troubleshooting, locating Drivers & Software.

Alternatively, please contact the Product Support Centre for any customer care/technical support enquiry.

To contact Brother International (Aust) Pty Ltd for support on a Brother product please see the details listed below:

Product Support Centre: **Australia**

Brother International (Aust) Pty Ltd

Phone: 02 8875 6000

Fax: 02 9870 7223

Solutions Site: support.brother.com

Web Site: www.brother.com.au

Email: To submit an e-mail enquiry, visit www.brother.com.au go to **Service and Support** area and follow the prompts.

Our Technical Support Consultants are available 5 days a week by phone during the hours of 8.30 am to 5.00 pm (EST/EDST) Monday to Friday.

brother

Visit us on the World Wide Web
www.brother.com



www.brotherearth.com



D011DA001②