

Product Safety Guide

HL-L9430CDN / HL-L9470CDN / MFC-L9630CDN / MFC-L9670CDN

Read this guide before attempting to operate the product, or before attempting any maintenance, and ensure that you follow all warnings and instructions marked on the product. If you have concerns about how to use your product safely after reading this guide, contact Brother customer service or your local Brother dealer. Failure to follow these instructions may result in an increased risk of personal injury or damage to property, including through fire, electrical shock, burns or suffocation. Brother shall not be liable for the damage caused where the product owner has failed to follow the instructions set out in this guide or on the product.

For more advanced instructions, information, and product specifications, see the *Online User's Guide* at support.brother.com/manuals.

Symbols and Conventions Used in the Documentation

WARNING

WARNING indicates a potentially hazardous situation which, if not avoided, could result in death or serious injuries.

CAUTION

CAUTION indicates a potentially hazardous situation which, if not avoided, may result in minor or moderate injuries.

IMPORTANT

IMPORTANT indicates a potentially hazardous situation which, if not avoided, may result in damage to property or loss of product functionality.

NOTE

NOTE specifies the operating environment, conditions for installation, or special conditions of use.



Electrical Hazard icons alert you to possible electrical shock.



Fire Hazard icons alert you to the possibility of a fire.



Hot Surface icons warn you not to touch product parts that are hot.



Prohibition icons indicate actions that must not be performed.

Compilation and Publication Notice

The definitions of font style are as follows:

Bold	Bold typeface identifies specific keys on the product's control panel or on the computer screen.
<i>Italics</i>	Italicised style emphasises an important point or refers you to a related topic.
Courier New	Text in Courier New font identifies messages on the LCD of the product.

Not all models are available in all countries.

The illustrations in this guide show the HL-L9430CDN/MFC-L9630CDN.

This product's manuals have been compiled and published to provide the latest product safety information at the time of publication. The information contained in these manuals may be subject to change.

For the latest manuals, visit us at support.brother.com.

©2021 Brother Industries, Ltd. All rights reserved.

Choose a Safe Location for Your Product

WARNING



Choose a location where the temperature remains between 10°C and 32.5°C, the humidity is between 20% and 80%, and where there is no condensation.



DO NOT place the product near heaters, air conditioners, electrical fans, refrigerators, or water. Doing so may create the risk of an electrical shock, short circuit, or fire, as water may come into contact with the product (including condensation caused by heating/air conditioning/ventilation equipment).



DO NOT expose the product to direct sunlight, excessive heat, open flames, corrosive gasses, moisture, or dust. Doing so may create a risk of an electrical shock, short circuit, or fire, causing damage to the product and/or rendering it inoperable.



DO NOT place the product near chemicals or in a place where chemicals could be spilled on it. Should chemicals come into contact with the product, there may be a risk of fire or electrical shock. In particular, organic solvents or liquids such as benzene, paint thinner, polish remover, or deodoriser may melt or dissolve the plastic cover and/or cables, resulting in a risk of fire or electrical shock. These or other chemicals may cause the product to malfunction or become discoloured.



DO NOT put the product in a location that blocks or obstructs any slot or opening in the product. These slots and openings are provided for ventilation. Blocking the machine's ventilation could create a risk of overheating and/or fire.

Instead:

- Keep a minimum gap around the product as shown in the illustration.

Products without the scanning function

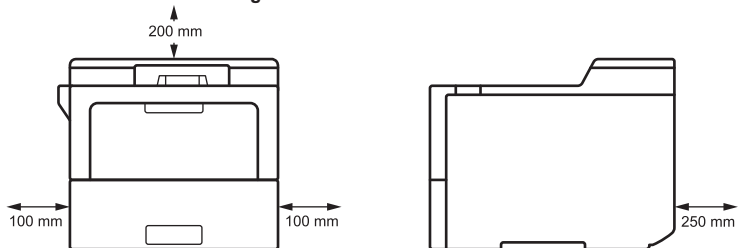

Products with the scanning function

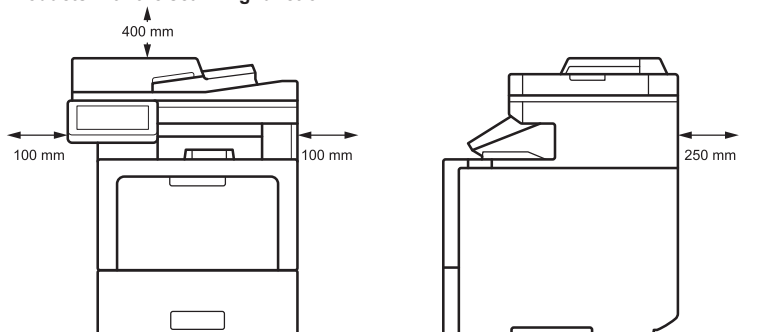

- Place the product on a solid level surface.
- DO NOT place this product near or over a radiator or heater.
- DO NOT place this product in any installation unless adequate ventilation is provided.

CAUTION

Put your product on a flat, level, stable surface (such as a desk), that is free from vibration and shocks. Put the product near a telephone socket (models with the fax function only) and a standard earthed electrical socket.

DO NOT place this product on an unstable cart, stand, or table, particularly if children are expected to be near the product. The product is heavy and may fall, causing injury to you or others and serious damage to the product. For the products with scanning functionality, there is an added risk of injury if the scanner glass should break.

Avoid placing your product in a busy area. If you must place it in a busy area, ensure that the product is in a safe location where it cannot be accidentally knocked over, which could cause injury to you or others and serious damage to the product.

Ensure that cables and cords leading to the product are secured so as not to pose a tripping hazard.

DO NOT place heavy objects on the product.

DO NOT place any objects around the product. Such objects block the access to the electrical socket in case of emergency. It is important that the product can be unplugged whenever needed.

This product emits some chemical substances during printing, and additionally if used for prolonged periods or in poorly ventilated areas may cause the emission of odorous gases such as ozone. Place the product in a well-ventilated area for optimum performance and comfort.

IMPORTANT

- DO NOT place your product next to devices that contain magnets or generate magnetic fields. Doing so may interfere with the operation of the product, causing print quality problems.
 - DO NOT place your product next to sources of interference, such as speakers or the base units of non-Brother cordless telephones. Doing so may interfere with the operation of the product's electronic components.
-

Connect the Product Safely

WARNING



ELECTRICAL HAZARDS

Failure to follow the warnings in this section may create the risk of an electrical shock. In addition, you could create an electrical short, which may create the risk of a fire.



There are high-voltage electrodes inside the product. Before you access the inside of the product, including for routine maintenance such as cleaning, make sure you have unplugged the telephone line cord first (models with the fax function only) and then the power cord from the electrical socket, as well as any telephone/RJ-11 (models with the fax function only) or Ethernet/RJ-45 cables (network models only) from the product.

DO NOT push objects of any kind into this product through slots or openings in the product, as they may touch dangerous voltage points or short-out parts.

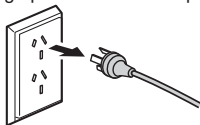

(Example for Australia and New Zealand)



DO NOT handle the plug with wet hands. Doing this might cause an electrical shock.



(Example for Australia and New Zealand)



Always make sure the plug is fully inserted. DO NOT use the product or handle the cord if the cord has become worn or frayed.



Unplug the power plug regularly to clean it. Use a dry cloth to clean the root of the plug blades and between the blades. If the power plug is plugged into the socket over a long period, dust accumulates around the plug blades, which may cause a short circuit, resulting in a fire.



DO NOT dismantle this product. Dismantling this product could cause a fire or electrical shock.

DO NOT attempt to service this product yourself. Opening or removing covers may expose you to dangerous voltage points and other risks and may void your warranty. Refer all servicing to Brother customer service or your local Brother dealer.



DO NOT drop any metal objects or any type of liquid on the power plug of the product. It may cause an electrical shock or a fire.



If water, other liquids, or metal objects get inside the product, immediately unplug the product from the electrical socket and contact Brother customer service or your local Brother dealer.



This product should be connected to an AC power source within the range indicated on the rating label on your machine. DO NOT connect it to a DC power source or inverter. If you are not sure what kind of power source you have, contact a qualified electrician.

Use the Product Safely

WARNING

ELECTRICAL HAZARDS

Failure to follow the warnings in this section may create the risk of an electrical shock. In addition, you could cause an electrical short, which may lead to a fire.



If the product has been dropped or the casing has been damaged, there may be the possibility of an electrical shock. Unplug the product from the electrical socket and contact Brother customer service or your local Brother dealer.



DO NOT use this product during a thunderstorm. There may be a remote risk of an electrical shock from lightning.

FIRE HAZARDS

Failure to follow the warnings in this section may create the risk of a fire.



DO NOT use flammable substances, any type of spray, or an organic solvent/liquid containing alcohol or ammonia to clean the inside or outside of the product. Doing so could cause a fire. Instead, use only a dry, lint-free cloth. For instructions on how to clean the product, see the *Online User's Guide*.

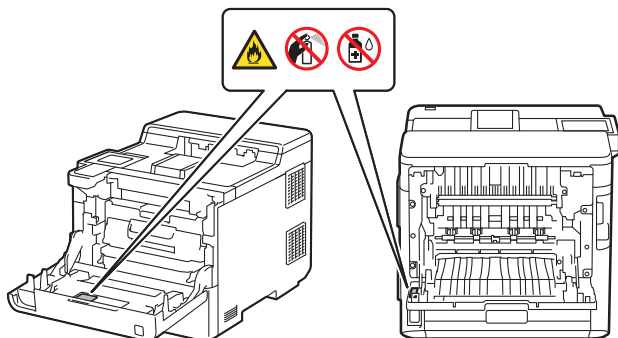

DO NOT attempt to operate this product when a paper jam or stray pieces of paper are inside the product. Prolonged contact of paper with the fuser unit could cause a fire.



DO NOT use a vacuum cleaner to clean up scattered toner. Doing this might cause the toner dust to ignite inside the vacuum cleaner, potentially starting a fire. Carefully clean the toner dust with a dry, lint-free soft cloth, and dispose of it according to local regulations.

(Models with the Wireless LAN function only)

DO NOT use the product near any medical electrical equipment. The radio waves emitted from the product may affect medical electrical equipment and cause a malfunction, which may result in accident or injury.

For users with pacemakers:

(Models with the Wireless LAN function only)

This product generates a weak magnetic field. If you feel anything wrong with the operation of your pacemaker when near the product, move away from the product and consult a doctor immediately.



DO NOT place metal objects, such as clips, staples, or jewellery on the product. If these objects contact the electrical parts inside the product, it may cause a fire or electrical shock.



DO NOT place a container holding water or liquid on the product. The water or liquid in the container may spill into the product making contact with the electrical parts inside the product, which may cause a fire or electrical shock.

HOT SURFACE

Immediately after using the product, some internal parts of the product will be extremely hot. Wait at least 10 minutes for the product to cool down before you touch the internal parts of the product.

HL-L9430CDN/MFC-L9630CDN:

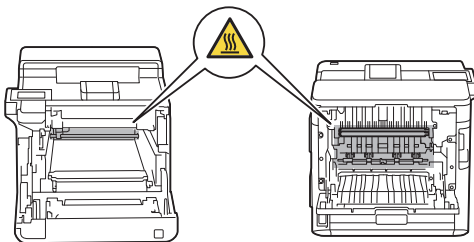

HL-L9470CDN/MFC-L9670CDN:

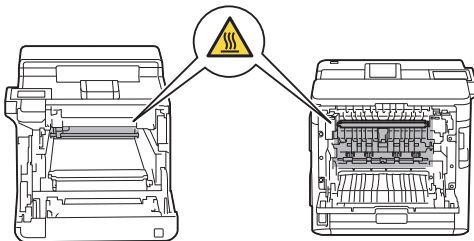

If the product becomes unusually hot, releases smoke, generates any strong smells, or if you accidentally spill any liquid on it, immediately unplug the product from the electrical socket. Contact Brother customer service or your local Brother dealer.

Plastic bags are used in the packing of this product. Plastic bags are not toys. To avoid the danger of suffocation, keep these bags away from babies and children, and dispose of them correctly.



(Models with the fax function only)

Use caution when installing or modifying telephone lines. Never touch telephone wires or terminals that are not insulated unless the telephone line has been unplugged from the wall socket.

Never install telephone wiring during a thunderstorm. Never install a telephone wall socket in a location that is wet or may become wet, for example, near a refrigerator or other appliance that produces condensation.



Power Cord Safety:

- This product is equipped with an earthed plug. This plug will only fit into an earthed electrical socket. This is a safety feature. If you are unable to insert the plug into the socket, ask your electrician to replace your obsolete socket. **DO NOT** attempt to defeat the purpose of the earthed plug.
- **DO NOT** allow anything to rest on the power cord.
- **DO NOT** place this product where others might step on the cord.
- **DO NOT** place this product in a position where the cord is stretched or strained, as it may become worn or frayed.
- **DO NOT** use the product or handle the cord if the cord has become worn or frayed. If unplugging your product, **DO NOT** touch the damaged/frayed part.
- **DO NOT** pull on the middle of the AC power cord; pulling on the middle may cause the cord to separate from the plug. Doing this might cause an electrical shock.
- **DO NOT** use any undesignated cables (or optional devices). Doing so may cause a fire or injuries. Installation must be performed correctly according to the *Quick Setup Guide*.
- Brother strongly recommends that you **DO NOT** use any type of extension cord.
- This product should be positioned so that nothing pinches or constricts the power cord.
- **DO NOT** use cables that do not meet the cable specifications described in the *Online User's Guide: Specifications*. Doing so may cause a fire or injuries.
- If the power cord is provided with this product, use **ONLY** the provided cord. Installation must be performed correctly as described in the *Quick Setup Guide*.

CAUTION

When you move the product, carry the product as shown in the illustration.

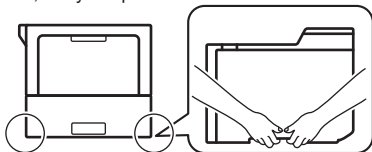

To prevent possible injuries, at least two people should lift the product by holding it from the front and back.



DO NOT carry the product by holding the areas shown in the illustrations. Doing this may cause the product to slip out of your hands and may result in injury.

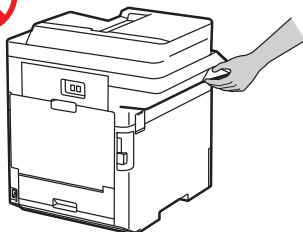
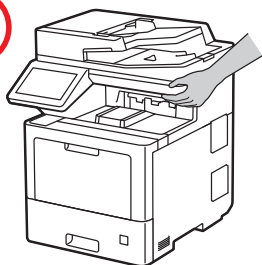

If you use a Lower Tray/optional output tray, DO NOT carry the product with the Lower Tray/optional output tray as you may be injured or cause damage to the product because it is not attached to the Lower Tray/optional output tray.

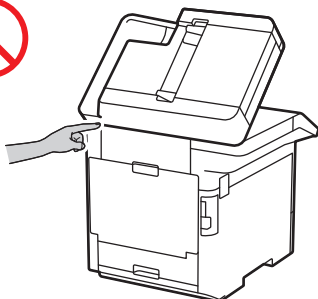

MFC-L9630CDN/MFC-L9670CDN

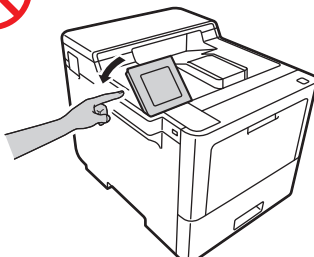

HL-L9430CDN/HL-L9470CDN

For your safety, unplug the product from the electrical socket when it is not used for a long time.

When multiple devices, including this product, are connected to a computer using USB cables, you may feel an electric charge when you touch metal parts of the product.

Some products and/or their cartons contain a silica gel pack. DO NOT eat the silica gel pack; throw it away. If you ingest it, seek medical attention immediately.

DO NOT attempt to dismantle the toner cartridge. If toner dust should leak out, avoid inhaling it or letting it come in contact with your skin.

Keep toner cartridges out of the reach of children. If toner powder is swallowed, consult a doctor immediately.

We recommend placing the toner cartridge and drum unit assembly on a clean, flat surface with disposable paper underneath it in case you accidentally spill or scatter toner. If toner scatters on your hands or clothes, immediately wipe it off or wash it with cold water.

Should you come into contact with toner, follow these instructions:

- Inhalation

Obtain immediate medical attention. In case of accidental inhalation, move to fresh air immediately, then obtain medical attention.

- Skin contact

Remove contaminated clothing immediately and wash affected skin with plenty of water or soap and water.

- Eye contact

Obtain medical attention. If the toner has got into the eyes, immediately wash out the eyes with water continuously, for at least 15 minutes.

- Ingestion

Obtain immediate medical attention. Wash out mouth with water and drink 200 - 300 ml (one cup) of water.

DO NOT run your hand over the edge of the paper. The thin and sharp edges of the paper may cause an injury.

This machine contains electronic components that emit electromagnetic radiation during the printing operation. To avoid the possibility of electromagnetic radiation exposure to your body, maintain a distance of 7.87 inches (20 cm) from both sides of the machine when printing.

DO NOT remove or damage any of the caution or warning labels inside the product.

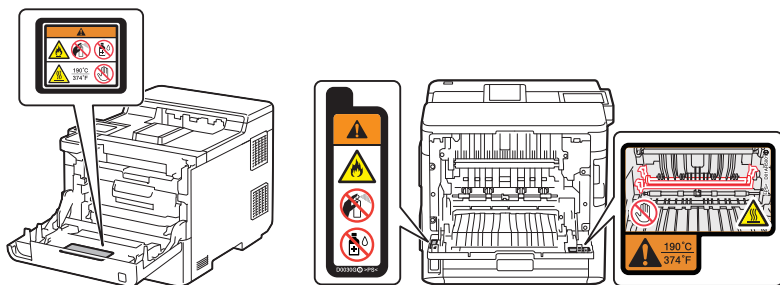

IMPORTANT

- A distinct change in the product's performance may indicate a need for service.
- DO NOT connect your product to an electrical socket controlled by wall switches or automatic timers, or to the same circuit as a large appliance or other equipment that requires a significant amount of electricity. It could disrupt the power supply. Disruption of the power supply may also delete information from the product's memory, and repeated cycling of the power supply can damage the product.
- We recommend that you use our genuine toner cartridges to replace cartridges that come with the device. Non-genuine toner cartridges may cause damage to the machine. They may also result in differences in the colours or storage stability. (Not all non-genuine toner cartridges cause these issues.)
- DO NOT put any objects on top of the product. Doing so may cause the product to malfunction.
- If the product does not operate normally when the operating instructions are followed, adjust only those controls that are covered by the operating instructions. Incorrect adjustment of other controls may result in damage and will often require extensive work by a qualified technician to restore the product to normal operation.
- DO NOT touch the shaded parts shown in the illustrations. Doing so may cause damage to the machine.

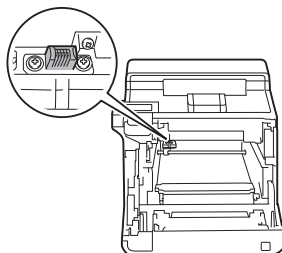

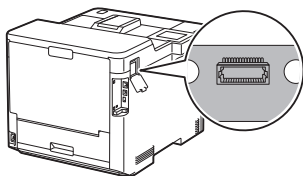

Important Information for Australia

IMPORTANT-For Your Safety

To ensure safe operation the three-pin plug supplied must be inserted only into a standard three-pin power point which is effectively grounded through the normal household wiring.

The fact that the equipment operates satisfactorily does not imply that the power is grounded and that the installation is completely safe. For your safety, if in any doubt about the effective grounding of the power, consult a qualified electrician.

Important Safety Instructions

1. This product is equipped with a grounded plug, a plug having a third (grounded) pin. This plug will only fit into a grounded power outlet. This is a safety feature. If you are unable to insert the plug into the outlet, call your electrician to replace your obsolete outlet. **DO NOT** defeat the purpose of the grounded plug.
2. **DO NOT** place anything on top of the power cord including this product. **DO NOT** allow the power cord to be stepped on.
3. **DO NOT** touch a document during printing.
4. Never push objects of any kind into this product through cabinet slots, since they may touch dangerous voltage points or short out parts resulting in a risk of fire or electric shock. Never spill liquid of any kind on the product.
5. Unplug this product from the wall outlet and refer servicing to Authorised Service Personnel under the following conditions:
 - When the power cord is damaged or frayed.
 - If liquid has been spilled into the product.
 - If the product has been exposed to rain or water.
 - If the product does not operate normally when the operating instructions are followed. Adjust only those controls that are covered by the operating instructions. Incorrect adjustment of other controls may result in damage and will often require extensive work by a qualified technician to restore the product to normal operation.
 - If the product has been dropped or the casing has been damaged.
 - If the product exhibits a distinct change in performance, indicating a need for service.

Important Information for New Zealand

IMPORTANT-For Your Safety

To ensure safe operation the three-pin plug supplied must be inserted only into a standard three-pin power point which is effectively grounded through the normal household wiring.

The fact that the equipment operates satisfactorily does not imply that the power is grounded and that the installation is completely safe. For your safety, if in any doubt about the effective grounding of the power, consult a qualified electrician.

Important Safety Instructions

1. This product is equipped with an earthed plug. This plug will fit into only an earthed socket. This is a safety feature. If you are unable to insert the plug into the outlet, contact your electrician to replace your obsolete socket. DO NOT defeat the purpose of an earthed plug.
2. DO NOT place anything on top of the power cord including this product. DO NOT allow the power cord to be stepped on.
3. DO NOT touch a document during printing.
4. Never push objects of any kind into this product through cabinet slots, since they may touch dangerous voltage points or short out parts resulting in a risk of fire or electric shock. Never spill liquid of any kind on the product.
5. Unplug this product from the mains power and telephone line sockets (Models with FAX function only), and refer servicing to qualified Service Personnel under the following conditions:
 - If the power cord is damaged or frayed.
 - If liquid has been spilled into the product.
 - If the product has been exposed to rain or water.
 - If the product does not operate normally when the operating instructions are followed. Adjust only those controls that are covered by the operating instructions. Incorrect adjustment of other controls may result in damage and will often require extensive work by a qualified technician to restore the product to normal operation.
 - If the product has been dropped or the casing has been damaged.
 - If the product exhibits a distinct change in performance, indicating a need for service.

Models with FAX function only

1. The grant of a Telepermit for any item of terminal equipment indicates only that Telecom has accepted that the item complies with minimum conditions for connection to its network. It indicates no endorsement of the product by Telecom, nor does it provide any sort of warranty. Above all, it provides no assurance that any item will work correctly in all respects with another item of Telepermitted equipment of a different make or model, nor does it imply that any product is compatible with all of Telecom's network services.
2. This equipment is not capable, under all operating conditions, of correct operation at the higher speeds for which it is designed. Telecom will accept no responsibility should difficulties arise in such circumstances.

3. This equipment does not fully meet Telecom's impedance requirements. Performance limitations may occur when used in conjunction with some parts of the network. Telecom will accept no responsibility should difficulties arise in such circumstances.
4. This equipment shall not be set up to make automatic calls to the Telecom '111' Emergency Service.
5. This unit will only work in conjunction with a tone signalling (DTMF) telephone, but some telephones may not be compatible. Since noise or speech from the telephone can upset dialling from this unit, errors may result if the devices are used together in other than quiet conditions.
6. Where it is necessary to dial prefix digits, such as a Caller Display override code ("0196" or "0197"), this unit will have to be used in conjunction with an associated tone signalling (DTMF) telephone.
7. Note that some telephones are NOT compatible with this unit and dialling errors may result if the two devices are used together in other than quiet conditions. The Telecom Faults Service is NOT to be called should such problems arise. In such cases, it is recommended that the prefix and wanted number are dialled manually.
8. If a charge for local calls is unacceptable, the 'Dial' button should NOT be used for local calls. Only the seven-digits of the local number should be dialled from your telephone. DO NOT dial the area code digit or the '0' prefix.
9. This equipment may not provide for the effective hand-over of a call to another device connected to the same line.
10. Some parameters required for compliance with Telecom's Telepermit requirements are dependent on the equipment (PC) associated with this device. The associated equipment shall be set to operate within the following limits for compliance with Telecom's Specifications: (a) There shall be no more than 10 call attempts to the same number within any 30 minute period for any single manual call initiation, and (b) The equipment shall go on-hook for a period of not less than 30 seconds between the end of one attempt and the beginning of the next call attempt.
11. Some parameters required for compliance with Telecom's Telepermit requirements are dependent on the equipment (PC) associated with this device. The associated equipment shall be set to operate within the following limits for compliance with Telecom's Specifications: Automatic calls to different numbers are spaced such that there is no less than five seconds between the end of one call attempt and the beginning of another.
12. This equipment should not be used under any circumstances which may constitute a nuisance to other Telecom customers.
13. Some parameters required for compliance with Telecom's Telepermit requirements are dependent on the equipment (PC) associated with this device. The associated equipment shall be set to operate within the following limits for compliance with Telecom's Specifications: Equipment shall be set to ensure that calls are answered between three and 30 seconds of receipt of ringing.
14. In the event of any problem with this device, it is to be disconnected, and a CPE item connected to one of its terminal ports may be connected directly in its place. The user should then arrange for the product to be repaired. Should the matter be reported to Telecom as a wiring fault, and the fault is proven to be due to this product, a call-out charge will be incurred by the customer.
15. Many CPE devices have features such as 'last number redial' or 'memory dial' which depend on a small on-hook line current for the maintenance of memory information. Such terminal devices used with the series connected device may lose their memory functions.

16. Telepermitted equipment only may be connected to the EXT telephone port. This port is not specifically designed for three-wire-connected equipment. Three-wire-connected equipment might not respond to incoming ringing when attached to this port.

IMPORTANT NOTICE (Models with FAX function only)

Under power failure conditions, this telephone may not operate. Please ensure that a separate telephone, not dependent on local power, is available for emergency use in emergencies.

Important Information for Some Countries

Important Safety Instructions

1. This product is equipped with a grounding type plug, a plug having two or three pins. This plug will fit into only a grounding-type power outlet. This is a safety feature. If you are unable to insert the plug into the outlet, contact your electrician to replace your obsolete outlet. DO NOT defeat the purpose of the grounding-type plug.
2. DO NOT place anything on top of the power cord including this product. DO NOT allow the power cord to be stepped on.
3. DO NOT touch a document during printing.
4. Never push objects of any kind into this product through cabinet slots, since they may touch dangerous voltage points or short out parts resulting in the risk of fire or electric shock. Never spill liquid of any kind on the product.
5. Unplug this product from the wall outlet and refer servicing to Authorized Service Personnel under the following conditions:
 - If the power cord is damaged or frayed.
 - If the product has been spilled by liquid.
 - If the product has been exposed to rain or water.
 - If the product does not operate normally when the operating instructions are followed. Adjust only those controls that are covered by the operating instructions. Incorrect adjustment of other controls may result in damage and will often require extensive work by a qualified technician to restore the product to normal operation.
 - If the product has been dropped or the casing has been damaged.
 - If the product exhibits a distinct change in performance, indicating a need for service.
6. For Singapore only
We DO NOT recommend using ethylated spirits to clean or contact with the product.

WARNING



For protection against the risk of electrical shock, always disconnect all cables from the wall outlet before servicing, modifying or installing the equipment.

IMPORTANT

- This equipment may not be used on coin service lines provided by the telephone company or connected to party lines. (Models with FAX function only)
- Brother cannot accept any financial or other responsibilities that may be the result of your use of this information, including direct, special, or consequential damages. There are no warranties extended or granted by this document.

Product Warranty & Liability

Nothing in this guide shall affect any existing product warranty or be construed as granting any additional product warranty. Failure to follow the safety instructions in this guide may invalidate your product's warranty.

WARNING



Only use the power cord supplied with this product (if included in the box).

Disconnect device



This product must be installed near an electrical socket that is easily accessible. In case of an emergency, you must unplug the power cord from the electrical socket to shut off the power completely.

Declaration of Conformity (Europe Only)

We, Brother Industries, Ltd.

15-1, Naeshiro-cho, Mizuho-ku, Nagoya 467-8561 Japan

declare that this product is in conformity with the relevant EU harmonization legislation (Europe only) and UK legislation (Great Britain only).

The Declaration of Conformity (DoC) can be downloaded from our website. Visit support.brother.com/manuals.

WARNING

This is a class A product. In a domestic environment this product may cause radio interference in which case the user may be required to take adequate measures.

EU Declaration of Conformity for RE Directive 2014/53/EU (Europe Only) (Applicable to Models with Radio Interfaces)

We, Brother Industries, Ltd.

15-1, Naeshiro-cho, Mizuho-ku, Nagoya 467-8561 Japan

declare that these products are in conformity with the provisions of the RE Directive 2014/53/EU. A copy of the Declaration of Conformity can be downloaded by following the instructions in the Declaration of Conformity (Europe Only) section.

IEC60825-1:2014 Specification (For 220 V - 240 V Models Only)

This product is a Class 1 laser product as defined in IEC60825-1:2014 specifications. The label shown below is attached in countries where required.

This product has a Class 3B Laser Diode which emits invisible laser radiation in the Laser Unit. The Laser Unit should not be opened under any circumstances.



Internal Laser radiation

Wave length: 770 nm - 800 nm

Output: 25 mW max.

Laser Class: Class 3B

WARNING

Use of controls, adjustments or performance of procedures other than those specified in this manual may result in hazardous radiation exposure.

Wireless LAN (Models with the Wireless LAN Function Only)

This Printer/Multifunction Printer supports Wireless LAN.

Frequency band(s): 2400 MHz - 2483.5 MHz

Maximum radio-frequency power transmitted in the frequency band(s): Less than 20 dBm (e.i.r.p)

Frequency band(s): 5150 MHz - 5350 MHz

Maximum radio-frequency power transmitted in the frequency band(s): less than 23 dBm (e.i.r.p)

For indoor use only (5.15 GHz - 5.35 GHz)

Frequency band(s): 5470 MHz - 5725 MHz

Maximum radio-frequency power transmitted in the frequency band(s): less than 30 dBm (e.i.r.p)

NFC (Models with the NFC Function Only)

This Printer/Multifunction Printer supports NFC (Near Field Communication).

- Frequency band(s): 13.553 MHz - 13.567 MHz

Maximum radio-frequency power transmitted in the frequency band(s): Less than 111.5 dBuV/m at 10 m

LAN Connection (Models with the Wired LAN Function Only)

CAUTION

DO NOT connect this product to a LAN connection that is subject to over-voltages.

For WLAN models (Taiwan only)

Caution!

Administrative Regulations on Low Power Radio Waves Radiated Devices

Article 12: Unless granted permission by Taiwan DGT, any company, enterprise or user is not allowed to change the frequency, enhance the transmitting power or alter the original design characteristics or operating functions of an approved low-power radio frequency device.

Article 14: Low-power radio frequency devices shall not influence aircraft security or interfere with legal communications. If such interference occurs, the low-power radio frequency device must immediately cease operations and may not be resumed until the interference problem has been resolved. The above-mentioned "legal communications" is defined as radio communication operations that conform to the Telecommunications Act. Low-power radio-frequency devices must accept any interference received from legal communications, and Industrial, Scientific and Medical (ISM) radio wave devices.

Avoid affecting the operation of nearby radar systems.

Compliance Statement of Wireless equipment (Thailand only)

This telecommunication equipment conforms to the standard or technical requirements of NBTC.

เครื่องวิทยุคมนาคมนี้มีระดับการแผ่คลื่นแม่เหล็กไฟฟ้าสอดคล้องตาม มาตรฐานความปลอดภัยต่อสุขภาพของมนุษย์จากการใช้เครื่องวิทยุคมนาคมที่คณะกรรมการกิจการ โทรคมนาคมแห่งชาติประกาศกำหนด

Recycling information in accordance with the India E-Waste (Management) Rules (India only)



India only

This product is RoHS compliant and meets the requirements of the India E-Waste (Management) Rules. The above recycling symbol means that at the end of the life of the equipment, you must dispose of it separately at an appropriate collection point, and not place it in the normal domestic unsorted waste stream. This will benefit the environment for all. For detailed information, please refer to the following Brother India website: <https://www.brother.in/>

For inquiries on the collection program, please call Toll Free: 1800 222422 or 1800 2098904 (Between 9AM-5PM Mon-Sat).

Declaration of the Presence Condition of the Restricted Substances Marking (Taiwan Only)

We, Brother Industries, Ltd.

15-1 Naeshiro-cho, Mizuho-ku, Nagoya 467-8561 Japan

Disclaimer This product complies with the Taiwan RoHS Certification Practice.

The "Declaration of the Presence Condition of the Restricted Substances Marking" can be download form our website, Visit

support.brother.com/g/d/afm4/ and:

-> Select a product category

-> Select the product model.

The "Declaration of the Presence Condition of the Restricted Substances Marking" will be downloaded as a PDF file.

Trademarks

Each company whose software title is mentioned in this manual has a Software Licence Agreement specific to its proprietary programs.

Any trade names and product names of companies appearing on Brother products, related documents and any other materials are all trademarks or registered trademarks of those respective companies.

Brother Customer Service

Customer Service

Visit www.brother.com for contact information for your local Brother office.

Service Centre Locations

For service centres in your country, contact your local Brother Office. Address and telephone contact information for local offices can be found at www.brother.com by selecting your region and country.

Unlawful Use of Copying or Scanning Equipment (Products with the scanning function only)

It is an offence to make reproductions of certain items or documents with the intent to commit fraud. The following is a non-exhaustive list of documents which it may be unlawful to produce copies of. We suggest you check with your legal adviser and/or the relevant legal authorities if in doubt about a particular item or document:

- Currency
- Bonds or other certificates of debt
- Certificates of deposit
- Armed forces service or draft papers
- Passports
- Postage stamps (cancelled or uncanceled)
- Immigration papers
- Welfare documents
- Cheques or drafts drawn by governmental agencies
- Identifying badges or insignias

In addition, driving licences and/or Certificates of Title to motor vehicles may not be copied or scanned under certain national laws.

Copyrighted works cannot be copied or scanned lawfully, subject to the “fair dealing” exception relating to sections of a copyrighted work. Multiple copies would indicate improper use. Works of art should be considered the equivalent of copyrighted works.

Disclaimer

Failure to follow these instructions may result in an increased risk of personal injury or damage to personal property, including through fire, electrical shock, burns, or suffocation.

Brother disclaims any warranties with respect to avoidance, mitigation or non-occurrence of any breakdowns, malfunctions, system crashes, hang-ups, virus infections, damage and

disappearances of data, and any other kind of errors by using this product. AS LONG AS PERMITTED BY APPLICABLE LAWS, BROTHER WILL NOT BE LIABLE FOR ANY LOST REVENUES OR INDIRECT, SPECIAL, INCIDENTAL, CONSEQUENTIAL, EXEMPLARY, OR PUNITIVE DAMAGES OF THE CUSTOMERS OR ANY OTHER THIRD PARTY.

brother

These machines are approved for use in the country of purchase only. Local Brother companies or their dealers will support only machines purchased in their own countries.

Month of publication: 02/2022



D01WGT001-00
OCE/ASA/SAF/GLF/TWN
Version 0