

Product Safety Guide

**HL-L5210DN/HL-L5210DW/HL-L5210DWT/HL-L5215DW/HL-L6210DW/HL-L6210DWT/HL-L6217DW/
HL-L6310DW/HL-L6415DW/HL-L6415DWT/HL-EX415DW/DCP-L5510DN/DCP-L5610DN/
DCP-L5660DN/MFC-L5710DN/MFC-L5710DW/MFC-L5715DW/MFC-L5717DW/MFC-L5915DW/
MFC-L6810DW/MFC-L6915DW/MFC-EX915DW**

IMPORTANT: Before setting up or operating this printer, please read this guide in its entirety.

For more detailed instructions, information, and product specifications, see the *Online User's Guide* at support.brother.com/manuals.

Symbols and Conventions Used in the Documentation

The following symbols and conventions are used throughout the documentation.

WARNING

WARNING indicates a potentially hazardous situation which, if not avoided, could result in death or serious injuries.

CAUTION

CAUTION indicates a potentially hazardous situation which, if not avoided, may result in minor or moderate injuries.

IMPORTANT

IMPORTANT indicates a potentially hazardous situation which, if not avoided, may result in damage to property or loss of product functionality.



Hot Surface icons warn you not to touch product parts that are hot.



Prohibition icons indicate actions that must not be performed.



Electrical Hazard icons alert you to the possibility of an electric shock.



Fire Hazard icons alert you to the possibility of a fire.



Explosion Hazard icons alert you to the possibility of an explosion.



This icon alerts you to the areas that contain moving parts.

Bold Bold typeface identifies specific keys on the product's control panel or on the computer screen.

Italics Italicized style emphasizes an important point or refers you to a related topic.

Courier New Text in Courier New font identifies messages on the LCD of the product.

Compilation and Publication Notice

Not all models are available in all countries.

In this guide, the illustrations of the following models are used unless otherwise specified:

HL-L6310DW/HL-L6415DW/MFC-L6810DW/MFC-L6915DW

Under the supervision of Brother Industries, Ltd., this product's manuals have been compiled and published, covering the latest product descriptions and specifications.

The contents of all manuals and the specifications of this product are subject to change without notice.

Brother shall not be liable for the damage caused where the product owner has failed to follow the instructions set out in this guide or on the product.

Brother reserves the right to make changes without notice in the specifications and materials contained herein and shall not be responsible for any damages (including consequential) caused by reliance on the materials presented, including but not limited to typographical and other errors relating to the publication.

These machines are approved for use in the country of purchase only. Local Brother companies or their dealers may only support machines purchased in their own countries.

©2022 Brother Industries, Ltd. All rights reserved.

Choose a Safe Location for Your Product

WARNING

- Choose a location where the temperature remains between 50°F and 90.5°F (10°C and 32.5°C), the humidity is between 20% and 80%, and where there is no condensation.

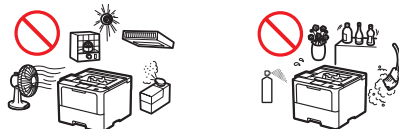

- DO NOT place the product near heaters, air conditioners, electrical fans, refrigerators, or water. DO NOT allow this product to come into contact with water. This product should not be used around standing water, including a bathtub, sink, or swimming pool; around appliances containing water, including a refrigerator; or in a wet basement.
- DO NOT expose the product to direct sunlight, excessive heat, open flames, corrosive gasses, moisture, or dust.
- DO NOT place the product near chemicals or in a place where chemicals could be spilled on it. In particular, organic solvents or liquids such as benzene, paint thinner, polish remover, or deodorizer may melt or dissolve the plastic cover and/or cables. These or other chemicals

may cause the product to malfunction or become discolored.



Do not install or use in areas where explosive or electrically conductive dusts are generated.



Do not obstruct any slots or openings to ensure efficient ventilation and reduce the risk of overheating or fire.



- Keep the following clearance around the product:
Products without the scanning function

Top: 5.9 in. (150 mm)

Rear: 5.9 in. (150 mm)

Sides: 5.9 in. (150 mm)

- Products with the scanning function**

Top: 11.8 in. (300 mm)

Rear: 5.9 in. (150 mm)

Sides: 5.9 in. (150 mm)

- DO NOT place this product near a radiator or heater.
- Make sure you install the product in a well-ventilated area.

Make sure you place this product on a stable and level surface free from vibration and shocks. The product is heavy and may fall, causing injury to you or others and serious damage to the product.

⚠ CAUTION

- Install the product near a telephone wall jack (models with the fax function only) and a standard grounded AC power outlet.
- Install the product in a safe location where it cannot be accidentally knocked over.
- Ensure that cables and cords are secured so as not to pose a tripping hazard.
- DO NOT place heavy objects on the product.
- DO NOT place any objects around the product that may block access to the power outlet. It is important that the product can be unplugged whenever needed.
- The product may generate odorous gas such as ozone if used for a large volume of printing or used in a poorly ventilated room for multiple hours. In addition, the product emits some chemical substances during the printing process. Ensure adequate ventilation for the product to avoid injury or discomfort.

IMPORTANT

- DO NOT place your product next to devices that contain magnets or generate magnetic fields. Doing so may interfere with the operation of the product, causing print quality problems.
- DO NOT place your product next to sources of interference, such as speakers or the base units of cordless telephones. Doing so may interfere with the operation of the product's electronic components.

Connect the Product Safely

⚠ WARNING



- There are high-voltage electrodes inside the product. Before cleaning or other routine maintenance of your product, disconnect the telephone line cord first, and then unplug the power cord and disconnect all other cables.
- Always make sure the plug is fully inserted. DO NOT use the product if the power cord has become worn or frayed.
- DO NOT drop any metal objects or any type of liquid on the product's power plug.

- Connect this product to an AC power source within the range shown on your machine's rating label. DO NOT connect it to a DC power source, inverter or UPS (uninterruptible power supply). If you are not sure what kind of power source you have, contact a qualified electrician.



DO NOT handle the plug with wet hands.



To prevent the accumulation of dust, unplug the power plug regularly to clean it. Use a dry cloth to clean the base of the plug blades/pins and between the blades/pins.

Use the Product Safely

⚠ WARNING



- Dismantling this product could cause a fire or electrical shock. If an individual with the knowledge, experience, and tools required to repair a product is self-servicing this product, please take precautionary measures to minimize the risks of these hazards.
- Opening or removing covers may expose you to dangerous voltage points and other risks and may void your warranty. We recommend to utilize a Brother Authorized Service Center for any repairs. If an individual with the knowledge, experience, and tools required to repair a product is self-servicing this product, please take precautionary measures to minimize the risks of these hazards.
- If the product has been dropped or the casing has been damaged, there may be the possibility of an electric shock. Unplug the product from the AC power outlet and contact Brother Authorized Service Personnel.
- If water, other liquids, or metal objects get inside the product, immediately unplug the product from the AC power outlet and contact Brother Authorized Service Personnel.
- If the product becomes unusually hot, releases smoke, or generates any strong smells, immediately unplug the product from the AC power outlet. Contact Brother Authorized Service Personnel.

Power Cord Safety



- This product is equipped with a grounded plug. This plug will only fit into a grounded power outlet. This is a safety feature. If you are unable to insert the plug into the outlet, call your electrician to replace your obsolete outlet.
- DO NOT allow anything to rest on the power cord.
- DO NOT place this product where others might step on the cord.
- DO NOT place this product in a position where the cord is stretched as it may become worn or frayed.
- DO NOT use the product if the power cord is frayed or damaged. Doing so may cause an electrical shock or fire.
- DO NOT pull on the middle of the power cord; pulling on the middle may cause the cord to separate from the plug.
- DO NOT use unsupported hardware. Cables must meet the cable specifications described in the *Specifications* chapter of the *Online User's Guide*.
- Brother strongly recommends that you DO NOT use any type of extension cord.
- If the power cord is provided with this product, use ONLY the provided cord. Installation must

be performed correctly as described in the *Quick Setup Guide*.



- DO NOT use or install this product during a thunderstorm.
- (Models with the fax function only)
Use caution when installing or modifying telephone lines. Never touch telephone wires or terminals that are not insulated unless the telephone line has been unplugged from the wall jack.
Never install a telephone wall jack in a location that is wet or may become wet.



- DO NOT attempt to operate this product when a paper jam or stray pieces of paper are inside the product. Prolonged contact of paper with the fuser unit could cause a fire.
- DO NOT use a vacuum cleaner to clean up scattered toner. Carefully clean the toner dust with a dry, lint-free soft cloth, and dispose of it according to local regulations.



Immediately after use, some internal parts of the product will be extremely hot. Wait at least 10 minutes for the product to cool down before you touch the internal parts.

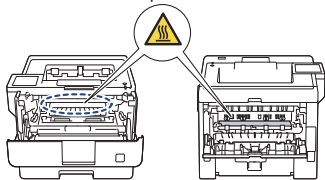

DO NOT use flammable substances, any type of spray, or an organic solvent/liquid containing alcohol or ammonia to clean the inside or outside of the product. Instead, use only a dry, lint-free cloth. For instructions on how to clean the product, see the *Online User's Guide*.



- (Models with the Wireless LAN function only)
DO NOT use the product near any medical electrical equipment. The radio waves emitted from the product may affect medical electrical equipment and cause a malfunction, which may result in accident or injury.
- For users with pacemakers: (Models with the Wireless LAN function only)
This product generates a weak magnetic field. If you feel anything wrong with the operation of your pacemaker when near the product, move away from the product and consult a doctor immediately.

- Plastic bags are used in the packing of this product. Plastic bags are not toys. To avoid the danger of suffocation, keep these bags away from babies and children, and dispose of them correctly.
- If you use a Lower Tray/optional output tray, DO NOT carry the product with the Lower Tray/optional output tray as you may be injured or cause damage to the product because it is not attached to the Lower Tray/optional output tray.
- When you move the product, carry the product as shown in the illustration.
HL-L5210DN/HL-L5210DW/HL-L5210DWT/HL-L5215DW/
HL-L6210DW/HL-L6210DWT/HL-L6217DW/
HL-L6310DW/HL-L6415DW/HL-L6415DWT/
HL-EX415DW:

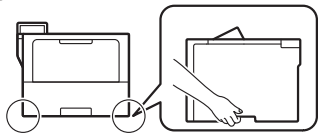

DCP-L5510DN/MFC-L5710DN/MFC-L5710DW/
MFC-L5715DW/MFC-L5717DW:

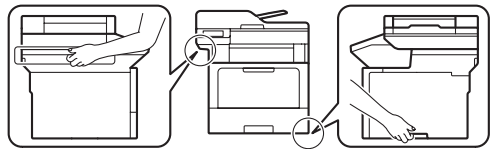

DCP-L5610DN/DCP-L5660DN/MFC-L5915DW/
MFC-L6810DW/MFC-L6915DW/MFC-EX915DW:

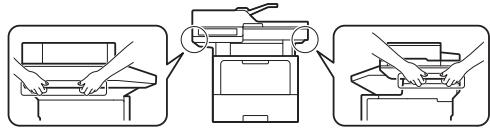

- (DCP-L5610DN/DCP-L5660DN/MFC-L5915DW/
MFC-L6810DW/MFC-L6915DW/MFC-EX915DW)
To prevent possible injuries, at least two people should lift the product by holding it from the front and back.

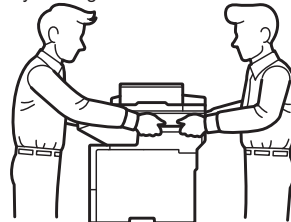

Keep toner cartridges out of the reach of children. If a child swallows the toner dust, consult a doctor immediately.

CAUTION

- DO NOT carry the product by holding the areas shown in the illustrations. Doing this may cause the product to slip out of your hands and may result in injury.



- To prevent injuries, keep your hands away from the areas shown in the illustrations.

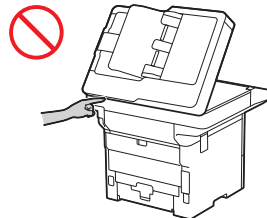

For your safety, unplug the product from the power outlet when not in use.

When multiple devices, including this product, are connected to a computer using USB cables, you may feel

an electric charge when you touch metal parts of the product.

Some products and/or their cartons contain a silica gel pack. DO NOT eat the silica gel pack; throw it away. If you ingest it, seek medical attention immediately.

We recommend placing the toner cartridge and drum unit assembly on a clean, flat surface with disposable paper underneath it in case you accidentally spill or scatter the toner.

Should you come into contact with toner, follow these instructions:

- Inhalation: Immediately move to fresh air and seek urgent medical attention.
- Skin contact: Remove contaminated clothing immediately and wash the affected skin with soap and cold water.
- Eye contact: Rinse your eyes with water continuously for at least 15 minutes and seek medical attention.
- Ingestion: Thoroughly rinse your mouth with water, drink 200-300 ml (one cup) of water, and seek medical attention.

DO NOT try to open a toner cartridge.

DO NOT run your hand over the edge of the paper. The thin and sharp edges of the paper may cause an injury.

This machine contains electronic components that emit electromagnetic radiation during the printing operation. To avoid the possibility of electromagnetic radiation exposure, maintain a distance of 7.87 inches (20 cm) from the machine when printing.

- DO NOT remove or damage any of the caution or warning labels inside the product.

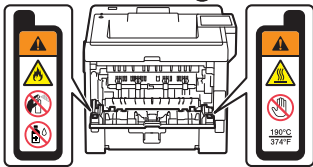
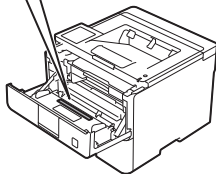

- Moving parts are located in the gray shaded areas shown in the illustration. Keep your hands away from those areas when the parts are moving, or else injury may result.

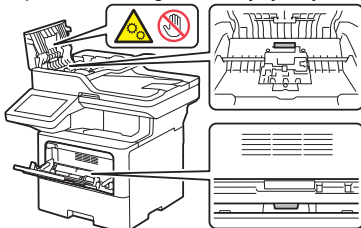

IMPORTANT

- A distinct change in the product's performance may indicate a need for service.
- DO NOT connect your product to an AC power outlet controlled by wall switches or automatic timers, or to the same circuit as a large appliance or other equipment that requires a significant amount of electricity. It could disrupt the power

supply. Disruption of the power supply may also delete information from the product's memory, and repeated cycling of the power supply can damage the product.

- DO NOT put any objects on top of the product. Doing so may cause the product to malfunction.
- DO NOT touch the shaded parts shown in the illustrations. Doing so may cause damage to the machine.

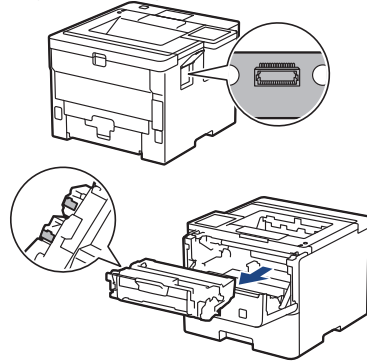

Important Safety Instructions

DO NOT attempt to service this product yourself because opening or removing covers may expose you to dangerous voltage points and other risks and may void your warranty. Refer all servicing to a Brother Authorized Service Center.

1. Read all of these instructions.
2. Save these instructions for later reference.
3. Follow all warnings and instructions marked on the product.
4. Unplug this product from the AC power outlet and refer servicing to Brother Authorized Personnel if any of the following occur:
 - If liquid has been spilled into the product.
 - If the product has been exposed to rain or water.
 - If the product does not operate normally when the operating instructions are followed. Adjust only those controls that are discussed in the operating instructions. Improper adjustment of other controls may result in damage and will often require extensive work by a qualified technician to restore the product to normal operation.
 - If the product exhibits a distinct change in performance, indicating a need for service.
5. For the location of your nearest Brother Authorized Service Center, contact:

In USA: 1-877-BROTHER (1-877-276-8437)

In Canada: www.brother.ca/support

Regulations

⚠ WARNING



- (Models with the fax function only)
When using your telephone equipment, basic safety precautions should always be followed to reduce the risk of fire, electrical shock, and injury to people. These important safety precautions include the following:
 1. DO NOT use this product near water or locations that may become wet, for example, near a bathtub, wash bowl, kitchen sink or washing machine, in a wet basement, or near a swimming pool.
 2. Avoid using this product during a thunderstorm. There may be a remote risk of an electrical shock from lightning.
 3. DO NOT use this product to report a gas leak in the vicinity of the leak.
 4. Use only the power cord provided with the product (if included in the box).
Read all of the instructions. Save them for later reference.
- (Models with the fax function only)

To reduce the risk of fire, electrical shock, and injury to people;

Use only a No. 26 AWG or larger telecommunication line cord.

- This product must be installed near an AC power outlet that is easily accessible. In case of an emergency, you must unplug the power cord from the AC power outlet to shut off the power completely.



For protection against the risk of electrical shock, always disconnect all cables from the wall outlet before the equipment is installed, serviced, or modified.

IMPORTANT

- This product has been certified to comply with FCC standards, which are applied to the USA only.
- Brother cannot accept any financial or other responsibilities that may be the result of your use of this information, including direct, special, or consequential damages. There are no warranties extended or granted by this document.
- A grounded plug should be plugged into a grounded AC power outlet after checking the rating of the local power supply for the product to operate properly and safely.

Standard Telephone and FCC Notices (Models with the fax function only)

These notices are in effect on models sold and used in the United States only.

When programming emergency numbers or making test calls to emergency numbers:

- Remain on the line and briefly explain to the dispatcher the reason for the call before hanging up.
- Perform these activities in the off-peak hours, such as early morning or late evening.

This equipment complies with Part 68 of the FCC rules and the requirements adopted by the ACTA. On the back side of this equipment is a label that contains, among other information, a product identifier in the format US:AAAEQ##TXXXX. If requested, this number must be provided to the telephone company.

You may safely connect this equipment to the telephone line by means of a standard modular jack, USOC RJ11C.

A plug and jack used to connect this equipment to the premises wiring and telephone network must comply with the applicable FCC Part 68 rules and requirements adopted by the ACTA. A compliant telephone cord and modular plug is provided with this product. It is designed to be connected to a compatible modular jack that is also compliant. See installation instructions for details.

The Ringer Equivalence Number (REN) is used to determine the number of devices that may be connected to a telephone line. Excessive RENs on a telephone line may result in the devices not ringing in response to an incoming call. In most but not all areas, the sum of RENs should not exceed five (5.0). To be certain of the number of devices that may be connected to a line, as determined by the total RENs, contact the local telephone company. For products approved after July 23, 2001, the REN for this product is part of the product identifier that has the format US:AAAEQ##TXXXX. The digits represented by ## are the REN without a decimal point (e.g., 06 is a REN of 0.6). For earlier products, the REN is separately shown on the label.

If this equipment causes harm to the telephone network, the telephone company will notify you in advance that temporary discontinuance of service may be required. But if advance notice is not practical, the telephone company will notify you as soon as possible. Also, you will be advised of your right to file a complaint with the FCC if you believe it is necessary.

The telephone company may make changes in its facilities, equipment, operations, or procedures that could affect the operation of the equipment. If this happens, the telephone company will provide advance notice in order for you to make necessary modifications to maintain uninterrupted service.

If trouble is experienced with this equipment, for repair or warranty information, contact Brother Customer Service (see the *Online User's Guide: Brother Help and Customer Support*). If the

equipment is causing harm to the telephone network, the telephone company may request that you disconnect the equipment until the problem is resolved.

Connection to party line service is subject to state tariffs. Contact the state public utility commission, public service commission or corporation commission for information.

If your home has specially wired alarm equipment connected to the telephone line, ensure the installation of this equipment does not disable your alarm equipment. If you have questions about what will disable the alarm equipment, call your telephone company or a qualified installer.

The Telephone Consumer Protection Act of 1991 makes it unlawful for any person to use a computer or electronic device to send any message via a telephone fax machine unless such messages clearly contain, in a margin at the top or bottom of each transmitted page, or on the first page of the transmission, the date and time it is sent and an identification of the business or other entity or other individual sending the message and the telephone number of the sending machine or such business, other entity or individual. To program this information into your machine, see the *Online User's Guide: Set the Date and Time and Set Your Station ID*.

If you are not able to solve a problem with your product, contact Brother Customer Service (see the *Online User's Guide: Brother Help and Customer Support*).

Federal Communications Commission (FCC) Supplier's Declaration of Conformity (USA Only)

Responsible Party: Brother International Corporation
200 Crossing Boulevard
Bridgewater, NJ 08807-0911 USA
TEL: (908) 704-1700

declares, that the products

Product Name: Mono Laser Printer

Model Numbers: HL-L5210DN/HL-L5210DW/HL-L5210DWT/HL-L5215DW/HL-L6210DW/HL-L6210DWT/HL-L6217DW/HL-L6310DW/HL-L6415DW/HL-L6415DWT/HL-EX415DW

Product Name: Multi Function Printer

Model Numbers: DCP-L5510DN/DCP-L5610DN/DCP-L5660DN/MFC-L5710DN/MFC-L5710DW/MFC-L5715DW/MFC-L5717DW/MFC-L5915DW/MFC-L6810DW/MFC-L6915DW/MFC-EX915DW

Product Options: LT-5505/LT-6505/MX-4000

comply with Part 15 of the FCC Rules. Operation is subject to the following two conditions:

(1) This device may not cause harmful interference, and (2) this device must accept any interference received, including interference that may cause undesired operation.

This equipment has been tested and found to comply with the limits for a Class B digital device, pursuant to Part 15 of the FCC Rules. These limits are designed to provide reasonable protection against harmful interference in a residential installation. This equipment generates, uses, and can radiate radio frequency energy and, if not installed and used in accordance with the instructions, may cause harmful interference to radio communications. However, there is no guarantee that interference will not occur in a particular installation. If this equipment does cause harmful interference to radio or television reception, which can be determined by turning the equipment off and on, the user is encouraged to try to correct the interference by one or more of the following measures:

- Reorient or relocate the receiving antenna.
- Increase the separation between the equipment and receiver.
- Connect the equipment to an outlet on a circuit different from that to which the receiver is connected.
- Consult with an experienced radio/TV technician for help.
- (Wireless network models only)
This transmitter must not be co-located or operated in conjunction with any other antenna or transmitter.

IMPORTANT

- Changes or modifications not expressly approved by Brother Industries, Ltd. could void the user's authority to operate the equipment.
- A shielded interface cable should be used to ensure compliance with the limits for a Class B digital device.

Compliance with FCC requirement 15.407(c)

Data transmission is always initiated by software, which is the passed down through the MAC, through the digital and analog baseband, and finally to the RF chip. Several special packets are initiated by the MAC. These are the only ways the digital baseband portion will turn on the RF transmitter, which it then turns off at the end of the packet. Therefore, the transmitter will be on only while one of the aforementioned packets is being transmitted. In other words, this device automatically discontinues transmission in case of either absence of information to transmit or operational failure.

Frequency Tolerance: ± 25 ppm

RF Exposure Notice (USA or Canada Only) (Wireless Models Only)

This equipment complies with FCC/IC radiation exposure limits set forth for an uncontrolled environment and meets the FCC radio frequency (RF) Exposure Guidelines and RSS-102 of the IC radio frequency (RF) Exposure rules. This equipment should be installed and operated keeping the radiator at least 20 cm or more away from a person's body.

Cet équipement est conforme aux limites d'exposition aux rayonnements énoncées pour un environnement non contrôlé et respecte les lignes directrices d'exposition aux fréquences radioélectriques (RF) de la FCC et les règles d'exposition aux fréquences radioélectriques (RF) CNR-102 de l'IC. Cet équipement doit être installé et utilisé en gardant une distance de 20 cm ou plus entre le radiateur et le corps humain.

Wireless Connection (Mexico Only) (Wireless Models Only)

The operation of this equipment is subject to the following two conditions:

(1) it is possible that this equipment or device may not cause harmful interference, and (2) this equipment or device must accept any interference, including interference that may cause undesired operation.

La operación de este equipo está sujeta a las siguientes dos condiciones:

(1) es posible que este equipo o dispositivo no cause interferencia perjudicial y (2) este equipo o dispositivo debe aceptar cualquier interferencia, incluyendo la que pueda causar su operación no deseada.

Industry Canada Compliance Statement (Canada Only)

This device complies with Industry Canada's licence-exempt RSSs. Operation is subject to the following two conditions:

(1) this device may not cause interference, and (2) this device must accept any interference, including interference that may cause undesired operation of the device.

Le présent appareil est conforme aux CNR d'Industrie Canada applicables aux appareils radio exempts de licence. L'exploitation est autorisée aux deux conditions suivantes:

(1) l'appareil ne doit pas produire de brouillage, et (2) l'utilisateur de l'appareil doit accepter tout brouillage radioélectrique subi, même si le brouillage est susceptible d'en compromettre le fonctionnement.

For indoor use only (5150 MHz - 5350 MHz)

Pour usage intérieur seulement (5150 MHz - 5350 MHz)

EQUIPMENT ATTACHMENT LIMITATIONS (Canada Only) (Models with the fax function only)

NOTICE

This product meets the applicable Innovation, Science and Economic Development Canada technical specifications.

Le présent produit est conforme aux spécifications techniques applicables d'Innovation, Sciences et Développement économique Canada.

NOTICE

The Ringer Equivalence Number (REN) indicates the maximum number of devices allowed to be connected to a telephone interface. The termination of an interface may consist of any combination of devices subject only to the requirement that the sum of the RENs of all the devices not exceed five.

L'indice d'équivalence de la sonnerie (IES) sert à indiquer le nombre maximal de dispositifs qui peuvent être raccordés à une

interface téléphonique. La terminaison d'une interface peut consister en une combinaison quelconque de dispositifs, à la seule condition que la somme des IES de tous les dispositifs n'exécède pas cinq.

Laser Safety (for 110V - 120V Models Only)

This equipment is certified as a Class 1 laser product as defined in IEC60825-1:2014 specifications under the U.S. Department of Health and Human Services (DHHS) Radiation Performance Standard according to the Radiation Control for Health and Safety Act of 1968. This means that the equipment does not produce hazardous laser radiation.

Since radiation emitted inside the equipment is completely confined within protective housings and external covers, the laser beam cannot escape from the product during any phase of user operation.

FDA Regulations (for 110V - 120V Models Only)

⚠ WARNING

Use of controls, adjustments, or performance of procedures other than those specified in this manual may result in hazardous invisible radiation exposure.
Internal laser radiation:
Max. Radiation Power: 25 mW
Wave Length: 775 nm - 800 nm
Laser Class: Class 3B

For Use in the USA or Canada Only

These products are made for use in the USA and Canada only. We cannot recommend using them overseas because it may violate the Telecommunications Regulations (models with the fax function only) of that country and the power requirements of your product may not be compatible with the power available in foreign countries. Using USA or Canada models overseas is at your own risk and may void your warranty.

LAN Connection (Models with the Wired LAN Function Only)

⚠ CAUTION

DO NOT connect this product to a LAN connection that is subject to overvoltages.

International ENERGY STAR® Qualification Statement (USA and Canada Only)

The purpose of the International ENERGY STAR® Program is to promote the development and popularization of energy-efficient office equipment.

As an ENERGY STAR® Partner, Brother Industries, Ltd. has determined that this product meets the ENERGY STAR® specifications for energy efficiency.



Trademarks

Wi-Fi® is a registered trademark of Wi-Fi Alliance®.

QR Code is a registered trademark of DENSO WAVE INCORPORATED in Japan and in other countries.

Each company whose software title is mentioned in this manual has a Software License Agreement specific to its proprietary programs.

Any trade names and product names of companies appearing on Brother products, related documents and any other materials are all trademarks or registered trademarks of those respective companies.

Legal Limitations for Copying or Scanning (Products with Scanning Function Only)

Copying or scanning reproductions of certain documents is regulated by federal, state or provincial law, and may result in criminal or civil liability.

The following list of documents is intended to be a guide and not a complete listing of all items that may be prohibited by a governmental or other official agency.

Please consult with counsel or your government office for specific guidance.

- Money
- Bonds or other certificates of indebtedness
- Certificates of Deposit
- Passports
- Postage Stamps (canceled or uncanceled)
- Food Stamps
- Immigration Papers
- Checks or drafts drawn by Governmental agencies
- Licenses
- Certificates of Title

To request a printed version of the Online User's Guide, please contact us at:

Chile and Bolivia:

Tel: 800-541-000 / Email: info@brother.cl

Peru:

Tel: 0800-00-066 / Email: info@brother.com.pe

Mexico:

Tel: 01-800-759-6000 / 01-800-759-8000

URL: www.brother.com.mx

Argentina, Paraguay and Uruguay:

In Argentina: www.brother.com.ar

In Paraguay: www.brother.com.py

In Uruguay: www.brother.com.uy

Other countries in Latin America and the Caribbean:

Tel: 888-800-7303* (Eastern Standard Time, USA.)

Email: CALASales@brother.com

* AT&T USADirect® Service is not available in all locations. Calling this number may incur charges. Contact your local telephone company for more information.

Disclaimer

Brother disclaims any warranties with respect to avoidance, mitigation or non-occurrence of any breakdowns, malfunctions, system crashes, hang-ups, virus infections, damage and disappearances of data, and any other kind of errors by using this product. AS LONG AS PERMITTED BY APPLICABLE LAWS, BROTHER WILL NOT BE LIABLE FOR ANY LOST REVENUES OR INDIRECT, SPECIAL, INCIDENTAL, CONSEQUENTIAL, EXEMPLARY, OR PUNITIVE DAMAGES OF THE CUSTOMERS OR ANY OTHER THIRD PARTY.