



The latest manuals are available at the Brother support website: [support.brother.com/manuals](http://support.brother.com/manuals)



Read the *Product Safety Guide* first, then read this *Quick Setup Guide* for the correct installation procedure.

Manuals in Spanish for this model are available at [support.brother.com/manuals](http://support.brother.com/manuals).  
 Manuales en Español para este modelo están disponibles en [support.brother.com/manuals](http://support.brother.com/manuals).



If you selected **[[5-B] Set up from the control panel on the machine]** in the printed *Quick Setup Guide* included with the machine, go to **[5-B]**.

## 1 Unpack the machine and check the components

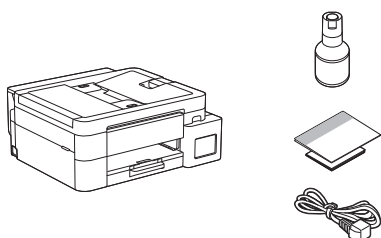

Remove the protective tape and the film covering the machine.

### NOTE

- The illustrations in this guide may not match your model exactly, but the steps are the same for each model. The above illustration is MFC-T930DW.
- The components may differ depending on your country.
- Save all packing materials and the box in case you need to ship your machine.
- If you use a wired connection, you must purchase the correct interface cable for the interface you want to use. (Supported models only)

**USB cable:** Use a USB 2.0 cable (Type A/B) that is no more than 6 feet (2 meters) long (included in some countries).

**Ethernet (Network) cable:** Use a straight-through Category 5 (or greater) twisted-pair cable for 10BASE-T or 100BASE-TX Fast Ethernet Network (not included).

## 2 Load plain Letter paper in the paper tray



Proceed to the next step according to your model. The model name can be found on the front of the machine.

DCP-T530DW / DCP-T535DW / DCP-T536DW  
 DCP-T730DW / DCP-T735DW / MFC-T580DW → **2-A**  
 MFC-T780DW

DCP-T830DW / DCP-T835DW → **2-B**  
 MFC-T930DW / MFC-T935DW / MFC-T980DW

### 2-A

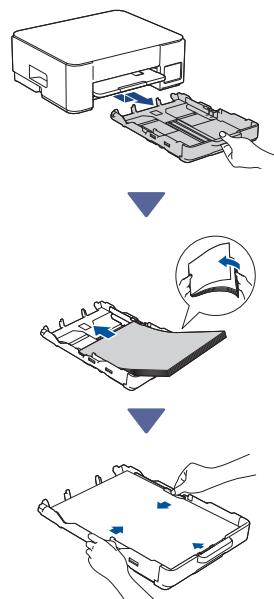

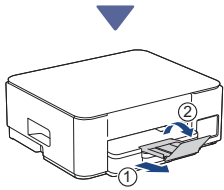
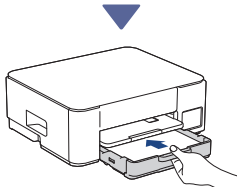

2-B

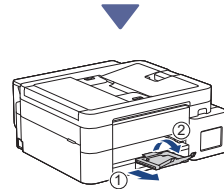
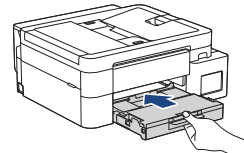
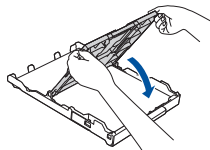
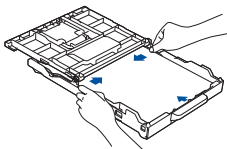
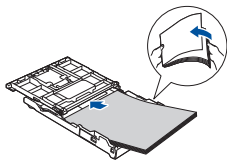
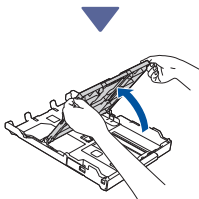
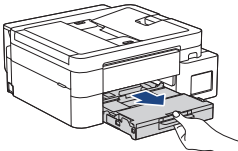

### 3 Connect the telephone line cord (MFC-T930DW / MFC-T935DW / MFC-T980DW)

Follow this step only for models MFC-T930DW / MFC-T935DW / MFC-T980DW and if you are using this machine as a fax machine.

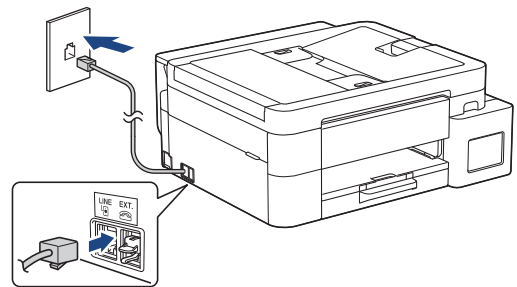

Insert the telephone line cord into the socket marked **LINE**.  
For more information on using the fax feature, see the *Online User's Guide*.

Continue to the next column 

## 4 Connect the power cord

- DCP-T530DW / DCP-T535DW / DCP-T536DW  
DCP-T730DW / DCP-T735DW / MFC-T580DW  
MFC-T780DW

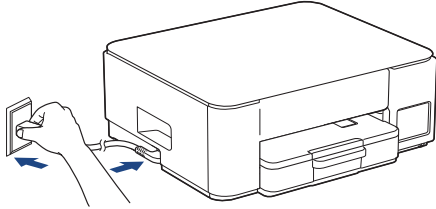

- DCP-T830DW / DCP-T835DW / MFC-T930DW  
MFC-T935DW / MFC-T980DW

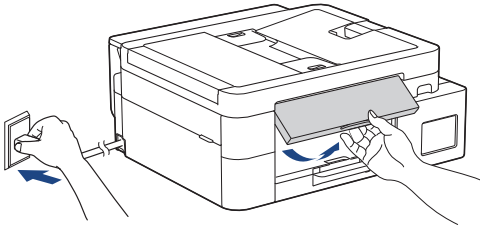

The machine powers on automatically.

(For certain models only) If you are prompted to select your country or language, follow the LCD instructions.

## 5 Choose your setup method

Choose your setup method below.

- To complete both the setup and the connection settings with your device at the same time, follow the instructions in [5-A].
- To set up your machine using a Mac, follow the instructions in section [5-B].



Set up using mobile app or computer software (recommended) → **5-A**

Set up from the control panel on the machine → **5-B**

### Recommended

#### 5-A Set up using mobile app or computer software

(To set up your machine using a Mac, follow the instructions in section [5-B].)

Go to the website applicable to your setup method:

##### Set up with your mobile device

\* The mobile device must be connected to Wi-Fi®.



[setup.brother.com](http://setup.brother.com)

##### Set up with your computer



[setup.brother.com](http://setup.brother.com)

#### NOTE

Even after the setup is complete, you can also use your machine on another device by installing the software on that device.

#### 5-B Set up from the control panel on the machine

Follow the steps below according to your model.

- DCP-T530DW / DCP-T535DW / DCP-T536DW  
DCP-T730DW / DCP-T735DW / DCP-T830DW  
DCP-T835DW / MFC-T580DW

1. When [Set up?] is displayed, press ▼.
2. Press ▲ or ▼ to select [Set up using LCD], and then press **OK**.
3. When the message appears on the LCD, press ▲.

- MFC-T780DW / MFC-T930DW / MFC-T935DW  
MFC-T980DW

1. Press ◀ when the QR Code screen appears.
2. Press ▶ when the [Set up from machine] screen appears to confirm the change of mode.

Continue to the next column ↗

## 6 Fill the ink tanks with starter ink

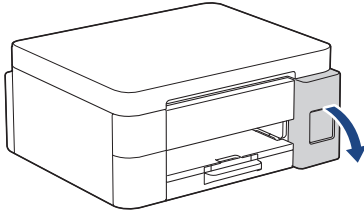

Open the ink tank cover.  
(The illustrations in this guide may not match your model exactly, but the steps are the same for each model.)

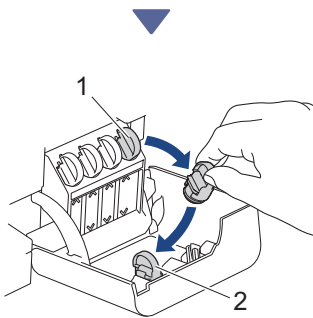

Remove the cap (1) and place it inside the back of the cover (2).

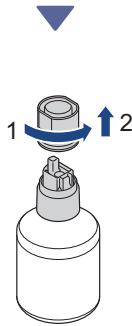

Remove the ink bottle cap.

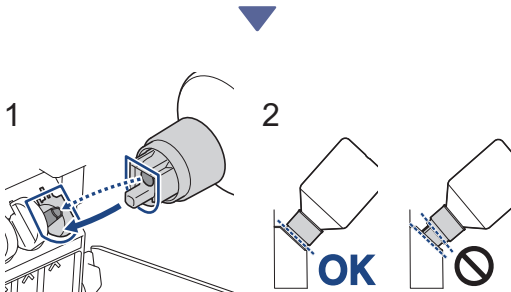

Align the bottle so that the pin on the ink tank can be inserted into the hole in the bottle, as shown in (1).

Slide the bottle onto the pin at the angle shown in (2) until the cap is flush with the ink tank surface. (You will hear a click when you insert it for the first time.)

The bottle will support itself when in the correct position and the ink will fill the tank automatically. If ink flow does not start automatically or if it fills very slowly, carefully remove and reinsert the bottle.

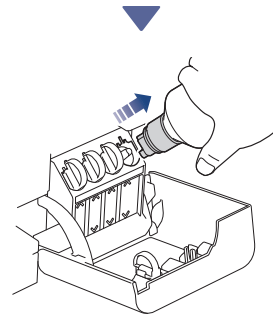

When finished, remove the bottle, pulling the nozzle slowly so the ink does not spill.

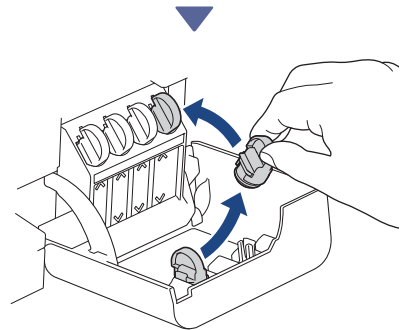

Remove the cap from inside the ink tank cover and seal the ink tank.

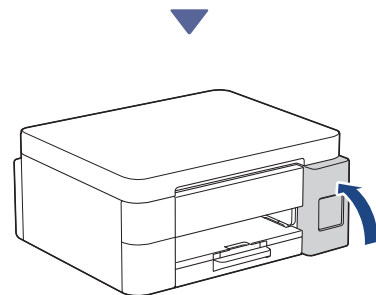

After filling all of the ink tanks, close the ink tank cover.

Continue to the next column 

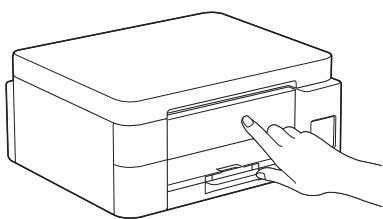

Check the LCD messages to continue setup. When the message preparing ink appears, follow the LCD instructions to perform initial ink system cleaning. Cleaning can take a few minutes, and you can perform the next step during this time.

## 7 Set the date and time

Follow the steps on the LCD to set the date and time.

➤ DCP-T530DW / DCP-T535DW / DCP-T536DW  
DCP-T730DW / DCP-T735DW / DCP-T830DW  
DCP-T835DW / MFC-T580DW

1. Press **OK** to set the date and time.
2. Press **▲** or **▼** to select the number, and then press **OK** to set the date and time.

➤ MFC-T780DW / MFC-T930DW / MFC-T935DW  
MFC-T980DW

Follow the LCD instructions to set the date and time.

## 8 Set firmware update notifications



Follow this step for models MFC-T780DW / MFC-T930DW / MFC-T935DW / MFC-T980DW only.

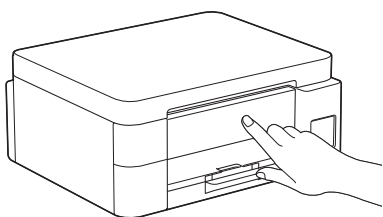

When the firmware update information screen appears, configure your firmware settings.

## 9 Check the print quality

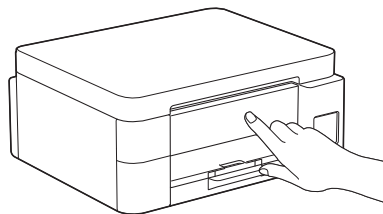

When the initial ink system cleaning has finished, print the Print Quality Check Sheet:

➤ DCP-T530DW / DCP-T535DW / DCP-T536DW  
DCP-T730DW / DCP-T735DW / DCP-T830DW  
DCP-T835DW / MFC-T580DW

Press **Start**.

➤ MFC-T780DW / MFC-T930DW / MFC-T935DW  
MFC-T980DW

Press **▶**.



The machine prints the Print Quality Check Sheet.

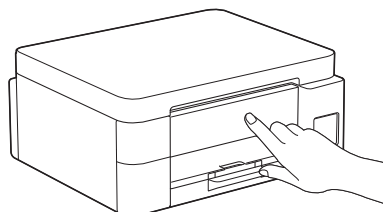
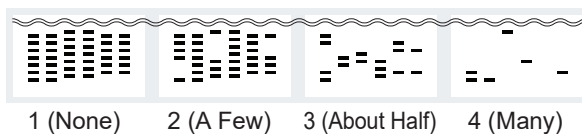

On the machine's LCD, select the images that closely match the image for each color on the Print Quality Check Sheet, and then restart the cleaning procedure, if required.

## 10 Adjust the print alignment (recommended)

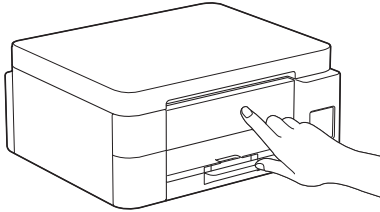

To adjust the print alignment before using your machine, print the Adjustment Sheet:

- DCP-T530DW / DCP-T535DW / DCP-T536DW  
DCP-T730DW / DCP-T735DW / DCP-T830DW  
DCP-T835DW / MFC-T580DW

When the alignment check message appears, press ▲ and follow the LCD instructions.

- MFC-T780DW / MFC-T930DW / MFC-T935DW  
MFC-T980DW

When the paper adjustment message appears, press ► and follow the LCD instructions.

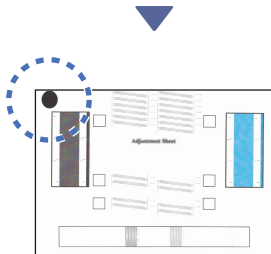

There is a black circle located in the upper left corner of the sheet.

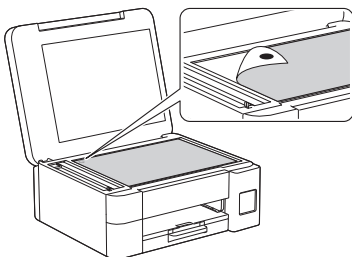

Place the Adjustment Sheet face down on the scanner glass, making sure the black circle is in the upper left corner of the scanner glass, as shown.

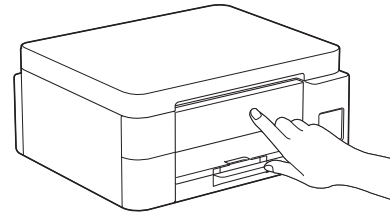

Follow the LCD instructions to adjust the alignment.

When finished, remove the Adjustment Sheet from the scanner glass.

## 11 Connect your computer or mobile device to your machine (if needed)

Visit the following website from your computer or mobile device or scan the code below to install the software.

 [setup.brother.com](http://setup.brother.com)



Make sure your machine and mobile device are connected to the same network.

### NOTE

- DCP-T530DW / DCP-T535DW / DCP-T536DW  
DCP-T730DW / DCP-T735DW / MFC-T580DW  
MFC-T780DW

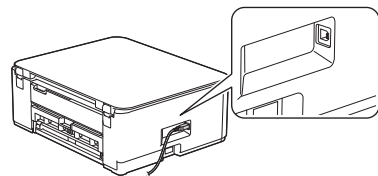

For USB connection, locate the correct port on the side of the machine, as shown.

Continue to the next column 

➤ DCP-T830DW / DCP-T835DW / MFC-T930DW  
MFC-T935DW / MFC-T980DW

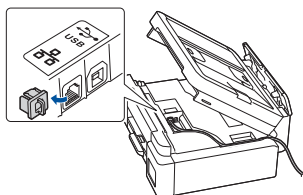

For wired network connection and USB connection, locate the correct port (based on the cable you are using) inside the machine, as shown.

## Setup Finished

Now you are ready to print or scan from this machine. Perform the following steps as necessary.

### Important Notice for Network Security:

The default password to manage this machine's settings is located on the back of the machine and marked "Pwd". We recommend immediately changing the default password to protect your machine from unauthorized access.

## Manual wireless setup

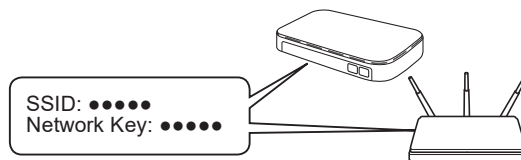

Find the SSID (Network Name) and Network Key (Password) on your wireless access point/router.



➤ DCP-T530DW / DCP-T535DW / DCP-T536DW  
DCP-T730DW / DCP-T735DW / DCP-T830DW  
DCP-T835DW / MFC-T580DW

1. Go to your machine and press **Wi-Fi**.
2. Press **OK** to select [Find Network]. The [WLAN Enable?] message appears on the LCD.
3. Press **▲** to select [On].
4. Select the SSID (Network Name) for your access point/router and enter the Network Key (Password).

If you cannot find this information, ask your network administrator or wireless access point/router manufacturer.

To enter the Network Key (Password), hold down or repeatedly press **▲** or **▼** to select a character from the list below:

aAbBcCdDeEfFgGhHijJkKlLmMnNoOpPqQrRsStT  
uUvVwWxXyYzZ!@&%#^\_{}|() ;:~<>=+\*/  
\_1234567890

➤ MFC-T780DW / MFC-T930DW / MFC-T935DW  
MFC-T980DW

1. Go to your machine, and press  or **Wi-Fi** on the panel.
2. Press **OK** to select [Find Wi-Fi Network]. The [Enable WLAN?] message appears on the LCD.
3. Press **▶** to select Yes.
4. Select the SSID (Network Name) for your access point/router and enter the Network Key (Password).

Continue to the next column 

If you cannot find this information, ask your network administrator or wireless access point/router manufacturer.

For more information, see *Enter Text on Your Brother Machine* in the *Online User's Guide*.

When the wireless setup is successful, the LCD displays [Connected].

For detailed machine information and product specifications, see the *Online User's Guide* at [support.brother.com/manuals](https://support.brother.com/manuals).