



Operation Videos:
www.95105369.com



Installation & Using Videos

Read the *Product Safety Guide* first, then read this *Quick Setup Guide* for the correct installation procedure.

i If you selected **[[4-B] Set up from the control panel on the machine]** in the printed *Quick Setup Guide* included with the machine, go to **[4-B]**.

1 Unpack the machine and check the components

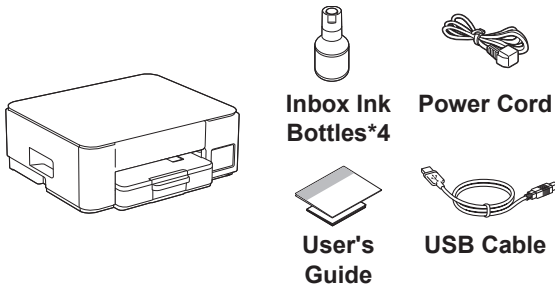

Remove the protective tape and the film covering the machine.

NOTE

- The illustrations in this guide may not match your model exactly, but the steps are the same for each model.
- Save all packing materials and the box in case you need to ship your machine.
- We recommend using a USB 2.0 cable (Type A/B) that is no more than 2 metres long.

2 Load plain A4 paper in the paper tray

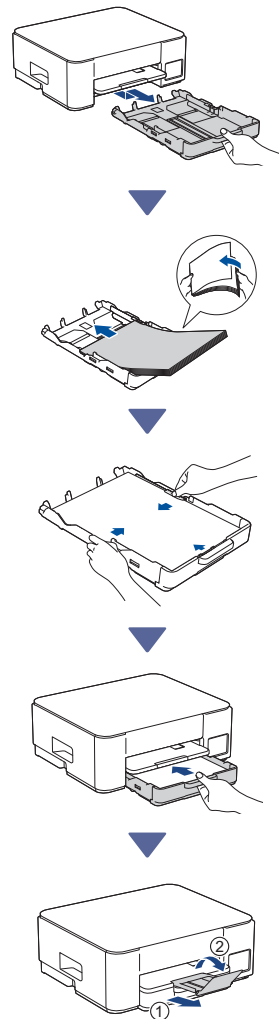

Continue to the next column

3 Connect the power cord

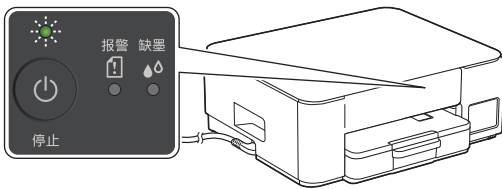
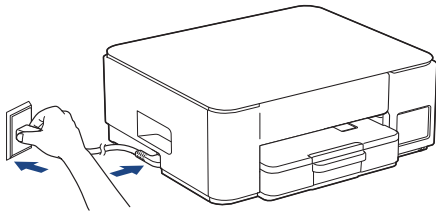

The machine powers on automatically and the Power LED is flashing.

4 Choose your setup method

Choose your setup method below.

- To complete both the setup and the connection settings with your device at the same time, follow the instructions in [4-A].
- To set up your machine using a Mac, follow the instructions in section [4-B].



Set up using mobile app or computer software (recommended) → **4-A**

Set up from the control panel on the machine → **4-B**

Recommended

4-A Set up using mobile app or computer software

(To set up your machine using a Mac, follow the instructions in section [4-B].)

Go to the website applicable to your setup method: (DCP-T230/DCP-T236/DCP-T238) Choose *Set up with your computer*.

Set up with your mobile device

* The mobile device must be connected to Wi-Fi®.



setup.brother.com

Set up with your computer



setup.brother.com

NOTE

Even after the setup is complete, you can also use your machine on another device by installing the software on that device.

4-B Set up from the control panel on the machine



When the Power LED starts flashing slowly, press and hold the **Mono Copy** button for three seconds.

Confirm that the Power LED is lit and the Ink LED is flashing, and then proceed to the next step.

Continue to the next column

5 Fill the ink tanks with inbox ink

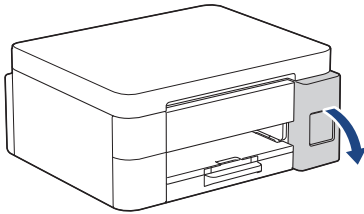

Open the ink tank cover.
(The illustrations in this guide may not match your model exactly, but the steps are the same for each model.)

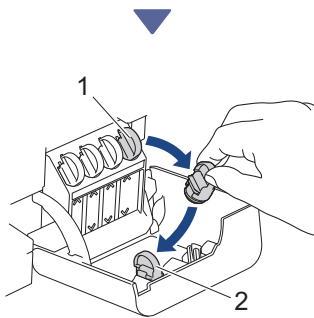

Remove the cap (1) and place it inside the back of the cover (2).

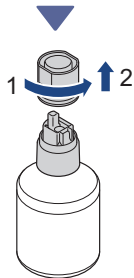

Remove the ink bottle cap.

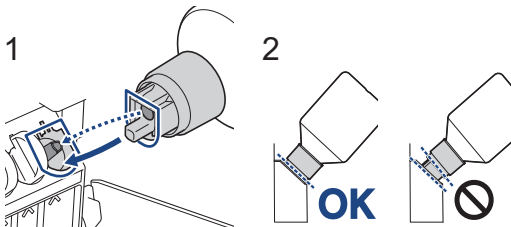

Align the bottle so that the pin on the ink tank can be inserted into the hole in the bottle, as shown in (1).

Slide the bottle onto the pin at the angle shown in (2) until the cap is flush with the ink tank surface. (You will hear a click when you insert it for the first time.)

The bottle will support itself when in the correct position and the ink will fill the tank automatically. If the ink flow does not start automatically or if the tank fills very slowly, carefully remove and reinsert the bottle.

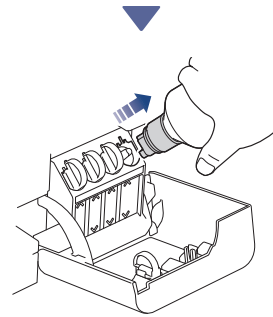

When finished, remove the bottle, pulling the nozzle slowly so the ink does not spill.

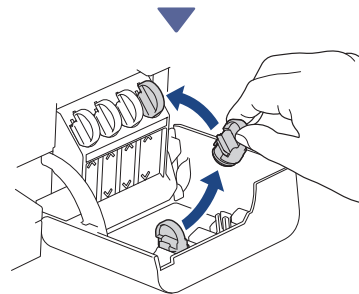

Remove the cap from inside the ink tank cover and seal the ink tank.

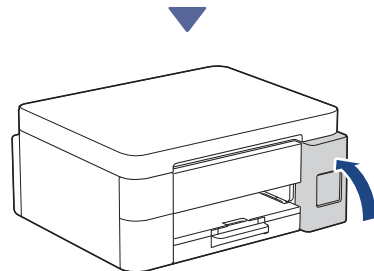

After filling all of the ink tanks, close the ink tank cover.

Continue to the next column 

6 Start the initial cleaning



Press and hold the **Colour Copy** button for three seconds to start the initial ink system cleaning. During the initial cleaning, both the Power and Ink LEDs will flash. Cleaning can take a few minutes.



When the initial ink system cleaning has finished, the machine prints the Print Quality Check Sheet.

7 Check the print quality

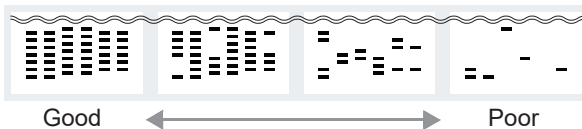

Check the Print Quality Check Sheet. To improve the print quality, clean the print head. See the *Reference Guide*.

8 Connect your computer or mobile device to your machine (if needed)

Visit the following website from your computer or mobile device or scan the code below to install the software.

 setup.brother.com



Make sure your machine and mobile device are connected to the same network.

NOTE

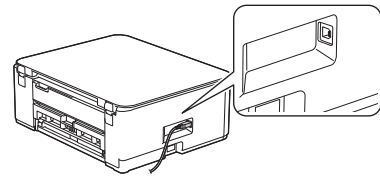

For USB connection, locate the correct port on the side of the machine, as shown.

Setup Finished

Now you are ready to print or scan from this machine.

Important Notice for Network Security:

The default password to manage this machine's settings is located on the back of the machine and marked "Pwd". We recommend immediately changing the default password to protect your machine from unauthorized access.

Continue to the next column 

For detailed machine information and product specifications, see the *Online User's Guide* at www.95105369.com.