



Operation Videos:  
[www.95105369.com](http://www.95105369.com)



Installation &  
Using Videos

Read the *Product Safety Guide* first, then read this *Quick Setup Guide* for the correct installation procedure.



If you have followed the instructions in the printed *Quick Setup Guide* included with your machine and selected "Manual Setup", go directly to step 6 in this guide.

## 1 Unpack the machine and check the components

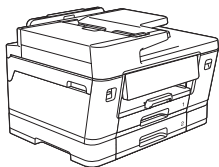

**Inbox ink cartridges**



**Power Cord**

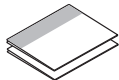

**User's Guides**



**USB Cable**

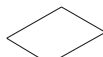

**Maintenance Sheet**

Remove the protective tape or film covering the machine and the supplies.

### NOTE

- The illustrations in this guide may not match your model exactly, but the steps are the same for each model.
- Save all packing materials and the box in case you need to ship your machine.
- If you use a wired connection, you must purchase the correct interface cable for the interface you want to use.

**USB cable:** Use a USB 2.0 cable (Type A/B) that is no more than 2 metres long.

**Ethernet (Network) cable:** Use a straight-through Category 5e (or greater) twisted-pair cable for 10Base-T/100Base-TX/1000Base-T.

## 2 Load plain A4 paper

### NOTE

For more information on loading different media, see the *Online User's Guide* at [www.95105369.com](http://www.95105369.com).

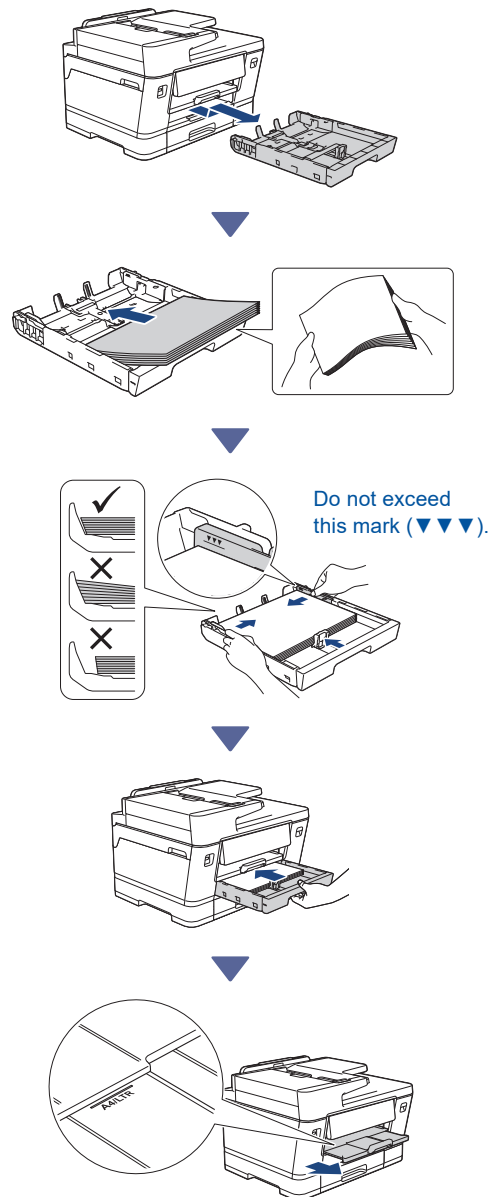

Continue to the next column ↗

### 3 Connect the telephone line cord (models with the fax function only)



Follow this step only if you are using this machine as a fax machine.

The telephone line cord is not included in the box.

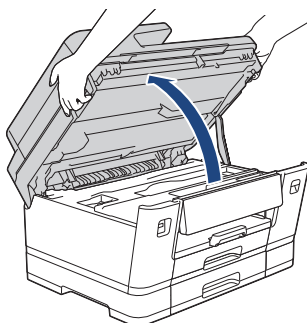

Lift the scanner cover.

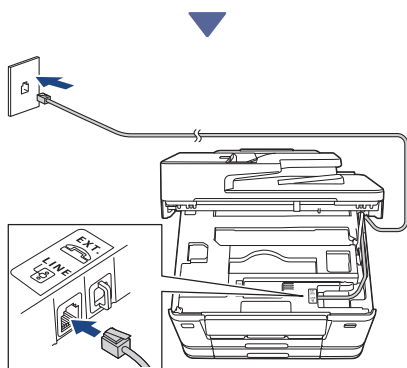

Insert the telephone line cord into the socket marked **LINE** and guide the cord out of the back of the machine.

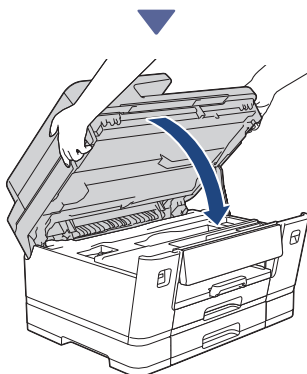

Close the scanner cover.

Continue to the next column

### 4 Connect the power cord

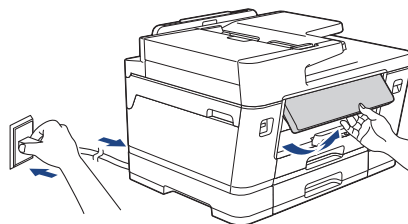

The machine powers on automatically.

#### NOTE

You can adjust the control panel angle to read the LCD more easily.

### 5 Choose your setup method

#### Easy Setup

Go to [setup.brother.com](https://setup.brother.com) and download the app or software that helps you to easily complete your setup and connection.

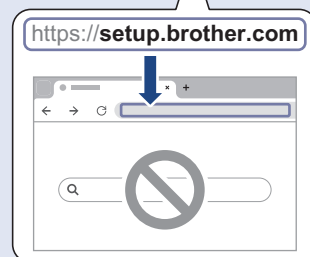
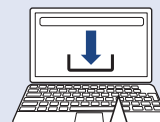
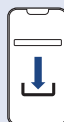

Not available for macOS

#### Manual Setup

Go to step 6.

#### NOTE

You can use your machine with multiple devices. Use one of the setup methods in this step to download the machine's software onto other devices that you want to use.

## 6 Set up from the machine's control panel

1. Press [Setup without app/software] when the QR Code screen appears.
2. Read the LCD information, and then press [Yes].

## 7 Install the inbox ink cartridges

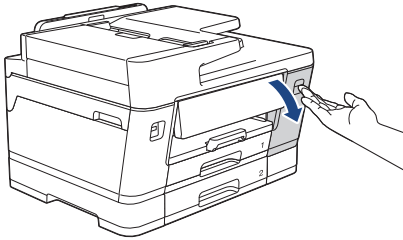

Open the ink cartridge cover.

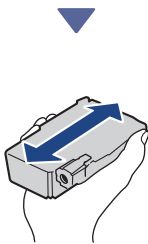

Quickly shake just the **black** ink cartridge horizontally 15 times as shown, before inserting it into the machine.

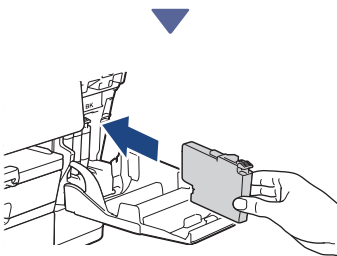

Follow the LCD instructions to install the ink cartridges.

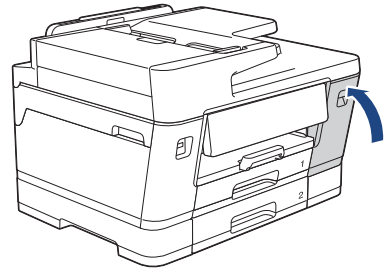

After installing all of the four ink cartridges, close the ink cartridge cover.

Check the LCD messages to continue the setup. When the ink preparation message appears, follow the LCD instructions to perform the initial ink system cleaning. Cleaning can take a few minutes, and you can perform the next step during this time.

### NOTE

The first time you install the ink cartridges, the machine will use extra ink to fill the ink delivery tubes. This is a one-time process that enables high-quality printing.

## 8 Set the date and time

Follow the LCD instructions to set the date and time.

## 9 Set the internet connection for some functions or firmware update

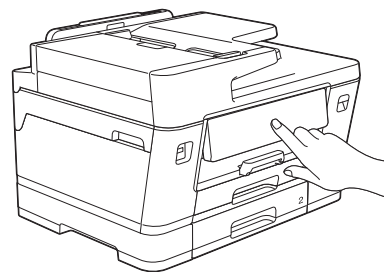

Follow the LCD instructions. When you press [Yes], standard Internet connection rates will apply.

## 10 Check the print quality

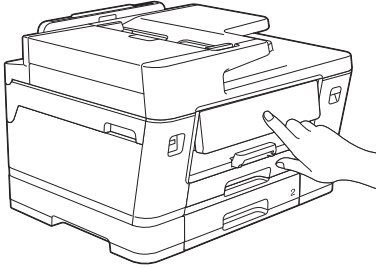

When the initial ink system cleaning has finished, print the Print Quality Check Sheet: Press [Start].



The machine prints the Print Quality Check Sheet.

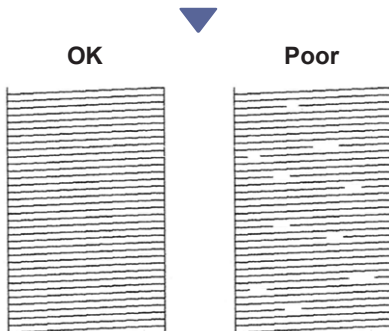

On the machine's LCD, select the images that closely match the image for each colour on the Print Quality Check Sheet, and then restart the cleaning procedure, if required.

## 11 Adjust the print alignment (recommended)

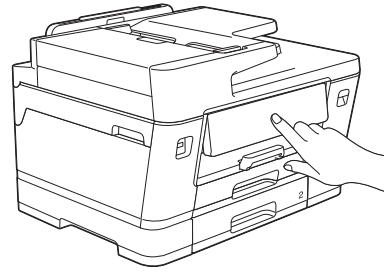

To adjust the print alignment before using your machine, print the Adjustment Sheet: When the adjustment message appears, press [Start] and follow the LCD instructions.

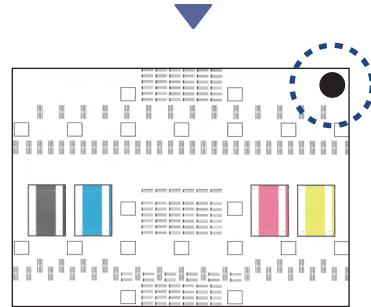

There is a black circle located in the top right corner of the sheet.

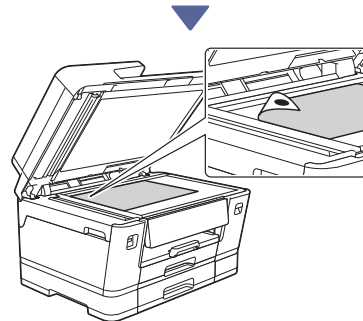

Place the Adjustment Sheet face down on the scanner glass, making sure the black circle is in the top left corner of the scanner glass, as shown.

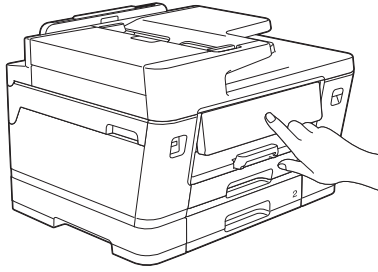

Follow the LCD instructions to adjust the alignment.  
When finished, remove the Adjustment Sheet from the scanner glass.

## 12 Confirm the machine setup completion

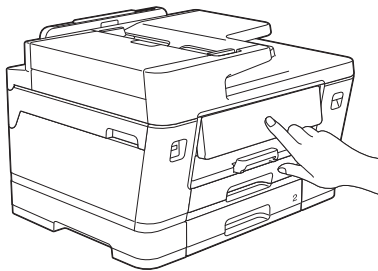

Follow the LCD instructions if displayed, and then confirm the machine setup completion.

## 13 Connect your computer or mobile device to your machine (if needed)

Go to [setup.brother.com](https://setup.brother.com) and download the app or software.

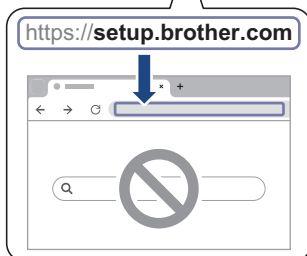

### NOTE

For USB or wired network connection, locate the correct port (based on the cable you are using) inside the machine, as shown.

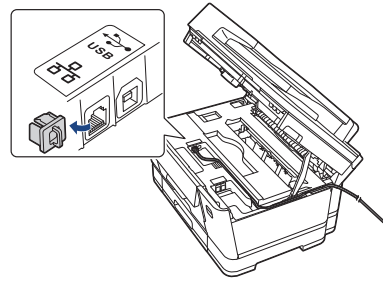

## Setup Finished

Now you are ready to print or scan from your machine.

### Important Notice for Network Security:

The default password to manage this machine's settings is located on the back of the machine and marked "Pwd". We recommend immediately changing the default password to protect your machine from unauthorised access.

## 14 Manual wireless setup

If the wireless setup is not successful, try to set up the connection manually.

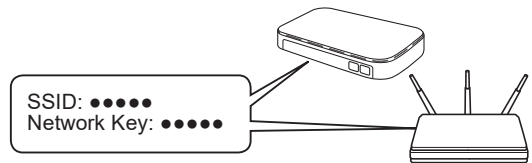

Find the SSID (Network Name) and Network Key (Password) on your wireless access point/router.

If you cannot find this information, ask your network administrator or wireless access point/router manufacturer.

1. Go to your machine and press > [Find Wi-Fi Network] > [Yes].
2. Select the SSID (Network Name) for your access point/router and enter the Network Key (Password).

When the wireless setup is successful, the LCD displays [Connected]. Go to step 13 to download the app or software.

If still not successful, visit [www.95105369.com](http://www.95105369.com) for FAQs and Troubleshooting.

Continue to the next column

## Appendix

### 兄弟畅享印 (WeChat Mini Program)

You can print photos and documents using WeChat application "兄弟畅享印", without the need to install an app or a driver. Register your machine before using this feature for the first time. Visit the QR code on the right for the instruction.

