



The latest manuals are available at the Brother support website: support.brother.com/manuals



Read the *Product Safety Guide* first, then read this *Quick Setup Guide* for the correct installation procedure.



If you have followed the instructions in the printed *Quick Setup Guide* included with your machine and completed steps 1 to 4, go directly to step 5-B.

1 Unpack the machine and check the components

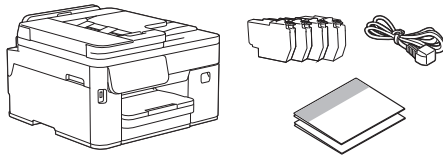

Remove the protective tape or film covering the machine and the supplies.

NOTE

- The illustrations in this guide may not match your model exactly, but the steps are the same for each model.
- The components may differ depending on your country.
- Save all packing materials and the box in case you need to ship your machine.
- If you use a wired connection, you must purchase the correct interface cable for the interface you want to use.

USB cable: Use a USB 2.0 cable (Type A/B) that is no more than 5 metres long.

Ethernet (Network) cable: Use a straight-through Category 5e (or greater) twisted-pair cable for 10Base-T/100Base-TX/1000Base-T.

2 Load plain A4 paper

NOTE

For more information on loading different media, see the *Online User's Guide* at support.brother.com/manuals.

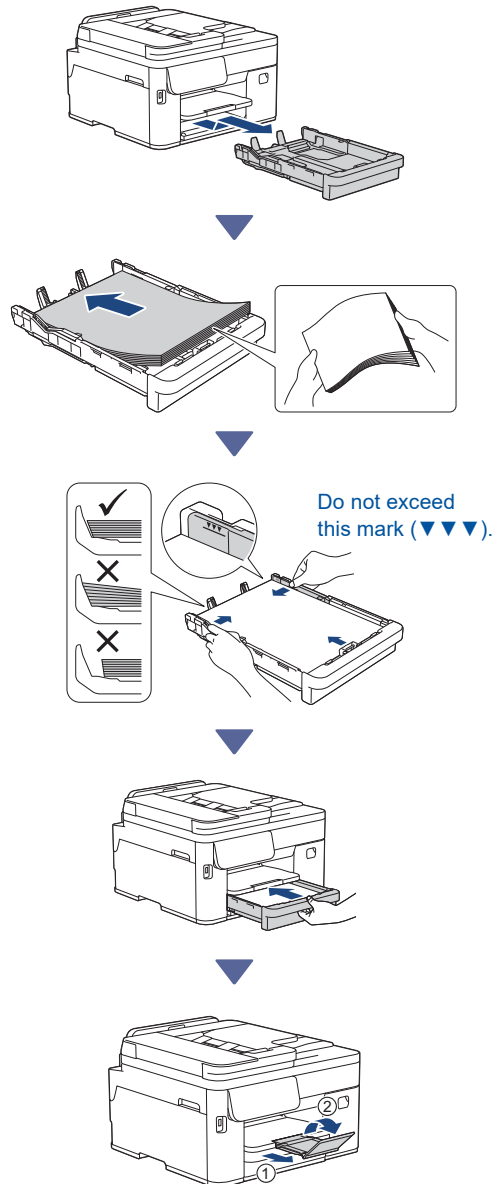

3 Connect the telephone line cord (models with the fax function only)



Follow this step only if you are using this machine as a fax machine.

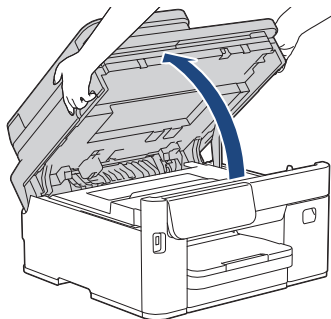

Lift the scanner cover.

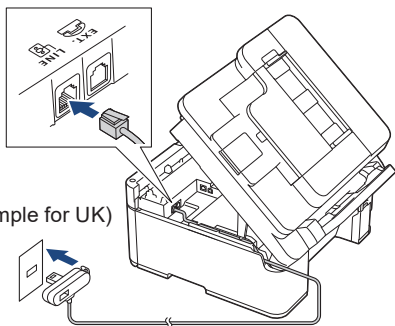

(Example for UK)

Insert the telephone line cord into the socket marked **LINE** and guide the cord out of the back of the machine.

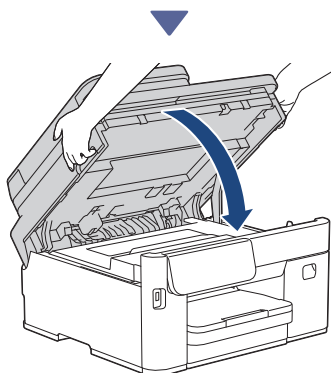

Close the scanner cover.

(For Europe) We can send you a genuine Brother cord free of charge if you need one. To contact us, visit www.brother.eu.

4 Connect the power cord

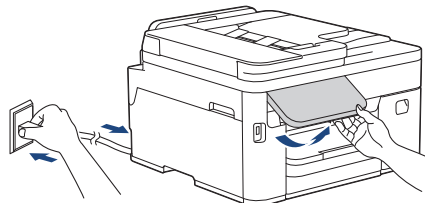

The machine powers on automatically.

(For certain models only) If you are prompted to select your country or language, follow the LCD instructions.

NOTE

You can adjust the control panel angle to read the LCD more easily.

5 Choose your setup method



Choose the setup method according to your environment.

Set up using mobile app or computer software (Recommended) → **5-A**

Set up from the machine's control panel (Mac users who cannot use a mobile device for setup should select this method.) → **5-B**

Continue to the next column

Recommended

5-A Set up using mobile app or computer software

Go to the website applicable to your setup method:

Set up with your mobile device

* The mobile device must be connected to Wi-Fi®.



setup.brother.com

Set up with your computer (Windows only)

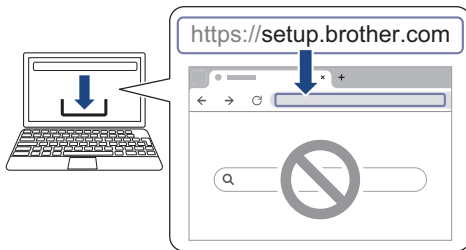

setup.brother.com

NOTE

You can use your machine with multiple devices. Use one of the setup methods in this step to download the machine's software onto other devices that you want to use.

5-B Set up from the machine's control panel

1. Press [Setup without app/software] when the QR Code screen appears.
2. Read the LCD information, and then press [Yes].

6 Install the inbox ink cartridges

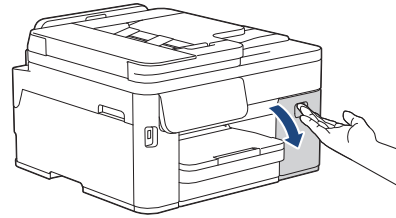

Open the ink cartridge cover.

(The illustrations in this guide may not match your model exactly, but the steps are the same for each model.)

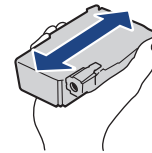

Quickly shake just the **black** ink cartridge horizontally 15 times as shown, before inserting it into the machine.

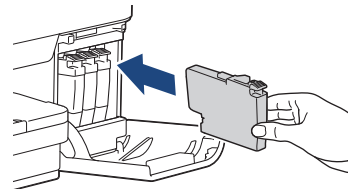

Follow the LCD instructions to install the ink cartridges.

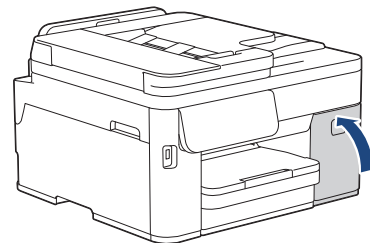

After installing all of the four ink cartridges, close the ink cartridge cover.

Continue to the next column 

Check the LCD messages to continue the setup. When the ink preparation message appears, follow the LCD instructions to perform the initial ink system cleaning. Cleaning can take a few minutes, and you can perform the next step during this time.

NOTE

The first time you install the ink cartridges, the machine will use extra ink to fill the ink delivery tubes. This is a one-time process that enables high-quality printing.

7 Set the date and time

Follow the LCD instructions to set the date and time.

8 Set the internet connection for some functions or firmware update

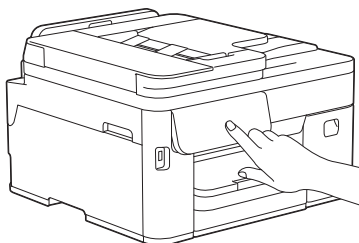

Follow the LCD instructions. When you press [Yes], standard Internet connection rates will apply.

9 Check the print quality

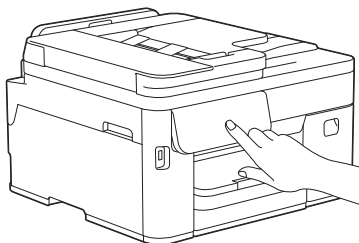

When the initial ink system cleaning has finished, print the Print Quality Check Sheet: Press [Start].

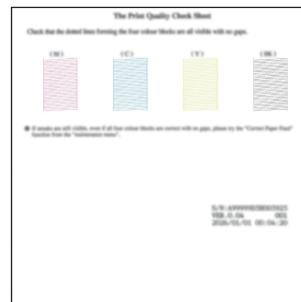

The machine prints the Print Quality Check Sheet.

OK

Poor

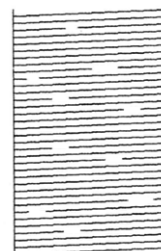
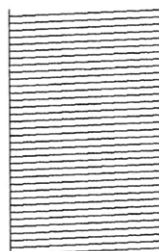

On the machine's LCD, select the images that closely match the image for each colour on the Print Quality Check Sheet, and then restart the cleaning procedure, if required.

10 Adjust the print alignment (recommended) (supported models only)

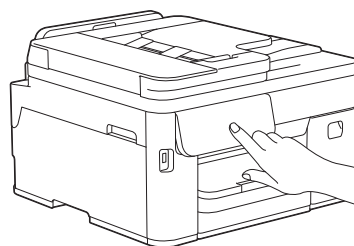

To adjust the print alignment before using your machine, print the Adjustment Sheet: When the adjustment message appears, press [Start] and follow the LCD instructions.

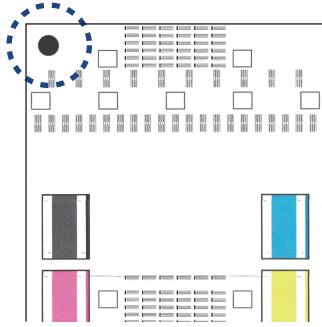

There is a black circle located in the top left corner of the sheet.

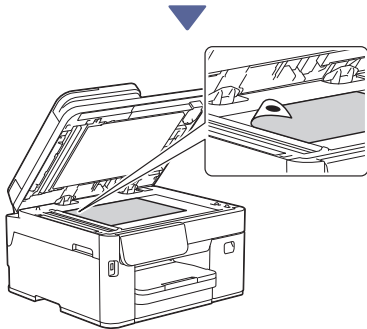

Place the Adjustment Sheet face down on the scanner glass, making sure the black circle is in the top left corner of the scanner glass, as shown.

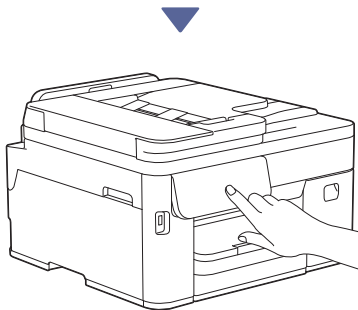

Follow the LCD instructions to adjust the alignment.
When finished, remove the Adjustment Sheet from the scanner glass.

11 Confirm the machine setup completion

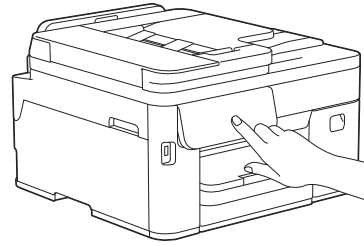

Follow the LCD instructions if displayed, and then confirm the machine setup completion.

12 Connect your computer or mobile device to your machine (if needed)

Visit the following website from your computer or mobile device, or scan the code below to install the software:

Make sure your machine and mobile device are connected to the same network.



setup.brother.com

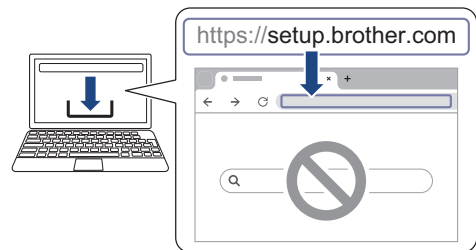

setup.brother.com

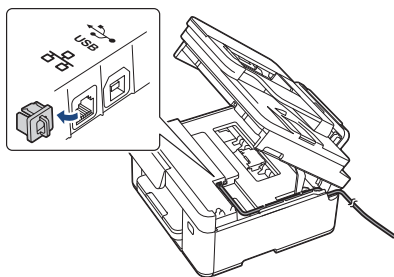

NOTE

For USB or wired network connection, locate the correct port (based on the cable you are using) inside the machine, as shown.

Setup Finished

Now you are ready to print or scan from your machine. Complete the steps in the "Manual wireless setup" section, if necessary.

Important Notice for Network Security:

The default password to manage this machine's settings is located on the back of the machine and marked "PwD". We recommend immediately changing the default password to protect your machine from unauthorised access.

Manual wireless setup

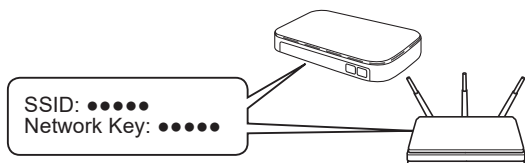

Find the SSID (Network Name) and Network Key (Password) on your wireless access point/router.

If you cannot find this information, ask your network administrator or wireless access point/router manufacturer.



1. Go to your machine and press  > [Find Wi-Fi Network] > [Yes].
2. Select the SSID (Network Name) for your access point/router and enter the Network Key (Password).

When the wireless setup is successful, the LCD displays [Connected].

For detailed machine information and product specifications, see the *Online User's Guide* at support.brother.com/manuals.