

Quick Reference Guide

Stručná referenční příručka

Gyors útmutató

Skrócona instrukcja obsługi

Ръководство за бързи справки

Ghid de referință rapidă

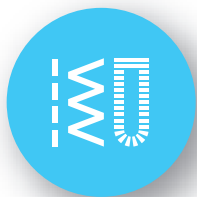
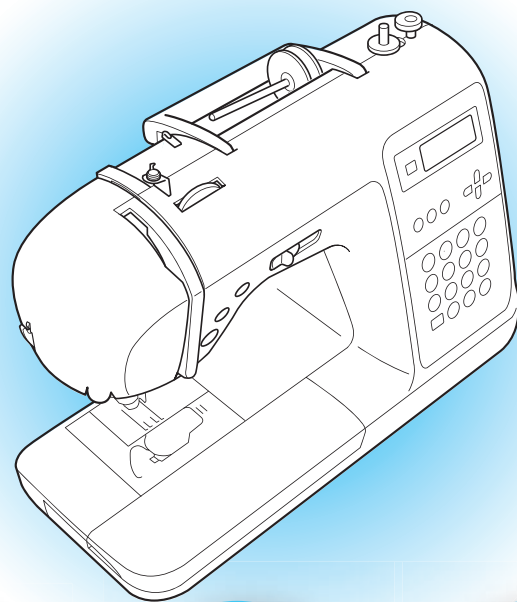

Refer to the operation manual for detailed instruction.

Podrobný návod naleznete v uživatelské příručce.

A részletes utasításokért lásd a Használati utasítást.

Szczegółowe informacje znajdują się w instrukcji obsługi.

За подробни инструкции, направете справка с ръководството за работа.

Pentru instrucțiuni detaliate consultați manualul de utilizare.

Contents

Obsah
Tartalomjegyzék
Spis treści
Съдържание
Cuprins

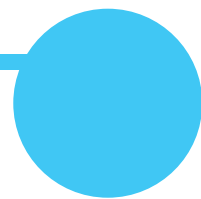

Bobbin winding and setting

2

Navíjení cívky a nastavení
Orsó csévélése és beállítása
Ustawienie i nawijanie bębenka
Навиване и поставяне на калерчето
Bobinarea și instalarea bobinei



Upper threading

4

Zavedení horní niti
Felsőszál befűzése
Nawlekanie górnej nici
Вдяване отгоре
Înfilarea firului superior



Selecting stitch patterns

6

Výběr typů stehů
Öltési minták kiválasztása
Wybieranie wzorów ściegów
Избиране на шаблони на шев
Selectarea modelelor de cusături



Combining and saving patterns

9

Kombinace a ukládání vzorů
Minták kombinálása és mentése
Łączenie i zapisywanie wzorów
Комбиниране и запаметяване на шаблони
Combinarea și salvarea modelelor



Saved patterns' memo

10

Paměť uložených vzorů
Mentett minták emlékeztetője
Przypomnienie zapisanych wzorów
Бележка за запаметени шаблони
Memo modele salvate

Summary of stitch patterns

11

Shrnutí vzorů stehů
Öltési minták összegzése
Podsumowanie zapisanych wzorów
Кратко изложение на шаблони на шев
Lista cu modelele de cusături

Bobbin winding and setting



Navíjení cívky a nastavení

Orsó csévélése és beállítása

Ustawienie i nawijanie bębenka

Навиване и поставяне на калерчето

Bobinarea și instalarea bobinei

Use only the included bobbin or bobbins of the same type.

Používejte pouze přiloženou cívku nebo cívky stejného typu.

Csak a mellékelt orsót vagy azzal megegyező típusú orsókat használjon.

Używaj wyłącznie bębenka dołączonego do maszyny lub bębenków tego samego rodzaju.

Използвайте само доставеното калерче или калерчета от същия тип.

Folosiți doar bobina primită odată cu mașina sau bobine de același tip.

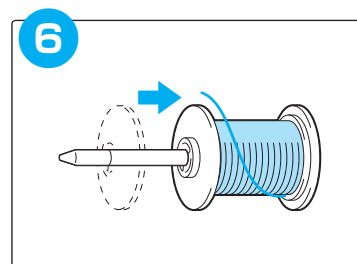
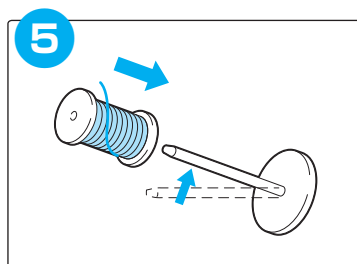
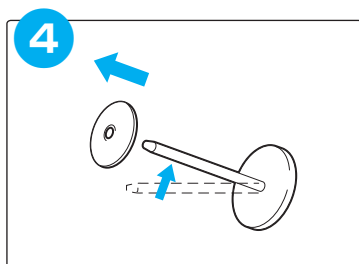
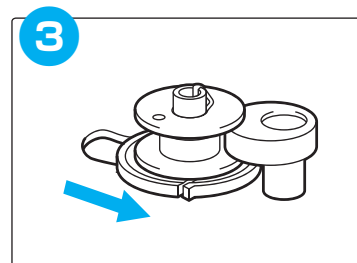
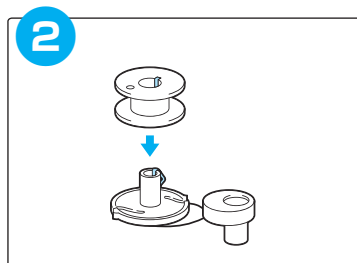
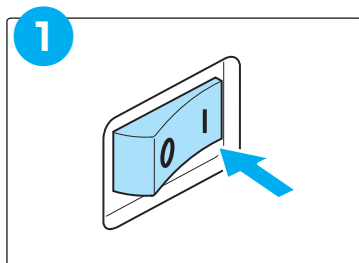
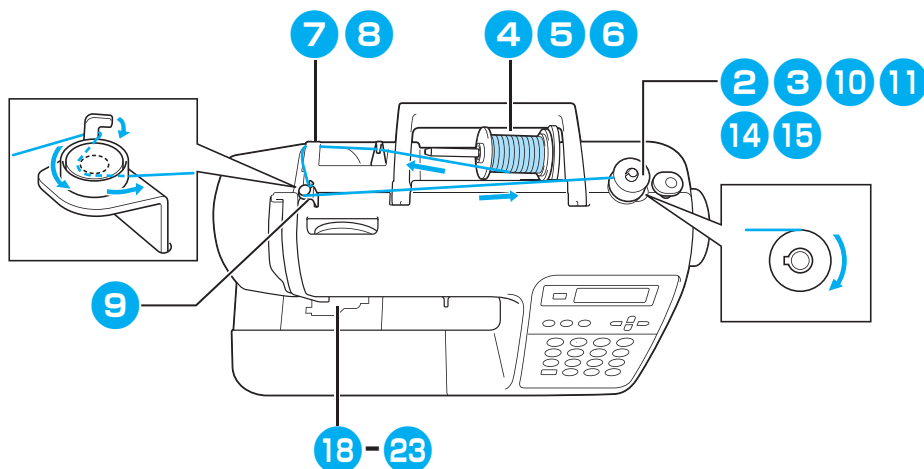

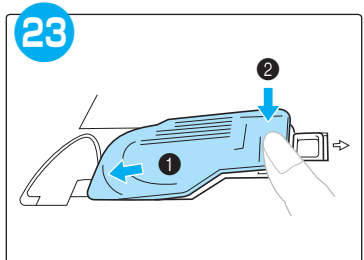
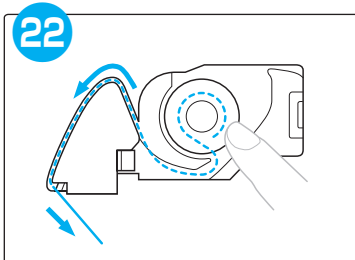
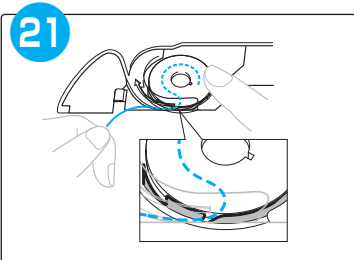
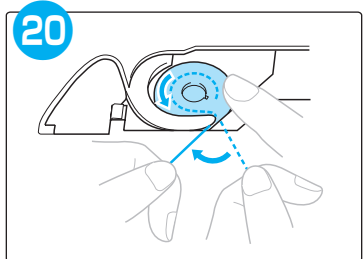
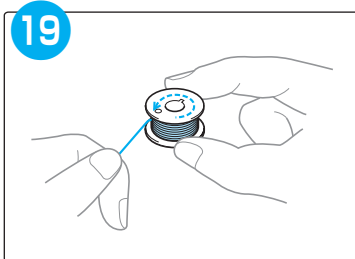
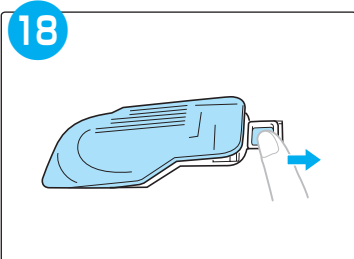
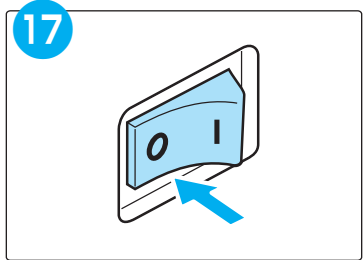
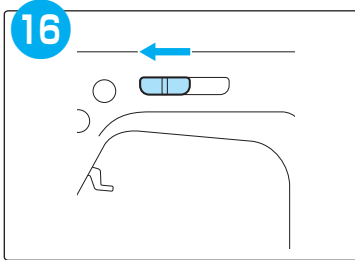
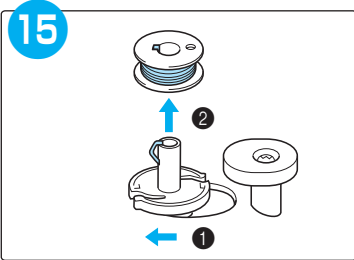
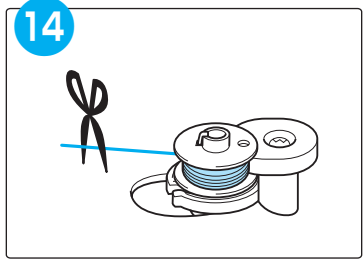
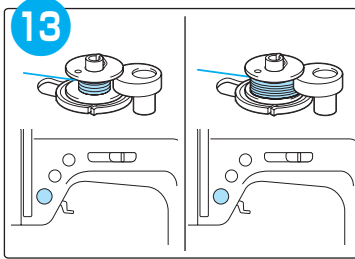
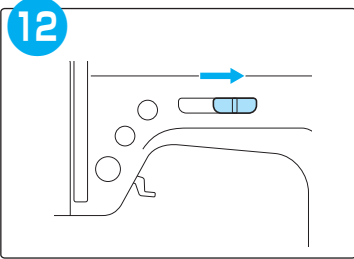
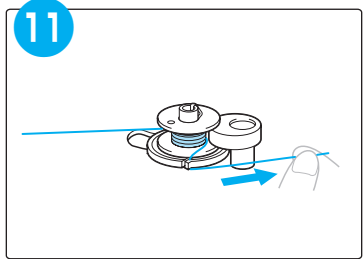
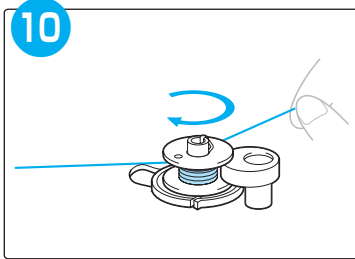
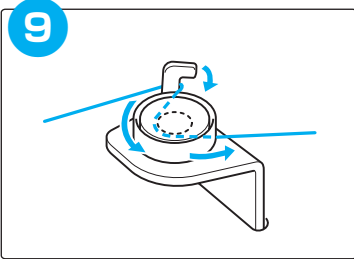
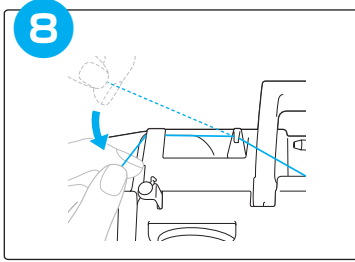
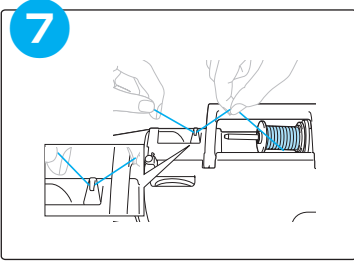
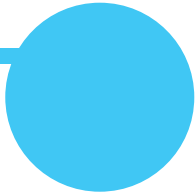



Upper threading

Zavedení horní niti
Felsőszál befűzése
Nawlekanie górnej nici
Вдяване отгоре
Înfilarea firului superior

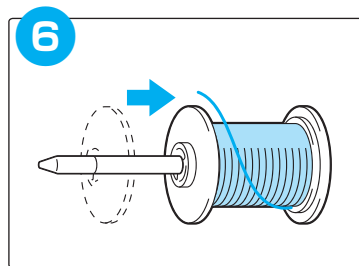
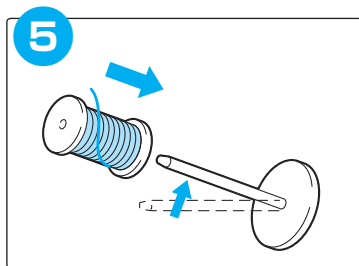
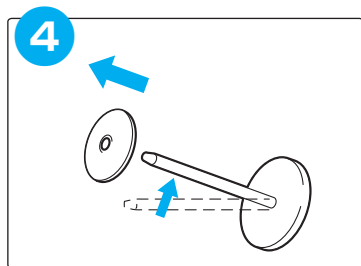
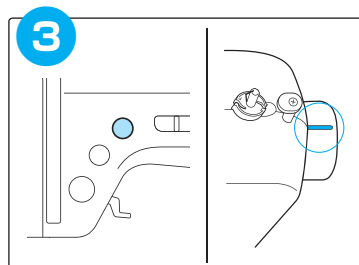
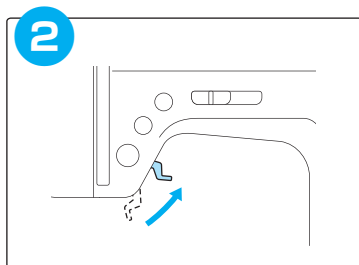
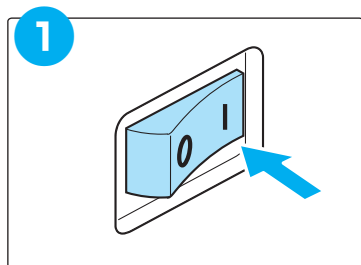
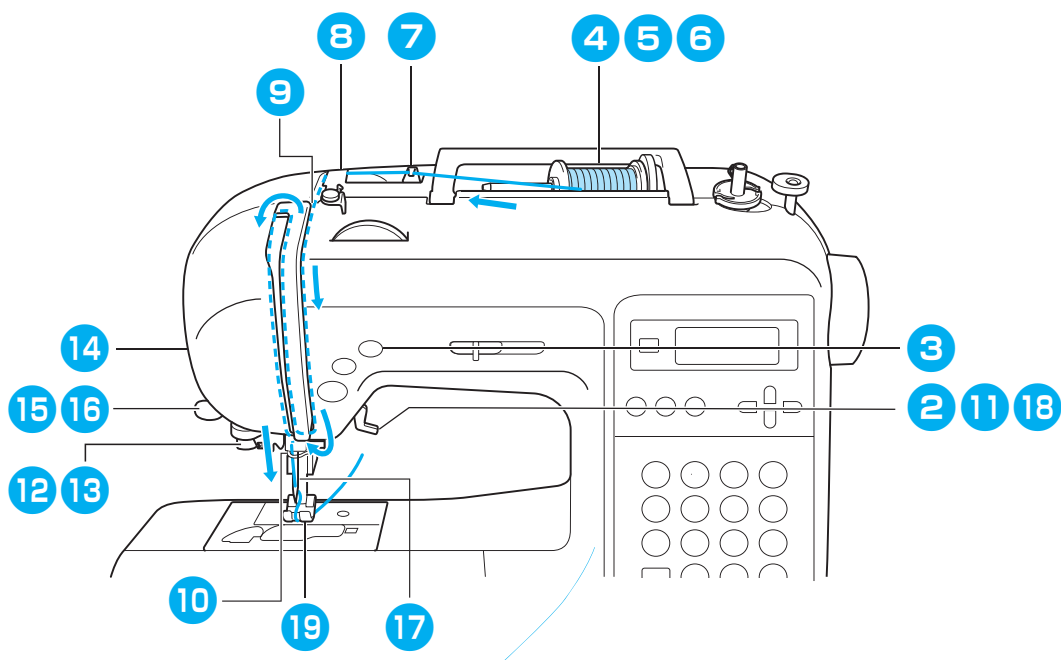

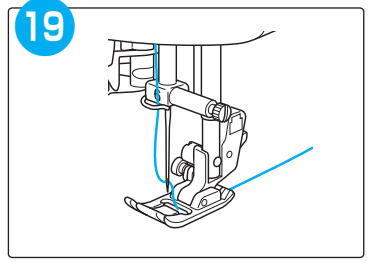
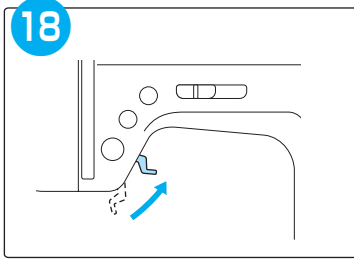
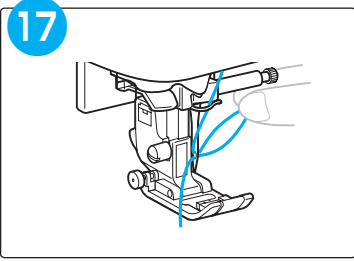
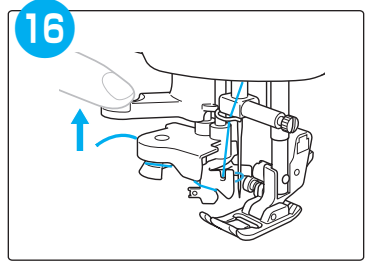
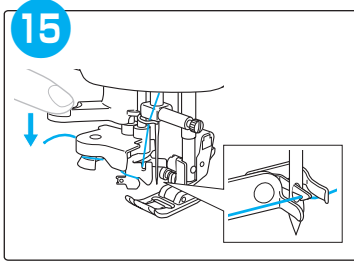
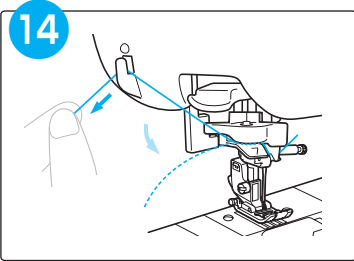
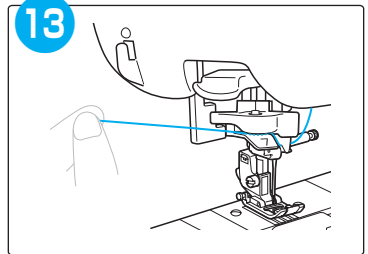
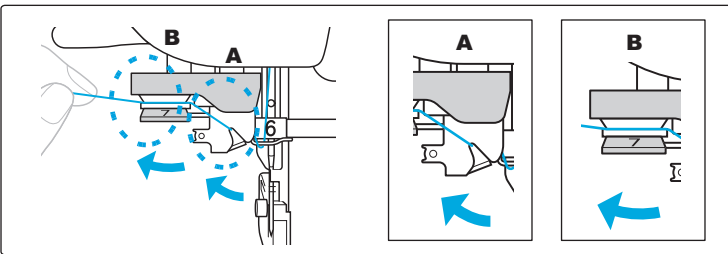
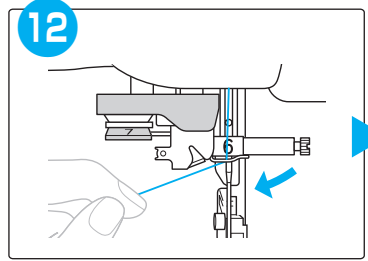
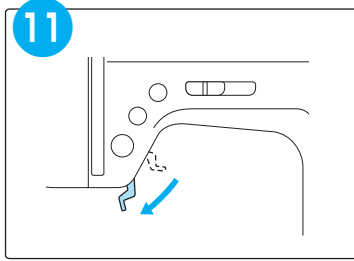
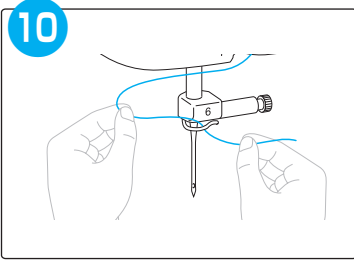
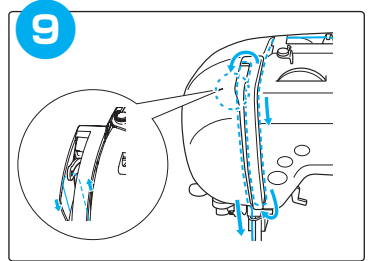
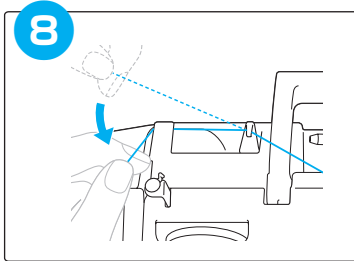
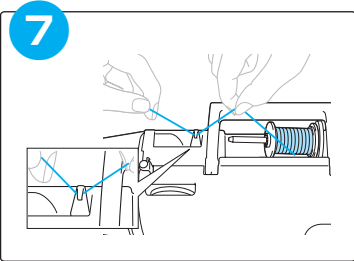

Selecting stitch patterns

Výběr typů stehů
 Öltési minták kiválasztása
 Wybieranie wzorów ściegów
 Избирание на шаблони на шев
 Selectarea modelelor de cusături

Preset utility stitch/ saved pattern

Přednastavený užitkový
 steh/
 uložený vzor

Előre beállított
 rögzítőöltés/
 mentett minta

Wbudowany ścieg
 użytkowy/
 zapisany wzór

Предварително зададен
 помощен шев/
 запаметен шаблон

Preparate cusături
 utilitare/
 model salvat

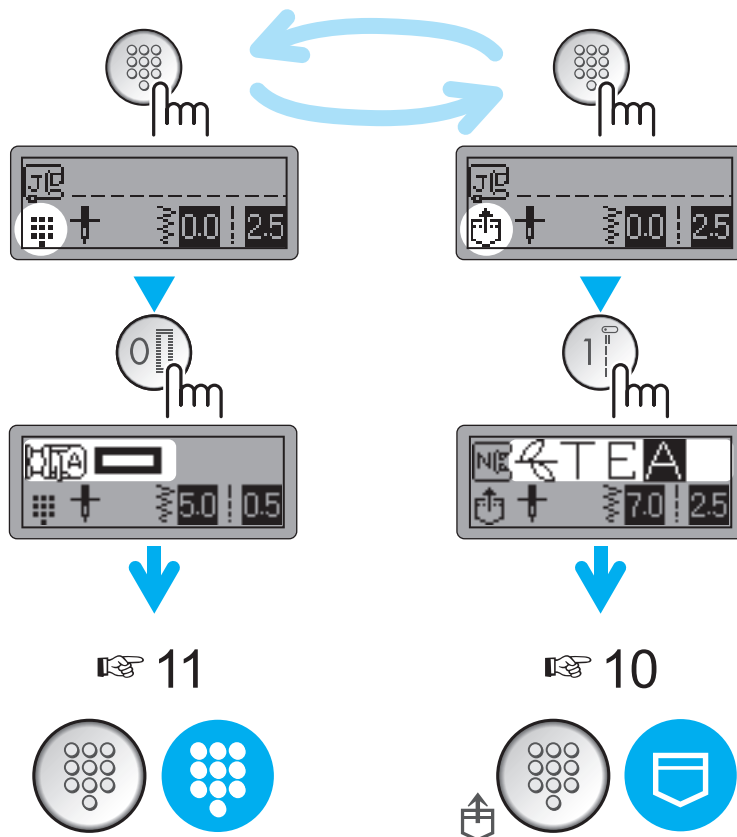

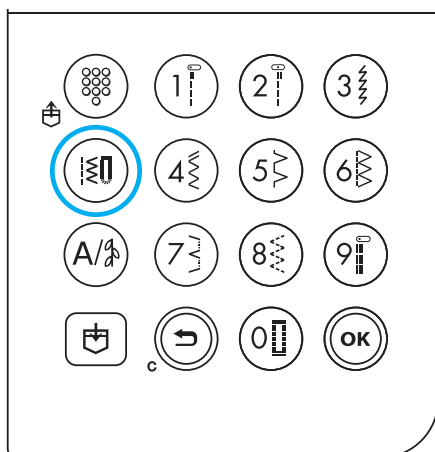
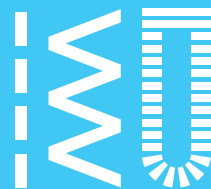

Utility stitches

Užitkové stehy
Rögzítőöltések
Ściegi użytkowe
Помощни шевове
Cusături utilitare

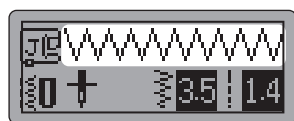
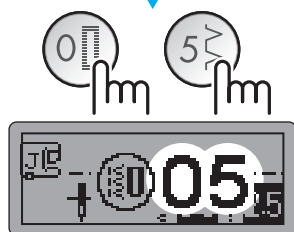
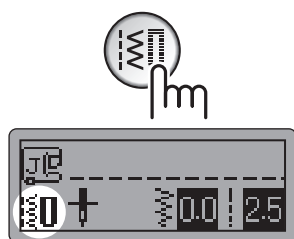

11



A/g

Utility decorative stitches

Užitkové dekorativní stehy

Díszítő rögzítőöltések

Ściegi użytkowe ozdobne

Помощни декоративни шевове

Cusături decorative utilitare

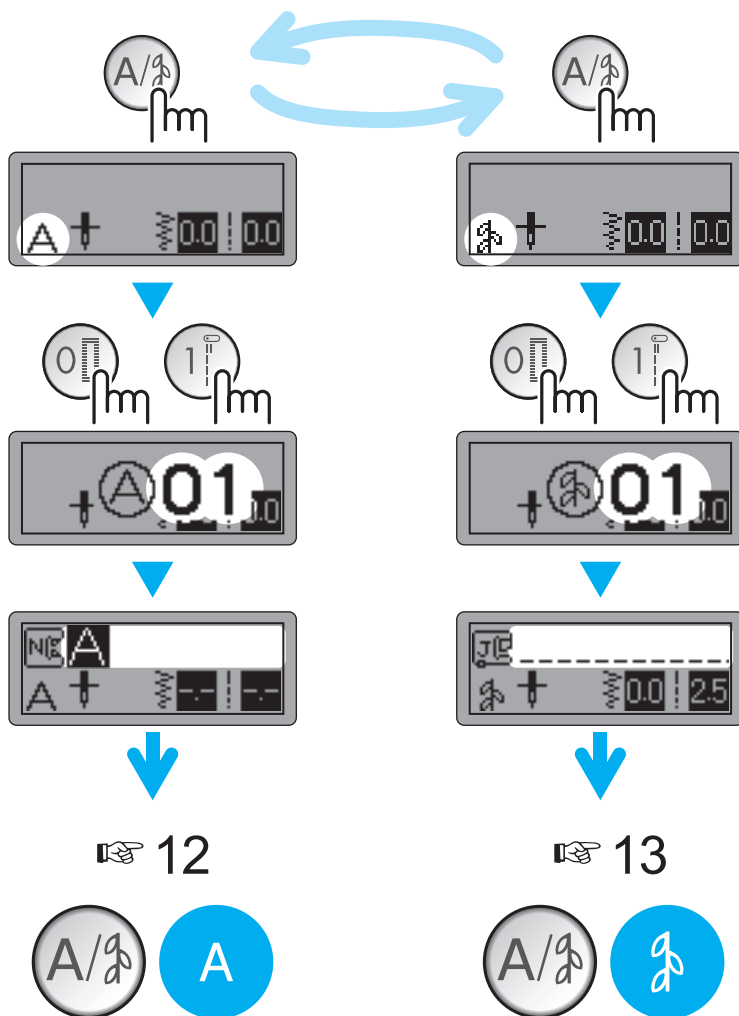
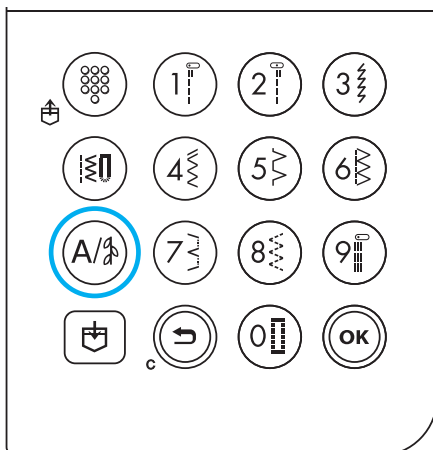

Combining and saving patterns

Kombinace a ukládání vzorů
Minták kombinálása és mentése
Łączenie i zapisywanie wzorów
Комбиниране и запаметяване на шаблони
Combinarea și salvarea modelelor



Example: Příklad: Pélida: Przykład: Пример: Exemplu:

 TEA

Combining patterns Kombinace vzorů/ Minták kombinálása/ Łączenie wzorów/ Комбиниране на шаблони/
Combinarea modelelor

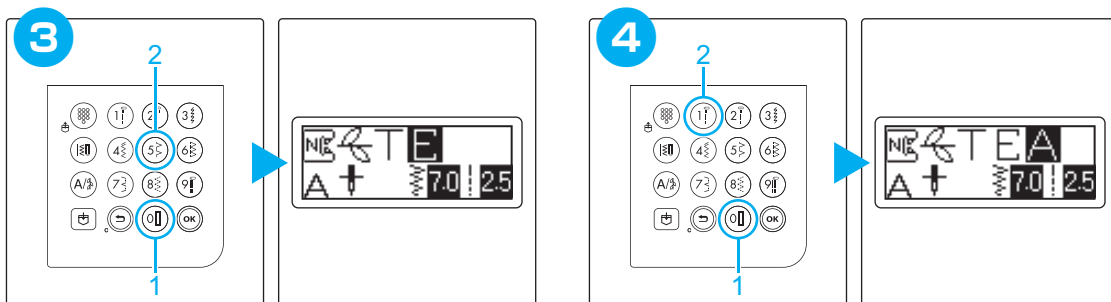
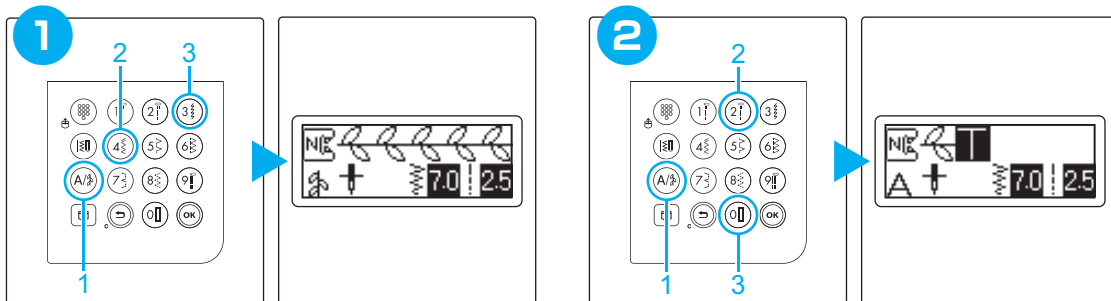

Saving patterns Ukládání vzorů/ Minták mentése/ Zapisywanie wzorów/ Запаметяване на шаблони/
Salvarea modelelor

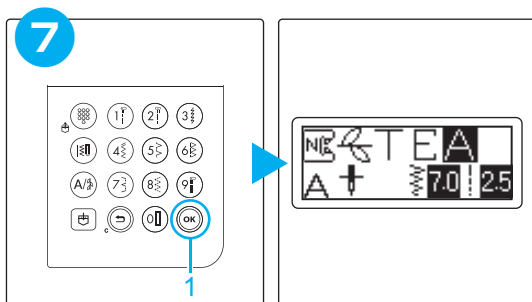
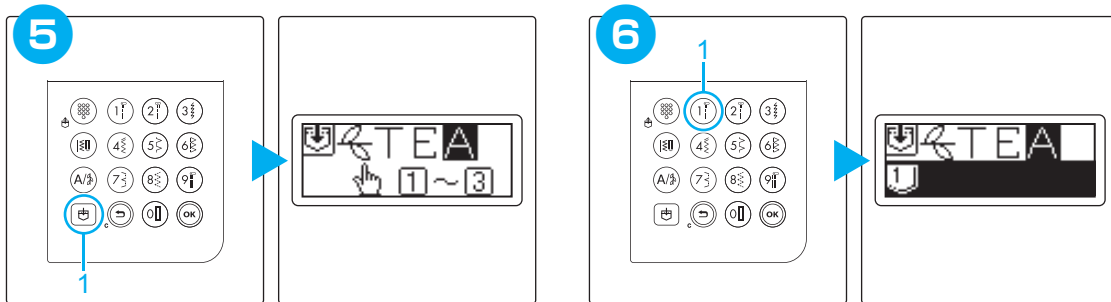



Saved patterns' memo

Paměť uložených vzorů
Mentett minták emlékeztetője
Przypomnienie zapisanych wzorów
Бележка за запаметени шаблони
Memo modele salvate



Saved patterns Uložené vzory/ Elmentett minták/ Zapisane wzory/ Запаметени шаблони/
Modele salvate

Summary of stitch patterns

Shrnutí vzorů stehů

Öltési minták összegzése

Podsumowanie zapisanych wzorów

Кратко изложение на шаблони на шев

Lista cu modelele de cusături



Preset utility stitch

Přednastavený užitkový steh/ Előre beállított rögzítőöltés/
Wbudowany ścieg użytkowy/ Предварительно задан помощен шев/ Presetare cusături utilitare

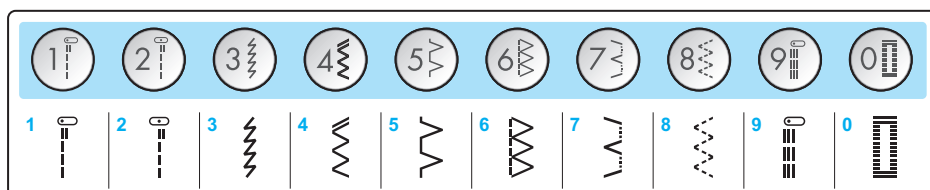

Utility stitches

Užitkové stehy/ Rögzítőöltések/ Ściegi użytkowe/ Помощни шевове/
Cusături utilitare

00	01	02	03	04	05	06	07	08	09
00	01	02	03	04	05	06	07	08	09
10	11	12	13	14	15	16	17	18	19
20	21	22	23	24	25	26	27	28	29
30	31	32	33	34	35	36	37	38	39
40	41	42	43	44	45	46	47	48	49
50	51	52	53	54	55	56	57	58	59
60	61	62	63	64	65	66	67	68	69
70	71	72	73	74	75	76	77	78	79
80									

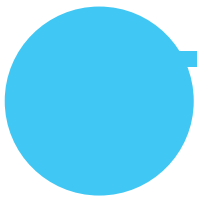

Character stitches Stehy ve tvaru písmen/ Karakteröltések/ Ściegi literowe/
Шевове за цифри и букви/ Cusături pentru monograme

00	01	02	03	04	05	06	07	08	09
00	01	02	03	04	05	06	07	08	09
01	A	B	C	D	E	F	G	H	I
10	J	K	L	M	N	O	P	Q	R
20	T	U	V	W	X	Y	Z	&	?
30	-	0	1	2	3	4	5	6	7
40	9	'	,	.	()	-	Ä	Å
50	Ñ	Ö	Ø	Ç	Ü	β			



Utility decorative stitches Užitočné dekoratívne stehy/ Diszítő rögzítőöltések/
 Ściegi użytkowe ozdobne/ Помощни декоративни шевове/ Csűturi decorative utilitare

00	0	1	2	3	4	5	6	7	8	9
0		01	02	03	04	05	06	07	08	09
1	10	11	12	13	14	15	16	17	18	19
2	20	21	22	23	24	25	26	27	28	29
3	30	31	32	33	34	35	36	37	38	39
4	40	41	42	43	44	45	46	47	48	49
5	50	51	52	53	54	55	56	57	58	59
6	60	61	62							

