

**brother**<sup>®</sup>

**1** *GETTING READY*

---

**2** *SEWING BASICS*

---

**3** *UTILITY STITCHES*

---

**4** *APPENDIX*

---

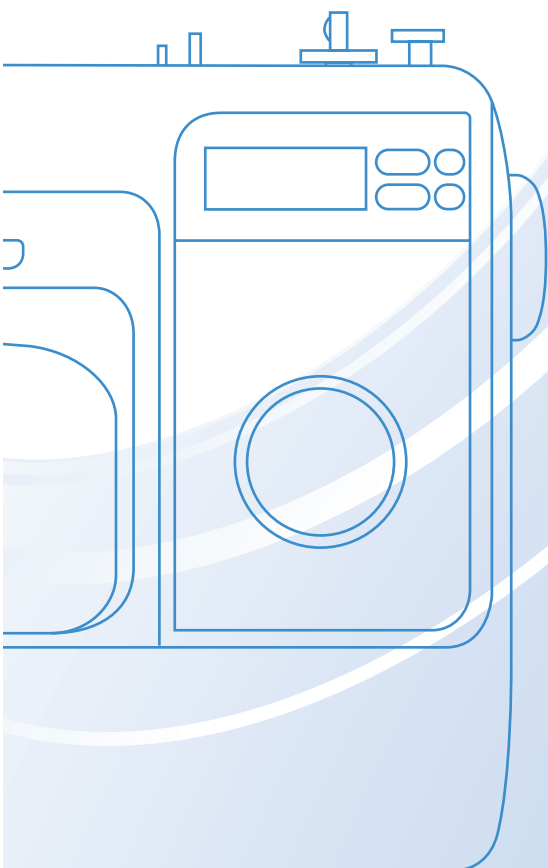

# **Operation Manual**

---

Computerized Sewing Machine



# IMPORTANT SAFETY INSTRUCTIONS

Please read these safety instructions before attempting to use the machine.

**DANGER** - To reduce the risk of electric shock:

**1 Always** unplug the machine from the electrical outlet immediately after using, when cleaning, when making any user servicing adjustments mentioned in this manual, or if you are leaving the machine unattended.

**WARNING** - To reduce the risk of burns, fire, electric shock, or injury to persons.

**2 Always** unplug the machine from the electrical outlet when removing covers, lubricating, or when making any adjustments mentioned in the instruction manual:

- To unplug the machine, switch the machine to the symbol “O” position to turn it off, then grasp the plug and pull it out of the electrical outlet. **Do not** pull on the cord.
- Plug the machine directly into the electrical outlet. Do not use an extension cord.
- **Always** unplug your machine if the power is cut.

**3 Never** operate this machine if it has a damaged cord or plug, if it is not working properly, if it has been dropped or damaged, or water is spilled on the unit. Return the machine to the nearest authorized dealer or service center for examination, repair, electrical or mechanical adjustment. While the machine is stored or in use if you notice anything unusual, such as an odor, heat, discoloration or deformation, stop using the machine immediately and unplug the power cord. When transporting the sewing machine, be sure to carry it by its handle. Lifting the sewing machine by any other part may damage the machine or result in the machine falling, which could cause injuries.

When lifting the sewing machine, be careful not to make any sudden or careless movements, otherwise you may injure your back or knees.

## 4 Always keep your work area clear:

- Never operate the machine with any air openings blocked. Keep ventilation openings of the sewing machine and foot control free from the build up of lint, dust, and loose cloth.
- **Do not** store objects on the foot controller.
- **Do not** use extension cords. Plug the machine directly into the electrical outlet.
- **Never** drop or insert **any** object into **any** opening.
- **Do not** operate where aerosol (spray) products are being used or where oxygen is being administered.
- **Do not** use the machine near a heat source, such as a stove or iron; otherwise, the machine, power cord or garment being sewn may ignite, resulting in fire or an electric shock.
- **Do not** place this sewing machine on an unstable surface, such as an unsteady or slanted table, otherwise the sewing machine may fall, resulting in injuries.

## 5 Special care is required when sewing:

- **Always** pay close attention to the needle. Do not use bent or damaged needles.
- Keep fingers away from **all** moving parts. Special care is required around the machine needle.
- Switch the sewing machine to the symbol "O" position to turn it off when making any adjustments in the needle area.
- **Do not** use a damaged or incorrect needle plate, as it could cause the needle to break.
- **Do not** push or pull the fabric when sewing, and follow careful instruction when freehand stitching so that you do not deflect the needle and cause it to break.

## 6 This machine is **not** a toy:

- Your close attention is necessary when the machine is used by or near children.
- The plastic bag that this sewing machine was supplied in should be kept out of the reach of children or disposed of. Never allow children to play with the bag due to the danger of suffocation.
- **Do not** use outdoors.

## 7 For a longer service life:

- When storing this machine, avoid direct sunlight and high humidity locations. Do not use or store the machine near a space heater, iron, halogen lamp, or other hot objects.
- Use only neutral soaps or detergents to clean the case. Benzene, thinner, and scouring powders can damage the case and machine, and should never be used.
- Always consult the operation manual when replacing or installing any assemblies, the presser feet, needle, or other parts to assure correct installation.

## **8 For repair or adjustment:**

- If the Light unit (light-emitting diode) is damaged, it must be replaced by authorized dealer.
- In the event a malfunction occurs or adjustment is required, first follow the troubleshooting table in the back of the operation manual to inspect and adjust the machine yourself. If the problem persists, please consult your local authorized Brother dealer.

**Use this machine only for its intended use as described in this manual.**

**Use accessories recommended by the manufacturer as contained in this manual.**

**The contents of this manual and specifications of this product are subject to change without notice.**

**For additional product information, visit our web site at [www.brother.com](http://www.brother.com)**

# **SAVE THESE INSTRUCTIONS.**

**This machine is intended for household use.**

---

## FOR USERS IN THE UK, EIRE, MALTA AND CYPRUS ONLY

### IMPORTANT

- In the event of replacing the plug fuse, use a fuse approved by ASTA to BS 1362, i.e. carrying the  mark, rating as marked on plug.
- Always replace the fuse cover. Never use plugs with the fuse cover omitted.
- If the available electrical outlet is not suitable for the plug supplied with this equipment, you should contact your authorized dealer to obtain the correct lead.

### FOR USERS IN AC INPUT 220-240V COUNTRIES AND MEXICO

This appliance is not intended for use by persons (including children) with reduced physical, sensory or mental capabilities, or lack of experience and knowledge, unless they have been given supervision or instruction concerning use of the appliance by a person responsible for their safety. Children should be supervised to ensure that they do not play with the appliance.



# Contents

<b>Important Safety Instructions</b> .....	<b>1</b>
<b>Contents</b> .....	<b>6</b>
<b>Introduction</b> .....	<b>8</b>
<b>Names of Machine Parts and Their Functions</b> .....	<b>8</b>
Machine .....	8
Needle and presser foot section .....	9
Operation buttons .....	9
Operation panel .....	10
Flat bed attachment .....	10
<b>Accessories</b> .....	<b>11</b>
Included accessories .....	11
Optional accessories .....	12
<b>1. GETTING READY</b> .....	<b>13</b>
<b>Turning the Machine On/Off</b> .....	<b>13</b>
Power supply precautions .....	13
Turning on the machine .....	14
Turning off the machine .....	14
<b>Preparing for Upper and Lower Threading</b> .....	<b>15</b>
Winding the bobbin .....	15
Installing the bobbin .....	18
Threading the upper thread .....	20
Using the twin needle .....	25
<b>Replacing the Needle</b> .....	<b>27</b>
Needle precautions .....	27
Needle types and their uses .....	28
Checking the needle .....	29
Replacing the needle .....	29
<b>Replacing the Presser Foot</b> .....	<b>31</b>
Presser foot precautions .....	31
Replacing the presser foot .....	31
Removing the presser foot holder .....	32
Using the optional walking foot .....	33
<b>Useful Functions</b> .....	<b>35</b>
Changing the needle stop position .....	35
Changing the initial needle position .....	36
<b>Sewing Cylindrical or Large Pieces</b> .....	<b>37</b>
Stitching cylindrical pieces .....	37
Sewing large pieces of fabric .....	37
<b>2. SEWING BASICS</b> .....	<b>39</b>
<b>Starting to Sew</b> .....	<b>39</b>
Sewing procedure .....	39
Selecting a stitch .....	40
Adjusting the stitch length and width .....	40
Positioning the fabric .....	41
Starting to sew .....	42
Securing the stitching .....	44
Cutting the thread .....	46
Automatically sewing reverse/reinforcement stitches .....	46
Adjusting the thread tension .....	47



<b>Useful Sewing Tips</b> .....	<b>48</b>
Trial sewing .....	48
Changing the sewing direction .....	48
Sewing curves .....	48
Sewing thick fabrics .....	48
Sewing thin fabrics .....	49
Sewing stretch fabrics .....	49
Pulling up the bobbin thread .....	50
<b>3. UTILITY STITCHES</b> .....	<b>51</b>
<b>Overcasting</b> .....	<b>51</b>
Sewing overcasting stitches using zigzag foot “J” .....	52
Sewing overcasting stitches using overcasting foot “G” .....	52
<b>Basic Stitching</b> .....	<b>53</b>
<b>Blind Hem Stitching</b> .....	<b>54</b>
<b>Buttonhole Stitching</b> .....	<b>56</b>
Button sewing .....	61
<b>Zipper Insertion</b> .....	<b>63</b>
Inserting a centered zipper .....	63
Inserting a side zipper .....	64
<b>Sewing Stretch Fabrics and Elastic Tape</b> .....	<b>67</b>
Stretch stitching .....	67
Elastic attaching .....	67
<b>Appliqué, Patchwork and Quilt Stitching</b> .....	<b>69</b>
Appliqué stitching .....	70
Patchwork (crazy quilt) stitching .....	70
Piecing .....	71
Quilting .....	71
Free-motion quilting .....	72
<b>Reinforcement Stitching</b> .....	<b>74</b>
Triple stretch stitching .....	74
Bar tack stitching .....	75
<b>Decorative stitching</b> .....	<b>77</b>
Fagoting .....	78
Scallop stitching .....	78
Smocking .....	79
Shell tuck stitching .....	79
Joining .....	80
Heirloom stitching .....	80
Using the side cutter (optional) .....	83
<b>4. APPENDIX</b> .....	<b>87</b>
<b>Stitch settings</b> .....	<b>87</b>
Utility stitches .....	87
<b>Maintenance</b> .....	<b>91</b>
Cleaning the machine surface .....	91
Cleaning the race .....	91
Removing the needle plate .....	92
<b>Troubleshooting</b> .....	<b>93</b>
<b>Error messages</b> .....	<b>97</b>
<b>Operation beep</b> .....	<b>98</b>
Canceling the operation beep .....	98
<b>Index</b> .....	<b>99</b>

## Introduction

Thank you for choosing this product.

Before using this sewing machine, carefully read "Important Safety Instructions", and then study this manual for the correct operation of the various functions.

In addition, after you have finished reading this manual, store it where it can quickly be accessed for future reference.

## Names of Machine Parts and Their Functions

### Machine

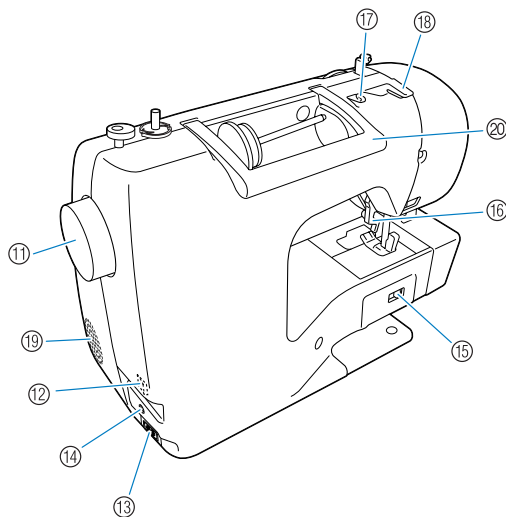
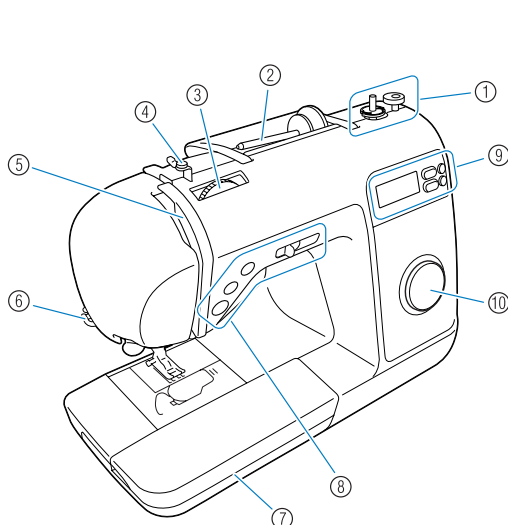

① **Bobbin winder (page 15)**

Use the bobbin winder when winding the bobbin.

② **Spool pin (page 15, 20)**

Place a spool of thread on the spool pin.

③ **Thread tension dial (page 47)**

Use the thread tension dial to adjust the tension of the upper thread.

④ **Bobbin-winding thread guide and pretension disc (page 15)**

Pass the thread under this thread guide and around the pretension disc when winding the bobbin thread.

⑤ **Thread take-up lever (page 23)**

Slide the thread into the thread take-up lever from the right side of slot to the left side of slot.

⑥ **Thread cutter (page 46)**

Pass the threads through the thread cutter to cut them.

⑦ **Flat bed attachment (page 10, 11, 37)**

Store presser feet and bobbins in the flat bed attachment. Remove the flat bed attachment when sewing cylindrical pieces such as sleeve cuffs.

⑧ **Operation buttons and sewing speed controller (page 9)**

Use these buttons and the slide to operate the sewing machine.

⑨ **Operation panel (page 10)**

Use to select stitches and various other stitch settings.

⑩ **Pattern selection dial (page 40)**

Use to select the pattern to sew.

⑪ **Handwheel**

Turn the handwheel toward you to sew one stitch or to raise or lower the needle.

⑫ **Main power switch (page 14)**

Use this switch to turn the sewing machine on and off.

⑬ **Power supply jack (page 14)**

Insert the plug on the power cord into the power supply jack.

⑭ **Foot controller jack (page 43)**

Insert the plug on the end of the foot controller cable into the foot controller jack.

⑮ **Feed dog position switch (page 73)**

Use this switch to lower the feed dogs.

⑯ **Presser foot lever (page 20)**

Raise and lower this lever to raise and lower the presser foot.

⑰ **Thread guide (page 16)**

Pass the thread under this thread guide when winding the bobbin thread and threading the machine.

⑱ **Thread guide cover (page 16)**

Pass the thread under this thread guide when winding the bobbin thread and threading the machine.

⑲ **Air vent**

This vent allows the air surrounding the motor to circulate.

⑳ **Handle**

Carry the sewing machine by its handle when transporting the machine.

## Needle and presser foot section

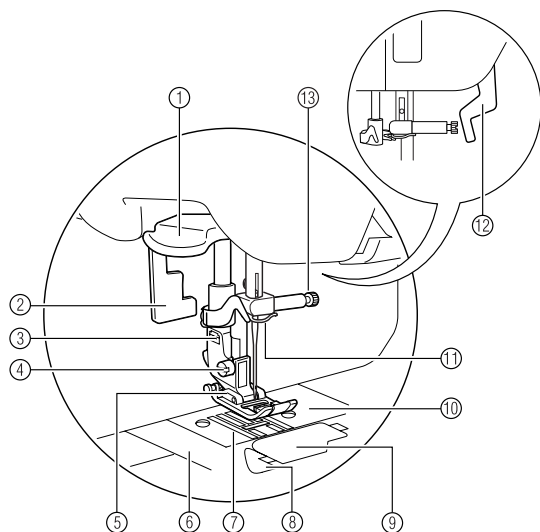

### ① Needle threader lever

Use the needle threader to thread the needle.

### ② Buttonhole lever

Lower the buttonhole lever when sewing buttonholes and bar tacks.

### ③ Presser foot holder

The presser foot is attached to the presser foot holder.

### ④ Presser foot holder screw

Use the presser foot holder screw to hold the presser foot holder in place.

### ⑤ Presser foot

The presser foot applies pressure to the fabric during sewing. Attach the appropriate presser foot for the selected stitch.

### ⑥ Needle plate cover

Remove the needle plate cover to clean the bobbin case and race.

### ⑦ Feed dogs

The feed dogs feed the fabric.

### ⑧ Quick-set bobbin

Begin sewing without pulling up the bobbin thread.

### ⑨ Bobbin cover

Remove the bobbin cover and then insert the bobbin into the bobbin case.

### ⑩ Needle plate

The needle plate is marked with guides to help sew straight seams.

### ⑪ Needle bar thread guide

Pass the upper thread through the needle bar thread guide.

### ⑫ Presser foot lever

Raise and lower this lever to raise and lower the presser foot.

### ⑬ Needle clamp screw

Use the needle clamp screw to hold the needle in place.

## Operation buttons

The operation buttons help you to easily perform various basic sewing machine operations.

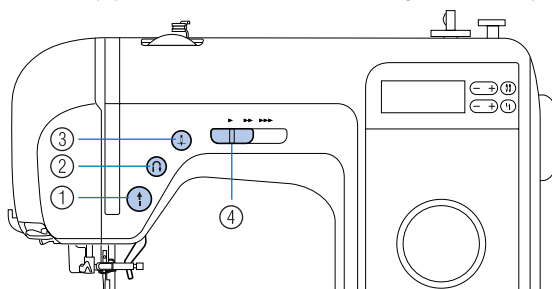

### ① Start/stop button $\updownarrow$

Press the start/stop button to start or stop sewing. The machine sews at a low speed at the beginning of sewing while the button is continuously pressed. When sewing is stopped, the needle is lowered into the fabric. For details, refer to "Starting to sew" (page 42).

### ② Reverse/reinforcement stitch button $\text{fi}$

Press the reverse/reinforcement stitch button to sew reverse stitches or reinforcement stitches. Reverse stitches are sewn by keeping the button pressed down to sew in the opposite direction. Reinforcement stitches are sewn by sewing 3 to 5 stitches on top of each other. For details, refer to "Securing the stitching" (page 44).

### ③ Needle position button $\updownarrow$

Press the needle position button to raise or lower the needle. Pressing the button twice sews one stitch.

### ④ Sewing speed controller

Slide the sewing speed controller to the left or right to adjust the sewing speed.

Slide the sewing speed controller to the left to reduce the sewing speed, or slide the speed controller to the right to increase the sewing speed.

## Operation panel

The operation panel, located on the front of the sewing machine, allows you to select a stitch and specify how the stitch will be sewn.

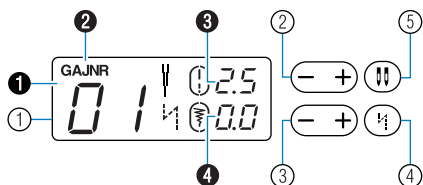

### ① LCD (liquid crystal display)

The number of the selected stitch (①), the presser foot to be used (②), the stitch length (mm) (③), and the stitch width (mm) (④) are displayed here.

### ② Stitch length key (page 40)

Use to adjust the length of the stitch. (Press the “-” side for a shorter stitch length, or press the “+” side for a longer stitch length.)

### ③ Stitch width key (page 41)

Use to adjust the width of the stitch. (Press the “-” side for a more narrow stitch width, or press the “+” side for a wider stitch width.)

### ④ Automatic reverse/reinforcement stitch key (page 46)

The sewing machine can be set to automatically sew reverse or reinforcement stitches at the beginning and end of the stitching.

### ⑤ Needle mode selection key (single/twin) (page 25)

Press this key to select the twin needle sewing setting. Each time this key is pressed, the setting switches between that for single needle sewing and for twin needle sewing.

## Flat bed attachment

The accessories are stored in the storage space in the flat bed attachment.

### 1 Swing the lid of the flat bed attachment toward you to open the storage space.

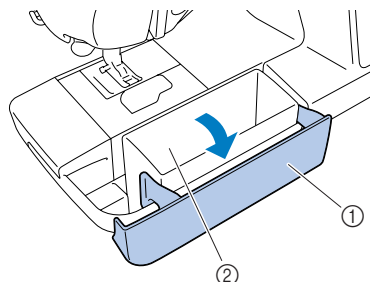

① Flat bed attachment

② Accessory compartment

► The bag of accessories is in the storage space.

### Note

- Place the accessories in the bag before storing them in the flat bed attachment. If the accessories are not placed in the accessory bag when stored in the flat bed attachment, accessories may fall out and be lost or damaged.

## Accessories

After opening the box, check that the following accessories are included. If any item is missing or damaged, contact your dealer.

### Included accessories

The following items should also be included in the box.

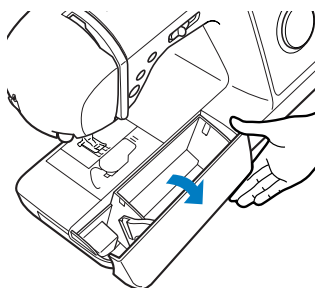

#### Note

(For U.S.A. only)

- Foot controller: Model T  
This foot controller can be used on this machine model NS40.
- The screw for the presser foot holder is available through your authorized dealer.  
(Part code: XA4813-051)

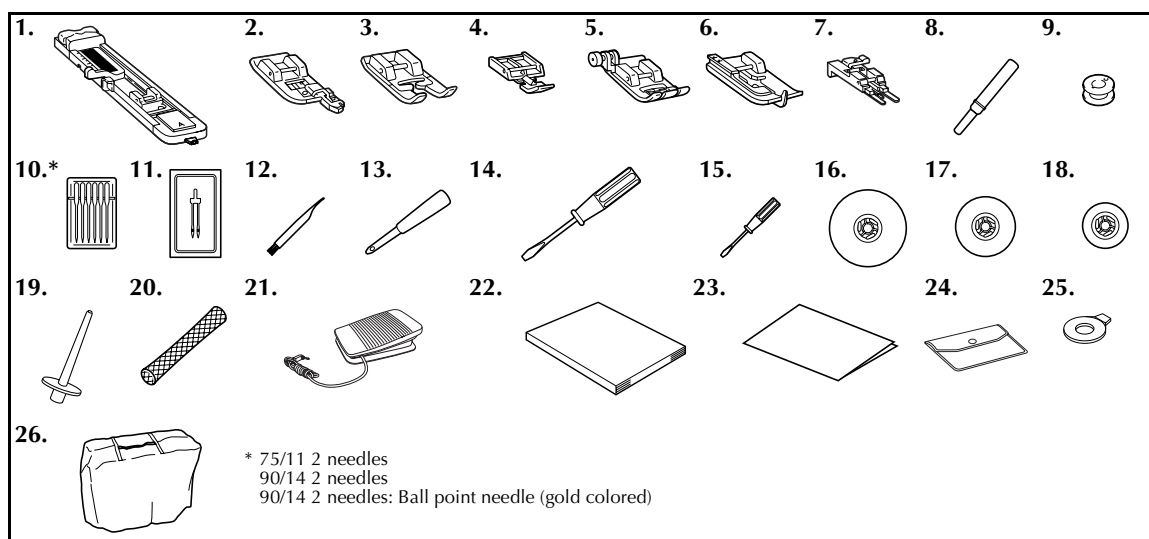

No.	Part Name	Part Code		No.	Part Name	Part Code	
		U.S.A./Canada	Others			U.S.A./Canada	Others
1	Buttonhole foot "A"		XC2691-033	15	Screwdriver (small)		X55468-021
2	Overcasting foot "G"		XC3098-031	16	Spool cap (large)		130012-054
3	Monogramming foot "N"		XD0810-031	17	Spool cap (medium)		XE1372-001
4	Zipper foot "I"		X59370-021	18	Spool cap (small)		130013-154
5	Zigzag foot "J" (on machine)		XC3021-051	19	Extra spool pin		XE2241-001
6	Blind stitch foot "R"		X56409-051	20	Spool net		XA5523-020
7	Button fitting foot "M"		130489-001	21	Foot controller		XD0501-021 (EU area)
8	Seam ripper		X54243-051				XC8816-021 (other areas)
9	Bobbin (4)	SA156	SFB (XA5539-151)	22	Operation manual		XE2426-101
10	Needle set		X58358-021	23	Quick reference guide		XE2429-001
11	Twin needle		X59296-121	24	Accessory bag		XC4487-021
12	Cleaning brush		X59476-021	25	Disc-shaped screwdriver		XC1074-051
13	Eyelet punch		135793-001	26	Soft cover		XC1103-022
14	Screwdriver (large)		XC8349-051				

## Optional accessories

The following are available as optional accessories.

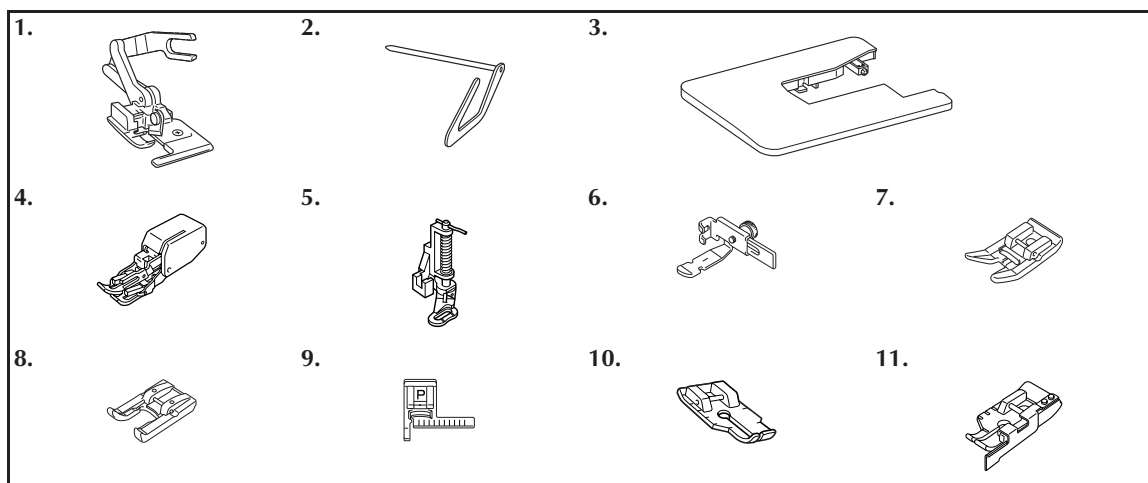

No.	Part Name	Part Code		No.	Part Name	Part Code	
		U.S.A./ Canada	Others			U.S.A./ Canada	Others
1	Side cutter	SA177	F054 (XC3879-002)	7	Non stick foot	SA114	F007N (XC1949-002)
2	Quilting guide	SA132	F016N (XC2215-002)	8	Open toe foot	SA147	F027N (XC1964-002)
3	Wide table	SA552	WT8 (XE2472-001)	9	Stitch guide foot "P"	SA160	F035N (XC1969-002)
4	Walking foot	SA140	F033N (XC2214-002)	10	1/4 inch quilting foot	SA125	F001N (XC1944-052)
5	Quilting foot	SA129	F005N (XC1948-002)	11	1/4 inch quilting foot with guide	SA185	F057 (XC7416-252)
6	Adjustable zipper/piping foot	SA161	F036N (XC1970-002)				



### Memo

- To obtain optional accessories or parts, contact the nearest authorized dealership.
- All specifications are correct at the time of printing. The part codes are subject to change without notice.
- Visit your Brother dealer for a complete listing of optional accessories available for your machine.

# 1 GETTING READY

## Turning the Machine On/Off

This section explains how to turn the sewing machine on and off.

### Power supply precautions

Be sure to observe the following precautions concerning the power supply.



#### WARNING

- Use only regular household electricity for the power source. Using other power sources may result in fire, electric shock, or damage to the machine.
- Make sure that the plugs on the power cord are firmly inserted into the electrical outlet and the power supply jack on the machine.
- Do not insert the plug on the power cord into an electrical outlet that is in poor condition.
- Turn off the main power and remove the plug in the following circumstances:
  - When you are away from the machine
  - After using the machine
  - When the power fails during use
  - When the machine does not operate correctly due to a bad connection or a disconnection
  - During electrical storms



#### CAUTION

- Use only the power cord included with this machine.
- Do not use extension cords or multi-plug adapters with many other appliances plugged in to them. Fire or electric shock may result.
- Do not touch the plug with wet hands. Electric shock may result.
- When unplugging the machine, always turn off the main power first. Always grasp the plug to remove it from the outlet. Pulling on the cord may damage the cord, or lead to fire or electric shock.
- Do not allow the power cord to be cut, damaged, modified, forcefully bent, pulled, twisted, or bundled. Do not place heavy objects on the cord. Do not subject the cord to heat. These things may damage the cord and cause fire or electric shock. If the cord or plug is damaged, take the machine to your authorized dealer for repairs before continuing use.
- Unplug the power cord if the machine is not to be used for a long period of time. Otherwise a fire may result.

## Turning on the machine

Prepare the included power cord.

- 1** Make sure that the sewing machine is turned off (the main power switch is set to “0”), and then plug the power cord into the power supply jack on the right side of the machine.
- 2** Insert the plug of the power cord into a household electrical outlet.

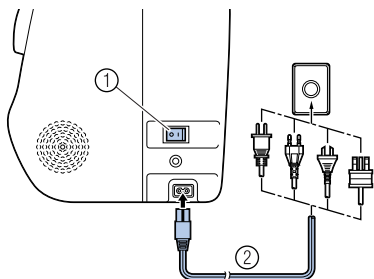

- ① Main power switch  
② Power cord

- 3** Press the right side of the main power switch on the right side of the machine (set it to “1”).

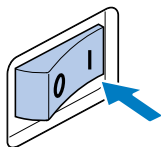

- The sewing lamp and the LCD come on when the machine is turned on.

## Turning off the machine

When you are finished using the sewing machine, turn it off. In addition, before transporting the sewing machine to another location, be sure to turn it off.

- 1** Make sure that the machine is not sewing.
- 2** Press the left side of the main power switch on the right side of the machine (set it to “0”).

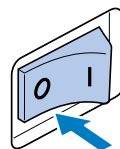

- The sewing lamp and the LCD go off when the machine is turned off.

- 3** Unplug the power cord from the electrical outlet.

Grasp the plug when unplugging the power cord.

- 4** Unplug the power cord from the power supply jack.

### Note

- If a power outage occurs while the sewing machine is being operated, turn off the sewing machine and unplug the power cord. When restarting the sewing machine, follow the necessary procedure to correctly operate the machine.  
(For U.S.A. only)
- This appliance has a polarized plug (one blade wider than the other). To reduce the risk of electrical shock, this plug is intended to fit in a polarized outlet only one way. If the plug does not fit fully in the outlet, reverse the plug. If it still does not fit, contact a qualified electrician to install the proper outlet. Do not modify the plug in any way.



# Preparing for Upper and Lower Threading

## Winding the bobbin

Wind the thread onto the bobbin.

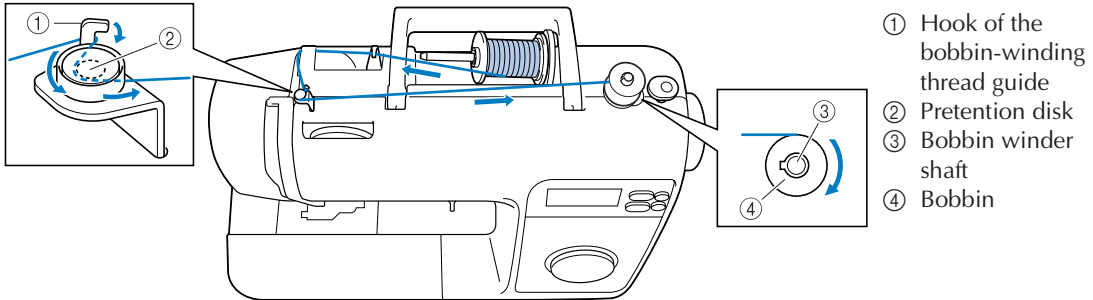

- ① Hook of the bobbin-winding thread guide
- ② Pretention disk
- ③ Bobbin winder shaft
- ④ Bobbin

### CAUTION

- Only use the bobbin (part code: SA156, SFB(XA5539-151)) designed specifically for this sewing machine. Use of any other bobbin may result in injuries or damage to the machine.
- The included bobbin was designed specifically for this sewing machine. If bobbins from other models are used, the machine will not operate correctly. Use only the included bobbin or bobbins of the same type (part code: SA156, SFB(XA5539-151)).

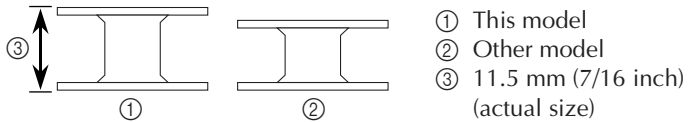

- ① This model
- ② Other model
- ③ 11.5 mm (7/16 inch)  
(actual size)

- 1** Turn on the sewing machine.

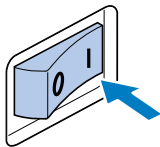

- 2** Place the bobbin on the bobbin winder shaft so that the spring on the shaft fits into the notch in the bobbin.

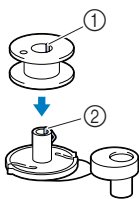

- ① Notch
- ② Bobbin winder shaft spring

- 3** Slide the bobbin winder shaft to the right until it snaps into place.

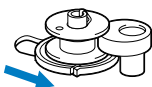

- 4** Swing up the spool pin, and then remove the spool cap.

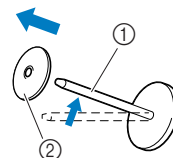

- ① Spool pin
- ② Spool cap

- 5** Fully insert the spool of thread for the bobbin onto the spool pin.

Slide the spool onto the pin so that the spool is horizontal and the thread unwinds to the front at the bottom.

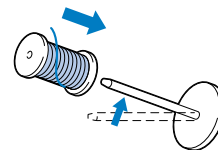

### CAUTION

- If the spool is not positioned so that the thread unwinds correctly, the thread may become tangled around the spool pin.

- 6 Slide the spool cap onto the spool pin.**  
With the slightly rounded side of the spool cap positioned toward the left, slide the spool cap onto the spool pin as far as possible to the right so that the spool is moved to the right end of the spool pin.

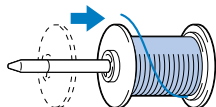
**Memo**

- When sewing with fine, cross-wound thread, use the small spool cap, and leave a small space between the cap and the spool.

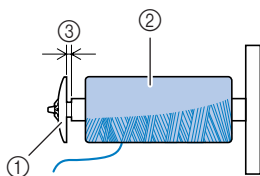

- ① Spool cap (small)
- ② Spool (cross-wound thread)
- ③ Space

- When using thread that winds off quickly, such as transparent nylon thread or metallic thread, place the spool net over the spool before placing the spool of thread onto the spool pin.  
If the spool net is too long, fold it to fit the size of the spool.  
When the spool net is used, the tension of the upper thread will slightly increase. Be sure to check the thread tension. For details, refer to “Adjusting the thread tension” (page 47).

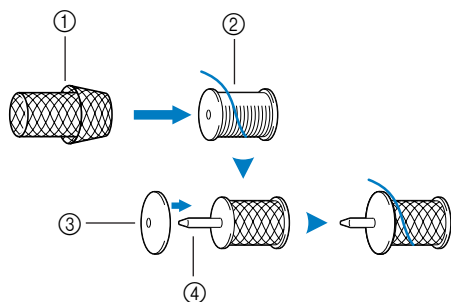

- ① Spool net
- ② Spool
- ③ Spool cap
- ④ Spool pin

- 7 While holding the spool with your right hand, and then pass the thread under the thread guide.**

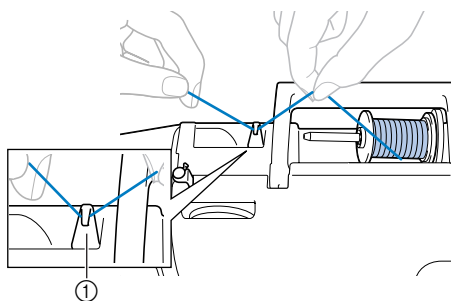

- ① Thread guide

- 8 Pass the thread under the thread guide cover from the back to the front.**

Hold the thread with your right hand so that there is no slack in the thread that is pulled out, and then pass the thread under the thread guide cover with your left hand.

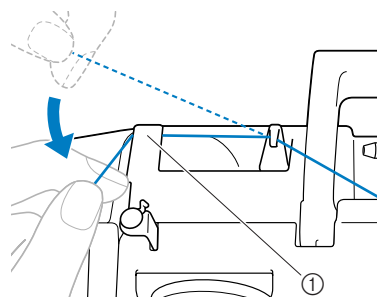

- ① Thread guide cover

- 9 Pull the thread to the right, pass it under the hook of the bobbin-winding thread guide, and then wind the thread counterclockwise between the discs, pulling it in as far as possible.**

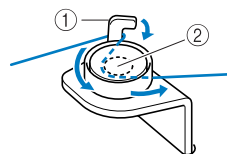

- ① Hook of the bobbin-winding thread guide
- ② Pretension disk

- 10** While using your left hand to hold the thread that was passed through the bobbin-winding thread guide, use your right hand to wind the end of the thread clockwise around the bobbin five or six times.

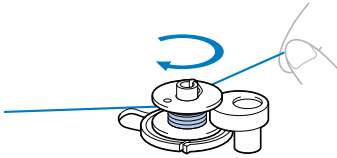

- 11** Pass the end of the thread through the slit in the bobbin winder seat, and then pull the thread to the right to cut it.

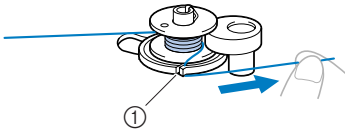

- ① Slit in bobbin winder seat (with built-in cutter)  
▶ The thread is cut to a suitable length.

### **!** CAUTION

- Be sure to cut the thread as described. If the bobbin is wound without cutting the thread using the cutter built into the slit in the bobbin winder seat, the bobbin may not be wound correctly. In addition, the thread may become tangled in the bobbin or the needle may bend or break when the bobbin thread starts to run out.

- 12** Slide the sewing speed controller to the right to increase the bobbin winding speed and slide to left to decrease.

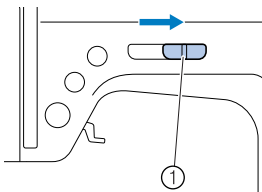

- ① Sewing speed controller

- 13** Press **!** (start/stop button) once.

- ▶ The bobbin starts spinning and the thread is wound around the bobbin.

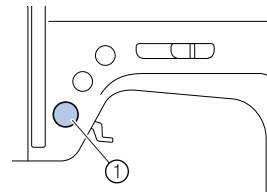

- ① Start/stop button

- 14** When the bobbin winding becomes slow, press **!** (start/stop button) once to stop the machine.

### **!** CAUTION

- When the bobbin winding becomes slow, stop the machine, otherwise the sewing machine may be damaged.

- 15** Cut the thread, slide the bobbin winder shaft to the left, and then remove the bobbin from the shaft.

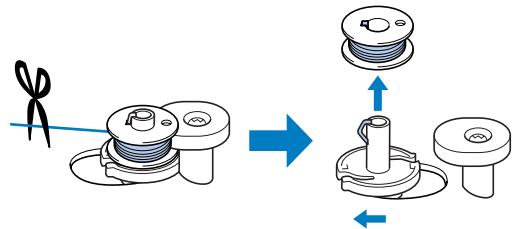

### **!** Memo

- When the sewing machine is started or the handwheel is turned after winding the thread around the bobbin, the machine will make a clicking sound; this is not a malfunction.
- The needle cannot move (sewing is not possible) while the bobbin winder shaft is moved to the right.

## Installing the bobbin

Install the bobbin wound with thread.

### CAUTION

- Use a bobbin that has been correctly wound, otherwise the needle may break or the thread tension will be incorrect.

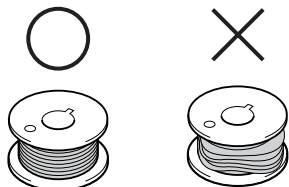

- The bobbin was designed specifically for this sewing machine. If bobbins from other models are used, the machine will not operate correctly. Use only the included bobbin or bobbins of the same type (part code: SA156, SFB (XA5539-151)).

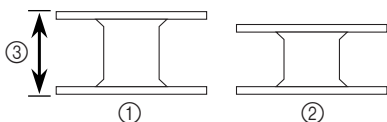

- ① This model
- ② Other model
- ③ 11.5 mm (7/16 inch) (actual size)

- Before installing the bobbin or replacing the needle, be sure to turn off the sewing machine, otherwise injuries may occur if the start/stop button is accidentally pressed and the machine starts sewing.

- 1 Press  (needle position button) once or twice to raise the needle, and then raise the presser foot lever.

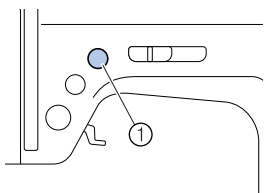

- ① Needle position button

- 2 Turn off the sewing machine (set it to "O").

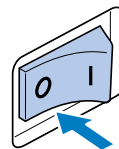

- 3 Slide the latch on the right side of the bobbin cover to the right, and then remove the bobbin cover.

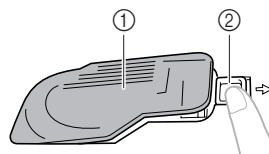

- ① Bobbin cover
- ② Latch

- 4 Insert the bobbin with your right hand so that the thread unwinds to the left side, and then pull the thread firmly under the tab with your left hand.

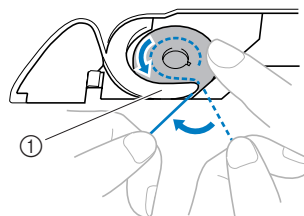

- ① Tab

### CAUTION

- Be sure to hold down the bobbin with your finger and install the bobbin so that the thread unwinds in the correct direction, otherwise the needle may break or the thread tension will be incorrect.

- 5** Lightly hold down the bobbin with your right hand, and guide the thread through the slot, and then pull it toward you to cut it with the cutter.

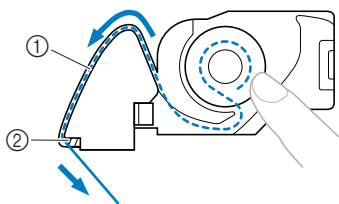

① Slot

② Cutter

► The cutter cuts the thread.

- Make sure that the thread is correctly passed through the flat spring of the bobbin case. If it is not inserted correctly, reinstall the bobbin.

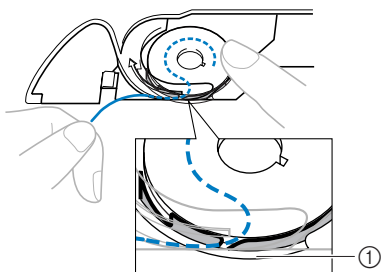

① Flat spring



### Memo

- The direction for feeding the bobbin thread is indicated by marks around the needle plate cover. Be sure to thread the machine as indicated.

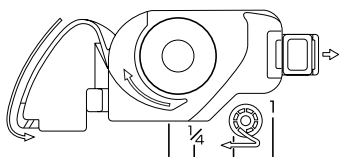

- 6** Reattach the bobbin cover. Insert the tab in the lower-left corner of the bobbin cover (A), and then press down on the right side (B).

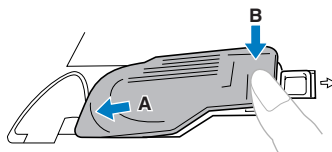

### Memo

- You can begin sewing without pulling up the bobbin thread. If you wish to pull up the bobbin thread before starting to sew, finish threading the machine, and then pull up the thread according to the procedure in "Pulling up the bobbin thread" (page 50).

## Threading the upper thread

In this section, the procedures for installing the spool for the upper thread and threading the needle are described.

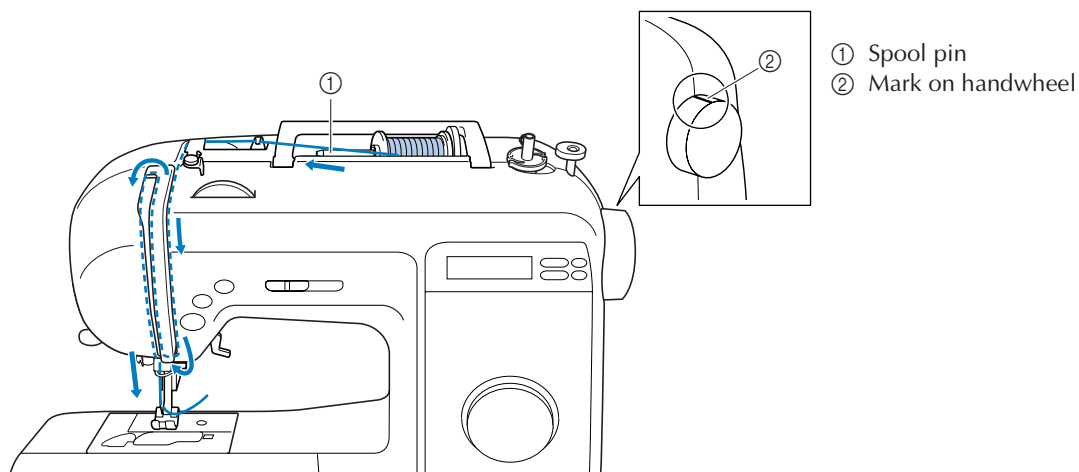

### CAUTION

- When threading the machine, carefully follow the instructions. If the upper threading is not performed correctly, the thread may become tangled and the needle may bend or break.
- The needle threader can be used with sewing machine needles 75/11 through 100/16.
- Use appropriate thread and needle combinations. For details on appropriate needle and thread combinations, refer to “Needle types and their uses” (page 28).
- Thread with a thickness of 130/20 or thicker cannot be used with the needle threader.
- The needle threader cannot be used with the wing needle or the twin needle.
- If the needle threader cannot be used, refer to “Manually threading the needle” (page 24).

- 1 Turn on the sewing machine.

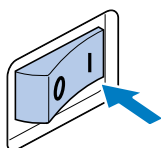

- 2 Raise the presser foot lever.

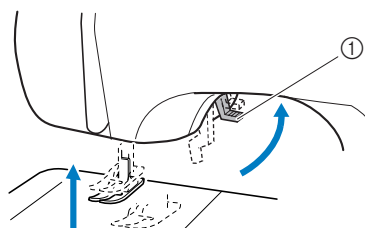

- ① Presser foot lever

### CAUTION

- If the presser foot is not raised, the sewing machine cannot be threaded correctly.

- 3** Press  (needle position button) once or twice to raise the needle.

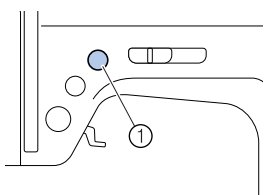

- ① Needle position button
- If the needle is not at the correct height, the sewing machine cannot be threaded. Check that the mark on the handwheel points up as shown in the illustration below. If the handwheel is not in this position, be sure to press the needle position button to raise the needle before continuing the procedure.

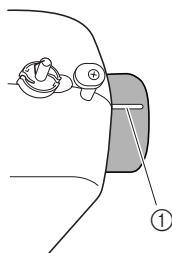

- ① Mark on handwheel

- 4** Swing up the spool pin, and then remove the spool cap.

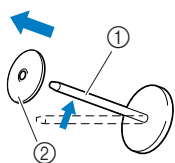

- ① Spool pin  
② Spool cap

- 5** Fully insert the spool for the upper thread onto the spool pin

Slide the spool onto the pin so that the spool is horizontal and the thread unwinds to the front at the bottom.

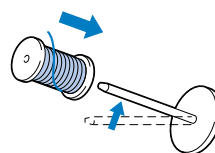

**!** CAUTION

- If the spool is not positioned so that the thread unwinds correctly, the thread may become tangled around the spool pin and the thread or needle may break.
- If the spool cap that is used is smaller than the spool, the thread may catch, for example, on the notch in the spool, or the needle may break.

- 6** Slide the spool cap onto the spool pin.

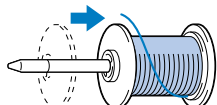

### Memo

- When sewing with fine, cross-wound thread, use the small spool cap, and leave a small space between the cap and the spool.

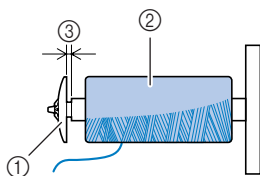

- Spool cap (small)
- Spool (cross-wound thread)
- Space

- When using thread that winds off quickly, such as transparent nylon thread or metallic thread, place the spool net over the spool before placing the spool of thread onto the spool pin.

If the spool net is too long, fold it to fit the size of the spool.

When the spool net is used, the tension of the upper thread will slightly increase. Be sure to check the thread tension. For details, refer to "Adjusting the thread tension" (page 47).

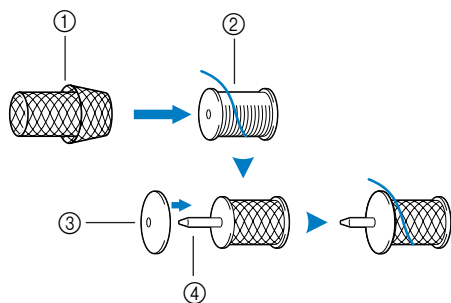

- Spool net
- Spool
- Spool cap
- Spool pin

- 7** While holding the spool with your right hand, and then pass the thread under the thread guide.

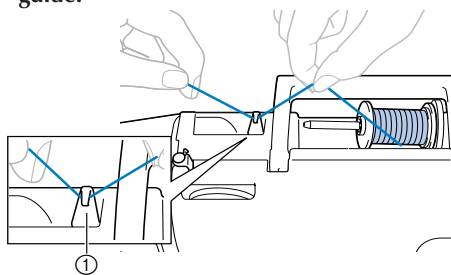

- Thread guide

- 8** Pass the thread under the thread guide cover from the back to the front. Hold the thread with your right hand so that there is no slack in the thread that is pulled out, and then pass the thread under the thread guide cover with your left hand.

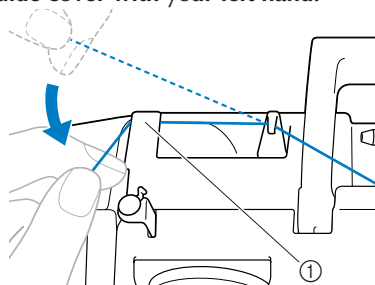

- Thread guide cover

- 9** Thread the machine by guiding the thread along the path indicated by the number on the machine.

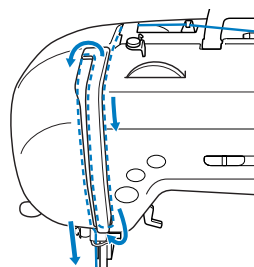



- 10** Slide the thread into the thread take-up lever from the right to the left.

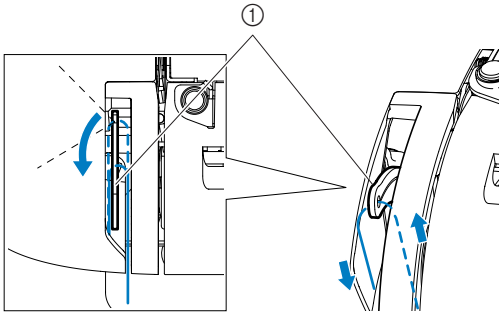

① Thread take-up lever



**Memo**

- If the needle is not raised, the thread take-up lever cannot be threaded. Be sure to press the needle position button to raise the needle before threading the thread take-up lever.

- 11** Pass the thread behind the needle bar thread guide.

The thread can easily be passed behind the needle bar thread guide by holding the thread in your left hand, and pulling the thread into the guide from right to left.

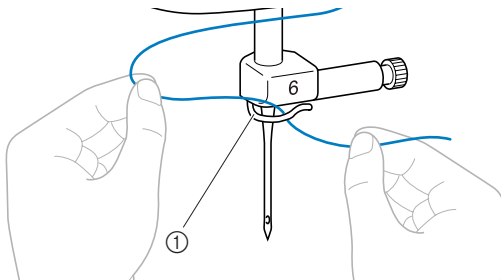

① Needle bar thread guide

- 12** Lower the presser foot lever.

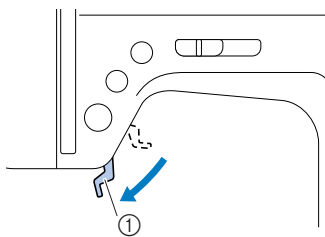

① Presser foot lever

- 13** While lowering the needle threader lever, hook the thread onto the guide.

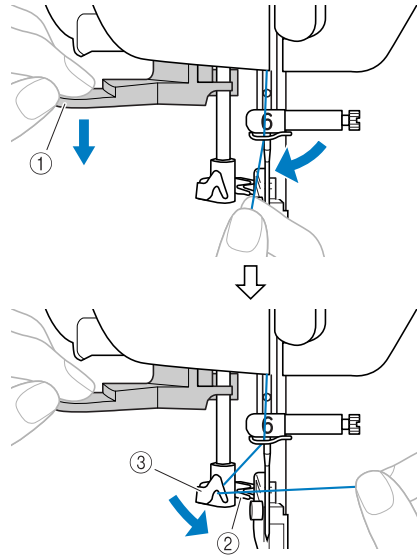

① Needle threader  
② Thread  
③ Guide

- 14** Catch the thread on the hook as shown below.

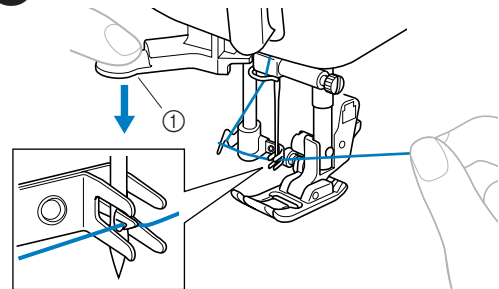

① Needle threader lever

- 15** Raise the needle threader lever, and then pull the end of the thread which passed through the eye of the needle.

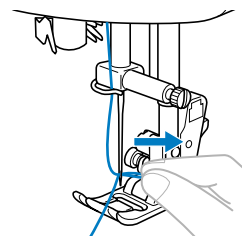

**CAUTION**

- Be careful not to pull on the thread with force or it may bend the needle.

- 16** Raise the presser foot lever, pass the end of the thread through the presser foot, and then pull out about 5 cm (2 inches) of thread toward the rear of the machine.

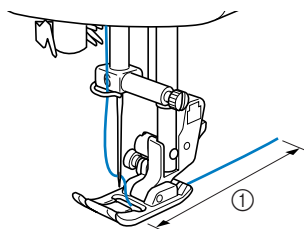

- ① 5 cm (2 inches)  
▶ The upper threading is finished.

### Manually threading the needle

If the needle threader cannot be used, thread the needle as described below.

- 1** Thread the machine to the needle bar thread guide, as described in steps ① through ⑪ of “Threading the upper thread”, and then lower the presser foot lever.

- 2** Turn off the sewing machine.

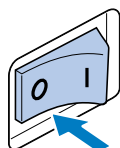

### CAUTION

- Be sure to turn off the sewing machine, otherwise injuries may occur if the start/stop button is accidentally pressed and the machine starts sewing.

- 3** Manually pass the thread through the eye of the needle from front to back.

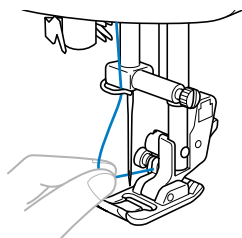

- 4** Raise the presser foot lever.

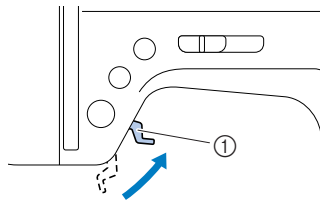

- ① Presser foot lever

- 5** Pass the end of the thread through the presser foot, and then pull out about 5 cm (2 inches) of thread toward the rear of the machine.

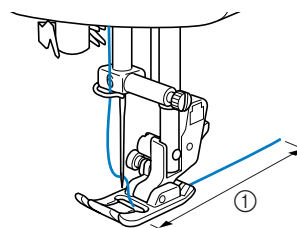

- ① 5 cm (2 inches)

## Using the twin needle

With the twin needle, you can sew two parallel lines of the same stitch with two different threads. Both upper threads should have the same thickness and quality. Be sure to use the twin needle and the extra spool pin.

For details on the stitches that can be sewn with the twin needle, refer to “Stitch settings” (page 87).

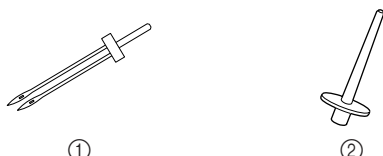

- ① Twin needle
- ② Extra spool pin

### CAUTION

- Only use the twin needle (part code: X59296-121). Use of any other needle may bend the needle or damage the machine.
- Never use bent needles. Bent needles can easily break, possibly resulting in injuries.
- The needle threader cannot be used with the twin needle. If the needle threader is used with the twin needle, the sewing machine may be damaged.

#### 1 Install the twin needle.

- For details on installing a needle, refer to “Replacing the needle” (page 29).

#### 2 Thread the upper thread for the left needle.

- For details, refer to steps ① through ⑩ of “Threading the upper thread” (page 20).

#### 3 Manually thread the left needle with the upper thread.

- Pass the thread through the eye of the needle from the front to the back.

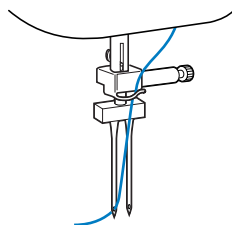

#### 4 Insert the extra spool pin onto the end of the bobbin winder shaft.

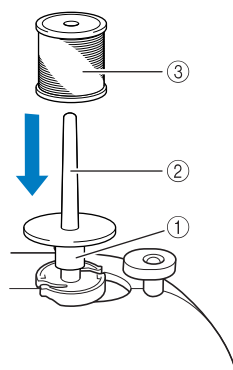

- ① Bobbin winder shaft
- ② Extra spool pin
- ③ Thread spool

#### 5 Install the thread spool and thread the upper thread.



#### Memo

- When setting the thread spool, set it so that the thread winds off from the front of the spool.

#### 6 Thread the upper thread for the right side in the same way that the upper thread for the left side was threaded.

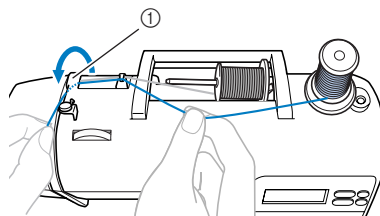

- ① Thread guide cover

- For details, refer to step ① through ⑩ of “Threading the upper thread” (page 20).

#### 7 Without passing the thread through the needle bar thread guide, manually thread the right needle.

- Pass the thread through the eye of the needle from the front to the back.

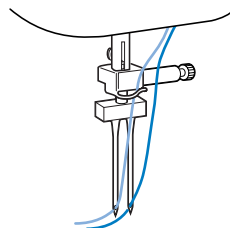

- 8 Attach zigzag foot “J”.**
- For details on changing the presser foot, refer to “Replacing the presser foot” (page 31).

### CAUTION

- When using the twin needle, be sure to attach zigzag foot “J”, otherwise the needle may break or the machine may be damaged.

- 9 Turn on the sewing machine.**

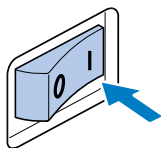

- The LCD comes on.

- 10 Select a stitch.**
- For details on selecting a stitch, refer to “Selecting a stitch” (page 40).
  - For details on the stitches that can be sewn with the twin needle, refer to “Stitch settings” (page 87).

### CAUTION

- After adjusting the stitch width, slowly turn the handwheel toward you (counterclockwise) and check that the needle does not touch the presser foot. If the needle hits the presser foot, the needle may bend or break.

- 11 Press**  (Needle mode selection key).

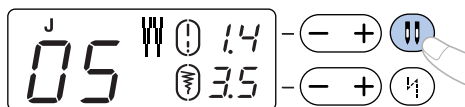

- The twin needle can now be used.
- To return to single needle sewing, press  (Needle mode selection key).
- Even after the sewing machine is turned off, the twin needle setting is not cancelled.

### CAUTION

- When using the twin needle, be sure to select the twin needle setting, otherwise the needle may break or the machine may be damaged.

- 12 Start sewing.**
- For details on starting to sew, refer to “Starting to sew” (page 42).
  - Two lines of stitching are sewn parallel to each other.

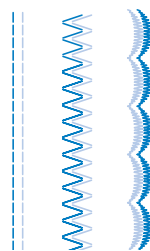

### Note

- When using the twin needle, the stitches may become bunched together, depending on the types of thread and fabric that are used. If this occurs, increase the stitch length. For details on adjusting the stitch length, refer to “Adjusting the stitch length and width” (page 40).

### CAUTION

- When changing the sewing direction, press  (needle position button) to raise the needle from the fabric, and then raise the presser foot lever and turn the fabric. Otherwise the needle may break or the machine may be damaged.
- Do not try turning the fabric with the twin needle left down in the fabric, otherwise the needle may break or the machine may be damaged.

## Replacing the Needle

This section provides information on sewing machine needles.

### Needle precautions

Be sure to observe the following precautions concerning the handling of the needle. Failure to observe these precautions is extremely dangerous, for example, if the needle breaks and fragments are dispersed. Be sure to read and carefully follow the instructions below.



#### CAUTION

- **Only use home sewing machine needles. Use of any other needle may bend the needle or damage the machine.**
- **Never use bent needles. Bent needles can easily break, possibly resulting in injuries.**

## Needle types and their uses

The sewing machine needle that should be used depends on the fabric and thread thickness. Refer to the following table when choosing the thread and needle appropriate for the fabric that you wish to sew.

Fabric Type/Application		Thread		Size of Needle
		Type	Weight	
Medium weight fabrics	Broadcloth	Cotton thread	60–80	75/11–90/14
	Taffeta	Synthetic thread		
	Flannel, Gabardine	Silk thread	50	
Thin fabrics	Lawn	Cotton thread	60–80	65/9–75/11
	Georgette	Synthetic thread		
	Challis, Satin	Silk thread	50	
Thick fabrics	Denim	Cotton thread	30–50	90/14–100/16
	Corduroy	Synthetic thread	50–60	
	Tweed	Silk thread		
Stretch fabrics	Jersey	Thread for knits	50–60	Ball point needle (golden colored) 75/11–90/14
	Tricot			
Easily frayed fabrics		Cotton thread	50–80	65/9–90/14
		Synthetic thread		
		Silk thread	50	
For top-stitching		Synthetic thread	50–60	90/14–100/16
		Silk thread		



### Memo

- The lower the thread number, the thicker the thread, and the higher the needle number, the thicker the needle.
- Use the ball point needle when sewing on stretch fabrics or fabrics where skipped stitches easily occur.
- Use a 90/14 to 100/16 needle with transparent nylon threads, regardless of the fabric being sewn.



### CAUTION

- The appropriate fabric, thread and needle combinations are shown in the table above. If the combination of the fabric, thread and needle is not correct, particularly when sewing thick fabrics (such as denim) with thin needles (such as 65/9 to 75/11), the needle may bend or break. In addition, the stitching may be uneven or puckered or there may be skipped stitches.

## Checking the needle

Sewing with a bent needle is extremely dangerous since the needle may break while the machine is being operated.

Before using the needle, place the flat side of the needle on a flat surface and check that the distance between the needle and the flat surface is even.

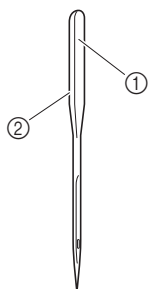

- ① Flat side
- ② Needle type marking

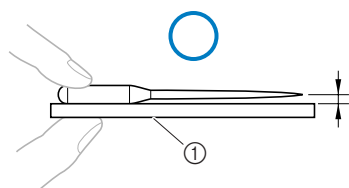

- ① Flat surface

If the distance between the needle and the flat surface is not even, the needle is bent. Do not use a bent needle.

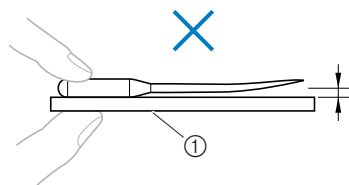

- ① Flat surface

## Replacing the needle

Replace the needle as described below. Use the screwdriver and a correct needle, as described in "Checking the needle".

- 1 Press  $\oplus$  (needle position button) once or twice to raise the needle.

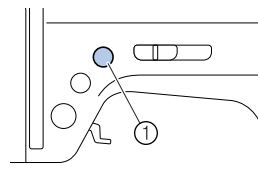

- ① Needle position button

- 2 Turn off the sewing machine.

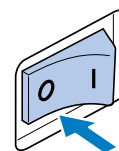

### ! CAUTION

- Before replacing the needle, be sure to turn off the sewing machine, otherwise injuries may occur if the start/stop button is accidentally pressed and the machine starts sewing.

- 3 Lower the presser foot lever.

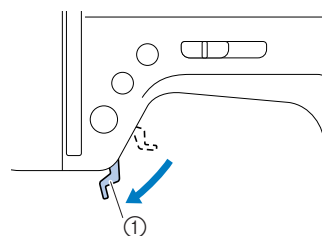

- ① Presser foot lever

### ! CAUTION

- Before replacing the needle, place fabric or paper under the presser foot to prevent the needle from falling into the hole in the needle plate.

#### 4 Loosen the needle clamp screw and remove the needle.

Hold the needle with your left hand, and then turn the screwdriver counterclockwise with your right hand.

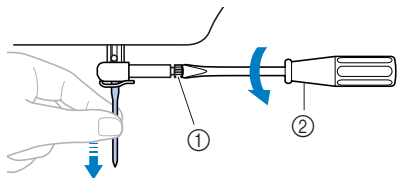

① Needle clamp screw

② Screwdriver

- Do not apply extreme force when loosening or tightening the needle clamp screw, otherwise damage to the machine may result.

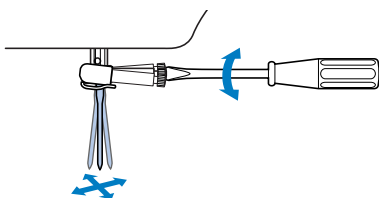

#### 5 With the flat side of the needle toward the rear of the machine, insert the needle until it touches the needle stopper.

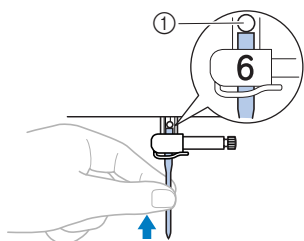

① Needle stopper

#### 6 While holding the needle with your left hand, tighten the needle clamp screw.

Turn the screwdriver clockwise.

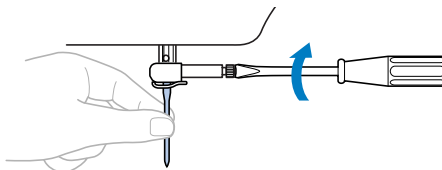

Install the twin needle in the same way.

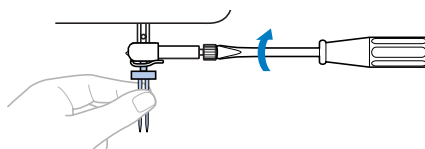

#### CAUTION

- Be sure to insert the needle until it touches the needle stopper and securely tighten the needle clamp screw with the screwdriver, otherwise the needle may break or damage may result.



# Replacing the Presser Foot

## Presser foot precautions

Be sure to observe the following precautions concerning the presser feet.

### CAUTION

- Use the presser foot appropriate for the type of stitch that you wish to sew, otherwise the needle may hit the presser foot, causing the needle to bend or break.
- Only use presser feet designed specifically for this sewing machine. Use of any other presser foot may result in injuries or damage to the machine.

## Replacing the presser foot

Replace the presser foot as described below.

- 1 Press  (needle position button) once or twice to raise the needle.

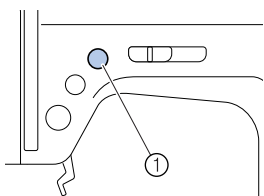

① Needle position button

- 2 Turn off the sewing machine.

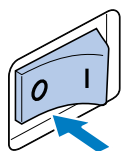

### CAUTION

- Before replacing the presser foot, be sure to turn off the sewing machine, otherwise injuries may occur if the start/stop button is accidentally pressed and the machine starts sewing.
- Make sure that the presser foot is installed in the correct direction, otherwise the needle may strike the presser foot, causing it to break and cause injuries.

- 3 Raise the presser foot lever.

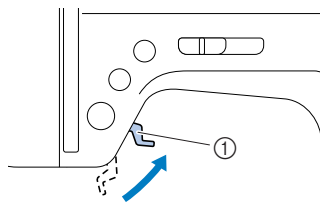

① Presser foot lever

- 4 Press the black button at the back of the presser foot holder to remove the presser foot.

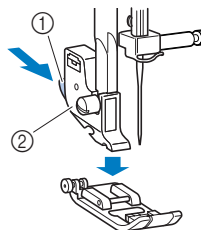

① Black button  
② Presser foot holder

- 5** Place the presser foot to be installed below the holder so that the presser foot pin is aligned with the notch in the holder.

Position the presser foot so the letter indicating the presser foot type (J, A, etc.) is positioned to be read.

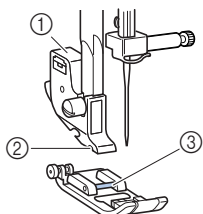

- ① Presser foot holder
- ② Notch
- ③ Pin



### Memo

- The code for the presser foot to be used with each stitch appears in the LCD. For details on selecting a stitch, refer to "Selecting a stitch" (page 40).

- 6** Slowly lower the presser foot lever so that the presser foot pin snaps into the notch in the presser foot holder.

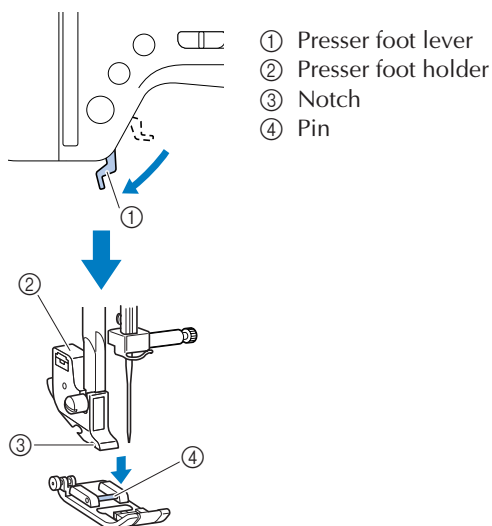

▶ The presser foot is attached.

- 7** Raise the presser foot lever to check that the presser foot is securely attached.

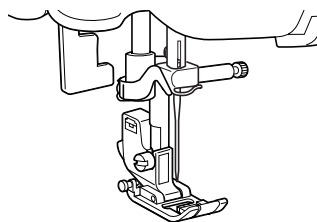

## Removing the presser foot holder

Remove the presser foot holder when cleaning the sewing machine or when installing the optional walking foot.

- 1** Remove the presser foot.
- For details, refer to "Replacing the presser foot" (page 31).

- 2** Loosen the presser foot holder screw, and then remove the presser foot holder.
- Turn the screwdriver counterclockwise.

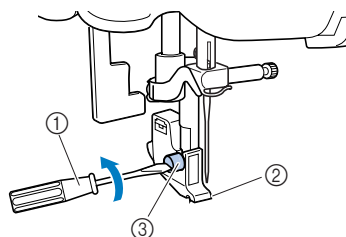

- ① Screwdriver
- ② Presser foot holder
- ③ Screw

## ■ Attaching the presser foot holder

- 1 Align the presser foot holder with the presser bar.

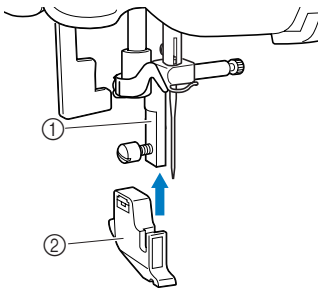

- 1 Presser bar
- 2 Presser foot holder

- 2 Hold up the presser foot holder with your right hand, and tighten the screw. With your left hand, turn the screwdriver clockwise.

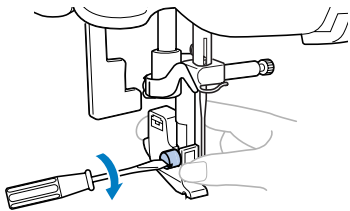

### Note

- If the presser foot holder is not correctly installed, the thread tension will be incorrect.



### CAUTION

- Be sure to securely tighten the presser foot holder screw, otherwise the presser foot holder may fall off and the needle may strike it, causing the needle to bend or break.

## Using the optional walking foot

With the optional walking foot, both pieces of fabric are fed evenly by the feed dogs and the teeth on the presser foot. This is useful when sewing fabrics that are hard to feed such as vinyl and leather and when sewing fabrics that easily slip such as velvets or when quilting.

Use the screwdriver to attach the walking foot.

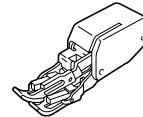

## ■ Attaching the walking foot

- 1 Remove the presser foot holder.
  - For details, refer to “Removing the presser foot holder” (page 32).
- 2 Hook the connecting fork of the walking foot onto the needle clamp screw.

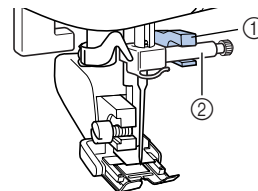

- 1 Connecting fork
- 2 Needle clamp screw

- ③ Lower the presser foot lever, insert the presser foot holder screw, and then tighten the screw with the screwdriver.

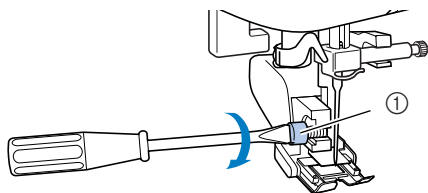

① Presser foot holder screw

### CAUTION

- Be sure to securely tighten the screw with the screwdriver, otherwise the needle may touch the presser foot, causing it to bend or break.
- Before starting to sew, slowly turn the handwheel toward you (counterclockwise) and check that the needle does not touch the presser foot. If the needle hits the presser foot, the needle may bend or break.



### Note

- When sewing with the walking foot, sew at a speed between slow and medium.

### ■ Removing the walking foot

- ① Press  $\oplus$  (needle position button) once or twice to raise the needle.

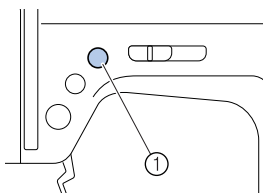

① Needle position button  
▶ The needle is raised.

- ② Turn off the sewing machine.

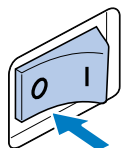

- ③ Raise the presser foot lever.

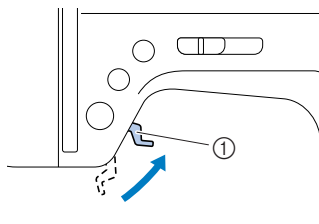

① Presser foot lever  
▶ The presser foot is raised.

- ④ With a screwdriver, loosen the presser foot holder screw, and then remove the walking foot.

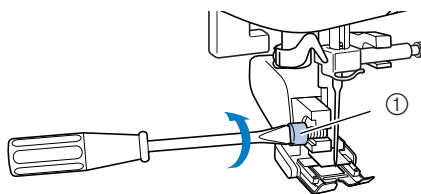

① Presser foot holder screw

- ⑤ Attach the presser foot holder.
- For details, refer to “Removing the presser foot holder” (page 32).



### Memo

- Only the straight stitch (with reinforcement stitching) and the zigzag stitch can be used with the walking foot. For details on the stitches, refer to “Stitch settings” (page 87).
- The optional walking foot is available through your Brother dealer.

## Useful Functions

Functions useful in improving sewing efficiency are described below.

### Changing the needle stop position

Normally, the sewing machine is set to leave the needle in the fabric when sewing is stopped. Instead, the machine can be set to leave the needle raised when sewing is stopped.

- 1 Turn off the sewing machine.

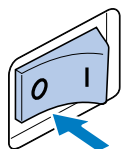

- 2 While pressing  (automatic reverse/reinforcement stitch key), turn on the sewing machine.

When machine beeps twice, release the automatic reverse/reinforcement stitch key.

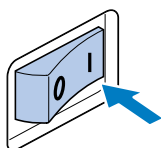
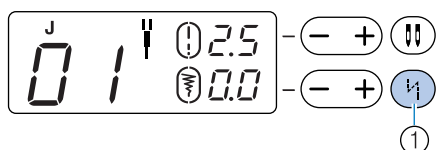

- ① Automatic reverse/reinforcement stitch key
- ▶ The needle stop position changes to the raised position.



#### Memo

- Perform the same operation to change the needle stop position to the lowered position.

- **When the needle stops in the raised position**  
The needle stops in the raised position when sewing ends.

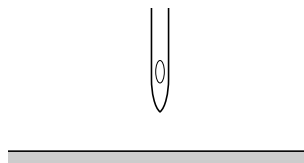

#### Memo

- After sewing is finished, the fabric can be pulled out.

- **When the needle stops in the lowered position**

The needle stops in the lowered position when sewing ends.

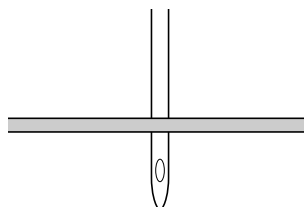

#### Memo

- Use this position to change the sewing direction ("Changing the sewing direction" (page 48)) or to stop while sewing.

## Changing the initial needle position

Normally, the straight stitch (left needle position) is automatically selected when the sewing machine is turned on. The machine can be set so that the straight stitch (center needle position) is automatically selected when it is turned on.

- 1 Turn off the sewing machine.

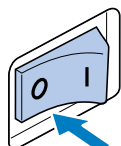

- 2 While pressing  (needle mode selection key), turn on the sewing machine.

When the machine beeps twice, release the needle mode selection key.

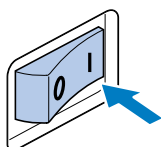
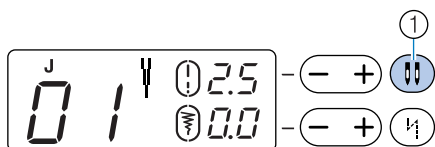

- ① Needle mode selection key (single/twin)
  - ▶ The initial needle position is changed to the center needle position.



### Memo

- The specified initial needle position is maintained even after the machine is turned off.
- Perform the same operation to change the initial needle position to the left needle position.

## Sewing Cylindrical or Large Pieces

When sewing cylindrical or large pieces of fabric, remove the flat bed attachment.

### Stitching cylindrical pieces

Removing the flat bed attachment makes it easier to sew cylindrical pieces such as cuffs and pant legs.

- 1 Pull the flat bed attachment off to the left.

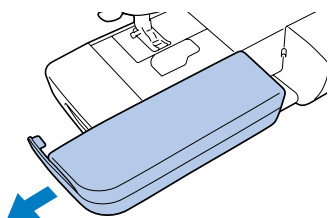

► With the flat bed attachment removed, free-arm sewing is possible.

- 2 Slide the part that you wish to sew onto the arm, and then sew from the top.

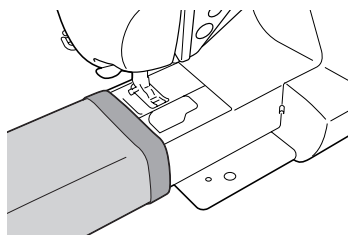

- 3 When you are finished with free-arm sewing, install the flat bed attachment back in its original position.

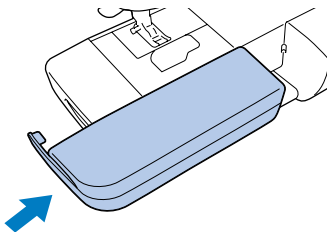

### Sewing large pieces of fabric

The optional wide table makes sewing large pieces of fabric easier.

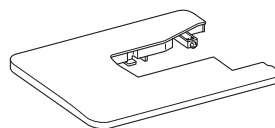

- 1 Open up the legs at the bottom of the wide table. Pull out the four legs until they snap into place.

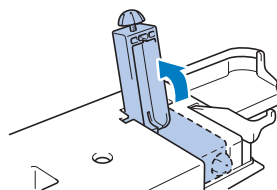

- 2 Pull the flat bed attachment off to the left.

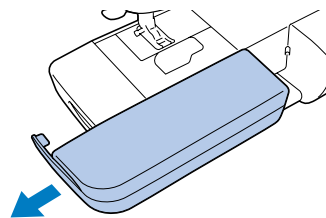

- 3 Install the wide table.**  
Keeping the wide table level, fully slide it into place. The lower right corner section of the wide table extends over the front section of the sewing machine bed.

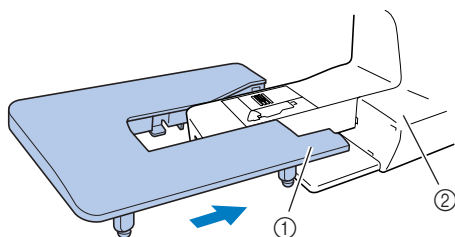

- ① Lower right corner  
② Sewing machine bed



#### Note

- The optional wide table is available through your Brother dealer.

- 4 Turn the screw at the bottom of each leg to adjust their height so the wide table will be level with the sewing machine bed.**

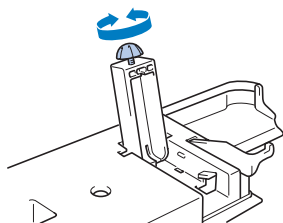

#### CAUTION

- Do not move the sewing machine while the wide table is attached, otherwise damage or injuries may occur.
- 5 When you are finished using the wide table, remove it.**  
While slightly lifting up the wide table, pull it off to the left.

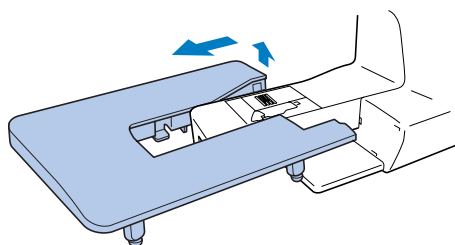

- 6 Install the flat bed attachment back in its original position.**



## 2 SEWING BASICS

### Starting to Sew

Basic sewing operations are described below.

Before operating the sewing machine, read the following precautions.

#### CAUTION

- While the machine is in operation, pay special attention to the needle. In addition, keep your hands away from all moving parts such as the needle, handwheel, and thread take-up lever, otherwise injuries may occur.
- Do not pull or push the fabric too hard while sewing, otherwise injuries may occur or the needle may break.
- Never use bent needles. Bent needles can easily break, possibly resulting in injuries.
- Use the correct presser foot for the type of stitch that you wish to sew, otherwise the needle may hit the presser foot, causing the needle to bend or break.
- When sewing, make sure that the needle does not strike basting pins, otherwise the needle may break or bend.
- Before replacing the presser foot, be sure to turn off the sewing machine, otherwise injuries may occur if the start/stop button is accidentally pressed and the machine starts sewing.

### Sewing procedure

The basic sewing procedure is shown below.

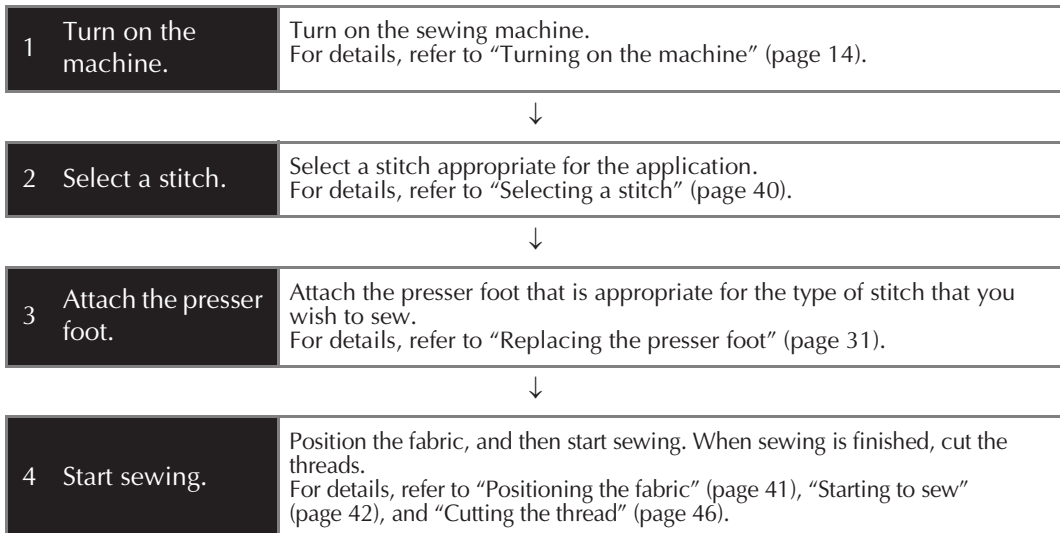

## Selecting a stitch

Select each stitch by using the pattern selection dial.

- 1 Turn on the sewing machine.

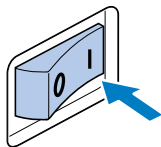

- 2 Turn the pattern selection dial to select the stitch to be sewn. Turn the dial to the right to increase the number, or turn the dial to the left to decrease the number.

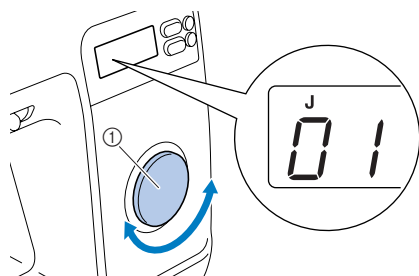

- 1 Pattern selection dial
- The stitch appears in the LCD.

- 3 Attach the presser foot indicated in the LCD.

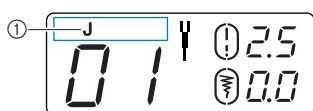

- 1 Presser foot type
  - For details, refer to “Replacing the presser foot” (page 31).



### Memo

- The presser foot to be used is indicated by the letter (J, A, etc.) that appears above the stitch number.

- 4 If necessary, adjust the stitch width and stitch length.

- For details on making adjustments, refer to the next section, “Adjusting the stitch length and width”

## Adjusting the stitch length and width

- Example: To select stitch  05

- 1 Turn the pattern selection dial until “05” appears in the LCD.
- 2 Press “+” or “-” side of  (stitch length key) to adjust the stitch length.

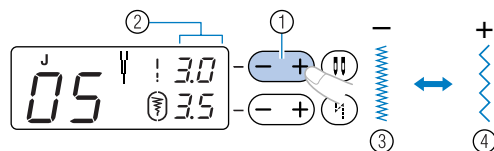

- 1 Stitch length key
- 2 Stitch length
- 3 Fine
- 4 Coarse

- 3** Press “+” or “-” side of  $\ominus\oplus$  (stitch width key) to adjust the stitch width.

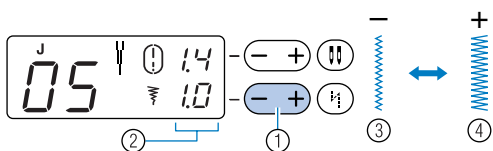

- ① Stitch width key
- ② Stitch width
- ③ Narrow
- ④ Wide



### Memo

- When the stitch length or stitch width is changed from the default setting,  $\circ$  around  $\updownarrow$  or  $\text{⌂}$  disappears from the LCD. When the stitch length or stitch width is reset back to the default setting,  $\circ$  reappears around  $\updownarrow$  or  $\text{⌂}$  in the LCD.
- If the stitch width of the selected stitch cannot be adjusted, “--” appears to the right of  $\text{⌂}$  in the LCD.



### CAUTION

- After adjusting the stitch width, slowly turn the handwheel toward you and check that the needle does not touch the presser foot. If the needle hits the presser foot, the needle may bend or break.
- If the stitches become bunched together, increase the stitch length. Continuing to sew with the stitches bunched together may result in the needle bending or breaking.

## Positioning the fabric

Be sure that the fabric pieces are sewn in the correct order and that the right and wrong sides of the fabric are aligned correctly.

- 1** Turn on the sewing machine.  
The straight stitch (left needle position) is automatically selected.

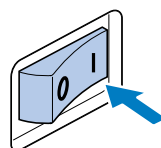

- 2** Press  $\oplus$  (needle position button) once or twice to raise the needle.

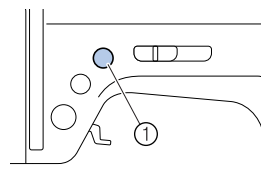

- ① Needle position button

- 3** Place the fabric under the presser foot.
- If the seam allowance is positioned on the right side, sewing in a straight line is easier and the extra fabric does not get in the way.

- 4** While holding the end of the thread and the fabric with your left hand, turn the handwheel toward you (counterclockwise) with your right hand to lower the needle to the starting point of the stitching.

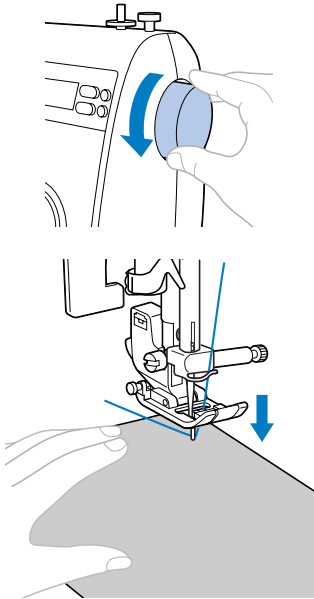

- 5** Lower the presser foot lever.

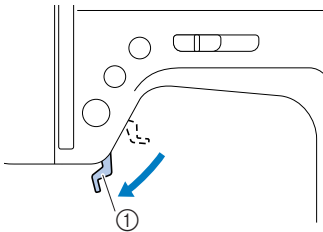

- ① Presser foot lever  
▶ The fabric is now positioned to be sewn.

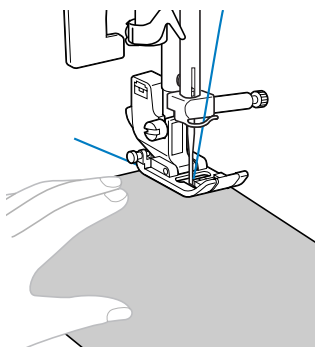

## Starting to sew

Once you are ready to start sewing, you can start the sewing machine. The sewing speed can be adjusted using either the sewing speed controller or the foot controller.



### Note

#### Important:

- When the foot controller is plugged in, ① (start/stop button) cannot be used to start sewing.

### ■ Using the operation buttons

Sewing can be started and stopped using the operation button ① (start/stop button).

- ①** Slide the sewing speed controller to the left or right to select the desired sewing speed. Slide the sewing speed controller to the left to sew at a slower speed, or slide the speed controller to the right to sew at a faster speed.

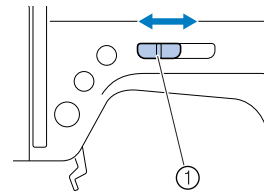

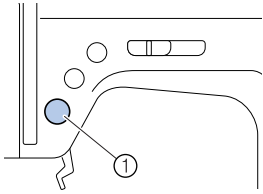

- ① Sewing speed controller

- ② Press  (start/stop button) once.

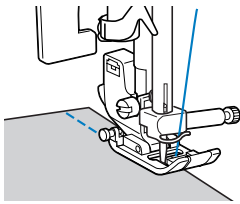

- ① Start/stop button  
The machine starts sewing.



- If you continue pressing the  (start/stop button) immediately after the sewing starts, the machine will sew at a slow speed.

- ③ When the end of the stitching is reached, press  (start/stop button) once.

- ▶ The machine stops sewing with the needle down (in the fabric).

- ④ When you are finished sewing, raise the needle, and then cut the threads.

- ▶ For details, refer to “Cutting the thread” (page 46).

#### ■ Using the foot controller

Sewing can be started and stopped using the foot controller.

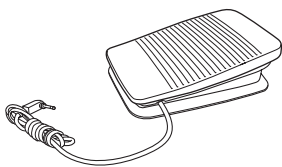

- ① Turn off the sewing machine.  
When connecting the foot controller, be sure to turn off the sewing machine in order to prevent the machine from accidentally being started.

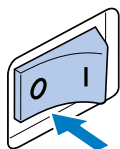

- ② Insert the foot controller plug into its jack on the side of the sewing machine.

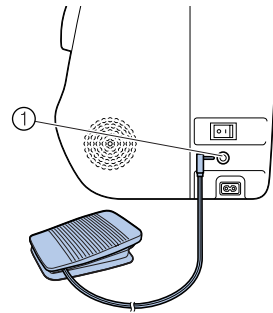

- ① Foot controller jack

- ③ Turn on the sewing machine.

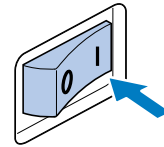

- ④ Slide the sewing speed controller to the left or right to select the desired sewing speed.

- Slide the sewing speed controller to the left to sew at a slower speed, or slide the speed controller to the right to sew at a faster speed.

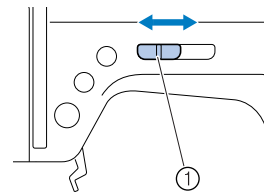

- ① Sewing speed controller
- The speed set using the sewing speed controller will be the foot controller's maximum sewing speed.

- 5** Once you are ready to start sewing, slowly press down on the foot controller. Pressing down on the foot controller increases the sewing speed; releasing the pressure on the foot controller decreases the sewing speed.

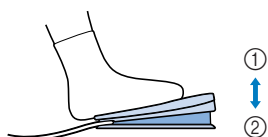

- ① Slower  
② Faster
- Slowly press down on the foot controller. Pressing it down hard starts sewing too quickly.
  - ▶ The machine starts sewing.

- 6** When the end of the stitching is reached, completely release the foot controller.
- ▶ The machine stops sewing with the needle lowered (in the fabric).

- 7** When you are finished sewing, raise the needle, and then cut the threads.
- For details, refer to “Cutting the thread” (page 46).



### Memo

- When the foot controller is plugged in, ① (start/stop button) cannot be used to start sewing.
- When sewing is stopped, the needle remains lowered (in the fabric). The machine can be set so that the needle will stay up when sewing is stopped. For details on setting the machine so that the needle stays up when sewing is stopped, refer to “Changing the needle stop position” (page 35).



### CAUTION

- Do not allow thread or dust to accumulate in the foot controller, otherwise a fire or an electric shock may occur.
- Do not place objects on the foot controller, otherwise damage to the machine or injuries may occur.
- If the machine is not to be used for a long period of time, unplug the foot controller, otherwise a fire or an electric shock may occur.

## Securing the stitching

When sewing with the straight stitch, for example, at the end of an opening or where seams do not overlap, use reverse stitching or reinforcement stitching to secure the end of the thread.

- 1** Lower the needle into the fabric at the beginning of the stitching, and then lower the presser foot lever.

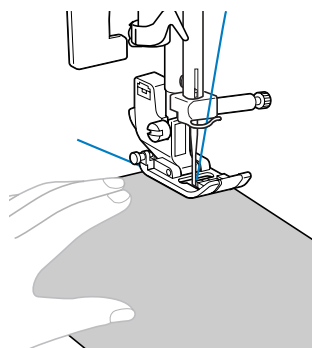

- 2** Press ① (start/stop button) or press down on the foot controller.

At this time, if ① (start/stop button) is held down, the machine sews at a low speed.

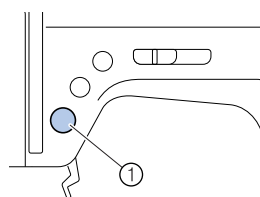

- ① Start/stop button
- For details, refer to “Starting to sew” (page 42).
  - ▶ The machine starts sewing.

- 3** After sewing 3 to 5 stitches, press **(Ⓜ)** (reverse/reinforcement stitch button).  
Keep **(Ⓜ)** (reverse/reinforcement stitch button) held down until you reach the beginning of the stitching.

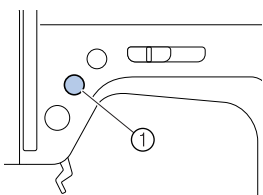

- ① Reverse/reinforcement stitch button  
While **(Ⓜ)** (reverse/reinforcement stitch button) is held down, reverse stitches are sewn.

- 4** After sewing back to the beginning of the stitching, release **(Ⓜ)** (reverse/reinforcement stitch button).  
▶ The machine stops sewing.

- 5** Press **(⏻)** (start/stop button), or press down on the foot controller.  
▶ The machine starts sewing in the normal sewing direction.

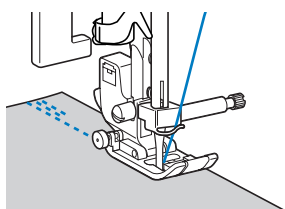

- 6** When the end of the stitching is reached, press **(Ⓜ)** (reverse/reinforcement stitch button).  
Keep **(Ⓜ)** (reverse/reinforcement stitch button) held down until 3 to 5 reverse stitches are sewn.  
▶ While **(Ⓜ)** (reverse/reinforcement stitch button) is held down, reverse stitches are sewn.

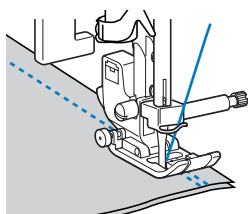

- 7** After 3 to 5 reverse stitches have been sewn, release **(Ⓜ)** (reverse/reinforcement stitch button).  
▶ The machine stops sewing.

- 8** Press **(⏻)** (start/stop button), or press down on the foot controller.  
At this time, if **(⏻)** (start/stop button) is held down, the machine sews at a slow speed.  
▶ The machine starts sewing in the normal sewing direction.

- 9** After sewing to the end of the stitching, stop the sewing machine.  
Press **(⏻)** (start/stop button) or release foot controller.

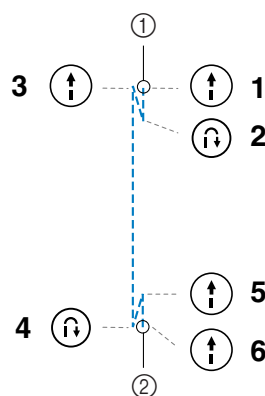

- ① Beginning of stitching  
② End of stitching

### ■ Sewing reinforcement stitches

When sewing stitches other than straight or zigzag stitches that are secured with reverse stitching, pressing **(Ⓜ)** (reverse/reinforcement stitch button) sews reinforcement stitches, 3 to 5 stitches on top of each other.

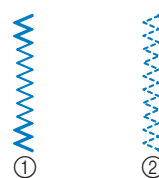

- ① Reverse stitching  
② Reinforcement stitching



### Memo

- Whether reverse stitches or reinforcement stitches are sewn depends on the stitch that is selected. For details, refer to "Stitch settings" (page 87).

## Cutting the thread

- 1 When you wish to finish the stitching and the sewing machine is stopped, press  (needle position button) once to raise the needle.

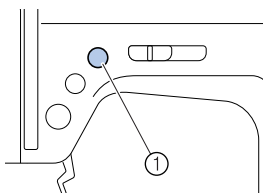

- 1 Needle position button  
▶ The needle is raised.

- 2 Raise the presser foot lever.

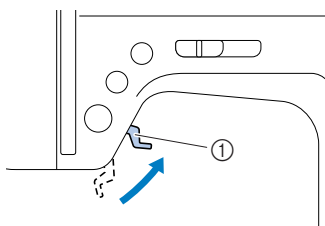

- 1 Presser foot lever

- 3 Pull the fabric to the left side of the machine, and then pass the threads through the thread cutter to cut them.

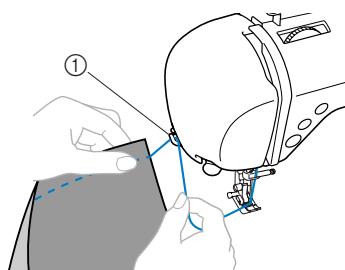



- 1 Thread cutter

## Automatically sewing reverse/reinforcement stitches

The sewing machine can be set to automatically sew reverse or reinforcement stitches at the beginning and end of the stitching. With straight stitches and zigzag stitches, reverse stitches, not reinforcement stitches, are automatically sewn.

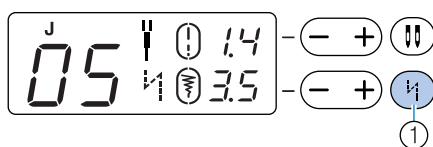
- 1 Select a stitch.
  - For details, refer to “Selecting a stitch” (page 40).
- 2 Press  (automatic reverse/reinforcement stitch key).



- 1 Automatic reverse/reinforcement stitch key  
▶  appears in the LCD.

- This step is not necessary if a stitch such as those for sewing buttonholes and bar tacks is selected where reinforcement stitches are automatically sewn.
- Press  (automatic reverse/reinforcement stitch key) again to cancel automatic reverse/reinforcement stitching.

- 3 Position the fabric under the presser foot, and turn the handwheel toward you to insert the needle into the fabric.

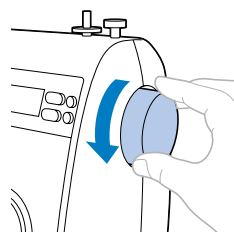

- 4 Press  (start/stop button) once.

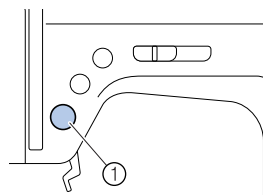

- 1 Start/stop button  
▶ After reverse/reinforcement stitches are sewn, the machine starts sewing.



**5** After reaching the end of the stitching, press the reverse/reinforcement stitch button once.

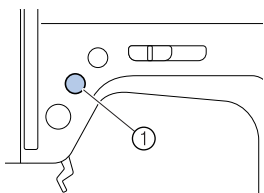

- ① Reverse/reinforcement stitch button
- This step is not necessary if a stitch such as those for sewing buttonholes and bar tacks is selected where reinforcement stitches are automatically sewn.
  - ▶ After reverse/reinforcement stitches are sewn, the sewing machine stops.

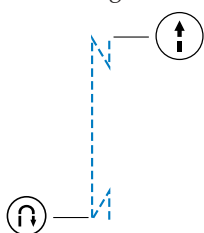

**Memo**

- Reverse/reinforcement stitches **WILL NOT** be sewn until ① (reverse/reinforcement stitch button) is pressed. ② (start/stop button) may be pressed to stop stitching when needed such as for pivoting corners.

**Adjusting the thread tension**

The tensions of the upper thread and of the bobbin thread (thread tension) should be adjusted so that they are equal.

If the thread and needle combination is correct for the type of fabric being sewn (according to "Needle types and their uses" (page 28)), the thread tension will automatically be adjusted to the appropriate setting. However, if the preset thread tension does not give the desired result or if you are sewing with special thread or on special fabric, use the thread tension dial to increase or decrease the tension of the upper thread.

**Correct thread tension**

The upper thread and the bobbin thread should cross near the center of the fabric. Only the upper thread should be visible from the right side of the fabric, and only the bobbin thread should be visible from the wrong side of the fabric.

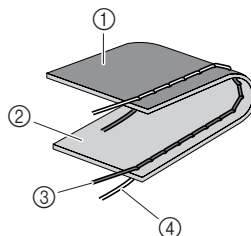

- ① Wrong side of fabric
- ② Right side of fabric
- ③ Upper thread
- ④ Bobbin thread

**Upper thread is too tight**

If the bobbin thread is visible from the right side of the fabric, the upper thread is too tight.

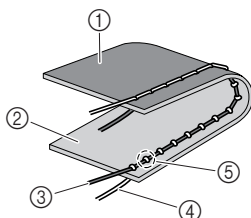

- ① Wrong side of fabric
- ② Right side of fabric
- ③ Upper thread
- ④ Bobbin thread
- ⑤ The bobbin thread is visible from the right side of the fabric.

Turn the thread tension dial to the left to loosen the upper thread.

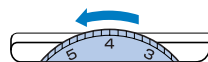

**Upper thread is too loose**

If the upper thread is visible from the wrong side of the fabric, the upper thread is too loose.

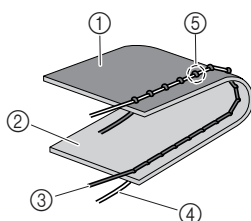

- ① Wrong side of fabric
- ② Right side of fabric
- ③ Upper thread
- ④ Bobbin thread
- ⑤ The upper thread is visible from the wrong side of the fabric.

Turn the thread tension dial to the right to tighten the upper thread.

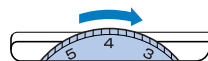

## Useful Sewing Tips

Various ways to achieve better sewing results are described below. Refer to these tips when sewing.

### Trial sewing

After a stitch is selected, the machine automatically sets the stitch width and length for the stitch that was selected.

However, a trial piece of fabric should be sewn since, depending on the type of fabric and stitching being sewn, the desired results may not be achieved. For the trial sewing, use a piece of fabric and thread that are the same as those used for your project, and check the thread tension and stitch length and width. Since the results differ depending on the type of stitching and the number of fabric layers sewn, perform the trial sewing under the same conditions that will be used with your project.

### Changing the sewing direction

- 1** When stitching reaches a corner, stop the sewing machine.  
Leave the needle lowered (in the fabric). If the needle remained up when the machine stopped sewing, press ⊕ (needle position button).
- 2** Raise the presser foot lever, and then turn the fabric.  
Turn the fabric using the needle as a pivot.

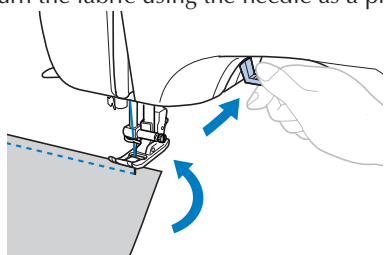

- 3** Lower the presser foot lever and continue sewing.

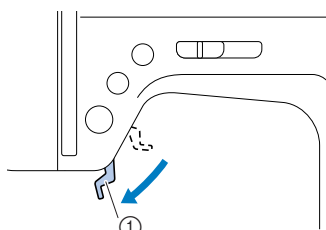

① Presser foot lever

### Sewing curves

Stop sewing, and then slightly change the sewing direction to sew around the curve.

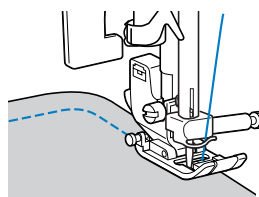

When sewing along a curve while using a zigzag stitch, select a shorter stitch length in order to obtain a finer stitch.

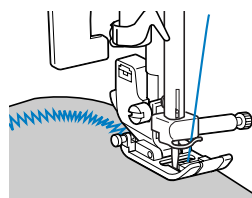

### Sewing thick fabrics

- If the fabric does not fit under the presser foot  
Raise the presser foot even higher to bring the presser foot to its highest position. (At this time, the presser foot lever is not secured.)

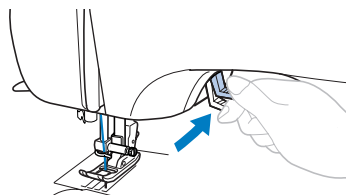

### CAUTION

- The thickness of fabric differs depending on the fabric type. If the fabric is forcefully pushed, the needle may break or bend.

- If thick seams are being sewn and the fabric does not feed at the beginning of stitching Zigzag foot “J” is equipped with a feature that keeps the presser foot level.

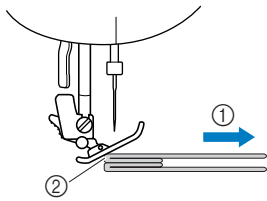

- ① Sewing direction
- ② Misalignment

- ① When starting sewing with a seam that is too thick for the fabric to be fed, raise the presser foot lever.
- ② Using the index finger press the black button (presser foot holding pin) on the left side of the zigzag foot “J”, then use left thumb to level the presser foot by gently pushing down on the front of the presser foot. You will hear a “click”; continue pressing the presser foot holding pin while lowering the presser foot.

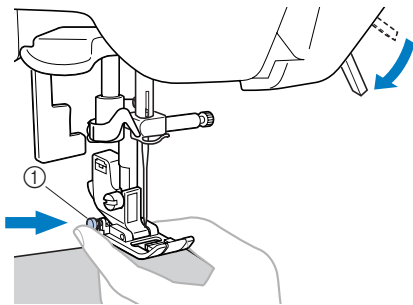

- ① Black button

- ③ The presser foot remains level, enabling the fabric to be fed.

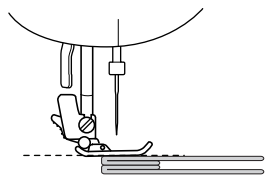

- After the seam is sewn, the presser foot will return to its normal operation.



## CAUTION

- The thickness of fabric differs depending on the fabric type. If the fabric is forcefully pushed, the needle may break or bend.

## Sewing thin fabrics

When sewing thin fabrics, the stitching may become misaligned or the fabric may not feed correctly. If this occurs, place thin paper or stabilizer material under the fabric and sew it together with the fabric. When you have finished sewing, tear off any excess paper.

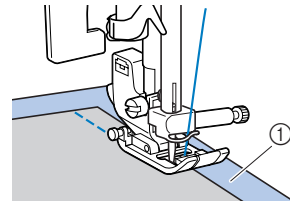

- ① Stabilizer material or paper

## Sewing stretch fabrics

First, baste the pieces of fabric together, and then sew without stretching the fabric. In addition, a better result can be achieved by using thread for knits or a stretch stitch.

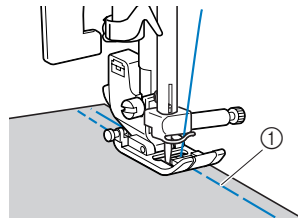

- ① Basting

## Pulling up the bobbin thread

When making gathers, first pull up the bobbin thread as described below.

- 1** Pass the bobbin thread through the slot.  
Do not cut the thread with the cutter.

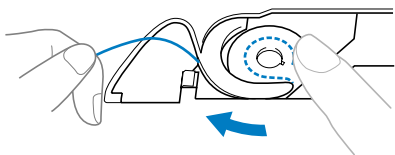

- Leave the bobbin cover removed.

- 2** Lightly hold the end of the upper thread.

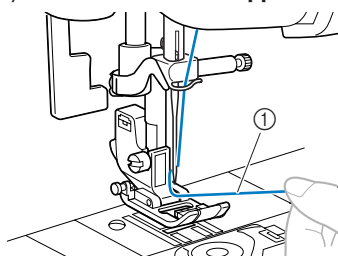

- ① Upper thread

- 3** With the needle raised, press  (needle position button) twice.

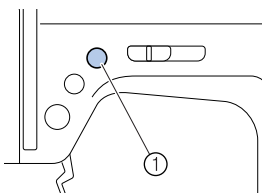

- ① Needle position button

- 4** Carefully pull the upper thread upward to pull out the end of the bobbin thread.

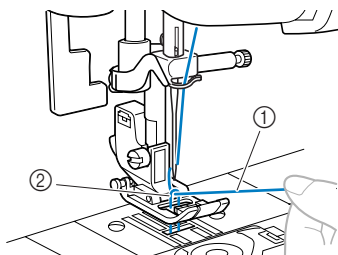

- ① Upper thread  
② Bobbin thread

- 5** Pull out about 10 to 15 cm (4-5 inches) of the bobbin thread under the presser foot toward the rear of the machine.

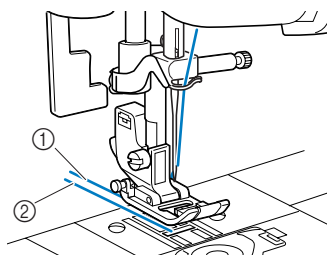

- ① Upper thread  
② Bobbin thread



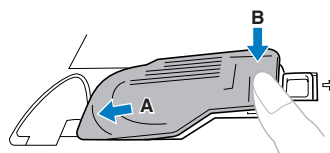



- 6** Reattach the bobbin cover.  
Insert the tab in the lower-left corner of the bobbin cover (A), and then press down on the right side (B).



# 3 UTILITY STITCHES

## Overcasting

Sew overcasting along the edges of cut fabric to prevent them from fraying. Six stitches are available for overcasting.

Stitch Name	Pattern	Presser Foot	Application	Stitch Width [mm (inch)]		Stitch Length [mm (inch)]		Twin Needle	Walk-ing Foot	Reverse/ Reinforcement Stitching
				Auto	Manual	Auto	Manual			
Zigzag stitch		J	Overcasting and attaching appliqués	3.5 (1/8)	0.0–7.0 (0–1/4)	1.4 (1/16)	0.0–4.0 (0–3/16)	Yes (J)	*1 Yes	Reverse
3-point zigzag stitch		J	Overcasting on medium weight or stretch fabrics, attaching elastic, darning, etc.	5.0 (3/16)	1.5–7.0 (1/16–1/4)	1.0 (1/16)	0.2–4.0 (1/64–3/16)	Yes (J)	No	Reinforcement
Overcasting stitch		G	Overcasting on thin or medium weight fabrics	3.5 (1/8)	2.5–5.0 (3/32–3/16)	2.0 (1/16)	1.0–4.0 (1/16–3/16)	No	No	Reinforcement
		G	Overcasting on thick fabrics	5.0 (3/16)	2.5–5.0 (3/32–3/16)	2.5 (3/32)	1.0–4.0 (1/16–3/16)	No	No	Reinforcement
		G	Preventing fraying in thick fabrics and fabrics that fray easily	5.0 (3/16)	3.5–5.0 (1/8–3/16)	2.5 (3/32)	1.0–4.0 (1/16–3/16)	No	No	Reinforcement
		J	Overcasting on stretch fabrics	5.0 (3/16)	0.0–7.0 (0–1/4)	2.5 (3/32)	0.5–4.0 (1/32–3/16)	Yes (J)	No	Reinforcement

\*1 Do not use reverse stitching.



The values below “Auto” are set when the pattern is selected. The setting can be adjusted to any value within the range indicated below “Manual”.

Observe the following precautions while stitching.

### CAUTION

- Before replacing the presser foot, be sure to turn off the sewing machine, otherwise injuries may occur if a button is accidentally pressed and the machine starts sewing.

## Sewing overcasting stitches using zigzag foot “J”

- 1 Turn on the machine.
- 2 With the pattern selection dial,
  - select ,  or .
- 3 Attach zigzag foot “J”.
  - For details, refer to “Replacing the presser foot” (page 31).
- 4 Sew along the edge of the fabric with the needle dropping off the edge at the right.

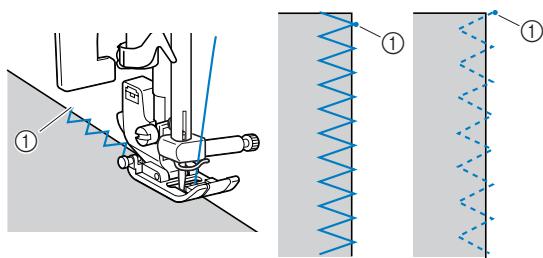



① Needle drop point



### CAUTION

- After adjusting the stitch width, slowly turn the handwheel toward you and check that the needle does not touch the presser foot. If the needle hits the presser foot, the needle may bend or break.

## Sewing overcasting stitches using overcasting foot “G”

- 1 Turn on the machine.
- 2 With the pattern selection dial,
  - select ,  or .
- 3 Attach overcasting foot “G”.
  - For details, refer to “Replacing the presser foot” (page 31).
- 4 Position the fabric with the edge of the fabric against the guide of the presser foot, and then lower the presser foot lever.

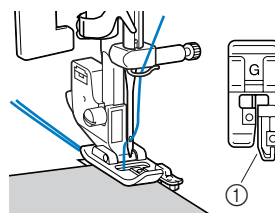

① Presser foot guide

- 5 Slowly turn the handwheel toward you and check that the needle does not touch the presser foot.

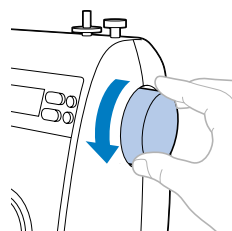

- 6 Sew with the edge of the fabric against the presser foot guide.

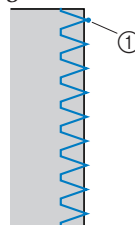

① Needle drop point

# Basic Stitching

Straight stitches are used for sewing plain seams. Three stitches are available for basic stitching.

Stitch Name	Pattern	Presser Foot	Application	Stitch Width [mm (inch)]		Stitch Length [mm (inch)]		Twin Needle	Walk-ing Foot	Reverse/ Reinforcement Stitching
				Auto	Manual	Auto	Manual			
Straight stitch	Left	01 	Basic stitching, sewing gathers or pintucks, etc.	0.0 (0)	0.0–7.0 (0–1/4)	2.5 (3/32)	0.2–5.0 (1/64–3/16)	Yes (J)	*1 Yes	Reverse
	Center	02 		3.5 (1/8)	0.0–7.0 (0–1/4)	2.5 (3/32)	0.2–5.0 (1/64–3/16)	Yes (J)	*1 Yes	Reverse
Triple stretch stitch	03 	J	Attaching sleeves, sewing inseams, sewing stretch fabrics and decorative stitching	0.0 (0)	0.0–7.0 (0–1/4)	2.5 (3/32)	1.5–4.0 (1/16–3/16)	Yes (J)	No	Reinforcement

\*1 Do not use reverse stitching.

The values below “Auto” are set when the pattern is selected. The setting can be adjusted to any value within the range indicated below “Manual”.



## CAUTION

- Before replacing the presser foot, be sure to turn off the sewing machine, otherwise injuries may occur if a button is accidentally pressed and the machine starts sewing.

**1** Baste or pin together the fabric pieces.

**2** Turn on the machine.

**3** With the pattern selection dial,

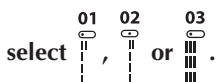

**4** Attach zigzag foot “J”.

- For details, refer to “Replacing the presser foot” (page 31).

**5** If reverse stitches are to be sewn, lower the needle into the fabric 3 to 5 stitch lengths in front of the point where the stitching will begin, and then sew the reverse stitches.

- For details, refer to “Securing the stitching” (page 44).

**6** Start sewing.

- For details, refer to “Starting to sew” (page 42).

**7** If reverse stitches are to be sewn at the end of stitching, sew 3 to 5 reverse stitches.

- For details, refer to “Securing the stitching” (page 44).

**8** When sewing is finished, cut the thread.

### ■ Changing the needle position

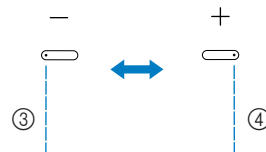
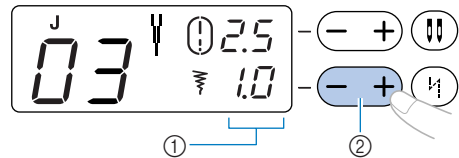

The needle position can be adjusted with the straight stitch (left needle position) and the triple stretch stitch by adjusting the stitch width. Press the “-” side of the stitch width key for a left needle position, or press the “+” side for a right needle position.



- ① Stitch width
- ② Stitch width key
- ③ Moves the needle position to the left
- ④ Moves the needle position to the right

## Blind Hem Stitching



The bottoms of skirts and pants are hemmed. Two stitches are available for blind hem stitching.

Stitch Name	Pattern	Presser Foot	Application	Stitch Width [mm (inch)]		Stitch Length [mm (inch)]		Twin Needle	Walking Foot	Reverse/Reinforcement Stitching
				Auto	Manual	Auto	Manual			
Blind hem stitch		R	Blind hem stitching on medium weight fabrics	0 (0)	-3 - 3	2.0 (1/16)	1.0-3.5 (1/16-1/8)	No	No	Reinforcement
		R	Blind hem stitching on stretch fabrics	0 (0)	-3 - 3	2.0 (1/16)	1.0-3.5 (1/16-1/8)	No	No	Reinforcement

The values below "Auto" are set when the pattern is selected. The setting can be adjusted to any value within the range indicated below "Manual".



### Memo

- When stitch  or  is selected

Press the "-" side of the stitch width key so that "0", "-1", "-2" or "-3" appears in the LCD to move the needle drop point to the left.

Press the "+" side of the stitch width key so that "0", "1", "2" or "3" appears in the LCD to move the needle drop point to the right.

Sew a blind hem according to the following procedure.



### CAUTION

- Before replacing the presser foot, be sure to turn off the sewing machine, otherwise injuries may occur if a button is accidentally pressed and the machine starts sewing.

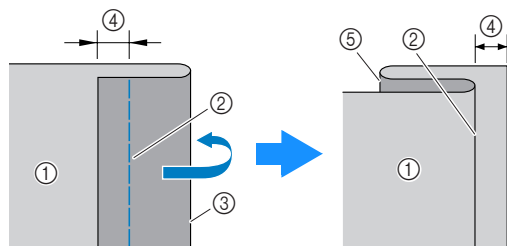

- Fold the fabric along the desired edge of the hem, and then baste it about 5 mm (3/16 inch) from the edge of the fabric. After basting, fold back the fabric along the basting, and then position the fabric with the wrong side facing up.



- Wrong side of fabric
- Basting stitching
- Desired edge of hem
- 5 mm (3/16 inch)
- Edge of hem

- Turn on the machine.

- With the pattern selection dial,

select  or .

- Attach blind hem foot "R".

- For details, refer to "Replacing the presser foot" (page 31).



- 5** Position the fabric with the edge of the folded hem against the guide of the presser foot, and then lower the presser foot lever.

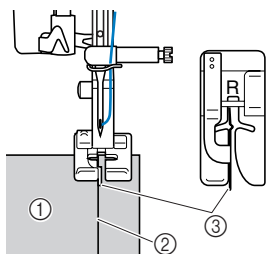

- ① Wrong side of fabric
- ② Fold of hem
- ③ Presser foot guide

- 6** Press the “-” side of the stitch width key to adjust the stitch width until the needle slightly catches the fold of the hem, and then sew with the edge of the fabric against the presser foot guide.

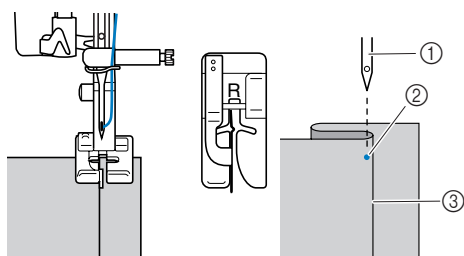

- ① Needle
- ② Needle drop point
- ③ Fold of hem



## CAUTION

- Slowly turn the handwheel toward you and check that the needle does not touch the presser foot. If the needle hits the presser foot, the needle may bend or break.



## Memo

If the needle is incorrectly positioned, the stitching results will be as shown below. Correct each result as described below.

- If the needle catches too much of the hem fold  
The needle is positioned too far to the left. Press the “+” side of the stitch width key to adjust the needle position so that the needle slightly catches the fold of the hem.

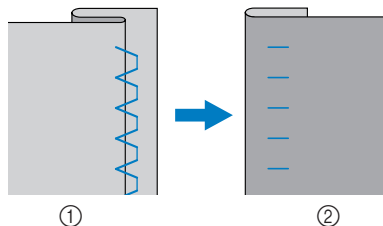

- ① Wrong side of fabric
- ② Right side of fabric

- If the needle does not catch the hem fold  
The needle is positioned too far to the right. Press the “-” side of the stitch width key to adjust the needle position so that the needle slightly catches the fold of the hem.

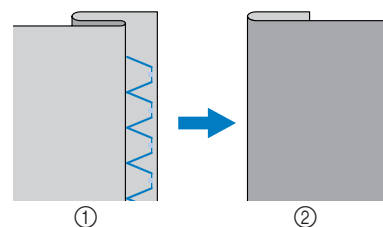

- ① Wrong side of fabric
- ② Right side of fabric

- For details, refer to “Adjusting the stitch length and width” (page 40).





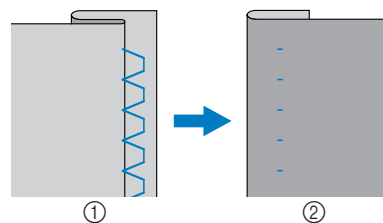

- 7** Remove the basting stitching.



- ① Wrong side of fabric
- ② Right side of fabric

## Buttonhole Stitching

Buttonholes can be sewn. Five stitches are available for sewing buttonholes.

Stitch Name	Pattern	Presser Foot	Application	Stitch Width [mm (inch)]		Stitch Length [mm (inch)]		Twin Needle	Walking Foot	Reverse/ Reinforcement Stitching
				Auto	Manual	Auto	Manual			
Buttonhole stitch		A	Horizontal buttonholes on thin and medium weight fabrics	5.0 (3/16)	3.0-5.0 (1/8-3/16)	0.5 (1/32)	0.2-1.0 (1/64-1/16)	No	No	Automatic Reinforcement
		A	Secured buttonholes for fabrics that have backings	5.0 (3/16)	3.0-5.0 (1/8-3/16)	0.5 (1/32)	0.2-1.0 (1/64-1/16)	No	No	Automatic Reinforcement
		A	Buttonholes for stretch or knit fabrics	6.0 (15/64)	3.0-6.0 (1/8-15/64)	1.0 (1/16)	0.5-2.0 (1/32-1/16)	No	No	Automatic Reinforcement
		A	Buttonholes for stretch fabrics	6.0 (15/64)	3.0-6.0 (1/8-15/64)	1.5 (1/16)	1.0-3.0 (1/16-1/8)	No	No	Automatic Reinforcement
		A	Keyhole buttonholes for thick or furry fabrics	7.0 (1/4)	3.0-7.0 (1/8-1/4)	0.5 (1/32)	0.3-1.0 (1/64-1/16)	No	No	Automatic Reinforcement

The values below "Auto" are set when the pattern is selected. The setting can be adjusted to any value within the range indicated below "Manual".

Buttonholes with a maximum length of 30 mm (1-3/16 inches) (diameter + thickness of the button) can be sewn. Buttonholes are sewn as shown below.

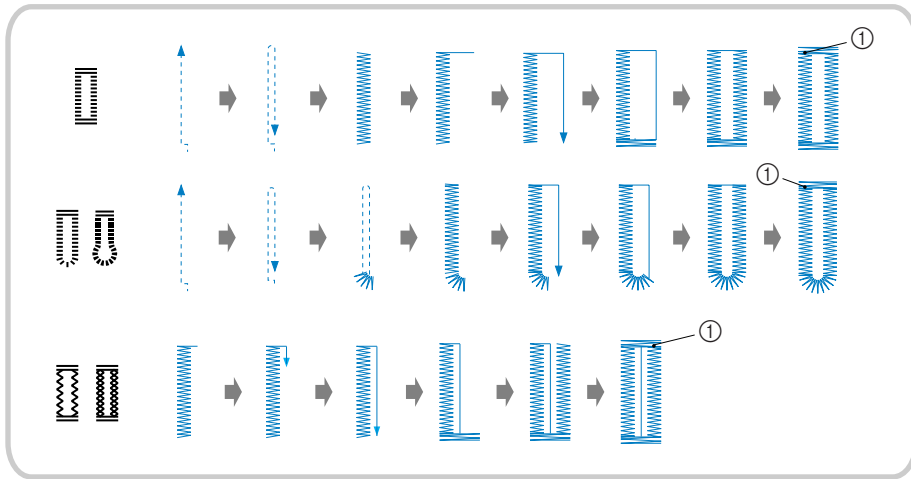

① Reinforcement stitching

**CAUTION**

- Before replacing the presser foot, be sure to turn off the sewing machine, otherwise injuries may occur if a button is accidentally pressed and the machine starts sewing.

The names of parts of buttonhole foot "A", which is used for sewing buttonholes, are indicated below.

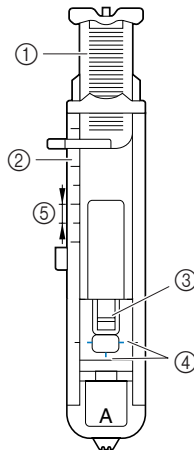

- ① Button guide plate
- ② Presser foot scale
- ③ Pin
- ④ Marks on buttonhole foot
- ⑤ 5 mm (3/16 inch)

- 1** Use chalk to mark on the fabric the position and length of the buttonhole.

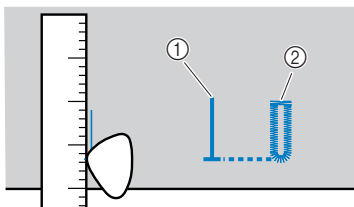

- ① Marks on fabric  
② Finished stitching

- 2** Pull out the button guide plate of buttonhole foot "A", and then insert the button that will be put through the buttonhole.

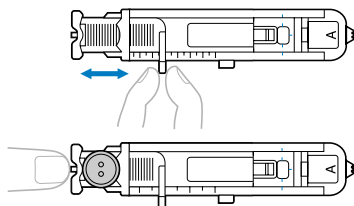

**■ If the button does not fit in the button guide plate**

Add together the diameter and thickness of the button, and then set the button guide plate to the calculated length. (The distance between the markings on the presser foot scale is 5 mm (3/16 inch).)

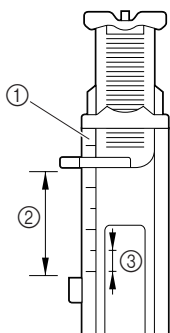

- ① Presser foot scale  
② Length of buttonhole (diameter + thickness of button)  
③ 5 mm (3/16 inch)

Example: For a button with a diameter of 15 mm (9/16 inch) and a thickness of 10 mm (3/8 inch), the button guide plate should be set to 25 mm (1 inch) on the scale.

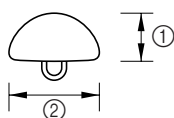

- ① 10 mm (3/8 inch)  
② 15 mm (9/16 inch)  
▶ The size of the buttonhole is set.

- 3** Turn on the machine.  
**4** With the pattern selection dial, select a stitch.

- 5** Attach buttonhole foot "A".  
• For details, refer to "Replacing the presser foot" (page 31).

- 6** Pass the upper thread down through the hole in the presser foot, and then pull it under the presser foot, as shown.

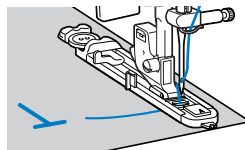

- 7** Position the fabric with the front end of the buttonhole mark aligned with the red marks on the sides of the buttonhole foot, and then lower the presser foot lever.

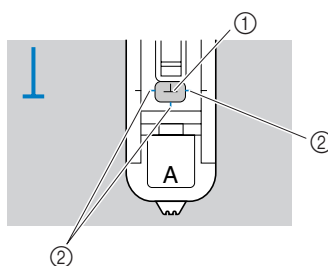

- ① Mark on fabric (front)  
② Red marks on buttonhole foot

**Note**

- When lowering the presser foot, do not push in the front of the presser foot, otherwise the buttonhole will not be sewn with the correct size.

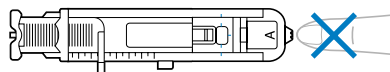

- 8** Pull down the buttonhole lever as far as possible.

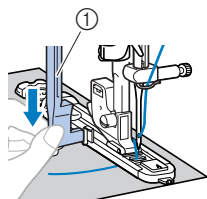

- ① Buttonhole lever  
The buttonhole lever should be positioned behind the bracket on the buttonhole foot.

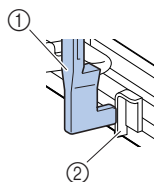

- ① Buttonhole lever  
② Bracket

- 9** Gently hold the end of the upper thread in your left hand, and then start sewing.

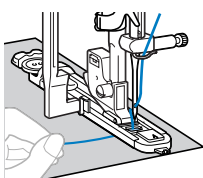

- Once sewing is completed, the machine automatically sews reinforcement stitches, then stops.

- 10** Cut the threads, raise the presser foot lever, and then remove the fabric.

- 11** Raise the buttonhole lever to its original position.

- 12** Insert a pin along the inside of one bar tack at the end of the buttonhole stitching to prevent the stitching from being cut.

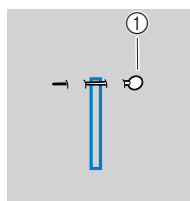

- ① Pin

- 13** Use the enclosed seam ripper to cut towards the pin and open the buttonhole.

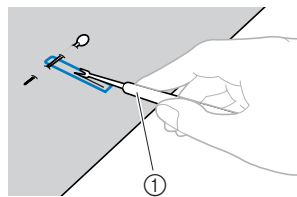

- ① Seam ripper

For keyhole buttonholes (34), use the enclosed eyelet punch to make a hole in the rounded end of the buttonhole, and then use the seam ripper to cut open the buttonhole.

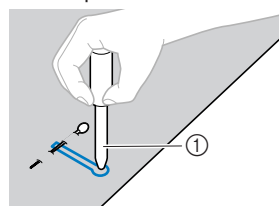

- ① Eyelet punch
- When using the eyelet punch, place thick paper or some other protective sheet under the fabric before punching the hole in the fabric.

### CAUTION

- When opening the buttonhole with the seam ripper, do not place your hands in the cutting path, otherwise injuries may result if the seam ripper slips. Do not use the seam ripper in any other way than how it is intended.

### Changing the stitch length

Press the "+" or "-" side of the stitch length key to adjust the stitch length.

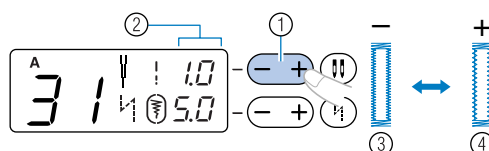

- ① Stitch length key  
② Stitch length  
③ Fine  
④ Coarse

- If the fabric does not feed (for example, if it is too thick), increase the coarseness of the stitching.

### ■ Changing the stitch width

Press the “+” or “-” side of the stitch width key to adjust the stitch width.

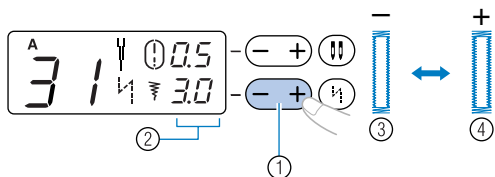

- ① Stitch width key
- ② Stitch width
- ③ Narrow
- ④ Wide



#### Memo

- Before sewing buttonholes, check the stitch length and width by sewing a trial buttonhole on a scrap piece of fabric.

### ■ Sewing buttonholes on stretch fabrics

When sewing buttonholes on stretch fabrics, use a gimp thread.

- ① Hook the gimp thread onto the part of buttonhole foot “A” shown in the illustration so that it fits into the grooves, and then loosely tie it.

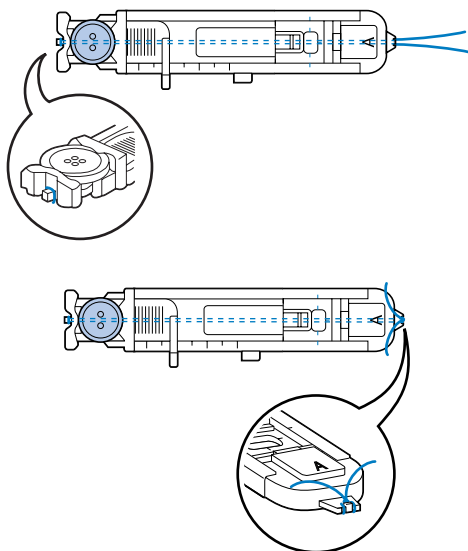

- ② Turn on the sewing machine.

- ③ Select stitch 32 or 33.

- ④ Attach buttonhole foot “A”.

- For details, refer to “Replacing the presser foot” (page 31).

- ⑤ Adjust the stitch width to the thickness of the gimp thread.

- ⑥ Lower the presser foot lever and the buttonhole lever, and then start sewing.

- ⑦ When sewing is finished, gently pull the gimp thread to remove any slack.

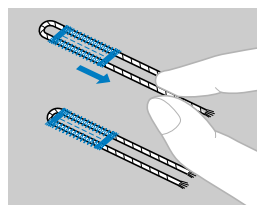

- ⑧ Use a handsewing needle to pull the gimp thread to the wrong side of the fabric, and then tie it.

- ⑨ With a seam ripper, cut the middle part of the gimp thread remaining at the top end of the buttonhole.

Trim off any excess of the gimp thread.



#### Note

- If gimp thread is not available use a thread or cord of at least 12 weight.

## Button sewing

Buttons can be sewn on with the sewing machine. Buttons with 2 or with 4 holes can be attached.

- 1 Measure the distance between the holes in the button to be attached.

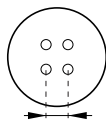

- 2 Raise the presser foot lever, and then slide the drop feed lever, located at the rear of the machine on the base, to  (to the left as seen from the rear of the machine).

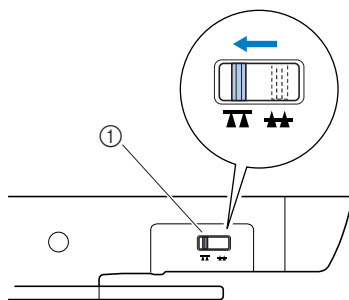

- 1 Drop feed lever (as seen from the rear of the machine)
  - ▶ The feed dogs are lowered.

- 3 Turn on the sewing machine.

- 4 Select stitch  05.

- 5 Attach button fitting foot “M”.

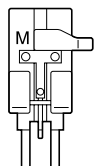

- For details, refer to “Replacing the presser foot” (page 31).

- 6 Adjust the stitch width so that it is the same as the distance between the holes in the button.

- 7 Place the button into button fitting foot “M”.

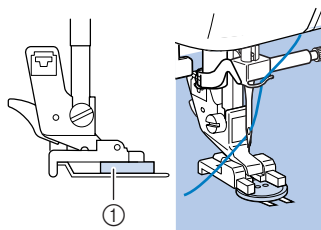

- 1 Button
  - ▶ The button is held in place.
  - When attaching four-hole buttons, first sew the two holes closest to you. Then, slide the button so that the needle goes into the two holes toward the rear of the sewing machine, and then sew them in the same way.

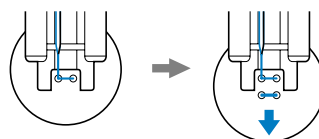

- 8 Turn the handwheel toward you (counterclockwise) to check that the needle correctly goes into the two holes of the button.

If it seems as if the needle will hit the button, remeasure the distance between the holes in the button. Adjust the stitch width to the distance between the button holes.

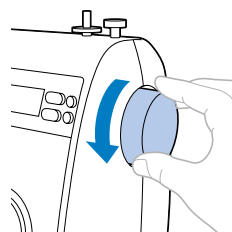

### CAUTION

- When sewing, be sure that the needle does not touch the button, otherwise the needle may bend or break.

- 9 Start sewing.**  
Set the sewing speed controller to the left (so that the speed will be slow).

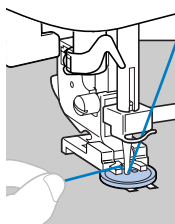

- ▶ The sewing machine automatically stops after sewing reinforcement stitches.
- If additional strength is needed to secure the button, perform the button-sewing operation twice.

- 10 Use scissors to cut the upper thread and the bobbin thread at the beginning of the stitching.**  
Pull the upper thread at the end of the stitching to the wrong side of the fabric, and then tie it with the bobbin thread.

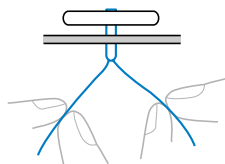

- 11 When you are finished attaching the button, slide the drop feed lever to  (to the right as seen from the rear of the machine) to raise the feed dogs.**

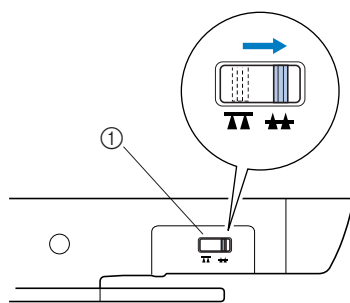

- ① Drop feed lever (as seen from the rear of the machine)



**Memo**

- The feed dog position switch is normally set to the right side (as seen from the rear of machine).
- The feed dogs come up when you start sewing again.

- Attaching a shank to a button**  
To sew the button with a shank, attach the button with space between it and the fabric, and then wind the thread by hand. This attaches the button securely.

- ① Place the button into button-sewing foot “M”, and then pull the shank lever toward you.**

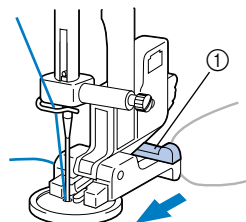

- ① Shank lever

- ② After sewing is finished, cut the upper thread with plenty of excess, wind it around the thread between the button and the fabric, and then tie it to the upper thread at the beginning of the stitching.**

Tie together the ends of the bobbin thread at the end and at the beginning of the stitching on the wrong side of the fabric.



- ③ Cut off any excess thread.**



# Zipper Insertion

A zipper can be sewn in place.

Stitch Name		Pattern	Presser Foot	Application	Stitch Width [mm (inch)]		Stitch Length [mm (inch)]		Twin Needle	Walk- ing Foot	Reverse/ Reinforcement Stitching
					Auto	Manual	Auto	Manual			
Straight stitch	Center	02 — — — — — 	J	Attaching zippers, basic stitching, and sewing gathers or pintucks, etc.	3.5 (1/8)	0.0–7.0 (0–1/4)	2.5 (3/32)	0.2–5.0 (1/64–3/16)	Yes (J)	*1 Yes	Reverse

\*1 Do not use reverse stitching.

The values below “Auto” are set when the pattern is selected. The setting can be adjusted to any value within the range indicated below “Manual”.

There are many methods for attaching zippers. Therefore, only the procedures for inserting a centered zipper and a side zipper are described below.

## CAUTION

- Before replacing the presser foot, be sure to turn off the sewing machine, otherwise injuries may occur if a button is accidentally pressed and the machine starts sewing.

### Inserting a centered zipper

Stitching is sewn on both pieces of fabric butted against each other.

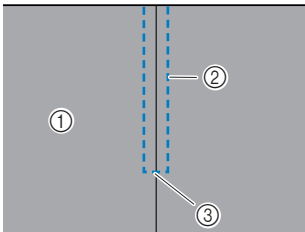

- ① Right side of fabric
- ② Stitching
- ③ End of zipper opening

**1** Turn on the machine.

**2** Attach zigzag foot “J” and sew straight stitches up to the zipper opening.

With the right sides of the fabric facing each other, sew reverse stitches after reaching the zipper opening.

- For details on basic stitching, refer to “Basic Stitching” (page 53).

**3** Baste the two pieces up to the edge of the fabric.

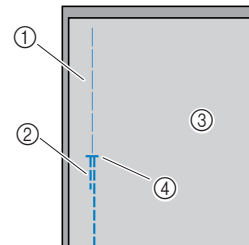

- ① Basting stitching
- ② Reverse stitching
- ③ Wrong side of fabric
- ④ End of zipper opening

**4** Press open the seam allowance from the wrong side of the fabric.

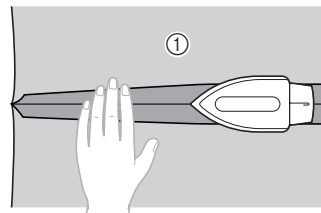

- ① Wrong side of fabric

- 5** Align the seam with the center of the zipper, and then baste the zipper in place.

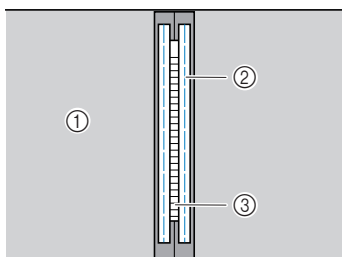

- ① Wrong side of fabric
- ② Basting stitching
- ③ Zipper

- 6** With the pattern selection dial,

select stitch .

- 7** Attach the presser foot holder to the right side of the pin of zipper foot “I”.

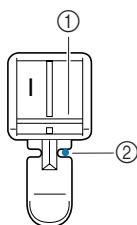

- ① Right side of the pin
- ② Needle drop point
- For details, refer to “Replacing the presser foot” (page 31).

**! CAUTION**

- When using zipper foot “I”, be sure to use a center needle position, and slowly turn the handwheel toward you to check that the needle does not touch the presser foot. If a different stitch is selected and the needle hits the presser foot, the needle may bend or break.

- 8** Topstitch around the zipper.

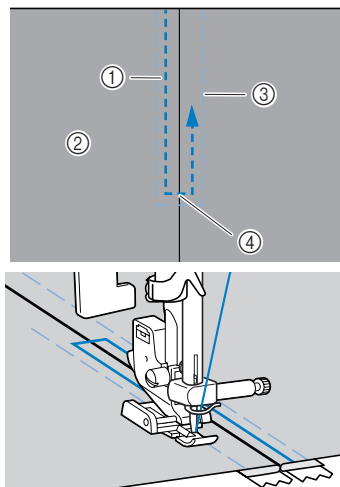

- ① Stitching
- ② Right side of fabric
- ③ Basting stitching
- ④ End of zipper opening

**! CAUTION**

- When sewing, be sure that the needle does not touch the zipper, otherwise the needle may bend or break.

- 9** Remove the basting stitching.

**Inserting a side zipper**

Stitching is sewn on only one piece of fabric. Use this type of zipper for side openings and back openings.

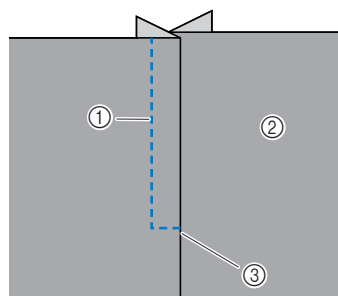

- ① Stitching
- ② Right side of fabric
- ③ End of zipper opening

The following procedure will describe how to stitch on the left side, as shown in the illustration.

**1** Turn on the machine.

**2** Attach zigzag foot “J” and sew straight stitches up to the zipper opening.

- With the right sides of the fabric facing each other, sew reverse stitches after reaching the zipper opening.
- For details on basic stitching, refer to “Basic Stitching” (page 53).

**3** Baste the two pieces up to the edge of the fabric.

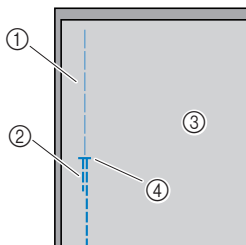

- ① Basting stitching
- ② Reverse stitching
- ③ Wrong side of fabric
- ④ End of zipper opening

**4** Press open the seam allowance from the wrong side of the fabric.

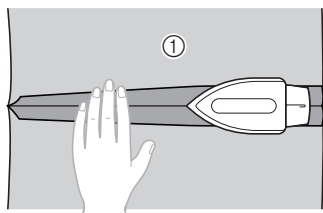

- ① Wrong side of fabric

**5** Press the seam allowance so that the right side (the side that will not be stitched) has an extra 3 mm (1/8 inch).

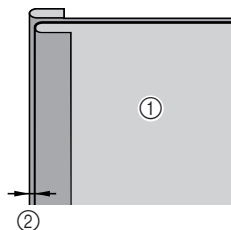

- ① Wrong side of fabric
- ② 3 mm (1/8 inch)

**6** Align the zipper teeth with the pressed edge of the fabric having the extra 3 mm (1/8 inch), and then baste or pin the zipper in place.

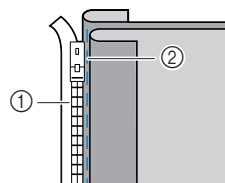

- ① Zipper teeth
- ② Basting stitching

**7** With the pattern selection dial, select stitch 02.



**8** Attach the presser foot holder to the right side of the pin of zipper foot “1”.

If the stitching will be sewn on the right side (opposite side of this example), attach the presser foot holder to the left side of the zipper foot pin.

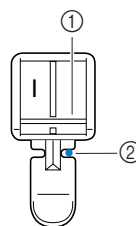

- ① Right side of the pin
- ② Needle drop point
- For details, refer to “Replacing the presser foot” (page 31).

### **!** CAUTION

- When using zipper foot “1”, be sure to use a center needle position, and slowly turn the handwheel toward you to check that the needle does not touch the presser foot. If a different stitch is selected and the needle hits the presser foot, the needle may bend or break.

- 9** Sew the zipper to the piece of fabric with the extra 3 mm (1/8 inch), starting from the base of the zipper.

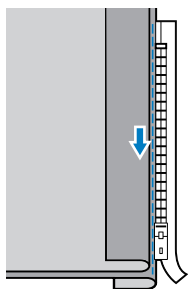

**! CAUTION**

- When sewing, be sure that the needle does not touch the zipper, otherwise the needle may bend or break.

- 10** When you are about 5 cm (2 inches) from the end of the zipper, stop the sewing machine with the needle down (in the fabric), raise the presser foot lever, and then open the zipper and continue sewing.

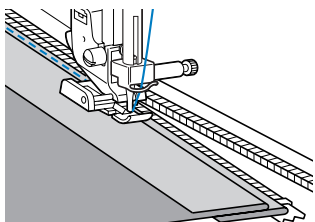

- 11** Close the zipper, turn over the fabric, and then baste the other side of the zipper to the fabric.

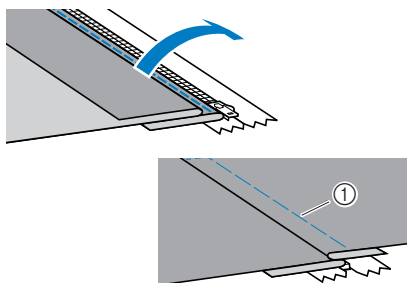

① Basting stitching

- 12** Attach the presser foot holder to the other side of the pin of zipper foot “1”.

If the presser foot holder was attached to the right side of the pin in step 8, change it to the left side of the pin.

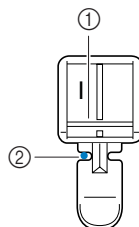

- ① Left side of the pin
- ② Needle drop point
- For details, refer to “Replacing the presser foot” (page 31).

- 13** **Topstitch along the zipper.**  
Sew reverse stitches at the end of the zipper opening and align the zipper teeth with the side of the presser foot.

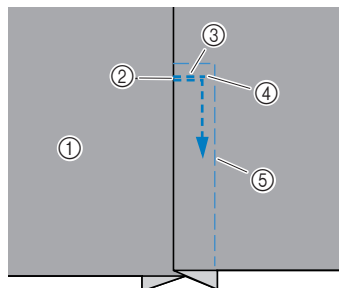

- ① Right side of fabric
- ② End of zipper opening
- ③ Reverse stitching
- ④ Beginning of stitching
- ⑤ Basting stitching

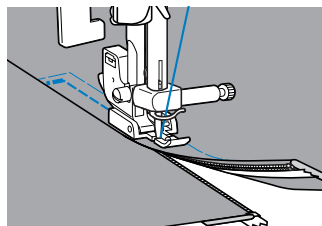

- 14** When you are about 5 cm (2 inches) from the end of the zipper, stop the sewing machine with the needle down (in the fabric), and then raise the presser foot lever.

- 15** Remove the basting stitching, open the zipper, and then continue sewing.



## Sewing Stretch Fabrics and Elastic Tape

Stretch fabrics can be sewn and elastic tape can be attached.

Stitch Name	Pattern	Presser Foot	Application	Stitch Width [mm (inch)]		Stitch Length [mm (inch)]		Twin Needle	Walk-ing Foot	Reverse/ Reinforcement Stitching
				Auto	Manual	Auto	Manual			
Stretch stitch	04 	J	Sewing stretch fabrics and decorative stitching	1.0 (1/16)	1.0–3.0 (1/16–1/8)	2.5 (3/32)	1.0–4.0 (1/16–3/16)	Yes (J)	No	Reinforcement
3-point zigzag stitch	06 	J	Overcasting on medium weight or stretch fabrics, attaching elastic, darning, etc.	5.0 (3/16)	1.5–7.0 (1/16–1/4)	1.0 (1/16)	0.2–4.0 (1/64–3/16)	Yes (J)	No	Reinforcement

The values below “Auto” are set when the pattern is selected. The setting can be adjusted to any value within the range indicated below “Manual”.

Observe the following precautions while stitching.



### CAUTION

- Before replacing the presser foot, be sure to turn off the sewing machine, otherwise injuries may occur if a button is accidentally pressed and the machine starts sewing.

### Stretch stitching

- 1 Turn on the machine.
- 2 With the pattern selection dial, select stitch .
  - For details, refer to “Replacing the presser foot” (page 31).
- 3 Attach zigzag foot “J”.

- 4 Sew without stretching the fabric.

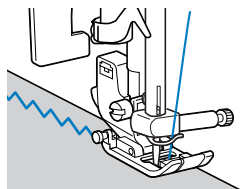

### Elastic attaching

When elastic tape is attached to the cuff or waist of a piece of clothing, the finished dimensions will be that of the stretched elastic tape. Therefore, it is necessary that a suitable length of the elastic tape be used.

- 1 Pin the elastic tape to the wrong side of the fabric.
  - Pin the elastic tape to the fabric at a few points to make sure that the tape is uniformly positioned on the fabric.

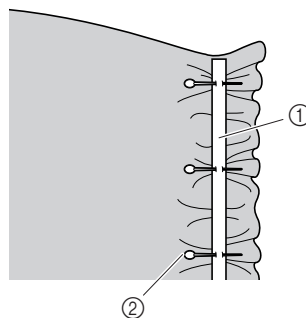

- ① Elastic tape
- ② Pin

- 2 Turn on the machine.

- 3** With the pattern selection dial, select stitch .

- 4** Attach zigzag foot “J”.
- For details, refer to “Replacing the presser foot” (page 31).

- 5** Sew the elastic tape to the fabric while stretching the tape so that it is the same length as the fabric.

While pulling the fabric behind the presser foot with your left hand, pull the fabric at the pin nearest the front of the presser foot with your right hand.

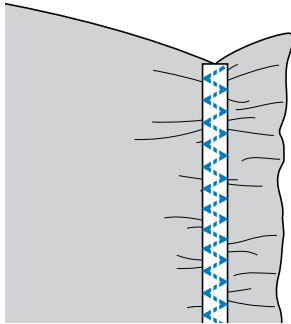
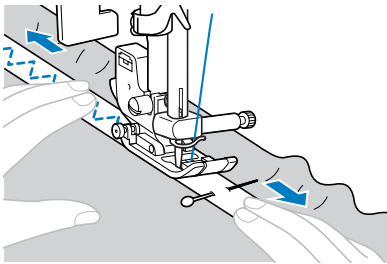

### CAUTION

- When sewing, make sure that the needle does not touch any pins, otherwise the needle may bend or break.

## Appliqué, Patchwork and Quilt Stitching

Eight stitches are available for sewing appliqués and patchwork quilts.

Stitch Name	Pattern	Presser Foot	Application	Stitch Width [mm (inch)]		Stitch Length [mm (inch)]		Twin Needle	Walking Foot	Reverse/Reinforcement Stitching
				Auto	Manual	Auto	Manual			
Zigzag stitch	05	J	Overcasting and attaching appliqués	3.5 (1/8)	0.0–7.0 (0–1/4)	1.4 (1/16)	0.0–4.0 (0–3/16)	Yes (J)	*1 Yes	Reverse
Appliqué stitch	13	J	Appliqué stitching	3.5 (1/8)	2.5–7.0 (3/32–1/4)	2.5 (3/32)	1.6–4.0 (1/16–3/16)	Yes (J)	No	Reinforcement
Piecing straight stitch	15	J	Piecing straight stitching (with a seam allowance of 6.5 mm (1/4 inch) from the right edge of the presser foot)	5.5 (7/32)	0.0–7.0 (0–1/4)	2.0 (1/16)	0.2–5.0 (1/64–3/16)	No	No	Reinforcement
Joining stitch	19	J	Patchwork stitching and decorative stitching	4.0 (3/16)	0.0–7.0 (0–1/4)	1.2 (1/16)	0.2–4.0 (1/64–3/16)	Yes (J)	No	Reinforcement
	20	J	Patchwork stitching, decorative stitching and sewing overcasting on both pieces of fabrics, such as with tricot	5.0 (3/16)	2.5–7.0 (3/32–1/4)	2.5 (3/32)	1.0–4.0 (1/16–3/16)	Yes (J)	No	Reinforcement
	21	J	Patchwork stitching and decorative stitching	5.0 (3/16)	0.0–7.0 (0–1/4)	1.2 (1/16)	0.2–4.0 (1/64–3/16)	Yes (J)	No	Reinforcement
Hand-look quilting	16	J	Straight stitch quilting that looks hand-sewn	0.0 (0)	0.0–7.0 (0–1/4)	2.5 (3/32)	1.0–4.0 (1/16–3/16)	No	No	Reinforcement
Quilting stitch (for stippling)	17	J	Quilting background stitching (stippling)	7.0 (1/4)	1.0–7.0 (1/16–1/4)	1.6 (1/16)	1.0–4.0 (1/16–3/16)	No	No	Reinforcement

\*1 Do not use reverse stitching.

The values below “Auto” are set when the pattern is selected. The setting can be adjusted to any value within the range indicated below “Manual”.

### CAUTION

- Before replacing the presser foot, be sure to turn off the sewing machine, otherwise injuries may occur if a button is accidentally pressed and the machine starts sewing.

## Appliqué stitching

- 1 Cut out the appliqué, leaving a seam allowance of between 3 and 5 mm (1/8 and 3/16 inch).

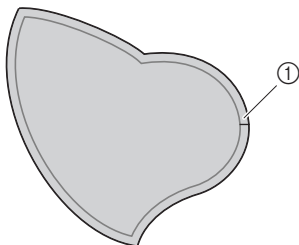

① Seam allowance

- 2 Place a pattern made of thick paper on the back of the appliqué, and then fold over the seam allowance using an iron.

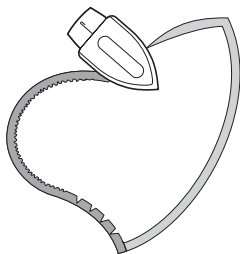

- 3 Turn the fabric over, and then baste, glue or pin it onto the fabric that it will be attached to.

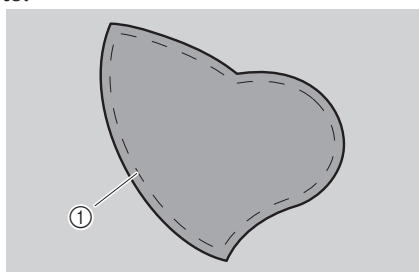

① Basting stitching

- 4 Turn on the machine.

- 5 With the pattern selection dial, select stitch 05 or 13.

- 6 Attach zigzag foot "J".
  - For details, refer to "Replacing the presser foot" (page 31).

- 7 Turn the handwheel toward you, and then begin sewing around the edge of the appliqué, making sure that the needle drops just outside of the appliqué.

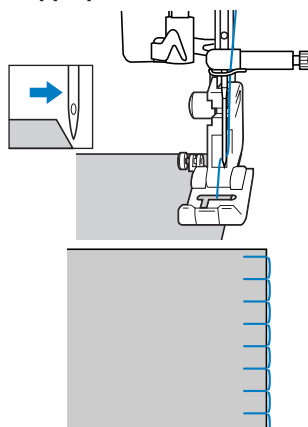

- When sewing around corners, stop the machine with the needle in the fabric just outside of the appliqué, raise the presser foot lever, and then turn the fabric as needed to change the sewing direction.

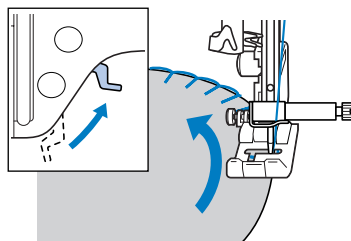

## Patchwork (crazy quilt) stitching

- 1 Fold the edge of the top piece of fabric and place it over the lower piece.
- 2 Sew the two pieces of fabric together so the pattern spans over both pieces.

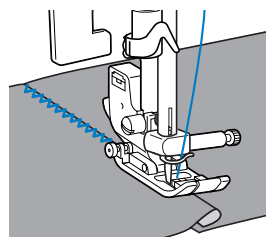



## Piecing

Sewing together two pieces of fabric is called “piecing”. The fabric pieces should be cut with a 6.5 mm (1/4 inch) seam allowance.

Sew a piecing straight stitch 6.5 mm (1/4 inch) from the right side of the presser foot.

- 1 **Baste or pin along the seam allowance of the fabric that you wish to piece together.**

- 2 **Turn on the machine.**

- 3 **Select stitch** 

- For details, refer to “Selecting a stitch” (page 40).

- 4 **Attach zigzag foot “J”.**

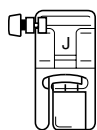

- For details, refer to “Replacing the presser foot” (page 31).

- 5 **Sew with the side of the presser foot aligned with the edge of the fabric.**

### ■ For a seam allowance on the right side

Align the right side of the presser foot with the edge of the fabric, and sew using stitch

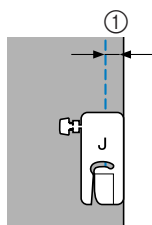

- ① 6.5 mm (1/4 inch)



### Memo

- To change the width of the seam allowance (the needle position), adjust the stitch width.

## Quilting

Sandwiching batting between the top and bottom layers of fabric is called “quilting”. Quilts can easily be sewn using the optional walking foot and the optional quilting guide.

- 1 **Baste the fabric to be quilted.**

- 2 **Attach the walking foot.**

- For details, refer to “Using the optional walking foot” (page 33).

- 3 **Select a stitch.**

- For details, refer to “Selecting a stitch” (page 40).

- 4 **Place one hand on each side of the presser foot, and hold fabric taut while sewing.**

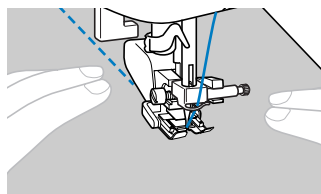

### Note

- When sewing with the walking foot, sew at a speed between slow and medium.

### ■ Using the optional quilting guide

Use the quilting guide to sew parallel stitches that are equally spaced.

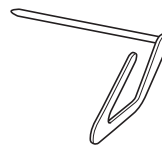

- 1 **Insert the stem of the quilting guide into the hole at the rear of the walking foot or presser foot holder.**

- Walking foot

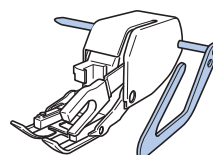

- Presser foot holder

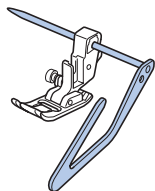

- 2 Adjust the stem of the quilting guide so that the guide aligns with the seam that has already been sewn.

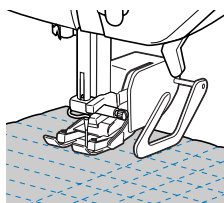

**Note**

- The optional quilting guide is available through your dealer.

## Free-motion quilting

With free-motion quilting, lower the feed dogs (using the feed dog position switch) so that the fabric is not fed.

The optional quilting foot is needed for free-motion quilting.

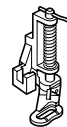

- 1 Turn off the sewing machine.
- 2 Remove the presser foot and the presser foot holder.
  - For details, refer to “Removing the presser foot holder” (page 32).
- 3 Attach the quilting foot to the presser foot holder screw.

The pin on the quilting foot should be positioned over the needle clamp screw.

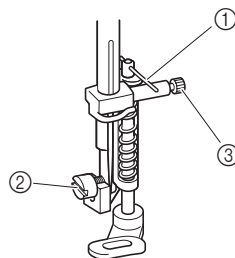

- ① Pin on quilting foot
- ② Presser foot holder screw
- ③ Needle clamp screw

- 4** Hold the quilting foot in place with your right hand, and then tighten the presser foot holder screw using the enclosed screwdriver in your left hand.

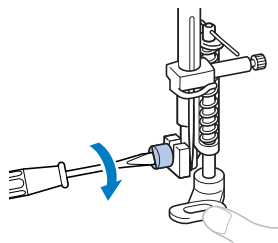

**CAUTION**

- Be sure to securely tighten the screw with the enclosed screwdriver, otherwise the needle may touch the presser foot, causing it to bend or break.

- 5** Slide the feed dog position switch, located at the rear of the machine on the base, to the position shown below to lower the feed dogs.

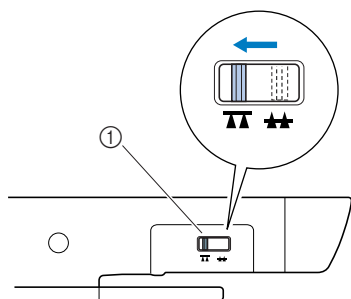

- ① Feed dog position switch (as seen from the rear of the machine)

- 6** Turn on the machine.

- 7** With the pattern selection dial, select stitch 02 or 05.

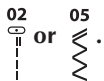

- 8** Use both hands to stretch the fabric taut, and then move the fabric to follow the pattern. Reinforcement stitches are sewn at the beginning and end of stitching.

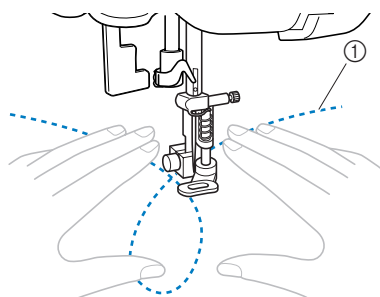

- ① Pattern
- Reverse stitches cannot be sewn when the feed dogs are lowered.

- 9** After sewing is finished, slide the feed dog position switch to its original position to raise the feed dogs.

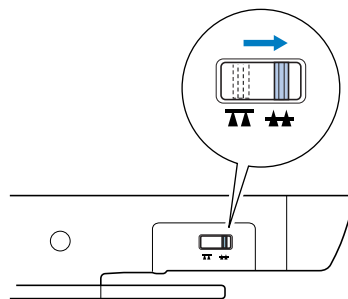



- The feed dogs are normally left raised.

**Memo**

- Turn the handwheel to raise the feed dogs.

## Reinforcement Stitching

Reinforce points that will be subject to strain, such as sleeve holes, inseams and pocket corners.

Stitch Name	Pattern	Presser Foot	Application	Stitch Width [mm (inch)]		Stitch Length [mm (inch)]		Twin Needle	Walking Foot	Reverse/Reinforcement Stitching
				Auto	Manual	Auto	Manual			
Triple stretch stitch	03 	J	Attaching sleeves, sewing inseams, sewing stretch fabrics and decorative stitching	0.0 (0)	0.0–7.0 (0–1/4)	2.5 (3/32)	1.5–4.0 (1/16–3/16)	Yes	No	Reinforcement
Bar tack stitch	35 	A	Reinforce openings and areas where the seam easily comes loose	2.0 (1/16)	1.0–3.0 (1/16-1/8)	0.4 (1/64)	0.3–1.0 (1/64-1/16)	No	No	Automatic Reinforcement

The values below “Auto” are set when the pattern is selected. The setting can be adjusted to any value within the range indicated below “Manual”.



### CAUTION

- Before replacing the presser foot, be sure to turn off the sewing machine, otherwise injuries may occur if a button is accidentally pressed and the machine starts sewing.

### Triple stretch stitching

With each stitch, three overlapping stitches are sewn.

- 1 Turn on the machine.
- 2 With the pattern selection dial, select stitch  .
- 3 Attach zigzag foot “J”.
  - For details, refer to “Replacing the presser foot” (page 31).
- 4 Start sewing.

### Changing the needle position

The needle position can be adjusted with the straight stitch (left needle position) and the triple stretch stitch by adjusting the stitch width. Press the “-” side of the stitch width key for a left needle position, or press the “+” side for a right needle position.

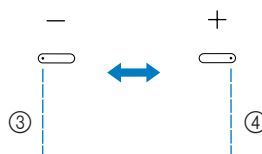
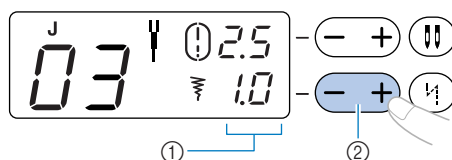

- ① Stitch width
- ② Stitch width key
- ③ Moves the needle position to the left
- ④ Moves the needle position to the right

## Bar tack stitching

Bar tacks are one type of reinforcement stitching used to strengthen points subject to strain, such as pocket corners and openings. As an example, the procedure for sewing bar tacks at pocket corners is described below.

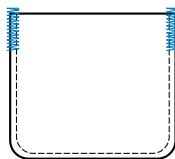

- 1 Determine the desired length of the bar tack.** Set the button guide plate on buttonhole foot "A" to the desired length. (The distance between the markings on the presser foot scale is 5 mm (3/16 inch).)

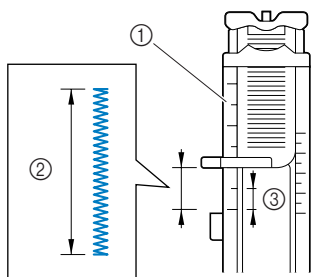

- Presser foot scale
- Length of bar tack
- 5 mm (3/16 inch)

- 2 Turn on the machine.**

- 3 With the pattern selection dial, select stitch 35.**

- 4 Attach buttonhole foot "A".**
  - For details, refer to "Replacing the presser foot" (page 31).

- 5 Pass the upper thread down through the hole in the presser foot, and then pull it under the presser foot, as shown.**

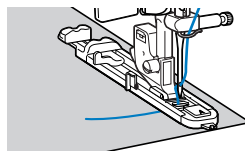

- 6 With the opening of the pocket toward you, position the fabric so that the needle drops 2 mm (1/16 inch) in front of the pocket opening, and then lower the presser foot lever.**

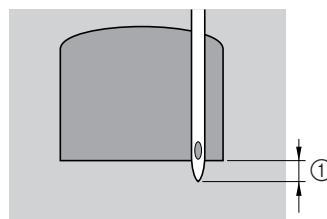

- 2 mm (1/16 inch)

### Note

- When lowering the presser foot, do not push in the front of the presser foot, otherwise the bar tack will not be sewn with the correct size.

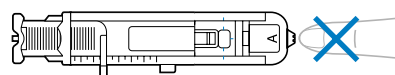

- 7** Pull down the buttonhole lever as far as possible.

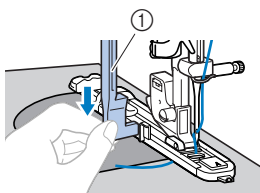

- ① Buttonhole lever

The buttonhole lever should be positioned behind the metal bracket on the buttonhole foot.

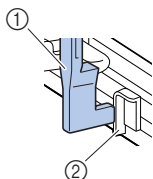

- ① Buttonhole lever  
② Bracket

- 8** Gently hold the end of the upper thread in your left hand, and then start sewing.

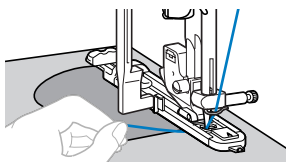

- Once sewing is completed, the machine automatically sews reinforcement stitches, then stops.

- 9** Raise the presser foot lever, cut the threads, and then remove the fabric.

- 10** Raise the buttonhole lever to its original position.















### Memo

- If the fabric does not feed, for example, because it is too thick, increase the stitch length. For details, refer to "Adjusting the stitch length and width" (page 40).

## Decorative stitching

Various decorative stitches can be sewn with this sewing machine.

Stitch Name	Pattern	Presser Foot	Application	Stitch Width [mm (inch)]		Stitch Length [mm (inch)]		Twin Needle	Walking Foot	Reverse/Reinforcement Stitching
				Auto	Manual	Auto	Manual			
Fagoting stitch		J	Fagoting, smocking and decorative stitching	5.0 (3/16)	0.0-7.0 (0-1/4)	2.5 (3/32)	1.0-4.0 (1/16-3/16)	Yes (J)	No	Reinforcement
		J	Fagoting, smocking and decorative stitching	5.0 (3/16)	2.5-7.0 (3/32-1/4)	2.5 (3/32)	1.0-4.0 (1/16-3/16)	Yes (J)	No	Reinforcement
Joining stitch		J	Patchwork stitching and decorative stitching	4.0 (3/16)	0.0-7.0 (0-1/4)	1.2 (1/16)	0.2-4.0 (1/64-3/16)	Yes (J)	No	Reinforcement
		J	Patchwork stitching, decorative stitching and sewing overcasting on both pieces of fabrics, such as with tricot	5.0 (3/16)	2.5-7.0 (3/32-1/4)	2.5 (3/32)	1.0-4.0 (1/16-3/16)	Yes (J)	No	Reinforcement
		J	Patchwork stitching and decorative stitching	5.0 (3/16)	0.0-7.0 (0-1/4)	1.2 (1/16)	0.2-4.0 (1/64-3/16)	Yes (J)	No	Reinforcement
Shell tuck stitch		J	Shell tuck stitching	4.0 (3/16)	0.0-7.0 (0-1/4)	2.5 (3/32)	0.2-4.0 (1/64-3/16)	Yes (J)	No	Reinforcement
Satin scallop stitch		N	Scallop stitching	5.0 (3/16)	2.5-7.0 (3/32-1/4)	0.5 (1/32)	0.1-1.0 (1/64-1/16)	Yes (J)	No	Reinforcement
Decorative stitch		J	Decorative stitching	4.0 (3/16)	0.0-7.0 (0-1/4)	3.0 (1/8)	2.0-4.0 (1/16-3/16)	No	No	Reinforcement
		J	Decorative stitching	4.0 (3/16)	0.0-7.0 (0-1/4)	2.5 (3/32)	1.0-4.0 (1/16-3/16)	Yes (J)	No	Reinforcement
		N	Decorative stitching and elastic-attaching	5.0 (3/16)	1.5-7.0 (1/64-1/4)	1.0 (1/16)	0.2-4.0 (1/64-3/16)	Yes (J)	No	Reinforcement
		N	Lace sewing, decorative hemming, heirloom stitching, etc.	3.5 (1/8)	1.5-7.0 (1/16-1/4)	2.5 (3/32)	1.6-4.0 (1/16-3/16)	No	No	Reinforcement
		N	Decorative hemming, heirloom stitching, etc.	6.0 (15/64)	1.5-7.0 (1/16-1/4)	3.0 (1/8)	1.5-4.0 (1/16-3/16)	No	No	Reinforcement



## Fagoting

Stitching across an open seam is called “fagoting”. It is used on blouses and children's clothing. This stitch is more decorative when thicker thread is used.

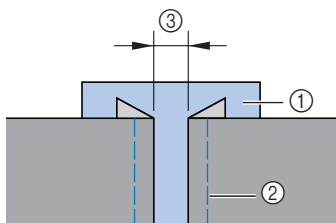
- 1 Use an iron to fold the two pieces of fabric along their seams.
- 2 Baste the two pieces of fabric, separated by about 4.0 mm (3/16 inch), onto thin paper or a sheet of water-soluble stabilizer.



- ① Thin paper or water soluble stabilizer
- ② Basting stitching
- ③ 4 mm (3/16 inch)

- 3 Turn on the machine.
- 4 Select stitch  or .
- 5 Attach zigzag foot “J”.
- 6 Set the stitch width to 7.0 mm (1/4 inch).
  - For details, refer to “Selecting a stitch” (page 40).
- 7 Sew with the center of the presser foot aligned along the center of the two pieces of fabric.

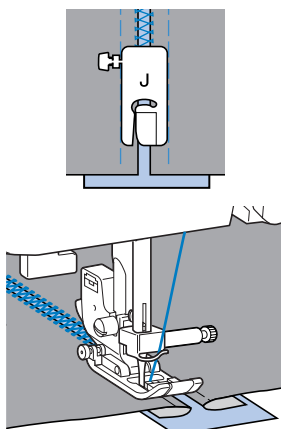

- 8 After sewing is finished, remove the paper.

## Scallop stitching

The wave-shaped repeating pattern that looks like shells is called “scalloping”. It is used on the collars of blouses and to decorate the edges of handkerchiefs.

- 1 Turn on the machine.
- 2 Select stitch  18.
- 3 Attach monogramming foot “N”.



- 4 Stitch along the edge of the fabric, making sure not to sew directly on the edge of the fabric.

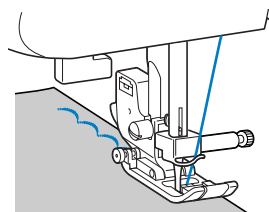

- For better results, apply spray starch onto the fabric and press with a hot iron before it is sewn.

- 5 Trim along the stitches.

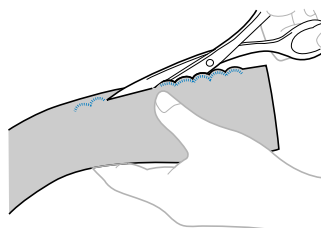

- Be careful not to cut the stitches.



## Smocking

The decorative stitch created by stitching or embroidering over gathers is called “smocking”. It is used to decorate the front of blouses or cuffs. The smocking stitch adds texture and elasticity to fabric.

- 1 Turn on the machine.
- 2 Select the straight stitch, and then adjust the stitch length to 4.0 mm (3/16 inch) and loosen the thread tension.
  - For details, refer to “Selecting a stitch” (page 40) and “Adjusting the thread tension” (page 47).
- 3 Attach zigzag foot “J”.
- 4 Sew parallel stitching at intervals of 1 cm (3/8 inch).

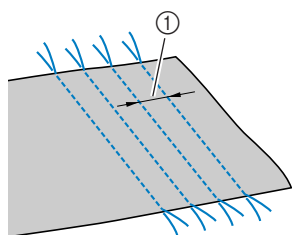

- ① 1 cm (3/8 inch)
- Do not sew reverse/reinforcement stitches or cut the thread.

- 5 Pull the bobbin threads to create gathers. Smooth the gathers by ironing them.

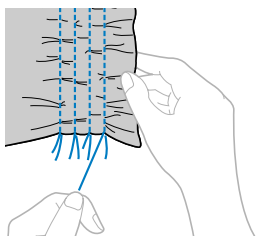

- 6 Select stitch  or .

- 7 Stitch between the straight stitches.

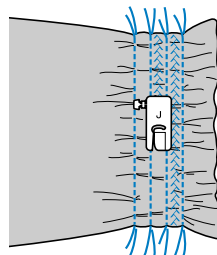

- 8 Pull out the threads for the straight stitches.

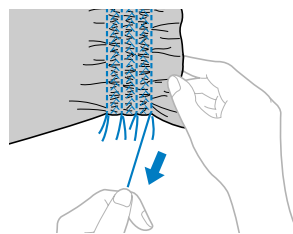

## Shell tuck stitching

The gathers that look like shells are called “shell tucks”. They are used to decorate trims, the front of blouses or cuffs made of thin fabrics.

- 1 Fold the fabric along the bias.

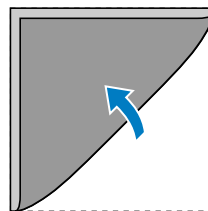

- 2 Turn on the machine.
- 3 Select stitch , and then increase the thread tension.
  - For details, refer to “Selecting a stitch” (page 40).
- 4 Attach zigzag foot “J”.

- 5** Sew while making sure that the needle drops slightly off the edge of the fabric.

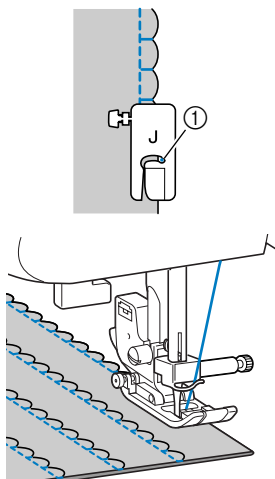

① Needle drop point

- 6** Unfold the fabric, and then iron the tucks down to one side.

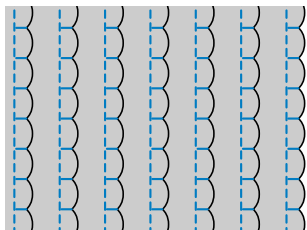

## Joining

Decorative bridging stitches can be sewn over the seam allowance of joined fabrics. This is used when making a crazy quilt.

- 1** Turn on the machine.
- 2** Sew together the right sides of the two pieces of fabric, and then open up the seam allowances.



① Wrong side of fabric  
② 6.5 mm (1/4 inch) seam allowance  
③ Straight stitch

- 3** Select stitch 19, 20 or 21.

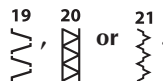

- 4** Attach zigzag foot "J".

- 5** Turn the fabric over so that the right side faces up, and then sew over the seam with the center of the presser foot aligned with the seam.

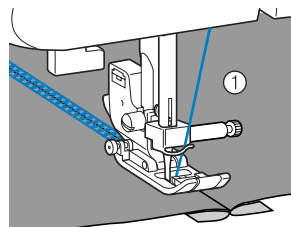

① Right side of fabric

## Heirloom stitching

When sewing with the wing needle, the needle holes are enlarged, creating a lace-like decorative stitch. This is used to decorate hems and tablecloths on thin or medium weight fabrics in addition to plain weave fabrics.

### CAUTION

- The needle threader cannot be used with the wing needle, otherwise the sewing machine may be damaged. Manually pass the thread through the eye of the needle from the front to the back. For details, refer to "Manually threading the needle" (page 24).

- 1** Insert the wing needle.

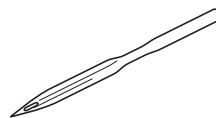

- Use a 130/705H 100/16 wing needle.
- For details on inserting a needle, refer to "Replacing the needle" (page 29).

- 2** Turn on the machine.

- 3** Select stitch 27, 28 or 29.

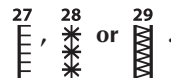

4 Attach monogramming foot "N".

**CAUTION**

- Select a stitch width of 6.0 mm (15/64 inch) or less, otherwise the needle may bend or break.
- After adjusting the stitch width, slowly turn the handwheel toward you (counterclockwise) and check that the needle does not touch the presser foot. If the needle hits the presser foot, the needle may bend or break.

5 Start sewing.

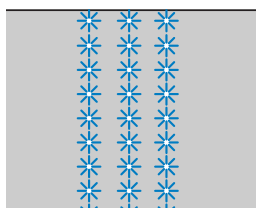

■ Drawnwork (Example 1)

The fabric is turned and sewn twice.

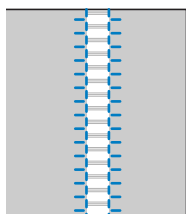

1 Pull out several threads from the fabric.

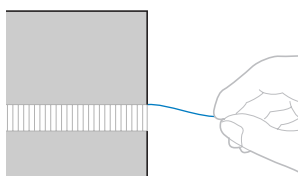

2 Attach monogramming foot "N".

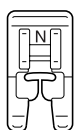

- For details, refer to "Replacing the presser foot" (page 31).

3 Select stitch .

- For details, refer to "Selecting a stitch" (page 40).

4 With the right side of the fabric facing up, sew along the right edge of the frayed section.

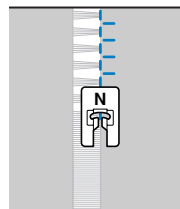

5 Turn the fabric around to sew the opposite side.

6 Sew along the other edge of the frayed section so that it looks like the previous stitching.

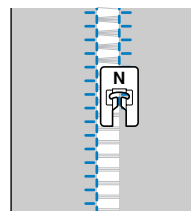

■ Drawnwork (Example 2)

1 Pull out several threads from two sections of the fabric, separated by an unfrayed section of about 4 mm (3/16 inch).

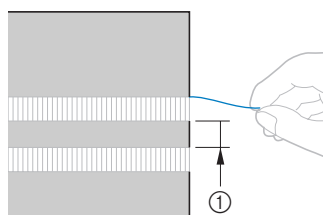

① 4 mm (3/16 inch)

2 Attach monogramming foot "N".

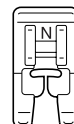

- For details, refer to "Replacing the presser foot" (page 31).

③ Select stitch  29.

- For details, refer to “Selecting a stitch” (page 40).

④ Sew along the center of the unfrayed section.

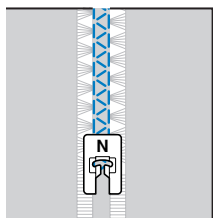

## Using the side cutter (optional)

By using the optional side cutter, overcasting stitching can be sewn while the edge of the fabric is cut off.

Stitch Name	Pattern	Presser Foot	Application	Stitch Width [mm (inch)]		Stitch Length [mm (inch)]		Reverse/Reinforcement Stitching
				Auto	Manual	Auto	Manual	
Overcasting stitch	01 ---=0	S	Basic stitching, sewing gathers or pintucks, etc.	0.0 (0)	0.0–2.5 (0–3/32)	2.5 (3/32)	0.2–5.0 (1/64–3/16)	Reverse
	07 W	S	Overcasting on thin or medium weight fabrics	3.5 (1/8)	2.5–5.0 (3/32–3/16)	2.0 (1/16)	1.0–4.0 (1/16–3/16)	Reinforcement
	08 W	S	Overcasting on thick fabrics	5.0 (3/16)	2.5–5.0 (3/32–3/16)	2.5 (3/32)	1.0–4.0 (1/16–3/16)	Reinforcement
	09 W	S	Preventing fraying in thick fabrics and fabrics that fray easily	5.0 (3/16)	3.5–5.0 (1/8–3/16)	2.5 (3/32)	1.0–4.0 (1/16–3/16)	Reinforcement

The values below “Auto” are set when the pattern is selected. The setting can be adjusted to any value within the range indicated below “Manual”. When using the side cutter, adjust the stitch width setting to a value within the range indicated in the table above.



### CAUTION

- Before replacing the presser foot and presser foot holder, be sure to turn off the sewing machine, otherwise injuries may occur if a button is accidentally pressed and the machine starts sewing.

- 1 Remove the presser foot.
  - For details, refer to “Replacing the presser foot” (page 31).
- 2 Thread the upper thread.
  - For details, refer to “Threading the upper thread” (page 20).



### Note

- The needle threader cannot be used while the side cutter is installed on the sewing machine, otherwise damage to the needle threader may result.

- 3 Select a stitch.
  - For details, refer to “Selecting a stitch” (page 40).
- 4 Raise the presser foot lever.

- 5 Raise the presser foot lever even higher, and then hook the connecting fork of the side cutter onto the needle clamp screw.

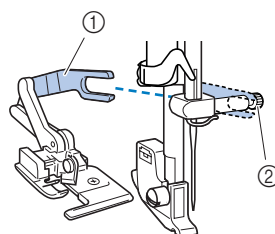

- ① Connecting fork
- ② Needle clamp screw

- 6** Position the side cutter so that the side cutter pin is aligned with the notch in the presser foot holder, and then slowly lower the presser foot lever.

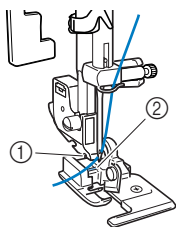

- ① Notch in presser foot holder
- ② Pin
- ▶ The side cutter is attached.

- 7** Raise the presser foot lever to check that the side cutter is securely attached.

- 8** Pass the upper thread under the side cutter, and then pull it out toward the rear of the sewing machine.

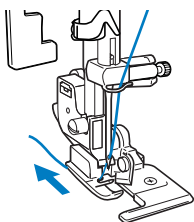

**! CAUTION**

- After adjusting the stitch width, slowly turn the handwheel toward you and check that the needle does not touch the presser foot. If the needle hits the presser foot, the needle may bend or break.

- 9** Make a cut of about 2 cm (3/4 inch) long in the fabric at the beginning of the stitching.

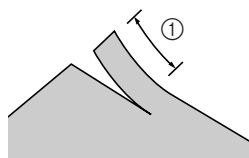

- ① 2 cm (3/4 inch)

- 10** Position the fabric.

Position the fabric so that the right side of the cut is on top of the guide plate and the left side of the cut is underneath the presser foot.

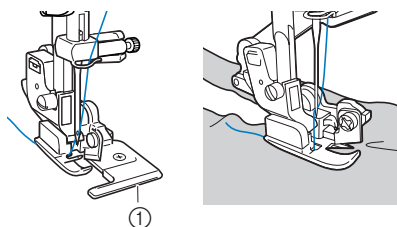

- ① Guide plate

**Note**

- If the fabric is not positioned correctly, the fabric will not be cut.

- 11** Lower the presser foot lever, and then start sewing.

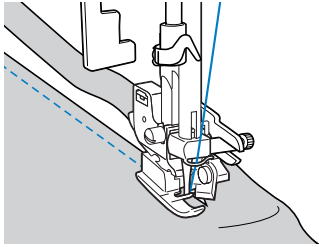

- A seam allowance is cut while the stitching is sewn.

If stitch <sup>01</sup> is sewn, the seam allowance will be about 5 mm (3/16 inch).

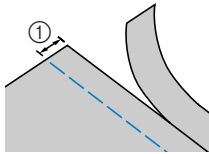

- ① 5 mm (3/16 inch)



#### Note

- The side cutter can cut as much as one layer of 13-oz. denim.
- After using the side cutter, clean it by removing any lint or dust.
- If the side cutter can no longer cut fabric, use a rag to apply a small amount of oil to the cutting edge of the cutter.





# 4

# APPENDIX

## Stitch settings

Applications, stitch lengths and widths and whether the twin needle can be used are listed for utility stitches in the following table.















### CAUTION











- When using the twin needle, be sure to attach zigzag foot “J”, otherwise the needle may break or the machine may be damaged.











## Utility stitches

Stitch Name	Pattern	Presser Foot	Application	Stitch Width [mm (inch)]		Stitch Length [mm (inch)]		Twin Needle	Walk-ing Foot	Reverse/ Reinforcement Stitching
				Auto	Manual	Auto	Manual			
Straight stitch	Left	01 	J Basic stitching, sewing gathers or pintucks, etc.	0.0 (0)	0.0–7.0 (0–1/4)	2.5 (3/32)	0.2–5.0 (1/64–3/16)	Yes (J)	*1 Yes	Reverse
	Center	02 	J Attaching zippers, basic stitching, and sewing gathers or pintucks, etc.	3.5 (1/8)	0.0–7.0 (0–1/4)	2.5 (3/32)	0.2–5.0 (1/64–3/16)	Yes (J)	*1 Yes	Reverse
Triple stretch stitch	03 	J	Attaching sleeves, sewing inseams, sewing stretch fabrics and decorative stitching	0.0 (0)	0.0–7.0 (0–1/4)	2.5 (3/32)	1.5–4.0 (1/16–3/16)	Yes (J)	No	Reinforcement
Stretch stitch	04 	J	Sewing stretch fabrics and decorative stitching	1.0 (1/16)	1.0–3.0 (1/16–1/8)	2.5 (3/32)	1.0–4.0 (1/16–3/16)	Yes (J)	No	Reinforcement
Zigzag stitch	05 	J	Overcasting and attaching appliqués	3.5 (1/8)	0.0–7.0 (0–1/4)	1.4 (1/16)	0.0–4.0 (0–3/16)	Yes (J)	*1 Yes	Reverse
3-point zigzag stitch	06 	J	Overcasting on medium weight or stretch fabrics, attaching elastic, darning, etc.	5.0 (3/16)	1.5–7.0 (1/16–1/4)	1.0 (1/16)	0.2–4.0 (1/64–3/16)	Yes (J)	No	Reinforcement

\*1 Do not use reverse stitching.

Stitch Name	Pattern	Presser Foot	Application	Stitch Width [mm (inch)]		Stitch Length [mm (inch)]		Twin Needle	Walk- ing Foot	Reverse/ Reinforcement Stitching
				Auto	Manual	Auto	Manual			
Overcasting stitch		G	Overcasting on thin or medium weight fabrics	3.5 (1/8)	2.5–5.0 (3/32–3/16)	2.0 (1/16)	1.0–4.0 (1/16–3/16)	No	No	Reinforcement
		G	Overcasting on thick fabrics	5.0 (3/16)	2.5–5.0 (3/32–3/16)	2.5 (3/32)	1.0–4.0 (1/16–3/16)	No	No	Reinforcement
		G	Preventing fraying in thick fabrics and fabrics that fray easily	5.0 (3/16)	3.5–5.0 (1/8–3/16)	2.5 (3/32)	1.0–4.0 (1/16–3/16)	No	No	Reinforcement
		J	Overcasting on stretch fabrics	5.0 (3/16)	0.0–7.0 (0–1/4)	2.5 (3/32)	0.5–4.0 (1/32–3/16)	Yes (J)	No	Reinforcement
Blind hem stitch		R	Blind hem stitching on medium weight fabrics	0 (0)	–3 – 3	2.0 (1/16)	1.0–3.5 (1/16–1/8)	No	No	Reinforcement
		R	Blind hem stitching on stretch fabrics	0 (0)	–3 – 3	2.0 (1/16)	1.0–3.5 (1/16–1/8)	No	No	Reinforcement
Appliqué stitch		J	Appliqué stitching	3.5 (1/8)	2.5–7.0 (3/32–1/4)	2.5 (3/32)	1.6–4.0 (1/16–3/16)	Yes (J)	No	Reinforcement
Shell tuck stitch		J	Shell tuck stitching	4.0 (3/16)	0.0–7.0 (0–1/4)	2.5 (3/32)	0.2–4.0 (1/64–3/16)	Yes (J)	No	Reinforcement
Piecing straight stitch		J	Piecing straight stitching (with a seam allowance of 6.5 mm (1/4 inch) from the right edge of the presser foot)	5.5 (7/32)	0.0–7.0 (0–1/4)	2.0 (1/16)	0.2–5.0 (1/64–3/16)	No	No	Reinforcement
Hand-look quilt- ing		J	Straight stitch quilting that looks hand-sewn	0.0 (0)	0.0–7.0 (0–1/4)	2.5 (3/32)	1.0–4.0 (1/16–3/16)	No	No	Reinforcement
Quilting stitch (for stippling)		J	Quilting background stitching (stippling)	7.0 (1/4)	1.0–7.0 (1/16–1/4)	1.6 (1/16)	1.0–4.0 (1/16–3/16)	No	No	Reinforcement
Satin scallop stitch		N	Scallop stitching	5.0 (3/16)	2.5–7.0 (3/32–1/4)	0.5 (1/32)	0.1–1.0 (1/64–1/16)	Yes (J)	No	Reinforcement

Stitch Name	Pattern	Presser Foot	Application	Stitch Width [mm (inch)]		Stitch Length [mm (inch)]		Twin Needle	Walking Foot	Reverse/Reinforcement Stitching
				Auto	Manual	Auto	Manual			
Joining stitch		J	Patchwork stitching and decorative stitching	4.0 (3/16)	0.0–7.0 (0–1/4)	1.2 (1/16)	0.2–4.0 (1/64–3/16)	Yes (J)	No	Reinforcement
		J	Patchwork stitching, decorative stitching and sewing overcasting on both pieces of fabrics, such as with tricot	5.0 (3/16)	2.5–7.0 (3/32–1/4)	2.5 (3/32)	1.0–4.0 (1/16–3/16)	Yes (J)	No	Reinforcement
		J	Patchwork stitching and decorative stitching	5.0 (3/16)	0.0–7.0 (0–1/4)	1.2 (1/16)	0.2–4.0 (1/64–3/16)	Yes (J)	No	Reinforcement
Fagoting stitch		J	Fagoting, smocking and decorative stitching	5.0 (3/16)	0.0–7.0 (0–1/4)	2.5 (3/32)	1.0–4.0 (1/16–3/16)	Yes (J)	No	Reinforcement
		J	Fagoting, smocking and decorative stitching	5.0 (3/16)	2.5–7.0 (3/32–1/4)	2.5 (3/32)	1.0–4.0 (1/16–3/16)	Yes (J)	No	Reinforcement
Decorative stitch		J	Decorative stitching	4.0 (3/16)	0.0–7.0 (0–1/4)	3.0 (1/8)	2.0–4.0 (1/16–3/16)	No	No	Reinforcement
		J	Decorative stitching	4.0 (3/16)	0.0–7.0 (0–1/4)	2.5 (3/32)	1.0–4.0 (1/16–3/16)	Yes (J)	No	Reinforcement
		N	Decorative stitching and elastic-attaching	5.0 (3/16)	1.5–7.0 (1/64–1/4)	1.0 (1/16)	0.2–4.0 (1/64–3/16)	Yes (J)	No	Reinforcement
		N	Lace sewing, decorative hemming, heirloom stitching, etc.	3.5 (1/8)	1.5–7.0 (1/16–1/4)	2.5 (3/32)	1.6–4.0 (1/16–3/16)	No	No	Reinforcement
		N	Decorative hemming, heirloom stitching, etc.	6.0 (15/64)	1.5–7.0 (1/16–1/4)	3.0 (1/8)	1.5–4.0 (1/16–3/16)	No	No	Reinforcement
		N	Decorative hemming on thin, medium weight and plain weave fabrics, heirloom stitching, etc.	5.0 (3/16)	1.5–7.0 (1/16–1/4)	4.0 (3/16)	1.5–4.0 (1/16–3/16)	No	No	Reinforcement

Stitch Name	Pattern	Presser Foot	Application	Stitch Width [mm (inch)]		Stitch Length [mm (inch)]		Twin Needle	Walk- ing Foot	Reverse/ Reinforcement Stitching
				Auto	Manual	Auto	Manual			
Buttonhole stitch		A	Horizontal buttonholes on thin and medium weight fabrics	5.0 (3/16)	3.0-5.0 (1/8-3/16)	0.5 (1/32)	0.2-1.0 (1/64-1/16)	No	No	Automatic Reinforcement
		A	Secured buttonholes for fabrics that have backings	5.0 (3/16)	3.0-5.0 (1/8-3/16)	0.5 (1/32)	0.2-1.0 (1/64-1/16)	No	No	Automatic Reinforcement
		A	Buttonholes for stretch or knit fabrics	6.0 (15/64)	3.0-6.0 (1/8-15/64)	1.0 (1/16)	0.5-2.0 (1/32-1/16)	No	No	Automatic Reinforcement
		A	Buttonholes for stretch fabrics	6.0 (15/64)	3.0-6.0 (1/8-15/64)	1.5 (1/16)	1.0-3.0 (1/16-1/8)	No	No	Automatic Reinforcement
		A	Keyhole buttonholes for thick or furry fabrics	7.0 (1/4)	3.0-7.0 (1/8-1/4)	0.5 (1/32)	0.3-1.0 (1/64-1/16)	No	No	Automatic Reinforcement
Bar tack stitch		A	Reinforcing openings and areas where the seam easily comes loose	2.0 (1/16)	1.0-3.0 (1/16-1/8)	0.4 (1/64)	0.3-1.0 (1/64-1/16)	No	No	Automatic Reinforcement
Decorative stitch		N	For decoration, etc.	7.0 (1/4)	0.0-7.0 (0-1/4)	2.5 (3/32)	0.2-4.0 (1/64-3/16)	No	No	Reinforcement
Satin stitches		N	For decoration, etc.	7.0 (1/4)	2.5-7.0 (3/32-1/4)	0.4 (1/64)	0.1-1.0 (1/64-1/16)	Yes (J)	No	Reinforcement
		N	For decoration, etc.	7.0 (1/4)	2.5-7.0 (3/32-1/4)	0.4 (1/64)	0.1-1.0 (1/64-1/16)	Yes (J)	No	Reinforcement
		N	For decoration, etc.	7.0 (1/4)	2.5-7.0 (3/32-1/4)	0.4 (1/64)	0.1-1.0 (1/64-1/16)	Yes (J)	No	Reinforcement
Cross-stitches		N	For decoration, etc.	6.0 (15/64)	0.0-7.0 (0-1/4)	1.4 (1/16)	0.2-4.0 (1/64-3/16)	No	No	Reinforcement

## Maintenance

Simple sewing machine maintenance operations are described below.

### Cleaning the machine surface

If the surface of the machine is dirty, lightly soak a cloth in neutral detergent, squeeze it out firmly, and then wipe the surface of the machine. After cleaning it once with a wet cloth, wipe it again with a dry cloth.

#### ! CAUTION

- Make sure that the sewing machine has been turned off, and then unplug the power cord before cleaning the machine, otherwise injuries or an electric shock may occur.
- Do not use benzene, thinner or cleansing powder, otherwise the machine may be discolored or deformed.

### Cleaning the race

Clean the hook and under the needle plate. Sewing performance will suffer if lint and dust collect in the race; therefore, it should be cleaned periodically.

- 1 Turn off the sewing machine, and then unplug the power cord from the electrical outlet.

#### ! CAUTION

- Make sure that the sewing machine has been turned off, and then unplug the power cord before cleaning the machine, otherwise injuries or an electric shock may occur.

- 2 Raise the needle and presser foot lever.

- 3 Pull the flat bed attachment off to the left.

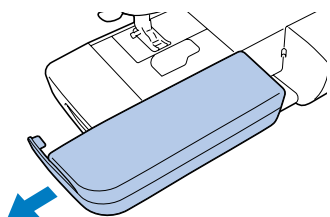

- 4 Loosen the presser foot holder screw and remove the presser foot holder, and then loosen the needle clamp screw and remove the needle.

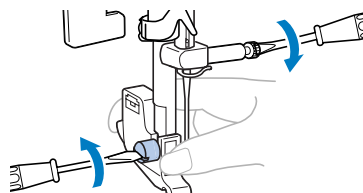

- 5 Grasp both sides of the needle plate cover, and then slide it toward you to remove it.

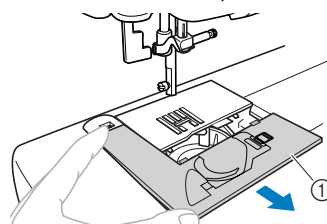

① Needle plate cover

- 6 Remove the bobbin case.

Grasp the front of the bobbin case, and then pull it out.

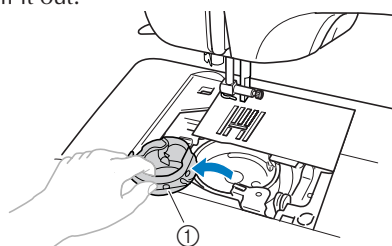

① Bobbin case

- 7 Use the enclosed cleaning brush or a vacuum cleaner to remove any lint and dust from the race and its surrounding area.

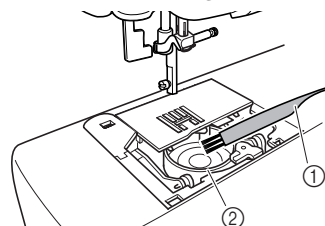

① Cleaning brush

② Race

- Do not apply oil to the race or bobbin case.

- 8** Insert the bobbin case so that the ▲ mark on the bobbin case aligns with the ● mark on machine as shown below.

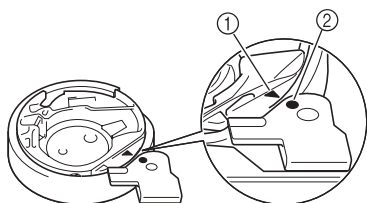
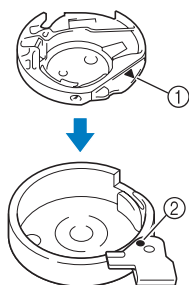

- Align the ▲ and ● marks.

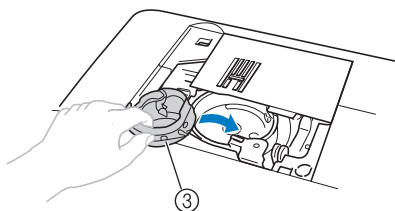

- ① ▲ mark
- ② ● mark
- ③ Bobbin case

- Make sure that the indicated points are aligned before installing the bobbin case.

### CAUTION

- Never use a bobbin case that is scratched, otherwise the upper thread may become tangled, the needle may break, or sewing performance may suffer. For a new bobbin case, contact your nearest authorized service center.
- Be sure that the bobbin case is correctly installed, otherwise the needle may break.

- 9** Insert the tabs on the needle plate cover into the needle plate, and then slide the cover back into position.

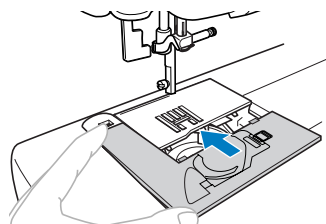

### Removing the needle plate

When the thread is tangled and cannot be removed by cleaning the race, remove the needle plate.

- 1 Follow steps 1 through 6 on page 91.
- 2 Remove the needle plate by removing the screws with the disc-shaped screwdriver.

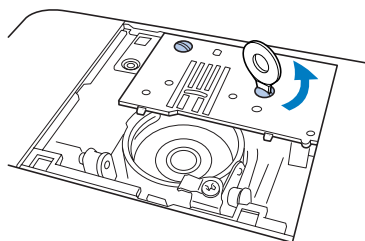

- 3 Remove the tangled thread from the needle plate.
- 4 Return the needle plate to its original position, and then tighten the screws with the disc-shaped screwdriver.

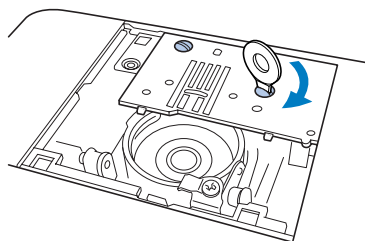

### Note

- Align the two screw holes on the needle plate with the two holes on the machine.

- 5 Follow steps 7 through 9 beginning on page 91.

## Troubleshooting

If the machine stops operating correctly, check for the following possible causes before requesting service. If the problem persists, contact your dealer or the nearest authorized service center.

Symptom	Probable Cause	Remedy	Reference
<b>The sewing machine does not operate.</b>	The plug of the power cord is not inserted into an electrical outlet.	Insert the plug of the power cord into a household electrical outlet.	page 14
	The machine is not turned on.	Turn on the machine.	page 14
	The bobbin winder shaft is moved to the right.	Slide the bobbin winder shaft to the left.	page 17
	The presser foot lever is raised.	Lower the presser foot lever.	page 42
	A stitch other than the buttonhole or bar tack stitch was selected and the start/stop button was pressed while the buttonhole lever is lowered.	Raise the buttonhole lever.	–
	The buttonhole or bar tack stitch was selected and the start/stop button was pressed while the buttonhole lever is raised.	Pull down the buttonhole lever.	page 59
	The start/stop button was pressed, even though the foot controller is connected.	Do not use the start/stop button when the foot controller is connected. To use the start/stop button, disconnect the foot controller.	page 42
<b>The needle breaks.</b>	The needle is incorrectly installed.	Correctly install the needle.	page 29
	The needle clamp screw is loose.	Use the screwdriver to firmly tighten the screw.	page 30
	The needle is bent or blunt.	Replace the needle with a new one.	page 29
	The combination of fabric, thread and needle is incorrect.	Select a thread and needle that are appropriate for the type of fabric being sewn.	page 28
	The appropriate presser foot for the type of stitch that you wish to sew is not used.	Attach the presser foot that is appropriate for the type of stitch that you wish to sew.	page 87
	The upper thread tension is too tight.	Loosen the upper thread tension.	page 47
	The fabric is pulled too much.	Lightly guide the fabric.	–
	The area around the hole in the needle plate is scratched.	Replace the needle plate. Contact your dealer or the nearest authorized service center.	–
	The area around the hole in the presser foot is scratched.	Replace the presser foot. Contact your dealer or the nearest authorized service center.	–
	The bobbin case is scratched.	Replace the bobbin case. Contact your dealer or the nearest authorized service center.	–
	A bobbin designed specifically for this machine is not used.	Bobbins from older models, which have a different thickness, will not work properly. Only use a bobbin designed specifically for this machine.	page 15

Symptom	Probable Cause	Remedy	Reference
<b>The upper thread breaks.</b>	The upper thread was incorrectly threaded (for example, the spool is incorrectly installed or the thread has come out of the needle bar thread guide).	Correct the upper threading.	page 20
	There are knots or tangles in the thread.	Remove any knots or tangles.	–
	The selected needle is not appropriate for the thread being used.	Select a needle that is appropriate for the type of stitch being used.	page 28
	The upper thread tension is too tight.	Loosen the upper thread tension.	page 47
	The thread is tangled, for example, in the bobbin case.	Remove the tangled thread. If the thread is tangled in the bobbin case, clean the race.	page 91
	The needle is bent or blunt.	Replace the needle with a new one.	page 29
	The needle is incorrectly installed.	Correctly install the needle.	page 29
	The area around the hole in the needle plate is scratched.	Replace the needle plate. Contact your dealer or the nearest authorized service center.	–
	The area around the hole in the presser foot is scratched.	Replace the presser foot. Contact your dealer or the nearest authorized service center.	–
	The bobbin case is scratched.	Replace the bobbin case. Contact your dealer or the nearest authorized service center.	–
A bobbin designed specifically for this machine is not used.	Bobbins from older models, which have a different thickness, will not work properly. Only use a bobbin designed specifically for this machine.	page 15	
<b>The lower thread is tangled or breaks.</b>	The bobbin thread is incorrectly installed.	Correct the bobbin threading.	page 18
	The bobbin thread is incorrectly wound.	Correctly wind the bobbin.	page 15
	There are scratches on the bobbin or it doesn't rotate properly.	Replace the bobbin.	–
	The thread is tangled.	Remove the tangled thread and clean the race.	page 91
	A bobbin designed specifically for this machine is not used.	Bobbins from older models, which have a different thickness, will not work properly. Only use a bobbin designed specifically for this machine.	page 15



Symptom	Probable Cause	Remedy	Reference
<b>The thread tension is incorrect.</b>	The upper thread is incorrectly installed.	Correct the upper threading.	page 20
	The bobbin thread is incorrectly installed.	Correct the bobbin threading.	page 18
	The bobbin thread is incorrectly wound.	Correctly wind the bobbin.	page 15
	The combination of fabric, thread and needle is incorrect.	Select a thread and needle that are appropriate for the type of fabric being sewn.	page 28
	The presser foot holder is incorrectly installed.	Correctly install the presser foot holder.	page 33
	The thread tension is incorrectly set.	Adjust the thread tension.	page 47
	A bobbin designed specifically for this machine is not used.	Bobbins from older models, which have a different thickness, will not work properly. Only use a bobbin designed specifically for this machine.	page 15
<b>The fabric is puckered.</b>	The upper thread or bobbin thread is incorrectly installed.	Correctly thread the upper thread and correctly install the bobbin thread.	page 18, 20
	The spool is incorrectly installed.	Correctly install the spool.	page 15
	The combination of fabric, thread and needle is incorrect.	Select a thread and needle that are appropriate for the type of fabric being sewn.	page 28
	The needle is bent or blunt.	Replace the needle with a new one.	page 29
	If thin fabrics are being sewn, the stitch is too long or the fabric is not being fed correctly.	Sew with stabilizer material under the fabric.	page 49
	The thread tension is incorrectly set.	Adjust the thread tension.	page 47
<b>Stitches are skipped.</b>	The upper thread is incorrectly installed.	Correct the upper threading.	page 20
	The combination of fabric, thread and needle is incorrect.	Select a thread and needle that are appropriate for the type of fabric being sewn.	page 28
	The needle is bent or blunt.	Replace the needle with a new one.	page 29
	The needle is incorrectly installed.	Correctly install the needle.	page 29
	Dust has accumulated under the needle plate or in the bobbin case.	Remove the needle plate cover and clean the bobbin case.	page 91
<b>A high-pitched sound is produced while sewing. A rattling noise is produced.</b>	Dust has accumulated in the feed dogs or in the bobbin case.	Clean the bobbin case.	page 91
	The upper thread is incorrectly installed.	Correct the upper threading.	page 20
	The bobbin case is scratched.	Replace the bobbin case. Contact your dealer or the nearest authorized service center.	–
	A bobbin designed specifically for this machine is not used.	Bobbins from older models, which have a different thickness, will not work properly. Only use a bobbin designed specifically for this machine.	page 15

Symptom	Probable Cause	Remedy	Reference
<b>The thread does not pass through the eye of the needle.</b>	The needle was not raised.	Press ⊕ (needle position button) once or twice to raise the needle.	page 21
	The needle is incorrectly installed.	Correctly install the needle.	page 29
<b>The stitch is not sewn correctly.</b>	The appropriate presser foot for the type of stitch that you wish to sew is not used.	Attach the presser foot that is appropriate for the type of stitch that you wish to sew.	page 87
	The thread tension is incorrectly set.	Adjust the thread tension.	page 47
	The thread is tangled, for example, in the bobbin case.	Remove the tangled thread. If the thread is tangled in the bobbin case, clean the race.	page 91
<b>The fabric does not feed.</b>	The feed dogs are lowered.	Slide the feed dog position switch to  .	page 73
	The stitch is too short.	Lengthen the stitch length.	page 40
	The combination of fabric, thread and needle is incorrect.	Select a thread and needle that are appropriate for the type of fabric being sewn.	page 28
	The thread is tangled, for example, in the bobbin case.	Remove the tangled thread. If the thread is tangled in the bobbin case, clean the race.	page 91
<b>The sewing lamp does not come on.</b>	The sewing lamp is damaged.	Contact your dealer or the nearest authorized service center.	–

## Error messages

If the sewing machine is incorrectly operated or if the sewing machine malfunctions, an error message appears in the LCD.

The message can be cleared by pressing any key in the operation panel, turning any dial, or performing the operation correctly.

Error Message (in LCD)	Probable Cause	Remedy
E1	The start/stop button or the reverse/reinforcement stitch button was pressed (The foot controller was depressed if it is connected.) while the presser foot is raised.	Lower the presser foot before continuing the operation.
E2	A stitch other than the buttonhole or bar tack stitch was selected and the start/stop button was pressed (The foot controller was depressed if it is connected.) while the buttonhole lever is lowered.	Raise the buttonhole lever before continuing the operation.
E3	The buttonhole or bar tack stitch was selected and the start/stop button was pressed (The foot controller was depressed if it is connected.) while the buttonhole lever is raised.	Lower the buttonhole lever before continuing the operation.
E4	The reverse/reinforcement stitch button or needle position button was pressed while the bobbin winder shaft is moved to the right.	Move the bobbin winder shaft to the left before continuing the operation.
E5	The start/stop button was pressed, even though the foot controller is connected.	Disconnect the foot controller, and then press the start/stop button. Otherwise, operate the machine by using the foot controller.
E6	The motor locked up because the thread is tangled.	Turn off the machine and remove the tangled thread before continuing the operation.
E7	The needle mode selection key was pressed to select twin needle sewing while a stitch that cannot be used with the twin needle is selected.	Select a stitch that can be used with the twin needle.
E8	The pattern selection dial was turned to select a pattern while the twin needle setting is selected.	Cancel the twin needle setting, and then select a stitch.



### Memo

- If error message “F1” through “F9” appears in the LCD while the sewing machine is being used, the machine may be malfunctioning. Contact your dealer or the nearest authorized service center.

## Operation beep

Each time a key is pressed or an incorrect operation is performed, a beep is sounded.

### ■ For a correct operation

One beep is sounded.

### ■ If an incorrect operation is performed

Two or four beeps are sounded.

### ■ If the machine locks up, for example, because the thread is tangled

The sewing machine continues to beep for three seconds, and then the machine automatically stops. Be sure to check for the cause of the error, and correct it before continuing to sew.

## Canceling the operation beep

When the sewing machine is purchased, it is set to beep each time an operation panel key is pressed. This setting can be changed so that the machine does not beep.

### 1 Turn off the sewing machine.

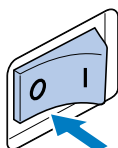

### 2 While holding the “-” side of (stitch width key) pressed, turn on the sewing machine.

When a beep is heard, release the “-” side of the stitch width key.

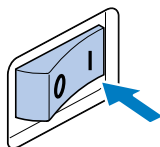
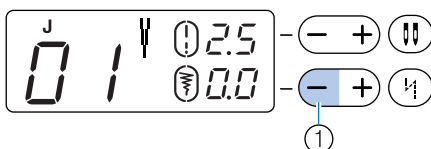

① “-” side of the stitch width key

► The machine is now set so that it will not beep.



### Memo

- Perform the same operation to set the machine so that the operation beep is sounded.

# Index

## Numerics

- 1/4 inch quilting foot..... 12
- 1/4 inch quilting foot with guide ..... 12

## A

- accessory bag..... 11
- adjustable zipper/piping foot..... 12
- appliques ..... 70
- attaching elastic tape..... 67

## B

- bar tack stitching..... 75
- basic stitching ..... 52, 63, 64
- blind hem stitching..... 54
- blind stitch foot ..... 11
- bobbin ..... 11
- bobbin cover..... 18
- bobbin thread..... 15, 18, 50
- button fitting foot..... 11
- buttonhole..... 56
- buttonhole foot..... 11, 58, 75
- buttonhole lever..... 59, 75
- buttonhole stitching..... 56

## C

- changing sewing direction..... 48
- cleaning ..... 91
- cleaning brush..... 11, 91
- crazy quilts..... 70

## D

- disc-shaped screwdriver ..... 11

## E

- error messages..... 97
- extra spool pin ..... 11, 25
- eyelet punch ..... 11, 59

## F

- fagoting ..... 78
- feed dog position switch..... 72, 73
- feed dogs..... 73
- flat bed attachment..... 10
- foot controller ..... 11
- free-motion quilting..... 72

## H

- heirloom stitching ..... 80

## I

- included accessories ..... 11

## J

- joining..... 80

## M

- main power switch..... 14
- maintenance ..... 91
- monogramming foot..... 11

## N

- needle ..... 27
- needle plate cover..... 91
- needle position..... 53
- needle position button..... 18
- needle set..... 11
- needle stop position ..... 35
- non stick foot ..... 12

## O

- open toe foot..... 12
- operation beep..... 98
- operation buttons ..... 9
- operation manual ..... 11
- operation panel ..... 10, 40, 97
- optional accessories ..... 12
- overcasting foot..... 11, 52

## P

- patchwork ..... 70
- pattern selection dial ..... 40
- power supply ..... 13
- presser foot..... 31
- presser foot holder..... 32
- presser foot lever ..... 20
- presser foot mounting pin..... 49

## Q

- quick reference guide..... 11
- quilting foot..... 12, 72
- quilting guide..... 12

## R

- race..... 91
- replacing the needle..... 27

## S

- safety instructions..... 1
- scallop stitching ..... 78
- screwdriver ..... 11
- seam ripper ..... 11, 59
- selecting a stitch..... 40
- sewing curves..... 48
- sewing heavyweight fabric ..... 48
- sewing lightweight fabric..... 49
- sewing machine needles ..... 27
- sewing speed controller..... 17
- sewing stretch fabrics ..... 49
- sewing thick fabrics..... 48
- side cutter ..... 12

smocking.....	79
spool cap .....	11
spool net .....	11
spool pin .....	20
stitch guide foot.....	12
stitch length.....	40
stitch settings.....	87
stitch width .....	40
straight stitch .....	53
stretch stitching .....	67

## T

thread guide .....	20
thread tension .....	47
thread tension dial.....	47
triple stretch stitching .....	74
twin needle .....	11, 25

## U

upper thread.....	20
-------------------	----

## W

walking foot .....	12, 33, 71
wide table .....	12, 37

## Z

zigzag foot .....	11, 49
zipper foot.....	11, 64
zipper insertion .....	63



