

brother

Embroidery Design Guide

绣花设计指南

刺繡設計手冊

자수 디자인 안내서

Руководство по дизайнам для вышивания

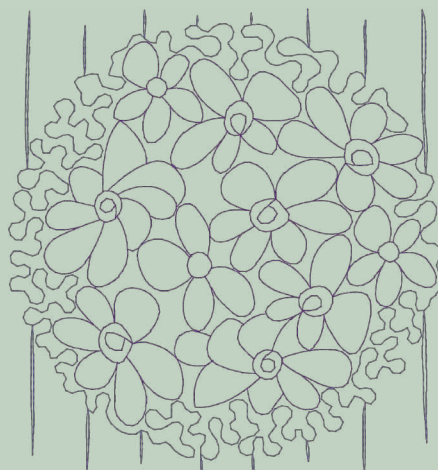
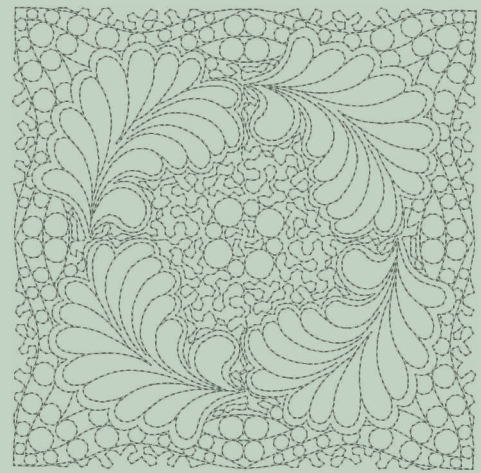

Note

The designated embroidery time in this guide is an estimated time only.

注意

本指南中指定的绣花时间只是预估时间。

註釋

本說明書中的指定刺繡時間僅為預計時間。

참고

본 안내서에 지정된 자수 시간은 추정치일 뿐입니다 .

Примечание

В настоящем руководстве указано приблизительное время вышивания.

Contents

- 2 Summary of Embroidery Patterns
- 10 Embroidery Patterns Color Change Table
- 31 Examples of Combinations
- 33 Color Thread Conversion Chart
- 36 Font Name Chart

目录

- 2 绣花花样概述
- 10 绣花花样换色顺序表
- 31 花样组合示例
- 33 绣花线颜色转换表
- 36 字体名称表

目錄

- 2 刺繡花樣概要
- 10 刺繡花樣顏色轉換表
- 31 組合範例
- 33 繡線顏色轉換表
- 36 字體名稱表

목차

- 2 자수 패턴 요약
- 10 자수 패턴 색 변경 테이블
- 31 조합 예
- 33 색실 변환 차트
- 36 글꼴 이름 차트

Содержание

- 2 Обзор дизайнов для вышивания
- 10 Таблицы цветов нитей для вышивок
- 31 Примеры комбинирования
- 33 Таблица преобразования цветов нитей
- 36 Таблица названий шрифтов

Summary of Embroidery Patterns 刺繡花樣概要 Обзор дизайнов для вышивания

绣花花样概述 자수 패턴 요약

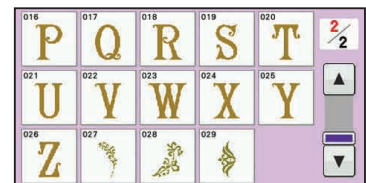
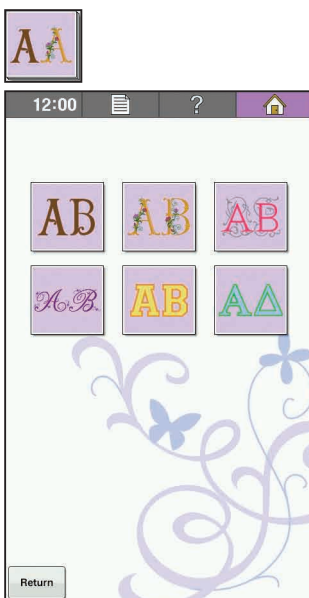
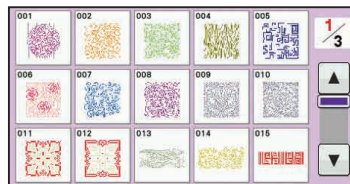
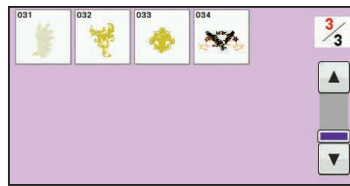
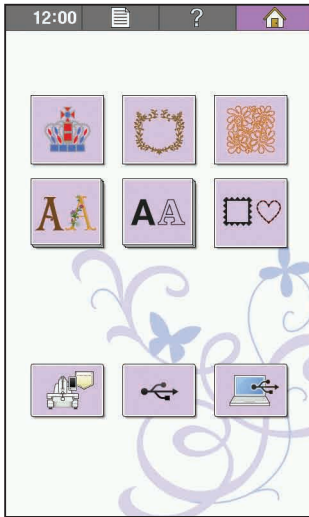

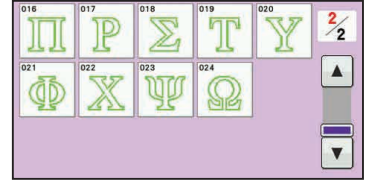
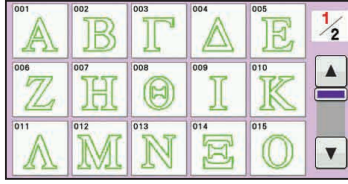
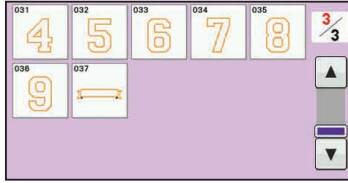
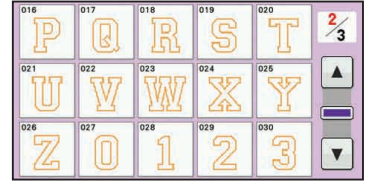
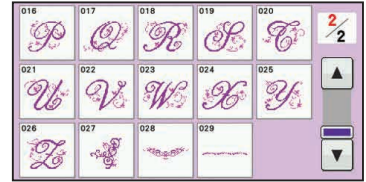
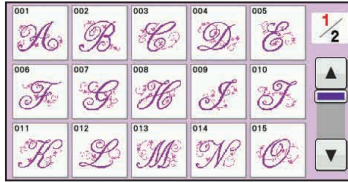
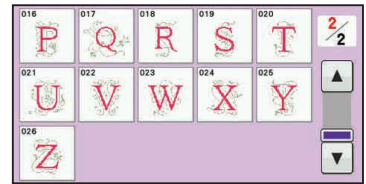
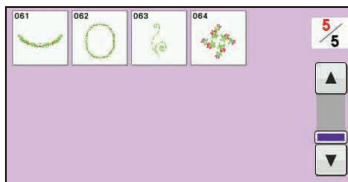



00 *ABC* 1/2

01 **ABC** 02 **ABC** 03 **ABC**

04 *ABC* 05 *ABC* 06 *ABC*

07 **ABC** 08 **ABC** 09 **ABC**

10 **ABC** 11 **ABC** 12 **ABC**

13 **ABC**

14 **ABCD** 15 *ABCD* 16 *ABCD* 2/2

17 *ABCD* 18 **ABB** 19 **ABB**



ABC abc 0-9., &?! **AAa** NNn

A B C D E F G H Delete

I J K L M N O P

Q R S T U V W X

Y Z -

ABC **abc** 0-9., &?! **AAa** NNn

a b c d e f g h Delete

i j k l m n o p

q r s t u v w x

y z -

ABC abc 0-9., &?! **AAa** NNn

0 1 2 3 4 5 6 7 Delete

8 9 # % \$ £ € ¥

- + * ÷ = * . ,

-

ABC abc 0-9., &?! **&?!** **AAa** NNn

g ? / @ < > / / Delete

/ / / \ ~ : ; ©

® ™ “ ” ’ ‘ ’

-

ABC abc 0-9., &?! **AAa** NNn

A A A B à á â ã Delete

ä å æ ç è é ê ë

Ë Ë è é ê ë Í Î

İ İ í î ï -

ABC abc 0-9., &?! **AAa** NNn

N N ñ ò ó ô õ ö ø ï Delete

ò ó ô õ ö ø ï

ÿ Ů Ū ù ú û ü ž

P p ß -



ABC abc 0-9., &?! **AAa** NNn

A B C D E F G H Delete

I J K L M N O P

Q R S T U V W X

Y Z -

ABC **abc** 0-9., &?! **AAa** NNn

a b c d e f g h Delete

i j k l m n o p

q r s t u v w x

y z -

ABC abc 0-9., &?! **AAa** NNn

0 1 2 3 4 5 6 7 Delete

8 9 # % \$ £ € ¥

- + * ÷ = * . ,

-

ABC abc 0-9., &?! **&?!** **AAa** NNn

& ? ! @ < > () Delete

[] / \ ~ : ; ©

® ™ “ ” ’ ‘ ’

-

ABC abc 0-9., &?! **AAa** NNn

Â Ã Ä Å Æ à á â ã Delete

ä å æ ç è é ê ë

Ë Ë è é ê ë Í Î

İ İ í î ï -

ABC abc 0-9., &?! **AAa** NNn

Ñ Ñ ñ Ô Ö Ø Ó Œ Delete

ò ó ô õ ö ø ï

ÿ Ů Ū ù ú û ü ž

P p ß -



ABC abc 0-9., &?! **AAa** NNn

A B C D E F G H Delete

I J K L M N O P

Q R S T U V W X

Y Z -

ABC **abc** 0-9., &?! **AAa** NNn

a b c d e f g h Delete

i j k l m n o p

q r s t u v w x

y z -

ABC abc 0-9., &?! **AAa** NNn

0 1 2 3 4 5 6 7 Delete

8 9 # % \$ £ € ¥

- + * ÷ = * . ,

-

ABC abc 0-9., &?! **&?!** **AAa** NNn

& ? ! @ < > () Delete

[] / \ ~ : ; ©

® ™ “ ” ’ ‘ ’

-

ABC abc 0-9., &?! **AAa** NNn

Â Ã Ä Å Æ à á â ã Delete

ä å æ ç è é ê ë

Ë Ë è é ê ë Í Î

İ İ í î ï -

ABC abc 0-9., &?! **AAa** NNn

Ñ Ñ ñ Ô Ö Ø Ó Œ Delete

ò ó ô õ ö ø ï

ÿ Ů Ū ù ú û ü ž

P p ß -

03
ABC

ABC	abc	0-9.,	&?!	ÄÄä	ÑÑñ			
A	B	C	D	E	F	G	H	Delete
I	J	K	L	M	N	O	P	↩
Q	R	S	T	U	V	W	X	
Y	Z	-						

ABC	abc	0-9.,	&?!	ÄÄä	ÑÑñ			
a	b	c	d	e	f	g	h	Delete
i	j	k	l	m	n	o	p	↩
q	r	s	t	u	v	w	x	
y	z	-						

ABC	abc	0-9.,	&?!	ÄÄä	ÑÑñ			
0	1	2	3	4	5	6	7	Delete
8	9	#	%	\$	€	£	¥	↩
.	+	x	÷	=	*	.	,	
-								↩

ABC	abc	0-9.,	&?!	ÄÄä	ÑÑñ			
&	?	!	@	<	>	()	Delete
[]	/	\	~	:	:	©	↩
®	™	“	”	’	’	’	’	
-								↩

ABC	abc	0-9.,	&?!	ÄÄä	ÑÑñ					
À	Á	Â	Ã	Ä	Å	à	á	â	ã	Delete
ä	å	æ	ç	ç	Ð	È	É	↩		
Ê	Ë	ë	é	ê	Ë	Ì	Í			
î	ï	ï	ï	ï	ï	ï	ï	-		

ABC	abc	0-9.,	&?!	ÄÄä	ÑÑñ					
Ñ	Ñ	ñ	Ò	Ó	Ô	Õ	Ö	Ø	Delete	
ò	ó	ô	õ	ö	ø	ø	ø	í	↩	
š	š	š	š	š	š	š	š	š		
ü	z	þ	þ	ß	-					

04
ABC

ABC	abc	0-9.,	&?!	ÄÄä	ÑÑñ			
A	B	C	D	E	F	G	H	Delete
I	J	K	L	M	N	O	P	↩
Q	R	S	T	U	V	W	X	
Y	Z	-						

ABC	abc	0-9.,	&?!	ÄÄä	ÑÑñ			
a	b	c	d	e	f	g	h	Delete
i	j	k	l	m	n	o	p	↩
q	r	s	t	u	v	w	x	
y	z	-						

ABC	abc	0-9.,	&?!	ÄÄä	ÑÑñ			
0	1	2	3	4	5	6	7	Delete
8	9	#	%	\$	£	€	¥	↩
.	+	x	÷	=	*	.	,	
-								↩

ABC	abc	0-9.,	&?!	ÄÄä	ÑÑñ			
&	?	!	@	<	>	()	Delete
[]	/	\	~	:	:	©	↩
®	™	“	”	’	’	’	’	
-								↩

ABC	abc	0-9.,	&?!	ÄÄä	ÑÑñ			
Á	Ä	Ä	Ä	Ä	à	á	ã	Delete
ä	å	æ	ç	ç	Ð	È	É	↩
Ê	Ë	ë	é	ê	Ë	Ì	Í	
î	ï	ï	-					

ABC	abc	0-9.,	&?!	ÄÄä	ÑÑñ					
Ñ	Ñ	ñ	Ò	Ó	Ô	Õ	Ö	Delete		
ò	ó	ô	õ	ö	ø	ø	ø	í	↩	
š	š	š	š	š	š	š	š	š		
ü	z	þ	þ	ß	-					

05
ABC

ABC	abc	0-9.,	&?!							
À	Á	Â	Ã	Ä	Å	Æ	Ç	Ð	Ñ	Delete
Ò	Ó	Ô	Õ	Ö	Ø	Ù	Ú	Û	Ü	↩
Ý	Z	-								

ABC	abc	0-9.,	&?!					
a	b	c	d	e	f	g	h	Delete
i	j	k	l	m	n	o	p	↩
q	r	s	t	u	v	w	x	
y	z	-						

ABC	abc	0-9.,	&?!					
0	1	2	3	4	5	6	7	Delete
8	9	-	=	.	.	-	-	↩

ABC	abc	0-9.,	&?!					
&	?	!	-	<	>	[]	Delete
/	\	~	:	:	“	”	’	↩
’	-							

06
ABC

ABC	abc	0-9.,	&?!	ÄÄä	EEë	ÑÑñ	ŦŦŧ	
À	B	C	D	E	F	G	H	Delete
I	J	K	L	M	N	O	P	↩
Q	R	S	T	U	V	W	X	
Y	Z	-						

ABC	abc	0-9.,	&?!	ÄÄä	EEë	ÑÑñ	ŦŦŧ	
a	b	c	d	e	f	g	h	Delete
i	j	k	l	m	n	o	p	↩
q	r	s	t	u	v	w	x	
y	z	-						

ABC	abc	0-9.,	&?!	ÄÄä	EEë	ÑÑñ	ŦŦŧ	
0	1	2	3	4	5	6	7	Delete
8	9	#	%	\$	£	€	¥	↩
.	+	x	÷	=	*	.	,	
-								↩

ABC	abc	0-9.,	&?!	ÄÄä	EEë	ÑÑñ	ŦŦŧ	
È	É	Ê	Ë	Ì	Í	Î	Ï	Delete
è	é	ê	ë	ì	í	î	ï	↩
ĭ	î	ï	ï	ï	ï	ï	ï	
-								↩

ABC	abc	0-9.,	&?!	ÄÄä	EEë	ÑÑñ	ŦŦŧ	
À	Ä	Ä	Ä	Ä	à	á	Delete	
â	ã	ä	å	æ	ç	ç	↩	
Ĉ	Ĉ	ĉ	ĉ	ĉ	ĉ	ĉ		ĉ
-								↩

ABC	abc	0-9.,	&?!	ÄÄä	EEë	ÑÑñ	ŦŦŧ	
È	É	Ê	Ë	Ì	Í	Î	Ï	Delete
è	é	ê	ë	ì	í	î	ï	↩
ĭ	î	ï	ï	ï	ï	ï	ï	
-								↩

ABC	abc	0-9..	&?!	ÄÄä	ÈÈè	ÑÑñ	ŦŦŧ
Ŧ	Ŧ	Ŧ	ñ	ñ	ñ	Ö	Ö
Ø	Ö	œ	ò	ó	ô	ø	ø
ø	œ	Ŕ	ř	Ŗ	Š	Š	Š
Ŗ	Ŗ	š	š	Ŗ	Ŗ	Ŗ	Ŗ

ABC	abc	0-9..	&?!	ÄÄä	ÈÈè	ÑÑñ	ŦŦŧ
Ŧ	Ŧ	Ŧ	ř	ř	ř	Ŧ	Ŧ
Ŧ	Ŧ	Ŧ	Ŧ	Ŧ	Ŧ	Ŧ	Ŧ
Ŧ	Ŧ	Ŧ	Ŧ	Ŧ	Ŧ	Ŧ	Ŧ
Ŧ	Ŧ	Ŧ	Ŧ	Ŧ	Ŧ	Ŧ	Ŧ

07 ABC

ABC	abc	0-9..	&?!	ÄÄä	ÈÈè	ÑÑñ	
A	B	C	D	E	F	G	H
I	J	K	L	M	N	O	P
Q	R	S	T	U	V	W	X
Y	Z	-					

ABC	abc	0-9..	&?!	ÄÄä	ÈÈè	ÑÑñ	
a	b	c	d	e	f	g	h
i	j	k	l	m	n	o	p
q	r	s	t	u	v	w	x
y	z	-					

ABC	abc	0-9..	&?!	ÄÄä	ÈÈè	ÑÑñ	
0	1	2	3	4	5	6	7
8	9	#	%	\$	£	€	¥
-	+	x	÷	=	*	.	,
-							

ABC	abc	0-9..	&?!	ÄÄä	ÈÈè	ÑÑñ	
&	?	!	@	<	>	()
[]	/	\	~	:	;	©
®	™	"	"	"	'	'	'
-							

ABC	abc	0-9..	&?!	ÄÄä	ÈÈè	ÑÑñ	
Á	À	À	Æ	à	á	â	ã
ä	å	æ	ç	ç	ð	è	é
ê	ë	é	é	ê	ë	î	ï
ì	í	ì	ì	ì	ì	ì	ì

ABC	abc	0-9..	&?!	ÄÄä	ÈÈè	ÑÑñ	
Ŧ	Ŧ	ñ	Ö	Ö	ø	Ö	œ
ò	ó	ô	ø	ø	ø	œ	ř
Ŗ	Ŗ	ř	Ŧ	Ŧ	Ŧ	Ŧ	Ŧ
Ŧ	Ŧ	Ŧ	Ŧ	Ŧ	Ŧ	Ŧ	Ŧ

08 ABC

ABC	abc	0-9..	&?!	ÄÄä	ÈÈè	ÑÑñ	
A	B	C	D	E	F	G	H
I	J	K	L	M	N	O	P
Q	R	S	T	U	V	W	X
Y	Z	-					

ABC	abc	0-9..	&?!	ÄÄä	ÈÈè	ÑÑñ	
a	b	c	d	e	f	g	h
i	j	k	l	m	n	o	p
q	r	s	t	u	v	w	x
y	z	-					

ABC	abc	0-9..	&?!	ÄÄä	ÈÈè	ÑÑñ	
0	1	2	3	4	5	6	7
8	9	#	%	\$	£	€	¥
-	+	x	÷	=	*	.	,
-							

ABC	abc	0-9..	&?!	ÄÄä	ÈÈè	ÑÑñ	
&	?	!	@	<	>	()
[]	/	\	~	:	;	©
®	™	"	"	"	'	'	'
-							

ABC	abc	0-9..	&?!	ÄÄä	ÈÈè	ÑÑñ	
À	À	À	Æ	à	á	â	ã
ä	å	æ	ç	ç	ð	è	é
ê	ë	é	é	ê	ë	î	ï
ì	í	ì	ì	ì	ì	ì	ì

ABC	abc	0-9..	&?!	ÄÄä	ÈÈè	ÑÑñ	
Ŧ	Ŧ	ñ	Ö	Ö	ø	Ö	œ
ò	ó	ô	ø	ø	ø	œ	ř
Ŧ	Ŧ	Ŧ	Ŧ	Ŧ	Ŧ	Ŧ	Ŧ
Ŧ	Ŧ	Ŧ	Ŧ	Ŧ	Ŧ	Ŧ	Ŧ

09 ABC

ABC	abc	0-9..	&?!	ÄÄä	ÈÈè	ÑÑñ	
A	B	C	D	E	F	G	H
I	J	K	L	M	N	O	P
Q	R	S	T	U	V	W	X
Y	Z	-					

ABC	abc	0-9..	&?!	ÄÄä	ÈÈè	ÑÑñ	
a	b	c	d	e	f	g	h
i	j	k	l	m	n	o	p
q	r	s	t	u	v	w	x
y	z	-					

ABC	abc	0-9..	&?!	ÄÄä	ÈÈè	ÑÑñ	
0	1	2	3	4	5	6	7
8	9	#	%	\$	£	€	¥
-	+	x	÷	=	*	.	,
-							

ABC	abc	0-9..	&?!	ÄÄä	ÈÈè	ÑÑñ	
Ŧ	Ŧ	ñ	Ö	Ö	ø	Ö	œ
ò	ó	ô	ø	ø	ø	œ	ř
Ŧ	Ŧ	Ŧ	Ŧ	Ŧ	Ŧ	Ŧ	Ŧ
Ŧ	Ŧ	Ŧ	Ŧ	Ŧ	Ŧ	Ŧ	Ŧ

ABC	abc	0-9..	&?!	ÄÄä	ÈÈè	ÑÑñ	
À	À	À	Æ	à	á	â	ã
ä	å	æ	ç	ç	ð	è	é
ê	ë	é	é	ê	ë	î	ï
ì	í	ì	ì	ì	ì	ì	ì

ABC	abc	0-9..	&?!	ÄÄä	ÈÈè	ÑÑñ	
Ŧ	Ŧ	ñ	Ö	Ö	ø	Ö	œ
ò	ó	ô	ø	ø	ø	œ	ř
Ŧ	Ŧ	Ŧ	Ŧ	Ŧ	Ŧ	Ŧ	Ŧ
Ŧ	Ŧ	Ŧ	Ŧ	Ŧ	Ŧ	Ŧ	Ŧ

10 ABC

ABC	abc	0-9..	&?!	ÄÄä	ÈÈè	ÑÑñ	
A	B	C	D	E	F	G	H
I	J	K	L	M	N	O	P
Q	R	S	T	U	V	W	X
Y	Z	-					

ABC	abc	0-9..	&?!	ÄÄä	ÈÈè	ÑÑñ	
a	b	c	d	e	f	g	h
i	j	k	l	m	n	o	p
q	r	s	t	u	v	w	x
y	z	-					

ABC	abc	0-9..	&?!	ÄÄä	ÈÈè	ÑÑñ	
0	1	2	3	4	5	6	7
8	9	#	%	\$	£	€	¥
-	+	x	÷	=	*	.	,
-							

11 ABC

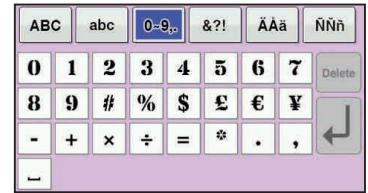
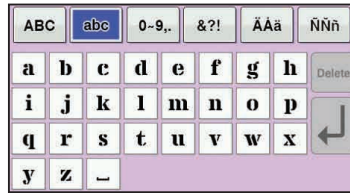
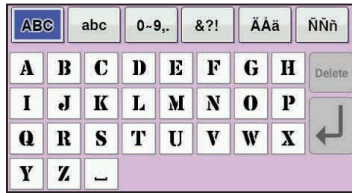
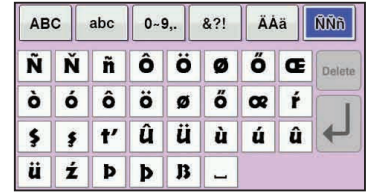
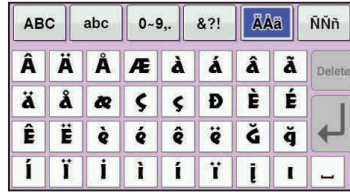
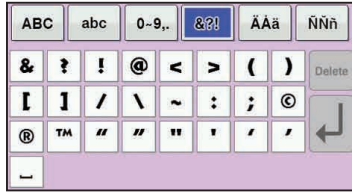

12 ABC

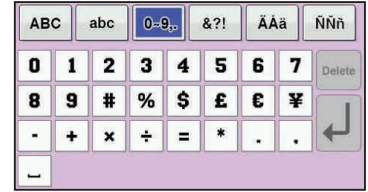
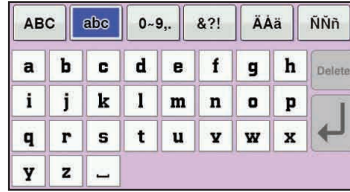
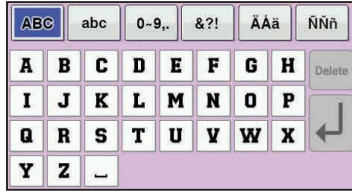
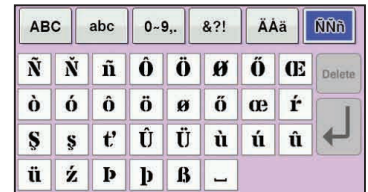
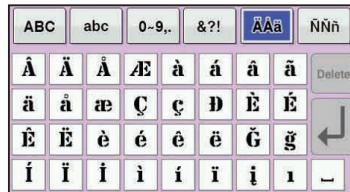
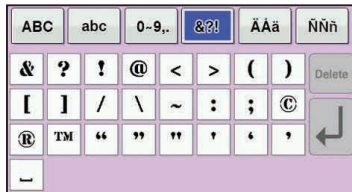

13 ABC

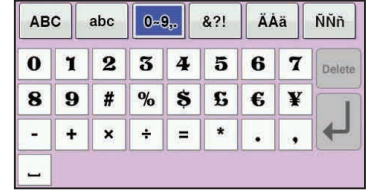
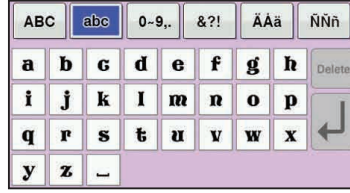
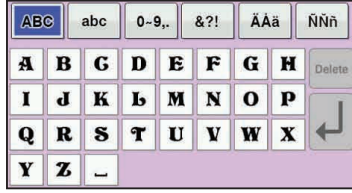
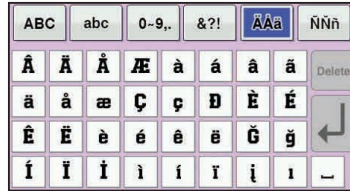
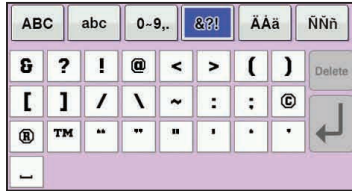

14 ABCD

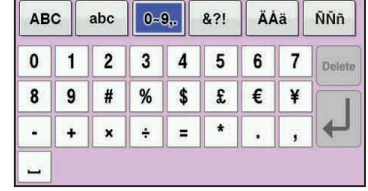
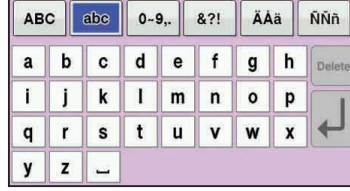
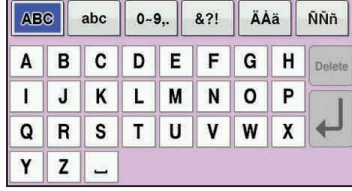
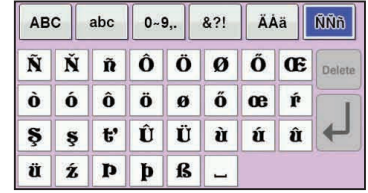
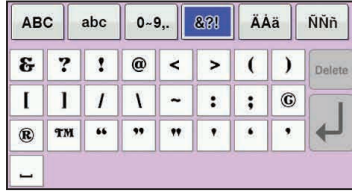

ABC	abc	0-9,.	&?! 	ÄÄä	ÑÑñ			
&	?	!	@	<	>	()	Delete
[]	/	\	~	:	;	©	
®	™	“	”	”	’	’	’	
—								↵

ABC	abc	0-9,.	&?! 	ÄÄä	ÑÑñ			
Ä	Ä	Ä	Æ	à	á	â	ã	Delete
ä	ä	æ	Ç	ç	Đ	È	É	
Ê	Ë	è	é	ê	ë	İ	ı	
ì	ï	í	—					↵

ABC	abc	0-9,.	&?! 	ÄÄä	ÑÑñ			
Ñ	Ñ	ñ	Ō	Ō	Ø	Ó	Œ	Delete
ò	ó	ô	ö	ø	õ	œ	í	
ƒ	Ū	Ü	ù	ú	û	ü	ž	
Ɔ	Ɔ	β	—					↵

15
ABCD

ABC	abc	0-9,.	&?! 	ÄÄä	ÑÑñ			
A	B	C	D	E	F	G	H	Delete
I	J	K	L	M	N	O	P	
Q	R	S	T	U	V	W	X	
Y	Z	—						↵

ABC	abc	0-9,.	&?! 	ÄÄä	ÑÑñ			
a	h	c	d	e	f	g	h	Delete
i	j	k	l	m	n	a	p	
q	r	s	t	u	a	u	x	
y	z	—						↵

ABC	abc	0-9,.	&?! 	ÄÄä	ÑÑñ			
0	1	2	3	4	5	6	7	Delete
8	9	-	.	,	—			
								↵

ABC	abc	0-9,.	&?! 	ÄÄä	ÑÑñ			
&	?	!	@	()	/	'	Delete
—								↵

ABC	abc	0-9,.	&?! 	ÄÄä	ÑÑñ			
Á	Á	Á	Æ	à	á	â	ã	Delete
ä	æ	Ç	ç	è	é	ê	ë	
ì	í	î	—					↵

ABC	abc	0-9,.	&?! 	ÄÄä	ÑÑñ			
Ñ	ñ	Ō	Ø	à	á	â	ã	Delete
ø	Ū	ù	ú	û	ü	β	—	
								↵

16
ABCD

ABC	abc	0-9,.	&?! 	ÄÄä	ÑÑñ			
À	À	À	Æ	à	á	â	ã	Delete
ä	æ	Ç	ç	è	é	ê	ë	
ì	í	î	—					↵

ABC	abc	0-9,.	&?! 	ÄÄä	ÑÑñ			
a	b	c	d	e	f	g	h	Delete
i	j	k	l	m	n	o	p	
q	r	s	t	u	v	w	x	
y	z	—						↵

ABC	abc	0-9,.	&?! 	ÄÄä	ÑÑñ			
0	1	2	3	4	5	6	7	Delete
8	9	-	.	,	—			
								↵

ABC	abc	0-9,.	&?! 	ÄÄä	ÑÑñ			
&	?	!	@	()	/	'	Delete
—								↵

ABC	abc	0-9,.	&?! 	ÄÄä	ÑÑñ			
Á	Á	Á	Æ	à	á	â	ã	Delete
ä	æ	Ç	ç	è	é	ê	ë	
ì	í	î	—					↵

ABC	abc	0-9,.	&?! 	ÄÄä	ÑÑñ			
Ñ	ñ	Ō	Ø	à	á	â	ã	Delete
ø	Ū	ù	ú	û	ü	β	—	
								↵

17
ABCD

ABC	abc	0-9,.	&?! 	ÄÄä	ÑÑñ			
À	À	À	Æ	à	á	â	ã	Delete
ä	æ	Ç	ç	è	é	ê	ë	
ì	í	î	—					↵

ABC	abc	0-9,.	&?! 	ÄÄä	ÑÑñ			
a	b	c	d	e	f	g	h	Delete
i	j	k	l	m	n	o	p	
q	r	s	t	u	v	w	x	
y	z	—						↵

ABC	abc	0-9,.	&?! 	ÄÄä	ÑÑñ			
0	1	2	3	4	5	6	7	Delete
8	9	-	.	,	—			
								↵

ABC	abc	0-9,.	&?! 	ÄÄä	ÑÑñ			
&	?	!	@	()	/	'	Delete
—								↵

ABC	abc	0-9,.	&?! 	ÄÄä	ÑÑñ			
À	À	À	Æ	à	á	â	ã	Delete
ä	æ	Ç	ç	è	é	ê	ë	
ì	í	î	—					↵

ABC	abc	0-9,.	&?! 	ÄÄä	ÑÑñ			
Ñ	ñ	Ō	Ø	à	á	â	ã	Delete
ø	Ū	ù	ú	û	ü	β	—	
								↵

18
ABВ

ABВ	ЧШЩ	абв	чшщ					
А	Б	В	Г	Д	Е	Ё	Ж	Delete
З	И	Й	К	Л	М	Н	О	
П	Р	С	Т	У	Ф	Х	Ц	
—								↵

ABВ	ЧШЩ	абв	чшщ					
Ч	Ш	Щ	Ъ	Ы	Ь	Э	Ю	Delete
Я	Г	Є	І	Ї	Ў	Ҁ	ҁ	
Ј	Љ	Њ	Џ	Ѓ	Ѕ	Ї	—	
								↵

ABВ	ЧШЩ	абв	чшщ					
а	б	в	г	д	е	ё	ж	Delete
з	и	й	к	л	м	н	о	
п	р	с	т	у	ф	х	ц	
—								↵



19 АБВ

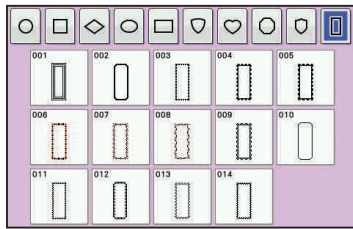
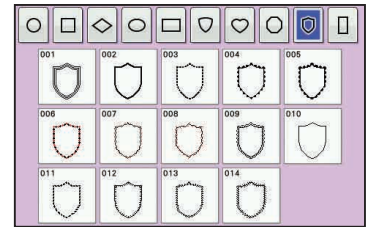
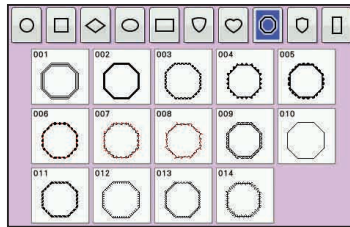
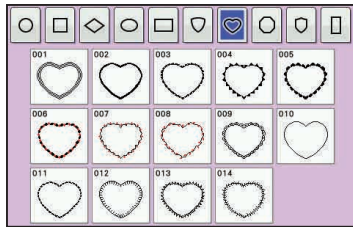
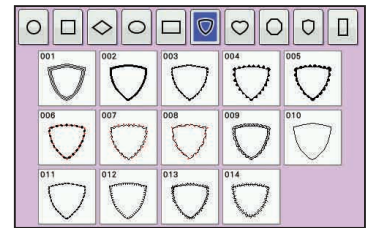
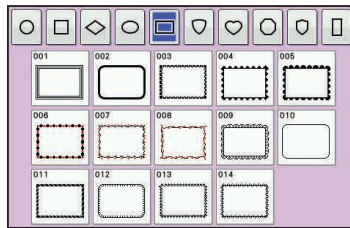
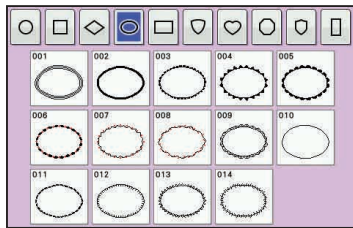
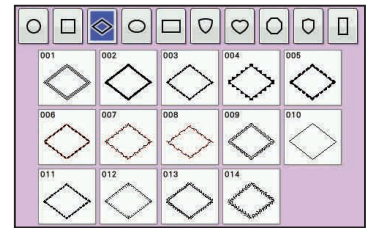
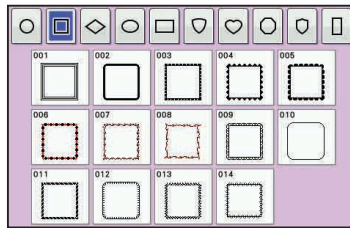
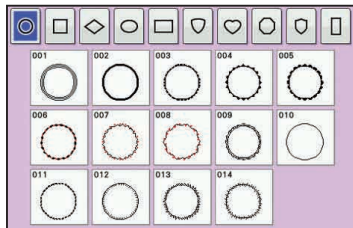

Embroidery Patterns Color Change Table 刺繡花樣顏色轉換表 Таблицы цветов нитей для вышивок

绣花花样换色顺序表 자수 패턴 색 변경 테이블

✿ Embroidery patterns

✿ 刺繡花樣

✿ Дизайны для вышивания

✿ 绣花花样

✿ 자수 패턴



No.1 4 min

1	(107)
2	(007)
3	(005)
4	(007)
5	(107)

Time required for embroidering
绣花需要的时间
刺繡所需的時間
자수에 필요한 시간
Время, необходимое для вышивания

Embroidery thread color number
绣花线色编号
繡線顏色編號
자수 실 색 번호
Номер цвета нити для вышивания

Embroidery size
绣花尺寸
刺繡尺寸
자수 크기
Размер вышивки

Order to embroider
绣制顺序
刺繡順序
자수 순서
Порядок вышивания

Embroidery thread color
绣花线色
繡線顏色
자수 실 색
Цвет нити для вышивания

↓ 40.1 mm
↔ 41.3 mm



No.13 2 min

1	(214)
---	-------

↓ 39.3 mm
↔ 38.4 mm



No.14 5 min

1	(214)
---	-------

↓ 68.5 mm
↔ 69.5 mm



No.15 4 min

1	(348)
2	(399)
3	(085)
4	(124)

↓ 41.4 mm
↔ 49.3 mm

No.2 2 min

1	(812)
2	(205)

↓ 32.1 mm
↔ 30.2 mm

No.6 1 min

1	(399)
2	(348)

↓ 31.2 mm
↔ 21.1 mm

No.10 2 min

1	(348)
2	(001)
3	(517)
4	(515)
5	(323)
6	(058)
7	(214)
8	(208)

↓ 30.8 mm
↔ 27.6 mm



No.16 12 min

1	(348)
2	(124)
3	(085)
4	(399)

↓ 88.1 mm
↔ 157.9 mm

No.3 1 min

1	(612)
2	(515)
3	(534)
4	(620)

↓ 28.2 mm
↔ 27.4 mm

No.7 1 min

1	(328)
2	(214)

↓ 37.6 mm
↔ 15.3 mm

No.11 2 min

1	(001)
2	(515)
3	(800)
4	(214)
5	(001)

↓ 31.0 mm
↔ 30.9 mm

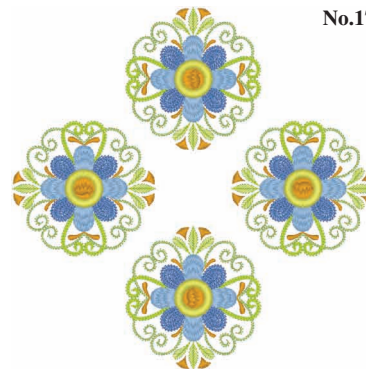

No.17 38 min

1	(517)
2	(214)
3	(513)
4	(070)
5	(607)
6	(214)
7	(206)

↓ 192.5 mm
↔ 192.5 mm

No.4 1 min

1	(079)
2	(001)
3	(058)

↓ 19.1 mm
↔ 29.3 mm

No.8 1 min

1	(001)
2	(509)
3	(058)

↓ 29.9 mm
↔ 23.8 mm

No.5 1 min

1	(509)
2	(515)

↓ 26.3 mm
↔ 26.6 mm

No.9 1 min

1	(900)
2	(800)
3	(900)

↓ 15.0 mm
↔ 16.1 mm

No.12 7 min

1	(005)
---	-------

↓ 68.2 mm
↔ 53.8 mm

No.18 **35 min**

1	(399)
2	(517)
3	(607)
4	(070)
5	(804)
6	(613)
7	(214)
8	(399)
9	(517)
10	(607)
11	(070)
12	(804)
13	(613)
14	(214)

↓ 185.9 mm
↔ 185.9 mm

No.21 **35 min**

1	(612)	7	(542)
2	(405)	8	(405)
3	(542)	9	(019)
4	(001)	10	(001)
5	(019)	11	(070)
6	(405)		

↓ 153.0 mm ↔ 153.5 mm

No.22

No.19 **28 min**

1	(513)
2	(085)
3	(807)
4	(507)
5	(209)
6	(206)
7	(807)

↓ 177.3 mm
↔ 177.4 mm

50 min

1	(515)	15	(019)	29	(010)	43	(208)	57	(513)
2	(027)	16	(208)	30	(323)	44	(843)	58	(534)
3	(513)	17	(843)	31	(513)	45	(010)	59	(707)
4	(058)	18	(010)	32	(534)	46	(810)	60	(208)
5	(208)	19	(810)	33	(019)	47	(010)	61	(513)
6	(070)	20	(010)	34	(208)	48	(323)	62	(515)
7	(019)	21	(323)	35	(843)	49	(070)	63	(027)
8	(209)	22	(513)	36	(010)	50	(208)	64	(513)
9	(208)	23	(534)	37	(810)	51	(001)	65	(058)
10	(800)	24	(019)	38	(010)	52	(058)	66	(208)
11	(405)	25	(208)	39	(323)	53	(010)	67	(070)
12	(058)	26	(843)	40	(513)	54	(070)	68	(019)
13	(513)	27	(010)	41	(534)	55	(058)		
14	(534)	28	(810)	42	(019)	56	(620)		

↓ 195.8 mm ↔ 195.8 mm

No.20 **39 min**

1	(613)
2	(001)
3	(086)
4	(542)
5	(613)
6	(001)
7	(086)
8	(542)
9	(613)
10	(001)
11	(086)
12	(542)
13	(613)
14	(001)
15	(086)
16	(542)

↓ 194.0 mm
↔ 194.0 mm

No.23 **36 min**

1	(804)
2	(810)
3	(607)
4	(017)
5	(019)
6	(085)
7	(086)
8	(027)
9	(124)

↓ 156.0 mm
↔ 155.1 mm



No.24 **22 min**

1	(107)
2	(086)
↕	148.2 mm
↔	195.4 mm



No.25 **21 min**

1	(405)
2	(420)
↕	148.2 mm
↔	195.4 mm



No.26 **21 min**

1	(517)
2	(515)
↕	148.2 mm
↔	195.4 mm



No.27 **21 min**

1	(007)
2	(405)
↕	148.2 mm
↔	195.4 mm



No.28 **55 min**

1	(208)	12	(307)
2	(323)	13	(126)
3	(126)	14	(333)
4	(058)	15	(208)
5	(800)	16	(126)
6	(107)	17	(001)
7	(058)	18	(800)
8	(001)	19	(058)
9	(126)	20	(107)
10	(399)	21	(399)
11	(107)	22	(058)
↕ 194.3 mm ↔ 145.3 mm			



No.29 **45 min**

1	(208)
2	(900)
3	(620)
4	(339)
5	(900)
↕	182.7 mm
↔	194.7 mm



No.30 **50 min**

1	(420)
2	(515)
3	(206)
4	(420)
5	(007)
6	(800)
7	(515)
8	(206)
9	(007)
10	(005)
11	(420)
12	(800)
↕	192.2 mm
↔	184.1 mm



No.31 **10 min**

1	(399)
2	(001)
↕	85.5 mm
↔	56.0 mm



No.32 **4 min**

1	(328)
↕	74.1 mm
↔	54.1 mm



No.33 **2 min**

1	(328)
2	(348)
↕	42.4 mm
↔	40.1 mm



No.34 **11 min**

1	(209)	6	(339)
2	(206)	7	(323)
3	(209)	8	(001)
4	(900)	9	(843)
5	(206)	10	(900)
↕ 55.2 mm ↔ 118.9 mm			

❖ Decoration/Hallmark patterns

❖ 裝飾/賀曼花樣

❖ Декоративные/традиционные дизайны

❖ 裝飾/标志花樣

❖ 장식/홀마크 패턴



No.1 **11 min**

1	(707)
2	(817)
3	(707)

↓ 195.6 mm
 ⇐ 160.0 mm

No.2 **4 min**

1	(817)
2	(707)

↓ 81.8 mm
 ⇐ 111.8 mm

No.3 **3 min**

1	(707)
2	(817)

↓ 39.4 mm
 ⇐ 136.7 mm

No.4 **2 min**

1	(900)
---	-------

↓ 25.0 mm
 ⇐ 69.8 mm

No.5 **2 min**

1	(900)
---	-------

↓ 40.5 mm
 ⇐ 90.3 mm

No.6 **1 min**

1	(900)
---	-------

↓ 24.4 mm
 ⇐ 95.7 mm

No.7 **1 min**

1	(900)
---	-------

↓ 18.9 mm
 ⇐ 62.7 mm

No.8 **5 min**

1	(900)
---	-------

↓ 62.4 mm
 ⇐ 123.6 mm

No.9 **1 min**

1	(900)
---	-------

↓ 23.8 mm
 ⇐ 58.5 mm

No.10 **1 min**

1	(900)
---	-------

↓ 40.6 mm
 ⇐ 74.9 mm

No.11 **1 min**

1	(900)
---	-------

↓ 15.2 mm
 ⇐ 62.9 mm

No.12 **3 min**

1	(900)
---	-------

↓ 37.8 mm
 ⇐ 125.4 mm

No.13 **3 min**

1	(900)
---	-------

↓ 24.7 mm
 ⇐ 129.1 mm

No.14 **2 min**

1	(900)
---	-------

↓ 32.5 mm
 ⇐ 75.0 mm

No.15 **2 min**

1	(900)
---	-------

↓ 8.1 mm
 ⇐ 182.8 mm

No.16 **19 min**

1	(399)
2	(804)

↓ 186.8 mm
 ⇐ 160.1 mm

No.17 **12 min**

1	(399)
2	(804)

↓ 84.6 mm
 ⇐ 143.0 mm

No.18 **9 min**

1	(399)
2	(804)

↓ 48.4 mm
 ⇐ 188.5 mm

No.19 **9 min**

1	(399)
2	(804)

↓ 48.4 mm
 ⇐ 188.5 mm



No.19

19 min	
1	(328)
↕	173.7 mm
↔	194.4 mm



No.24

2 min	
1	(328)
↕	47.9 mm
↔	51.4 mm



No.25

1 min	
1	(869)
↕	26.0 mm
↔	57.0 mm



No.20

13 min	
1	(328)
↕	137.6 mm
↔	147.2 mm



No.26

2 min	
1	(007)
↕	16.8 mm
↔	92.6 mm



No.21

24 min	
1	(704)
↕	154.3 mm
↔	186.5 mm



No.27

1 min	
1	(005)
↕	20.7 mm
↔	33.7 mm



No.22

7 min	
1	(900)
2	(085)
3	(086)
4	(807)
↕	47.9 mm
↔	161.3 mm

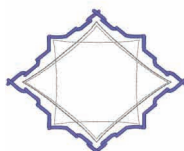

No.23

4 min	
1	(005)
2	(817)
3	(607)
↕	77.3 mm
↔	95.1 mm

- ❖ Quilt patterns
- ❖ 被面花樣
- ❖ Дизайны для квилтинга

- ❖ 绗缝花樣
- ❖ 킴트 패턴



No.1

5 min	
1	(613)
2	(607)
↕	194.9 mm
↔	182.0 mm

No.4

2 min	
1	(330)
↕	194.8 mm
↔	194.9 mm

No.2

2 min	
1	(209)
↕	193.7 mm
↔	194.1 mm

No.5

2 min	
1	(406)
↕	189.7 mm
↔	189.6 mm

No.3

2 min	
1	(509)
↕	194.8 mm
↔	194.8 mm

No.6

7 min	
1	(079)
2	(086)
↕	194.8 mm
↔	194.3 mm

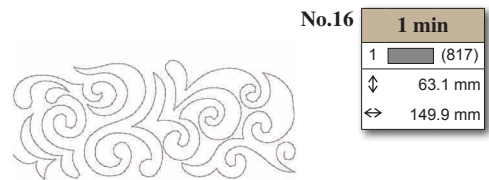
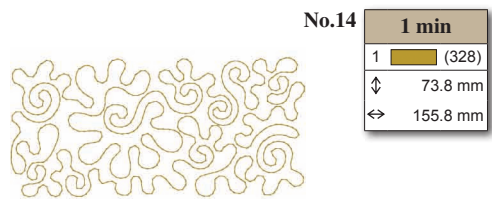
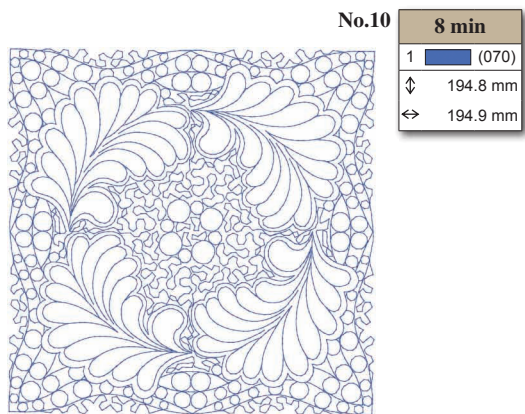
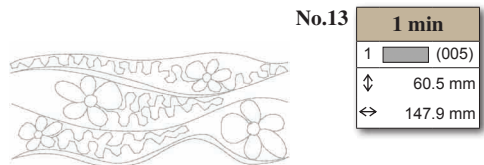
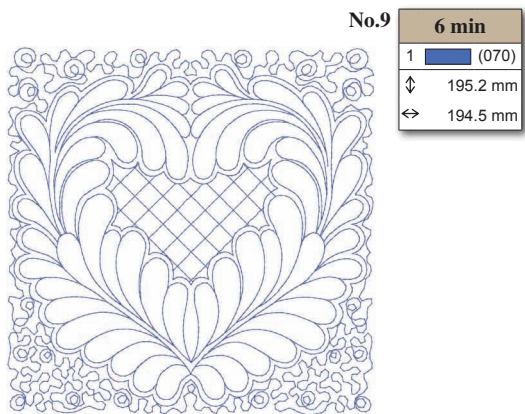
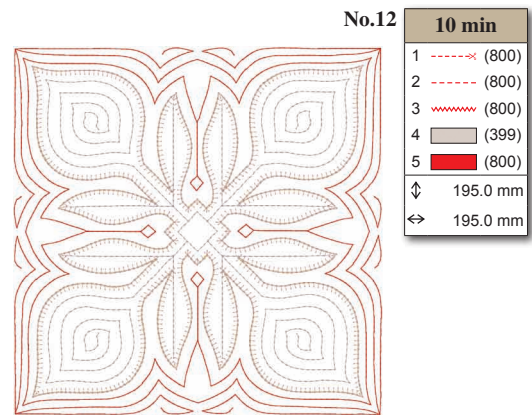
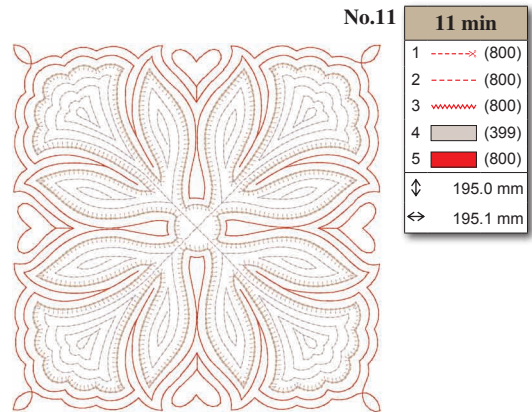
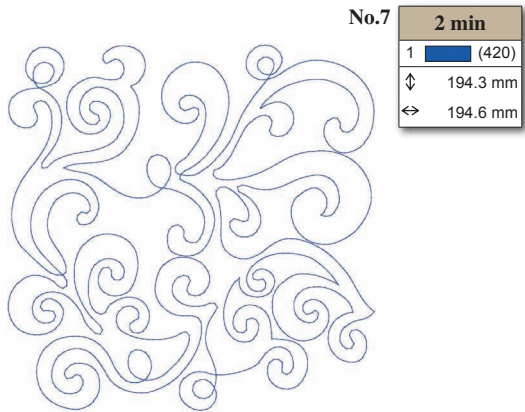

Embroidery Patterns Color Change Table
 刺繡花樣顏色轉換表
 Таблицы цветов нитей для вышивок

绣花花样换色顺序表
 자수 패턴 색 변경 테이블

No.17

2 min	
1	(800)
↕	56.3 mm
↔	163.1 mm



No.23

3 min	
1	(030)
2	(323)
↕	181.2 mm
↔	180.4 mm

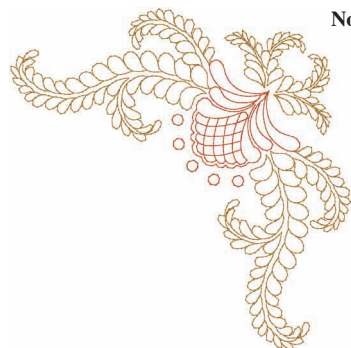

No.18

4 min	
1	(323)
2	(209)
↕	84.7 mm
↔	162.9 mm



No.19

11 min	
1	(517)
2	(330)
↕	143.8 mm
↔	143.0 mm

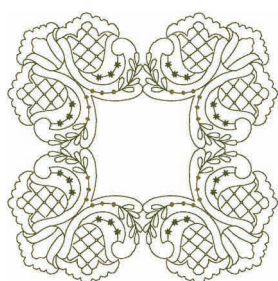

No.24

21 min	
1	(817)
2	(620)
3	(817)
4	(620)
5	(607)
6	(817)
7	(620)
8	(607)
9	(817)
10	(620)
11	(607)
12	(620)
↕	199.0 mm
↔	199.0 mm

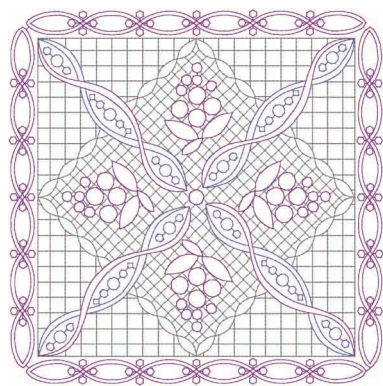

No.20

3 min	
1	(517)
2	(330)
↕	63.5 mm
↔	103.8 mm



No.25

1 min	
1	(817)
2	(620)
↕	32.2 mm
↔	91.0 mm

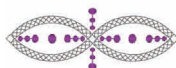

No.21

8 min	
1	(704)
2	(328)
↕	151.1 mm
↔	149.8 mm

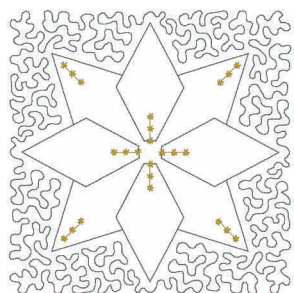

No.26

9 min	
1	(509)
2	(005)
3	(323)
4	(209)
↕	173.6 mm
↔	174.0 mm

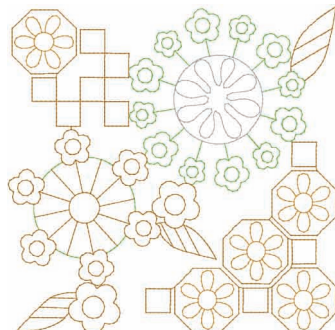

No.22

9 min	
1	(330)
2	(328)
3	(810)
↕	146.0 mm
↔	146.5 mm



Refer to the operation manual for the embroidery machine for details on how to embroider appliques.
 有关如何绣制贴布绣的详细信息，请参见绣花机的使用说明书。
 關於如何繡上印刷和針趾花樣的詳細資訊，請參考縫紉機的使用說明書。
 자세한 아플리케 자수 방법은 자수기 작동 설명서를 참조하세요.
 Инструкции по вышиванию аппликаций приведены в руководстве пользователя машины.



No.27

2 min	
1	■ (323)
2	■ (509)
↕	180.9 mm
↔	45.3 mm



No.28

2 min	
1	■ (517)
2	■ (208)
3	■ (800)
↕	123.9 mm
↔	59.4 mm



No.29

3 min	
1	■ (214)
2	■ (330)
↕	95.3 mm
↔	83.5 mm



No.30

2 min	
1	■ (330)
↕	44.2 mm
↔	162.8 mm



No.31

10 min	
1	■ (107)
2	■ (005)
3	■ (415)
4	■ (214)
↕	188.7 mm
↔	191.2 mm

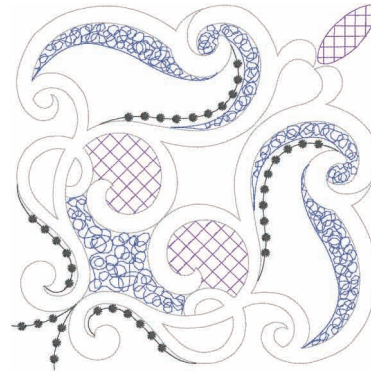

No.32

11 min	
1	■ (005)
2	■ (070)
3	■ (704)
4	■ (612)
↕	194.2 mm
↔	194.2 mm

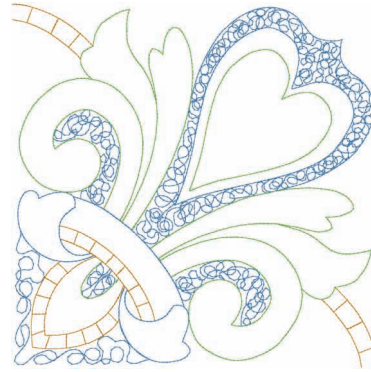

No.33

12 min	
1	■ (019)
2	■ (509)
3	■ (209)
4	■ (019)
5	■ (509)
↕	193.2 mm
↔	193.6 mm

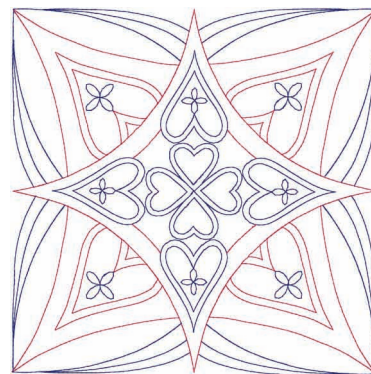

No.34

6 min	
1	■ (107)
2	■ (007)
3	■ (107)
↕	194.4 mm
↔	193.6 mm

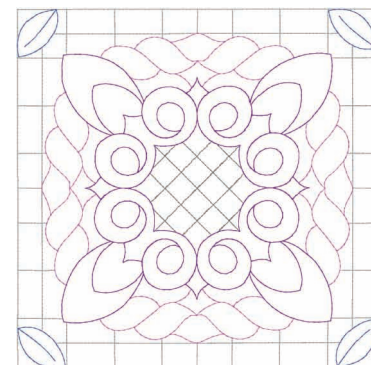

No.35

13 min	
1	■ (817)
2	■ (005)
3	■ (810)
4	■ (620)
5	■ (070)
↕	191.2 mm
↔	191.2 mm

❖ Alphabet
 ❖ 字母
 ❖ Алфавиты

❖ 字母
 ❖ 알파벳



● Vintage
 ● 빈티지

● 复古
 ● Винтажные

● 復古式



No.1 **17 min**
 1 (323)
 ↓ 147.7 mm
 ⇔ 129.6 mm



No.6 **15 min**
 1 (323)
 ↓ 149.3 mm
 ⇔ 107.4 mm



No.11 **20 min**
 1 (323)
 ↓ 149.4 mm
 ⇔ 125.1 mm

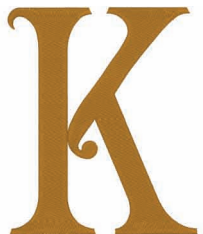

No.2 **18 min**
 1 (323)
 ↓ 149.9 mm
 ⇔ 110.9 mm



No.7 **17 min**
 1 (323)
 ↓ 150.4 mm
 ⇔ 111.7 mm



No.12 **13 min**
 1 (323)
 ↓ 149.2 mm
 ⇔ 107.1 mm

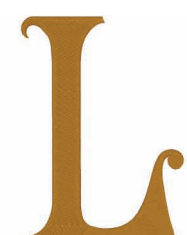

No.3 **13 min**
 1 (323)
 ↓ 152.9 mm
 ⇔ 102.3 mm



No.8 **21 min**
 1 (323)
 ↓ 149.1 mm
 ⇔ 125.6 mm



No.13 **28 min**
 1 (323)
 ↓ 149.2 mm
 ⇔ 150.1 mm



No.4 **18 min**
 1 (323)
 ↓ 149.3 mm
 ⇔ 111.7 mm



No.9 **10 min**
 1 (323)
 ↓ 149.1 mm
 ⇔ 58.0 mm



No.14 **21 min**
 1 (323)
 ↓ 149.7 mm
 ⇔ 131.1 mm



No.5 **19 min**
 1 (323)
 ↓ 149.1 mm
 ⇔ 109.7 mm



No.10 **11 min**
 1 (323)
 ↓ 148.8 mm
 ⇔ 93.9 mm

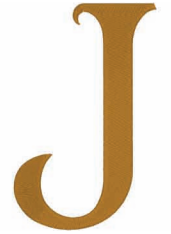

No.15 **19 min**
 1 (323)
 ↓ 151.7 mm
 ⇔ 107.1 mm





No.16 **16 min**
 1  (323)
 ↓ 149.4 mm
 ⇔ 111.7 mm



No.22 **14 min**
 1  (323)
 ↓ 149.1 mm
 ⇔ 110.2 mm



No.27 **9 min**
 1  (330)
 ↓ 195.5 mm
 ⇔ 104.8 mm





No.17 **18 min**
 1  (323)
 ↓ 149.5 mm
 ⇔ 108.2 mm



No.23 **26 min**
 1  (323)
 ↓ 149.2 mm
 ⇔ 162.8 mm



No.28 **11 min**
 1  (330)
 ↓ 136.7 mm
 ⇔ 123.8 mm





No.18 **20 min**
 1  (323)
 ↓ 149.3 mm
 ⇔ 123.2 mm



No.24 **17 min**
 1  (323)
 ↓ 149.0 mm
 ⇔ 115.2 mm



No.29 **4 min**
 1  (330)
 ↓ 85.9 mm
 ⇔ 40.0 mm



No.19 **16 min**
 1  (323)
 ↓ 149.3 mm
 ⇔ 91.2 mm



No.25 **14 min**
 1  (323)
 ↓ 149.2 mm
 ⇔ 120.2 mm



No.20 **16 min**
 1  (323)
 ↓ 149.2 mm
 ⇔ 118.8 mm

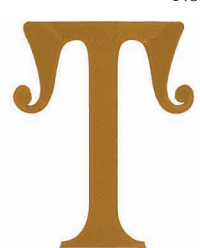

No.26 **17 min**
 1  (323)
 ↓ 147.9 mm
 ⇔ 96.0 mm



No.21 **16 min**
 1  (323)
 ↓ 149.7 mm
 ⇔ 117.4 mm



Embroidery Patterns Color Change Table
 刺繡花樣顏色轉換表
 Таблицы цветов нитей для вышивок

绣花花样换色顺序表
 자수 패턴 색 변경 테이블

● Floral
 ● 꽃장식

● 花饰花样
 ● Цветочные

● 花飾



No.1

17 min	
1	(328)
2	(804)
3	(612)
4	(079)
5	(807)
6	(513)
7	(502)
↓	145.1 mm
↔	125.7 mm



No.6

16 min	
1	(328)
2	(804)
3	(612)
4	(079)
5	(807)
6	(513)
7	(502)
↓	142.8 mm
↔	101.8 mm

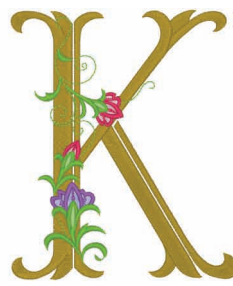

No.11

20 min	
1	(328)
2	(804)
3	(612)
4	(079)
5	(807)
6	(513)
7	(502)
↓	142.0 mm
↔	119.6 mm



No.2

19 min	
1	(328)
2	(804)
3	(612)
4	(079)
5	(807)
6	(513)
7	(502)
↓	140.9 mm
↔	108.1 mm



No.7

19 min	
1	(328)
2	(804)
3	(612)
4	(079)
5	(807)
6	(513)
7	(502)
↓	141.6 mm
↔	117.3 mm



No.12

15 min	
1	(328)
2	(804)
3	(612)
4	(079)
5	(807)
6	(513)
7	(502)
↓	144.9 mm
↔	107.0 mm



No.3

16 min	
1	(328)
2	(804)
3	(612)
4	(079)
5	(807)
6	(513)
7	(502)
↓	141.8 mm
↔	114.5 mm



No.8

22 min	
1	(328)
2	(804)
3	(612)
4	(079)
5	(807)
6	(513)
7	(502)
↓	141.7 mm
↔	121.6 mm



No.13

23 min	
1	(328)
2	(804)
3	(612)
4	(079)
5	(807)
6	(513)
7	(502)
↓	146.5 mm
↔	124.6 mm



No.4

19 min	
1	(328)
2	(804)
3	(612)
4	(079)
5	(807)
6	(513)
7	(502)
↓	141.2 mm
↔	108.3 mm



No.9

14 min	
1	(328)
2	(804)
3	(612)
4	(079)
5	(807)
6	(513)
7	(502)
↓	145.8 mm
↔	49.7 mm



No.14

20 min	
1	(328)
2	(804)
3	(612)
4	(079)
5	(807)
6	(513)
7	(502)
↓	147.0 mm
↔	116.8 mm



No.5

18 min	
1	(328)
2	(804)
3	(612)
4	(079)
5	(807)
6	(513)
7	(502)
↓	144.3 mm
↔	102.5 mm



No.10

15 min	
1	(328)
2	(804)
3	(612)
4	(079)
5	(807)
6	(513)
7	(502)
↓	144.5 mm
↔	82.3 mm



No.15

18 min	
1	(328)
2	(804)
3	(612)
4	(079)
5	(807)
6	(513)
7	(502)
↓	146.3 mm
↔	115.3 mm

No.16 17 min



1	(328)
2	(804)
3	(612)
4	(079)
5	(807)
6	(513)
7	(502)

↓ 143.4 mm
↔ 99.6 mm

No.20 18 min



1	(328)
2	(804)
3	(612)
4	(079)
5	(807)
6	(513)
7	(502)

↓ 144.5 mm
↔ 118.4 mm

No.24 18 min



1	(328)
2	(804)
3	(612)
4	(079)
5	(807)
6	(513)
7	(502)

↓ 142.3 mm
↔ 115.9 mm

No.17 20 min



1	(328)
2	(804)
3	(612)
4	(079)
5	(807)
6	(513)
7	(502)

↓ 142.7 mm
↔ 118.2 mm

No.21 17 min



1	(328)
2	(804)
3	(612)
4	(079)
5	(807)
6	(513)
7	(502)

↓ 144.6 mm
↔ 118.5 mm

No.25 16 min



1	(328)
2	(804)
3	(612)
4	(079)
5	(807)
6	(513)
7	(502)

↓ 142.8 mm
↔ 116.3 mm

No.18 21 min



1	(328)
2	(804)
3	(612)
4	(079)
5	(807)
6	(513)
7	(502)

↓ 143.4 mm
↔ 112.5 mm

No.22 17 min



1	(328)
2	(804)
3	(612)
4	(079)
5	(807)
6	(513)
7	(502)

↓ 145.5 mm
↔ 121.5 mm

No.26 19 min



1	(328)
2	(804)
3	(612)
4	(079)
5	(807)
6	(513)
7	(502)

↓ 142.8 mm
↔ 92.9 mm

No.19 21 min



1	(328)
2	(804)
3	(612)
4	(079)
5	(807)
6	(513)
7	(502)

↓ 144.1 mm
↔ 99.4 mm

No.23 23 min



1	(328)
2	(804)
3	(612)
4	(079)
5	(807)
6	(513)
7	(502)

↓ 146.2 mm
↔ 124.8 mm

◆Example ◆示例 ◆範例
◆예 ◆Пример

No.27 26 min

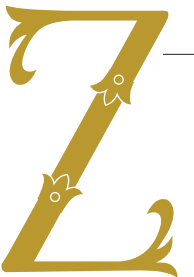

1	(328)
2	(804)
3	(612)
4	(079)
5	(807)
6	(513)
7	(502)

↓ 142.8 mm
↔ 92.9 mm



No.27 3 min



1	(328)
2	(079)
3	(807)
4	(513)
5	(502)

↓ 51.9 mm
↔ 45.9 mm

No.29 3 min



1	(328)
2	(079)
3	(807)
4	(513)
5	(502)

↓ 52.2 mm
↔ 41.1 mm

No.31 3 min



1	(328)
2	(079)
3	(807)
4	(513)
5	(502)

↓ 53.1 mm
↔ 37.3 mm

No.28 3 min



1	(328)
2	(079)
3	(807)
4	(513)
5	(502)

↓ 51.7 mm
↔ 39.6 mm

No.30 3 min



1	(328)
2	(079)
3	(807)
4	(513)
5	(502)

↓ 51.9 mm
↔ 39.3 mm

No.32 3 min



1	(328)
2	(079)
3	(807)
4	(513)
5	(502)

↓ 52.1 mm
↔ 36.6 mm

Embroidery Patterns Color Change Table
 刺繡花樣顏色轉換表
 Таблицы цветов нитей для вышивок

绣花花样换色顺序表
 자수 패턴 색 변경 테이블

No.33

3 min	
1	(328)
2	(079)
3	(807)
4	(513)
5	(502)
↕	51.9 mm
↔	42.7 mm

No.38

3 min	
1	(328)
2	(079)
3	(807)
4	(513)
5	(502)
↕	52.5 mm
↔	38.9 mm

No.43

3 min	
1	(328)
2	(079)
3	(807)
4	(513)
5	(502)
↕	52.6 mm
↔	43.3 mm

No.48

3 min	
1	(328)
2	(079)
3	(807)
4	(513)
5	(502)
↕	52.8 mm
↔	43.9 mm

No.34

4 min	
1	(328)
2	(079)
3	(807)
4	(513)
5	(502)
↕	52.2 mm
↔	44.3 mm

No.39

4 min	
1	(328)
2	(079)
3	(807)
4	(513)
5	(502)
↕	53.3 mm
↔	46.4 mm

No.44

4 min	
1	(328)
2	(079)
3	(807)
4	(513)
5	(502)
↕	52.3 mm
↔	40.7 mm

No.49

4 min	
1	(328)
2	(079)
3	(807)
4	(513)
5	(502)
↕	53.3 mm
↔	46.5 mm

No.35

3 min	
1	(328)
2	(079)
3	(807)
4	(513)
5	(502)
↕	53.9 mm
↔	23.8 mm

No.40

4 min	
1	(328)
2	(079)
3	(807)
4	(513)
5	(502)
↕	52.9 mm
↔	43.1 mm

No.45

3 min	
1	(328)
2	(079)
3	(807)
4	(513)
5	(502)
↕	52.6 mm
↔	35.0 mm

No.50

3 min	
1	(328)
2	(079)
3	(807)
4	(513)
5	(502)
↕	51.7 mm
↔	42.0 mm

No.36

3 min	
1	(328)
2	(079)
3	(807)
4	(513)
5	(502)
↕	52.6 mm
↔	30.1 mm

No.41

3 min	
1	(328)
2	(079)
3	(807)
4	(513)
5	(502)
↕	52.8 mm
↔	42.6 mm

No.46

3 min	
1	(328)
2	(079)
3	(807)
4	(513)
5	(502)
↕	53.0 mm
↔	42.0 mm

No.51

3 min	
1	(328)
2	(079)
3	(807)
4	(513)
5	(502)
↕	53.8 mm
↔	42.2 mm

No.37

4 min	
1	(328)
2	(079)
3	(807)
4	(513)
5	(502)
↕	52.4 mm
↔	43.4 mm

No.42

3 min	
1	(328)
2	(079)
3	(807)
4	(513)
5	(502)
↕	52.1 mm
↔	36.9 mm

No.47

3 min	
1	(328)
2	(079)
3	(807)
4	(513)
5	(502)
↕	52.5 mm
↔	42.8 mm

No.52

3 min	
1	(328)
2	(079)
3	(807)
4	(513)
5	(502)
↕	52.4 mm
↔	33.4 mm

No.53

2 min	
1	(804)
2	(612)
3	(079)
4	(807)
5	(513)
6	(502)
↕	34.4 mm
↔	22.7 mm

No.55

3 min					
1	(804)	3	(079)	5	(513)
2	(612)	4	(807)	6	(502)
↕ 39.3 mm ↔ 75.4 mm					

No.57

5 min														
1	(804)	7	(804)	13	(079)									
2	(612)	8	(612)	14	(807)									
3	(079)	9	(079)	15	(513)									
4	(807)	10	(807)	16	(502)									
5	(513)	11	(513)											
6	(502)	12	(502)											
↕ 27.9 mm ↔ 121.9 mm														

No.54

2 min	
1	(079)
2	(807)
3	(513)
4	(502)
↕	39.8 mm
↔	25.6 mm

No.56

5 min											
1	(804)	5	(513)	9	(079)						
2	(612)	6	(502)	10	(807)						
3	(079)	7	(804)	11	(513)						
4	(807)	8	(612)	12	(502)						
↕ 23.4 mm ↔ 123.7 mm											



No. 58

10 min		
1 (079)	7 (513)	13 (079)
2 (807)	8 (502)	14 (807)
3 (513)	9 (079)	15 (513)
4 (502)	10 (807)	16 (502)
5 (079)	11 (513)	
6 (807)	12 (502)	
⇅ 103.6 mm ⇆ 94.9 mm		



No.60

4 min	
1 (513)	
2 (807)	
3 (513)	
4 (807)	
⇅ 106.7 mm	
⇆ 93.4 mm	



No.63

1 min	
1 (513)	
⇅ 147.2 mm	
⇆ 61.8 mm	



No.59

20 min		
1 (079)	17 (513)	33 (804)
2 (807)	18 (502)	34 (612)
3 (804)	19 (079)	35 (513)
4 (612)	20 (807)	36 (502)
5 (513)	21 (804)	37 (079)
6 (502)	22 (612)	38 (807)
7 (079)	23 (513)	39 (804)
8 (807)	24 (502)	40 (612)
9 (804)	25 (079)	41 (513)
10 (612)	26 (807)	42 (502)
11 (513)	27 (804)	43 (079)
12 (502)	28 (612)	44 (807)
13 (079)	29 (513)	45 (804)
14 (807)	30 (502)	46 (612)
15 (804)	31 (079)	47 (513)
16 (612)	32 (807)	48 (502)
⇅ 195.4 mm ⇆ 157.3 mm		



No.61

3 min	
1 (513)	
2 (807)	
3 (513)	
4 (807)	
⇅ 42.6 mm	
⇆ 142.0 mm	



No.62

11 min		
1 (513)	4 (807)	7 (513)
2 (807)	5 (513)	8 (807)
3 (513)	6 (807)	
⇅ 195.4 mm ⇆ 158.5 mm		



No.64

7 min		
1 (804)	9 (079)	17 (513)
2 (612)	10 (807)	18 (502)
3 (079)	11 (513)	19 (804)
4 (807)	12 (502)	20 (612)
5 (513)	13 (804)	21 (079)
6 (502)	14 (612)	22 (807)
7 (804)	15 (079)	23 (513)
8 (612)	16 (807)	24 (502)
⇅ 73.3 mm ⇆ 72.8 mm		

Embroidery Patterns Color Change Table
 刺繡花樣顏色轉換表
 Таблицы цветов нитей для вышивок

绣花花样换色顺序表
 자수 패턴 색 변경 테이블

- Line
- 라인

- 线饰花样
- Линейные

- 線條式



No.1

L:	12 min
S:	8 min
1	█ (005)
2	█ (807)
L:	↕ 125.1 mm
	↔ 103.3 mm
S:	↕ 95.9 mm
	↔ 79.1 mm



No.4

L:	14 min
S:	10 min
1	█ (005)
2	█ (807)
L:	↕ 124.8 mm
	↔ 95.8 mm
S:	↕ 95.8 mm
	↔ 73.8 mm



No.7

L:	11 min
S:	8 min
1	█ (005)
2	█ (807)
L:	↕ 125.0 mm
	↔ 87.6 mm
S:	↕ 95.8 mm
	↔ 67.2 mm



No.2

L:	12 min
S:	8 min
1	█ (005)
2	█ (807)
L:	↕ 124.8 mm
	↔ 86.6 mm
S:	↕ 95.7 mm
	↔ 66.4 mm



No.5

L:	14 min
S:	9 min
1	█ (005)
2	█ (807)
L:	↕ 124.8 mm
	↔ 87.8 mm
S:	↕ 95.8 mm
	↔ 67.4 mm

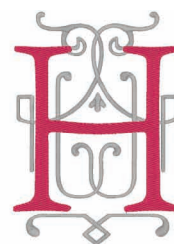

No.8

L:	14 min
S:	10 min
1	█ (005)
2	█ (807)
L:	↕ 125.0 mm
	↔ 89.8 mm
S:	↕ 95.7 mm
	↔ 68.8 mm



No.3

L:	11 min
S:	8 min
1	█ (005)
2	█ (807)
L:	↕ 124.8 mm
	↔ 85.6 mm
S:	↕ 95.8 mm
	↔ 65.8 mm



No.6

L:	12 min
S:	9 min
1	█ (005)
2	█ (807)
L:	↕ 124.8 mm
	↔ 80.8 mm
S:	↕ 95.8 mm
	↔ 61.8 mm



No.9

L:	7 min
S:	5 min
1	█ (005)
2	█ (807)
L:	↕ 124.9 mm
	↔ 66.0 mm
S:	↕ 95.8 mm
	↔ 50.6 mm





No.10

L: 9 min	
S: 6 min	
1	(005)
2	(807)
L:	↓ 124.9 mm
	↔ 75.4 mm
S:	↓ 95.8 mm
	↔ 57.8 mm



No.13

L: 18 min	
S: 12 min	
1	(005)
2	(807)
L:	↓ 125.0 mm
	↔ 117.6 mm
S:	↓ 95.8 mm
	↔ 90.4 mm



No.16

L: 12 min	
S: 8 min	
1	(005)
2	(807)
L:	↓ 125.0 mm
	↔ 82.6 mm
S:	↓ 95.8 mm
	↔ 63.2 mm



No.11

L: 13 min	
S: 8 min	
1	(005)
2	(807)
L:	↓ 125.0 mm
	↔ 95.6 mm
S:	↓ 95.8 mm
	↔ 73.4 mm



No.14

L: 14 min	
S: 10 min	
1	(005)
2	(807)
L:	↓ 124.8 mm
	↔ 96.0 mm
S:	↓ 95.8 mm
	↔ 73.6 mm

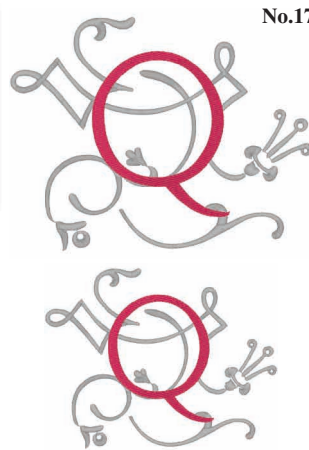

No.17

L: 15 min	
S: 10 min	
1	(005)
2	(807)
L:	↓ 124.8 mm
	↔ 160.4 mm
S:	↓ 96.0 mm
	↔ 123.2 mm



No.12

L: 12 min	
S: 8 min	
1	(005)
2	(807)
L:	↓ 124.9 mm
	↔ 88.1 mm
S:	↓ 95.8 mm
	↔ 67.6 mm

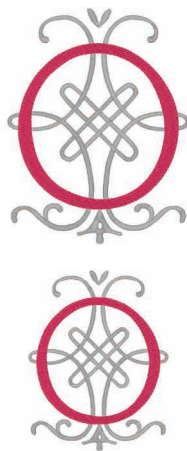

No.15

L: 13 min	
S: 9 min	
1	(005)
2	(807)
L:	↓ 124.6 mm
	↔ 96.8 mm
S:	↓ 95.8 mm
	↔ 74.4 mm



No.18

L: 10 min	
S: 7 min	
1	(005)
2	(807)
L:	↓ 124.8 mm
	↔ 79.6 mm
S:	↓ 95.8 mm
	↔ 61.2 mm



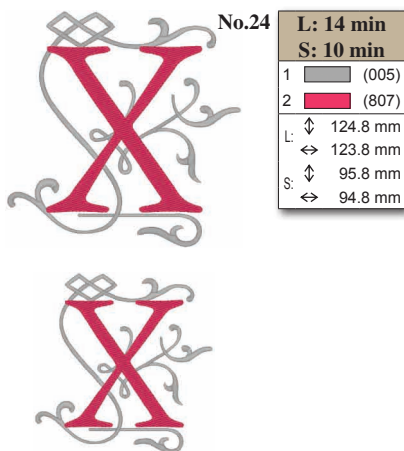
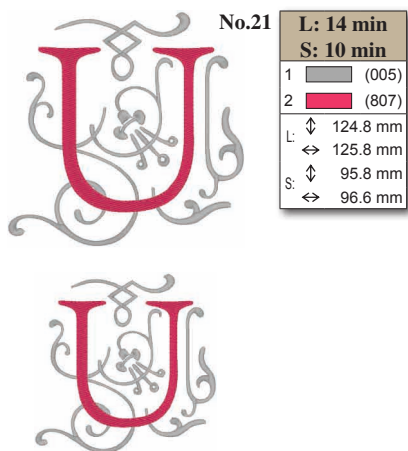
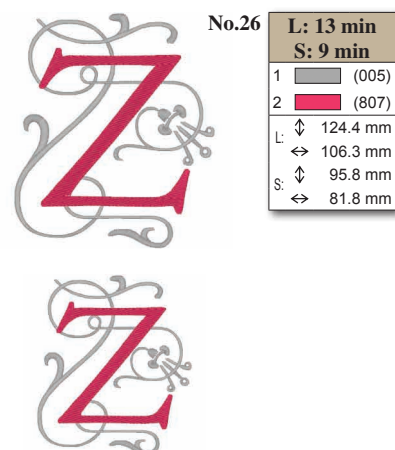
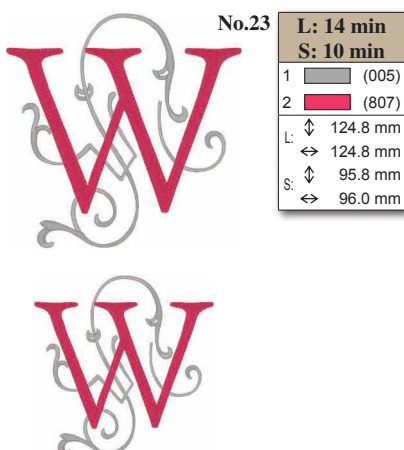
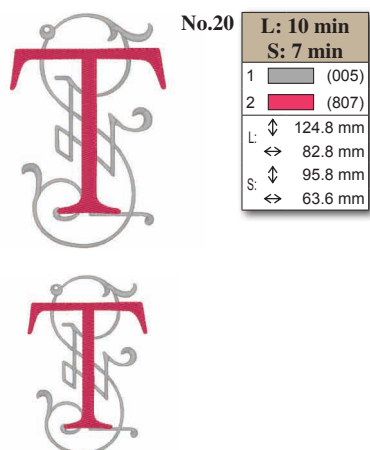
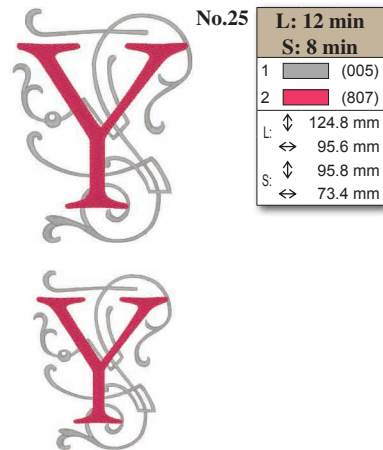
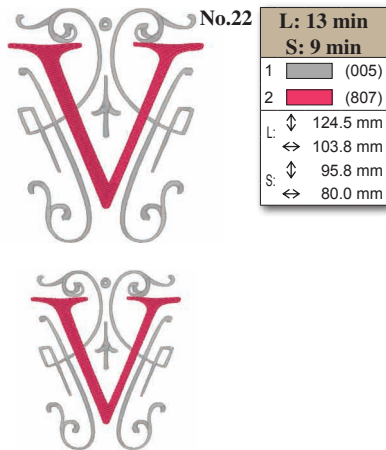
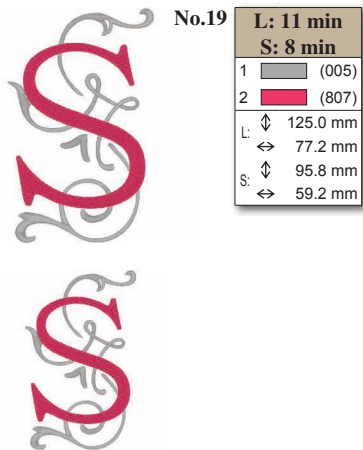

Patterns No.1 - No.26, are designed by Hang to Dry.
 1号至26号设计由Hang to Dry设计。
 花樣 No.1 - No.26 由 Hang to Dry 設計。
 디자인 No.1 - No.26은 Hang to Dry가 디자인하였습니다.
 Рисунок с № 1 по № 26 созданы дизайнерами компании Hang to Dry.

- Vine
- 덩굴

- 藤蔓花样
- Завивающиеся

- 藤蔓式



No.1 **4 min**

1	(620)
2	(612)
↓	54.3 mm
↔	82.8 mm

No.9 **2 min**

1	(620)
2	(612)
↓	55.0 mm
↔	68.3 mm

No.17 **3 min**

1	(620)
2	(612)
↓	54.9 mm
↔	83.5 mm

No.25 **3 min**

1	(620)
2	(612)
↓	53.1 mm
↔	65.9 mm

No.2 **3 min**

1	(620)
2	(612)
↓	54.4 mm
↔	72.6 mm

No.10 **3 min**

1	(620)
2	(612)
↓	54.3 mm
↔	71.0 mm

No.18 **4 min**

1	(620)
2	(612)
↓	54.7 mm
↔	81.5 mm

No.26 **3 min**

1	(620)
2	(612)
↓	55.9 mm
↔	70.0 mm

No.3 **3 min**

1	(620)
2	(612)
↓	53.9 mm
↔	73.3 mm

No.11 **3 min**

1	(620)
2	(612)
↓	55.2 mm
↔	85.3 mm

No.19 **3 min**

1	(620)
2	(612)
↓	54.5 mm
↔	73.8 mm

No.27 **3 min**

1	(620)
2	(612)
↓	57.4 mm
↔	57.7 mm

No.4 **4 min**

1	(620)
2	(612)
↓	54.6 mm
↔	80.0 mm

No.12 **3 min**

1	(620)
2	(612)
↓	53.9 mm
↔	75.0 mm

No.20 **3 min**

1	(620)
2	(612)
↓	54.2 mm
↔	73.2 mm

No.28

3 min	
1	(620)
2	(612)
↓	31.5 mm ↔ 119.2 mm

No.5 **3 min**

1	(620)
2	(612)
↓	55.0 mm
↔	65.3 mm

No.13 **4 min**

1	(620)
2	(612)
↓	54.1 mm
↔	85.0 mm

No.21 **3 min**

1	(620)
2	(612)
↓	53.6 mm
↔	78.3 mm

No.29

2 min	
1	(620)
2	(612)
↓	13.4 mm ↔ 195.4 mm

No.6 **3 min**

1	(620)
2	(612)
↓	54.0 mm
↔	78.8 mm

No.14 **3 min**

1	(620)
2	(612)
↓	54.6 mm
↔	84.8 mm

No.22 **3 min**

1	(620)
2	(612)
↓	53.2 mm
↔	70.9 mm

No.7 **3 min**

1	(620)
2	(612)
↓	54.6 mm
↔	70.4 mm

No.15 **3 min**

1	(620)
2	(612)
↓	53.9 mm
↔	78.7 mm

No.23 **4 min**

1	(620)
2	(612)
↓	53.4 mm
↔	82.6 mm

No.1 **4 min**

1	(620)
2	(612)
↓	54.3 mm
↔	82.8 mm

No.8 **4 min**

1	(620)
2	(612)
↓	54.3 mm
↔	83.3 mm

No.16 **3 min**

1	(620)
2	(612)
↓	54.7 mm
↔	67.2 mm

No.24 **3 min**

1	(620)
2	(612)
↓	53.2 mm
↔	83.4 mm

- Appliqué alphabet
- 아플리케 알파벳

- 贴布绣字母
- Алфавит для аппликации

- 貼布字母

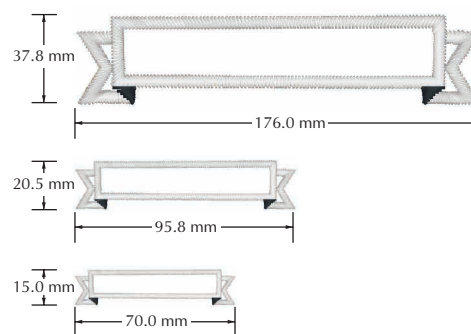
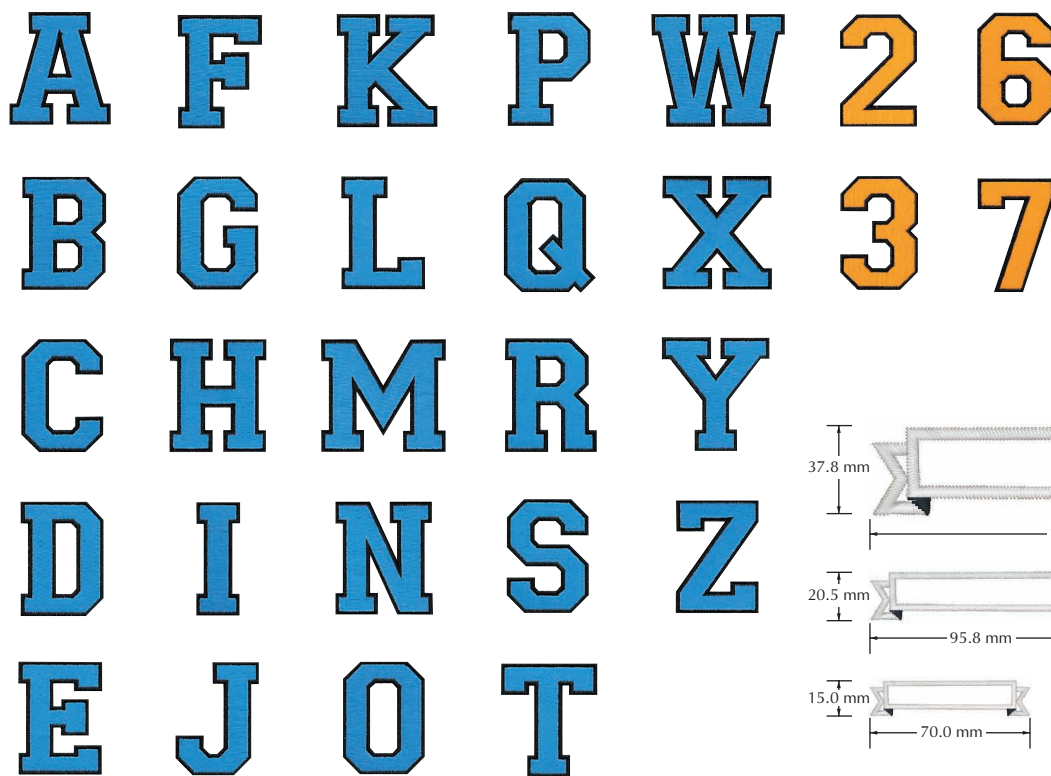
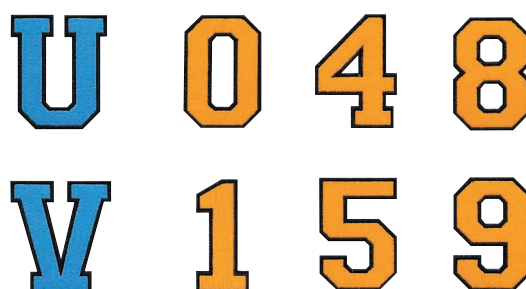

Refer to the operation manual for the embroidery machine for details on how to embroider appliqué.
 有关如何绣制贴布绣的详细信息，请参见绣花机的使用说明书。
 關於如何繡上印刷和針趾花樣的詳細資訊，請參考縫紉機的使用說明書。
 자세한 아플리케 자수 방법은 자수기 작동 설명서를 참조하세요.
 Инструкции по вышиванию аппликаций приведены в руководстве пользователя машины.

Embroidery Patterns Color Change Table
 刺繡花樣顏色轉換表
 Таблицы цветов нитей для вышивок

绣花花样换色顺序表
 자수 패턴 색 변경 테이블

- Appliqué Greek alphabet
- 아플리케 그리스 알파벳

- 貼布绣希腊字母
- Греческий алфавит для аппликации

- 貼布希臘字母



<p>No.1 3 min</p>  <p>1 ---x (420) 2 --- (420) 3 --- (509) 4 (509)</p> <p>↓ 77.8 mm ⇔ 80.4 mm</p>	<p>No.7 4 min</p>  <p>1 ---x (420) 2 --- (420) 3 --- (509) 4 (509)</p> <p>↓ 75.9 mm ⇔ 78.5 mm</p>	<p>No.13 4 min</p>  <p>1 ---x (420) 2 --- (420) 3 --- (509) 4 (509)</p> <p>↓ 78.3 mm ⇔ 78.4 mm</p>	<p>No.19 3 min</p>  <p>1 ---x (420) 2 --- (420) 3 --- (509) 4 (509)</p> <p>↓ 76.1 mm ⇔ 68.0 mm</p>
<p>No.2 4 min</p>  <p>1 ---x (420) 2 --- (420) 3 --- (509) 4 (509)</p> <p>↓ 76.0 mm ⇔ 70.7 mm</p>	<p>No.8 5 min</p>  <p>1 ---x (420) 2 --- (420) 3 --- (509) 4 (509)</p> <p>↓ 80.2 mm ⇔ 73.9 mm</p>	<p>No.14 5 min</p>  <p>1 ---x (420) 2 --- (420) 3 --- (509) 4 (509)</p> <p>↓ 76.1 mm ⇔ 68.5 mm</p>	<p>No.20 3 min</p>  <p>1 ---x (420) 2 --- (420) 3 --- (509) 4 (509)</p> <p>↓ 75.9 mm ⇔ 79.1 mm</p>
<p>No.3 3 min</p>  <p>1 ---x (420) 2 --- (420) 3 --- (509) 4 (509)</p> <p>↓ 76.0 mm ⇔ 68.2 mm</p>	<p>No.9 2 min</p>  <p>1 ---x (420) 2 --- (420) 3 --- (509) 4 (509)</p> <p>↓ 76.0 mm ⇔ 38.1 mm</p>	<p>No.15 3 min</p>  <p>1 ---x (420) 2 --- (420) 3 --- (509) 4 (509)</p> <p>↓ 80.3 mm ⇔ 73.9 mm</p>	<p>No.21 4 min</p>  <p>1 ---x (420) 2 --- (420) 3 --- (509) 4 (509)</p> <p>↓ 75.9 mm ⇔ 78.0 mm</p>
<p>No.4 3 min</p>  <p>1 ---x (420) 2 --- (420) 3 --- (509) 4 (509)</p> <p>↓ 77.7 mm ⇔ 70.0 mm</p>	<p>No.10 4 min</p>  <p>1 ---x (420) 2 --- (420) 3 --- (509) 4 (509)</p> <p>↓ 76.1 mm ⇔ 80.5 mm</p>	<p>No.16 4 min</p>  <p>1 ---x (420) 2 --- (420) 3 --- (509) 4 (509)</p> <p>↓ 75.9 mm ⇔ 82.6 mm</p>	<p>No.22 4 min</p>  <p>1 ---x (420) 2 --- (420) 3 --- (509) 4 (509)</p> <p>↓ 76.0 mm ⇔ 80.8 mm</p>
<p>No.5 4 min</p>  <p>1 ---x (420) 2 --- (420) 3 --- (509) 4 (509)</p> <p>↓ 76.1 mm ⇔ 69.8 mm</p>	<p>No.11 3 min</p>  <p>1 ---x (420) 2 --- (420) 3 --- (509) 4 (509)</p> <p>↓ 78.0 mm ⇔ 76.0 mm</p>	<p>No.17 3 min</p>  <p>1 ---x (420) 2 --- (420) 3 --- (509) 4 (509)</p> <p>↓ 76.0 mm ⇔ 62.0 mm</p>	<p>No.23 4 min</p>  <p>1 ---x (420) 2 --- (420) 3 --- (509) 4 (509)</p> <p>↓ 76.0 mm ⇔ 86.7 mm</p>
<p>No.6 3 min</p>  <p>1 ---x (420) 2 --- (420) 3 --- (509) 4 (509)</p> <p>↓ 76.0 mm ⇔ 67.4 mm</p>	<p>No.12 5 min</p>  <p>1 ---x (420) 2 --- (420) 3 --- (509) 4 (509)</p> <p>↓ 76.0 mm ⇔ 95.3 mm</p>	<p>No.18 4 min</p>  <p>1 ---x (420) 2 --- (420) 3 --- (509) 4 (509)</p> <p>↓ 76.0 mm ⇔ 69.0 mm</p>	<p>No.24 4 min</p>  <p>1 ---x (420) 2 --- (420) 3 --- (509) 4 (509)</p> <p>↓ 78.0 mm ⇔ 74.1 mm</p>

Refer to the operation manual for the embroidery machine for details on how to embroider appliqués.
 有关如何绣制贴布绣的详细信息，请参见绣花机的使用说明书。
 關於如何繡上印刷和針趾花樣的詳細資訊，請參考縫紉機的使用說明書。
 자세한 아플리케 자수 방법은 자수기 작동 설명서를 참조하세요.
 Инструкции по вышиванию аппликаций приведены в руководстве пользователя машины.

Examples of Combinations 組合範例 Примеры комбинирования

花样组合示例 조합 예

Combine various embroidery patterns, as shown below, to enhance your embroidering enjoyment.

如下所示，組合不同的绣花花样以增加您的绣制乐趣。

如下所示組合各種刺繡花樣，以增添您的刺繡樂趣。

아래처럼 다양한 자수 패턴을 조합하여 더 큰 자수의 재미를 느끼세요 .

Чтобы получить красивые и оригинальные композиции, можно комбинировать различные рисунки, как показано ниже.



No.16 × 2 + No.17 × 2



No.8 + No.9 × 2



No.3 × 2

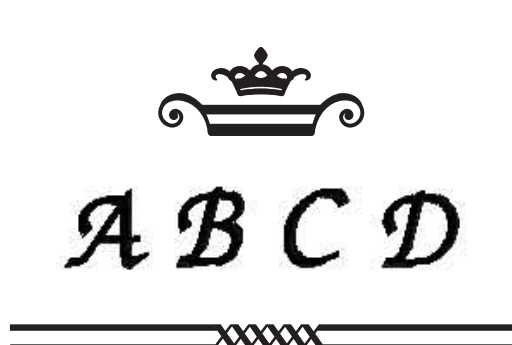

No.14 + 15



No.12 × 2

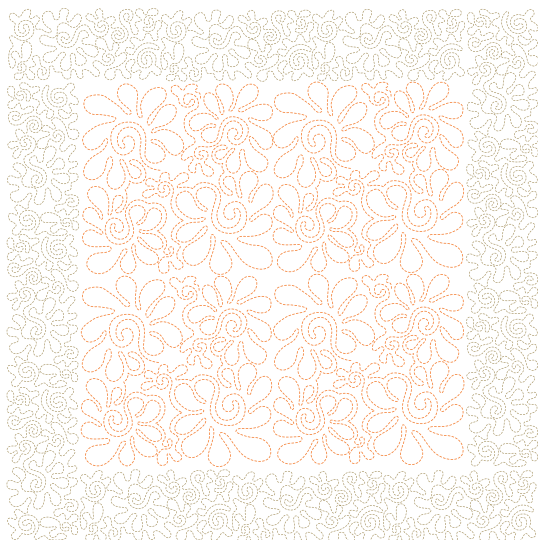

No.2 × 4 + No.14 × 12

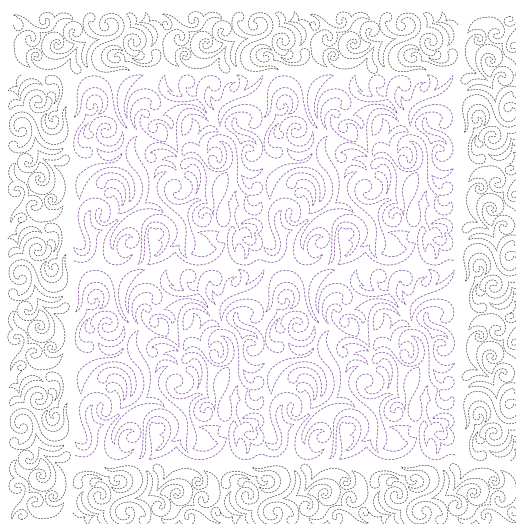

No.8 × 4 + No.16 × 12

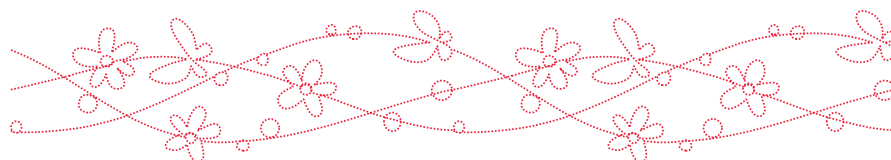

No.17 × 2



No.2 + No.27 × 2



No.6 + No.10 + No.19



No.2 + No.28 × 2























Color Thread Conversion Chart



















































繡線顏色轉換表

Таблица преобразования цветов нитей

绣花线颜色转换表

색실 변환 차트

	Color Name / 颜色名称 / 颜色名稱 / 색 이름 / Наименование цвета	Embroidery	Country	Madeira Polyneon	Madeira Rayon	Sulky	R.A. Polyster
1	Black / 黑色 / 黑 / 검정 / Черный	 900	 100	1800	1000	1005	5596
2	White / 白色 / 白 / 하양 / Белый	 001	 000	1801	1002	1001	5597
3	Red / 红色 / 紅 / 빨강 / Красный	 800	 149	1637	1037	1037	5678
4	Pink / 粉红色 / 粉 / 분홍 / Розовый	 085	 155	1921	1108	1224	5523
5	Deep Rose / 深玫红 / 深玫瑰 / 진한 장미색 / Темно-розовый	 086	 024	1721	1117	1154	9168
6	Flesh Pink / 肉粉色 / 淡粉 / 살분홍 / Свежий розовый	 124	 152	1915	1015	1064	5677
7	Dark Fuchsia / 深紫红 / 深桃红 / 어두운 푸크시아색 / Цвет темной фуксии	 107	 126	1984	1383	1533	5804
8	Vermillion / 朱红色 / 朱红 / 주색 / Багряный	 030	 148	1779	1179	1184	9023
9	Carmine / 洋红色 / 胭脂红 / 카민 / Карминный	 807	 158	1986	1081	1511	5561
10	Royal Purple / 蓝紫色 / 皇家紫 / 로열퍼플 / Яркий пурпурный	 869	 636	1788	1188	1192	5681
11	Magenta / 品红 / 红紫 / 마젠타 / Фуксин	 620	 625	1710	1319	1191	5592
12	Salmon Pink / 橙红色 / 橙红 / 새먼핑크 / Оранжево-розовый	 079	 122	1816	1317	1225	5773
13	Amber Red / 琥珀红 / 琥珀红 / 앰버레드 / Янтарно-красный	 333	 212	1942	1341	1119	5591
14	Lemon Yellow / 柠檬黄 / 檸檬黃 / 레몬옐로 / Лимонно-желтый	 202	 342	1623	1023	1067	5625
15	Yellow / 黄色 / 黃 / 노랑 / Желтый	 205	 043	1980	1068	1187	5860
16	Harvest Gold / 金黄色 / 金 / 하비스트골드 / Желто-золотистый	 206	 334	1971	1024	1124	5770
17	Orange / 橙色 / 橘 / 주황 / Оранжевый	 208	 335	1951	1137	1024	5694
18	Pumpkin / 南瓜色 / 南瓜色 / 호박색 (채소) / Тыквенный	 126	 322	1952	1155	1065	5630
19	Tangerine / 橘子色 / 蜜桔橘 / 귤색 / Мандаринный цвет	 209	 336	1965	1078	1078	5518
20	Cream Brown / 乳褐色 / 奶油棕 / 크림브라운 / Кремовый	 010	 331	1866	1022	1061	5761
21	Cream Yellow / 乳黄色 / 奶油黄 / 크림옐로 / Кремово-желтый	 812	 370	1861	1349	1135	5564
22	Khaki / 卡其色 / 卡其色 / 카키색 / Цвет хаки	 348	 242	1939	1255	1055	5636
23	Deep Gold / 深黄色 / 深金 / 진한 금색 / Глубокий золотой	 214	 354	1772	1172	1025	5770
24	Brass / 黄铜色 / 黃銅色 / 황동색 / Цвет латуни	 328	 404	1791	1192	1159	9109
25	Linen / 亚麻色 / 亞麻色 / 리넨색 / Льняной	 307	 025	1682	1149	1082	5635
26	Dark Brown / 深褐色 / 深棕 / 어두운 갈색 / Темно-коричневый	 058	 717	1859	1130	1129	5637
27	Reddish Brown / 红褐色 / 紅棕 / 적갈색 / Красно-коричневый	 337	 264	1753	1253	1021	5781
28	Clay Brown / 土棕褐色 / 土棕褐 / 클레이브라운 / Коричневый	 339	 224	1621	1021	1158	5590
29	Beige / 米黄色 / 米色 / 베이지색 / Бежевый	 843	 012	1738	1138	1127	5598
30	Warm Gray / 暖灰色 / 暖灰 / 웜그레이 / Теплый серый	 399	 706	1860	1085	1218	9126
31	Russet Brown / 赤褐色 / 黃褐棕 / 팔색 / Желто-коричневый	 330	 414	1726	1194	1126	5702
32	Light Brown / 浅棕色 / 淺棕 / 밝은 갈색 / Светло-коричневый	 323	 255	1729	1056	1128	5789
33	Seacrest / 蓝绿色 / 青瓷色 / 청자색 (도기) / Сероголубой	 542	 505	1647	1219	1077	5578
34	Mint Green / 薄荷绿 / 薄荷綠 / 민트그린 / Мятный зеленый	 502	 461	1702	1302	1047	5511
35	Leaf Green / 叶绿色 / 黃 / 리프그린 / Цвет зеленой ливствы	 509	 463	1749	1050	1510	5514
36	Olive Green / 橄榄绿 / 橄欖綠 / 올리브그린 / Зеленый оливковый	 519	 476	1904	1396	1174	5502

	Color Name / 颜色名称 / 颜色名稱 / 색 이름 / Наименование цвета	Embroidery	Country	Madeira Polyneon	Madeira Rayon	Sulky	R.A. Polyster
37	Dark Olive / 深橄欖色 / 暗橄欖綠 / 어두운 올리브색 / Темно-оливковый	 517	 473	1769	1156	1156	9122
38	Teal Green / 青綠色 / 深青綠 / 틸그린 / Опалово-зеленый	 534	 483	1879	1298	1503	5751
39	Emerald Green / 翡翠綠 / 鮮綠 / 에메랄드그린 / Изумрудный	 507	 485	1750	1250	1079	5508
40	Deep Green / 深綠色 / 深綠 / 진한 녹색 / Темно-зеленый	 808	 467	1703	1370	1208	5615
41	Fresh Green / 嫩綠色 / 青綠 / 프레시그린 / Цвет свежей зелени	 027	 442	1706	1102	1209	9153
42	Lime Green / 亮綠色 / 萊姆綠 / 라임그린 / Лаймовый зеленый	 513	 444	1848	1049	1177	5622
43	Moss Green / 苔綠色 / 苔蘚綠 / 모스그린 / Серо-зеленый	 515	 446	1770	1369	1176	9091
44	Blue / 藍色 / 藍 / 파랑 / Синий	 405	 586	1829	1177	1076	5684
45	Ultra Marine / 深藍色 / 群青色 / 군청색 / Ультрамарин	 406	 575	1842	1076	1042	5736
46	Light Blue / 淺藍色 / 淡藍 / 밝은 파랑 / Светло-голубой	 017	 150	1932	1132	1074	5683
47	Sky Blue / 天藍色 / 天藍 / 하늘색 / Лазурь	 019	 512	1828	1029	1196	5506
48	Electric Blue / 鐵藍色 / 銅青色 / 강청색 / Электрик	 420	 564	1797	1297	1250	5829
49	Peacock Blue / 孔雀藍 / 孔雀藍 / 피콕블루 / Переливчатый синий	 415	 057	1652	1252	1206	5810
50	Prussian Blue / 普魯士藍 / 普魯士藍 / 프리시안블루 / Берлинская лазурь	 007	 588	1767	1166	1535	5737
51	Comflower Blue / 矢車菊藍 / 矢車菊藍 / 콘플라워블루 / Васильковый	 070	 015	1830	1335	1028	5601
52	Light Lilac / 淺紫色 / 淺紫 / 밝은 라일락색 / Светло-сиреневый	 810	 133	1911	1031	1121	9016
53	Lilac / 淡紫色 / 雪青 / 라일락색 / Сиреневый	 612	 623	1831	1080	1080	9009
54	Violet / 紫羅蘭 / 紫羅蘭色 / 바이올렛색 / Фиолетовый	 613	 624	1631	1033	1194	5588
55	Purple / 紫色 / 紫 / 보라 / Пурпурный	 614	 635	1880	1122	1122	5554
56	Lavender / 薰衣草淡紫 / 薰衣草紫 / 라벤더색 / Лавандовый	 804	 604	1630	1261	1193	5586
57	Wisteria Violet / 紫藤紫 / 紫藤紫 / 위스테리어 바이올렛색 / Цвет глицинии	 607	 003	1943	1311	1032	5587
58	Pewter / 青灰色 / 沙電色 / 뿔납색 / Цвет пьютера	 704	 745	1840	1041	1041	9114
59	Dark Gray / 深灰色 / 深灰 / 어두운 회색 / Темно-серый	 707	 747	1841	1241	1220	5565
60	Silver / 銀色 / 銀 / 은색 / Серебряный	 005	 020	1812	1087	1011	5640
61	Gray / 灰色 / 灰 / 회색 / Серый	 817	 734	1640	1118	1219	5782
62	----->						
63	-----						
64	~~~~~ TTTTTTTTTTTTTTTTTTTT						
65	NOT DEFINED / 未定义 / 未定義 / 정의되지 않음 / НЕ ОПРЕДЕЛЕНО						

Note: The conversion chart is based on Embroidery thread. The color shades may vary with the different brands listed on the chart. If unsure of a particular color(s), please sew test. Robison Anton (R.A.), Madeira and Sulky are respectively registered trademarks. Actual colors may vary slightly from the chart.

注释：本转换表以绣花线为准。根据表中所列的不同品牌，颜色可能会有色差。若不确定某一特定颜色，请先做一个绣花测试。Robison Anton (R.A.)、Madeira 与 Sulky 分别是注册商标。实际的颜色可能与表格中所显示颜色稍有不同。

註釋：本轉換表以刺繡線為準。表中所列的不同品牌可能會有色差。如果對於特定顏色不確定，請進行縫紉測試。Robison Anton (R.A.)、Madeira 及 Sulky 分別為註冊商標。實際顏色可能與表中所示不同。

참고: 변환 차트는 자수실 기준입니다. 차트의 브랜드마다 색조가 다를 수 있습니다. 특정 색이 불확실하면 시험 재봉을 해보세요. Robison Anton (R.A.), Madeira, Sulky 는 각각 등록 상표입니다. 실제 색은 차트와 약간 다를 수 있습니다.

Примечание: Таблица преобразования составлена на базе вышивальных нитей. Оттенки цветов могут варьироваться в зависимости от производителей, указанных в таблице. Если вы не уверены в выборе какого-то конкретного цвета, произведите пробную вышивку. Robison Anton (R.A.), Madeira и Sulky являются зарегистрированными товарными знаками. Реальные цвета могут несколько отличаться от представленных в таблице.

Font Name Chart

字體名稱表

Таблица названий шрифтов

字体名称表

글꼴 이름 차트

	Font Key/ 字体键 / 字體鍵 / 글꼴 키 / Кнопка шрифта	Font Name/ 字体名称 / 字體名稱 / 글꼴 이름 / Название шрифта
1	⁰⁰ 	Künstlerschreibschrift
2	⁰¹ 	Block 01
3	⁰² 	Serif 01
4	⁰³ 	Brussels Demi Outline
5	⁰⁴ 	Serif 02
6	⁰⁵ 	Gothic 01
7	⁰⁶ 	Calgary MediumItalic
8	⁰⁷ 	Sicilia Light Italic
9	⁰⁸ 	Luedickital
10	⁰⁹ 	Toms Handwritten
11	¹⁰ 	Istanbul
12	¹¹ 	San Diego
13	¹² 	Los Angeles
14	¹³ 	Saipan
15	¹⁴ 	Helsinki Nallow Small
16	¹⁵ 	Riesa S
17	¹⁶ 	Germany S
18	¹⁷ 	Script 01 SR
19	¹⁸ 	Utah Bold Cyrillic
20	¹⁹ 	PC Tennessee Bold Cyrillic

English
Chinese-simp
Chinese-trad
Korean
Russian

882-T51
Printed in Taiwan



XG3766-001