

brother

Embroidery Machine

Operation Manual

Product Code: 884-T20

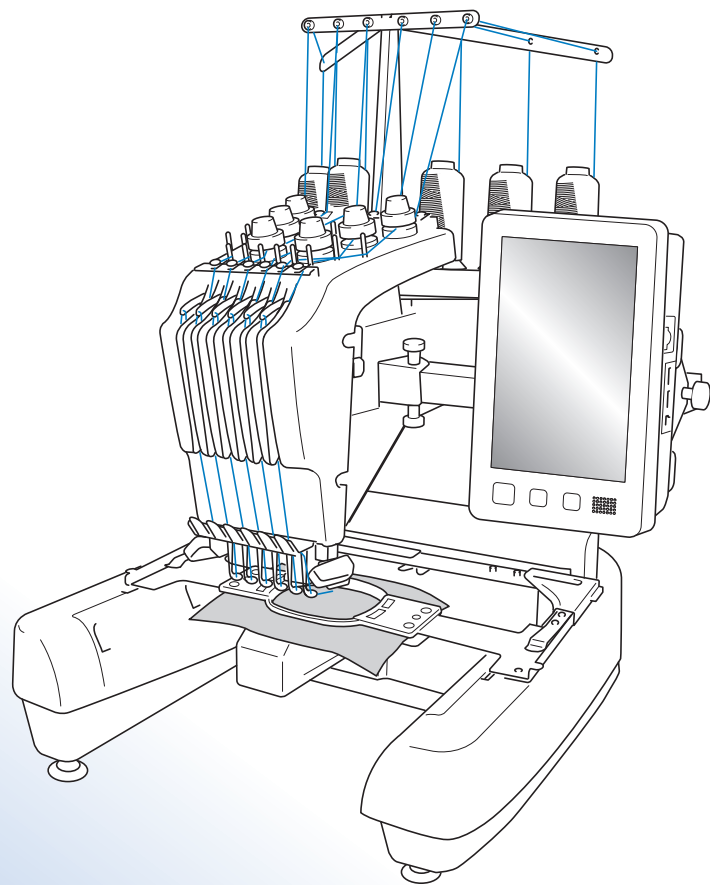

Be sure to read this document before using the machine.
We recommend that you keep this document nearby for future reference.

Trademarks

IBM is a registered trademark or a trademark of International Business Machines Corporation. Microsoft and Windows are registered trademarks or trademarks of Microsoft Corporation.

Each company whose software title is mentioned in this manual has a Software License Agreement specific to its proprietary programs.

All other brands and product names mentioned in this manual are registered trademarks of their respective companies. However, the explanations for markings such as ® and ™ are not clearly described within the text.

Open Source Licensing Remarks

This product includes open-source software.

To see the open source licensing remarks, please go to the manual download section on your model's home page of Brother Solutions Center at “ <http://s.brother/cpbac> ”.

Introduction

Thank you for purchasing this embroidery machine. Before using this machine, carefully read the "IMPORTANT SAFETY INSTRUCTIONS", and then study this manual for the correct operation of the various functions.

In addition, after you have finished reading this manual, store it where it can quickly be accessed for future reference.

IMPORTANT SAFETY INSTRUCTIONS

Please read these safety instructions before attempting to use the machine.

DANGER - To reduce the risk of electric shock:

- 1** Always unplug the machine from the electrical outlet immediately after using, when cleaning, when making any user servicing adjustments mentioned in this manual, or if you are leaving the machine unattended.

WARNING - To reduce the risk of burns, fire, electric shock, or injury to persons:

- 2** Always unplug the machine from the electrical outlet when lubricating it or when making any other user servicing adjustments mentioned in the operation manual
 - To unplug the machine, switch the machine to the symbol "O" position to turn it off, then grasp the plug and pull it out of the electrical outlet. Do not pull on the cord.
 - Plug the machine directly into the electrical outlet. Do not use an extension cord.
 - Always unplug your machine if the power is cut.
- 3** Electrical Hazards:
 - This machine should be connected to an AC power source within the range indicated on the rating label. Do not connect it to a DC power source or inverter. If you are not sure what kind of power source you have, contact a qualified electrician.
 - This machine is approved for use in the country of purchase only.
- 4** Never operate this machine if it has a damaged cord or plug, if it is not working properly, if it has been dropped or damaged, or water is spilled on the unit. Return the machine to the nearest authorized Brother dealer or service center for examination, repair, electrical or mechanical adjustment.
 - To avoid electric shock or fire; do not use a damaged power supply plug or loose electrical outlet, and ensure that the power supply plug is fully inserted and secure.
 - While the machine is stored or in use if you notice anything unusual, such as an odor, heat, discoloration or deformation, stop using the machine immediately and unplug the power cord.
 - When transporting the machine, be sure to lift it from the bottom positions. Lifting the machine by any other part may damage the machine or result in the machine falling, which could cause injuries.
 - When lifting the machine, be careful not to make any sudden or careless movements, otherwise you may injure your back or knees.
 - While the machine is being transported, be careful not to touch the operation panel, thread guides or any other part, otherwise injuries may result.

5 Always keep your work area clear:

- Never operate the machine with any air openings blocked. Keep ventilation openings of the machine free from the build up of lint, dust, and loose cloth.
- Do not use extension cords. Plug the machine directly into the electrical outlet.
- Never drop or insert any object into any opening.
- Keep fingers out of all machine openings, such as near the carriage, otherwise injuries may result.
- Do not operate where aerosol (spray) products are being used or where oxygen is being administered.
- Do not use the machine near a heat source, such as a stove or iron; otherwise, the machine, power cord or garment being sewn may ignite, resulting in fire or an electric shock.
- Do not use this machine near an open flame; the movement of the embroidery frame could cause the garment being sewn to catch fire.
- Do not place this machine on an unstable surface, such as an unsteady or slanted table, otherwise the machine may fall, resulting in injuries.
- While attaching or detaching an embroidery frame or other included accessory or while maintaining the machine, be careful not to hit the machine with your body or any other part of it.

6 Special care is required when sewing:

- Always pay close attention to the needle. Do not use bent or damaged needles.
- Keep fingers away from all moving parts. Special care is required around the machine needle.
- While the machine is in operation, keep your hands away from the needle bar case and all moving parts near the needle bar case, otherwise injuries may result.
- Switch the machine to the symbol "O" position to turn it off when making any adjustments in the needle area, such as changing the needle.
- Do not use a damaged or incorrect needle plate, as it could cause the needle to break.

7 This machine is not a toy:

- Your close attention is necessary when the machine is used by or near children.
- This machine is not intended for use by young children or infirm persons without supervision.
- Young children should be supervised to ensure that they do not play with this machine.
- Do not use the included scissors or seam ripper in any other way than how they are intended. In addition, when opening a hole with the seam ripper, do not place your hands or fingers in the cutting path, otherwise injuries may result if the seam ripper slips.
- The plastic bag that this machine was supplied in should be kept out of the reach of children or disposed of. Never allow children to play with the bag due to the danger of suffocation.
- Do not use outdoors.

8 For a longer service life:

- When storing this machine, avoid direct sunlight and high humidity locations. Do not use or store the machine near a space heater, iron, halogen lamp, or other hot objects.
- Use only neutral soaps or detergents to clean the case. Benzene, thinner, and scouring powders can damage the case and machine, and should never be used.
- Always consult the operation manual when replacing or installing any assemblies, needle, or other parts to assure correct installation.

9 For repair or adjustment:

- Do not try to disassemble, repair or alter this machine in any way, otherwise a fire, electric shock or injuries may result.
- If the light unit is damaged, it must be replaced by an authorized Brother dealer.
- In the event a malfunction occurs or adjustment is required, first follow the troubleshooting table in the back of the operation manual to inspect and adjust the machine yourself. If the problem persists, please consult your local authorized Brother dealer.

Use this machine only for its intended use as described in the manual.

Use accessories recommended by the manufacturer as contained in this manual.

Use only the interface cable (USB cable) included with this machine.

Use only a mouse designed specifically for this machine.

The contents of this manual and specifications of this product are subject to change without notice.

For additional product information and updates, visit our website at www.brother.com

SAVE THESE INSTRUCTIONS

This machine is intended for household use.

FOR USERS IN COUNTRIES EXCEPT CENELEC COUNTRIES

This appliance is not intended for use by persons (including children) with reduced physical, sensory or mental capabilities, or lack of experience and knowledge, unless they have been given supervision or instruction concerning use of the appliance by a person responsible for their safety. Children should be supervised to ensure that they do not play with the appliance.

FOR USERS IN CENELEC COUNTRIES

This appliance can be used by children aged from 8 years and above and persons with reduced physical, sensory or mental capabilities or lack of experience and knowledge if they have been given supervision or instruction concerning use of the appliance in a safe way and understand the hazards involved. Children shall not play with the appliance. Cleaning and user maintenance shall not be made by children without supervision.

FOR USERS IN THE UK, EIRE, MALTA AND CYPRUS ONLY

IMPORTANT

- In the event of replacing the plug fuse, use a fuse approved by ASTA to BS 1362, i.e. carrying the  mark, rating as marked on plug.
- Always replace the fuse cover. Never use plugs with the fuse cover omitted.
- If the available electrical outlet is not suitable for the plug supplied with this equipment, you should contact your authorized Brother dealer to obtain the correct lead.

Federal Communications Commission (FCC) Declaration of Conformity (For USA Only)

Responsible Party: Brother International Corporation
200 Crossing Boulevard
P.O. Box 6911
Bridgewater, NJ 08807-0911 USA
TEL : (908) 704-1700

declares that the product

Product Name: Brother Embroidery Machine
Model Number: PR670E

complies with Part 15 of the FCC Rules. Operation is subject to the following two conditions: (1) this device may not cause harmful interference, and (2) this device must accept any interference received, including interference that may cause undesired operation.

This equipment has been tested and found to comply with the limits for a Class B digital device, pursuant to Part 15 of the FCC Rules. These limits are designed to provide reasonable protection against harmful interference in a residential installation. This equipment generates, uses, and can radiate radio frequency energy and, if not installed and used in accordance with the instructions, may cause harmful interference to radio communications. However, there is no guarantee that interference will not occur in a particular installation. If this equipment does cause harmful interference to radio or television reception, which can be determined by turning the equipment off and on, the user is encouraged to try to correct the interference by one or more of the following measures:

- Reorient or relocate the receiving antenna.
- Increase the separation between the equipment and receiver.
- Connect the equipment into an outlet on a circuit different from that to which the receiver is connected.
- Consult the dealer or an experienced radio/TV technician for help.
- The included interface cable should be used in order to ensure compliance with the limits for a Class B digital device.
- Changes or modifications not expressly approved by Brother Corporation could void the user's authority to operate the equipment.

License Agreement

The enclosed machine includes data, software and/or documentation (collectively "CONTENT") that are proprietary products of Brother Industries, Ltd. ("BROTHER"). BY USING THE CONTENT, THE CUSTOMER ACCEPTS THE TERMS AND CONDITIONS OF THIS AGREEMENT. BROTHER retains ownership of all rights to CONTENT and to the copies of the CONTENT included in this package. The CONTENT are licensed (not sold) to you ("CUSTOMER") under the terms and conditions of this Agreement.

CUSTOMER is licensed to:

- Use the CONTENT in combination with an embroidery machine to create embroidery.
- Use the CONTENT in combination with an embroidery machine that CUSTOMER owns or uses, provided that the CONTENT is not used on more than one embroidery machine at a time.

Except as otherwise provided herein, CUSTOMER may not:

- Allow more than one copy of the CONTENT to be available for use at any one time.
- Reproduce, modify, publish, distribute, sell, rent, sublicense or otherwise make available to others CONTENT.
- Distribute, rent, sublicense, lease, sell, transfer or assign the media card or CONTENT.
- Decompile, disassemble or otherwise reverse engineer the CONTENT or assist others to do the same.
- Alter, translate, modify or adapt the CONTENT or any part thereof for business, commercial or industrial purposes.
- Sell or otherwise distribute the EMBROIDERY created by use of the CONTENT, WHICH ORIGINALLY BEARS CERTAIN COPYRIGHT NOTICE UNDER THE NAME OF ANY THIRD PARTIES OTHER THAN BROTHER (e.g. "©DISNEY").

BROTHER retains all rights not expressly granted to CUSTOMER herein.

Nothing in this agreement constitutes a waiver of the rights of BROTHER under any law. This agreement shall be governed by the laws of Japan.

Please direct all inquiries concerning this Agreement in writing by regular mail, to Brother Industries, Ltd., 1-1-1 Kawagishi, Mizuho-ku, Nagoya 467-8562, Japan, Attention: P&H company Sales and Marketing Dept.

Warning Labels

The following warning labels are on the machine.
Be sure to observe the precautions described in the labels.

1

	▲CAUTION	▲VORSICHT	▲ATTENTION	▲PRECAUCIÓN	▲CUIDADO
	Carriage may cause injury. Do not put hands in carriage traveling path.	Um Verletzungen mit dem Stickarm zu vermeiden, nicht die Hände in die Nähe des Stickarms halten.	Le chariot peut provoquer des blessures. Ne pas mettre les mains dans le chemin du chariot.	El carro puede provocar lesiones. No poner las manos por donde pasa el carro.	O carro de transporte pode causar ferimentos. Não coloque as mãos sobre o trilho do carro de transporte.

	▲VOORZICHTIG	▲ATTENZIONE	▲ОСТОРОЖНО!	▲注意	▲注意
	De borduurarm kan verwondingen veroorzaken. Houdt uw handen buiten bereik van de borduurarm.	Il carrello potrebbe ferirvi. Non appoggiate la mano nel percorso del carrello.	Движущаяся каретка может быть причиной травмы. Не кладите руки на пути движения каретки.	刺しゅう機のキャリッジや刺しゅう枠が動いているときに、手や物を近づけないでください。 ケガの原因になります。	在绣花机的导轨或绣花框移动时，为避免造成伤害，请不要将手或物品靠近。

2

Label locations

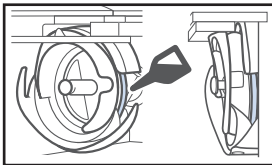

Please put a drop of oil onto the hook once a day before use.

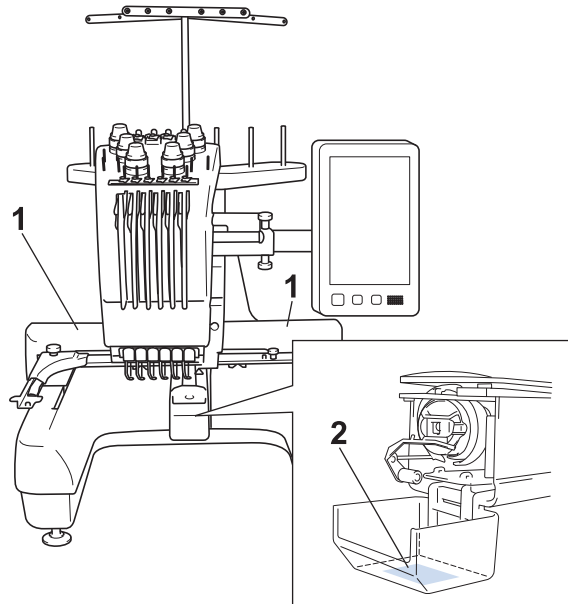

Machine Structure and Features

Six-needle machine embroidering

Your machine has six needles, each threaded with a different color of thread. It can sew embroidery patterns that contain several colors by automatically selecting the appropriate needle for each color.

The mechanism that moves the needles up and down is called the needle bar, and the needle bars are in the needle bar case. The needle bars are named from right to left: needle bar 1, needle bar 2, needle bar 3, needle bar 4, needle bar 5 and needle bar 6.

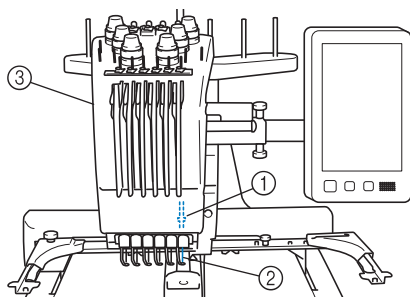

- ① Needle bar 1
- ② Needle 1
- ③ Needle bar case

The machine automatically assigns a thread color to each needle. There are two methods for assigning the thread colors. With the automatic method (default method when the machine is purchased), needles that are already threaded with a color that will be used in the next pattern are assigned to the same thread color based on the needle bar assignments from the previous pattern in order to reduce the number of thread spool changes.

For more professional embroidering, using a manual color sequence allows the needle bar assignments to easily be specified manually. Thread color and needle bar combinations can be selected manually to create a menu so that the needle bar assignments can be based on the thread color numbers. (Refer to "Selecting/Managing Thread Colors for Each Needle Bar (Manual Color Sequence)" on page 108.)



Memo

- Sewing is not necessarily performed in the order of the needle bar numbers.

The thread colors assigned to the needle bars are listed on the screen. Thread the needle bars as indicated.

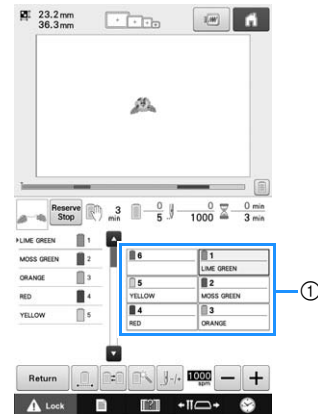

- ① The threads threaded on the needle bars are indicated as shown here.

The spool pins, thread tension knobs, thread take-up levers and thread paths, mentioned when threading the upper thread, are different according to their corresponding needle bar number.

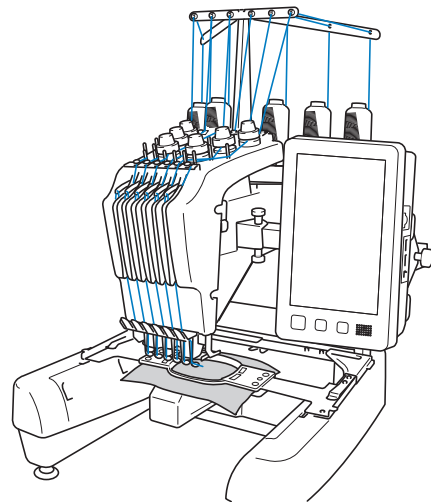

Not all six needles can be used to sew at the same time. Only one needle is moved to the embroidering position at a time. According to the sewing order, the needle bar case is moved to the left and right so that the needle bar and needle thread with the required color can be moved to the embroidering position.

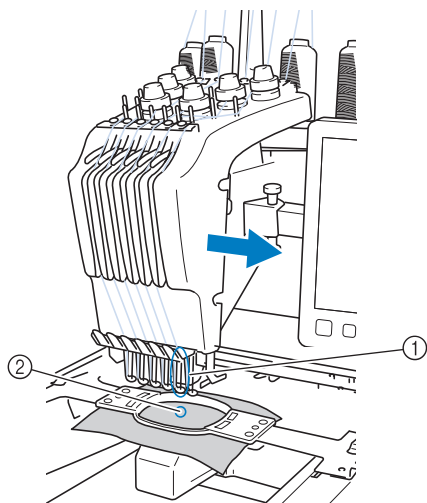

- ① Needle at the embroidering position
The needle is positioned over the hole in the needle plate ②.

When starting the machine, the presser foot is automatically lowered. The embroidery is sewn and thread is pulled away from the material when thread trimming and when changing thread colors (moving to the different needles to be sewn within the embroidery). When sewing is finished, the machine stops. If the pattern uses seven or more thread colors, the machine will stop when it is necessary for the thread spools to be changed, and the corresponding instructions appear on the LCD.

(However, when “Manual Color Sequence” is set to “ON”, the machine does not automatically stop when a thread spool must be changed. For details, refer to “Selecting/Managing Thread Colors for Each Needle Bar (Manual Color Sequence)” on page 108.)

Differences from single-needle machines

■ Can sew embroidery patterns using six or less colors without the need to replace the thread spools

With single-needle machines, the thread spool must be changed and the machine must be threaded each time a different thread color is used. With this machine, it is not necessary to change the thread spool or rethread the machine with embroidery patterns containing six or less colors. If total colors are less than six colors, and if total color change is more than seven times, machine will come back to the needle that the machine is already used and sew the same color again automatically.

■ Automatic sewing reduces sewing time

Except to change the thread spools with patterns containing seven or more colors, once the machine is started, it continues to operate automatically, from lowering the presser foot to performing the specified operations at the starting and end positions in addition to changing the thread colors. Since the machine can change threads and finish stitching, sewing time is reduced.

■ Automatically pulls and holds the thread tails to the under side of fabric at the beginning and end of stitching

Since the machine automatically pulls the upper thread under the fabric at the beginning of a color, and pulls the upper thread from the fabric at the time of thread trimming, you don't need to deal with the upper thread tail at all.

■ Automatically moves the embroidery frame to the embroidering position

With a single-needle machine, in most cases, the embroidery pattern is centered in the frame and the fabric must be correctly positioned within the embroidery frame with the center of the desired embroidering position aligned with the center of the embroidery frame. However, with 6 needle embroidery machine, the embroidery frame is moved to determine the embroidering position, making it easier to sew the pattern at any place in the frame. In addition, the embroidering position can be freely determined manually after the fabric is hooped and the embroidery frame is attached to the machine, regardless of how the fabric is positioned in the embroidery frame.

Other features

Large 10.1-inch LCD screen

The machine is equipped with a large 10.1-inch LCD screen, the same as on many tablets. The colors of an embroidery pattern can be previewed in a nearly realistic image. In addition, since the LCD is a touch panel, the keys that are displayed can be touched to easily perform operations.

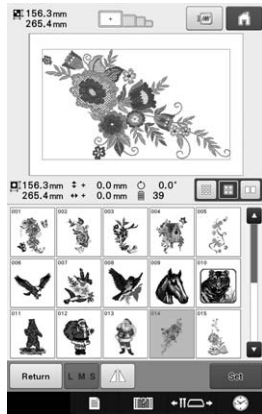

Link function – for your embroidery business –

You can send embroidery patterns edited in embroidery editing software provided with the Link function, such as PE-DESIGN NEXT /10 or later, from a computer to an embroidery machine. You can connect up to 4 machines to a single computer at a same time. (Refer to “Sending Embroidery Patterns From a Computer to the Machine (Link Function)” on page 142.)

Embroider while replacing the thread spool a minimal number of times

Before starting to embroider, touch the thread color sorting key () to rearrange the embroidery order and sort it by thread colors. For example, when embroidering after simply arranging the same pattern to be repeated side-by-side, you will need to replace the thread spool multiple times with each pattern. However, by using the thread color sorting function, the thread color order will be rearranged allowing you to embroider the same color at one time, while replacing the thread spool a minimal number of times.

The thread color sorting function cannot be used with overlapping patterns.



More user friendly pattern editing

Pattern editing, such as changing all parts with the same thread color to a different color or adding characters while entering text, has become more user friendly.

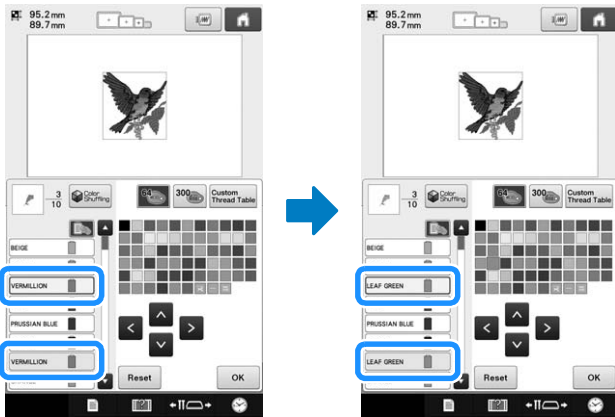

Embroidering progress bar

Since numbers for the time and stitches do not always provide the clearest image of the remaining embroidery time, the new embroidering progress bar shows the progress of the entire embroidery at a glance.



Deselect region function

Since you can specify a part of the embroidery pattern or a specific color not to be sewn, you can arrange the sewn embroidery without editing the pattern.

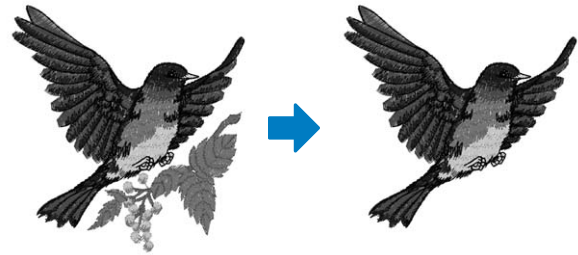

Safety mechanism

The machine is equipped with a locking mechanism that helps prevent injuries from accidental operation. The machine can only be started after the machine is unlocked. The color of the start/stop button changes to inform you of whether or not the machine is locked.

Lit in red

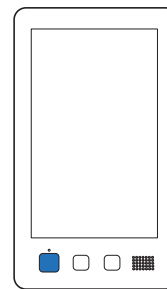

The machine is locked.

Flashing in green

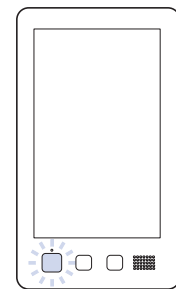

The machine can be started.

Wide selection of built-in thread color information

The thread color information for manufacturers' threads is available, making it easy to choose the appropriate thread color.

▶ 1848 Madeira Poly	1	▶ 1049 Madeira Rayon	1
1770 Madeira Poly	2	1369 Madeira Rayon	2
1986 Madeira Poly	3	1081 Madeira Rayon	3
1637 Madeira Poly	4	1037 Madeira Rayon	4
▶ 1177 Sulky	1	▶ 5622 R-A Poly	1
1176 Sulky	2	9091 R-A Poly	2
1511 Sulky	3	5561 R-A Poly	3
1037 Sulky	4	5678 R-A Poly	4

■ Expanded thread color display feature enables colors to be displayed as realistic true color

The colors and thread color numbers are stored in the machine's memory. From this thread color library, you can select colors to create your own color thread table. If the pattern colors are changed using this table, the pattern can be displayed with only the thread colors that you have. In addition, the embroidery pattern can be displayed as it would appear after it is embroidered.

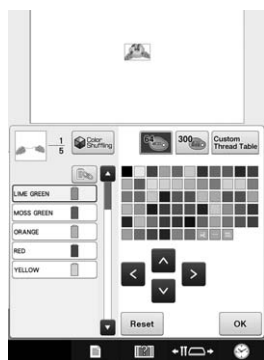

■ Automatic needle-threading mechanism

Using the automatic needle-threading mechanism, threads each needle easily. In addition, you can specify that automatic needle threading be canceled for specific needle bars.

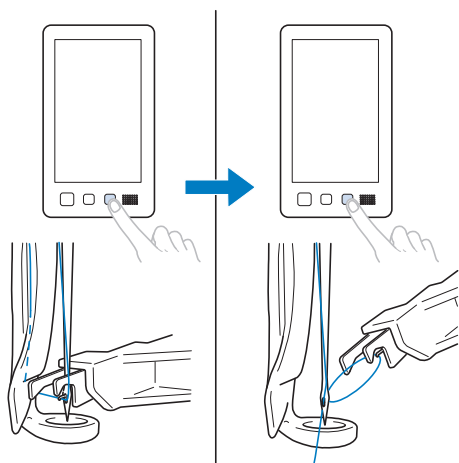

■ USB port/SD card slot available as standard equipment

By connecting a computer to the machine using the included USB cable, embroidery patterns can be transferred to/from the computer. (Refer to "Saving embroidery patterns in the computer" on page 136.)

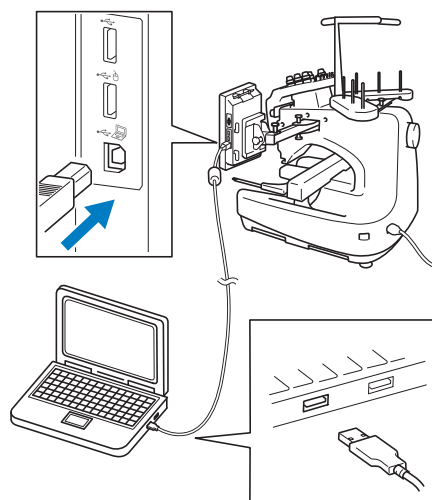

If the machine is positioned at a distance that prevents the USB cable from reaching the computer, embroidery patterns can be transferred from the computer by temporarily saving them on USB media or an SD card, which is then inserted into the machine. (Refer to "Saving embroidery patterns to USB media/SD card" on page 135.)

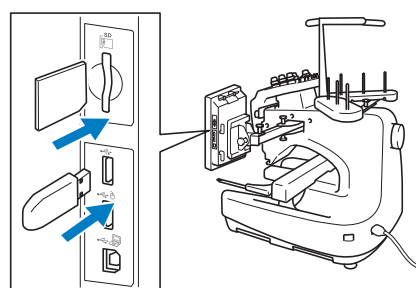

■ Moving or threading a selected needle bar at any time

When selecting, editing or embroidering a pattern, any one of the needle bars can be selected at any time to be threaded or moved to the embroidering position.

Touch  to open the needle move screen, then select the needle bar number that you want to move or thread. (Refer to "Moving and threading a selected needle bar" on page 55.)

Available features

Designs with a maximum size of 200 mm (H) × 300 mm (W) (7-7/8 inches (H) × 11-3/4 inches (W)) can be embroidered.

■ Manual color sequence - More professional use of this machine

If you specify the thread colors used with this machine, or if you use DST files frequently, it would be convenient to use the manual color sequence. (Refer to “Selecting/Managing Thread Colors for Each Needle Bar (Manual Color Sequence)” on page 108.)

■ Various built-in patterns

Many built-in character patterns, embroidery patterns and frame patterns enable you to start embroidering right after purchasing this machine.



■ Embroidery pattern editing

Lettering and embroidery patterns can be combined or a text arrangement can be specified to arrange the patterns.

The machine can also be set to repeatedly sew the same pattern.



Manual Structure

This manual is constructed as described below. Before using the machine, check the procedures described with the numbered titles in chapter 2. This shows the sequence of these basic operations.

Read before use

Chapter 1: Getting Ready

The setup of the embroidery machine and the various preparations required before starting to sew are described in this chapter.

Chapter 2: Embroidering Tutorial

This chapter describes the basic embroidering operations in order—from turning on the machine and sewing a pattern to finishing sewing. Follow the steps of the tutorial to embroider a pattern and master the operation of this embroidery machine.

Chapter 3: Other Basic Procedures

This chapter provides explanations on operations other than those described in chapter 2, such as sewing a pattern with seven or more colors, and other necessary operations, for example, changing the needle.

Read when additional information is required

Chapter 4: Embroidering Settings

This chapter contains descriptions on the various embroidering settings, which make editing patterns simple.

Chapter 5: Selecting/Editing/Saving Patterns

This chapter provides details on selecting, editing and saving embroidery patterns.

Chapter 6: Basic Settings and Help Feature

This chapter contains descriptions on the use of the settings key and the machine operations key. Details on changing the basic embroidery machine settings and viewing operations on the LCD will be provided.

Chapter 7: Appendix

This chapter provides descriptions of techniques for various embroidering operations, pointers for creating beautiful embroidery, and details on maintenance procedures and corrective measures that should be taken when a problem occurs.

Searching for information

■ Searching the manual

By title

Check the descriptions at the left for the contents of each chapter, and then check the table of contents.

By keyword

Search the index at the end of this manual. Look for the desired keyword, and then refer to the page that is indicated.

By screen

Descriptions of the keys and other information that appear in the main LCD screens are provided in the tables on pages 63 to 72. For details, refer to the page that is indicated.

By condition

Various possible conditions and the corresponding operations are described on page 73. For details, refer to the page that is indicated.

■ Searching the machine

This machine is equipped with a help feature.

Learning how to perform an operation

Touch the machine operations guide key, and then check for the desired information. (Refer to “Using the Machine Operations Guide Key” on page 187.)

Contents

Introduction	1
IMPORTANT SAFETY INSTRUCTIONS	1
License Agreement	5
Warning Labels	6
Machine Structure and Features	7
Six-needle machine embroidering	7
Differences from single-needle machines	8
Other features.....	9
Available features	12
Manual Structure	13
Read before use.....	13
Read when additional information is required	13
Searching for information	13
Chapter1 GETTING READY	17
Names of Machine Parts and Their Functions	17
Front view	17
Right-side/rear view.....	18
Operation panel	18
Accessories	19
Included accessories.....	19
Accessories that are included in some countries or regions	20
Optional Accessories	21
Setting Up the Machine	23
Setup and transporting precautions.....	23
Setup location	23
Setting up the machine.....	24
Adjusting the operation panel position	25
Preparing the thread guide assembly	26
Positioning the spool stand.....	27
Attaching the embroidery frame holder	28
Chapter2 EMBROIDERING TUTORIAL	29
Operating Precautions	29
Power supply precautions.....	29
Needle precautions	30
Checking the needle.....	30
Bobbin precautions	30
Upper thread recommendations	31
Fabric recommendations	31
Display recommendations.....	31
Basic Procedures	32
1. Installing the Bobbin	33
Removing the bobbin case	33
Installing the bobbin.....	33
Installing the bobbin case	34
2. Turning ON the Machine	35
Setting your machine for the first time	36
Understanding the screens.....	36
Screen overview	37
3. Selecting an Embroidery Pattern	38
Selecting an embroidery pattern	39
4. Editing the Embroidery Pattern	40
5. Previewing the Image	41
Checking a preview image	41
6. Hooping the Fabric in the Embroidery Frame	42
Hooping the fabric in the embroidery frame	42
7. Attaching the Embroidery Frame to the Machine	44
Attaching the embroidery frame	45
Continuing to the embroidering settings screen	46
8. Specifying Embroidering Setting	46
9. Checking the Embroidery Area	47
Temporarily stopping to check the area	48
Continuing to the embroidering screen	48
10. Upper Threading	48
Checking the needle bars and thread colors	48
Upper threading	50
Threading the needle.....	54
11. Sewing the Embroidery	57
Starting embroidering	57
Stopping embroidering	59
12. Removing the Embroidery Frame and Fabric	60
Removing the embroidery frame.....	60
Removing the fabric	61
13. Turning OFF the Machine	61
Screen Quick Reference Guide	63
Key displays	63
Understanding the pattern type selection screen.....	64
Understanding the pattern list screen.....	65
Understanding the pattern editing screen.....	66
Understanding the embroidering settings screen.....	68
Understanding the embroidering screen	71
When You Have a Question, This May Help You	73
Technical terms:	73
Patterns:	73
Embroidering:.....	73
Useful external connection functions.....	74
USB mouse operation	76
Chapter3 OTHER BASIC PROCEDURES	79
Changing the Needle	79
Replacing the needle	79
Correctly Using the Embroidery Frames	80
Embroidery frame holders.....	80
When difficult to replace the embroidery frame.....	81
Types of embroidery frames/frame holders and their applications.....	82
Attaching Iron-On Stabilizer (Backing) to Fabric	84
Hooping the Fabric	85
Hooping the fabric in the extra-large and large embroidery frames.....	85
Using the embroidery sheet	86
Large/small pieces of fabric	86
Embroidery Frame Position and Movement	88
Changing the Embroidering Position	89
Adjusting the angle.....	91
Switching the Thread Colors on the Screen	93
Embroidering a Pattern Containing Seven or More Colors	94

Checking if thread spool changes are necessary.....	94	Saving embroidery patterns to USB media/SD card	135
Changing the Thread Spools with Designs of Seven or More Colors	95	Saving embroidery patterns in the computer	136
Change thread spools message	95	Retrieving patterns from the machine's memory.....	137
Easily changing the thread spools	96	Recalling from USB media/SD card.....	138
If the Thread Breaks or the Bobbin Thread Runs Out While Embroidering.....	97	Recalling from the computer.....	139
If the upper thread breaks	97	Saving embroidery patterns from any memory source to another memory	141
If the bobbin thread breaks or runs out	98	Sending Embroidery Patterns From a Computer to the Machine (Link Function)	142
Embroidering From the Beginning or Middle of the Pattern.....	99	Operations available with the Link function	142
Resume Embroidering After Turning Off the Machine.....	101	Embroidering using the Link function.....	143
Adjusting the Thread Tension of both the Bobbin and Upper Thread	102	Disabling the Link function	145
Adjusting the tension of the bobbin thread.....	102	Editing the Embroidery Pattern (Pattern Editing Screen)	146
Adjusting the tension of the upper thread.....	103	Enlarge the pattern image on the screen.....	146
Chapter4 EMBROIDERING SETTINGS 105		Combining patterns.....	146
Basting Embroidery.....	105	Selecting the pattern to be edited	147
Creating an Appliqué Piece.....	106	Grouping multiple selected patterns.....	148
Creating an appliqué piece	106	Moving a pattern.....	148
Selecting/Managing Thread Colors for Each Needle Bar (Manual Color Sequence).....	108	Flipping a pattern horizontally	149
Convenience of the manual color sequence	108	Changing the size of a pattern (Normal resizing mode)	150
Specifying the manual color sequence	109	Changing the pattern size while maintaining the desired thread density (stitch recalculator).....	151
Using the manual color sequence	109	Rotating a pattern.....	152
Precautions on the manual color sequence.....	110	Changing the text arrangement of a character	153
Deselect Region Setting	110	Changing the character spacing	153
Specifying sewing of a specific thread color to be skipped.....	110	Separating combined character patterns.....	154
Cancelling the deselect region setting	111	Trimming the threads between characters	155
Automatic Lock Stitch Setting.....	112	Combining the separated character patterns.....	155
Starting/Ending Position Settings	113	Specifying multi-color text	156
Repeatedly sewing a pattern along a diagonal	114	Changing the character font	156
Embroidering linked characters.....	115	Changing the font and size of individual characters	156
Maximum Sewing Speed Setting	116	Changing the thread density (only for selected character and frame patterns)	157
Setting the Machine to Stop at Color Changes	117	Changing the colors of the pattern	157
Stopping the machine at the next color change.....	117	Find new color schemes with the color shuffling function	159
Specifying pause locations before embroidering	118	Thread color sorting.....	162
Temporary Needle Bar Setting.....	119	Designing repeated patterns.....	162
Uninterrupted embroidering (monochrome).....	119	Creating a custom thread table.....	167
Reserved Needle Bar and Sewing Speed Settings	120	Choosing a color from the custom thread table	169
		Saving and recalling the custom thread table using USB media	170
		Duplicating a pattern	171
		Deleting a pattern	171
		Editing the Embroidery Pattern (Embroidering Settings Screen).....	172
		Rotating the entire pattern.....	172
		Editing a Combined Pattern	173
Chapter5 SELECTING/EDITING/SAVING PATTERNS 123		Chapter6 BASIC SETTINGS AND HELP FEATURE 177	
Using the Memory Function	123	Using the Settings Key	177
Embroidery data precautions	123	Understanding the settings screen	177
Concerning USB media	124	Changing the display guides	180
Selecting an Embroidery Pattern.....	124	Changing the thread color information.....	182
General pattern selection	124	Selecting the thread color information for "PES" format data	183
Embroidery patterns.....	125	Changing the background colors of the embroidery patterns or thumbnails	183
Frame patterns	126		
Utility embroidery patterns/Large buttonhole patterns.....	127		
Monogram and frame designs.....	127		
Alphabet patterns.....	130		
Decorative alphabet patterns	133		
Saving embroidery patterns in the machine's memory	135		

Specifying jumpstitch trimming / "DST" jump codes for trimming	184
Deleting short stitches	184
Specifying the remaining length of thread.....	185
Selecting the "Eco Mode" or "Shutoff Support Mode"	185
Changing the screen saver settings.....	186
Using the Machine Operations Guide	
Key	187
Viewing the operation guides	187
Playing a tutorial video.....	189
Playing MPEG-4 (MP4) videos	190
Chapter7 APPENDIX	191
Appliqué Sewing.....	191
Sewing appliqué patterns.....	191
Using a frame pattern to create appliqués (1).....	192
Using a frame pattern to create appliqués (2).....	193
Sewing Large-size (Split) Embroidery	
Patterns	195
Helpful Tips for the Operation of the Machine	197
Checking the thread tension of built-in patterns.....	197
Sewing a pattern aligned with a mark on the fabric.....	199
Color thread table.....	200
Colors of Tajima (.dst) embroidery data	200
Creating Beautiful Embroidery	201
Threads	201
Stabilizers (backing).....	202
Hooping techniques	203
Fabric/stabilizer compatibility chart.....	204
Using the Optional Bobbin Winder	205
Precautions.....	205
Optional bobbin winder and its accessories	205
Setting up the optional bobbin winder.....	206
Connecting the AC adapter.....	206
Winding the bobbin	207
Maintenance.....	210
Cleaning the LCD	210
Cleaning the machine surface.....	210
Cleaning the hook	210
Cleaning around the needle plate	211
Cleaning the bobbin case	212
Cleaning the thread paths of the upper threads.....	213
Oiling the machine.....	214
About the maintenance message	216
Troubleshooting	216
On-screen troubleshooting	216
Troubleshooting	217
Error messages.....	223
If the machine does not respond when a key is pressed.....	230
Specifications	231
Embroidery machine specifications	231
Upgrading Your Machine's Software.....	231
Upgrade procedure	231
Index	233

Chapter 1 GETTING READY

After unpacking the machine, first refer to “Accessories” on page 19, and check that all listed accessories are included. After checking that all accessories are included, the embroidery machine can be set up. The setup of the machine and the various preparations required before starting to sew are described in this chapter.

Names of Machine Parts and Their Functions

The names of the various parts of the sewing machine and their functions are described below. Before using the sewing machine, carefully read these descriptions to learn the names of the machine parts.

Front view

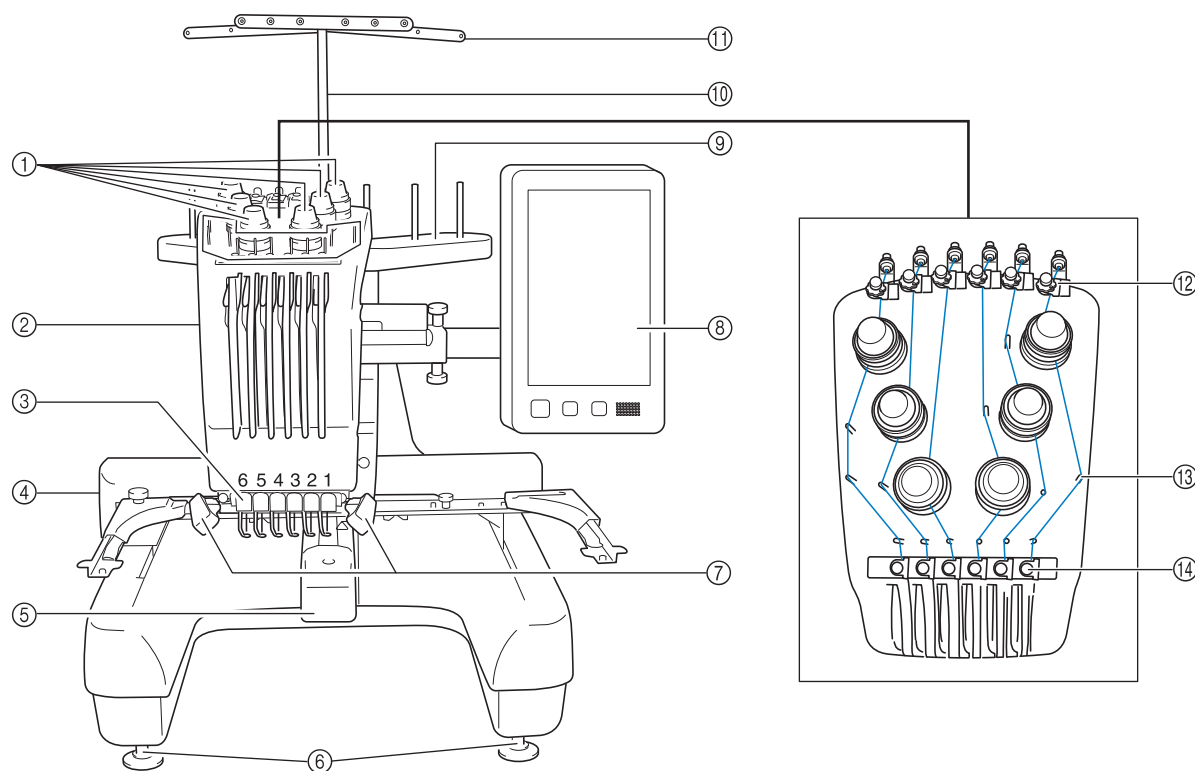

- ① **Thread tension knobs**
Adjust the tension of the thread.
- ② **Needle bar case**
Moves to the left and right to move the needle to the embroidering position.
- ③ **Lower thread guide**
- ④ **Carriage**
Attach the embroidery frame to the carriage. When the machine is turned on or when the machine is embroidering, the carriage moves forward, backward, left and right.
- ⑤ **Hook cover/Hook**
Open the hook cover, and then insert the bobbin case into the hook.
- ⑥ **Feet**
Use the feet to adjust the height of the legs.
- ⑦ **Sewing light**
The brightness of the sewing light can be adjusted in the settings screen. Refer to page 178.
- ⑧ **Operation panel**
- ⑨ **Spool stand**
Put 6 thread spools to embroider.
- ⑩ **Thread guide assembly support**
- ⑪ **Thread guide**
- ⑫ **Upper thread guide pretension knob**
- ⑬ **Thread guide pins**
- ⑭ **Middle thread guide**

Right-side/rear view

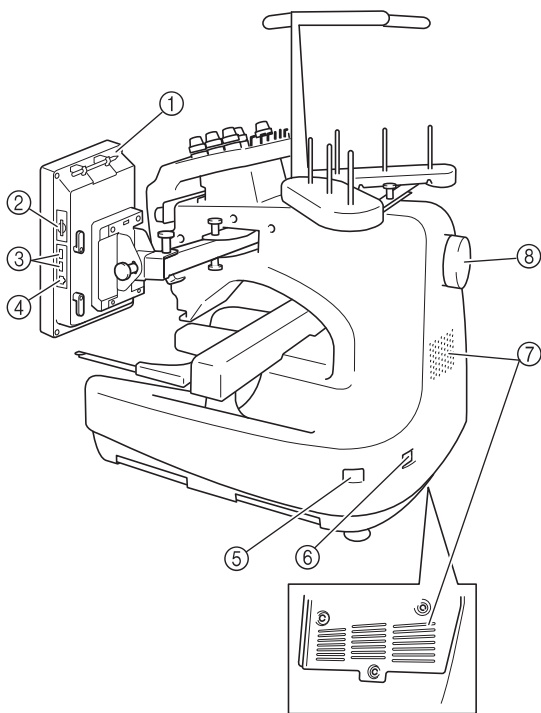

Bottom

- ① **Touch pen holder**
Use the touch pen holder to hold the touch pen when not in use.
- ② **SD card slot**
Insert an SD card into the SD card slot in order to import/export embroidery pattern data.
- ③ **USB port for media**
In order to send patterns from/to USB media, plug the USB media directly into the USB port.
- ④ **USB port for computer**
In order to import/export patterns between a computer and the machine, plug the USB cable into the USB port.
- ⑤ **Main power switch**
Use the main power switch to turn the machine ON (I) and OFF (O).
Do not turn the power on soon after turning the power off. It is recommended that you wait 5 seconds before turning the power back on.
- ⑥ **Power supply plug**
Insert the plug on the power supply cord into the power supply plug.
- ⑦ **Ventilation slots**
- ⑧ **Handwheel**
Rotate the handwheel to move the needle up and down. Be sure to rotate the handwheel toward the LCD panel (counterclockwise).

Operation panel

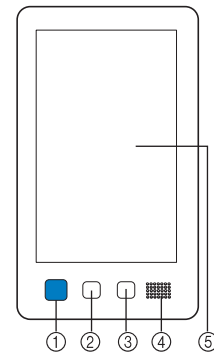

- ① **Start/Stop button**
Press the start/stop button to start or stop the machine. The lighting status and color of the button changes depending on the operation condition of the machine.









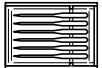

Lit in red	:	When the machine cannot start sewing
Flashing in green	:	When the machine can start sewing
Lit in green	:	While the machine is sewing
Flashing in orange	:	When the machine can cut the thread
Off	:	When the machine is turned off
- ② **Thread trimming button**
Press the thread trimming button to trim both the upper and the bobbin threads.
- ③ **Automatic needle-threading button**
Press the automatic needle threading button to thread the needle.
- ④ **Speaker**
- ⑤ **LCD (touch panel)**
Touch the keys that appear on the touch panel to select and edit patterns and confirm various information.















Accessories

The accessories listed below are included with this machine. Make sure to use the accessories designed for this machine.

Included accessories

After opening the box, check that the following accessories are included. If any item is missing or damaged, contact your authorized Brother dealer.

	Part Name
	Part Code
1. 	Accessory case
	XC6482-051
2. 	Needle set × 2
	XC6469-001
3. 	Prewound bobbin × 6
	XC6368-051
4. 	Spool net × 6
	S34455-000
5. 	Seam ripper
	XF4967-001
6. 	Scissors
	XF2052-001
7. 	Tweezers
	XC6542-051
8. 	Touch pen
	XA9940-051
9. 	Needle changing tool (Threader)
	XF2212-001
10. 	Needle plate spacer
	XC6499-151
11. 	Spacer (on machine)
	XF1978-001

	Part Name
	Part Code
12. 	Phillips screwdriver
	XC6543-051
13. 	Standard screwdriver
	X55468-051
14. 	Allen screwdriver
	XC5159-051
15. 	Offset screwdriver
	XC6545-051
16. 	Disc-shaped screwdriver
	XC1074-051
17. 	Wrench 13 mm × 10 mm
	XC6159-051
18. 	Oiler
	XZ0206-051 XG3677-001 (for Europe and Turkey)
19. 	Cleaning brush
	X59476-051
20. 	Weight (L)
	XC5974-151
21. 	Spool mat × 6
	XC7134-051
22. 	Spool cap × 6
	130012-054
23. 	USB cable
	XD1851-051
24. 	Embroidery frame (extra-large) 200 mm (H) × 300 mm (W) (7-7/8 inches (H) × 11-3/4 inches (W))
	PRH300 (Americas) PRH300: XC6284-052 (Other area)
25. 	Embroidery frame (large) 130 mm (H) × 180 mm (W) (5-1/8 inches (H) × 7-1/8 inches (W))
	PRH180 (Americas) PRH180: XC6285-052 (Other area)

	Part Name
	Part Code
26.	Embroidery frame (medium) 100 mm (H) × 100 mm (W) (4 inches (H) × 4 inches (W))
	PRH100 (Americas) PRH100: XC6286-052 (Other area)
27.	Embroidery frame (small) 40 mm (H) × 60 mm (W) (1-1/2 inches (H) × 2-3/8 inches (W))
	PRH60 (Americas) PRH60: XC6287-052 (Other area)
28.	Embroidery sheet (extra-large) 200 mm (H) × 300 mm (W) (7-7/8 inches (H) × 11-3/4 inches (W))
	XC5704-051
29.	Embroidery sheet (large) 130 mm (H) × 180 mm (W) (5-1/8 inches (H) × 7-1/8 inches (W))
	XC5721-051
30.	Embroidery sheet (medium) 100 mm (H) × 100 mm (W) (4 inches (H) × 4 inches (W))
	XC5759-051
31.	Embroidery sheet (small) 40 mm (H) × 60 mm (W) (1-1/2 inches (H) × 2-3/8 inches (W))
	XC5761-051
32.	Embroidery frame holder A (with white corner cover)
	XF2222-001
33.	Embroidery frame holder B (with light gray corner cover)
	XF2223-001
34.	Operation Manual
	This manual
35.	Quick reference guide
	XG8272-001
36.	Embroidery Design Guide
	XG8276-001
37.	Power cord
	Visit your authorized Brother dealer.
38.	Bobbin case (on machine)
	XC7206-001

⚠ CAUTION

- Be sure to use the included power cord for this machine. Using any other power cord may result in damage.

Memo



- The included touch pen can be stored in the touch pen holder on the back of the operation panel. Refer to page 18.





Accessories that are included in some countries or regions

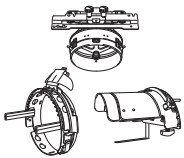
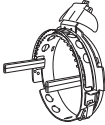
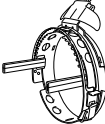
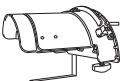
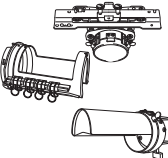
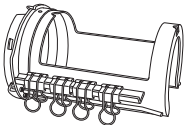
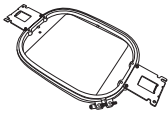
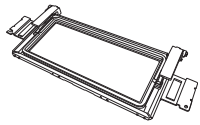



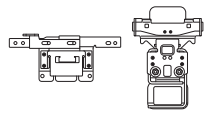
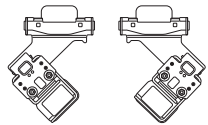
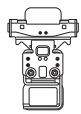
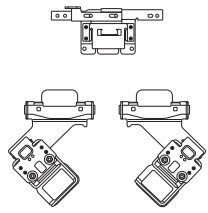
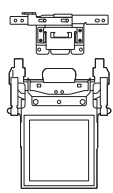

	Part Name
	Part Code
1.	Embroidery Design Guide
	XG8278-001
2.	Bobbin winder set (Refer to page 205.)
	PRBW1

Optional Accessories

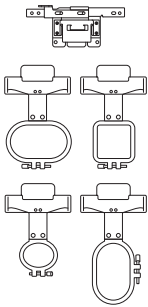
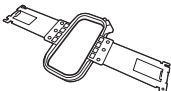
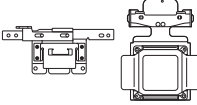
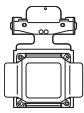
The following are available as optional accessories to be purchased separately.

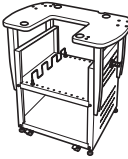
	Part Name
	Part Code
1.	 Advanced cap frame 2 set PRCF3 (Americas) PRCF3: XE2158-201 (Other area)
2.	 Advanced cap frame 2 60 mm (H) × 130 mm (W) (2-3/8 inches (H) × 5-1/8 inches (W)) PRCFH3 (Americas) PRCFH3: XE2162-001 (Other area)
3.	 Advanced cap frame 50 mm (H) × 130 mm (W) (2 inches (H) × 5-1/8 inches (W)) PRCFH2 (Americas) PRCFH2: XC7610-052 (Other area)
4.	 Mounting jig PRCFJ2 (Americas) PRCFJ2: XC7611-052 (Other area)
5.	 Cylinder frame set PRCL1 (Americas) PRCL1: XE2166-001 (Other area)
6.	 Cylinder frame 80 mm (H) × 90 mm (W) (3 inches (H) × 3-1/2 inches (W)) PRCLH1 (Americas) PRCLH1: XE2170-001 (Other area)
7.	 Quilt frame 200 mm × 200 mm (7-7/8 inches × 7-7/8 inches) PRPQF200 (Americas) PRPQF200: XE8411-001 (Other area)
8.	 Border frame 100 mm (H) × 300 mm (W) (4 inches (H) × 11-3/4 inches (W)) PRPBF1 (Americas) PRPBF1: XE8414-001 (Other area)
9.	 Round frame set PRPRFK1 (Americas) PRPRFK1: XE8402-001 (Other area)

	Part Name
	Part Code
10.	 Round frame (Ø100 mm (4 inches)) PRPRF100 (Americas) PRPRF100: XE8427-001 (Other area)
11.	 Round frame (Ø130 mm (5 inches)) PRPRF130 (Americas) PRPRF130: XE8430-001 (Other area)
12.	 Round frame (Ø160 mm (6 inches)) PRPRF160 (Americas) PRPRF160: XE8433-001 (Other area)
13.	 Embroidery frame holder C (with dark gray corner covers) PRPARMC (Americas) PRPARMC: XE8436-001 (Other area)
14.	 Flat frame 200 mm (H) × 300 mm (W) (7-7/8 inches (H) × 11-3/4 inches (W)) PRF300 (Americas) PRF300: XE2086-001 (Other area)
15.	 Clamp frame S straight set 24 mm (H) × 45 mm (W) (7/8 inch (H) × 1-3/4 inches (W)) PRCLP45B (Americas) PRCLP45B: XF2251-001 (Europe) PRCLP45B: XF2252-001 (Other area)
16.	 Clamp frames S L & R 24 mm (H) × 45 mm (W) (7/8 inch (H) × 1-3/4 inches (W)) PRCLP45LR (Americas) PRCLP45LR: XF2255-001 (Europe) PRCLP45LR: XF2256-001 (Other area)
17.	 Clamp frame S straight 24 mm (H) × 45 mm (W) (7/8 inch (H) × 1-3/4 inches (W)) PRCLP45S (Americas) PRCLP45S: XF2269-001 (Europe) PRCLP45S: XF2268-001 (Other area)
18.	 Clamp frames S L & R set 24 mm (H) × 45 mm (W) (7/8 inch (H) × 1-3/4 inches (W)) PRCLP45LRD (Americas) PRCLP45LRD: XF2270-001 (Europe) PRCLP45LRD: XF2272-001 (Other area)
19.	 Clamp frame M set 100mm (H) × 100 mm (W) (4 inches (H) × 4 inches (W)) PRCLPM1 (Americas) PRCLP100B: 115D02E000B (Europe) PRCLPM1AP: 115D02E700B (Other area)

	Part Name
	Part Code
20.	 <p>Compact frame set 70: 41 mm (H) x 70 mm (W) (1-5/8 inches (H) x 2-3/4 inches (W)) 50: 50 mm (H) x 50 mm (W) (2 inches (H) x 2 inches (W)) 44: 38 mm (H) x 44 mm (W) (1-1/2 inches (H) x 1-3/4 inches (W)) Portrait orientation: 33 mm (H) x 75 mm (W) (1-5/16 inches (H) x 2-15/16 inches (W))</p> <p>PRHCK1 (Americas) PRSFK1: 115D02E000A (Europe) PRHCK1AP: 115D02E700A (Other area)</p>
21.	 <p>Sleeve frame 200 mm (H) x 70 mm (W) (7-7/8 inches (H) x 2-3/4 inches (W))</p> <p>PRHSL200 (Americas) PRHSL200: 115D02E000C (Europe) PRHSL200AP: 115D02E700C (Other area)</p>
22.	 <p>Magnetic frame set 50 mm (H) x 50 mm (W) (2 inches (H) x 2 inches (W))</p> <p>PRMHA50 (Americas) PRMFA50: 115D02E000E (Europe) PRMFA50AP: 115D02E700E (Other area)</p>
23.	 <p>Magnetic frame 50 mm (H) x 50 mm (W) (2 inches (H) x 2 inches (W))</p> <p>PRMH50 (Americas) PRMF50: 115D02E000F (Europe) PRMF50AP: 115D02E700F (Other area)</p>
24.	 <p>Embroidery Table</p> <p>PRWT1 (Americas) PRWT1: XE8417-001 (Other area)</p>
25.	 <p>Embroidery Stand</p> <p>PRNSTD2 (Americas) VRPRNSTD: 115Z05E0005 (Europe) VRPRNSTD: 115Z05E7005 (Other area)</p>
26.	 <p>Metal bobbin</p> <p>100376-051</p>
27.	 <p>Weight (S)</p> <p>XC6631-051</p>
28.	 <p>USB mouse</p> <p>XE5334-101</p>



Memo

- Always use accessories recommended for this machine.
- All specifications are correct at the time of printing. Please be aware that some specifications may change without notice.



Note

- Visit your nearest authorized Brother dealer for a complete listing of optional accessories for your machine.

Setting Up the Machine

The procedures for setting up the machine are described below. If the machine is not set up correctly, it may shake or produce loud noises and the embroidery will not be sewn correctly. An optional embroidery stand is also available.

Setup and transporting precautions

⚠ CAUTION

- The temperature of the operating environment should be between 5 °C (40 °F) and 40 °C (104 °F). If the machine is operated in an environment that is either too cold or too hot, the machine may malfunction.
- Do not use the machine in a location where it will be exposed to direct sunlight, otherwise the machine may malfunction.
- Set up the machine with its four adjustable feet completely in contact with the desk or table, so that the machine is level.
- Do not block the ventilation slots at the back and on the rear underside of the machine by such as putting anything under the embroidery machine, and do not allow lint or dust to accumulate in the ventilation slots, otherwise the machine's motor may overheat, resulting in a fire or in damage to the machine.
- The machine weight is approximately 38 kg (84 lb). The transporting or setting up of the embroidery machine should be performed by two people.
- When transporting the machine, be sure to have two people lift the machine from the bottom at the indicated slots (①). Lifting the machine from any other area may damage the machine or result in the machine falling, which could cause injuries.

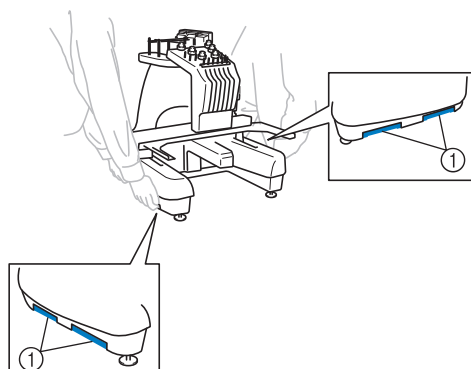

- When lightning occurs, turn off the machine and unplug the power supply cord. Lightning may cause the machine to malfunction.
- Do not plug in the power supply cord until setup of the machine is completed, otherwise injuries may result if the start/stop button is accidentally pressed and the machine starts sewing.
- When lubricating the machine, wear protective eyeglasses and gloves to prevent the oil or grease from getting into your eyes or on your skin. Do not put the oil or grease into your mouth. Keep the oil and grease out of the reach of children.
- While attaching or detaching an embroidery frame or other included accessory or while maintaining the machine, be careful not to hit the machine with your body or any other part of it.

Setup location

Set up the machine in a location that meets the following requirements.

- Position the machine a minimum of 50 mm (2 inches) away from the wall
- Allow sufficient space around the machine
- Place no objects within the moving range of the embroidery frame
- Set-up machine near an electrical outlet
- Use a level and stable surface, such as a desk or stand
- Use a surface that can support the weight of the machine (about 38 kg (84 lb))
- Allow open space around the ventilation slots at the back and on the rear underside of the machine

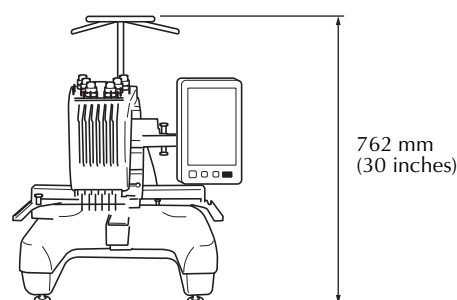

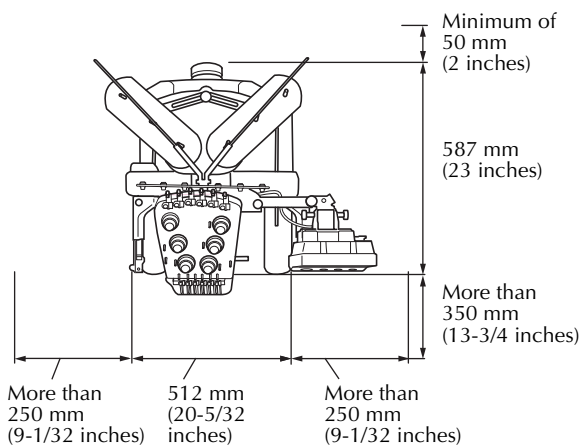

⚠ CAUTION

- In order to prevent malfunctions or damage, do not set up the machine in a location exposed to the following conditions.
 - Insufficient space
 - Liquids, such as water (①)
 - Direct sunlight (②)
 - Objects within the moving range of the embroidery frame (③)
 - Extremely high or extremely low temperatures. The operating environment should be between 5 °C (40 °F) and 40 °C (104 °F). (④)
 - Extreme dust (⑤)
 - Blocked ventilation slots (⑥)
 - An unstable surface (⑦)
 - Connection to extension cords or multiple adapters (⑧)

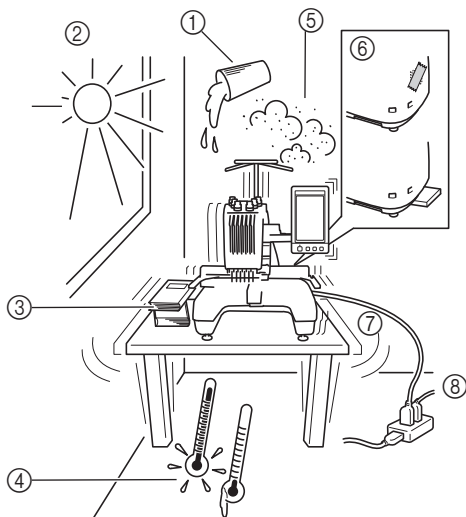

💡 Note

- For your safety: Since the machine weighs approximately 38 kg (84 lb), do not set it up on an unstable table or desk.

Setting up the machine

When setting up the machine, adjust the legs so that the machine is steady.

- 1 Make sure that all packing tape affixed to the machine is peeled off and that all packing material is removed.
- 2 Set up the machine while making sure that there is sufficient space around it.

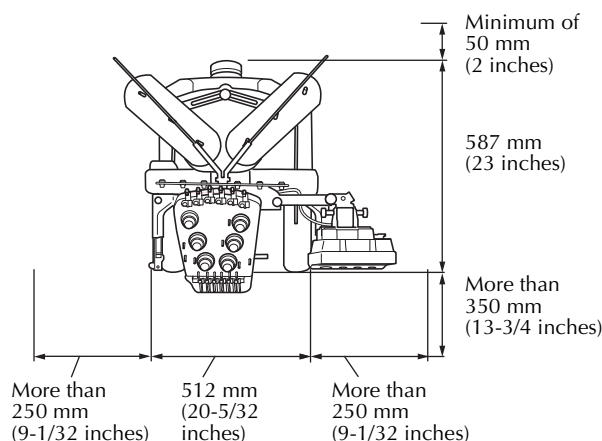

- 3 Adjust the legs so that the machine is steady.

Use the included wrench to loosen the lock nut on the leg that you wish to adjust.

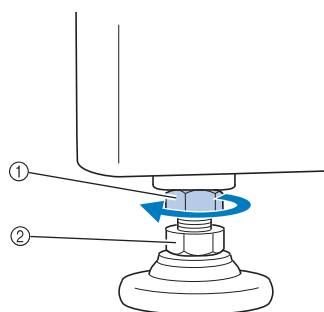

- ① Lock nut
- ② Adjustable foot nut
→ The foot can be turned.

4 Use the included wrench to turn the adjustable foot nut on the foot.

Turning the nut in direction ① lengthens the leg; turning the nut in direction ② shortens the leg.

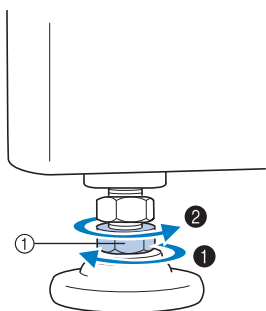

① Adjustable foot nut

- Adjust all four legs so that they securely contact the desk or table, and the machine is level.

5 After adjusting the legs to the desired length, use the included wrench to tighten the nuts.

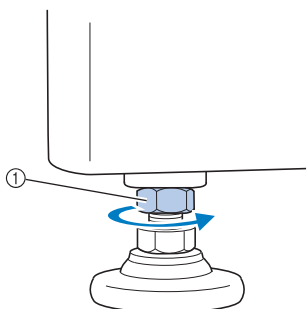

① Lock nut

6 Press down on each corner of the embroidery machine to check that it is stable.

If it is still unstable, perform steps ③ through ⑤ again to adjust the legs.

Adjusting the operation panel position

Adjust the orientation and angle of the operation panel so it can easily be operated.

1 Loosen 2 thumb screws to bring the operation panel forward.

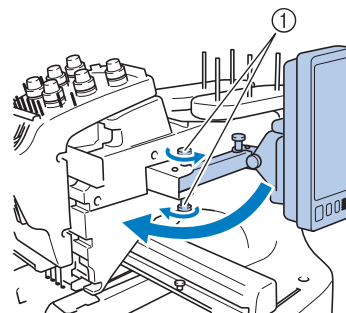

① Thumb screws

2 Adjust the operation panel to an easy-to-operate position, and then tighten the thumb screws.

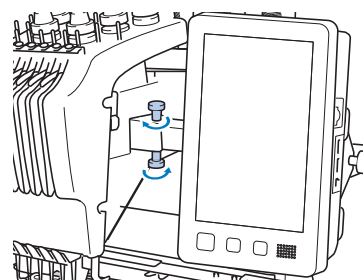

3 Adjust the orientation of the operation panel.

Loosen the thumb screw, adjust the operation panel to an easy-to-view orientation, and then tighten the thumb screw.

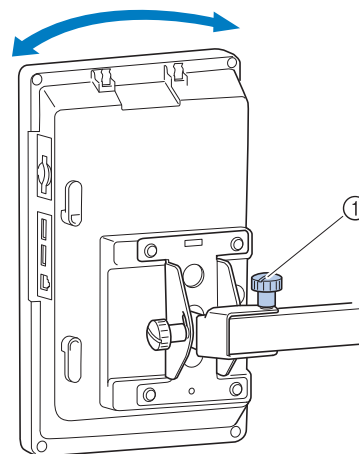

① Thumb screw

4 Adjust the angle of the operation panel.

Loosen the 2 thumb screws behind the operation panel, adjust the operation panel to an easy-to-view angle, and then tighten the thumb screws.

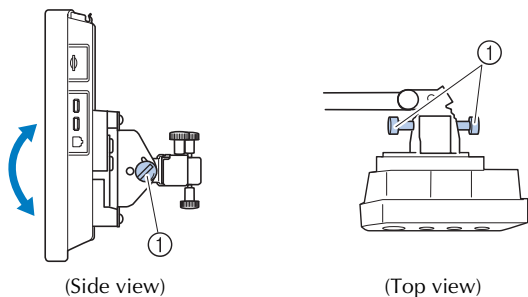

① Thumb screws



Note

- Using the disc-shaped screwdriver included, loosen and firmly tighten the five thumb screws.

Preparing the thread guide assembly

Raise the thread guide assembly. Locate the included Phillips screwdriver.

1 Using the Phillips screwdriver, loosen the screws on the left side of the thread guide assembly support so that the thread guide assembly can be raised.

Remove screw ①, and then turn screw ② three or four times to loosen it.

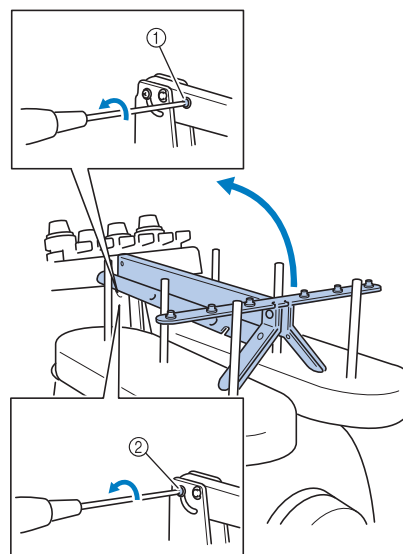

- Remove the screw.
- Turn the screw three or four times to loosen it.

2 Raise thread guide into position and tighten screw ② on the left. Insert screw ① into right side of the thread guide assembly support and tighten.

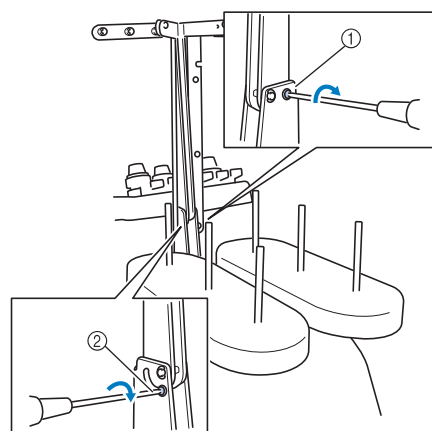

- Insert screw and tighten.
- Tighten screw.

- 3** Using the Phillips screwdriver, loosen the screws on the left and right sides of the thread guide assembly and lift up the thread guide so that it is level.

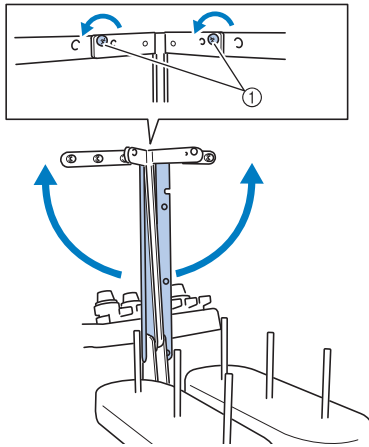

① Loosen screws.

- 4** Tighten the screws on the left and right sides of the thread guide assembly.

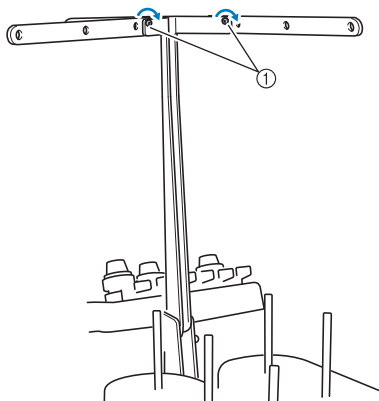

① Tighten screws.



Note

- If the screws are not loosened enough, it may not be easy to move the thread guide assembly support and the thread guide. Do not apply extreme force when moving the thread guide assembly support and the thread guide. Be sure that the screws are loosened well enough before moving these parts.
- Be sure to tighten each screw well enough that the thread guide assembly support and the thread guide are secured.

Positioning the spool stand

Secure the spool stand in the embroidering position. Locate the included disc-shaped screwdriver.

- 1** Loosen the thumb screw, and then open up the spool stand to the left and right.

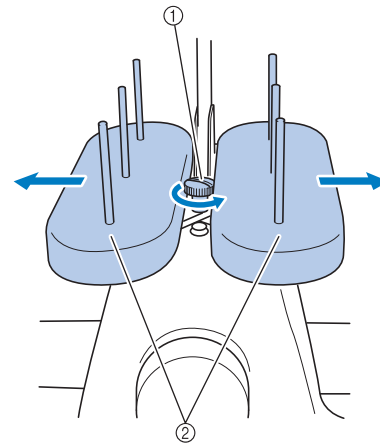

- ① Thumb screw
② Spool stand

- 2** After the spool stand is fully opened up, tighten the thumb screw.

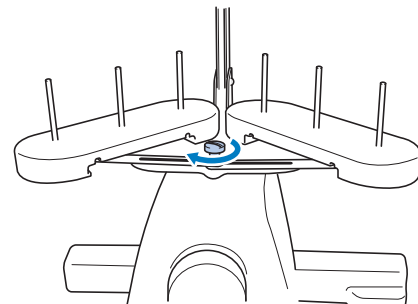

→ Secure the spool stand in the opened position.

Attaching the embroidery frame holder

Attach the embroidery frame holder to the carriage.

- 1 Use the embroidery frame holder appropriate for the embroidery frame that you are using. (Refer to page 82.)
- 2 Remove the two thumb screws of the embroidery frame holder.

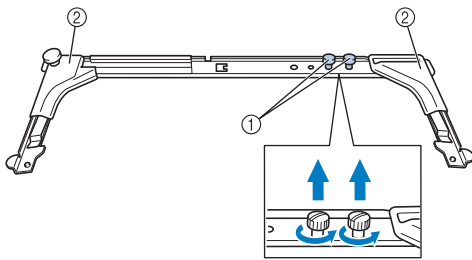

- 1 Thumb screws
- 2 Corner covers

- 3 Align the holes in the embroidery frame holder with the pins on the frame-mounting plate of the carriage.

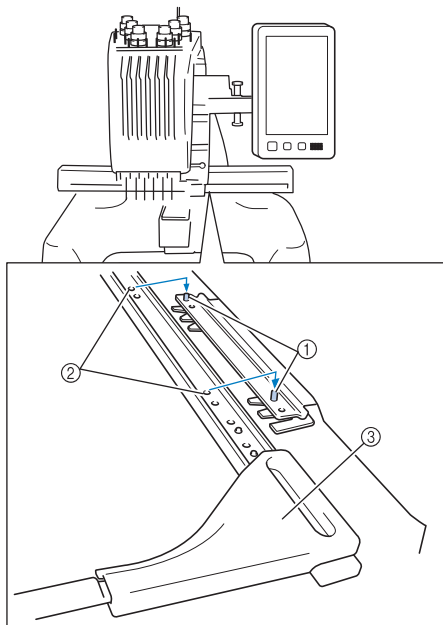

- 1 Pins on the frame-mounting plate
- 2 Holes in the embroidery frame holder
- 3 Corner covers



Memo

- Each embroidery frame holder has different color of corner cover.
 Holder A: White corner covers
 Holder B: Light gray corner covers
 Holder C: Dark gray corner covers (Optional)

- 4 Secure the embroidery frame holder with the two thumb screws removed in step 2.

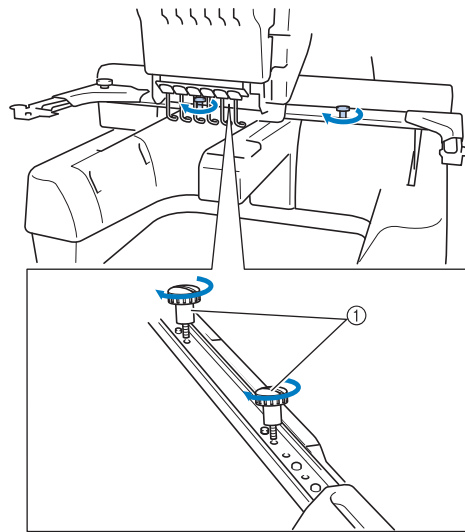

- 1 Thumb screws



Note

- Using the disc-shaped screwdriver included, firmly tighten the thumb screws.
- Two types of embroidery frame holders are included with this machine. Embroidery frame holder A is used with the four included embroidery frames. (Refer to "Correctly Using the Embroidery Frames" on page 80 for the details.)

This completes the preparation of the machine.

This chapter describes the basic embroidering operations in order—from turning on the machine and sewing a pattern to finishing sewing. Follow the steps of the tutorial to embroider a pattern and master the operation of this embroidery machine.

Operating Precautions

The necessary points to ensure the correct operation of this machine are described below.

Power supply precautions

Be sure to observe the following precautions concerning the power supply.

WARNING

- Use only regular household electricity for the power source. Using other power sources may result in fire, electric shock, or damage to the machine.
- Make sure that the plugs on the power supply cord are firmly inserted into the electrical outlet and the power supply cord receptacle on the machine. Otherwise, a fire or electrical shock may result.
- Do not insert the plug on the power supply cord into an electrical outlet that is in poor condition.
- If any of the following occur, turn off the embroidery machine and unplug the power supply cord, otherwise a fire, an electric shock or damage to the machine may result.
 - When you are away from the machine.
 - After using the machine.
 - If a power outage occurs while the machine is being operated.
 - If the machine is not operating properly, for example, when there is a loose or cut connection.
 - During electrical storms.

CAUTION

- Use only the power supply cord included with this machine.
- Do not plug this machine in with extension cords or multi-plug adapters with any other appliances plugged into them, otherwise a fire or an electric shock may result.
- Do not plug in or unplug the power supply cord with wet hands, otherwise an electric shock may result.
- When unplugging the power supply cord, be sure to first turn off the machine, and then grasp the plug when unplugging the cord. Pulling on the cord may damage it or result in a fire or an electric shock.
- Do not allow the power supply cord to be cut, damaged, modified, forcefully bent, pulled, twisted, or bundled. In addition, do not place heavy objects on the cord or expose it to heat, otherwise damage to the cord, fire or an electric shock may result. If the power supply cord or its plug is damaged, stop using the machine, and then take the machine to your authorized Brother dealer for repairs before continuing use.
- If the machine is not to be used for a long period of time, unplug the power supply cord, otherwise a fire may result.
- When leaving the machine unattended, either the main switch of the machine should be turned to OFF or the plug must be removed from the socket-outlet.
- When servicing the machine or when removing covers, the machine must be unplugged.
- For U.S.A only
This appliance has a polarized plug (one blade wider than the other). To reduce the risk of electrical shock, this plug is intended to fit in a polarized outlet only one way. If the plug does not fit fully in the electrical outlet, reverse the plug. If it still does not fit, contact a qualified electrician to install the proper electrical outlet. Do not modify the plug in any way.

Needle precautions

Be sure to observe the following precautions concerning the correct choice of needle for your machine.

⚠ CAUTION

- Your machine is designed to use household embroidery needles. The factory recommended needle is "HAX 130 EBBR" (Organ). Schmetz needles 130/705 H-E may be used as a substitute. Use of any other needles may break the needle or thread or damage the needle-threading mechanism or result in injuries.
- Never use bent needles. Bent needles can easily break, possibly resulting in injuries.

Checking the needle

Sewing with a bent needle is extremely dangerous since the needle may break while the machine is operating.

Place the flat side of the needle on a flat surface and check that the distance between the needle and the flat surface is even. If the needle is bent or the tip of the needle is broken, replace the needle with a new one. (Refer to "Changing the Needle" on page 79.)

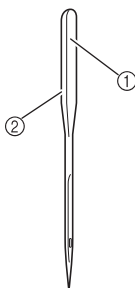

- ① Flat side
- ② Needle type marking

■ Good needle

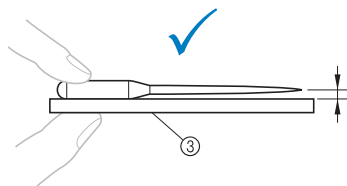

- ③ Flat surface

■ Bad needle

If the distance between the needle and the flat surface is not even, the needle is bent. Do not use a bent needle.

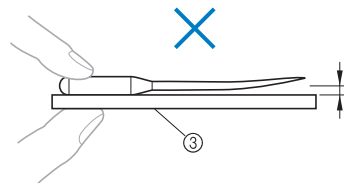

- ③ Flat surface

Bobbin precautions

Be sure to observe the following precautions concerning the bobbin.

⚠ CAUTION

- Only use prewound bobbin (COATS "L" type/ TRU-SEW POLYESTER "Filaments") or bobbins designed specifically for this machine. Use of any other bobbin may result in injuries or damage to the machine.

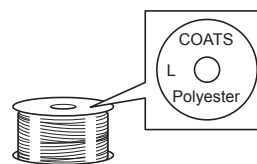

- Use a bobbin thread that has been correctly wound, otherwise the needle may break or the thread tension will be incorrect.

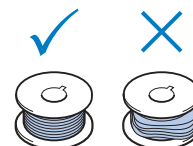

- When winding a bobbin, only use optional bobbin winder (refer to page 205) and metal bobbins (Part code: 100376-053).
- When winding the bobbin, be sure to use cotton or spun polyester bobbin thread (between 74 dtex/2 and 100 dtex/2).

Upper thread recommendations

Be sure to observe the following recommendations concerning the upper thread.



Note

- It is recommended that rayon or polyester embroidery thread be used (120 den x 2 / 135 dtex x 2 / 40 weight (in Americas and Europe) / #50 (in Japan)).

Fabric recommendations

Be sure to observe the following recommendations concerning the fabric.



Note

- Your machine can embroider fabric that is up to 2 mm (5/64 inch) thick. If thicker fabric is sewn, the needle may bend or break.
- When embroidering overlapping stitches, it is difficult for the needle to penetrate the fabric, possibly resulting in the needle bending or breaking.
- Attach stabilizers to thin or stretch fabrics. (Refer to “Attaching Iron-On Stabilizer (Backing) to Fabric” on page 84 for information.)
- When embroidering large pieces of fabric, make sure that the fabric is not caught in the carriage.

Display recommendations

Be sure to observe the following recommendations concerning the use of the operation panel display.



Note

- Only touch the display with your finger or included touch pen. Do not use a mechanical pencil, screwdriver or any other hard or sharp object. In addition, do not apply extreme pressure to the display screen, otherwise damage to the display screen may result.

Basic Procedures

Basic embroidering procedures are described below.

Check the overall procedure below, before operating the embroidery machine.

Step	Operation	Tutorial Reference Page	Operating Precaution Reference Page
1	Install the bobbin.	p. 33	p.30
2	Turn on the machine.	p. 35	p.29
3	Select an embroidery pattern.	p. 38	
4	Edit the embroidery pattern.	p. 40	
5	Check the previewed image.	p. 41	
6	Hoop the fabric in the embroidery frame.	p. 42	p.31
7	Attach the embroidery frame to the machine.	p. 44	
8	Specify the embroidering settings.	p. 46	
9	Check the embroidery area.	p. 47	
10	Thread the upper threads.	p. 48	p.31
11	Unlock the machine, then press the start/stop button to start embroidering. (Once embroidering is completed, the machine automatically stops.)	p. 57	
12	Remove the embroidery frame, and then remove the fabric from the frame.	p. 60	
13	Turn off the machine.	p. 61	

The operations to embroider the pattern are described on the following pages.

Although embroidering can continue without the pattern being edited or embroidering settings being specified, refer to page 146 for details on editing the patterns, and refer to page 105 for details on specifying embroidering settings.

Descriptions of the keys and other information that appear in the main LCD screens are provided in the tables on pages 63 to 72. Use these tables for quick reference.

The various operating precautions that must be observed during the basic procedures are provided on pages 29 to 31. These precautions must be strictly observed in order for the machine to function properly. Make sure to read these precautions.

1. Installing the Bobbin

When the machine is purchased, only the bobbin case is installed in the hook. Insert a bobbin wound with bobbin thread for embroidering. For precautions concerning the bobbin, refer to page 30.



Note

- The machine does not indicate how much bobbin thread is remaining. Before starting to embroider make sure that there is enough bobbin thread for the pattern.
- Make sure to clean the bobbin case every time the bobbin is changed. For details on cleaning the bobbin case, refer to “Cleaning the bobbin case” on page 212.

Removing the bobbin case

1

Open the hook cover.

Pull the hook cover toward you.

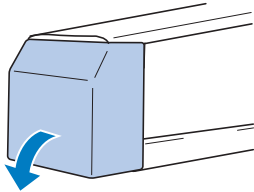

2

Pull the thread picker toward you if it was not pulled toward the front.

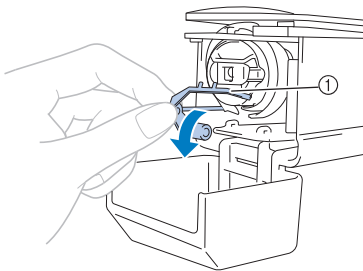

① Thread Picker

To gain access to the bobbin case easily, pull the thread picker toward front.



Memo

- Thread picker is a device that is used to hold the thread when beginning to sew or when trimming the thread.

⚠ CAUTION

- The thread picker can only be moved within a certain range. Do not pull it with extreme force.

3

Grab the bobbin case latch, and remove the bobbin case.

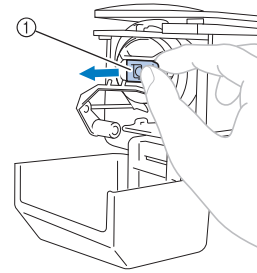

① Latch

■ Oiling the machine

After removing the bobbin case, apply oil to the machine. The race should be oiled. For details on oiling the machine, refer to “Oiling the machine” on page 214.



Note

- Put a drop of oil onto the hook once a day before use.

Installing the bobbin



Memo

- This embroidery machine is not equipped with a bobbin-winder. Use pre-wound (L type) bobbins.
- The optional bobbin winder (stand-alone type) and optional metal bobbins can also be used. (Refer to page 22, 205.)

1

Insert the bobbin into the bobbin case.

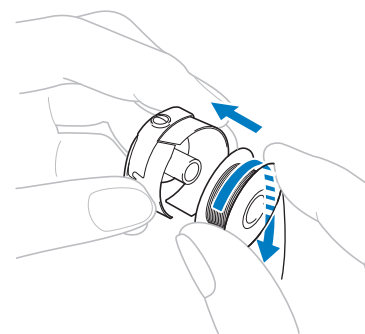

Note

- Check that the thread winds off the bobbin clockwise as shown in the illustration. If the bobbin is installed with the thread winding off in the opposite direction, the embroidery will not be sewn correctly.

- 2** Pass the thread through the thread slit and under the tension-adjusting spring.

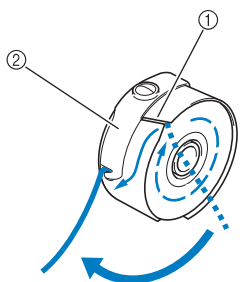

- ① Thread slit
- ② Tension-adjusting spring

- 3** Pull the thread about 50 mm (2 inches) through the opening in the tension-adjusting spring.

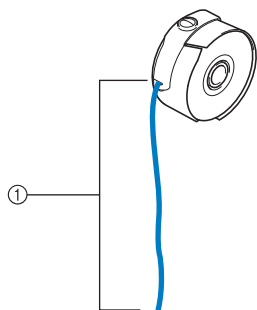

- ① About 50 mm (2 inches).

For adjusting the tension of the bobbin thread, refer to “Adjusting the tension of the bobbin thread” on page 102.

Installing the bobbin case

- 1** Insert the bobbin case into the hook.
Insert the bobbin case while aligning the tab on the bobbin case with the notch in the hook, as shown in the illustration.

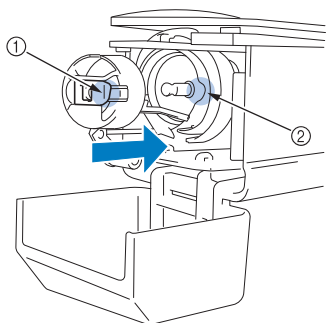

- ① Tab
- ② Notch

- 2** Fully insert the bobbin case until it snaps into place.

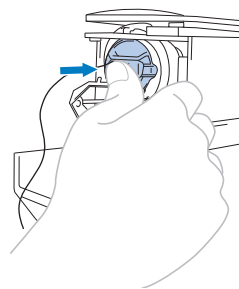

- 3** Close the hook cover.

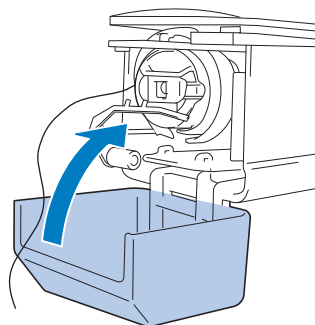

2. Turning ON the Machine

Connect the power supply cord, and then turn on the embroidery machine. For precautions concerning the power supply, refer to page 29.

⚠ CAUTION

- Be sure to use the included power cord for this machine. Using any other power cord may result in damage.

- 1 Plug the power supply cord into the machine.

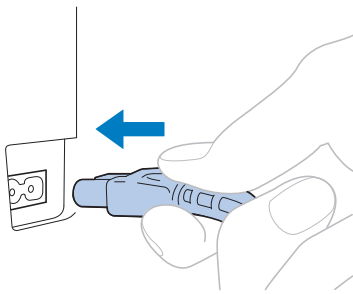

- 2 Insert the plug of the power supply cord into a household electrical outlet.

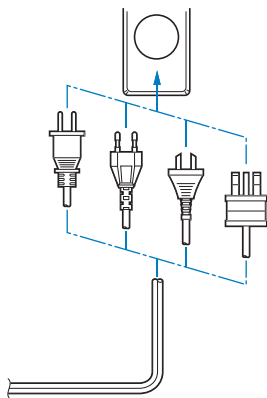

- 3 Switch on the main power switch on the back of the machine to "I".

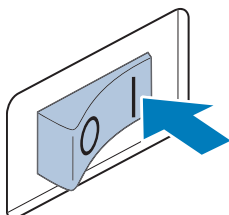

→ The LCD screen comes on.

- 4 When the machine is turned on, the opening movie is played. Touch anywhere on the screen to display the message below.

- 5 Touch **OK**.

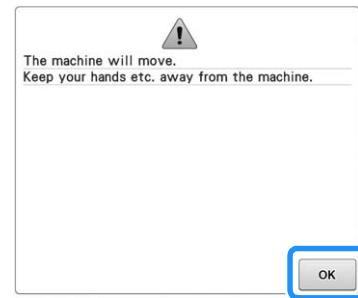

→ The pattern type selection screen appears, and the start/stop button lights up in red.

- 6 The carriage moves to its initial position.

- If the number 1 needle bar is not already at the embroidering position, the needle bar case moves and the number 1 needle bar moves to the embroidering position.

⚠ CAUTION

- Make sure to keep your hands and other items away from the carriage, in order to prevent any injuries.

📖 Memo

- If the machine is turned off in the middle of embroidering, the machine will automatically save the design position when turned on again. At that time, you will be asked if you wish to continue embroidering or begin a new operation. (Refer to "Resume Embroidering After Turning Off the Machine" on page 101.)

Setting your machine for the first time

When you first turn on the machine, set the language and time/date to your language and local time/date. Follow the procedure below when the settings screen appears automatically.

- 1 Touch or and to set your local language.

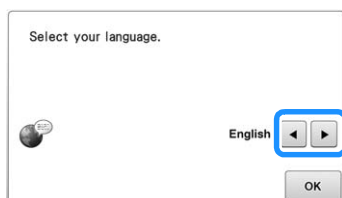

- 2 Touch .

→ The carriage moves to its initial position.

- 3 The message screen, confirming if you want to set time/date, appears. To set the time/date, touch ; to cancel the setting, touch .

→ The screen to set time/date appears.

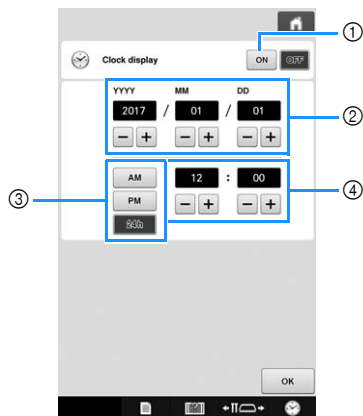

- 1 Touch to display the time on the screen.
- 2 Set the year (YYYY), month (MM) and date (DD).
- 3 Select whether 24h or 12h setting to display.
- 4 Set the current time.

- 4 Touch to start using your machine.



Note



- The time/date you set may be cleared, if you don't turn on the machine for an extended period of time.
- Time setting is also available by pressing on the bottom right of the LCD screen.

Understanding the screens

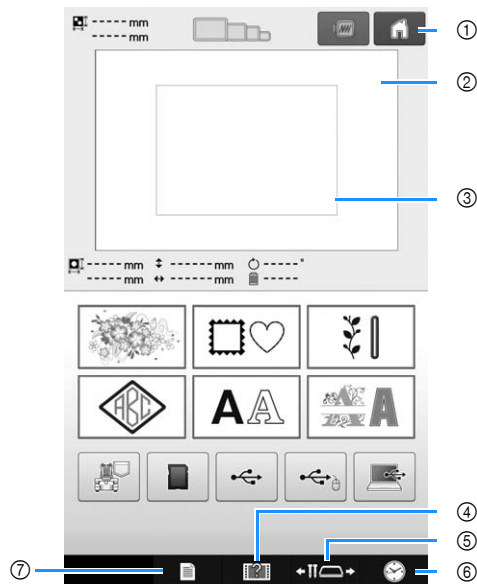
When the machine is turned on and is touched, the pattern type selection screen appears. The operations described below will be entered using the operation panel. For precautions concerning the use of the touch panel, refer to page 31.



No.	Display	Function	Page
	Key Name		
①	 Home key	Touch this key to cancel all operations previously performed and return to the initial pattern group selection screen.	—
②	— Pattern display area	This area displays the selected pattern.	p.180
③	— Embroidering area line	Shows the available embroidering area for the attached embroidery frame. The embroidery frame indications, the grid lines and other display settings can be specified from the machine settings screen.	p.180
④	 Machine operations guide key	Touch this key to check a machine operation.	p.187
⑤	 Needle bar/ Frame move key	Touch this key to move or thread a selected needle bar, to position the carriage, or to oil the machine so the embroidery frame can easily be removed or attached.	p.55 p.80

No.	Display	Function	Page
	Key Name		
⑥		Touch this key to set the clock to your local time.	p.36
	Clock key		
⑦		Touch this key to change the embroidery machine settings.	p.177
	Settings key		

* The keys in the table above appear and can be used in most of the screens described later in this manual.

Screen overview

The basic operation flow is shown below.

In the **pattern type selection screen**, select a pattern type. (Refer to page 38, 64.)

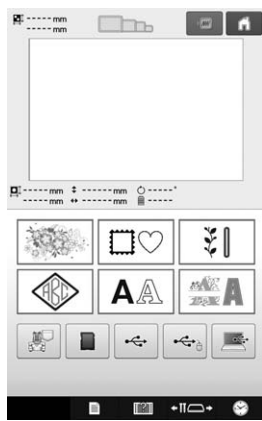

In the **pattern list screen**, select the pattern. (Refer to page 39, 65.)

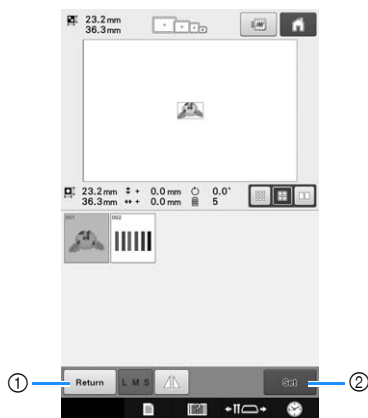

- ① Touch this key to return to the **pattern type selection screen**.
- ② Touch this key to continue to the **pattern editing screen**.

In the **pattern editing screen**, edit the pattern. (Refer to page 40, 66.)

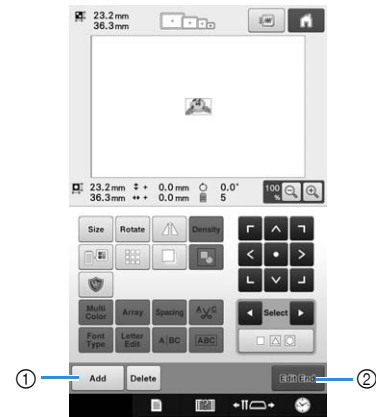

- ① Touch this key to return to the **pattern type selection screen** and add another pattern.
- ② Touch this key to continue to the **embroidering settings screen**.



In the **embroidering settings screen**, if it is a combined pattern, edit the entire pattern, specify the embroidering settings and check the embroidery area. (Refer to page 46, 68.)

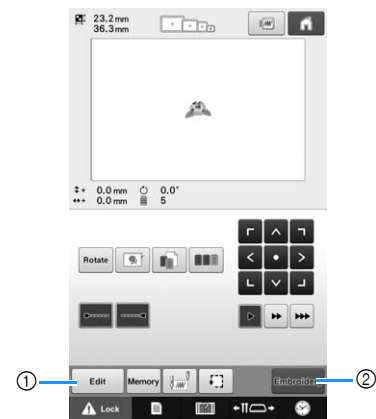

- ① Touch this key to return to the **pattern editing screen**.
- ② Touch this key to continue to the **embroidering screen**.



In the **embroidering screen**, check the thread colors assigned to the needle bars, and then install the upper threads. Touch **Lock** to unlock the machine so that the start/stop button starts flashing in green. The embroidery machine is now ready to begin sewing.

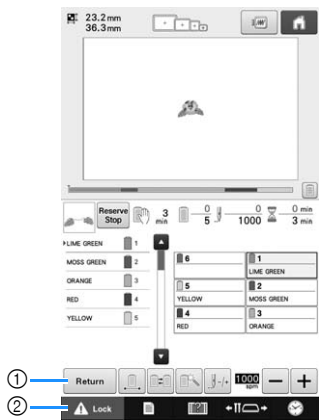

- ① Touch this key to return to the **embroidering settings screen**.
- ② Unlock key

After the embroidery pattern is sewn, a “Finished embroidering” message screen appears. Touch **OK** to return to the **embroidering settings screen**. (Refer to page 46, 68)

3. Selecting an Embroidery Pattern

As an example, we will select the pattern shown below.



In the pattern type selection screen, select a pattern category (type).

Pattern type selection screen (For details on the keys and other information on the screen, refer to page 64.)

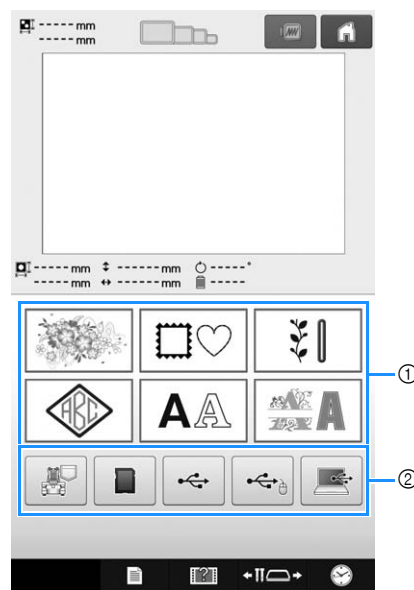

- ① Pattern type keys
- ② Touch to retrieve the saved patterns.

In the pattern list screen, search for the desired pattern, and then touch the key for the pattern.

Pattern list screen (For details on the keys and other information on the screen, refer to page 65.)

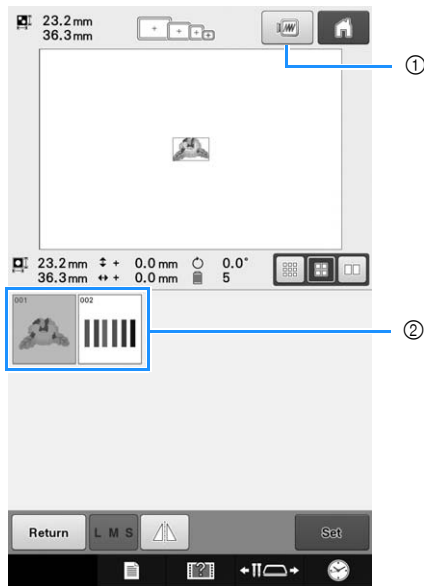

- ① Displays a preview image.
- ② Pattern keys

■ Checking a preview image from the pattern list screen

Touch  to preview the image prior to selecting.

Touch  to return to the pattern list screen.

Selecting an embroidery pattern

- 1 Touch  to select the embroidery patterns category.

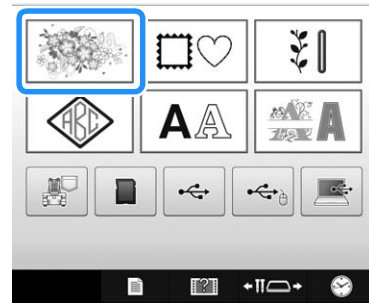

- The embroidery pattern categories appear.
- Sub-category keys may appear for some pattern categories. Touch the key for the sub-category containing the desired pattern.

- 2 **Select an embroidery pattern category.**
Touch the desired pattern category.

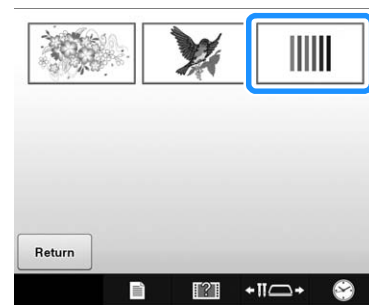

- The pattern list screen appears.

3 Touch the desired pattern.

In this case, touch .

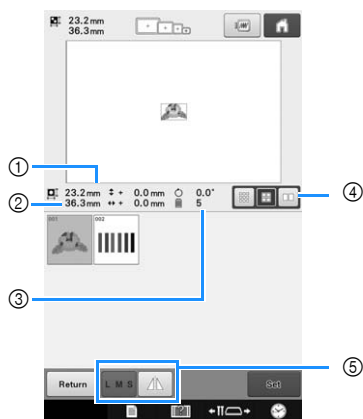
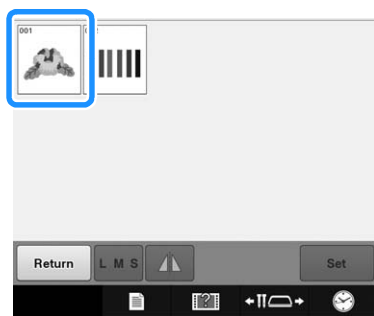

After a pattern is selected, the following appear:

- ① Vertical length of the pattern
- ② Horizontal width of the pattern
- ③ Number of thread color changes
- ④ Thumbnail size selection key
The size of the pattern thumbnails can be set to large, medium or small.
- ⑤ These keys can be used to change the pattern size or to flip the pattern horizontally. The functions may be used differently depending on the type of pattern that is selected.

(Refer to “Flipping a pattern horizontally” on page 149.)

- If the wrong pattern was selected or you wish to select a different pattern, touch the desired pattern.

4 Touch to display the next screen.

This confirms the pattern selection.

→ The pattern editing screen appears.

4. Editing the Embroidery Pattern

From this screen, the pattern can be edited.

Pattern editing screen (For details on the keys and other information on the screen, refer to page 66.)

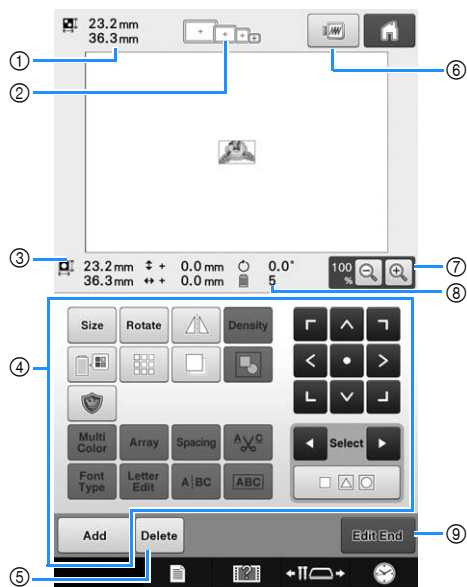

- ① Shows the size of the embroidery pattern currently displayed in the pattern display area. The top value shows the height and the bottom value shows the width. If the embroidery pattern consists of multiple patterns that have been combined, the size of the entire pattern, including all patterns, is shown.
- ② Highlights the sizes of embroidery frames that can be used to sew the currently selected embroidery pattern.

Memo

- If the embroidery frame holder is not attached to the machine, the embroidering area will not display the correct frame size. (Refer to page 45.)

- ③ Shows the size of the currently selected embroidery pattern. The top value shows the height and the bottom value shows the width.
- ④ Touch to edit the pattern.
- ⑤ Touch this key to delete the pattern, for example, if the wrong pattern was selected. No pattern is selected and the pattern type selection screen appears.
- ⑥ Displays a preview image.
- ⑦ Touch to change the size of the on screen embroidery image presentation.
- ⑧ Shows the number of thread color changes for the currently selected embroidery pattern
- ⑨ Continues to the next screen.

In this example, we will not edit the pattern. Without performing any editing operations, continue to confirm the pattern.

5. Previewing the Image

You can view an image of the completed pattern within the embroidery frame.

Checking a preview image



Display the preview image to check that the embroidery will be sewn as desired.

1 Touch .





→ The preview image is displayed.



① Touch  to display the pattern enlarged. Touch  to display the pattern reduced.

Memo

- A preview image in a landscape orientation cannot be rotated to a portrait orientation, even if there is space at the top and bottom.

2 Touch  or  to select the type of embroidery frame holder, and then select the embroidery frame you are going to use.

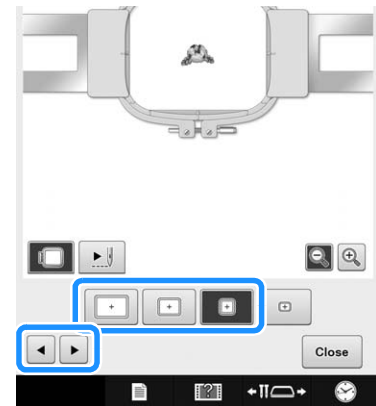

- After determining the type of embroidery frame holder and size of embroidery frame that are best for your embroidery, change the embroidery frame holder and embroidery frame that are installed. The machine will automatically detect the embroidery frame holder and embroidery frame and change the display.

3 Touch  to check the embroidering order.

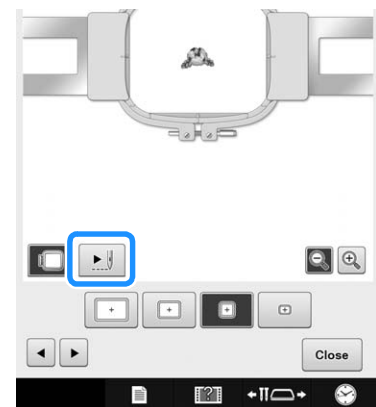

→ The stitch simulator screen appears.

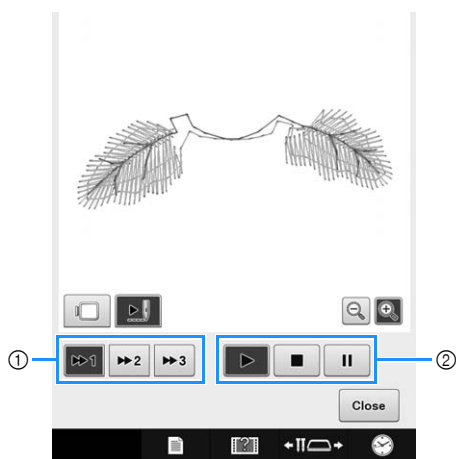

- ① Select the simulation speed. Touch **▶▶1**, **▶▶2** or **▶▶3** to change the speed. The speed can even be changed while the simulation is running.
 - ② Operation keys
 - ▶**: Touch to start the simulation at the set speed.
 - ||**: Touch this key while the simulation is running to pause it. Touch **▶** to continue the simulation.
 - : Touch this key while the simulation is running or paused to stop it and return to the condition before it was started.
- Touch **◻** to return to the embroidery frame holder/embroidery frame selection screen.

4 Touch **Close** to return to the previous screen.

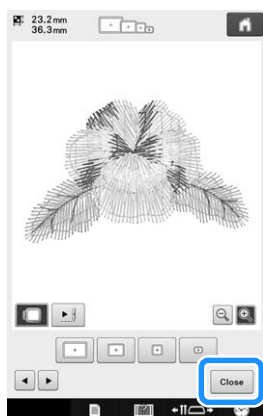

Memo

- The embroidery can be sewn while the preview image is displayed in the embroidering screen. If the preview image is displayed in any screen other than the embroidering screen, the embroidery cannot be sewn.

6. Hooping the Fabric in the Embroidery Frame

After selecting the pattern to be embroidered, check which embroidery frames can be used to sew the pattern. Select the appropriate frame, and hoop the fabric and stabilizer in the embroidery frame.

(Refer to “Attaching Iron-On Stabilizer (Backing) to Fabric” on page 84.) For precautions concerning the fabric, refer to page 31.



Note

- If the fabric is not taut, the pattern may be misaligned or the fabric may pucker. Follow the procedure described below to firmly stretch the fabric in the embroidery frame so that the fabric is not loose. In addition, be sure to work on a level surface when putting the fabric in the embroidery frame.

Hooping the fabric in the embroidery frame

1 Select an embroidery frame.

From the sizes of embroidery frames indicated in the screen, select the embroidery frame that you wish to use.



Embroidery frames that can be used appear lighter (**+**) embroidery frames that cannot be used appear darker (**■**).







Memo





- If the embroidery frame holder is not attached to the machine, the embroidering area will not display the correct frame size. (Refer to page 45.)

■ Embroidery frame types

There are four sizes of embroidery frames included with this machine, which are used with the included embroidery frame holder A. For details on the uses for each frame, refer to “Correctly Using the Embroidery Frames” on page 80.

Icon	Name
Embroidering area	
	Extra-large embroidery frame
	200 mm (H) × 300 mm (W) (7-7/8 inches (H) × 11-3/4 inches (W))
	Large embroidery frame
	130 mm (H) × 180 mm (W) (5-1/8 inches (H) × 7-1/8 inches (W))
	Medium embroidery frame
	100 mm (H) × 100 mm (W) (4 inches (H) × 4 inches (W))
	Small embroidery frame
	40 mm (H) × 60 mm (W) (1-1/2 inches (H) × 2-3/8 inches (W))

If you use any of the optional embroidery frames, the following icons appear in the screen.

-  : Embroidery frame holder B
-  : Embroidery frame holder C
-  : Embroidery frame holder D
-  : Embroidery frame holder E

⚠ CAUTION

- If embroidery frames other than the four included frames or recommended optional frames are used, the embroidery frame may hit the presser foot and damage the machine, or cause injury to the user. (See “Correctly Using the Embroidery Frames” on page 80 for the details about the embroidery frames.)

Note

- The embroidery frame indicators show all embroidery frame sizes in which the embroidery pattern can be sewn. Be sure to use an embroidery frame of the most suitable size. If the embroidery frame that is too large is used, the pattern may be misaligned or the fabric may pucker. (Refer to “Correctly Using the Embroidery Frames” on page 80.)

■ Hooping fabric in the small embroidery frame

The procedure for hooping fabric in the small embroidery frame is described below.

The same procedure is used to hoop the fabric in the medium embroidery frame.

For details on hooping fabric in the other included embroidery frames, refer to “Hooping the Fabric” on page 85.

2 Loosen the screw on the outer frame.

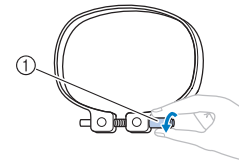

① Screw

3 Place the fabric with the right side up on top of the outer frame.

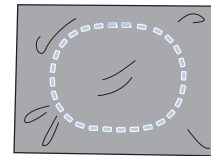

- The outer frame does not have a front or back side. Either side can be used as the front.
- In order to prevent shrinkage of the stitching or misaligned patterns, we recommend that iron-on stabilizer (backing) be used for embroidering. (Refer to “Attaching Iron-On Stabilizer (Backing) to Fabric” on page 84.)

4 Press the inner frame into the outer frame.

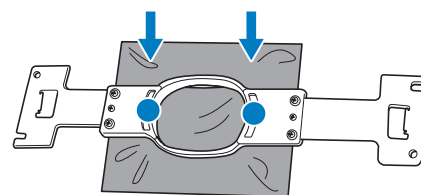

- Be sure that there are no wrinkles in the fabric after it is positioned in the embroidery frame.

5 Lightly tighten the screw, and then pull the edges of the fabric.

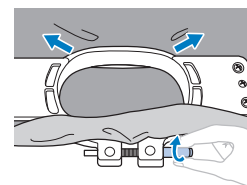

- 6** Securely tighten the screw, and then check to make sure that the fabric is taut.

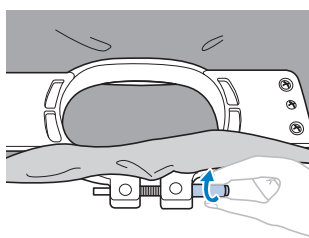

- After securing the fabric, lightly tapping it should produce a drum-like sound.
- Firmly clamp together the inner and outer frames so that the bottom of the inner frame is lower than the bottom of the outer frame.

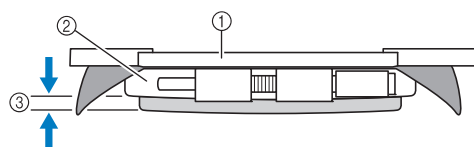

- ① Inner frame
- ② Outer frame
- ③ Bottom of inner frame

- Using the included disc-shaped screwdriver, firmly tighten the screw.

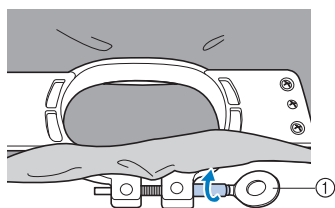

- ① Disc-shaped screwdriver

The amount that the fabric is stretched and the use of stabilizer material differ depending on the type of fabric being embroidered. Try various methods to achieve the best embroidering results. (Refer to “Hooping techniques” on page 203.)

7. Attaching the Embroidery Frame to the Machine

After hooping the fabric in the embroidery frame, attach the frame to the embroidery machine. Embroidery frame holders A and B are included accessories with this machine.

Install embroidery frame holder A when an included embroidery frame is to be used. (See “Correctly Using the Embroidery Frames” on page 80 for the details about the embroidery frame holders.)

⚠ CAUTION

- If the embroidery frame is not correctly attached it may hit the presser foot and damage the machine, or cause injury to the user.
- When attaching the embroidery frame, make sure that the start/stop button is lit in red. If the start/stop button is flashing in green, the embroidery machine may start sewing. If the embroidery machine accidentally starts operating, injuries may result.
- When attaching the embroidery frame, make sure that the embroidery frame does not hit any other part of the embroidery machine.



Note

- Before attaching the embroidery frame, check that there is enough thread in the bobbin.

Attaching the embroidery frame

Adjust the width of the embroidery frame holder to the size of the embroidery frame, and then attach the embroidery frame to the machine. As an example, the procedure for attaching the small embroidery frame is described below.

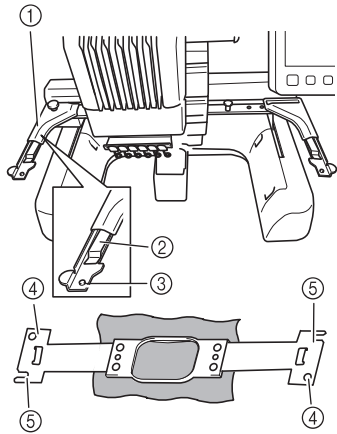

- ① Left arm of embroidery frame holder
Move the arm of the embroidery frame holder to the left or right to adjust it to the size of the embroidery frame.
- ② Clip on embroidery frame holder.
Insert the embroidery frame into the clips on the embroidery frame holder.
- ③ Positioning pin
- ④ Holes
- ⑤ Positioning slots

1 Loosen the two thumb screws on the embroidery frame holder.

If the screw is too tight, please use the included disc-shaped screwdriver.

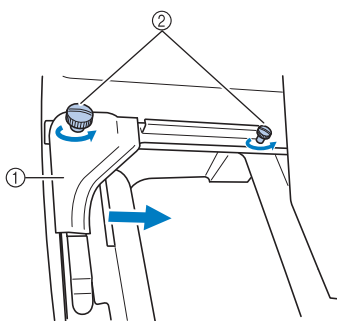

- ① Left arm
 - ② Thumb screws
- The left arm of the embroidery frame holder can be moved.
- Only loosen the thumb screws a maximum of 2 turns counterclockwise. Do not remove the screw.

2 Move the left arm to align the screw on the right side with the mark for the embroidery frame to be installed, and then tighten the thumb screws.

For this example, align with mark ④.

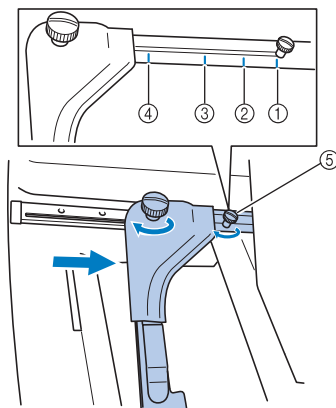

- ① Mark for extra-large embroidery frame
- ② Mark for large embroidery frame
- ③ Mark for medium embroidery frame
- ④ Mark for small embroidery frame
- ⑤ Align the screw with the mark.



Note

- Please firmly tighten the two thumb screws with included disc-shaped screwdriver. If the thumbscrews are not tightened, any of the following problems may occur.
 - The machine will detect the embroidery frame size incorrectly.
 - The starting position for the embroidery frame is misaligned.
 - The embroidery pattern is misaligned.

→ The embroidery frame holder is ready for the embroidery frame to be attached.

3 Hold the embroidery frame level, and then simultaneously align both the left and right mounts with the embroidery frame holder clips.

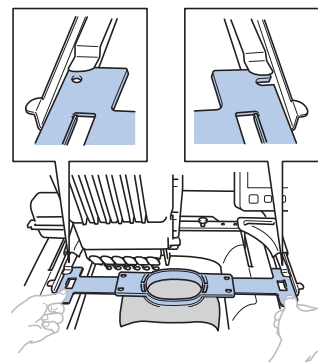

- The inner frame should be on top.



Note

- Attach the embroidery frame to place the needle plate under the embroidering area otherwise the embroidery frame hits the needle plate.

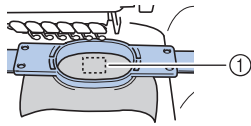

① Needle plate

- If the outer frame is on top, as shown below, the embroidery frame is incorrectly attached.

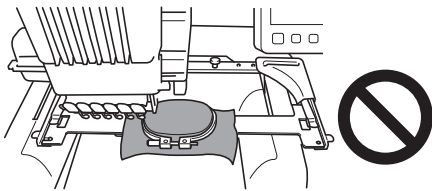

4 Insert the embroidery frame until it snaps into place.

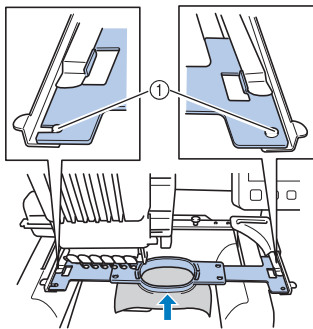

- ① Make sure that the pins on the left and right arms of the embroidery frame holder fit into the positioning slot and hole on the embroidery frame.

Continuing to the embroidering settings screen

1 Press **Edit End**.

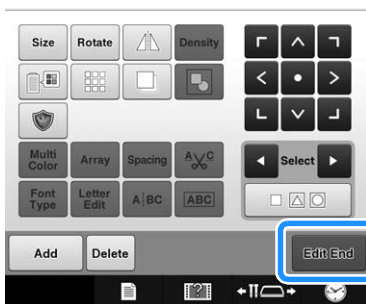

→ The embroidering settings screen is displayed.

8. Specifying Embroidering Setting

From this screen, the entire pattern can be edited and embroidering settings can be specified. In addition, the embroidering position can be checked and a pattern can be saved for later use. **Embroidering settings screen** (For details on the keys and other information on the screen, refer to page 68.)

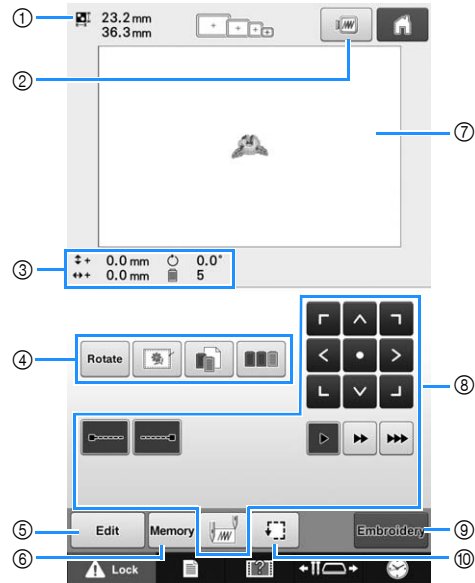

- ① Shows the size of the pattern in the pattern display area.
- ② Displays a preview image.
- ③ Image on the Design Page shows image size, rotation, number of thread changes and measured position of image within the embroidery area.
- ④ Touch for additional editing functions.
- ⑤ Returns to the pattern editing screen.
- ⑥ Touch to store the pattern in memory.
- ⑦ The embroidering area guide in the pattern display area indicates the size of the embroidery frame that is actually installed.
- ⑧ Touch these keys to specify how the pattern will be embroidered.
- ⑨ Continues to the next screen
- ⑩ Touch to check the embroidering area.

In this example, we will not specify any of the embroidering settings. Continue with the next operation.

**Note**

- Available keys are not the same if you set “Manual Color Sequence” to “ON” in the settings screen. For details on the keys and other information on the screen, refer to page 70.

**Memo**

- If the embroidery frame is not positioned correctly when continuing to the embroidering settings screen, the embroidery frame is moved to the correct position at the same time that the embroidering settings screen is displayed. (Refer to “Moving to the correct position” on page 89.)

9. Checking the Embroidery Area

Check the embroidery area to make sure that the embroidery will be sewn in the desired location and will not be misaligned and that the embroidery frame will not hit the presser foot. If the embroidery frame is not correctly positioned, it moves to the correct position, and then the embroidering position is indicated.

1 Touch .

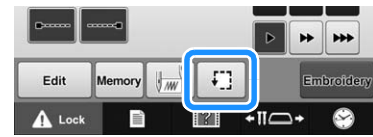

→ The presser foot is lowered and the embroidery frame moves to show the embroidery area.

2 The corners of the octagon showing the embroidery area for the pattern are indicated by changing direction.

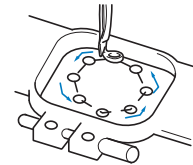

Carefully watch the movement of the embroidery frame and check that the embroidery is sewn in the desired location and that the embroidery frame does not hit the presser foot.

Temporarily stopping to check the area

The embroidery frame can be temporarily stopped at a desired position or the checking of the embroidering area can be stopped.

- 1 When the embroidery frame moves to the desired position, touch  again.

→ The embroidery frame stops moving, and the next screen appears.

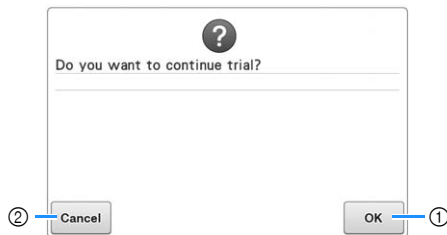

- 1 Touch to continue moving the frame.
- 2 Touch to stop checking the embroidering area.

Continuing to the embroidering screen

After finishing the necessary operations in the embroidering settings screen, continue to the embroidering screen.

- 1 Touch .

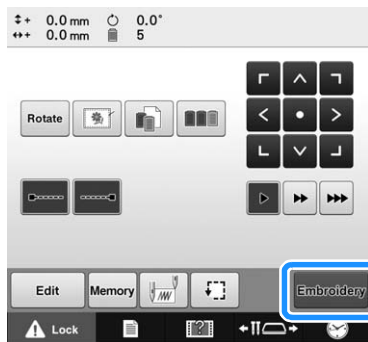

→ The embroidering screen appears.

10. Upper Threading

Check the embroidering screen for information on which needle bars should be threaded with which thread colors, and then thread the upper threads.

Checking the needle bars and thread colors

In the embroidering settings screen, touch  to display the embroidering screen. Check the thread colors in this screen.

Change thread spools message will appear if the thread spools from the previous embroidery project need to be changed. If you set "Manual Color Sequence" to "ON" in the settings screen, the message does not appear even if the thread spools need to be changed. (Refer to "Selecting/Managing Thread Colors for Each Needle Bar (Manual Color Sequence)" on page 108.)

Embroidering screen (For details on the keys and other information on the screen, refer to page 71.)

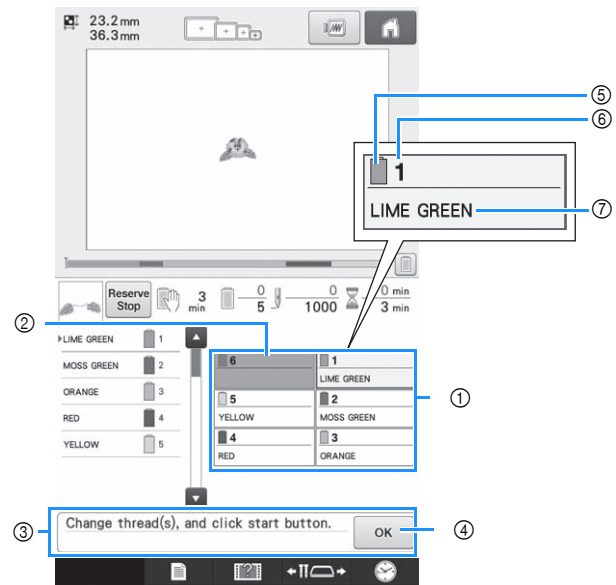

- 1 Thread information for the first to sixth needle bars
- 2 If no thread color name is displayed, that needle bar has not been used.
If a thread color had been assigned to the needle bar on a previously sewn design, the needle bar will show the previously assigned color.
- 3 Change thread spools message. (Refer to page 95.)
This message appears when it is necessary for the thread spools to be changed. If  4 is not touched to close the message, embroidering cannot continue.
- 4

Memo

- The thread information for the thread spool to be changed appears framed in red. When the automatic needle-threading button is pressed, the frame disappears.

- ⑤ Thread color
- ⑥ Needle bar number
- ⑦ Thread color name or number
If the thread color number (#123) is selected in the settings screen (Refer to “Changing the thread color information” on page 182), the thread brand will also displayed.

Thread with the color name that appears beside each needle bar number is threaded on that needle bar. For the screen shown



- 1: LIME GREEN
- 2: MOSS GREEN
- 3: ORANGE
- 4: RED
- 5: YELLOW

If there is no name beside the needle bar number, that needle bar is not used. For this example, needle bar 6 is not used.

1 Touch

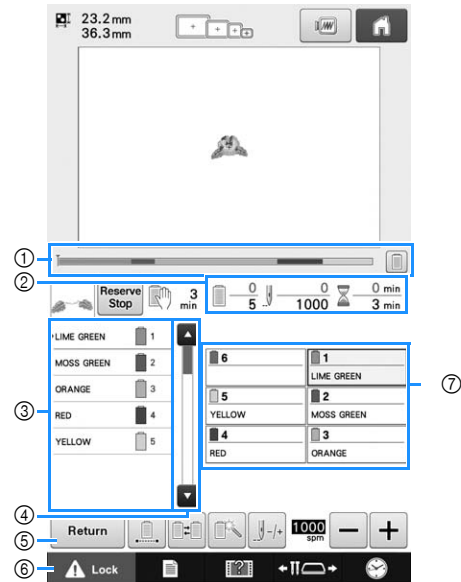
- The screen indicating that the spools be changed is closed.
- In addition to checking the thread colors, information such as the number of stitches and the sewing time can be checked and various embroidering settings can be specified in the embroidering screen.



- ① The embroidering progress is shown by the red mark in the bar. Touch  to display (in the indicator) only the thread color being embroidered.
- ② Shows the number of thread color changes, the number of stitches, the embroidering time and the length of time until the machine will stop.
- ③ Shows the thread colors, embroidering order and number of the needle bar assigned to the thread colors. A red triangle appears beside the thread color being embroidered. In addition, the box changes to gray and it will scroll off the page when embroidering is finished.
- ④ Touch  and  to view the embroidering order and needle bar number for thread colors that cannot be seen in the screen.
- ⑤ Use these keys to return to the embroidering settings screen.
- ⑥ When starting the machine or cutting the threads, touch this button to unlock the machine, and then press the start/stop button or thread trimming button.
- ⑦ Touch a key to move the selected needle bar to the sewing position. Use when threading the needle with the automatic needle-threading mechanism.



Note

- Available keys are not the same if you set “Manual Color Sequence” to “ON” in the settings screen. (Refer to page 71 for details on the keys and other information on the screen.)

⚠ CAUTION

- When  (unlock key) in the embroidering screen is touched, the start/stop button begins flashing in green and the embroidery machine can start sewing. If the upper threading is being performed or the needle is being threaded, be careful that the embroidery machine is not accidentally started, otherwise injuries may result.

Upper threading

Use machine embroidery thread to thread the needle bars in order, starting with needle bar 1.

⚠ CAUTION

- When threading the upper thread, carefully follow the instructions. If the upper threading is not performing correctly, the thread may break or become tangled, causing the needle to bend or break.



Note

- It is recommended that rayon or polyester machine embroidery thread be used (120 den/2, 135 dtex/2, 40 weight (in Americas and Europe), #50 (in Japan)).



Memo

- The path that the embroidery machine should be threaded is indicated by a line on the machine. Be sure to thread the machine as indicated.

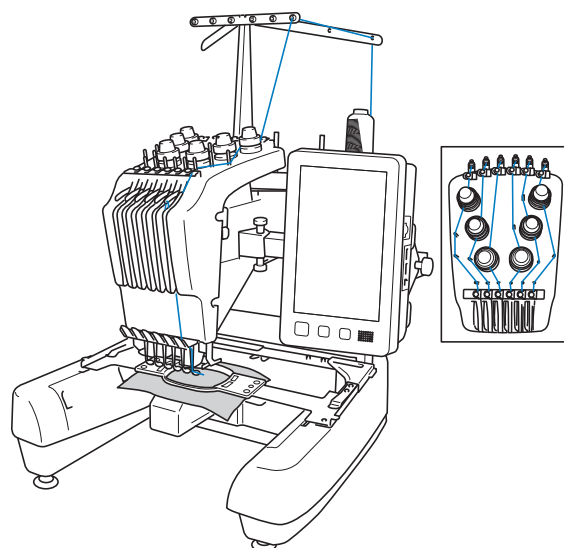

- 1 Place on spool pin 1 the spool of thread with the color (lime green) specified for needle bar 1.

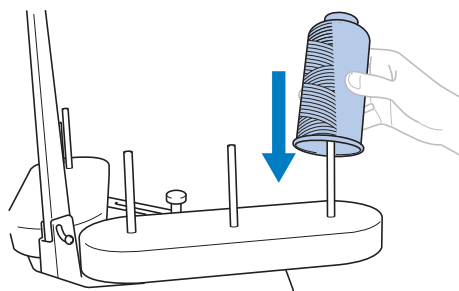

- Make sure that the spool stand is opened in the shape of a V.
- When using small spools of thread, be sure to place the included spool mat on the spool pin before placing the spool on the pin.
- Place the thread in the center of the spool stand so that the thread feeds off the spool correctly and does not get tangled around the spool pin directly under the thread spool.

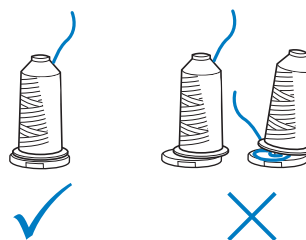

- Use spool cap on all spools of thread shorter than the height of the spool pin.

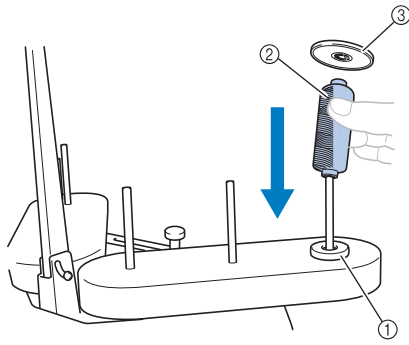

- ① Spool mat
- ② Small spool
- ③ Spool cap

- When using a flanged thread spool, place the spool on the spool pin, and then place the included spool cap onto the spool pin, over the spool.

The numbers indicate the thread path for each of the numbered needle bars. Be very careful to correctly thread the needle bars.

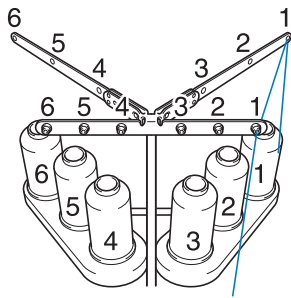

- 2** Pass the thread through the number 1 hole in the thread guide just above the spool, and then pass the thread through the number 1 hole in the thread guide toward the front of the machine.

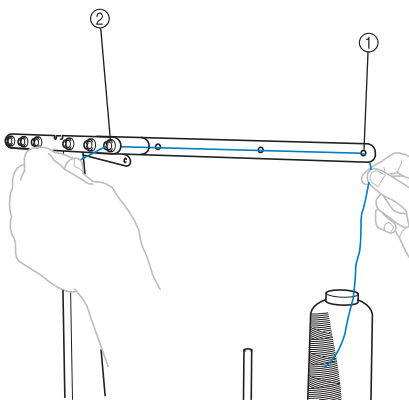

- ① Number 1 hole in the thread guide above the spool
- ② Number 1 hole in the thread guide toward the front of the machine

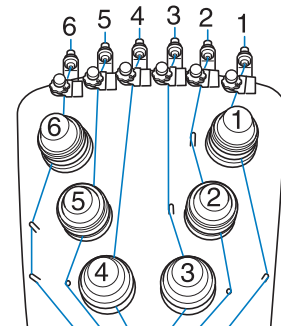

- 3** Pass the thread through the hole in the number 1 upper thread guide and pull the thread toward you.

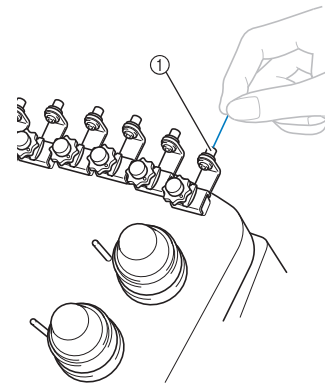

- ① Hole in upper thread guide

- 4** Hold the thread with both hands, and then pass it under the guide plate from the right.

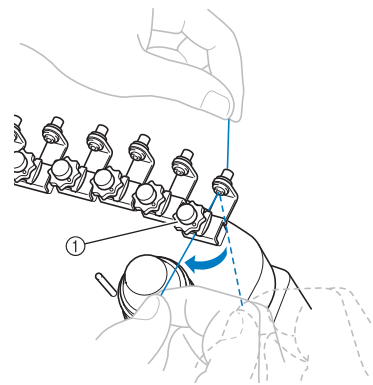

- ① Upper thread guide plate

- 5** Wind the thread clockwise once around the number 1 thread tension disc.

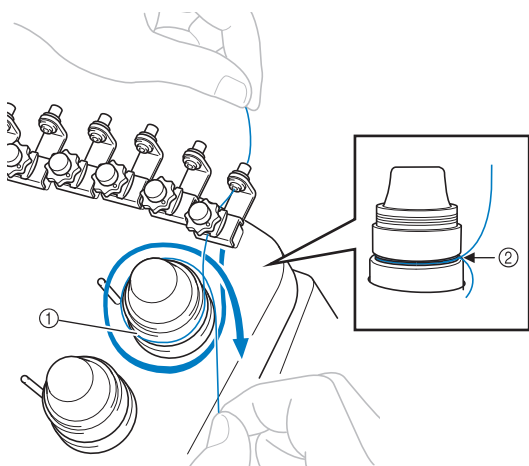

- ① Thread tension disc
 ② Pass thread in a clockwise direction at this location on the tension disks.
- Make sure that the thread is securely caught in the thread tension disc and passed correct thread guide pins.



Note

- All thread tension discs are threaded in clockwise direction.

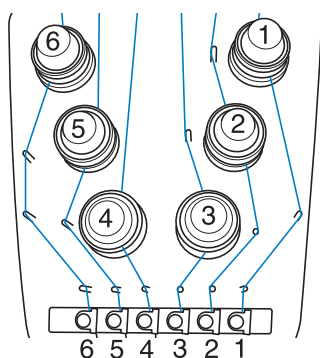

- 6** Lead the thread along the thread path and around the correct thread guide pins as indicated on the machine.

- 7** Slip the thread under the number 1 middle thread guide plate from the right.

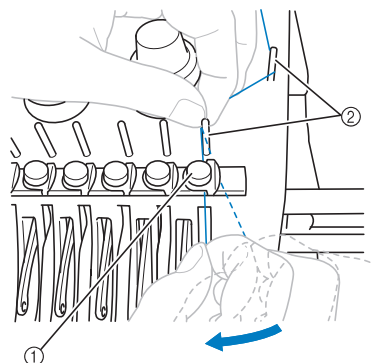

- ① Middle thread guide
 ② Thread guide pin
- The path from the upper thread guide around the thread tension disc and to the middle thread guide (steps 5 through 6) differs depending on the spool number. Passing the thread from the left to the right through the thread guide pins is designed to prevent the thread from becoming tangled. Be sure to follow the thread path indicated on the machine.

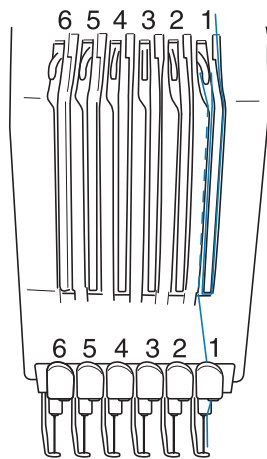

8 Pass the thread along the number 1 slot to pass it through the number 1 take-up lever hole from right to left.

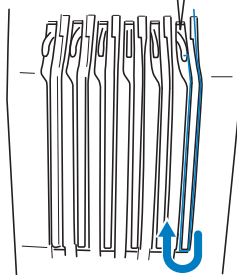
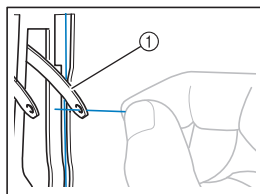

① Thread take-up lever

9 Pass the thread down through the slot to the lower thread guide, and then through the hole in the number 1 lower thread guide.

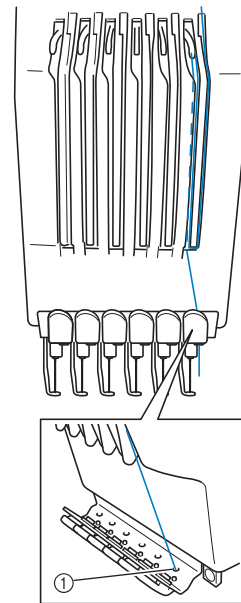

① Hole in lower thread guide

10 Use the included threader to pass the thread into the number 1 needle bar thread guide.

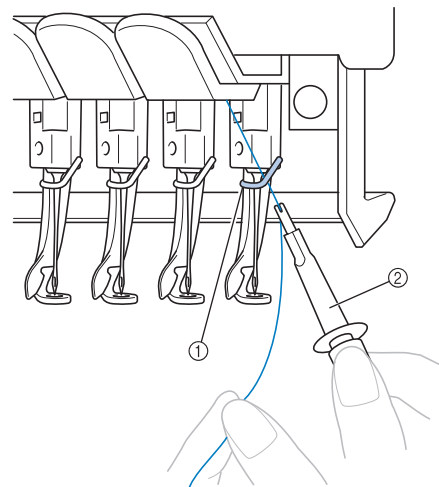

① Needle bar thread guide
② Needle changing tool (Threader)

Threading the needle

Use the automatic needle-threading mechanism to thread the needle.

- 1 Press the automatic needle-threading button.

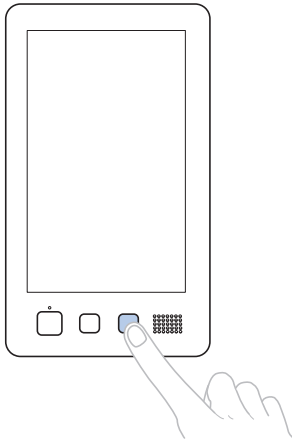

→ The hook on the automatic needle-threading mechanism passes through the eye of the needle.

⚠ CAUTION

- If the needle is not fully inserted, the hook of the automatic needle-threading mechanism will not pass through the eye of the needle during automatic needle threading, and the hook may bend or the needle cannot be threaded.
- If the hook of the automatic needle-threading mechanism is bent or damaged, contact your authorized Brother dealer.
- While the hook of the automatic needle-threading mechanism is passed through the eye of the needle, do not rotate the handwheel, otherwise the automatic needle-threading mechanism may be damaged.



Note

- To avoid damage, the automatic needle-threading mechanism may return to the back position when you turn the handwheel.
- The automatic needle-threading mechanism can thread one needle at the sewing position. When this mechanism is used, be sure that the needle bar that you want to thread is positioned as the sewing position, otherwise the automatic needle-threading mechanism cannot be used at the particular needle. If the needle bar is not at the sewing position, move it there. (Refer to page 55.)

- 2 Pull out about 150 mm (6 inches) of thread. Allow thread to relax and eliminate any stress on the thread. Then, as shown in the illustration, pass the thread under the fork of the automatic needle-threading mechanism from the right, and then catch the thread with the hook that passes through the eye of the needle.

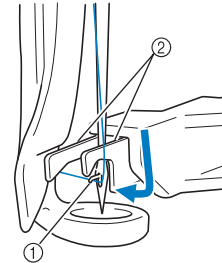

- ① Hook
- ② Fork



Note

- When catching the thread with the hook, be careful that the thread does not become loose.

- 3 Pass the thread under the guide on the presser foot.

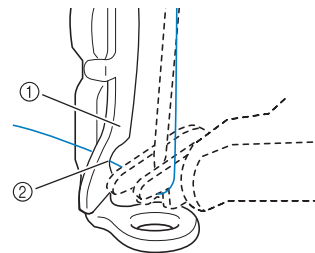

- ① Guide on presser foot
 - ② Notch in guide on presser foot
- Make sure that the thread securely passes through the notch in the guide on the presser foot.

- 4 Securely pass the thread through the groove in the thread cutter, and then lightly pull the thread to cut it.

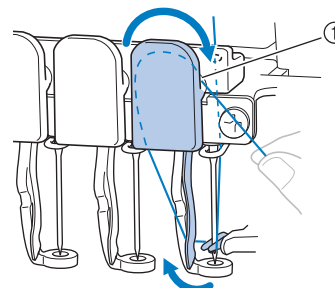

- ① Groove in thread cutter

**Note**

- If the thread is not correctly passed through the groove in the thread cutter, the message “Wiper error” appears and the needle cannot be threaded. Be sure to securely pass the thread through the groove.
- If enough thread is not pulled out, the thread cannot be pulled through the thread cutter.

5 Press the automatic needle-threading button.

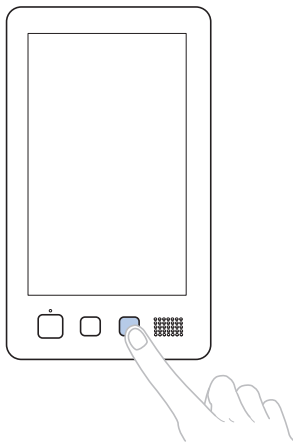

- The threader moves back away from the needle. The thread is pulled through the needle eye.
- The wiper comes out and catches the thread between the needle and the threader.
- The threader goes back to the original home position.

This completes the upper threading for needle bar 1.

Thread the remaining needle bars in the same way.

**Note**

- If the needle bar to be threaded is not moved to the embroidering position, the needle cannot be threaded with the automatic needle-threading mechanism. For the remaining needle bars, perform the following operation to move the needle bar to the embroidering position before trying to thread the needle.

Moving and threading a selected needle bar

You can move and thread a selected needle bar to the embroidering position at any time.

1 Touch .

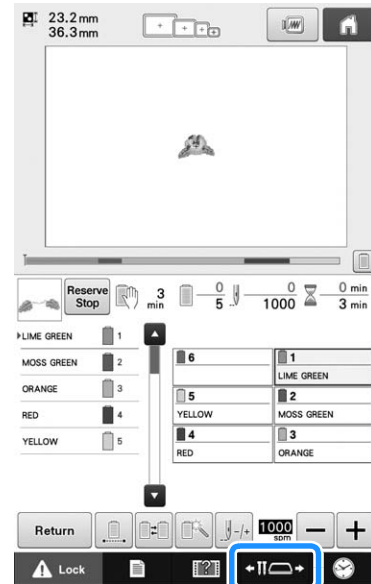

→ The needle bar move screen appears.

2 Touch the key for the needle bar that you wish to move or thread.

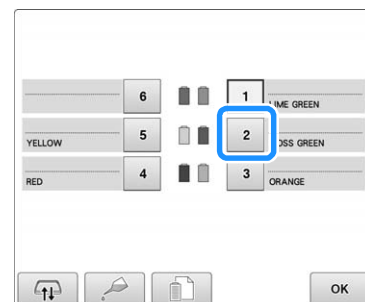

→ The selected needle bar moves to the position of embroidery.

- 3** Press the automatic needle-threading button while the needle bar move screen appears.

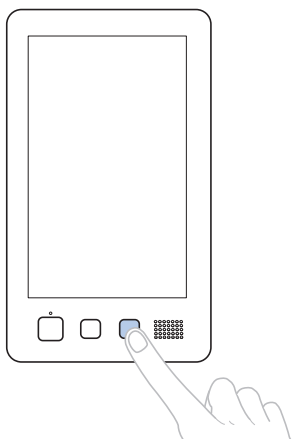

- 4** Touch **OK** to return to the previous screen.

Memo

- In the embroidering screen, a blue frame appears around the thread information box of the selected needle bar.

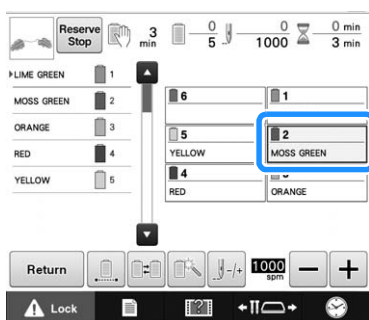

■ Moving the needle bar to be threaded to the position of embroidery

You can move the needle bar in the embroidering screen.

- 1** Touch the key for the needle bar that you wish to thread.

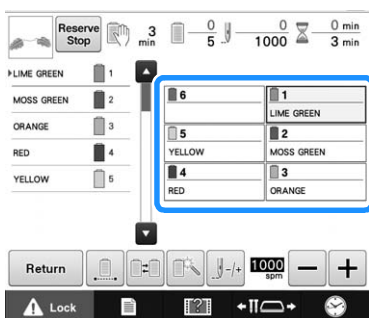

→ The selected needle bar moves to the embroidering position.

Note

- If the thread is not taut, it may come out of the thread tension disc. After upper threading is finished, check again to make sure that the thread is correctly passed into the thread tension disc. (Refer to step **5** on page 52.)

Memo

- When changing one of the upper thread colors, it is easy to re-thread by cutting the thread currently being used between the spool and the thread guide above the spool. Place the new spool on the spool pin and tie the end of the new thread to the end of the previous thread. Then pull the thread through to the needle. (Refer to page 96.)

■ Using the spool net

When using metallic thread or any other strong thread, place the included spool net over the spool before sewing.

If the spool net is too long, fold it once to match the size of the spool before placing it over the spool. It may be necessary to adjust thread tension when using the spool net.

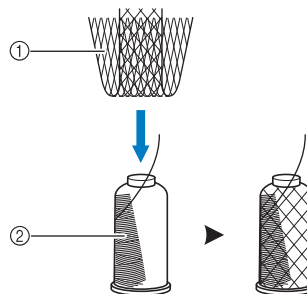

- ① Spool net
- ② Thread

11. Sewing the Embroidery

Now, the embroidery machine is ready to begin sewing.

When the machine starts sewing, the presser foot is automatically lowered, the necessary thread trimming operations at the end of stitching are performed, the threads are changed as necessary while the embroidery is sewn, and the machine stops when the end of the stitching is reached.

⚠ CAUTION

- For safety reasons, the embroidery machine must not be left unattended while it is sewing.
- While the machine is in operation, pay special attention to the needle location. In addition, keep your hands away from all moving parts such as the needle, needle bar case, thread take-up lever and carriage, otherwise injuries may result.

■ Locking mechanism

For safety reasons, this embroidery machine is equipped with a locking function. Normally, the embroidery machine is locked (it cannot start sewing). Unless the machine is unlocked, it cannot start sewing. If the embroidery machine is not started within 10 seconds after unlocking it, it automatically returns to being locked.

The start/stop button shows whether or not the embroidery machine is locked. If the start/stop button lights up in red, the machine is locked. If the start/stop button flashes in green, the machine is unlocked.

Starting embroidering



Note

- Make sure that there are no objects within the moving area of the embroidery frame. If the embroidery frame hits another object, the pattern may become misaligned.

1 Touch to unlock the embroidery machine.

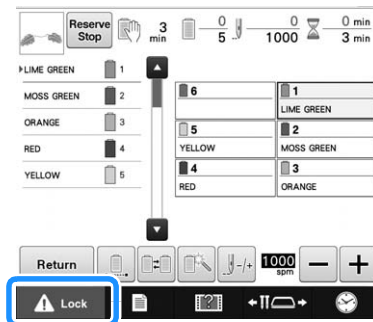

- The start/stop button begins flashing in green and the embroidery machine can be started.
- If the start/stop button is not pressed within 10 seconds after unlocking the embroidery machine, the machine becomes locked again.

2 Press the start/stop button.

Press the start/stop button while it is flashing in green. If the start/stop button returns to being lit in red, perform this procedure again from step 1.

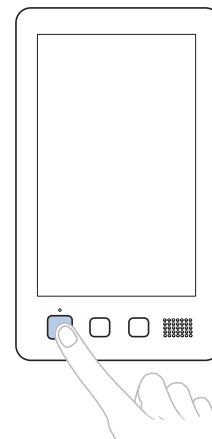

- The start/stop button lights up in green and begins sewing the first color.

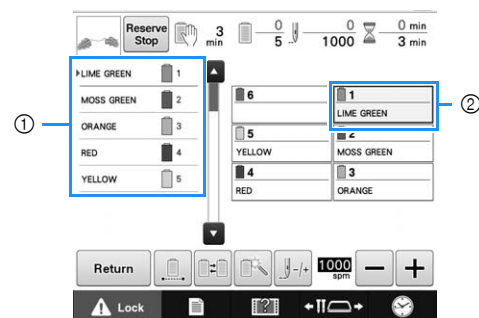

- ① The thread color for the needle bar that is currently being used for sewing or will soon be used for sewing appears at the top of the thread color sequence display. The remaining thread colors are listed in the sewing order, starting from the top.
- ② A blue frame appears around the thread information box of the needle bar currently being selected.

- While the embroidery machine is sewing, the point being sewn is indicated by the green crosshairs in the pattern display area. In addition, the number of stitches and the time count up.

3 After sewing of the first color is finished, the machine automatically stops and trims the thread. The needle bar case moves to the 2nd color position and sewing of the 2nd color begins.

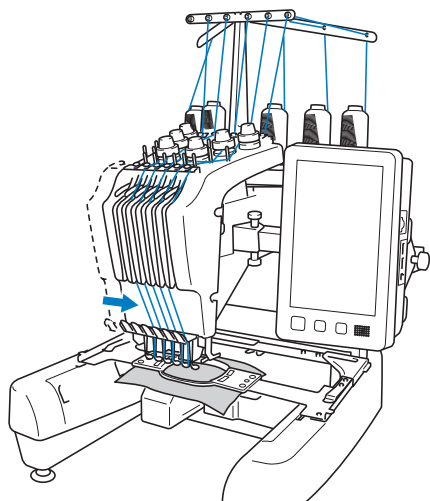

→ The thread color display in the screen continues to the second color, and the thread information for the second needle bar is surrounded by the blue frame.

4 This continues until the last color is sewn, and the embroidery machine automatically stops.

- The embroidering settings screen reappears.
- The start/stop button lights up in red.
- No thread trimming operations at the beginning of stitching and at the end of stitching are necessary.

Continuing embroidering

To sew the same pattern again, touch **Embroidery**.

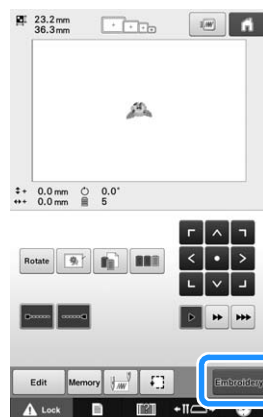

→ The embroidering screen appears so the same pattern can be sewn again.

To select a new pattern, touch **Home**.



→ The pattern type selection screen appears.

Memo

- Automatic Lock stitching can be set so that it is sewn at the beginning of the embroidery, when starting to sew after changing thread colors, and when trimming the thread. (Refer to “Automatic Lock Stitch Setting” on page 112.)
- The sewing speed can be changed, even while the pattern is being sewn. (Refer to “Maximum Sewing Speed Setting” on page 116.)

Stopping embroidering

The machine can be stopped during sewing.

■ Temporarily pausing

1 Press the start/stop button.

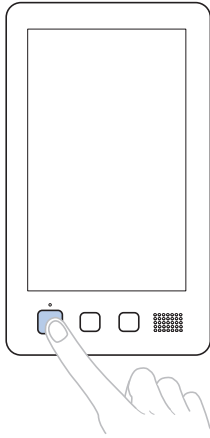

- The machine stops and the start/stop button lights up in red.
- Embroidering can also be stopped by touching an area displaying the pattern.
 - The thread is not trimmed.
 - To continue sewing, after checking that the upper thread is taut, touch the unlock key, and then press the start/stop button.



Memo

- If the Reserve Stop key is touched while embroidery is being sewn, the machine stops sewing before the next color begins. (Refer to “Stopping the machine at the next color change” on page 117.)
- Before starting to sew, the machine can be set to stop at any thread color change. (Refer to “Specifying pause locations before embroidering” on page 118.)

■ Resume sewing after the machine was turned off

1 Press the start/stop button.

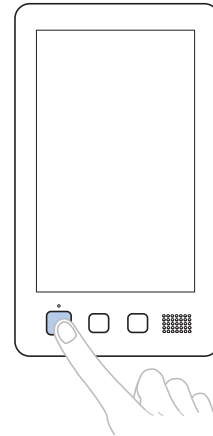

- The embroidery machine stops and the start/stop button lights up in red.
- The thread is not trimmed.

2 Touch to unlock the embroidery machine.

3 Press the thread trimming button.

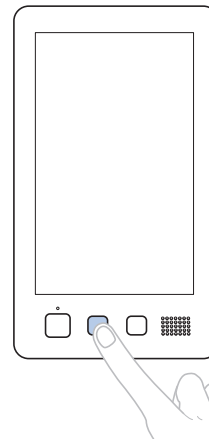

- The bobbin and upper threads are trimmed.
- Before turning off the embroidery machine, be sure to trim the threads.

4 Set the main power switch to “0”.

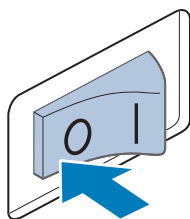

- The embroidery machine is turned off and the display and the start/stop button indicator go off.
- Sewing can resume after the embroidery machine is turned on again. Back up several stitches to overlap the stitching. (Refer to “Resume Embroidering After Turning Off the Machine” on page 101 for details.)

Memo

- The machine can be stopped at any time, even while it is embroidering; however, if the machine is stopped when the thread color is changed, it is not necessary to go back through the stitching when embroidering is continued. The machine can be set to stop when the thread color is changed. (For details, refer to “Specifying pause locations before embroidering” on page 118.)

■ If the thread breaks while sewing

If a problem occurs while sewing, such as if the thread breaks, the machine stops automatically. Re-thread the broken thread, back up several stitches, and then continue sewing. (Refer to “If the Thread Breaks or the Bobbin Thread Runs Out While Embroidering” on page 97 for details.)

12. Removing the Embroidery Frame and Fabric

After sewing is finished, remove the embroidery frame, and then remove the fabric from the frame.

Removing the embroidery frame

CAUTION

- When removing the embroidery frame, make sure that the start/stop button is lit in red. If the start/stop button is flashing in green, the machine may start sewing. If the machine accidentally starts operating, injuries may result.
- When removing the embroidery frame, be careful that the embroidery frame does not hit any other part of the machine.
- Do not lift up the embroidery frame holder with extreme force, otherwise it may be damaged.

1 With both hands, grab the left and right sides of the arms of the embroidery frame holder, and then slightly lift up the frame.

The pins on the arms of the embroidery frame holder should come out of the holes in the sides of embroidery frame.

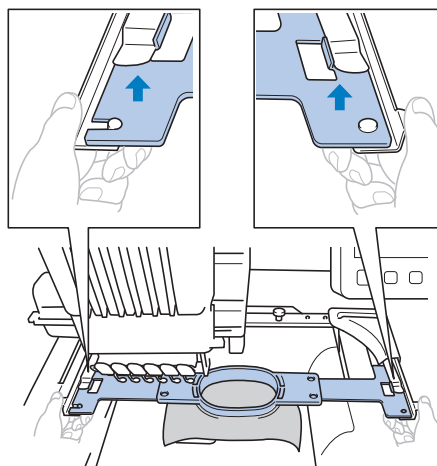

- 2** Pull off the embroidery frame toward you.

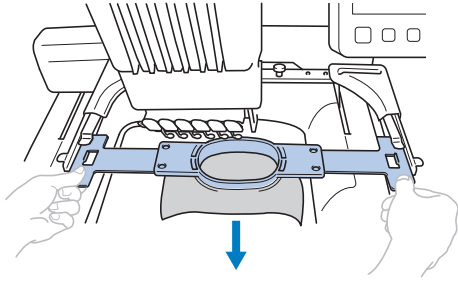

Removing the fabric

- 1** Loosen the outer frame screw.

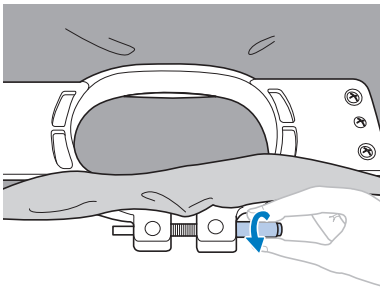

→ If the screw was tightened using a disc-shaped screwdriver, use the included disc-shaped screwdriver to loosen it.

- 2** Remove the outer frame, and then remove the fabric.

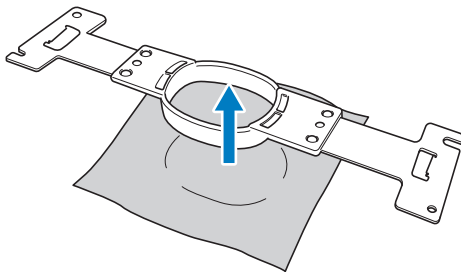

13. Turning OFF the Machine

After all embroidery is finished, turn off the machine.

- 1** Set the main power switch to “O”.

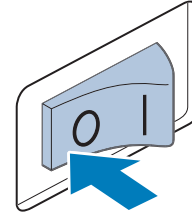

→ The embroidery machine is turned off and the display and the start/stop button indicator goes off.

- 2** Unplug the power supply cord from the electrical outlet.

Grasp the plug when unplugging the power supply cord.

- 3** If necessary, unplug the power supply cord from the machine.

Store the power supply cord in a safe place.

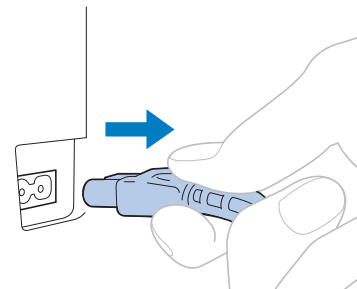

Note

- If a power outage occurs while the embroidery machine is being operated, turn off the embroidery machine and unplug the power supply cord. When restarting the embroidery machine, follow the necessary procedure to correctly operate the machine. (Refer to “2. Turning ON the Machine” on page 35.)

 **Memo**

- If the machine is turned off while it is sewing, embroidering can continue when the machine is turned on again. (Refer to “Resume Embroidering After Turning Off the Machine” on page 101.)

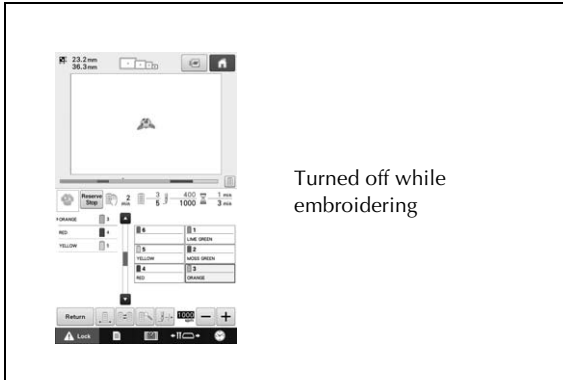

Turned on

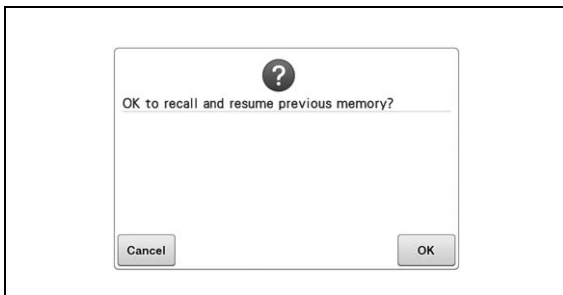



Screen Quick Reference Guide

Descriptions of the keys and other information that appear in the screens are provided in the tables below.

Key displays

The appearances of the keys have the following meanings, all keys work in the same manner.







Example:

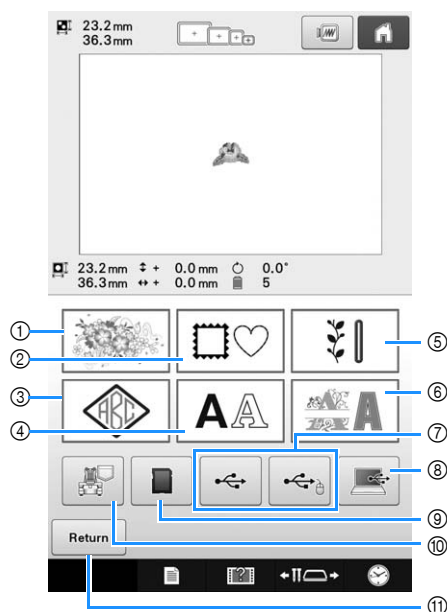



-  (Normal color display) : This key is not selected, but can be selected.
-  (Dark-colored display) : This key is selected.
-  (Gray display) : This key cannot be selected.

Understanding the pattern type selection screen

In this screen, select a pattern category (type).



No.	Display Key Name	Function	Page
①	 Embroidery pattern key	The embroidery pattern for a design can be selected.	p.125
②	 Frame pattern key	14 stitch types can be combined with 10 frame shapes, such as a circle and a square.	p.126
③	 Monogram and frame key	Monogram designs can be created by combining two or three letters.	p.127
④	 Alphabet key	Built-in patterns Uppercase and lowercase letters, numbers, symbols and accented characters from 37 fonts can be selected in small, medium and large sizes. Japanese fonts can be selected in large and small sizes.	p.130
⑤	 Utility embroidery pattern/Large buttonhole pattern key		Various utility embroidery patterns and large buttonhole patterns can be selected. Large buttonhole patterns can be selected from small, medium and large sizes.
⑥	 Decorative alphabet key	Various character patterns, such as floral characters, appliqué characters and so on, can be selected.	p.133

No.	Display Key Name	Function	Page
⑦	 USB media keys	Recalls patterns from USB media.	p.138
⑧	 Computer (USB) key	By using the included USB cable to connect a computer to the embroidery machine, patterns can be recalled from the computer.	p.139
⑨	 SD card key	Recalls patterns from SD cards.	p.138
⑩	 Embroidery patterns stored in the machine memory key	Recalls patterns stored in the machine's memory.	p.137
⑪	 Return key	This key is not displayed unless a pattern is selected. Touch this key to quit trying to add another pattern from the pattern type selection screen. Return to the pattern editing screen.	p.146

Understanding the pattern list screen

In this screen, select the pattern.

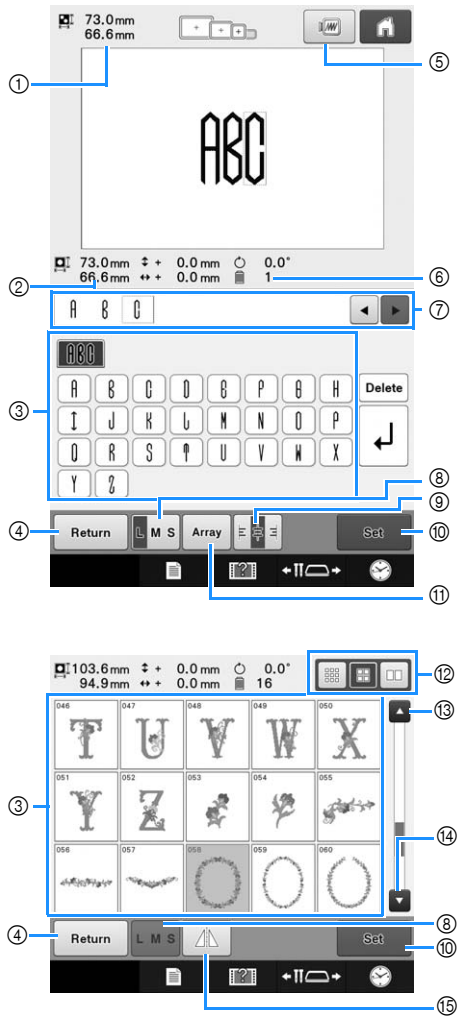

No.	Display Key Name	Function	Page
①		Shows the size of the embroidery pattern currently displayed in the pattern display area. The top value shows the height and the bottom value shows the width. If the embroidery pattern consists of multiple patterns that have been combined, the size of the entire pattern, including all patterns, is shown.	-
	Size		
②		Shows the size of the pattern selected when its pattern key is touched. The top value shows the height and the bottom value shows the width.	-
	Size		
③		An image of the pattern appears on the key. Touch the image to select the pattern. Drag your finger up and down in this area to scroll through the pages.	p.124
	Pattern keys		

No.	Display Key Name	Function	Page
④		Touch to leave the currently selected pattern category and choose a different category. Returns to the pattern type selection screen.	p.124
	Return key		
⑤		Displays an image of the pattern that is to be embroidered so it can be previewed.	p.41
	Preview key		
⑥		Shows the number of thread colors for the currently selected embroidery pattern.	-
	Number of thread colors		
⑦		The character information of an entered character pattern can be checked here. Since characters will be entered after the red cursor, use and to change the input position.	p.132
	Text preview area		
⑧		Allows the size of the currently selected embroidery pattern to be changed.	p.131
	Size key		
⑨		Touch to select a left, center or right alignment for a paragraph of a multi-line character pattern.	p.133
	Text alignment key		
⑩		Touch after selecting the pattern. The selection of the pattern is confirmed and the pattern editing screen appears.	p.125
	Set key		
⑪		Touch this key to change the configuration of a character pattern.	p.132
	Array key		
⑫		The size of the pattern thumbnails can be set to large, medium or small.	p.125
	Thumbnail size selection key		
⑬		Touch this key to display the previous page.	p.125
	Previous page key		
⑭		Touch this key to display the next page.	p.125
	Next page key		
⑮		Flips the pattern being selected horizontally.	p.149
	Horizontal mirror image key		

* Some patterns cannot be edited with ⑧, ⑨, ⑪ or ⑮.

Understanding the pattern editing screen

In the pattern editing screen, patterns can be individually edited. (The entire pattern cannot be edited from this screen.) The pattern selected in the pattern display area can be repositioned, resized, rotated and rearranged, and its color scheme can be changed. In addition, multiple patterns can be selected and combined. Entered character patterns can also be edited in various ways.

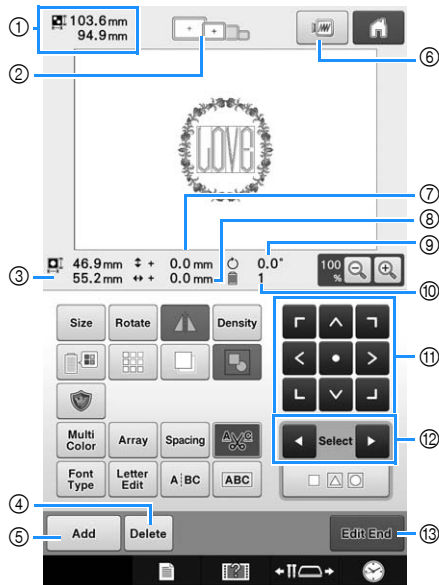

No.	Display Key Name	Function	Page
①	 Pattern size	Shows the size of the embroidery pattern currently displayed in the pattern display area. The top value shows the height and the bottom value shows the width. If the embroidery pattern consists of multiple patterns that have been combined, the size of the entire pattern, including all patterns, is shown.	—
②	 Embroidery frame indicators	Shows the sizes of embroidery frames that can be used to sew the embroidery pattern currently displayed in the pattern display area.	p.42
③	 Size	Shows the size of the pattern being edited. The top value shows the height and the bottom value shows the width.	—
④	 Delete key	Deletes the pattern. If touched, the pattern being edited is deleted.	p.171
⑤	 Add key	Adds a pattern. If touched, the pattern group selection screen appears.	p.146
⑥	 Preview key	Displays an image of the pattern so that it can be previewed.	p.41
⑦	 Distance from center (vertical)	Shows the vertical distance that the pattern being edited is moved.	p.148

No.	Display Key Name	Function	Page
⑧	 Distance from center (horizontal)	Shows the horizontal distance that the pattern being edited is moved.	p.148
⑨	 Rotation angle	Shows the rotation angle that the pattern being edited is rotated.	p.152
⑩	 Number of thread colors	Shows the total number of thread colors for the pattern that is being edited.	—
⑪	 Positioning keys	Moves the sewing position of the pattern that is being edited in the direction of the arrow. (If is touched, the sewing position is moved to the center of the embroidering area.)	p.148
⑫	 Pattern selection keys	Selects the pattern that is being edited when the embroidery pattern consists of multiple patterns that have been combined.	p.147
⑬	 Edit End key	Finish editing and continue to the embroidering settings screen.	p.46

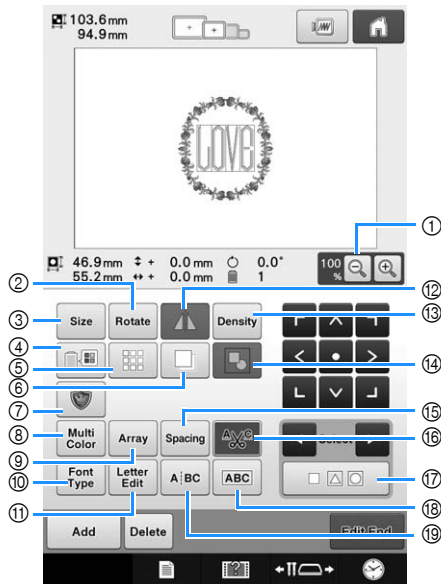





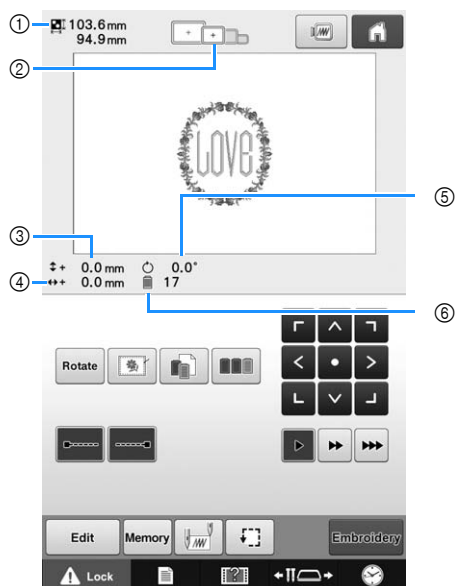

No.	Display Key Name	Function	Page
①	Enlarge key	Select from 100%, 125%, 150% or 200% to adjust how the pattern being edited is displayed.	p.146
②	Rotate key	Rotates the pattern that is being edited.	p.152
③	Size key	Changes the size of the pattern that is being edited.	p.150
④	Change thread color key	Changes the color of the pattern.	p.157
⑤	Border key	Makes and edits a repeating pattern.	p.162
⑥	Duplicate key	Duplicates the pattern.	p.171
⑦	Embroidery Appliqué key	Touch to change the pattern being edited into an appliqué pattern.	p.106
⑧	Multi Color key	Enables the thread color of each character in an alphabet pattern to be changed; can only be used when an alphabet is selected.	p.156
⑨	Array key	Changes the orientation of the characters in the alphabet pattern that is being edited.	p.153
⑩	Font Type key	Touch to change the font of the character pattern being edited.	p.156
⑪	Letter Edit key	Touch to change the size and font of individual characters in the character pattern being edited.	p.156

No.	Display Key Name	Function	Page
⑫	Horizontal mirror image key	Flips the pattern being edited horizontally.	p.149
⑬	Density key	Changes the density of the pattern that is being edited; can only be used if an alphabet or frame pattern is selected.	p.157
⑭	Grouping key	Touch to group the multiple selected patterns.	p.148
⑮	Spacing key	Changes the spacing between the characters in the character pattern that is being edited.	p.153
⑯	Thread trim setting key	Automatically trim any excess thread jumps within the letters of alphabet pattern.	p.155
⑰	Multiple selection key	Touch to select multiple patterns.	p.147
⑱	Text combining key	Touch to group the selected character patterns.	p.155
⑲	Text dividing key	Touch to ungroup the selected character pattern.	p.154

Understanding the embroidering settings screen

From this screen, the entire pattern can be edited and embroidering settings can be specified. In addition, the embroidering position can be checked and a pattern can be saved for later use. Keys available in this screen differ when you set “Manual Color Sequence” to “ON” in settings screen. (Refer to page 70 and 108.)



No.	Display	Function	Page
	Key Name		
①	 103.6mm 94.9mm Pattern size	Shows the size of the embroidery pattern currently displayed in the pattern display area. The top value shows the height and the bottom value shows the width. If the embroidery pattern consists of multiple patterns that have been combined, the size of the entire pattern, including all patterns, is shown.	—
②	 Embroidery frame indicators	Shows the sizes of embroidery frames that can be used to sew the embroidery pattern currently displayed in the pattern display area.	p.42
③	 0.0 mm Distance from center (vertical)	Shows the vertical distance that the pattern being combined/edited is moved.	p.89
④	 0.0 mm Distance from center (horizontal)	Shows the horizontal distance that the pattern being combined/edited is moved.	p.89
⑤	 0.0° Rotation angle	Shows the rotation angle that the pattern being edited is rotated.	p.91 p.172
⑥	 17 Number of thread colors changes	Shows the total number of thread colors for the pattern that is being edited.	—

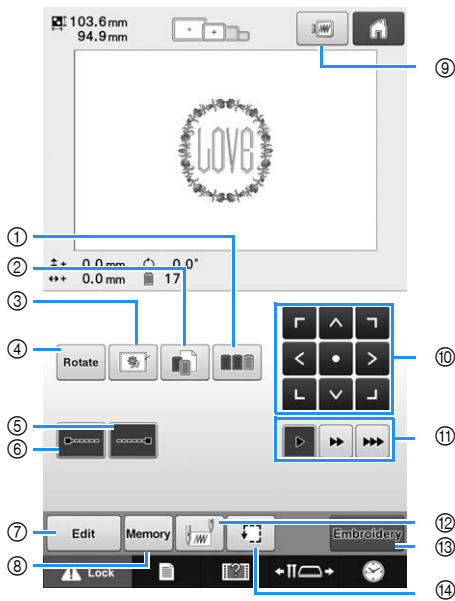



No.	Display Key Name	Function	Page
①	Color sorting key	Specifies that the sewing sequence for multiple patterns that have been combined be rearranged by thread color.	p.162
②	Individual region setting key	Touch to change the setting the thread color individually, for example, pause function or deselect region function.	p.118 p.110
③	Embroidery basting key	When stabilizer material is not affixed to the fabric, sew basting stitches along the outline of the pattern to minimize shrinkage of the stitching and misaligned patterns.	p.105
④	Rotate key	Rotates the entire embroidery pattern when it consists of multiple patterns that have been combined.	p.91 p.172
⑤	Lock stitching (end) key	Specifies that automatic lock stitch is sewn when the thread is trimmed.	p.112
⑥	Lock stitching (beginning) key	Specifies that automatic lock stitch is sewn at the beginning of the pattern and at the beginning of sewing after thread trimming.	p.112
⑦	Edit key	Touch to return to the pattern editing screen.	-
⑧	Memory key	Save a pattern in the machine's memory, USB media or a computer.	p.135 p.136
⑨	Preview key	Displays an image of the pattern that is to be embroidered so it can be previewed.	p.41

No.	Display Key Name	Function	Page
⑩	Positioning keys	Moves the sewing position of the whole pattern in the direction of the arrow. (If is touched, the sewing position is moved to the center of the embroidering area.)	p.89
⑪	Frame movement speed keys	Selects the speed to move the frame. Touch to move the frame by 0.1 mm. Touch to move the frame by 0.5 mm. Keep touching to move the frame at maximum speed.	p.89
⑫	Starting/ending position key	Specifies the needle position at the beginning of sewing and at the end.	p.113
⑬	Embroidery key	Finish all operations in the embroidering settings screen and continues to the embroidering screen.	p.48
⑭	Trial sewing key	Moves the embroidery frame so that the embroidering position can be checked.	p.47

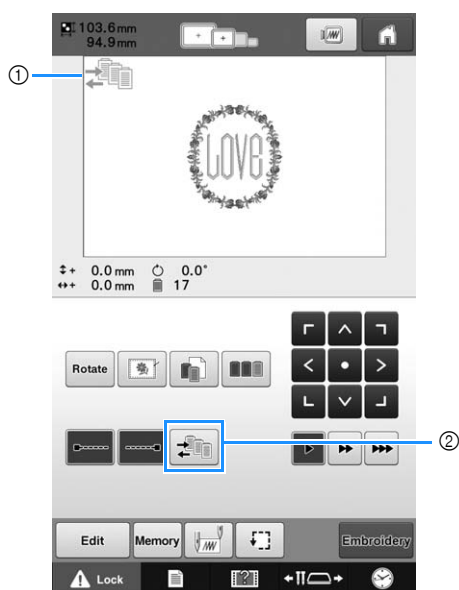
■ In the “Manual Color Sequence” mode









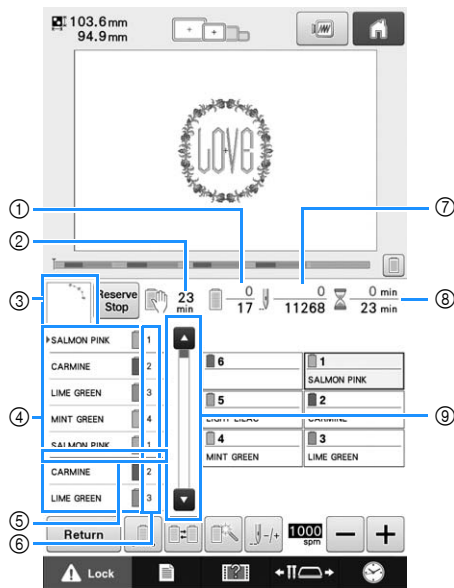



No.	Display	Function	Page
	Key Name		
①	 Manual color sequence mode icon	This illustration appears when the sewing machine is in the “Manual Color Sequence” mode.	p.108
②	 Manual color sequence key	Touch to change the needle bar color setting. This key appears when you set “Manual Color Sequence” to “ON” in settings screen.	p.109

Understanding the embroidering screen

From this screen, the total number of thread colors and the sewing time can be checked, the needle bar settings can be specified, and the needle placement forward or backward can be done. Keys available in this screen differ when you set “Manual Color Sequence” to “ON” in settings screen. (Refer to page 108.)



No.	Display Key Name	Function	Page
①	 17	The bottom value shows the total number of thread colors in the pattern and the top value shows the thread colors that is currently being sewn.	-
	Sewing order		
②	 23 min	Shows the amount of time until the machine will stop. When the last thread spool is being sewn, the number appears in red. If the thread color needs to be changed, this shows the time until the thread spool will need to be changed.	p.94
	Time until the machine stops		
③		Shows the part of the pattern that will be sewn with the thread color shown first in the thread color sequence display.	-
	Region display		
④		Shows the order for the thread color changes. During embroidering, this display scrolls automatically so that the color of the thread currently being sewn appears at the top.	-
	Thread color sequence display		
⑤		This red line indicator shows when the thread spools will need to be changed. The thread spools will need to be changed at the point between the two thread colors where the indicator is displayed.	p.95
	Spool change indicator		

No.	Display Key Name	Function	Page
⑥	 1 2 3	Indicates the needle bar number where the thread color at the left is assigned.	-
	Needle bar number		
⑦	 0 11268	The bottom value shows the total number of stitches in the pattern and the top value shows how many stitches have already been sewn.	-
	Stitch count		
⑧	 0 min 23 min	The bottom value shows the total amount of time required to sew the pattern and the top value shows how much time has already passed sewing.	-
	Sewing time		
⑨		The thread color sequence display shows the first seven thread colors. To check the sequence for the eighth and later thread colors, touch  or  , or touch the scroll bar.	-
	Scroll bar		

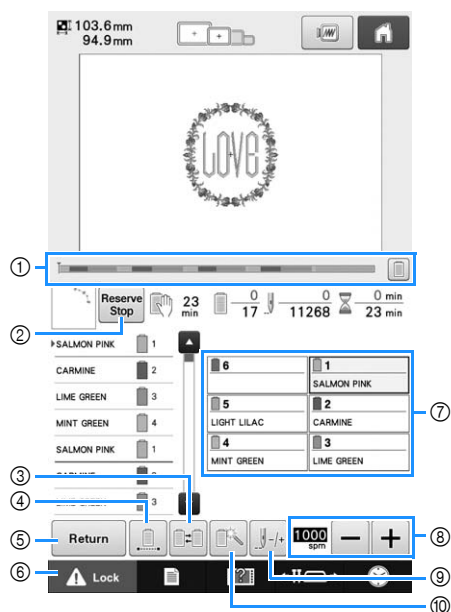

No.	Display	Function	Page
	Key Name		
①	Progress bar	The embroidering progress is shown by the red mark in the indicator. Touch to display (in the indicator) only the thread color being embroidered.	-
②	Reserve Stop key	While sewing embroidery, touch this key for the machine to stop prior to the next color beginning.	p.117
③	Switch spool key (Not available in the "Manual Color Sequence" mode)	Change the needle bar settings from the screen without changing the thread spools on the machine.	p.93
④	Uninterrupted embroidery key/ Monochrome	Touch to sew the pattern in the same color, regardless of specified color changes. The entire thread color sequence display will appear in the same color. The progress bar ① and thread color setup display ⑦ will show the original colors.	p.119
⑤	Return key	Touch this key to quit sewing and return to the embroidering settings screen.	-
⑥	Lock key	Unlocks the machine so it can start sewing within 10 seconds. When this key is touched, the start/stop button flashes in green.	p.57

No.	Display	Function	Page
	Key Name		
⑦	Needle bar key	Touch a key to move the needle bar position to the selected needle bar number. Use when threading the needle with the automatic needle-threading mechanism.	-
	Thread color set up display	Shows the color and the thread color name (number) for the thread on the needle bar indicated on the key. Thread the machine as indicated here.	p.48
⑧	Maximum sewing speed key	Specifies the maximum sewing speed.	p.116
⑨	Forward/Backward stitch key	Moves the needle forward or backward through the stitching. Use this key in the following situations: <ul style="list-style-type: none"> • If the thread breaks or runs out while embroidering • To restart sewing from the beginning • To continue sewing after the machine was turned off 	p.97
	Temporary needle bar settings key	Enables the needle bar settings to manually be specified.	p.119



Memo

- The thread color numbers in the thread color sequence display and the thread color set up display can be changed, for example, to the color name or the thread color number for other brands. (Refer to "Changing the thread color information" on page 182.)

When You Have a Question, This May Help You

Technical terms:

■ DST

This is the extension of Tajima data file (*.dst) that is one of the data formats of embroidery patterns. Tajima data does not contain color information, therefore the embroidery machine automatically assigns colors when a Tajima (.dst) file is loaded. (Refer to page 200.)

■ Needle number

The needles are numbered from right to left. The far right needle is number 1 needle. (Refer to page 7.)

■ Needle at the “embroidering position”

This is the needle that is placed above the needle hole in the needle plate. The needle bar case is moved to position that particular needle with the next thread color to the “embroidering position”. Also when using the needle threader, the needle that is going to be threaded should be moved to the “position of embroidery”. (Refer to page 55 and page 56.)

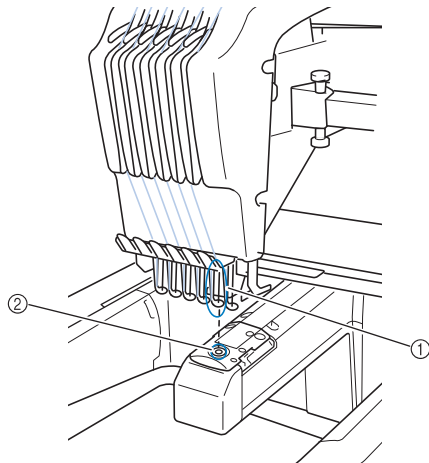

- ① Needle
- ② Needle hole in the needle plate

■ Wiper

This is the mechanism for pulling the thread. The wiper pulls the thread when the needle threader is used.

The wiper also pulls the thread from the material when the machine trims the thread. This makes trimming threads after embroidering unnecessary. (Refer to page 55.)

Patterns:

Following patterns can be processed by the machine to embroider.

- Use USB media or SD cards to transfer the embroidery data with *.pen, *.pes, *.phc or *.dst format to the machine. Using the USB cable, the data can be transferred from the PC to the machine.
- Optional embroidery cards
- Embroidery patterns created by digitizing software program
- The patterns saved on USB media or SD cards by the machine

Embroidering:

■ Customize the embroidery colors

- Use the thread color function by selecting either 64 colors or 300 colors, or by setting the custom thread color table on the pattern editing screen. For more details, see page 167 and page 169.
- Use the manual color sequence function in the embroidering settings screen. For more details, see page 108.
- Use the “Temporary needle bar setting” function by selecting the key on the “Embroidering” screen. More details please see the page 119.

■ Resume an unfinished pattern from the last time the machine was switched off.

- The machine remembers the pattern and the position even after turning off the power. And the machine can resume the embroidery when the machine turns on again. (Refer to “Resume Embroidering After Turning Off the Machine” on page 101.)

■ Getting false thread breakage error

- Check that the position of the upper thread is under the upper thread guide plates. (Refer to page 50.)
- Check that the position of the upper thread is around the thread tension disc. (Refer to page 52.)
- Check that no lint or dust has accumulated in the thread tension disc. If it has, remove it. (Refer to “Cleaning the thread paths of the upper threads” on page 213.)

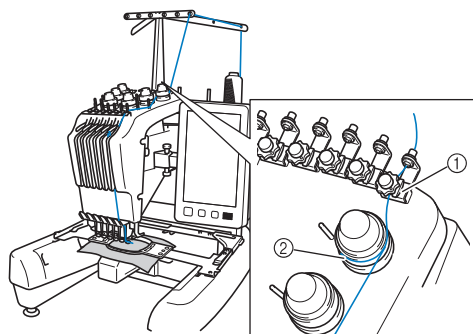

- ① Upper thread guide plates
- ② Thread tension disc

■ Thread tension changed suddenly

- Thread is caught on a rough edge of the spool of upper thread.
- Upper thread is caught under the spool of thread.
- The thread dust or lint is gathered under the bobbin's tension spring.
- Check that no lint or dust has accumulated in the thread tension disc. If it has, remove it. (Refer to “Cleaning the thread paths of the upper threads” on page 213.)

■ The embroidery frame becomes separated from the carriage

Make sure that the positioning pins are placed into the frame's positioning slot and hole. (Refer to page 45.)

To insure proper registration of pattern for embroidery, turning off the machine and turning it back on will allow the embroidery arm to reset its registration points.

■ Unable to detach the frame from the machine

Touch  and  to move the carriage, then the frame will be detachable. (Refer to page 81.)

■ Cancel the current design and start again

Select the “Home” key on the upper right of the screen. The pattern and all information will be deleted. (Refer to page 36.)

Useful external connection functions

You can access various patterns by using the machine's USB port and SD card slot.

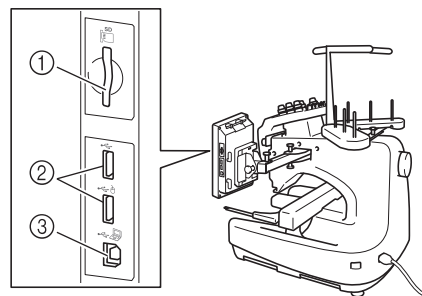

- ① SD card slot
- ② USB ports for media (USB 2.0)
- ③ USB port for computer



Note

- Do not insert anything other than USB media into the USB media port. Otherwise, the USB media drive may be damaged.

■ Using SD cards

When using SD cards to import or export pattern data, insert the card into the SD card slot.

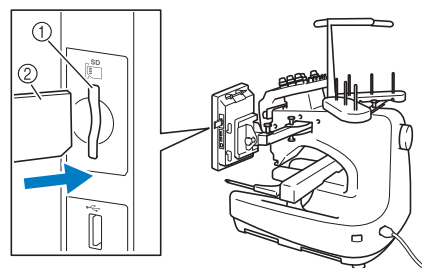

- ① SD card slot
- ② SD card

■ Using USB media

When sending or reading patterns using the USB media, connect the device to the USB port.

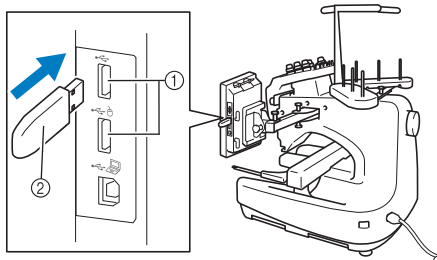

- ① USB ports
- ② USB media



Note

- The processing speed may vary by quantity of data.
- Do not insert anything other than USB media into the USB media port. Otherwise, the USB media drive may be damaged.



Memo

- USB media is widely used, however some USB media may not be usable with this machine. Please visit our website (<http://s.brother/cpbac>) for more details.
- Depending on the type of USB media being used, either directly plug the USB device into the machine's USB port or plug the USB media Reader/Writer into the machine's USB port.

■ Connecting the machine to the computer

Using the included USB cable, the sewing machine can be connected to your computer.

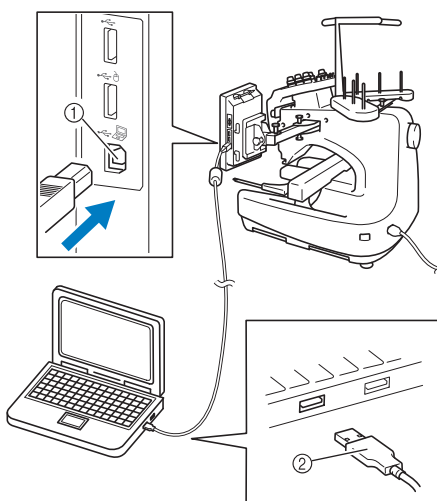

- ① USB port for computer
- ② USB cable connector



Note

- The connectors on the USB cable can only be inserted into a port in one direction. If it is difficult to insert the connector, do not insert it with force. Check the orientation of the connector.
- For details on the position of the USB port on the computer (or USB hub), refer to the instruction manual for the corresponding equipment.

■ Using a USB mouse

The USB mouse, connected to the sewing machine, can be used to perform a variety of operations in the screens.

Connect a USB mouse to the USB port marked with . You can also connect a USB mouse to the other USB port.

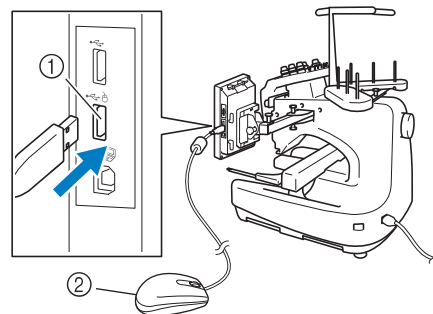

- ① USB port marked with 
- ② USB mouse



Note

- Do not perform operations with the mouse at the same time that you are touching the screen with your finger or the included touch pen.
- A USB mouse can be connected or disconnected at any time.
- Only the left mouse button and its wheel can be used to perform operations. No other buttons can be used.
- The mouse pointer does not appear in the screen saver.

USB mouse operation

■ Clicking a key

When the mouse is connected, the pointer appears on the screen. Move the mouse to position the pointer over the desired key, and then click the left mouse button.

Memo

- Double-clicking has no effect.



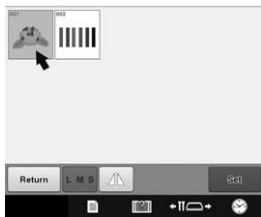
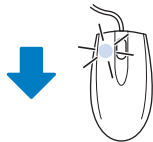

① Pointer



■ Changing pages

Rotate the mouse wheel to switch through the tabs of the pattern selection screens.

Memo

- If page numbers and a vertical scroll bar for additional pages are displayed, rotate the mouse wheel or click the left mouse button with the pointer on  /  to display the previous or next page.

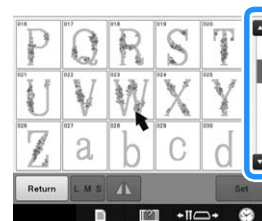
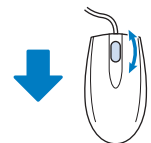
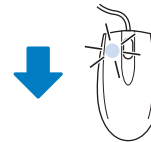
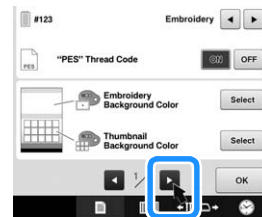



■ Changing the size

Refer to “Changing the size of a pattern (Normal resizing mode)” on page 150.

1 Touch **Size**.

2 Change the size of the pattern.

- Rotate the mouse wheel away from you to shrink the pattern in the same way as when  is touched.
- Rotate the mouse wheel toward you to enlarge the pattern in the same way as when  is touched.

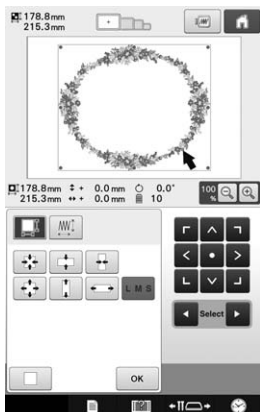
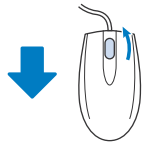
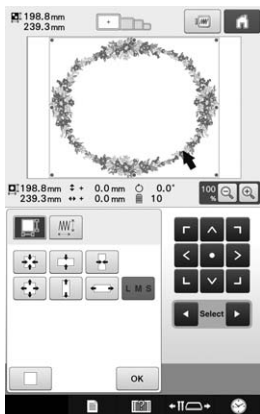



■ Rotating the pattern

Refer to “Adjusting the angle” on page 91 and “Rotating a pattern” on page 152.

1 Touch **Rotate**.

2 Rotate the pattern.

- Rotate the mouse wheel away from you to rotate the pattern 10 degrees to the left in the same way as when  is touched.
- Rotate the mouse wheel toward you to rotate the pattern 10 degrees to the right in the same way as when  is touched.

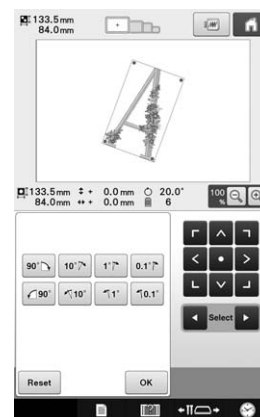
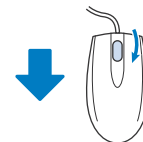
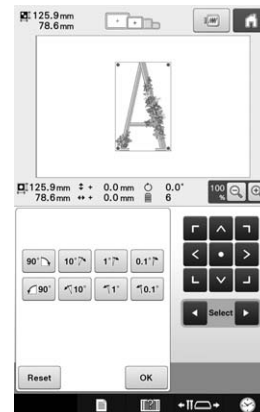

This chapter provides explanations on operations other than those described in chapter 2, such as sewing a pattern with seven or more colors, changing the needles and changing thread spools.

Changing the Needle

If the needle is bent or the tip of the needle is broken, replace the needle with a new one. Use the included Allen screw driver to replace the needle with one that is designed specifically for this machine and that passes the test described in "Checking the needle" on page 30.

Replacing the needle

- 1 Turn off the embroidery machine.

⚠ CAUTION

- Be sure to turn off the embroidery machine before replacing the needle, otherwise injuries may result if the machine starts sewing.

- 2 Loosen the needle set screw and remove the needle.

Hold the needle down with your left hand, and then hold the Allen screw driver in your right hand and turn the needle set screw counterclockwise.

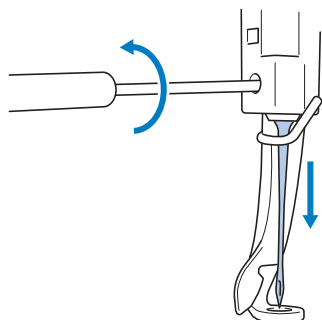

Note

- Be sure to use the included Allen screw driver to replace the needle, otherwise too much force may be applied to the needle, causing it to break.

- Do not apply extreme force when loosening or tightening the needle set screw, otherwise the machine may be damaged.

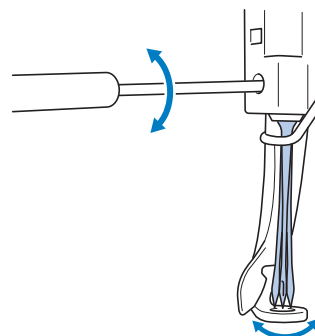

- 3 With the flat side of the needle toward the back of the machine, insert the needle all the way up until it touches the needle bar stopper.

Pass the needle through the hole in the presser foot, and then use the needle changing tool to lift up the needle.

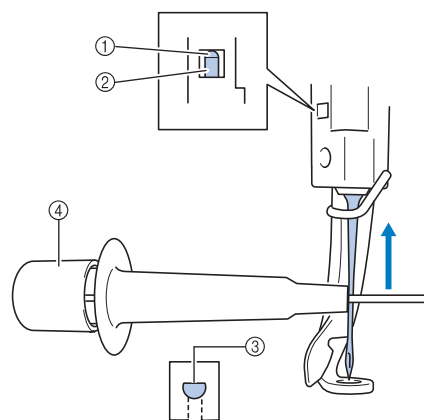

- 1 Needle bar stopper
- 2 Needle
- 3 Flat side of needle
- 4 Needle changing tool

Hold the needle changing tool and press the end of the needle changing tool ① in to extend the needle-mounting clamp ②. Attach the clamp to the needle, and then release the pressed area to clamp the needle. To unclamp the needle, press ① again.

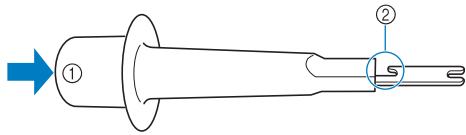

- ① End of the needle changing tool
- ② Needle mounting clamp

4 While holding the needle in place with your left hand, tighten the needle set screw.

Use the Allen screw driver to turn the needle set screw clockwise.

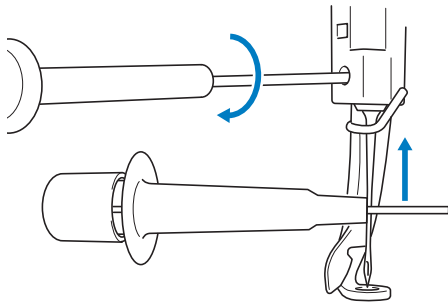

⚠ CAUTION

- Be sure to insert the needle in the needle bar chamber until it reaches the needle bar stopper and securely tighten the needle set screw with the Allen screw driver, otherwise the needle may break or the machine may be damaged.
- If the needle is not fully inserted, the hook of the automatic needle-threading mechanism will not pass through the eye of the needle during automatic needle threading, and the hook may bend or the needle cannot be threaded.
- If the hook of the automatic needle-threading mechanism is bent or damaged, contact your authorized Brother dealer.

Correctly Using the Embroidery Frames

Various types of embroidery frames can be used with this machine to suit your project. In addition to the four included embroidery frames, there are many frames that can be used with this embroidery machine. (Refer to “Optional Accessories” on page 21.)

⚠ CAUTION

- Only use embroidery frames of the sizes indicated in the screen, otherwise the embroidery frame may hit the presser foot, which may result in injuries.

Embroidery frame holders

Two types of embroidery frame holders (embroidery frame holder A and embroidery frame holder B) are included with this machine.

Embroidery frame holder A is used with the four included embroidery frames. Embroidery frame holder B is used with the optional embroidery frames. In addition, if you purchase optional round frame set, clamp frame set or compact frame set, specified frame holder C, D or E is included. For details on which embroidery frame can be installed on each embroidery frame holder, refer to “Types of embroidery frames/frame holders and their applications” on page 82.

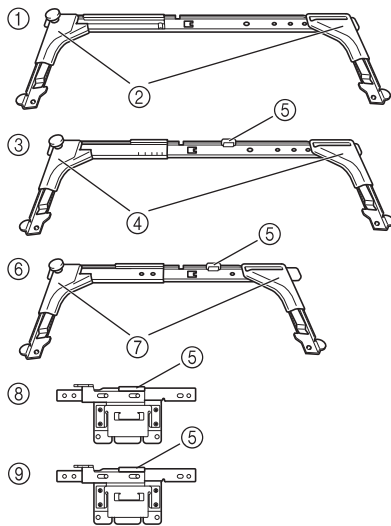

- ① Embroidery frame holder A
- ② White corner covers
- ③ Embroidery frame holder B
- ④ Light gray corner covers
- ⑤ Magnet
- ⑥ Embroidery frame holder C (optional)
- ⑦ Dark gray corner covers
- ⑧ Embroidery frame holder D (optional)
- ⑨ Embroidery frame holder E (optional)

When difficult to replace the embroidery frame

Depending on the position of the needle bars, it may be difficult to replace the embroidery frame. In that case, follow the procedure described below to move the embroidery frame.

1 Touch .

→ The needle bar move screen appears.



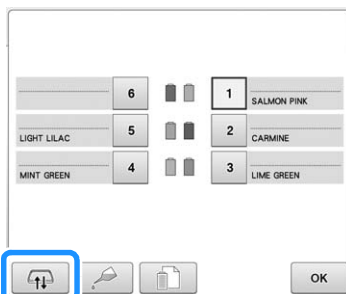







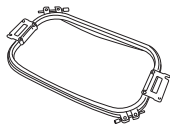



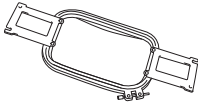



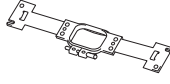

2 Touch .

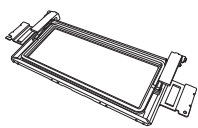

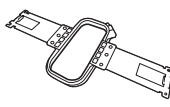







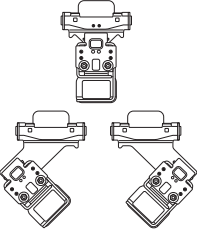

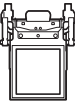

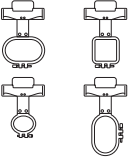
→ The carriage automatically moves to a position where the embroidery frame can easily be replaced.

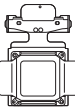
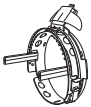
- Touch  to close the needle bar move screen and to move the carriage to the previous position.

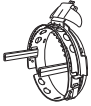
Types of embroidery frames/frame holders and their applications

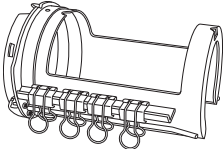
	Embroidery type	Embroidering area		Reference
			Usage	
Embroidery frame holder A	Extra-large embroidery frame 	200 mm (H) × 300 mm (W) (7-7/8 inches (H) × 11-3/4 inches (W))	 Use when embroidering connecting characters or patterns, combined patterns or large embroidery patterns.	(Refer to “Hooping the Fabric” on page 85.)
	Flat frame (optional) 	200 mm (H) × 300 mm (W) (7-7/8 inches (H) × 11-3/4 inches (W))	 Use when embroidering jackets and other thick garments.	Consult your nearest authorized Brother dealer.
	Large embroidery frame 	130 mm (H) × 180 mm (W) (5-1/8 inches (H) × 7-1/8 inches (W))	 Use when embroidering patterns with a size less than 130 mm (H) × 180 mm (W) (5-1/8 inches (H) × 7-1/8 inches (W))	(Refer to “Hooping the Fabric” on page 85.)
	Medium embroidery frame 	100 mm (H) × 100 mm (W) (4 inches (H) × 4 inches (W))	 Use when embroidering standard-sized patterns.	(Refer to “6. Hooping the Fabric in the Embroidery Frame” on page 42.)
	Small embroidery frame 	40 mm (H) × 60 mm (W) (1-1/2 inches (H) × 2-3/8 inches (W))	 Use when embroidering small-sized patterns, such as nametags.	
Embroidery frame holder B	Quilt frame (optional) 	200 mm (H) × 200 mm (W) (7-7/8 inches (H) × 7-7/8 inches (W))	 Use when embroidering pieces for quilts.	Consult your nearest authorized Brother dealer.
	Border frame (optional) 	100 mm (H) × 300 mm (W) (4 inches (H) × 11-3/4 inches (W))	 Use when embroidering a long string of characters or patterns.	
	Sleeve frame (optional) 	200 mm (H) × 70 mm (W) (7-7/8 inches (H) × 2-3/4 inches (W))	 Use when embroidering long items such as shirt sleeves.	
Embroidery frame holder C (optional)	Round frame (optional) ∅=diameter 	∅100 mm (4 inches) ∅130 mm (5 inches) ∅160 mm (6 inches)	   Use when adding a built-in embroidery pattern to a sleeve. Select the frame appropriate for the size of the pattern.	Consult your nearest authorized Brother dealer.

Embroidery type		Embroidering area		Reference
		Usage		
Embroidery frame holder D (optional)	Clamp frame S (optional)	24 mm (H) × 45 mm (W) (7/8 inches (H) × 1-3/4 inches (W))		Consult your nearest authorized Brother dealer.
		Use when embroidering specialty shaped items that cannot be held in normal frames, such as shoes and gloves.		
Embroidery frame holder E (optional)	Clamp frame M (optional)	100 mm (W) × 100 mm (H) (4 inches (H) × 4 inches (W))		Consult your nearest authorized Brother dealer.
		Use when embroidering specialty shaped items, such as narrow bags.		
Embroidery frame holder E (optional)	Compact frame (optional)	70: 41 mm (H) × 70 mm (W) (1-5/8 inches (H) × 2-3/4 inches (W)) 50: 50 mm (H) × 50 mm (W) (2 inches (H) × 2 inches (W)) 44: 38 mm (H) × 44 mm (W) (1-1/2 inches (H) × 1-3/4 inches (W)) Vertical: 33 mm (H) × 75 mm (W) (1-5/16 inches (H) × 2-15/16 inches (W))		Consult your nearest authorized Brother dealer.
		Use when embroidering logos or embroidery patterns on small items.		
Embroidery frame holder E (optional)	Magnetic frame (optional)	50 mm (H) × 50 mm (W) (2 inches (H) × 2 inches (W))		Consult your nearest authorized Brother dealer.
		Use to prevent the embroidery frame from leaving traces in the fabric.		
Advanced cap frame 2 (optional)		60 mm (H) × 130 mm (W) (2-3/8 inches (H) × 5-1/8 inches (W))		Consult your nearest authorized Brother dealer.
Advanced cap frame		50 mm (H) × 130 mm (W) (2 inches (H) × 5-1/8 inches (W))		Consult your nearest authorized Brother dealer.
Cylinder frame (optional)		80 mm (H) × 90 mm (W) (3 inches (H) × 3-1/2 inches (W))		Consult your nearest authorized Brother dealer.
		Use when embroidering tubular and curved fabric, such as shirt sleeves and turtlenecks.		

**Note**

- The embroidery frame indicators show all embroidery frame sizes in which the embroidery pattern can be sewn. Be sure to use an embroidery frame of the most suitable size. If the embroidery frame that is used is too large, the pattern may be misaligned or the fabric may pucker.
- Due to the weight of the embroidery frame and fabric it is recommended that the optional table be used, to prevent the frame holder from bending, which may result in the distortion of your design or machine damage.

Attaching Iron-On Stabilizer (Backing) to Fabric

In order to prevent shrinkage of the stitching or misaligned patterns, we recommend that iron-on stabilizer (backing) be used for embroidering.

⚠ CAUTION

- When embroidering on thin or stretch fabrics, fabrics with a coarse weave or fabrics that easily allow the stitching to shrink, be sure to use iron-on stabilizer (backing) for embroidering. If iron-on stabilizer (backing) is not used while embroidering, the needle may bend or break or the pattern may become misaligned.

- 1 Using an iron, affix the iron-on stabilizer (backing) to the back of the fabric.

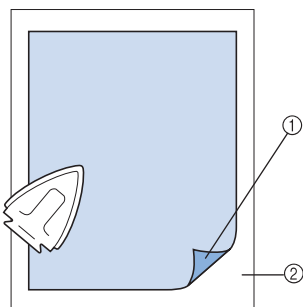

- 1 Adhesive side of iron-on stabilizer (backing)
- 2 Fabric (wrong side)

- When embroidering fabric that should not be ironed or when embroidering an area that is difficult to iron, hoop a layer of the iron-on stabilizer (backing) under the fabric in the embroidery frame without ironing it.



Note

- Use a piece of iron-on stabilizer (backing) that is larger than the embroidery frame. When framing the fabric in the embroidery frame, be sure that the stabilizer (backing) is clamped on all edges in order to prevent wrinkles in the fabric.

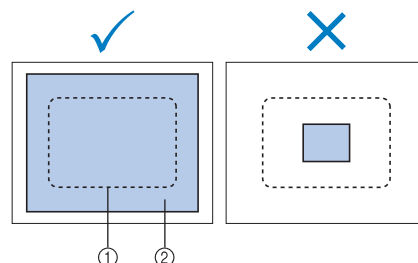

- 1 Area of embroidery frame
- 2 Iron-on stabilizer (backing)



Memo

- When embroidering thin fabrics, such as organza or lawn, use a water-soluble stabilizer (backing). Water-soluble stabilizers dissolve when washed, allowing you to create beautiful embroidery that is not stiff.
- When embroidering fabric with a nap, such as towels or corduroy, hoop a layer of iron-on stabilizer (backing) under the fabric in the embroidery frame without ironing it.
- For other uses of stabilizer (backing), refer to “Stabilizers (backing)” on page 202.

Hooping the Fabric

Hooping the fabric in the extra-large and large embroidery frames

- 1** Loosen the screw on the outer frame.

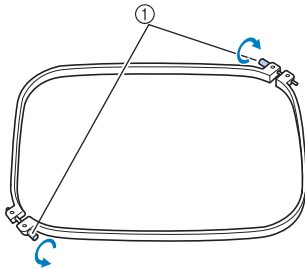

- ① Screw

- 2** Place the fabric with right side up on top of the outer frame.

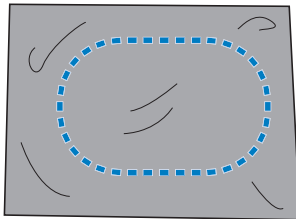

- The outer frame does not have a front or back side. Either side can be used as the front.

- 3** Press the inner frame into the outer frame.

First insert the inner frame at the corner with the screw (A), next insert the nearby one corner (B), and then insert the opposite corner (C). Then insert the opposite corner (non screw) (D).

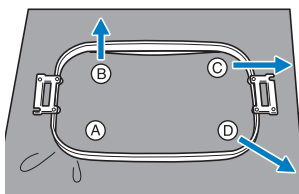

First, align the inner and outer frames at the corner with the screw (A). Then, while lightly pulling the fabric in the direction indicated by arrow (B) so that the fabric is taut, insert the inner frame at corner (B). In the same way, lightly pull the fabric in the direction indicated by arrow (C) and insert corner (C), and then lightly pull the fabric in the direction indicated by arrow (D) and insert corner (D).

- Be sure that there are no wrinkles in the fabric after it is stretched in the embroidery frame.

- 4** While stretching the fabric even more, securely tighten the screw so that the fabric is taut.

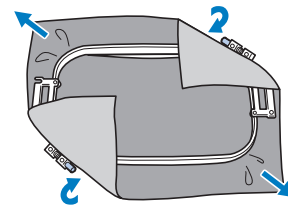

- After stretching the fabric, lightly tapping it should produce a drum-like sound.
- Firmly clamp together the inner and outer frames so that their tops are even.

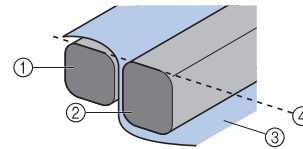

- ① Outer frame
- ② Inner frame
- ③ Right side of fabric
- ④ Top of inner and outer frames are even
- Using the included disc-shaped screwdriver, firmly tighten the screw.

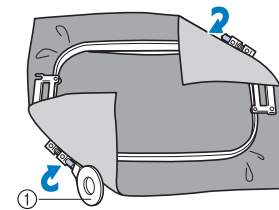

- ① Disc-shaped screwdriver

Memo

- To correctly frame the fabric in the embroidery frame, we recommend using a flat surface.
- Refer to “Hooping fabric in the small embroidery frame” on page 43 for details on hooping smaller frames.

Using the embroidery sheet

In order to hoop the fabric so that the pattern will be sewn in the correct position, use the guidelines on the embroidery sheet to accurately stretch the fabric in the frame.

- 1 With a fabric marker, mark the area of the fabric you want to embroider.

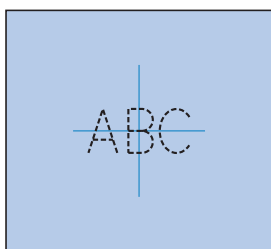

- 2 Place the embroidery sheet on the inner frame. Align the guidelines on the embroidery sheet with the marks that you drew on the fabric.

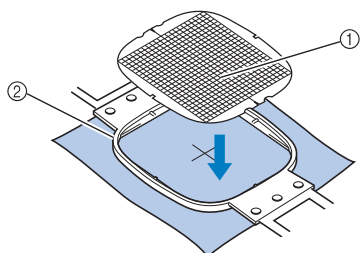

- ① Guidelines
- ② Inner frame

- 3 Gently stretch the fabric, so that there are no folds or wrinkles.

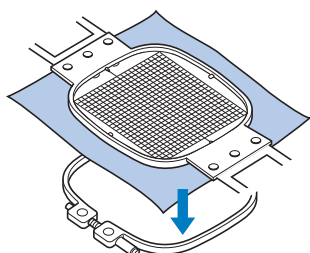

- 4 Press the inner frame into the outer frame. Remove the embroidery sheet.

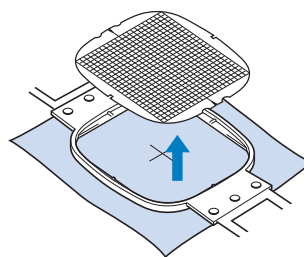

Large/small pieces of fabric

This section provides information on embroidering fabric that is either much larger or much smaller than the embroidery frame.

■ Embroidering large pieces of fabric or heavy clothing

When embroidering large pieces of fabric or heavy pieces of clothing, use a clothespin or binder clip to fasten the excess fabric to the embroidery frame so that it does not hang down from the frame. Embroidering with excess fabric hanging down from the embroidery frame may prevent the frame from moving properly and may result in a misaligned pattern.

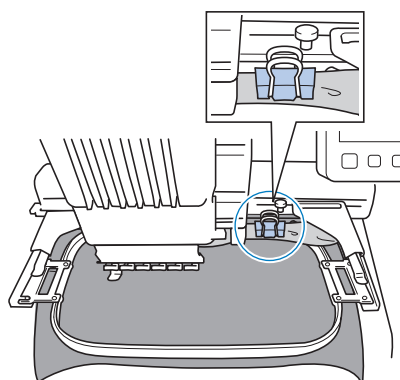

- Use a clothespin or binder clip to fasten the excess fabric to the embroidery frame.

■ Embroidering small pieces of fabric

When embroidering pieces of fabric that are smaller than the embroidery frame, use spray fabric adhesive to attach the fabric to stabilizer (backing) hooped in the embroidery frame. With fabrics where you do not wish to use spray adhesive, baste the fabric to the stabilizer (backing).

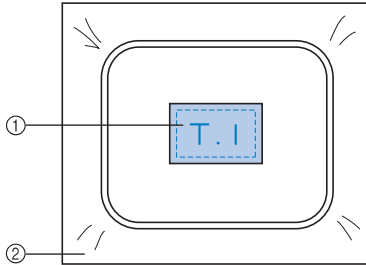

- ① Fabric
- ② Stabilizer (backing)

■ Embroidering the corner of fabric

When embroidering the corner of a piece of fabric, use spray fabric adhesive to attach the corner of the fabric to stabilizer (backing), and then hoop the stabilizer (backing) in the embroidery frame. With fabrics where you do not wish to use spray adhesive, baste the fabric to the stabilizer (backing).

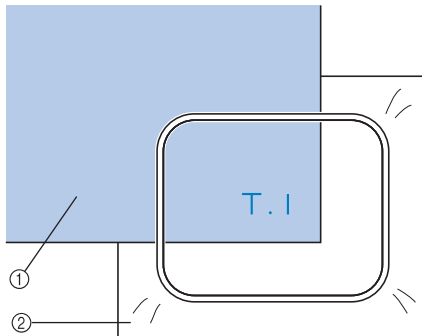

- ① Fabric
- ② Stabilizer (backing)

■ Embroidering narrow pieces of fabric, such as ribbon

When embroidering narrow pieces of fabric, use spray fabric adhesive to attach the fabric to stabilizer (backing), and then hoop the stabilizer (backing) in the embroidery frame. With fabrics where you do not wish to use spray adhesive, clamp both ends of the fabric, together with the stabilizer (backing), in the embroidery frame.

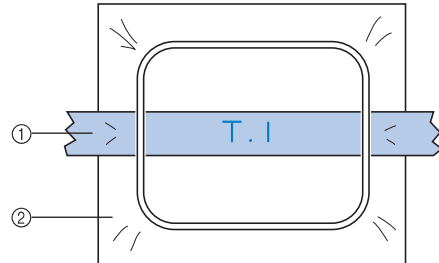

- ① Ribbon
- ② Stabilizer (backing)

Embroidery Frame Position and Movement

The following provides information concerning the embroidery frame when operating the embroidery machine.

■ Embroidery frames that cannot be used for embroidering

As explained on page 42, the embroidery frame indicators at the top of the screen show the embroidery frames that can be used to sew the currently selected pattern.

Embroidery frames with an embroidering area smaller than the pattern cannot be used. In addition, the embroidery frame cannot be used if the embroidery is smaller than the embroidering area but is positioned so that it extends out of the embroidering area of the frame.

Embroidery frames with an embroidering area smaller than the pattern

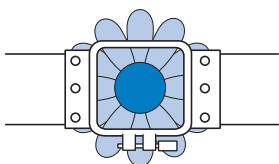

Patterns that extend out of the embroidering area of the frame

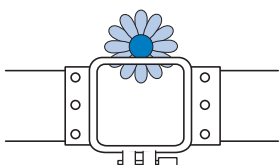

In either of these cases, a message appears on the embroidery machine, warning that the embroidery frame must be changed.

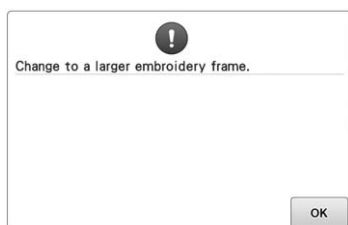

A message indicating that the embroidery frame be replaced may appear even if no embroidery frame is installed.

The embroidery machine detects which embroidery frame is installed according to the position of the left arm of the embroidery frame holder. Therefore, the embroidery frame size is determined by the position of the left arm, even if the embroidery frame is not actually installed. In addition, if the embroidery frame holder is not installed, the embroidery machine determines that the cap frame (optional) is installed.

■ Moving to the correct position

If the center of the embroidery frame is at the needle drop point in the embroidering area, the embroidery frame is correctly positioned, in other words, at the starting position before embroidering.

If the embroidery frame is changed, the next frame that is installed will not be correctly positioned. For example, if the extra-large embroidery frame is replaced with the small frame, the following will occur.

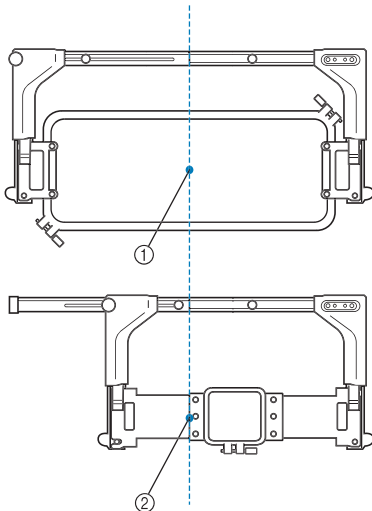

- ① Center of embroidery frame at the correct position
- ② Needle position when the embroidery frame is replaced

In order to correct the misalignment of this embroidery frame, the embroidery frame automatically moves to the correct position when any of the following is performed.

- **The embroidery machine is turned on.**
The embroidery frame will move.
- **The embroidering settings screen is displayed.**
The embroidery frame will not move if it is correctly positioned.
If the pattern extends out of the embroidering area for the frame, a message appears, indicating that the embroidery frame should be replaced. Either replace the embroidery frame or return to the pattern editing screen and move the embroidering position.
- **The embroidery frame is replaced while the embroidering settings screen or embroidering screen is displayed, and then the key for checking the embroidering area, for moving the embroidery frame, or for starting embroidering is touched.**
The embroidery frame will move.
Since the embroidery frame is moved to the correct position and paused, touch the desired key again.
If the pattern extends out of the embroidering area for the frame after the frame is moved, a message appears, indicating that the embroidery frame should be replaced. Either replace the embroidery frame or return to the pattern editing screen and adjust the pattern size or embroidering position.

Changing the Embroidering Position

When the embroidery machine is purchased, it was adjusted so that the beginning of the stitching was from the center of the pattern. Therefore, move the frame and adjust the embroidering position so that the center of the pattern aligns with the needle drop point at the sewing position. In addition, the angle of the entire pattern can be adjusted if the fabric cannot be hooped evenly within the embroidery frame and the pattern is positioned at an angle on the fabric.

- 1 Touch , or in the embroidering settings screen to select the speed.

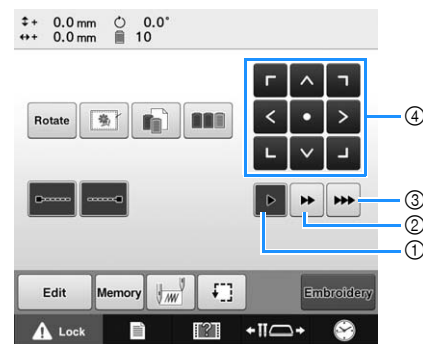

- ① Touch to move the frame by 0.1 mm.
- ② Touch to move the frame by 0.5 mm.
- ③ Keep touching to move the frame at maximum speed.
- ④ Move key

- 2 Touch in the embroidering settings screen.

Move the embroidery frame so that the needle drop point is at the center of the area where you wish to embroider.

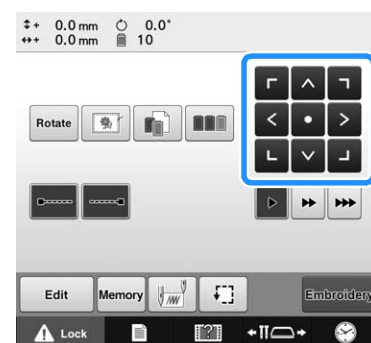

- The embroidery frame moves in the opposite direction of the arrow.
- The pattern in the pattern display area moves in the same direction of the arrow.

Memo

- If the LED pointer is set to "ON", it shows you the needle drop point.

Note

- The LED pointer may not be available depending on the type of embroidery frame attached.
- With fabric that has a very uneven or textured surface, the position of the LED pointer may not be correctly aligned. In this case, the pointer indication should be used only as a reference.

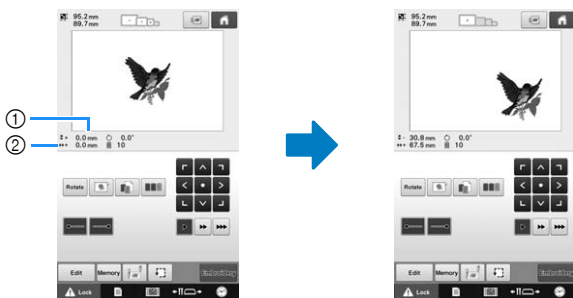

- ① Shows the vertical distance moved from center
 - ② Shows the horizontal distance moved from center
- Touch  to move the embroidery frame back to its original position (where the center of the embroidery frame is aligned with the needle drop point at the sewing position).

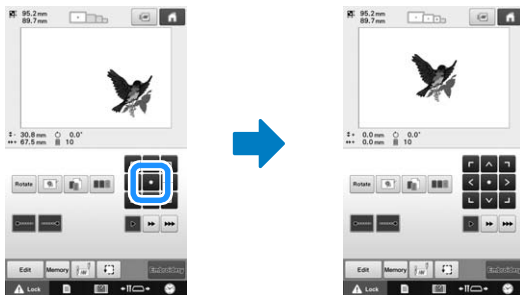

The pattern can also be moved by dragging it. If a USB mouse is connected, move the mouse to position the pointer on the desired pattern, and then while holding in the left mouse button, drag the pattern. The pattern can also be dragged by selecting it directly in the screen with your finger or the touch pen.

Finding the sewing position

By locking the needle bar (securing the needle and presser foot in the down position), the needle drop point can easily be seen.

- 1 As shown in the illustration, insert the Allen screwdriver into the hole in the needle clamp to slowly lower the needle bar down till needle bar stops then clicks into the lock position.

Note

- Make sure that the needle is not lowered beyond the positioning click into the fabric.

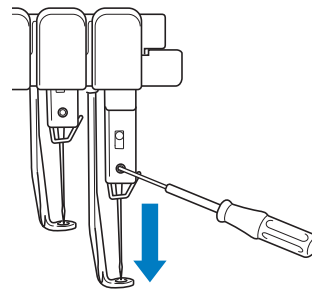

→ The needle and presser foot are locked in the down position.

- 2 Touch the arrow keys in the embroidering settings screen to move the embroidery frame so that the needle drop point is at the center of the area where you wish to embroider.

- With a USB mouse, your finger or the touch pen, drag the pattern to move it.

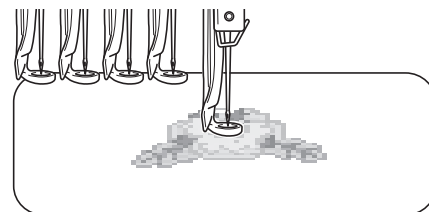

- When specifying the starting of stitching, align the needle drop point with the point specified as the starting of stitching. (For details on specifying the starting/ending of stitching, refer to page 113.)

Unlocking the needle bar

- 1 Display the embroidering screen, and then touch the key for any needle bar other than the one that is locked.

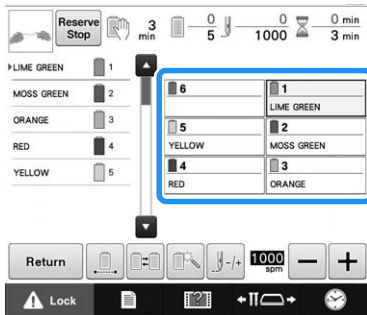

→ The needle bar is unlocked and will return to original position.

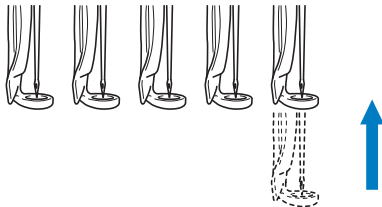

Adjusting the angle

Depending on the type of fabric being embroidered, it may not be possible to stretch the fabric in the embroidery frame at the desired angle. In this case, adjust the angle of the pattern so that it is correctly positioned on the fabric.

- 1 Touch **Rotate**.

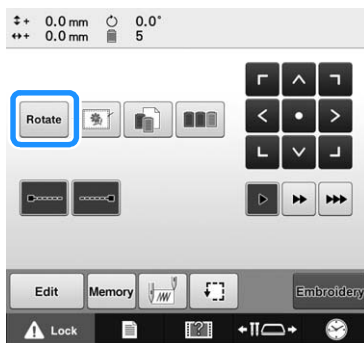

The following screen appears.

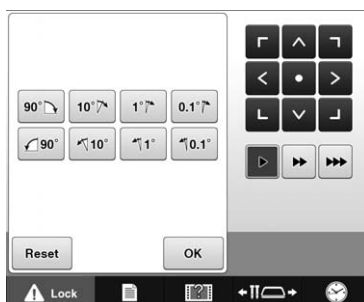

Example: Original angle



Rotates 90 degrees to the right



Rotates 10 degrees to the right



Rotates 1 degree to the right



Rotates 0.1 degree to the right



Rotates 90 degrees to the left



Rotates 10 degrees to the left



Rotates 1 degree to the left



Rotates 0.1 degree to the left



Moves the pattern in the direction of the arrow on the key.



Moves the frame by 0.1 mm.



Moves the frame by 0.5 mm.



Moves at maximum speed when a key is held down.



Touch this key to return the pattern to its original angle.



Touch this key to close this screen.

2 Touch the keys to adjust the pattern to the desired angle.

Each touch of a key rotates the pattern.

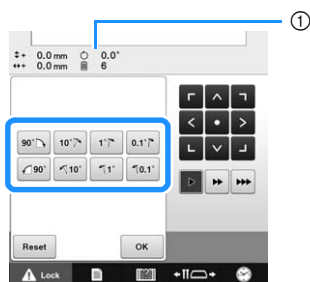

- ① Shows the angle of the pattern after a key is touched to change it.

The pattern can also be rotated by holding down and dragging a red point around the pattern.

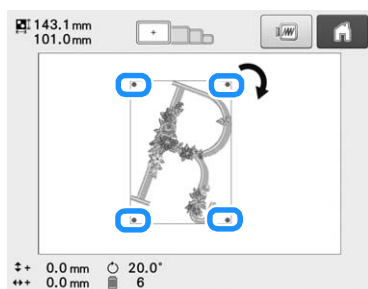

- To return the pattern to its original angle, touch



3 If necessary, touch the arrow keys to adjust the position of the pattern.

For more details, refer to page 89.

4 If necessary, touch and then touch to check the embroidering area.

For more details, refer to page 47.

5 After making the desired changes, touch .

The embroidering settings screen appears again.

Memo

- With this operation, fine adjustments can be made to the angle; also, this operation is particularly useful when embroidering items, such as bags and tubular items, that have limitations to being hooped in the embroidery frame.

Example: When embroidering a pillowcase Rotate the pattern 90 degrees to the left before embroidering.

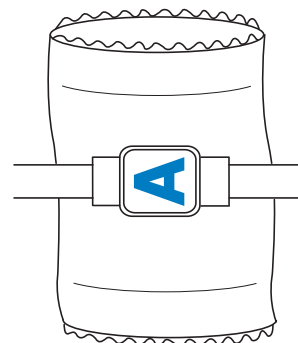

Example: When embroidering a T-shirt Rotate the pattern 180 degrees. Pass the machine bed through from the waist of the T-shirt, not from the neck, and attach the embroidery frame to the machine. This will prevent the neck of the shirt from being stretched when the embroidery frame is moving.



Switching the Thread Colors on the Screen

If a thread color on the spool stand is different than the needle position thread color on the screen, the thread colors on the screen can be switched to match the spool stand thread color position.

Memo

- This function is not available when you set "Manual Color Sequence" to "ON" in settings screen.

1 Touch  in the embroidering screen.

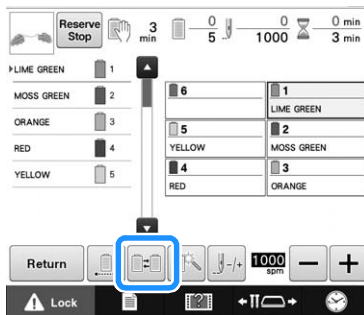

→ The spool selection screen appears.

2 Touch the number of the first needle bar that will be switched.

- To cancel the selection, touch the same needle number again.

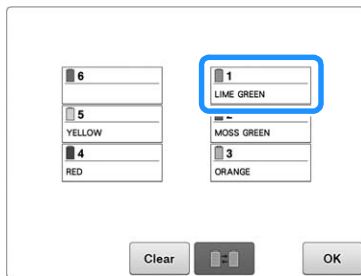

3 Touch the number of the other needle bar that will be switched. The two needle numbers are connected with an arrow.

- To cancel the selection, touch the same needle number again.

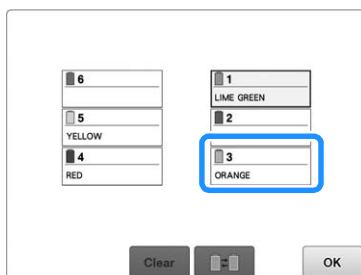

4 Touch  to switch the two thread colors.

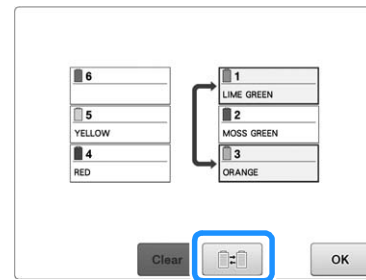

5 After making the desired changes, touch

.

■ To cancel the thread color settings for all previously stitched design

Memo

- The color settings will be completely canceled even if the machine is in the middle of the embroidery.

1 Touch .

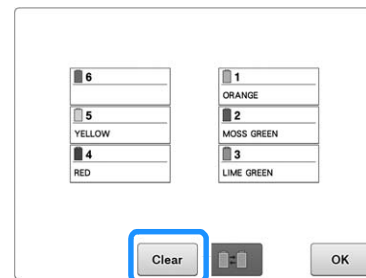

→ The thread color setting is canceled.

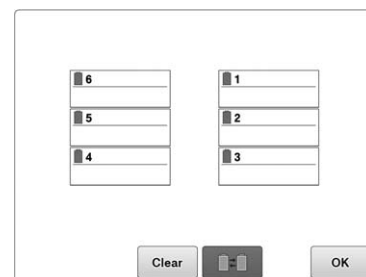

2 Touch .

→ Thread colors are assigned by the machine again, regardless of the previous spool setting.

Note

- This function will not clear anchor settings of any of the needles which have been assigned a thread color (Refer to "Reserved Needle Bar and Sewing Speed Settings" on page 120).

Embroidering a Pattern Containing Seven or More Colors

When embroidering a pattern that uses seven or more thread colors, it is necessary to change the thread spools. When changing the thread spools, instruction to change the thread spools will appear with the machine automatically stopping.



Memo

- This function is not available when you set "Manual Color Sequence" to "ON" in settings screen.

Assignment of thread colors to needle bars

Thread colors are automatically assigned by the machine to needle bars 1 to 6, starting with the thread colors that are sewn first. (However, if a new pattern has thread colors that are the same as the previously sewn pattern, the thread colors will be assigned to the same needle bar as before, regardless of the sewing order.)

For example, for a pattern with 6 thread colors and ten thread color changes, the thread colors are assigned as shown below.

1	SKY BLUE	1	Needle bar 1	<table border="1"> <tr><td>6</td><td>WISTERIA VIOLET</td><td>1</td><td>SKY BLUE</td></tr> <tr><td>5</td><td>WHITE</td><td>2</td><td>PINK</td></tr> <tr><td>4</td><td>LAVENDER</td><td>3</td><td>MINT GREEN</td></tr> <tr><td>6</td><td>WISTERIA VIOLET</td><td>6</td><td>SKY BLUE</td></tr> <tr><td>4</td><td>LAVENDER</td><td>4</td><td>LAVENDER</td></tr> <tr><td>1</td><td>SKY BLUE</td><td>1</td><td>SKY BLUE</td></tr> <tr><td>2</td><td>PINK</td><td>2</td><td>PINK</td></tr> <tr><td>5</td><td>WHITE</td><td>5</td><td>WHITE</td></tr> </table>	6	WISTERIA VIOLET	1	SKY BLUE	5	WHITE	2	PINK	4	LAVENDER	3	MINT GREEN	6	WISTERIA VIOLET	6	SKY BLUE	4	LAVENDER	4	LAVENDER	1	SKY BLUE	1	SKY BLUE	2	PINK	2	PINK	5	WHITE	5	WHITE
6	WISTERIA VIOLET	1	SKY BLUE																																	
5	WHITE	2	PINK																																	
4	LAVENDER	3	MINT GREEN																																	
6	WISTERIA VIOLET	6	SKY BLUE																																	
4	LAVENDER	4	LAVENDER																																	
1	SKY BLUE	1	SKY BLUE																																	
2	PINK	2	PINK																																	
5	WHITE	5	WHITE																																	
2	PINK	2	Needle bar 2																																	
3	MINT GREEN	3	Needle bar 3																																	
4	LAVENDER	4	Needle bar 4																																	
6	WISTERIA VIOLET	6	Needle bar 6																																	
6	WISTERIA VIOLET	6	Needle bar 6																																	
4	LAVENDER	4	Needle bar 4																																	
1	SKY BLUE	1	Needle bar 1																																	
2	PINK	2	Needle bar 2																																	
5	WHITE	5	Needle bar 5																																	

For a pattern with seven or more thread colors, the thread spool information is updated when the seventh thread color is needed.

Afterward, the machine adjusts the assignment of thread colors to reduce the number of times that the thread spools will have to be changed.

For example, for a pattern with seven thread colors and eleven thread color changes, the thread colors are assigned as shown below.

1	GREEN OAK	1	Needle bar 1	<table border="1"> <tr><td>6</td><td>CORNFLOWER BLUE</td><td>1</td><td>GREEN OAK</td></tr> <tr><td>5</td><td>CREAM BROWN</td><td>2</td><td>MOSS GREEN</td></tr> <tr><td>4</td><td>LIGHT LILAC</td><td>3</td><td>CLAY BROWN</td></tr> <tr><td>6</td><td>CORNFLOWER BLUE</td><td>6</td><td>GREEN OAK</td></tr> <tr><td>5</td><td>CREAM BROWN</td><td>5</td><td>CREAM BROWN</td></tr> <tr><td>4</td><td>LIGHT LILAC</td><td>4</td><td>LIGHT LILAC</td></tr> </table>	6	CORNFLOWER BLUE	1	GREEN OAK	5	CREAM BROWN	2	MOSS GREEN	4	LIGHT LILAC	3	CLAY BROWN	6	CORNFLOWER BLUE	6	GREEN OAK	5	CREAM BROWN	5	CREAM BROWN	4	LIGHT LILAC	4	LIGHT LILAC
6	CORNFLOWER BLUE	1	GREEN OAK																									
5	CREAM BROWN	2	MOSS GREEN																									
4	LIGHT LILAC	3	CLAY BROWN																									
6	CORNFLOWER BLUE	6	GREEN OAK																									
5	CREAM BROWN	5	CREAM BROWN																									
4	LIGHT LILAC	4	LIGHT LILAC																									
2	MOSS GREEN	2	Needle bar 2																									
3	CLAY BROWN	3	Needle bar 3																									
4	LIGHT LILAC	4	Needle bar 4																									
5	CREAM BROWN	5	Needle bar 5																									
6	CORNFLOWER BLUE	6	Needle bar 6																									

← Change thread spools here.

2	DARK BROWN	2	Needle bar 2	<table border="1"> <tr><td>6</td><td>CORNFLOWER BLUE</td><td>1</td><td>GREEN OAK</td></tr> <tr><td>5</td><td>CREAM BROWN</td><td>2</td><td>MOSS GREEN</td></tr> <tr><td>4</td><td>LIGHT LILAC</td><td>3</td><td>CLAY BROWN</td></tr> <tr><td>6</td><td>CORNFLOWER BLUE</td><td>6</td><td>GREEN OAK</td></tr> <tr><td>5</td><td>CREAM BROWN</td><td>5</td><td>CREAM BROWN</td></tr> <tr><td>4</td><td>LIGHT LILAC</td><td>4</td><td>LIGHT LILAC</td></tr> </table>	6	CORNFLOWER BLUE	1	GREEN OAK	5	CREAM BROWN	2	MOSS GREEN	4	LIGHT LILAC	3	CLAY BROWN	6	CORNFLOWER BLUE	6	GREEN OAK	5	CREAM BROWN	5	CREAM BROWN	4	LIGHT LILAC	4	LIGHT LILAC
6	CORNFLOWER BLUE	1	GREEN OAK																									
5	CREAM BROWN	2	MOSS GREEN																									
4	LIGHT LILAC	3	CLAY BROWN																									
6	CORNFLOWER BLUE	6	GREEN OAK																									
5	CREAM BROWN	5	CREAM BROWN																									
4	LIGHT LILAC	4	LIGHT LILAC																									
1	GREEN OAK	1	Needle bar 10																									
3	CLAY BROWN	3	Needle bar 3																									
6	CORNFLOWER BLUE	6	Needle bar 6																									
2	DARK BROWN	2	Needle bar 2																									

Since the thread colors on needle bars 1, 3 and 6 will be used again after the thread spools are changed, they will not be replaced. However, different colors are assigned to the other needle bars.

Checking if thread spool changes are necessary

When selecting a pattern, the number of thread changes can be viewed, however, which thread colors are used in the pattern cannot be checked on this screen. Whether or not and when thread spools will need to be changed can be checked with the following indicators.

Time until the machine stops embroidering

This indicator shows the amount of time until the machine stops embroidering. The machine stops when a spool change is required, or when the machine is set to be stopped by other settings. If the spool change indicator is appears, the machine will require a spool change. When the time is indicated in red, it is the last color embroidering before the machine stops.

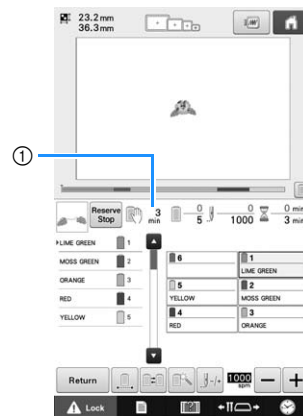



① Time until the machine stops

■ Spool change indicator (———)

The spool change indicator in the embroidering screen indicates the number of times that the thread spools will need to be changed and the amount of time between changes.

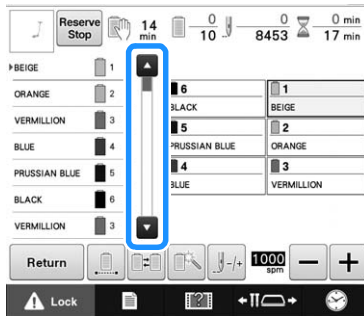

- 1 Use the scroll bar on the right side of the thread color sequence display in the embroidering screen.

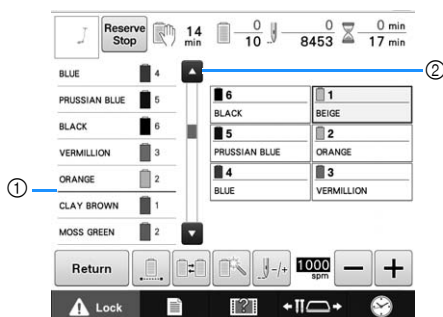

- Each time  is touched, the thread color sequence display scrolls down to the next color. After reaching the last color in the thread color sequence display, the first color is selected.
- The display can also be scrolled by using the scroll bar.

- 2 Check the position of .

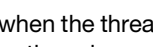

- ①  indicates when the thread spools will need to be changed. The thread spools will need to be changed the number of times that this indicator is displayed and between the two thread colors at the point where it is displayed.
- ② Touch  to scroll up through the thread color sequence display. Each time this key is touched, the previous color in the thread color sequence display is selected. After reaching the first color in the thread color sequence display, the last color is selected.

- 3 After checking the desired information, touch  or the top of the scroll bar to return to the first color.

Changing the Thread Spools with Designs of Seven or More Colors

This section contains details on understanding the change thread spools message and on easily changing the thread spools.

Memo

- This feature is not available if “Manual Color Sequence” has been set to “ON” in the settings screen.

Change thread spools message

When it is necessary to replace the thread spool while embroidering a pattern that contains seven or more colors, the machine automatically stops sewing and the message shown below appears.

This message also appears when it is necessary to change the thread spools before beginning to embroider a new pattern. Change the thread spools according to their new assignments.

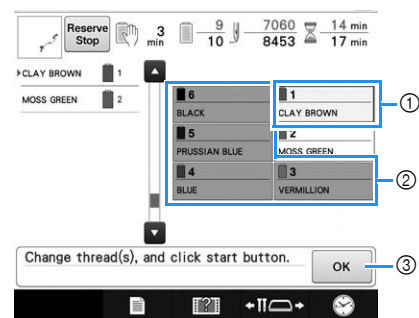

- ① The thread information for the thread spool to be changed appears in the new thread color and framed in red.
- ② The thread information for the thread spool needs not to be changed appears in gray.
- ③ Touch this key to close the message indicating that the thread spool be changed.



Note

- Touch needle bar key to move the needle into the correct position for threading into the new thread color. Refer to “Moving and threading a selected needle bar” on page 55.
- When the embroidering screen appears, the needle bar settings are saved.
- If the needle bar settings are saved and the next pattern that is opened contains thread colors that are the same as those from the previous pattern, the same needle bars will be assigned the same thread colors from the previous pattern.
- If you wish to delete all assigned color on display refer to “To cancel the thread color settings for all previously stitched design” on page 93.



Memo

- To use a different thread color than the one that was specified, use the temporary needle bar setting key, and then change the thread color setting. (For details, refer to “Temporary Needle Bar Setting” on page 119.)
- To minimize changing the thread spools, frequently used thread colors can be specifically assigned to certain needle bars. (For details, refer to “Reserved Needle Bar and Sewing Speed Settings” on page 120.)

Easily changing the thread spools

When replacing the thread spools, it is necessary to re-thread the upper thread. However, the thread spools can easily be changed when replacing a thread spool whose thread is correctly threaded through the machine.

- 1 Cut the thread between the thread spool and the thread guide.**

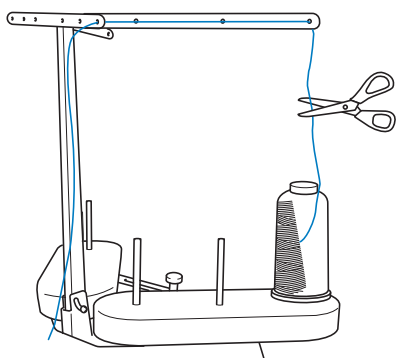

- 2 Change the thread spool.**

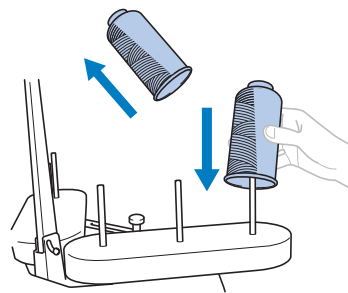

- 3 Tie the end of the thread on the new spool with the end of the thread remaining from the previous color.**

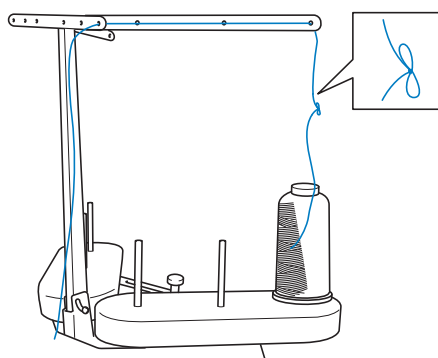

- 4 Pull out the old thread just after the needle bar thread guide.**

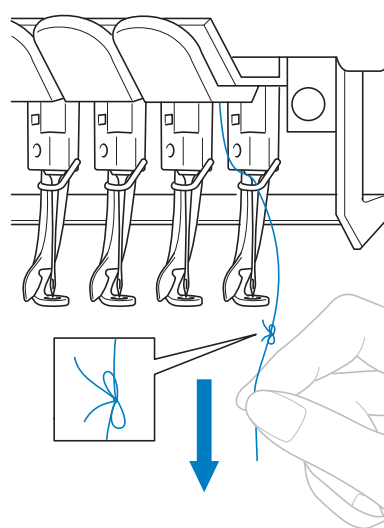

Continue pulling the thread until the knot is above the needle. Cut the knot.

- 5 Use the automatic needle-threading mechanism to thread the needle with the new thread. (Refer to page 54.)**

→ This completes the changing of the thread spool.



Note

- When pulling out the thread, do not pull the knot through the eye of the needle. If the knot is pulled through the eye of the needle, the needle may be damaged.

If the Thread Breaks or the Bobbin Thread Runs Out While Embroidering

If the thread breaks or the bobbin thread runs out while embroidering, the machine will automatically stop. Since some stitches may be sewn with only one thread, go back through the stitching to a point where stitches have already been sewn before continuing embroidering.



Note

- If the thread sensor is turned off, the machine does not stop until embroidering is finished. Normally, the thread sensor should be turned on. (Refer to page 179.)
- Be careful when going back or forward through the stitching since the embroidery frame moves at the same time.

If the upper thread breaks

1 Re-thread the upper thread. (Refer to page 50.)

2 Touch .

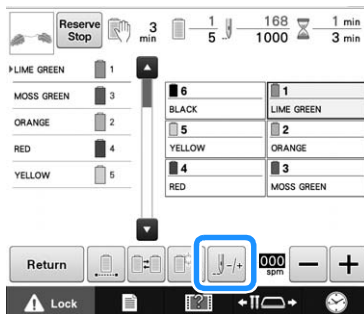

→ The stitch navigating screen appears.

3 Touch and to go back through the stitching to a point where stitches have already been sewn.

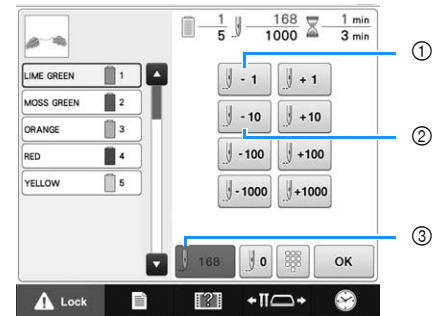

- ① Each touch of this key moves one stitch back through the stitching.
- ② Each touch of this key moves ten stitches back through the stitching.
- ③ Touch this key to return to the point in the stitching before the changes.



Note

- It is recommended to stitch over the last two or three stitches for complete coverage.

You can also touch the specific point of the embroidery progress bar to move the stitch count to the desired point.

If the needle bar is moved back too far through the stitching, touch or to go forward through the stitching.

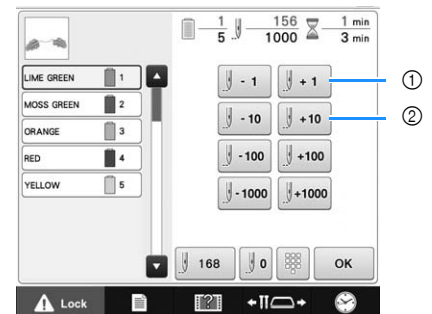

- ① Each touch of this key moves one stitch forward through the stitching.
- ② Each touch of this key moves ten stitches forward through the stitching.

4 Touch .

→ The embroidering screen appears again.

5 Touch , and then press the start/stop button to continue embroidering.

■ Specifying a stitch number

1 In step 3 on page 97, touch .

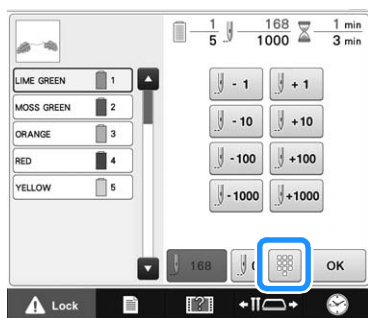

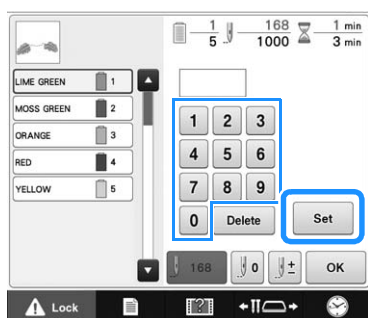

2 Use the number keys to enter the desired stitch number, and then touch .



→ The embroidery frame moves to the specified stitch.

3 Touch  to return to the previous screen, and then continue with step 4.

Memo

- Touch  to reset the stitch number and embroider from the first stitch.
- To specify the last stitch number, select the last thread color, and then touch .

If the bobbin thread breaks or runs out

1 Touch , and then press the thread trimming button.

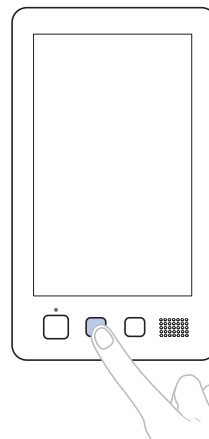

→ The upper thread is trimmed.

- If the bobbin thread breaks or runs out, also trim the upper thread.

2 Remove the stitches sewn only with the upper thread.

Pull the trim end of the upper thread.

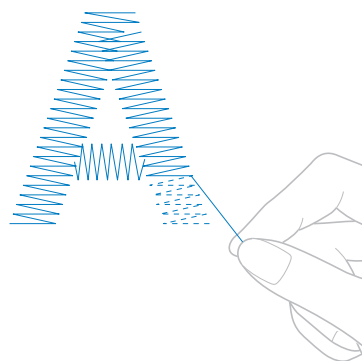

- If the stitches cannot be cleanly removed, trim the thread with scissors.

■ If the bobbin thread ran out, replace the bobbin at this point in the procedure.

- 1 Replace the bobbin with a bobbin wound with bobbin thread. (Refer to page 33.)

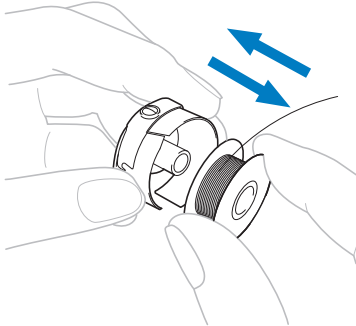

- If the hook cover can be opened, replace the bobbin without removing the embroidery frame from the machine.
- If the machine bed is hidden, for example, with a bag-shaped piece of fabric, or if the hook cover cannot be opened, temporarily remove the embroidery frame. (Refer to page 60.) After replacing the bobbin, re-attach the embroidery frame. (Refer to page 45.)

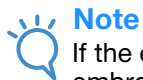

Note

If the embroidery frame is removed before embroidering of the pattern is finished, take caution, otherwise the pattern may become misaligned.

- Do not apply extreme pressure to the framed fabric and cause it to become loose.
- When removing and re-attaching the embroidery frame, do not allow the frame to hit the carriage or the presser foot. If the carriage is hit and moves, turn the machine off, then on again. The correct frame position at the time that the machine was stopped is stored in the machine's memory, and the embroidery frame is returned to the correct position.
- When the embroidery frame is re-attached, make sure that the pins on the left and right arms of the embroidery frame holder securely fit into the holes in the handles on the embroidery frame.

- 2 Go back through the stitching in the same way as that described in step 2 of "If the upper thread breaks" on page 97, and then continue embroidering.

Embroidering From the Beginning or Middle of the Pattern

If you wish to restart embroidering from the beginning, for example, if trial embroidery was sewn and an incorrect thread tension was used or if the wrong thread color was used, restart the embroidering using the forward/backward stitch key. In addition, you can go forward or back through the stitching by thread color or by stitch to start stitching at any position of the pattern.



Note

- Be careful when going back or forward through the stitching since the embroidery frame moves at the same time.

- 1 Press the start/stop button to stop the machine.

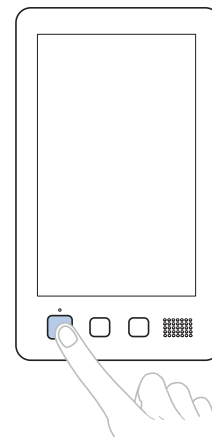

- If necessary, trim and remove the sewn stitches.

- 2 Touch .

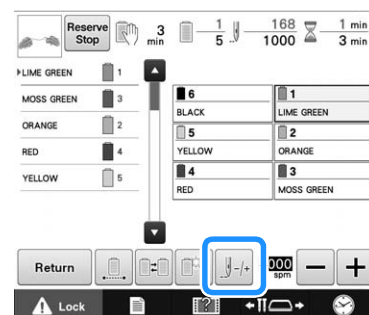

→ The stitch navigating screen appears.





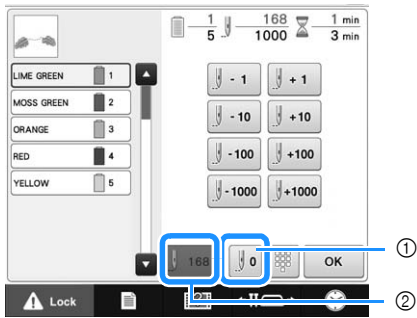



■ To start sewing from the beginning

3 Touch .







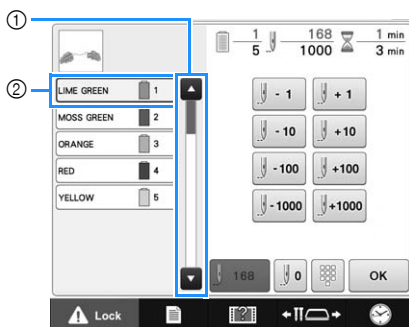

- ① Touch this key to return to the beginning of the first color.
→ The embroidery frame moves to the starting position.
- ② Touch this key to cancel the changes and return to the point in the stitching before the changes.

■ To select the stitch from where embroidering is to begin

4 Use the scroll bar to select the thread color, and then touch , , , , , ,  and  to select the specific stitch.



- ① The stitch from where embroidering is to begin can also be specified by using the scroll bar.
- ② The thread color at the top of the thread color sequence display is the color of the area currently selected.
Touch this area to specify the stitch from where embroidering is to begin.

-  - 1 Each touch of this key moves one stitch back through the stitching.
-  - 10 Each touch of this key moves ten stitches back through the stitching.
-  - 100 Each touch of this key moves one hundred stitches back through the stitching.
-  - 1000 Each touch of this key moves one thousand stitches back through the stitching.
-  + 1 Each touch of this key moves one stitch forward through the stitching.
-  + 10 Each touch of this key moves ten stitches forward through the stitching.
-  + 100 Each touch of this key moves one hundred stitches forward through the stitching.

 +1000 Each touch of this key moves one thousand stitches forward through the stitching.

→ The needle bar case moves and the current needle bar moves to the sewing position, and then the embroidery frame moves and current needle position is indicated.

5 After selecting the stitch from where embroidering is to begin, touch .

→ The embroidering screen appears again.

6 Touch , and then press the start/stop button to begin embroidering.

→ Embroidering begins from the specified point.

■ Specifying a stitch number

1 In step 4 on page 100, touch .

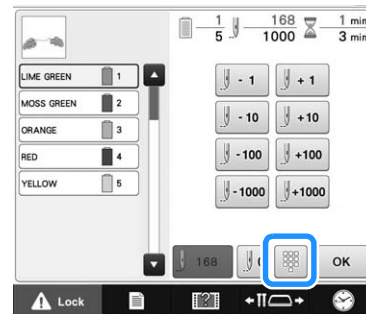

2 Use the number keys to enter the desired stitch number, and then touch .

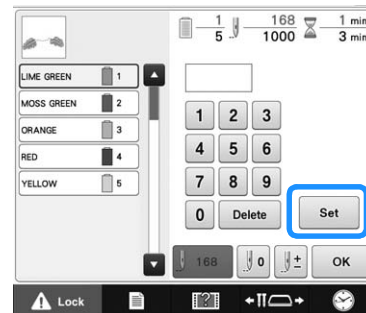

→ The embroidery frame moves to the specified stitch.

3 Touch  to return to the previous screen, and then continue with step 5.

Resume Embroidering After Turning Off the Machine

In either of the following cases, the remaining stitches of the embroidery are stored in the machine's memory.

- If the machine's power switch is pressed to turn off after stopping embroidering. Cut the thread before the machine's main power switch is turned off, otherwise the thread may be pulled or may catch when the carriage returns to its initial position after the machine is turned on again.
- If the machine was accidentally turned off, for example, due to a power outage, while it was embroidering. The remainder of the embroidery can be sewn when the machine is turned on again; however, some of the stitches that were already sewn may be sewn again.



Note

- Be careful when going back or forward through the stitching since the embroidery frame moves at the same time.

- 1 Set the main power switch to "I" to turn on the machine.
- 2 When the machine is turned on, the opening movie is played. Touch anywhere on the screen to display the message below.
- 3 Touch  .

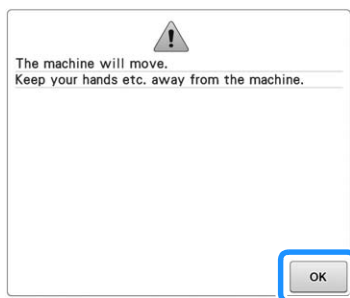

→ A message appears, asking if you wish to continue embroidering or start a new operation.

- 4 Touch  .

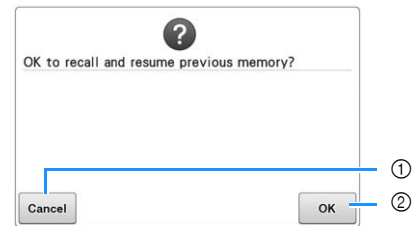

- ① Touch to cancel embroidering and display the pattern type selection screen to select a new pattern.
- ② Touch to continue embroidering.
→ The embroidering screen displayed before the machine was turned off appears.



- 5 Touch  .

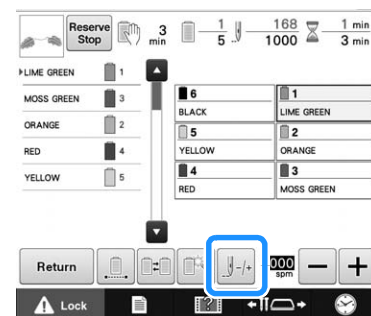

→ The stitch navigating screen appears.

- 6 Touch  two or three times to go back two or three stitches.

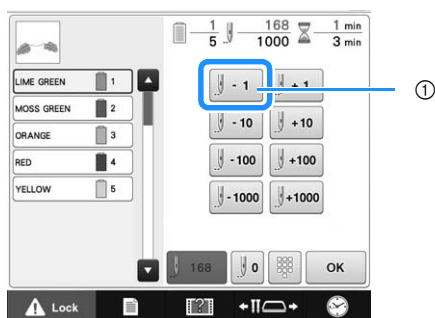

- ① Each touch of this key moves one stitch back through the stitching.
- Check that the needle drop point is positioned where stitches have already been sewn.

- 7 Touch  .

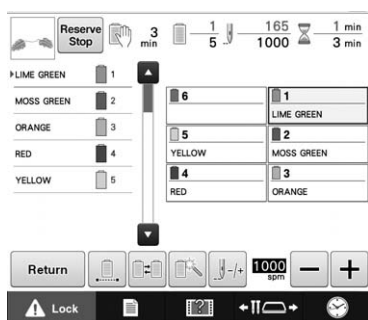

→ The embroidering screen appears again.

- 8 Touch , and then press the start/stop button to continue embroidering.

Memo

- The machine can be stopped at any time, even while it is embroidering; however, if the machine is stopped when the thread color is changed, it is not necessary to go back through the stitching when embroidering is continued. The machine can also be set to stop when the thread color is changed. (For details, refer to “Setting the Machine to Stop at Color Changes” on page 117.)

Adjusting the Thread Tension of both the Bobbin and Upper Thread

The following procedure describes how to adjust the thread tensions. After adjusting the tension of the bobbin thread, adjust the tension of the upper thread for each needle bar.

Note

- Be sure to check the tension of the bobbin thread each time that the bobbin is changed. Depending on the bobbin thread type and whether a prewound bobbin is used, the tension of the bobbin thread may differ. For example, when replacing an empty prewound bobbin with one of the same type, be sure to check the tension of the bobbin thread and adjust the tension if necessary.
- Be sure to adjust the tension of the bobbin thread before adjusting the tension of the upper thread.
- In order to check the finished embroidery before sewing on your project, sew trial embroidery using the same fabric and thread as those in your project.

Adjusting the tension of the bobbin thread

- 1 Tie the included weight to the end of the thread extending from the bobbin case.

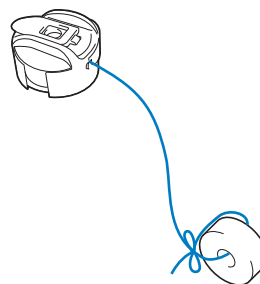

Note

- Different weights are used to adjust prewound bobbins and metal bobbins.
Prewound bobbins: Only weight (L)
Metal bobbins: Weight (L) and weight (S)
* Weight (S) is included with the optional bobbin winder.

- 2 As shown in the illustration, hold the bobbin case against a smooth vertical surface.

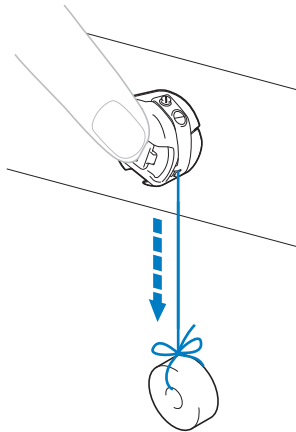

- If the thread with the weight attached is slowly pulled out, the thread tension is correct.

- 3 Use the included standard screwdriver to turn the tension-adjusting screw and adjust the thread tension.

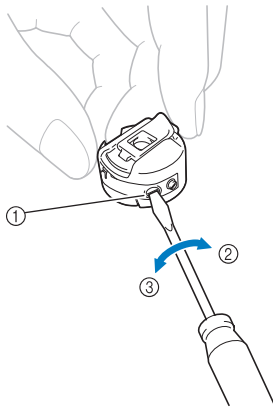

- ① Tension-adjusting screw
- ② Tighter
- ③ Looser

- 4 After making the adjustments, try embroidering with all needle bars to check the thread tension.

Memo

- In the built-in embroidery patterns, one pattern is used for checking the thread tension. By sewing this pattern, the thread tension can easily be checked. For details, refer to page 197.

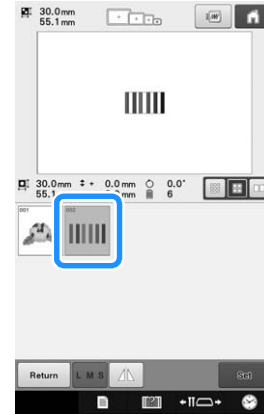

Adjusting the tension of the upper thread

When embroidering, the thread tension should be set so that the upper thread can slightly be seen on the wrong side of the fabric.

- 1 Turn the thread tension knobs.

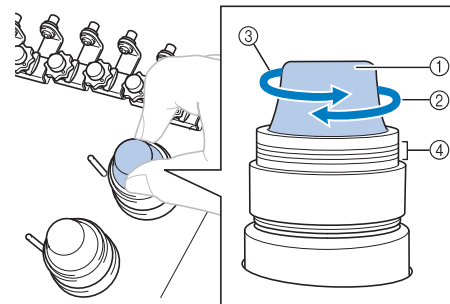

- ① Thread tension knobs
- ② Tighter
- ③ Looser
- ④ Mark

→ If the thread tension is not still correctly adjusted, turn the upper thread guide pretension knob.

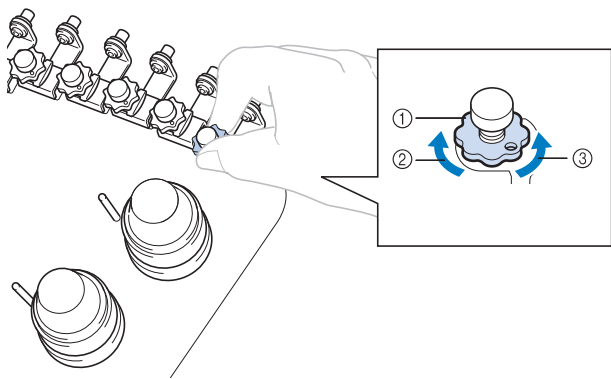

- ① Upper thread guide pretension knob
- ② Tighter
- ③ Looser

■ Correct Thread Tension

The pattern can be seen from the wrong side of the fabric. If the thread tension is not set correctly, the pattern will not finish well. The fabric may pucker or the thread may break.

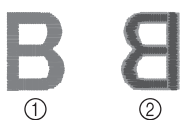

- ① Right side
- ② Wrong side

Follow the operations described below to adjust thread tension according to the situation.



Note

- If the thread tension setting is made extremely weak, the machine may stop during sewing. This is not the sign of a malfunction. Increase the thread tension slightly, and begin sewing again.
- If necessary, refer to page 213 for reassembling the tension unit.

■ Upper thread is too tight

The tension of the upper thread is too tight, resulting in the bobbin thread being visible from the right side of the fabric.

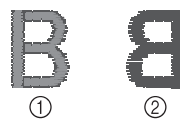

- ① Right side
- ② Wrong side

Turn the knob in the direction of the arrow to decrease the tension of the upper thread.

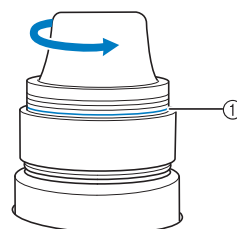

- ① Red line

If the red line is visible, the thread tension cannot be decreased any further. Increase the tension of the bobbin thread. For details, refer to page 102.



Note

- If you decrease the thread tension further than the red line, the tension knob may be disassembled.
- If necessary, refer to page 213 for reassembling the tension unit.

■ Upper thread is too loose

The tension of the upper thread is too loose, resulting in a loose upper thread, loose thread locks or loops appearing on the right side of the fabric.

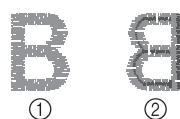

- ① Right side
- ② Wrong side

Turn the knob in the direction of the arrow to increase the tension of the bobbin thread.

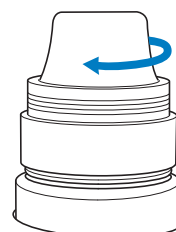

This chapter contains descriptions on the various embroidering settings, which make operation easier.

Basting Embroidery

Before embroidering, basting stitches can be sewn along the outline of the pattern. This is useful for embroidering fabric that cannot have stabilizer material affixed with an iron or adhesive. By stitching stabilizer material to the fabric, shrinkage of the stitching or misaligned pattern can be minimized.



Note

- It is recommended to finish combining and editing the pattern before selecting the basting setting. If the pattern is edited after selecting the basting setting, the basting and pattern may become misaligned, and the basting under the pattern may be difficult to remove after embroidering is complete.

1 Touch , and then display page 2 of the settings screen.

2 Use and to specify the distance from the pattern to the basting stitching.

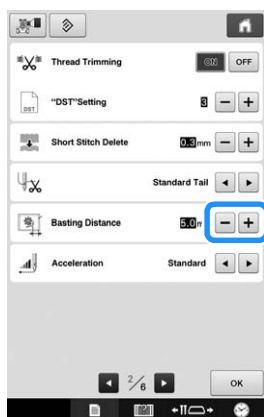

Memo

- The higher the setting, the farther the basting is from the pattern.
- The setting remains selected even if the machine is turned off.

3 Touch to return to the embroidering settings screen.

4 Touch to select the basting setting.

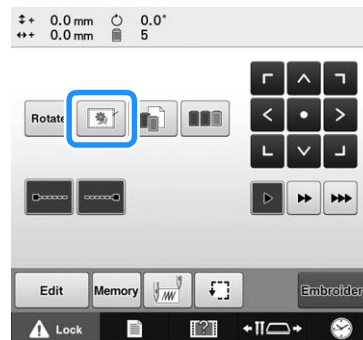

Note

- When is pressed, the pattern is moved to the center. After selecting the basting setting, move the pattern to the desired position.

- To cancel the setting, touch .

→ Basting is added to the beginning of the sewing order.

5 Touch to continue to the embroidering screen.

6 Touch , and then press the start/stop button to begin embroidering.

7 When embroidering is finished, remove the basting stitching.

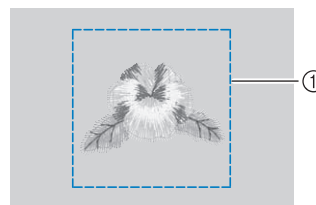

① Basting stitching

Creating an Appliqué Piece

Appliqué pieces can be created from the built-in patterns and patterns on embroidery cards. This is convenient for fabrics that cannot be embroidered or when you wish to attach an appliqué to a garment.

Creating an appliqué piece

The following pattern will be used to create an appliqué piece.

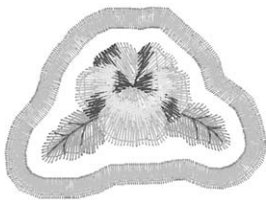

Note

- Felt or denim fabrics are recommended to make the appliqué piece. Depending on the pattern and fabric used, lighter weight fabrics may cause the stitching to appear smaller.
- For best results, be sure to use stabilizer material for embroidering.
- Select a frame that matches the pattern size. Frame options are displayed on the LCD screen.
- Finish combining and editing the pattern before selecting the appliqué setting. If the pattern is edited after selecting the appliqué setting, the appliqué stitching and pattern may become misaligned.
- Since an outline is added, the pattern for an appliqué piece (when the appliqué setting is selected) will be larger than the original pattern.
First, adjust the size and position of the pattern as shown below.

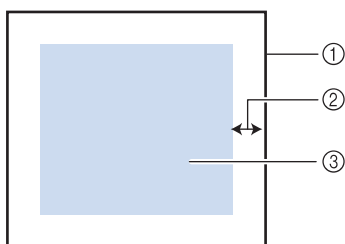



- ① Embroidering area
- ② Approx. 10 mm
- ③ Pattern size

1 Select the pattern to be used for the appliqué.

2 In the pattern editing screen, touch .

3 Select the outline.

If  is selected, an outline can be created around the pattern.

→ Use  or  to specify the distance between the pattern and the appliqué outline.

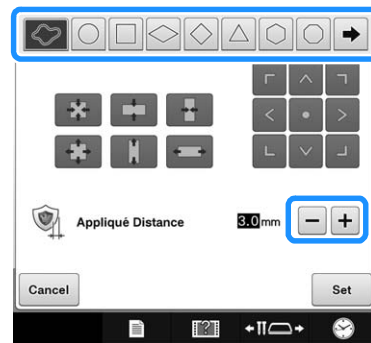

Memo

- If a border pattern is selected for the outline, the border pattern can be enlarged, reduced or moved.
- Touch  to select a different outline pattern.

4 To check preview in the screen, touch

.



Note

- At this time, the pattern and outline will be grouped.

5 After specifying the various settings, touch

.

6 Specify the embroidering settings, and then touch  to continue to the embroidering screen.

Memo

- Three steps are added to the sewing order: appliqué cutting line, position of pattern placement on the garment, and appliqué stitching.

	RED	4
	YELLOW	5
①	APPLIQUE MATERIAL	6
②	APPLIQUE POSITION	6
③	APPLIQUE	6

- ① Cutting line for appliqué
- ② Position of pattern placement on garment
- ③ Appliqué stitching
 - We recommend using thread for the cutting line "APPLIQUE MATERIAL" that is closest to the color of the fabric.

- ⑦ Fuse or stick a piece of stabilizer to the back of the felt or denim fabric to be used as the appliqué piece.
- ⑧ Hoop the appliqué fabric in the embroidery frame, attach the embroidery frame to the machine, and then start embroidering.
- ⑨ After the cutting line "APPLIQUE MATERIAL" is embroidered, stop the machine and remove the appliqué material from the embroidery frame.
- ⑩ Carefully cut along the stitching. After cutting, carefully remove all of the cutting line thread.

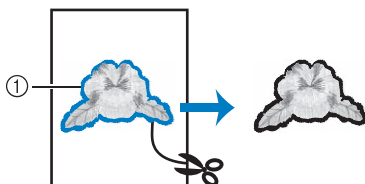

① Cutting line for appliqué

Note

- Depending on the pattern density and fabric used, there may be shrinking of the pattern or the appliqué may be misaligned with the placement line. We recommend cutting slightly outside of the cutting line.
- When using patterns that are vertically and horizontally symmetrical, use a chalk pencil to indicate the pattern orientation before cutting it out.
- Carefully cut out the pattern on the outline you just sewed. Do not cut inside the cutting line, otherwise the appliqué fabric will not be caught by the appliqué stitch.

- ⑪ Use two layers of adhesive water-soluble stabilizer material with their sticky sides together, and then hoop them in the embroidery frame.

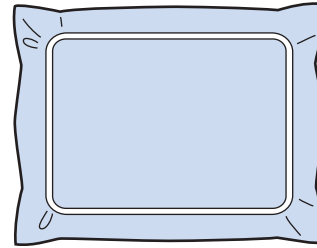

Note

- If water-soluble stabilizer is used, it is not necessary to remove the stabilizer material after sewing the appliqué outline. To reduce shrinkage of the pattern, we recommend using water-soluble stabilizer.
- Put together two layers of water-soluble stabilizer, otherwise the stabilizer material may tear during embroidering.

- ⑫ Sew the placement line for the appliqué position "APPLIQUE POSITION".

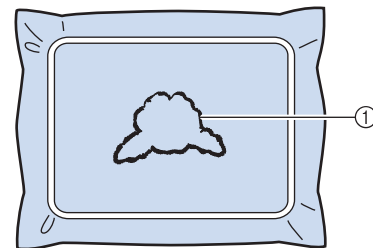

① Pattern placement line

- ⑬ Lightly apply glue or spray adhesive, and paste the appliqué piece so that it aligns with the placement line.

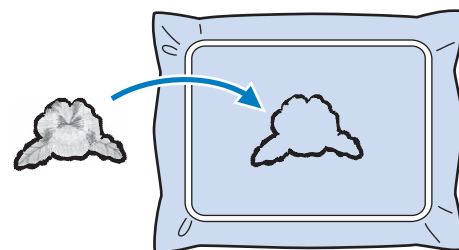

Note

- Before pasting the appliqué piece down, make sure the appliqué piece is positioned correctly within the placement line.

14 Sew the outline "APPLIQUE".

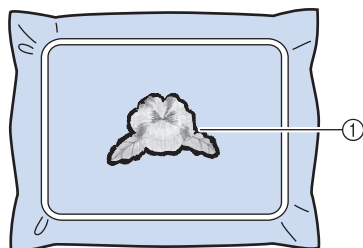

① Outline of appliqué piece

15 After embroidering is finished, remove the stabilizer material from the embroidery frame.

16 Use scissors to cut the excess water-soluble stabilizer from outside the appliqué outline.

17 Soak the appliqué piece in water to dissolve the water-soluble stabilizer.

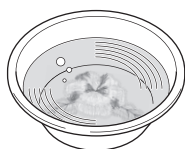

18 Dry the appliqué piece, and then iron it if necessary.



Note

- Do not apply a strong force when ironing, otherwise the stitching may be damaged.



Memo

- The outline is sewn using satin stitching.
- Some glue may get onto the presser foot, needle, and needle plate at this time. Finish embroidering the appliqué pattern, and then clean off the glue.

Selecting/Managing Thread Colors for Each Needle Bar (Manual Color Sequence)

The thread colors assigned to each needle bar can be manually specified/managed. In addition, the thread colors can be assigned to needle bars automatically and more efficiently than when the settings are normally specified.

Convenience of the manual color sequence

The manual color sequence is convenient when the machine is being used under the following conditions.

■ **When using embroidery data that has no thread color information, such as with DST files**

The thread spools to be used can easily be selected for data with no thread color information. (For details on the thread color information for DST files, refer to "Colors of Tajima (.dst) embroidery data" on page 200.)

■ **When the same combination of thread colors is always used**

If specific thread colors are assigned to certain needle bars, the thread color settings can be changed with the needle bar number assignments, even when the pattern is changed. The operation is simplified if the same thread colors are always used.

■ **When continuously sewing with the same needle bar settings**

If the settings are specified normally, the needle bar settings are canceled when the embroidering settings screen appears after sewing stops. However, with the manual color sequence, the needle bar settings continue to be applied unless the pattern is deleted or the machine is turned off.

This is useful if the same pattern is to be sewn continuously multiple times.

Specifying the manual color sequence



Note

- The manual color sequence cannot be changed while operations are being performed in the embroidering screen.

1 Touch , and then display page 5 of the settings screen.

2 Touch , and then select the manual color sequence.

- When the embroidery machine is purchased, "OFF" is selected.

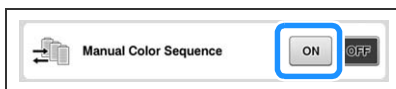

3 Touch  to return to the previous screen.

- The icon for the manual color sequence appears in the screen.

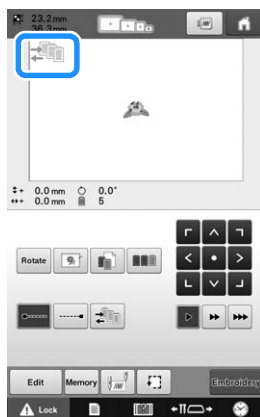

Using the manual color sequence

Manually assign thread colors to all needle bars

By specifying the thread colors used with this machine, sewing can continue more efficiently simply by changing the needle bar assignments after a pattern is selected. With the normal method of specifying settings, only a maximum of 5 needle bars can be manually assigned thread colors; however, with the manual color sequence, all 6 needle bars can be assigned thread colors.

(For details on specifying the settings, refer to "Reserved Needle Bar and Sewing Speed Settings" on page 120.)

Needle bar number settings

The needle bar used with each thread color can be specified.



Memo

- Using the procedure described in "Reserved Needle Bar and Sewing Speed Settings" on page 120, the finished embroidery colors can be checked in the screen if thread colors are assigned to thread spools.

1 In the embroidering settings screen, touch



- A screen appears, allowing the needle bar numbers to be selected.

2 From the thread color sequence display, select the thread color whose needle bar is to be changed.

- If the desired thread color is not displayed, use the scroll bar on the right side to display it.

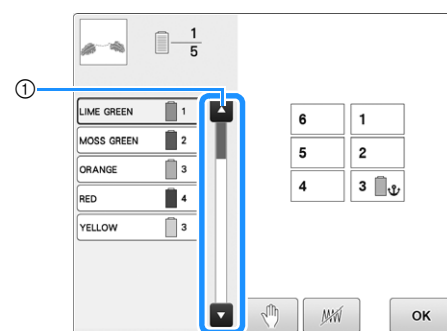

① Scroll bar

3 Touch a number button (between 1 and 6) to select the number of the needle bar whose settings are to be specified.

→ The needle bar number for the thread color selected in step 2 changes to the selected needle bar number.

If the needle bar number was specified with reserved needle bar settings, the color of the thread spool on the left side changes to the specified thread color, and the pattern in the pattern display area also changes to the color of the specified needle bar.

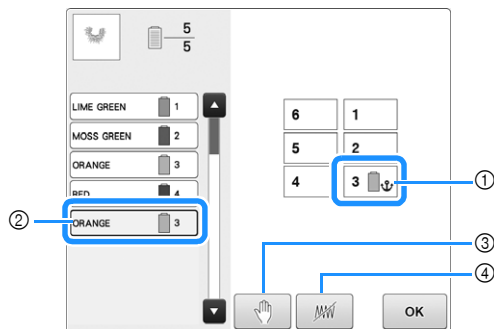

- ① Needle bar number specified with reserved needle bar settings
 - ② Needle bar set to a different number (needle bar 5)
 - ③ If a color is selected by touching this key, the machine stops before sewing the selected color.
 - ④ If a color is selected by touching this key, the pattern parts with the selected color will not be sewn.
- If ③ and ④ are both set for the same thread color, ④ will be given priority.

■ Initializing thread color settings

With the manual color sequence, the thread color information on the machine can be initialized each time a new pattern is selected, and then the needle bars can be assigned. This allows the needle bar settings to be specified without being affected by the thread color information from the previous pattern.

Precautions on the manual color sequence

■ When embroidering a pattern containing 7 or more colors

With the manual color sequence, the machine does not monitor the timing for replacing thread spools. Since the machine does not automatically stop and no message indicating that the thread spool be changed appears, as with the normal needle bar settings, follow the step 3 on page 110 or the procedure described in either "Stopping the machine at the next color change" or "Specifying pause locations before embroidering" on page 118 to set the machine to stop with thread spools that must be changed.

Deselect Region Setting

The deselect region setting (which specifies that a thread color will not to be sewn) can be applied to a part of the pattern with a specific color. In this way, you can arrange the sewn embroidery without actually editing the pattern.

Specifying sewing of a specific thread color to be skipped

1 In the embroidering settings screen, touch

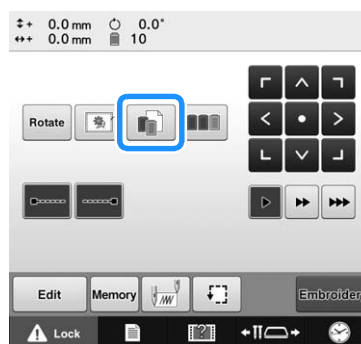

→ A screen appears, allowing the needle bar numbers to be selected.

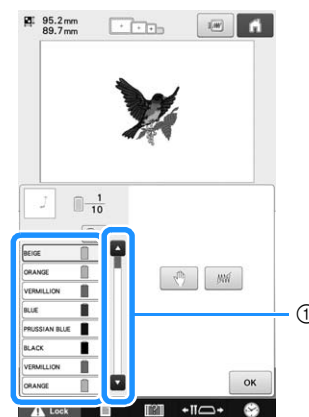

2 From the thread color sequence display, select the thread color that will not be sewn.

- If the desired thread color is not displayed, use the scroll bar on the right side to display it.



① Scroll bar

→ The selected thread color is surrounded with a blue frame.

- If the same thread color is used more than once, they can be combined. After selecting a thread color, touch . The key changes to , and all thread colors in the thread color sequence display that are the same as the one that was selected are highlighted in blue.

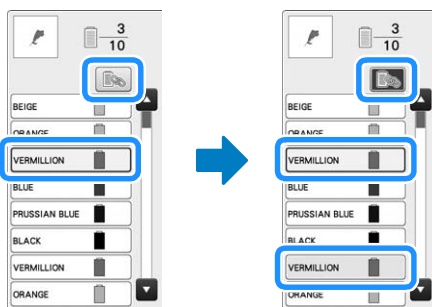

3 Touch .

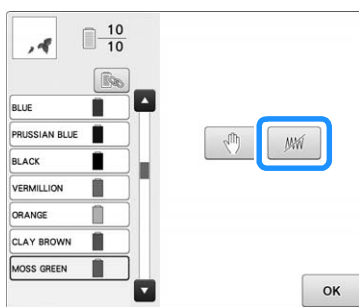

→ The  mark appears to indicate that the selected thread color will not be sewn.

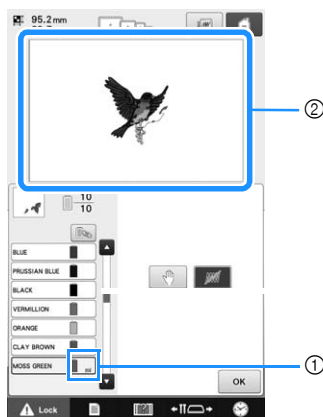

- ①  mark
- ② The parts of the pattern that will not be sewn are hidden.

4 Repeat steps ② and ③ for all thread colors that will not be sewn.

5 After specifying the desired settings, touch .

Memo

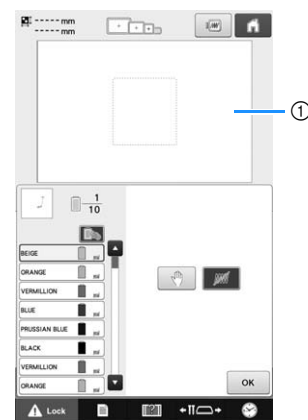

- If the deselect region setting is applied to a character pattern, all characters in the pattern will not be sewn. To deselect region for a single character, separate the character pattern (refer to page 154), or use the Multi Color key (refer to page 156). If the Multi Color key is used to specify that thread colors not be sewn, multi-color text cannot be turned off.
- The parts with the deselect region setting applied are not deleted. They can be reverted to being sewn (refer to “Cancelling the deselect region setting” on page 111).
- If the deselect region setting has been applied to all thread colors, a red  appears at the location of the pattern.



- ① Red 
 - If the machine is temporarily turned off, the settings to deselect region that were specified before the machine was turned off are not cancelled. However, the settings are cancelled if the same pattern is selected again.
 - When a pattern with the deselect region setting applied is saved, the deselect region setting is also saved. However, the pattern cannot be saved if the deselect region setting is applied to all thread colors.

Cancelling the deselect region setting

1 Select the thread color whose setting is to be cancelled, and then touch .



- The key changes to , and the deselect region setting is cancelled.
- If thread colors were combined with , the deselect region setting will also be cancelled for all thread colors that are the same as the one that was selected.



Automatic Lock Stitch Setting

The machine can be set to automatically sew lock stitches, for example at the beginning of the pattern, before sewing each thread color change, and before trimming the thread.

When the embroidery machine is purchased, this function is set ON.

■ Specifying that lock stitches be sewn at the beginning of the pattern, at the beginning of sewing each thread color change and at the beginning of sewing after the thread trim.

1 Touch  so that it changes to .

Touch  (or ) to select the desired setting.

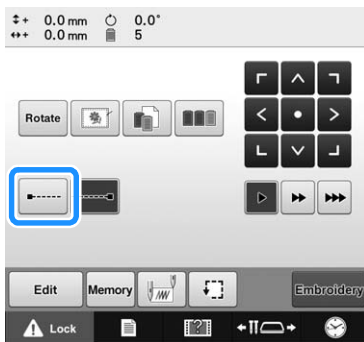

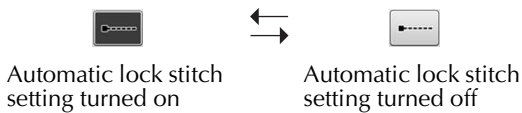

- Each touch of the key turns the setting either on or off.





Memo

- If the first stitch length is less than 0.8 mm, the lock stitch won't be inserted.
- If "Thread Trimming" is set "OFF" in the settings screen, the lock stitch won't be inserted (refer to page 184).

■ Specifying that lock stitches be sewn before the thread is trimmed.

1 Touch  so that it changes to .

Touch  (or ) to select the desired setting.

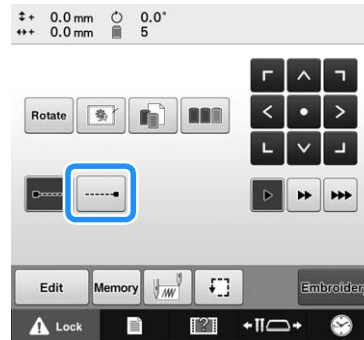

- Each touch of the key turns the setting either on or off.

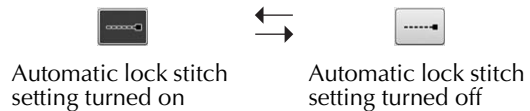

Memo

- The automatic lock stitch setting stays the same until the key is touched to turn it off. The setting specified before the machine is turned off remains selected the next time that the machine is turned on.
- If "Thread Trimming" is set "OFF" in the settings screen, the lock stitch won't be inserted (refer to page 184).

Starting/Ending Position Settings

The machine can set the start point and the ending point separately from the 9 points of the pattern. Those are upper-left corner, upper-center, upper-right corner, center-left, center-center, center-right, lower-left corner, lower-center and lower-right corner.

These settings can be used to repeatedly sew a pattern along a diagonal.

The starting/ending position settings are specified from the embroidering settings screen.

When the embroidery machine is purchased, both the starting position and the ending positions are set to the center of the pattern.

1 Touch .

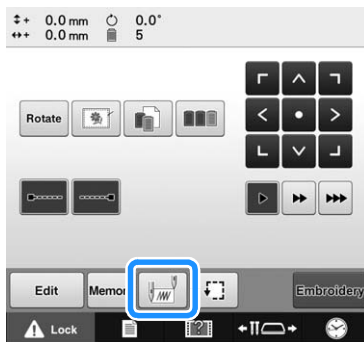

→ The starting/ending position settings screen appears.

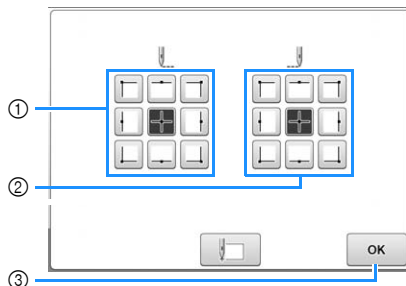

- ① Specifies the starting position
- ② Specifies the ending position
Touch a key to select the setting.
The highlighted key shows the currently selected setting.

Example

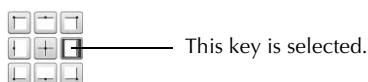

- ③ Touch this key to close this screen.

■ Specifying the starting position

2 Touch the key for the desired starting position setting.

- When a starting position is selected, the ending position is automatically set to the same position.
- The embroidery frame moves to the starting position.

■ Specifying the ending position

3 Touch the key for the desired ending position setting.

4 After selecting the desired settings, touch

 .

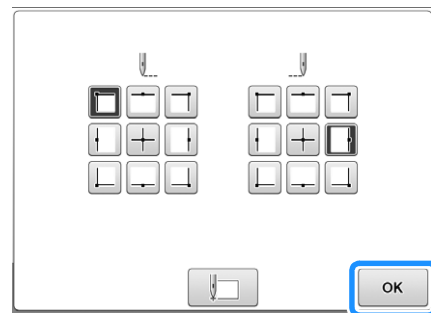

→ The embroidering settings screen appears again.

Memo

- The starting/ending position settings do not change until the key for a new setting is touched. The settings specified before the machine is turned off remain selected the next time that the machine is turned on.

Repeatedly sewing a pattern along a diagonal



Example



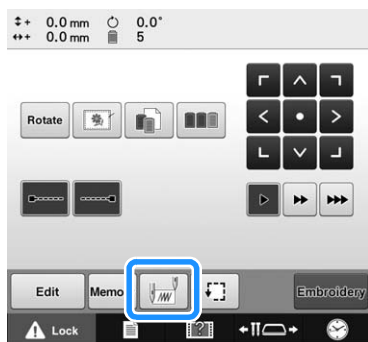

- 1 Specify the upper-left corner as the starting position and the lower-right corner as the ending position.

Touch  in the embroidering settings screen to display the starting/ending position settings screen.



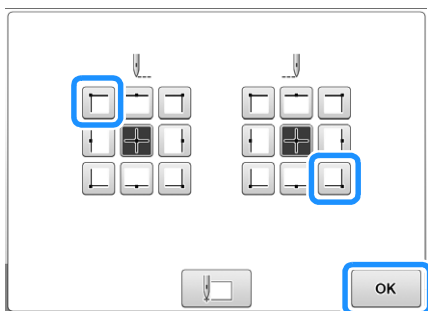

For the starting position, touch  so that it changes to .

For the ending position, touch  so that it changes to .



Touch  to close the starting/ending position settings screen.

- 2 Sew the first embroidery pattern.

Touch  to display the embroidering screen, and then touch  and press the start/stop button.

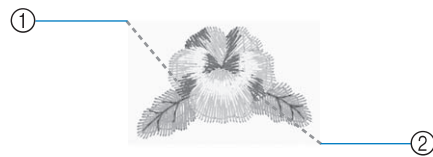

- 1 Starting position
- 2 Ending position

- 3 After embroidering is finished, the machine stops at the lower-right corner of the pattern.

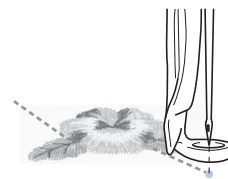

- 4 Touch  and repeat steps 2 and 3 three times.



Note

- If the next embroidery pattern of the series will be stitched outside the embroidery field, the following screen will appear. Rehoop the fabric to continue to repeat the sewing pattern. Touch  and repeat steps 2 and 3.

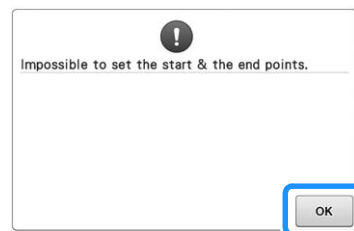

Memo

- If the starting position and ending position settings are changed, instead of sewing the patterns in a fixed direction, various pattern designs are possible.



Embroidering linked characters

Follow the procedure described below to embroider linked characters in a single row when the pattern extends beyond the embroidery frame.

Example: Linking "DEF" to the characters "ABC"

A B C D E F

- 1 Select the character patterns for "ABC".
- 2 In the embroidering settings screen, touch .

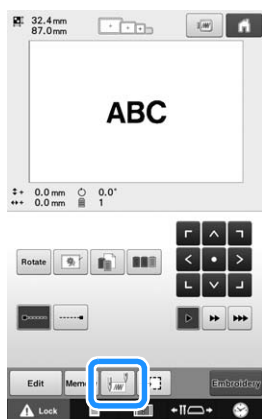

- 3 Touch .

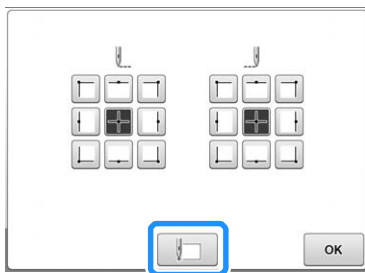



→ The needle bar is positioned in the lower-left corner of the pattern. The embroidery frame moves so that the needle is positioned correctly.





Note

- To cancel the starting point setting and return the starting point to the center of the pattern, touch .

- Use  to select a different starting point for embroidering.

- 4 Touch  to return to the embroidering settings screen, and then touch  to continue to the embroidering screen.

→  changes to  while the starting point is set in the lower-left corner of the pattern.

- 5 Touch , and then press the start/stop button to begin embroidering.
- 6 After the characters are embroidered, cut the threads, remove the embroidery frame, and then attach the embroidery frame again so that the remaining characters ("DEF") can be embroidered.

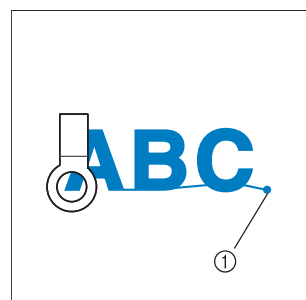

① End of the embroidering

- 7 As in step 1, select the character patterns for "DEF".
- 8 In the embroidering settings screen, touch .



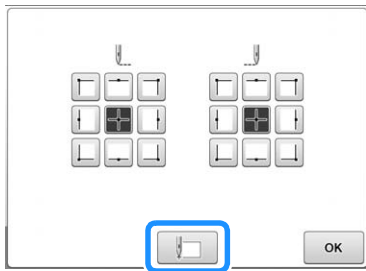

4

9 Touch .



→ The needle bar is positioned in the lower-left corner of the pattern. The embroidery frame moves so that the needle is positioned correctly.

10 Touch .

11 Use  to align the needle with the end of embroidering for the previous pattern.

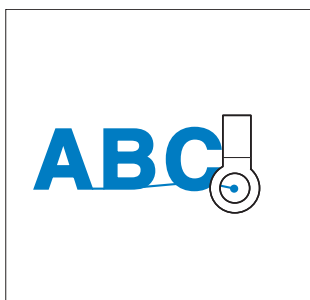

Note

- You can also follow the procedure in page 90 to find the sewing position, by directly place the needle over the end of the previous pattern.

12 Touch .

13 Touch , and then press the start/stop button to begin embroidering the remaining character patterns.



Maximum Sewing Speed Setting

The maximum sewing speed can be set to one of seven levels at every 100 spm between 400 and 1000 spm. If Cap frame, Cylinder frame or Clamp frame is used, the maximum sewing speed can be set to one of five levels at every 50 spm between 400 and 600 spm.



Maximum sewing speed

Embroidery frame/Flat frame/ Round frame/ or other frames		Cap frame/ Cylinder frame/ Clamp frame	
1	1000	1	600
2	900	2	550
3	800	3	500
4	700	4	450
5	600	5	400
6	500	–	–
7	400	–	–

The maximum sewing speed setting is specified from the embroidering screen.

When the embroidery machine is purchased, the maximum sewing speed is set to 1000 spm (Cap frame, Cylinder frame or Clamp frame for 600 spm).

For the types of embroidery frames, refer to “Types of embroidery frames/frame holders and their applications” on page 82.

1 To increase the sewing speed, touch . To decrease the sewing speed, touch .

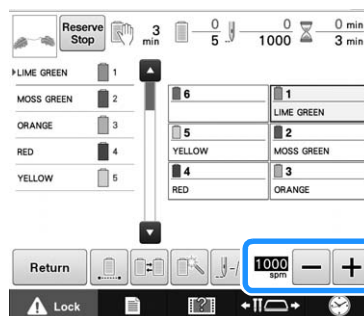

→ The value beside  and  changes.

**Memo**

- You can also specify a maximum sewing speed to a certain needle bar in the reserved needle bar settings (refer to page 120). When you set the slower sewing speed to a certain needle bar, the sewing speed set with the procedure described in this page, will not change the sewing speed on the balance of the needles. It changes the speed of the reserved needle.
- Decrease the sewing speed when embroidering on thin, thick or heavy fabrics. In addition, the machine embroiders more quietly at a slower sewing speed.
- The sewing speed can be changed while embroidery is being sewn.
- The maximum sewing speed setting does not change until a new setting is selected. The setting specified before the machine is turned off remains selected the next time that the machine is turned on.
- Decrease the sewing speed to 400 spm, when using a weak thread like a metallic thread.

Setting the Machine to Stop at Color Changes

The machine can be stopped at any time; however, if the machine is stopped while it is embroidering, it is better to go back a few stitches before continuing sewing to overlap the stitching. If the machine stops at a color change, it is not necessary to go back through the stitching before continuing embroidering.

Stopping the machine at the next color change

The machine can be set to stop before sewing the next color.

- 1** While sewing the color before the point where you wish to stop the machine, touch

Reserve Stop so that it changes to **Reserve Stop**.

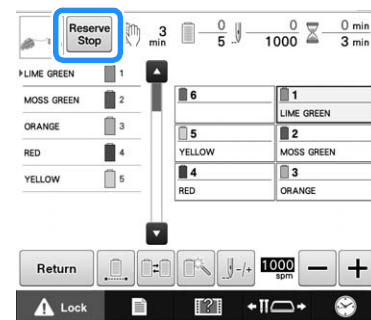

- 2** After finishing sewing the area for the current color, the next needle bar moves into position and the machine stops before sewing the next color.

→ **Reserve Stop** changes back to **Reserve Stop**.

- If the machine is temporarily turned off, you will be asked if you wish to continue sewing or select a new pattern when the machine is turned on again.

Touch **OK** to continue embroidering. (Refer to “Resume Embroidering After Turning Off the Machine” on page 101.)

Specifying pause locations before embroidering

Pause locations can be specified in the pause setting screen, displayed by touching .

- 1 Touch  in the embroidering settings screen.

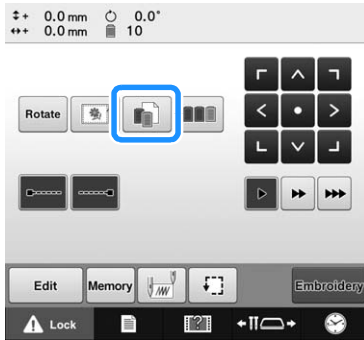



→ The change thread color screen appears.

- 2 From the thread color sequence display, select the thread color where you wish to stop the machine before sewing it.

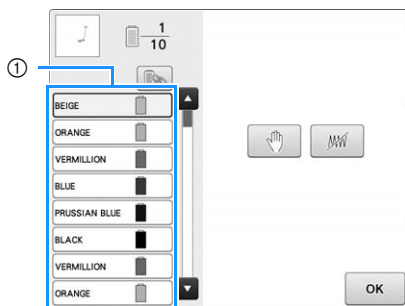
- If the desired thread color is not displayed, use the scroll bar on the right side to display it.



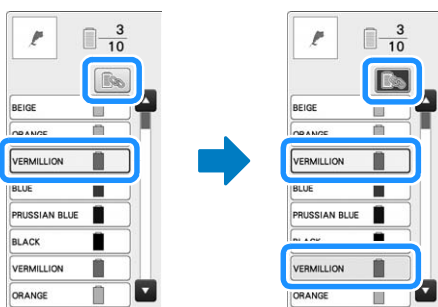

- 1 Scroll bar

- If the same thread color is used more than once, they can be combined. After selecting a thread color, touch . The key changes to , and all thread colors in the thread color sequence display that are the same as the one that was selected are highlighted in blue.

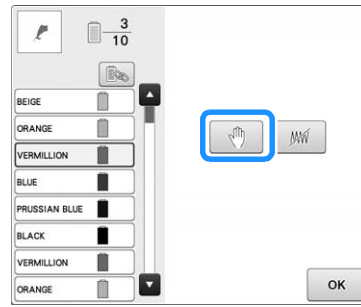

- 3 Touch .



→ The  mark appears to indicate where the machine will stop.

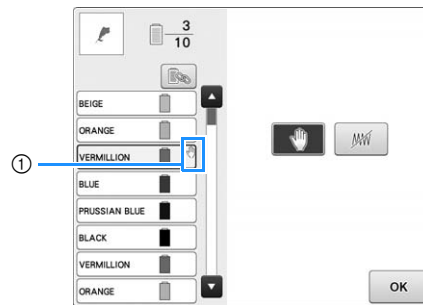

- 1  mark

- To cancel the setting, touch  again.

- 4 Repeat steps 2 and 3 for each pause that you wish to specify.

- Any number of pauses can be specified.

- 5 After specifying the desired settings, touch

.

- If the machine is temporarily turned off when it is stopped at the specified location after embroidering, you will be asked if you wish to continue sewing or select a new pattern when the machine is turned on again.

Touch  to continue embroidering. (Refer to "Resume Embroidering After Turning Off the Machine" on page 101.)

Memo

- If the machine is temporarily turned off, the settings to stop the machine at color changes specified before the machine was turned off are not cancelled. However, the settings are cancelled if a new pattern is selected.
- If a pattern with the settings to stop the machine at color changes is saved, the settings to stop the machine at color changes are also saved.

Temporary Needle Bar Setting

After embroidering begins, the machine can be stopped at a color change and a different needle bar can be specified for the next color to be sewn. By substituting an upper thread color already threaded on a different needle bar, the time for sewing can be saved. For example, similar color thread can be substituted for temporary use.

1 Touch .

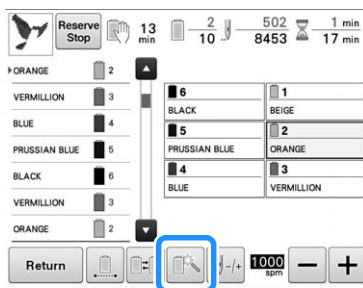

→ The temporary needle bar setting screen appears.

2 Touch the key for the needle bar threaded with the thread that you wish to embroider with.

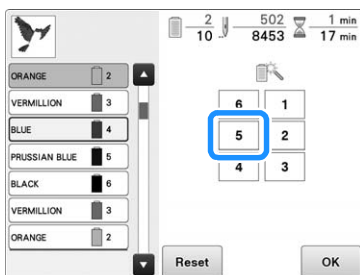

→ The needle bar number changes and  appears to indicate the selected needle bar.

→ To cancel the setting, touch .

3 Touch .

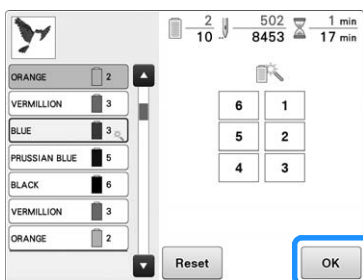

→ The embroidering screen appears again.

Memo

- The thread color (needle bar) cannot be changed in the middle of an area that is being sewn.

Uninterrupted embroidering (monochrome)

A selected pattern can be stitched out in one color instead of multicolor. The machine will hesitate but not stop between color steps, and then continue till the pattern is completed.

1 Touch the key for the needle bar threaded with the thread you wish to embroider uninterruptedly.

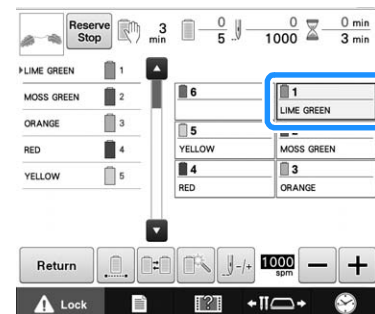

2 Touch for the multicolor steps to become shaded and the selected pattern will embroider in a single color, instead of changing the thread while embroidering.

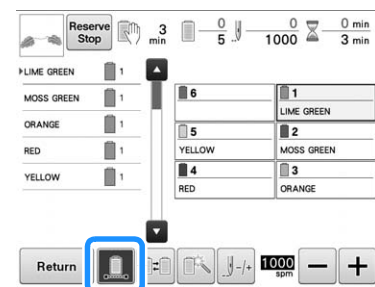

→ The thread color displayed on the screen will be grayed out.

- Touch  again to return to the pattern's original settings.

Memo

- Even if uninterrupted embroidering has been set, the DST thread trimming function can be used (refer to page 184).
- After finishing the embroidery, uninterrupted embroidery will be canceled.

Reserved Needle Bar and Sewing Speed Settings

Normally, the machine automatically assigns thread colors to the needle bars; however, a specific thread color can be manually assigned to a certain needle bar. If a needle bar is specified, that needle bar is removed from the machine's automatic assignments and the specified color remains assigned to it.

By specifically assigning often used thread colors to certain needle bars, the trouble of changing the thread spools can be reduced.

Also, the maximum sewing speed can be specified to the assigned needle bar. It is useful when you specially set a weak thread such as a metallic thread to the assigned needle bar.



Note

- This feature is not accessible through the embroidering screen.
- You can assign thread colors up to 5 needle bars in normal mode. When you set "Manual Color Sequence" to "ON" in settings screen, it is available to assign up to 6 needle bars. If you assign all the 6 needle bars in the "Manual Color Sequence" mode, and then you set the machine to the normal mode, the setting of needle bar 6 is canceled automatically.

Refer to "Selecting/Managing Thread Colors for Each Needle Bar (Manual Color Sequence)" on page 108

Once a manual needle bar setting is specified, it remains applied until the setting is cancelled.

The manual needle bar settings can be specified in page 3 of the settings screen.

- 1 Touch , and then touch and to display page 3 of the settings screen.

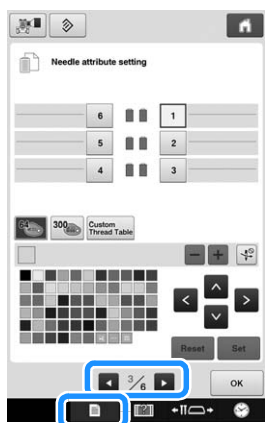

- 2 Touch any of the key from to for the number of the needle bar that you wish to specify.

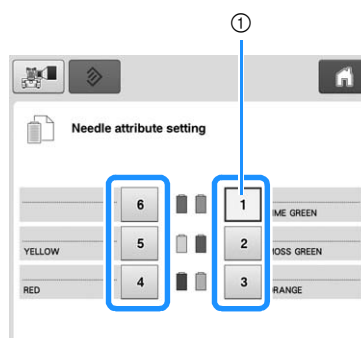

- ① Indicates the number of the selected needle bar

- 3 Select the color to be assigned to the needle bar.

Touch , , and , or directly touch a color, to select the desired color.

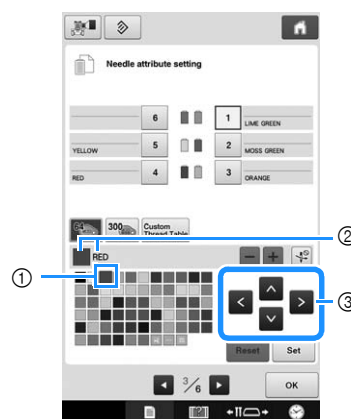

- ① The color that appears enlarged is the color that is selected.
- ② Displays the color that is selected and its name
- ③ Highlighting a color square moves in the direction of the arrow on the key that is touched.

- 4 Touch .

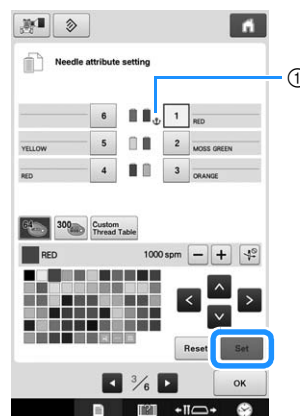

→ The color selected in step 3 is specified.

- ① The selected color of thread and appear on the spool.

5 Touch **-** or **+** to set the maximum sewing speed for the assigned needle bar.

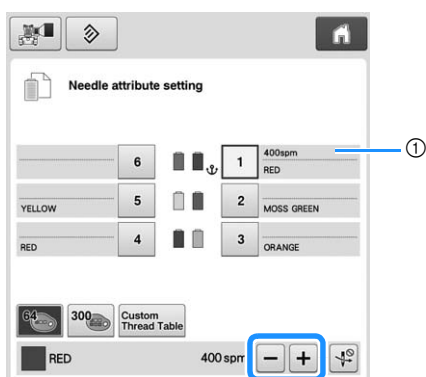

① Value of maximum sewing speed setting

Memo

- Decrease the sewing speed to 400 spm, when you specially set a specialty thread such as a metallic thread to the assigned needle bar.
- The maximum sewing speed specified here is always effective to the assigned needle bar, even if you set the faster speed in the embroidering screen (refer to page 116).

6 If necessary, touch **⏏** to cancel automatic needle threading.

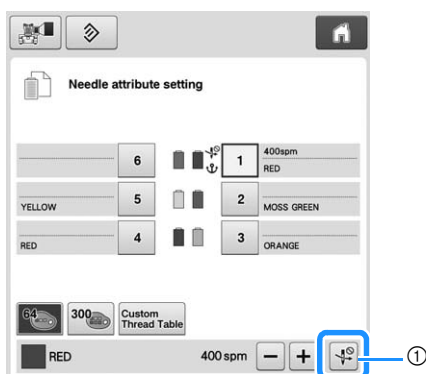

① Disable needle threader key

7 Touch **OK**.

- Specified needle bar is indicated with **⚓** and the specified maximum sewing speed in the embroidering screen.

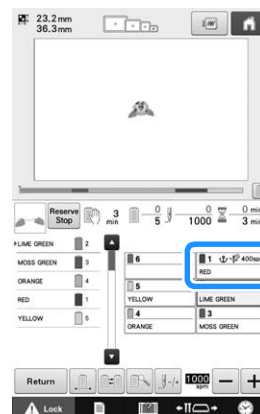

■ Cancelling the setting

To change the setting, first cancel it, and then select the new setting.

1 Touch any of the key from **1** to **6** for the number of the needle bar whose setting you wish to cancel.

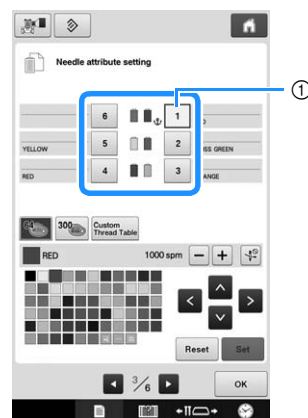

① Indicates the number of the selected needle bar

2 Touch **Reset**.

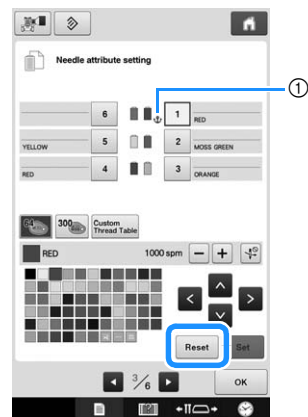

- ① **⚓** disappears from the thread spool.
→ This cancels the manual needle bar setting.



- 3** To cancel the cancel needle threading setting, touch  again.

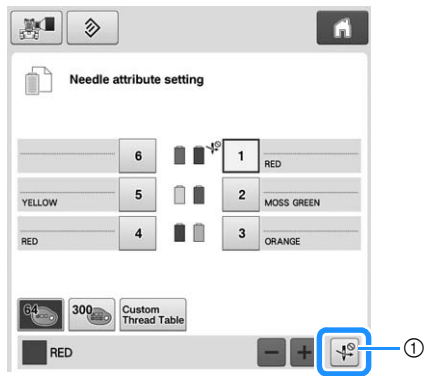

- ① Disable needle threader key



Memo

- Follow the procedure from step **3** on page 120, to assign the other thread color to the needle bar you canceled the setting.

This chapter provides details on selecting, editing and saving embroidery patterns.

Using the Memory Function

Embroidery data precautions

Observe the following precautions when using embroidery data other than that created and saved in this machine.

CAUTION

- When using embroidery data other than our original patterns, the thread or needle may break when sewing with a stitch density that is too fine or when sewing three or more overlapping stitches. In that case, use one of our original data design systems to edit the embroidery data.

■ Types of embroidery data that can be used

- Only .pen, .pes, .phc and .dst embroidery data files can be used with this machine. Using data other than that saved using our data design systems or embroidery machines may cause the embroidery machine to malfunction.

■ Types of USB devices/media that can be used

Stitch data can be saved to or recalled from USB media. Use media that meets the following specifications.

- USB Flash drive (USB Flash memory)
- USB Floppy disk drive

Stitch data can be recalled only.

- USB CD-ROM, CD-R, CD-RW drives

You can also use the following types of USB media with USB Memory Card Reader/USB card writer module.

- Secure Digital (SD) Card
- CompactFlash
- Memory Stick
- Smart Media
- Multi Media Card (MMC)
- xD-Picture Card



Note

- The processing speed may vary by quantity of data stored.
- Some USB media may not be usable with this machine. Please visit our website (<http://s.brother/cpbac>) for more details.
- The access lamp will begin blinking after inserting USB devices/media, and it will take about 5 to 6 seconds to recognize the devices/media. (Time will differ depending on the USB device/media).



Memo

- To create file folders, use a computer.
- Letters and numerals can be used in the file names.

■ Connecting your machine to the PC

- Compatible models:
IBM PC with a USB port as standard equipment
IBM PC-compatible computer equipped with a USB port as standard equipment
- Compatible operating systems:
Microsoft Windows 7, Windows 8.1, Windows 10

■ Precautions on using the computer to create and save data

- If the name of the embroidery data file/folder cannot be identified, for example, because the name contains special characters, the file/folder is not displayed. If this occurs, change the name of the file/folder. We recommend using the 26 letters of the alphabet (uppercase and lowercase), the numbers 0 through 9, "-", and "_".
- Embroidery data larger than 200 mm (H) × 300 mm (W) (approx. 7-7/8 inches (H) × 11-3/4 inches (W)) cannot be used. (All patterns must be within the 200 mm (H) × 300 mm (W) (approx. 7-7/8 inches (H) × 11-3/4 inches (W)) pattern field size.)
- .pes files saved with the number of stitches or the number of colors exceeding the specified limits cannot be displayed. The combined pattern can not exceed a maximum number of 500,000 stitches or a maximum number of 127 color changes (Above numbers are approximate, depending on the overall size of the pattern). Use one of our pattern software programs to edit the embroidery pattern so that it meets these specifications.
- Embroidery data stored in a folder created in USB media can be retrieved.
- Do not create folders in "Removable Disk" on a computer. If embroidery data is stored in a folder in "Removable Disk", that embroidery data cannot be retrieved by the machine.

■ Tajima (.dst) embroidery data

- Since Tajima (.dst) data does not contain specific thread color information, it is displayed with our default thread color sequence. Check the preview and change the thread colors as desired.

Concerning USB media

- Do not disassemble or alter the USB media.
- Do not allow the USB media to become wet, such as with water, solvents, drinks or any other liquids.
- Do not use or store the USB media in a location exposed to strong static electricity or electrical interference.
- Do not use or store USB media in locations exposed to vibrations or impacts, direct sunlight, extreme dust (or lint), high temperatures, high humidity, severe temperature fluctuations, or strong magnetic forces (such as from speakers).
- While embroidery data is being recalled from the USB media, do not allow the machine to be exposed to vibrations or impacts, and do not attempt to remove the USB media from the machine.
- Some USB media may not be usable with this machine. Please visit our web site (<http://s.brother/cpbac>) for more details.
- Only remove USB media while an access lamp on the USB media is not flashing (refer to “Saving embroidery patterns to USB media/SD card” on page 135).
- For additional information, refer to the instruction manual included with the USB media that you have purchased.
- Do not unplug a USB device/media from this machine immediately after it has been plugged in. Be sure to wait at least 5 seconds before unplugging the USB device/media.

Selecting an Embroidery Pattern

Various embroidery patterns are built into this machine. Other than the built-in patterns, various other patterns can be selected from embroidery cards (optional) and from the computer.

General pattern selection

The procedure for selecting a pattern differs depending on the type of pattern; however, the general procedure for selecting a pattern is described below.

- 1 In the pattern type selection screen, touch the key for the desired category.

■ Pattern type selection screen

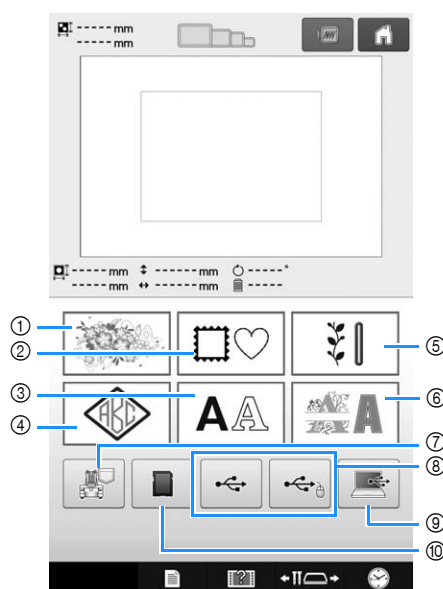

- ① Embroidery patterns
- ② Frame patterns
- ③ Alphabet patterns
- ④ Monogram and frame patterns
- ⑤ Utility embroidery patterns/Large buttonhole patterns
- ⑥ Decorative alphabet patterns
- ⑦ Embroidery patterns stored in the machine's memory
- ⑧ Embroidery patterns saved on USB media
- ⑨ Embroidery patterns saved on a computer (USB)
- ⑩ Embroidery patterns saved on an SD card

- 2 In the pattern category list screen, which appears next, touch the desired pattern category to select it.

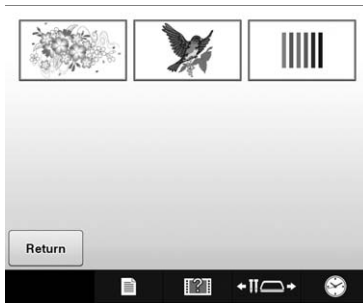

- 3 In the pattern list screen, which appears next, touch the desired pattern to select it.

■ Pattern list screen

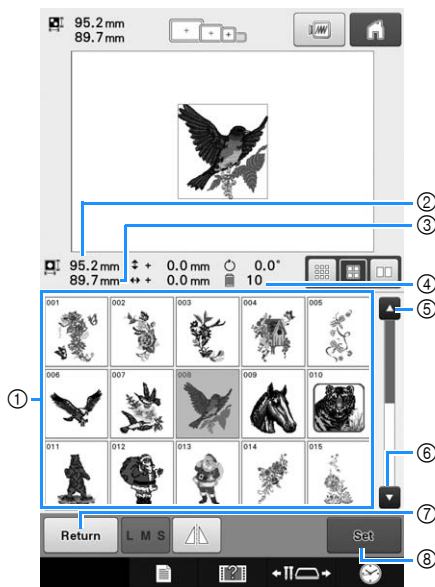

- ① Pattern keys
Touch a pattern to display the following information of the pattern.
- ② Vertical length of the pattern
- ③ Horizontal width of the pattern
- ④ Number of thread color changes
- ⑤, ⑥ If there is more than one page, touch ▲ or ▼ until the desired page is displayed.
- ⑦ Touch **Return** to return to pattern type selection screen to change category.
- ⑧ Touch to confirm the pattern, and move to the pattern editing screen.

Memo

- If there are multiple pages in the pattern list, drag your finger up and down in the pattern area to scroll through the pages.

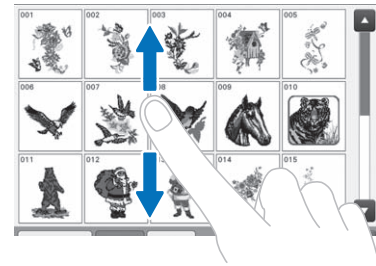

■ Changing the size of pattern keys

The size of pattern keys can be set to “Small”, “Medium” or “Large”. When the embroidery machine is purchased, “Medium” is selected.



- ① “Large” pattern key size

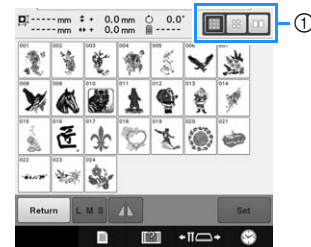

- ① “Small” pattern key size

Embroidery patterns

- 1 Touch .

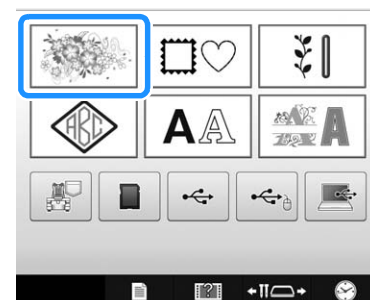

→ The embroidery pattern categories appears.

2 Select an embroidery pattern category.

Touch the desired category.

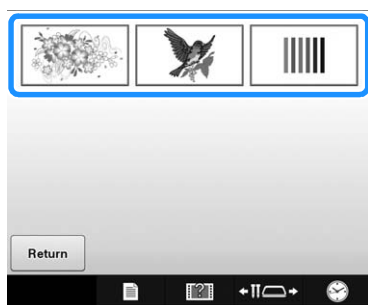

→ The list of embroidery patterns appears.

3 Select an embroidery pattern.

Touch the desired pattern.

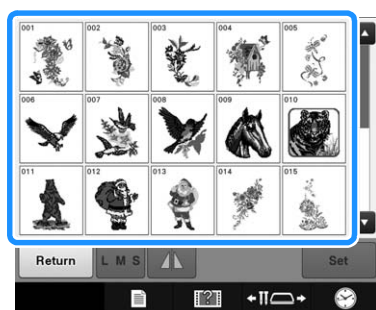

→ The selected pattern appears in the pattern display area.

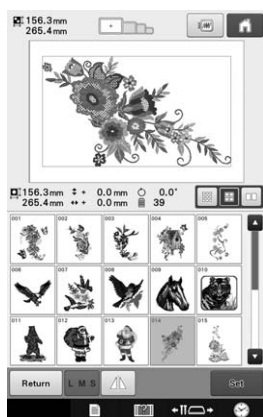

- If the wrong pattern was selected or you wish to select a different pattern, touch the desired pattern.

4 Touch .

This confirms the pattern selection.

→ The pattern editing screen appears.

Frame patterns

1 Touch .



→ The list of frame patterns appears.

2 From the upper tabs of the screen, select the desired shape for the frame.

Touch the desired frame shape.

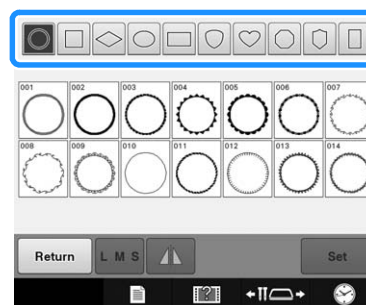

→ The available frame patterns appear in the lower half of the screen.

3 Select a frame pattern.

Touch the desired pattern.

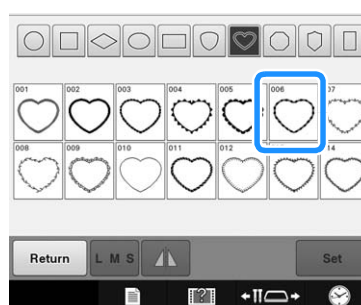

→ The selected pattern appears in the pattern display area.

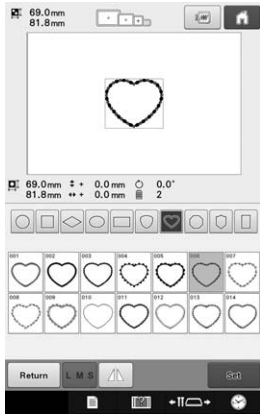

- If the wrong pattern was selected or you wish to select a different pattern, touch the desired pattern.

4 Touch **Set**.

This confirms the pattern selection.
→ The pattern editing screen appears.

Utility embroidery patterns/ Large buttonhole patterns

Utility embroidery patterns and large buttonhole patterns can be selected.

1 Touch .

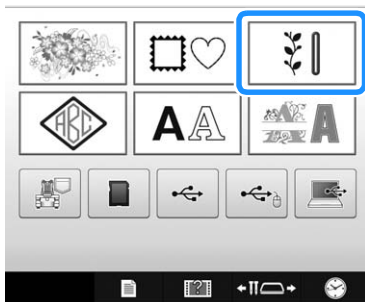

→ The pattern categories appears.

2 Select a pattern category.

Touch the desired pattern category.



→ The list of patterns of the selected category appears.

3 Select a pattern.

Touch the desired pattern.

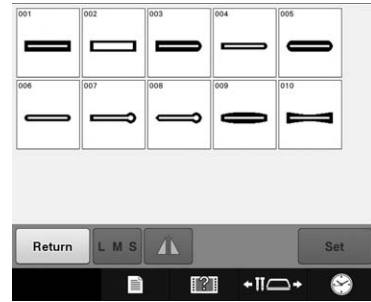

→ The selected pattern appears in the pattern display area.

4 If necessary, edit the pattern.

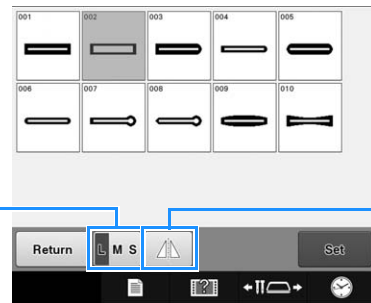

- ① Large buttonhole patterns can be selected from small, medium and large sizes.
- ② Touch this key to mirror the pattern.

5 Touch **Set**.

This confirms the pattern selection.
→ The pattern editing screen appears.

Monogram and frame designs

Monogram designs can be created by combining two or three letters. Frame patterns are also available for these types of designs.

1 Touch .

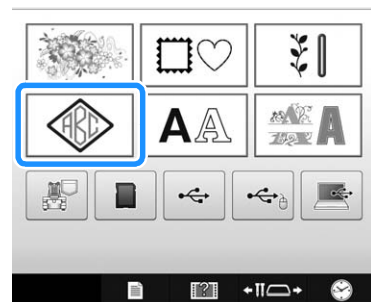

→ The design selection screen appears.



2 Select the monogram design.

Touch the button for the desired character style.

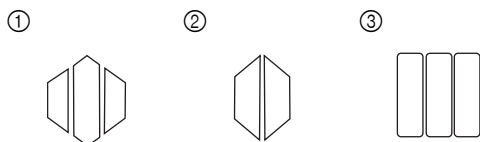
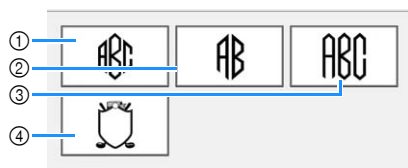

→ The text input screen appears.

- If ④ is selected, the frame pattern list appears. When creating a pattern by combining letters with a frame, it does not matter which of the two, the letters or the frame, is selected first. The sewing order follows the order in which the parts of the monogram are selected. For this example, we will select the letters first.

3 Select the characters.

Touch the tabs to select different character shapes, and then touch the key for one letter on each tab.

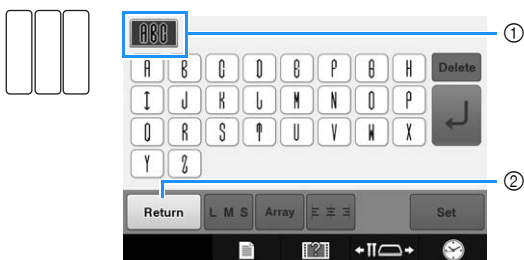
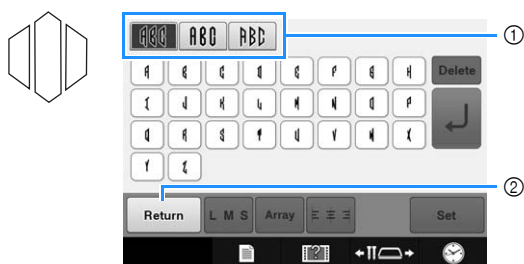

* Since the shapes of the letters are the same with this design, there are no tabs to select. On this screen, select three letters.

- ① Tabs
- ② To change the character font, touch Return to return to the design selection screen.

→ The selected characters appear in the text preview area and the pattern display area.

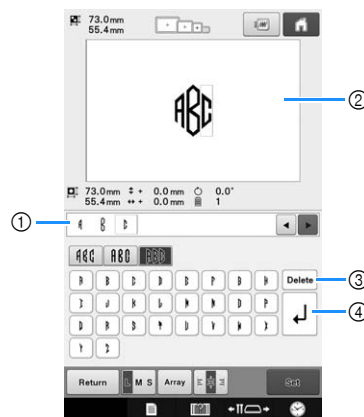

- ① Text preview area
- ② Pattern display area
- ③ If the wrong character was selected or you wish to select a different character, touch Delete to delete the last character selected, and then touch the desired character.
- ④ Line feed key

Memo

- Depending on the design, there is a preset number of letters; however, more than the preset number of letters can be entered. If too many letters are selected, touch Delete to delete the letters.
- If desired, multiple letters can be selected to use these characters in the same way as any other character pattern without creating a monogram.

4 If necessary, edit the characters.

- For details on editing characters, refer to “Alphabet patterns” on page 130.



- ① Touch this key to change the size of the characters.
- ② Touch this key to change the text arrangement.
- ③ Touch this key to change the text alignment.

■ Changing the pattern size

After selecting the first character, touch **LMS** until the character is the desired size.

- The next character that is selected will have the new character size.
- The character size of all entered characters cannot be changed after the characters are combined. (The size of the entire pattern can be changed from the pattern editing screen.)

■ Selecting a character

A character can be selected in either the text preview area or the pattern display area.

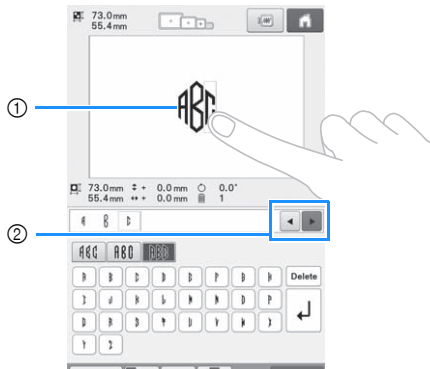

- ① Directly select a character.
- ② Touch **←** and **→** to move the cursor and select a character.

5 Touch **Set**.

This confirms the character selection.

→ The pattern editing screen appears.
Next, we will combine the letters with a frame.

6 Touch **Add**.

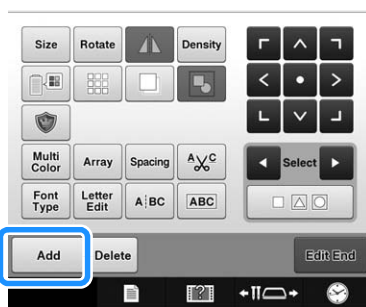

→ The pattern type selection screen appears.

7 Touch .

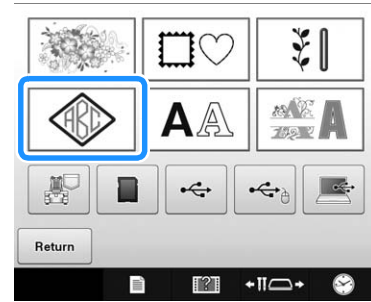

→ The design selection screen appears.

8 Touch .



→ The list of frame patterns appears.

9 Select a pattern.

Touch the desired pattern.

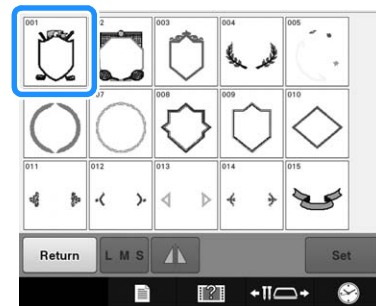

→ The selected frame pattern appears in the pattern display area.

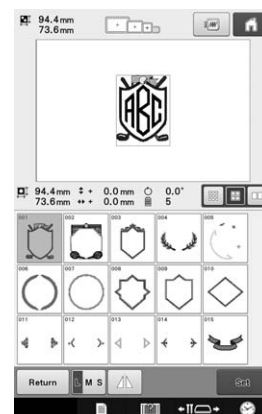

- If the wrong pattern was selected or you wish to select a different pattern, touch the desired frame pattern.

10 Touch **Set**.

This confirms the frame selection.
 → The pattern editing screen appears.

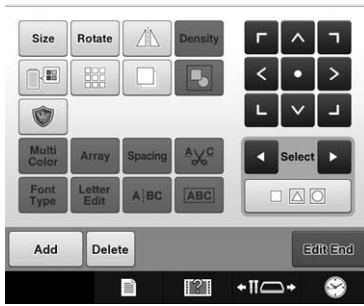

Memo

- Due to size or shape, some frame patterns cannot be used with the [] design.
- The frame patterns are just some of the patterns that can be used. Character patterns other than the 3-letter monogram patterns can be used in the combination.

Alphabet patterns

There are 37 built-in character fonts.

Example: Entering “Lucky Color”.

1 Touch **AA**.



→ The font selection screen appears.

2 Select a character font.

Touch the desired character font.

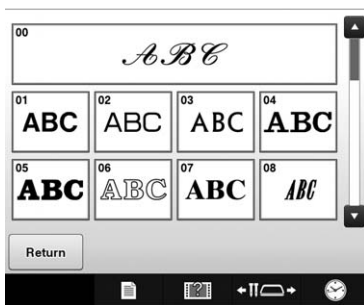

- Touch ▲ or ▼ for additional selections.
- The text input screen appears.

3 If the key for the character that you wish to select is not displayed, touch the tab for the desired set of characters.

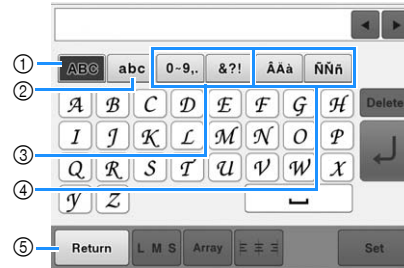

- ① Uppercase letters
 - ② Lowercase letters
 - ③ Numbers/symbols
 - ④ Accented characters
 - ⑤ Touch this key to change the character font.
 → The text input screen for the characters shown on the tab appears.
- To change the character font, touch **Return** to return to the font selection screen.

4 Enter “L”.

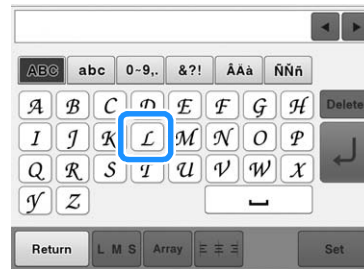

→ The selected characters appear in the text preview area and the pattern display area

5 With the first character entered, touch  to change the size of the character.

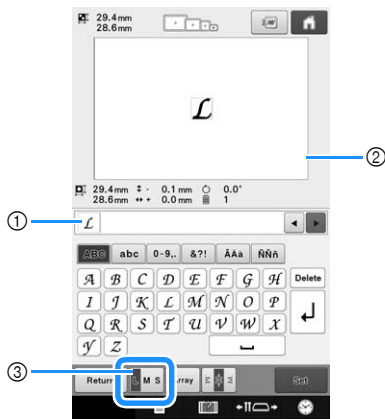

- ① Text preview area
- ② Pattern display area
- ③ Touch this key to change the size.

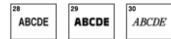
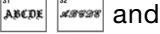

- The next characters that are selected will have the new character size.
- The character size of all entered characters cannot be changed after the characters are combined. (The size of the entire pattern can be changed from the pattern editing screen.)

 **Note**

- Size of the six small fonts  and  cannot be changed. All of these smaller fonts are shown on page 4/4 of the font selection screen.

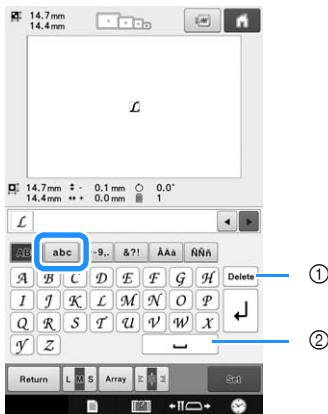
6 Touch  and enter “ucky”.



- ① If the wrong character was selected or you wish to select a different character, touch  to delete the last character selected, and then touch the key for the desired character. Each touch of  deletes the last character of the text.
- ② Touch  to enter a space.

7 Touch  to enter a line feed.

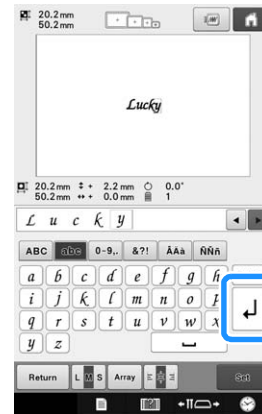

8 Touch  and enter “C”.

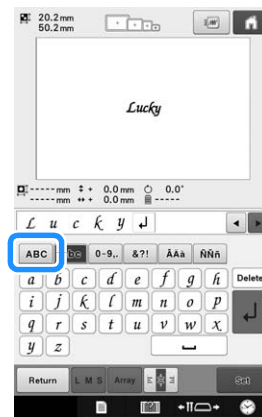

9 Touch  and enter “olor”.

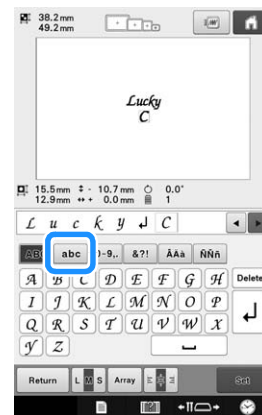

5

10 Even after text has been entered, characters can be selected and edited (resized, etc.).

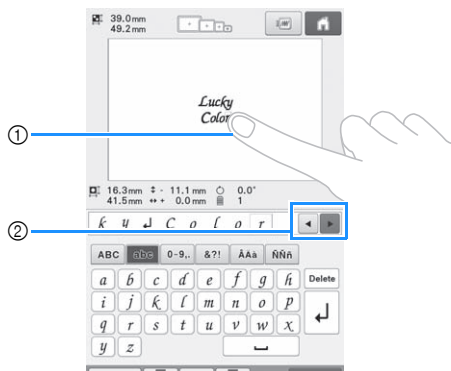

- ① Directly select a character.
- ② Touch ◀ and ▶ to move the cursor and select a character.

11 After entering all of the text as desired, touch **Set**.

This confirms the pattern selection.
→ The pattern editing screen appears.



Memo

- The color of the text is set to black. To change the color, refer to “Specifying multi-color text” on page 156 and “Changing the colors of the pattern” on page 157.

Changing the text arrangement

Touch **Array** to display the screen shown below. Touch the key for the desired text arrangement. After selecting the desired text arrangement, touch **OK** to return to the text input screen.



- Arranges the text on a straight line.
- Arranges the text on the outside of a wide curve.
- Arranges the text on the inside of a wide curve.
- Arranges the text on a slanted line.
- Arranges the text on the outside of a sharp curve.
- Arranges the text on the inside of a sharp curve.
- If text is arranged on a curve, each touch of this key decreases the bend of the curve (makes it flatter).
- If text is arranged on a curve, each touch of this key increases the bend of the curve (makes it more curved).



- If the text is arranged using one of the text arrangements on this screen, even more characters can be entered.



Memo

- If the text contains a line feed, changes to the text arrangement are only applied to the line containing the selected character.

■ Changing the text alignment

Touch  to change the text alignment. Continue pressing  until the desired text alignment is selected.

When the key displayed as , text is aligned to the left.

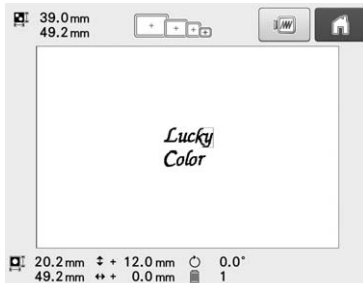

When the key displayed as , text is aligned to the center.

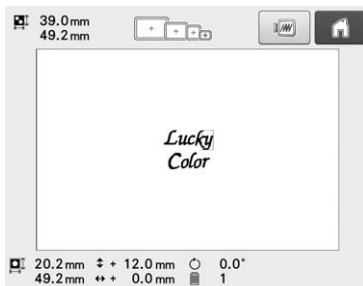

When the key displayed as , text is aligned to the right.

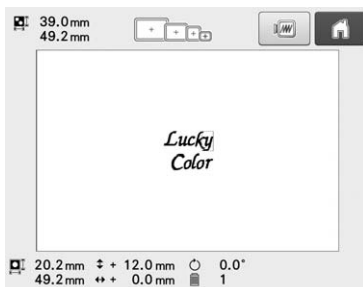

Decorative alphabet patterns

1 Touch .

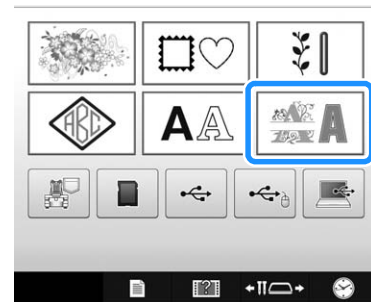

→ The list of decorative alphabet categories appears.

2 Select a decorative alphabet category.

Touch the desired category.

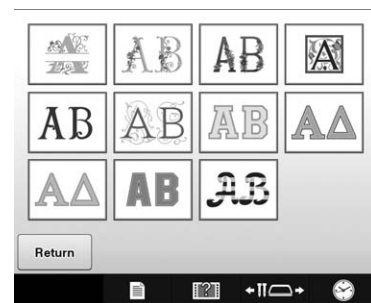

→ The list of the patterns in the selected category appears.

3 Select an embroidery pattern.

Touch the desired pattern.

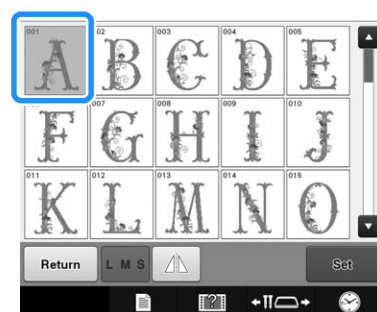

→ The selected pattern appears in the pattern display area.

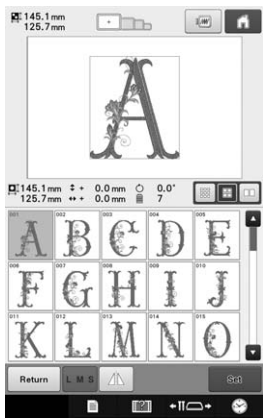

- If the wrong pattern was selected or you wish to select a different pattern, touch the desired pattern.

4 If necessary, edit the pattern.

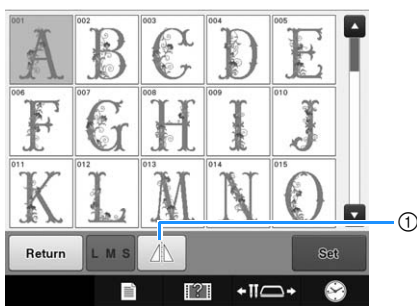

① Touch this key to flip the pattern horizontally.

5 Touch **Set**.

This confirms the pattern selection.
→ The pattern editing screen appears.

■ Appliqué alphabet

1 Touch .

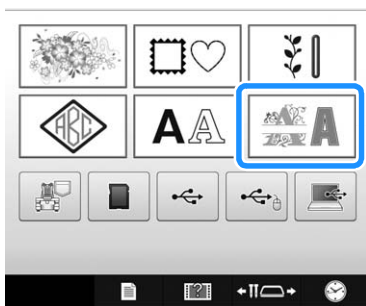

→ The list of decorative alphabet categories appears.

2 Touch .



→ The list of appliqué alphabets appears.

3 Select an embroidery pattern.

Touch the desired pattern.

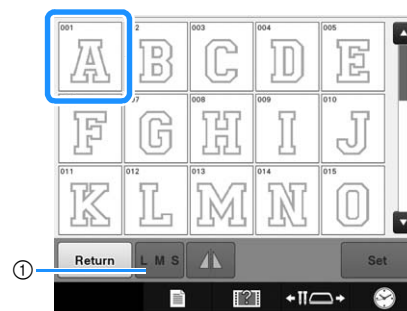

① Touch this button to change the character size.
→ The selected pattern appears in the pattern display area.

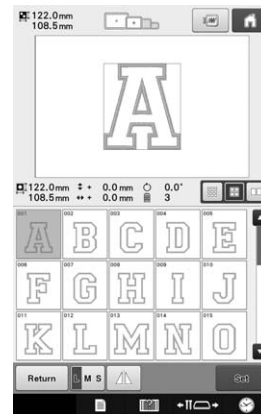

- If the wrong pattern was selected or you wish to select a different pattern, touch the desired pattern.

4 Touch **Set**.

This confirms the pattern selection.
→ The pattern editing screen appears.

 **Memo**

- For details on sewing appliqués, refer to “Sewing appliqué patterns” on page 191.

Saving embroidery patterns in the machine's memory

You can save embroidery patterns that you have customized and will use often; for example, your name, patterns that have been rotated or had the size changed, patterns that have had the embroidering position changed, etc. A total of about 10 MB of patterns can be saved in the machine's memory.



Note

- Do not turn the main power to OFF while the "Saving..." screen is displayed. You will lose the pattern you are saving.



Memo

- It takes a few seconds to save a pattern to the machine's memory.
- See page 137 for information on retrieving a saved pattern.

- Touch **Memory** when the pattern you want to save is in the embroidering settings screen.

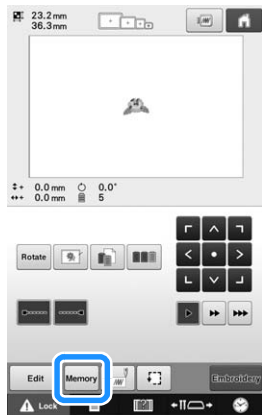

- Touch .

* Touch **Cancel** to return to the original screen without saving.

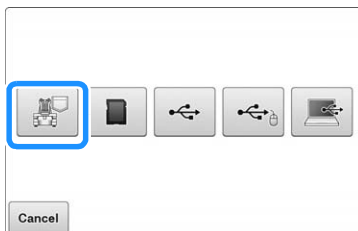

→ The "Saving..." screen is displayed. When the pattern is saved, the display returns to the original screen automatically.

If the memory is full

If the screen below displays, either the maximum number of patterns have been saved or the pattern you want to save takes a lot of memory, and the machine cannot save it. Press **OK** and delete a previously saved pattern, then you can save the current pattern. Refer to "Retrieving patterns from the machine's memory" on page 137.

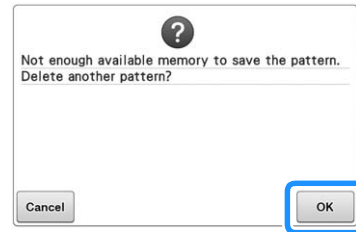

Saving embroidery patterns to USB media/SD card

When sending embroidery patterns from the machine to USB media/SD card, plug the USB media/SD card into the machine's USB port/SD card slot.



Memo

- USB media is commercially available, but some USB media may not be usable with this machine. Please visit our website (<http://s.brother/cpbac>) for more details.
- Depending on the type of USB media being used, either directly plug the USB device into the machine's USB port or plug the USB media Reader/Writer into the machine's USB port.
- The USB media/SD card can be inserted or removed at any time.

- Touch **Memory** when the pattern you want to save is displayed in the embroidering settings screen.

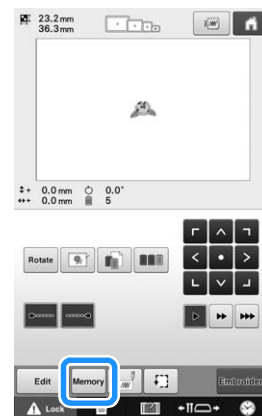

2 Insert the USB media/SD card into the USB port/SD card slot on the machine.

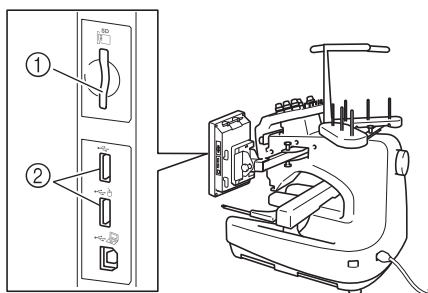

- ① SD card slot
- ② USB ports

Note

- Do not insert anything other than USB media into the USB media port. Otherwise, the USB media drive may be damaged.
- Do not insert anything other than SD card into the SD card slot. Otherwise, the SD card slot may be damaged.

3 Touch ,  or .

- * Touch  to return to the original screen without saving.

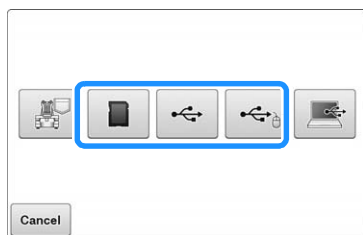

→ The “Saving...” screen is displayed. When the pattern is saved, the display returns to the original screen automatically.

Note

- Do not insert or remove USB media/SD card while “Saving...” screen is displayed. You will lose some or all of the pattern you are saving.

Saving embroidery patterns in the computer

Using the included USB cable, the machine can be connected to your computer, and the embroidery patterns can be temporarily retrieved from and saved in the “Removable Disk” folder in your computer. An approximate of 5 MB of embroidery patterns can be saved in the “Removable Disk”, but the saved embroidery patterns are deleted when the machine is turned OFF.

For Computers and Operating Systems, refer to “Connecting your machine to the PC” on page 123.

Note

- Do not turn the main power to OFF while the “Saving...” screen is displayed. You will lose the pattern you are saving.

1 Plug the USB cable connector into the corresponding USB ports for the computer and for the machine.

- * The USB cable can be plugged into the USB ports on the computer and embroidery machine whether or not they are turned on.

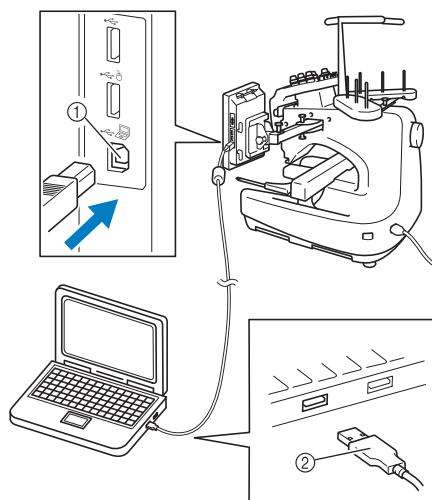

- ① USB port for computer
- ② USB cable connector

→ The “Removable Disk” icon will appear in “Computer (My Computer)” on the computer.

Note

- The connectors on the USB cable can only be inserted into a port in one direction. If it is difficult to insert the connector, do not insert it with force. Check the orientation of the connector.
- For details on the position of the USB port on the computer (or USB hub), refer to the instruction manual for the corresponding equipment.

- 2 Turn on your computer and select "Computer (My Computer)".
- 3 Touch **Memory** when the pattern you want to save is in the embroidering settings screen.

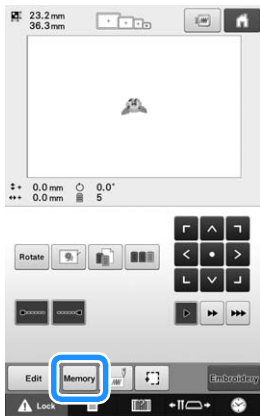

- 4 Touch .

* Touch **Cancel** to return to the original screen without saving.

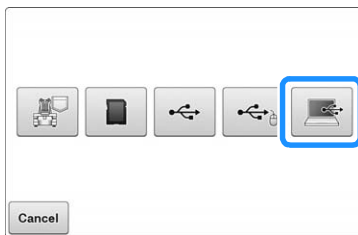

→ The pattern will be temporarily saved to "Removable Disk" under "Computer (My Computer)".

- 5 Select the pattern's .phc file in "Removable Disk" and copy the file to the computer.

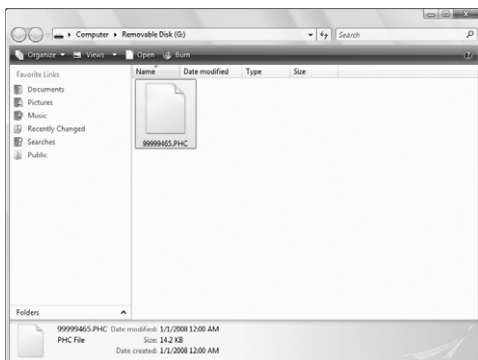

Retrieving patterns from the machine's memory

- 1 Press .

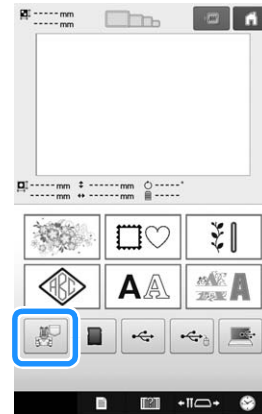

→ The machine displays the patterns currently in the memory.

- 2 Touch the key of the pattern you want to retrieve.



- 3 Touch **Set**.

* Touch **Delete** to delete the embroidery pattern.

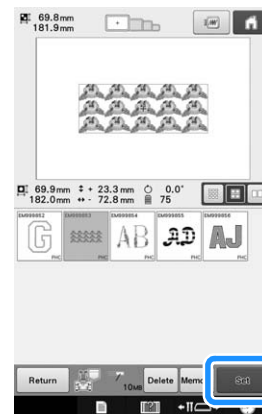

→ The embroidering screen is displayed.

5

Recalling from USB media/SD card

You can recall a specific embroidery pattern from either direct USB media/SD card or a folder in the USB media/SD card. If the pattern is in a folder, check each folder to find the embroidery pattern.



Note

- The processing speed may vary by quantity of data.

- 1 Insert the USB media/SD card into the USB port/SD card slot on the machine.

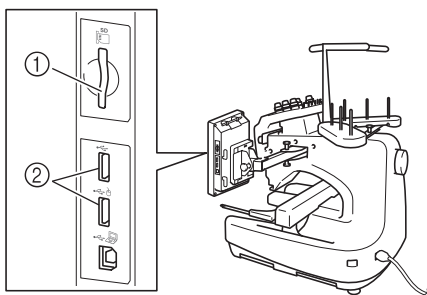

- 1 SD card slot
- 2 USB ports

- 2 Touch ,  or .

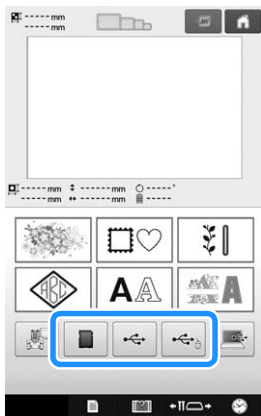

→ Embroidery patterns and a folder in a top folder are displayed.

- 3 Touch  when there is a subfolder to sort two or more stitch patterns to USB media/SD card, the embroidery pattern in the subfolder is displayed.

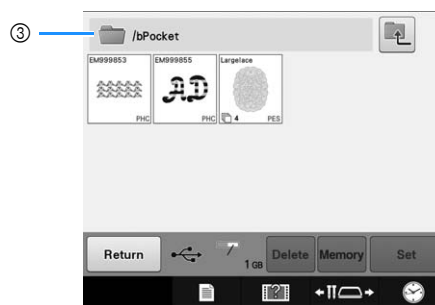
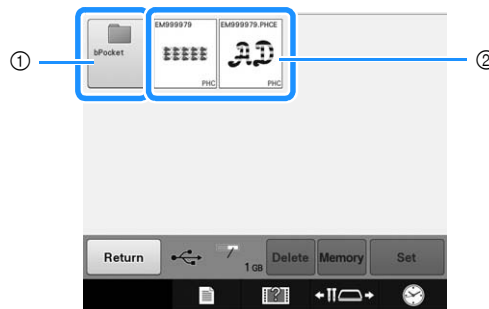

- 1 Folder name
 - 2 Embroidery patterns in USB media/SD card
 - 3 Path
- * The path to show the current folder at the top of the list.
 - * Embroidery patterns and subfolders within a folder are displayed.
 - * Press  to return to the previous folder.
 - * Use the computer to create folders. Folders cannot be created with the machine.

- 4 Touch the key of the pattern you want to retrieve.

- * Touch  to return to the original screen.

5 Touch **Set**.

* Touch **Delete** to delete the pattern from the USB media/SD card.

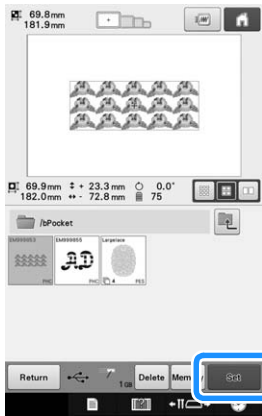

→ The Embroidery Edit screen is displayed.

Recalling from the computer

Refer to “Connecting your machine to the PC” on page 123 for the available computer operating systems.

1 Plug the USB cable connector into the corresponding USB ports for the computer and for the machine. (Refer to “Saving embroidery patterns in the computer” on page 136.)

2 On the computer, open “Computer (My Computer)” then go to “Removable Disk”.

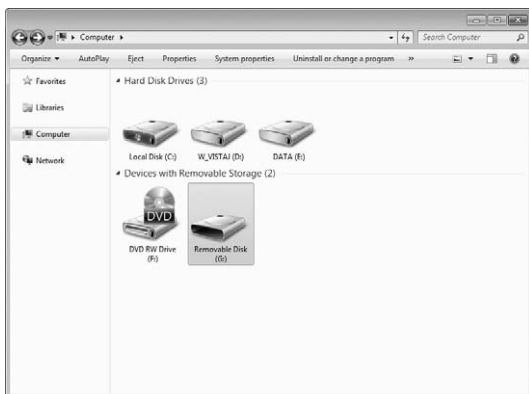

3 Move/copy the pattern data to “Removable Disk”.

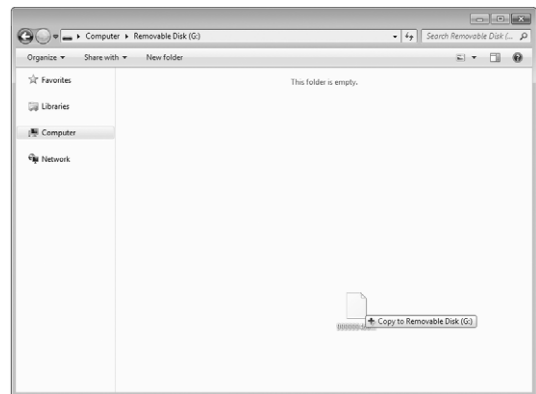

→ Pattern data in “Removable Disk” is written to the machine.

Note

- While data is being written, do not disconnect the USB cable.
- Do not create folders within “Removable Disk”. Since folders are not displayed, stitch pattern data within folders cannot be recalled.

5

4 Press .

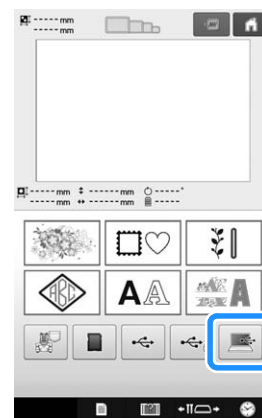

→ The patterns in the computer are displayed on the selection screen.

5 Touch the key of the pattern you want to recall.



6 Touch .

* Touch  to delete the pattern from the computer.

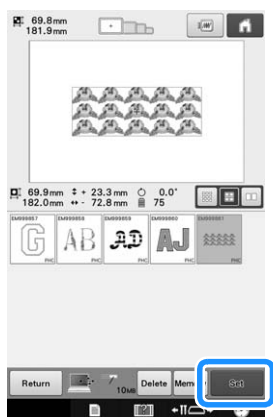

→ The Embroidery Edit screen is displayed.

With patterns larger than 200 mm (H) × 300 mm (W) (7-7/8 inches (H) × 11-3/4 inches (W))

When a pattern larger than 200 mm (H) × 300 mm (W) (7-7/8 inches (H) × 11-3/4 inches (W)) is selected, the following message appears.

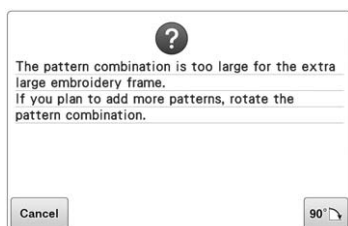

Touch  to rotate the pattern 90 degrees before opening it.

If the data is larger than 200 mm (H) × 300 mm (W) (7-7/8 inches (H) × 11-3/4 inches (W)) even after it is rotated 90 degrees, the following message appears.

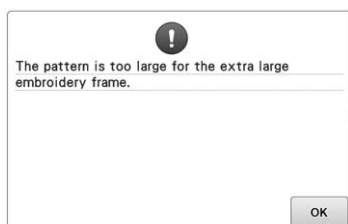

Touch  to return to the pattern list screen.

Memo

- Perform the same operation when a pattern larger than 200mm (H) x 300mm (W) is selected, whether from SD card, USB media, or computer.

If the desired pattern cannot be recalled

When recalling pattern data from the computer, the data is not taken directly from the computer. Instead, the pattern data is temporarily written to the machine, and that written pattern data is recalled. A total of about 10 MB of embroidery patterns can be saved in the “Removable Disk”. Pattern data cannot be recalled if that data amount is exceeded.

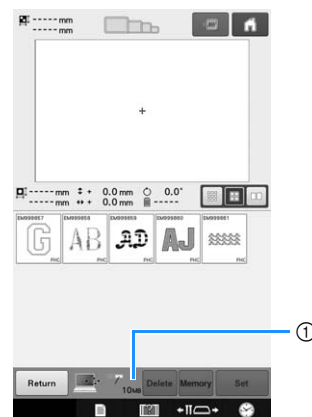

- ① Shows the amount of free space in the USB area of the machine. If pattern data with this size is added, it can be recalled (temporarily written).

To recall a pattern larger than the amount of space available, delete any currently written patterns, and then place the pattern that you wish to recall into the folder.

1 Remove all unnecessary patterns from the “Removable Disk” folder on the computer.

Select the pattern data, and then move it to a different folder, the Recycle Bin, or right-click it and click “Delete”.

2 Place the pattern that you wish to recall into the “Removable Disk” folder.

→ After writing the data to the embroidery machine, the key for that pattern appears in the screen.

3 If the desired pattern can still not be written, repeat steps 1 and 2.

Saving embroidery patterns from any memory source to another memory

Embroidery patterns saved in the machine's memory, USB memory, SD card, or PC can be transferred to each other.

- 1 On the home screen, press the key you want to retrieve/recall from.

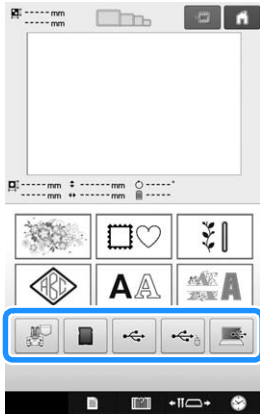

- 2 Touch the key of the pattern you want to save.



- 3 Touch **Memory**.



- 4 Choose the memory you want to save.

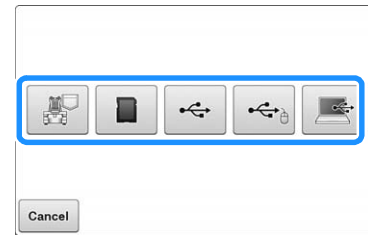

→ Embroidery pattern is saved.



Note

- When saving the embroidery pattern to USB media/SD card, the pattern is saved in the "bPocket" folder.

Sending Embroidery Patterns From a Computer to the Machine (Link Function)

This machine is compatible with the Link function. This function allows embroidery patterns edited in embroidery editing software provided with the Link function, such as PE-DESIGN NEXT or later, to be transferred from a computer to multiple embroidery machines. As many as 100 embroidery patterns can be transferred to an embroidery machine, and the embroidering status of the patterns being transferred can be viewed from the computer monitor. Use the included USB cable to connect the embroidery machine to a computer.

Operations available with the Link function

■ Send multiple embroidery patterns to connected embroidery machines

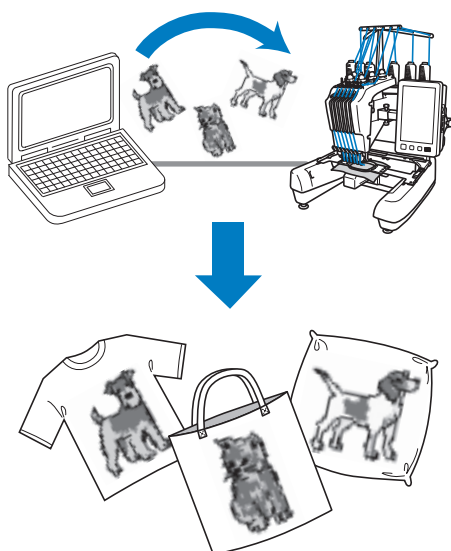

■ Check the sewing status of the embroidery machine (this model) from the computer

(Example of multiple machines connected)

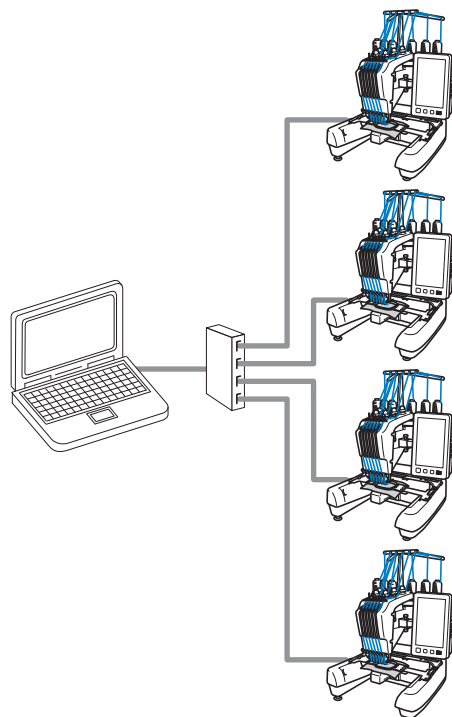

Memo

- When connecting multiple embroidery machines to the computer, use a commercially available USB hub. Please note that we recommend you use a self-powered USB hub. Do not use USB extension cables or repeater cables. For details on using the USB hub, refer to its operating instructions.



Embroidering using the Link function

First, use the embroidery editing software to create the embroidery pattern to be sent to the embroidery machine.



Note

- Embroidery data in the PES format (.pes) and the PEN format (.pen) can be embroidered using the Link function.
- The Link function cannot be used with large-size (split) embroidery patterns.
- Attach to the embroidery machine the embroidery frame for the size of the pattern to be sent.

1 Touch , and then touch  and  to display page 5 of the settings screen.

2 Touch  to enable the Link function.



→ When the following message appears, touch .

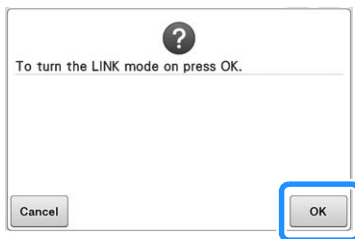

3 Turn off the machine.

4 Use the included USB cable to connect the embroidery machine to the computer.

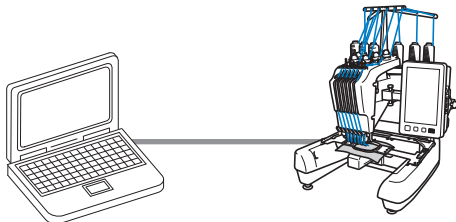

5 Turn on the machine.

6 Using embroidery editing software provided with the Link function, such as PE-DESIGN NEXT or later from a computer, send the embroidery pattern to the machine in the Link mode.

7 When the following message appears, touch

 .

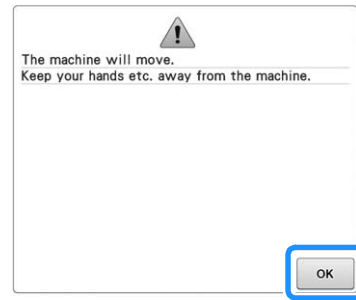

→ A message appears in the machine's LCD while the machine is connecting to PC.

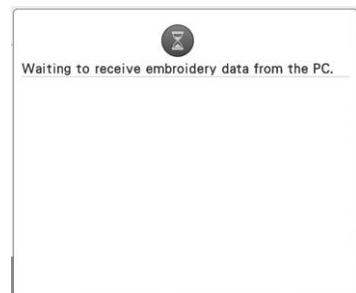

5



Note

- For details on using the embroidery editing software, refer to the Instruction Manual included with it.



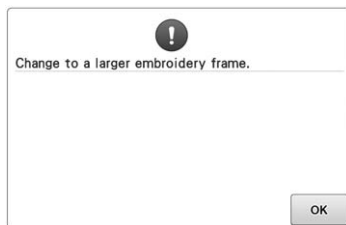

- * This Link dialog box is found in PE-DESIGN NEXT software.
- If the following error message appears, the type of embroidery frame installed on the machine is not compatible with the size of the pattern. Replace the embroidery frame with one compatible with the size of the pattern.

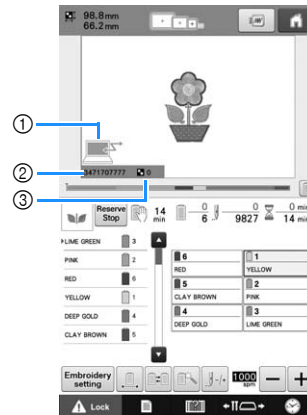

8 After the embroidery pattern has been opened by the machine, the embroidering screen appears.

→ The opened embroidery pattern appears in the pattern display area with the icon for the Link function.





- ① Icon for Link function
 - ② 10-digit machine ID
 - ③ Number of the pattern in the queue
- Touch  to delete the pattern.

Memo

- While the embroidery machine is connected to the computer, the machine's status can be displayed by using a function of the embroidery editing software. If multiple embroidery machines are connected at the same time, check the status of the machines using the 10-digit machine ID that appears in the machine's screen. The following information can be viewed from the computer.
 - Number of the stitch being sewn and total number of stitches in the pattern
 - Information on sewing errors

9 To change the embroidering settings for the opened embroidery pattern, touch .

- Touch  when the following message appears.
Touch  to return to the embroidering screen.

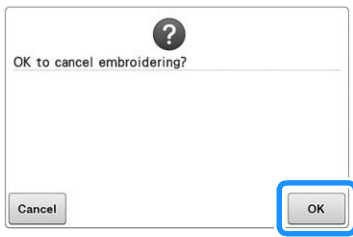

→ The embroidering settings screen appears.

10 After the desired settings have been specified, touch  to return to the embroidering screen.

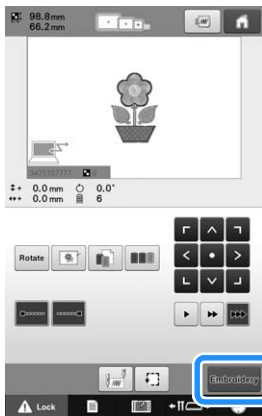

11 Touch , and then press the start/stop button to start embroidering.

→ When embroidering is finished, the following message appears.



12 To open another pattern sent from the computer, touch , and then repeat the procedure starting from step **8** to continue embroidering.

To stop embroidering or to embroider the same pattern again, touch .



Note



- The embroidering screen settings specified in step **10** are saved even if  was touched to continue sewing after embroidering is finished.



Memo

- If the embroidery machine is turned off while it is embroidering, the resume operation can be used the next time it is turned on.

Disabling the Link function

1 Touch , and then touch  and  to display page 5 of the settings screen.

2 Touch  to disable the Link function.



→ When the following message appears, touch .

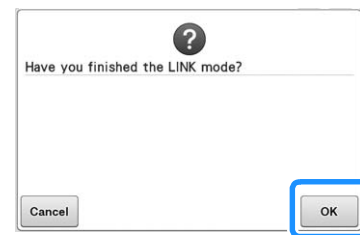

3 Turn off the machine.

Editing the Embroidery Pattern (Pattern Editing Screen)

The patterns can be edited from the pattern editing screen and the embroidering settings screen. Individual patterns can be edited with the pattern editing screen, and the entire pattern can be edited with the embroidering settings screen. The results of editing the pattern can be seen in the pattern display area.

Enlarge the pattern image on the screen

The pattern can be displayed enlarged to a maximum of double its normal size.

1 Touch .



→ The enlarged pattern image is displayed on the screen.

2 Each touch of switches the enlargement ratio to 125%, 150% or 200%.

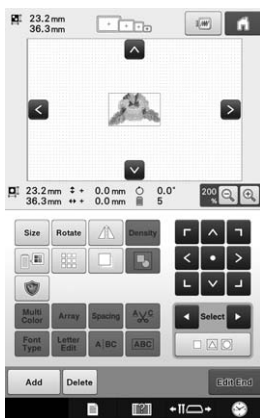

• Touch , , and on the pattern display area to view the hidden area of the pattern.

Memo

- The pattern display area can be moved even if a blank area is touched and moved.

3 To return the pattern to its normal size, continue pressing until the enlargement ratio is 100%.

Combining patterns

Various patterns, such as embroidery patterns, frame patterns, built-in alphabet patterns and patterns on embroidery cards, can easily be combined.

1 Touch .

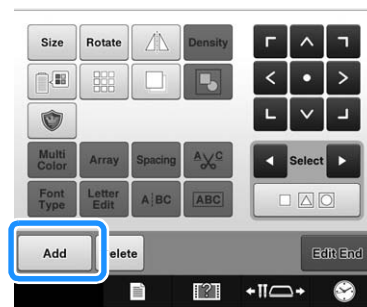

→ The pattern type selection screen appears again.

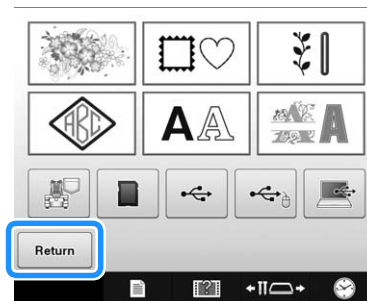

- Touch in the pattern type selection screen, if you no longer want to combine patterns. The pattern editing screen will then appear. This key is not available unless a pattern has been previously selected.

2 Select an embroidery pattern.

Select the pattern to be added as described on page 124 to 140.

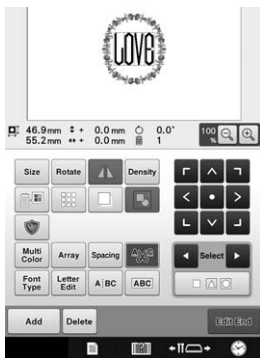

- When another pattern is selected, it is normally added at the center of the pattern display area.

3 Repeat steps 1 and 2 until all patterns to be combined are selected.

Memo

- The position of individual patterns and other editing operations can be performed from the pattern editing screen. The editing operations can be performed in the same way from the pattern editing screen whether it is displayed as each pattern is selected or after all patterns that you wish to combine have been selected.

Selecting the pattern to be edited

If multiple patterns are selected, you can choose which pattern will be edited.

1 Touch ◀ or ▶.

The pattern that will be edited is the pattern enclosed by the red frame.

Continue touching ◀ and ▶ until the red frame is around the pattern that you wish to edit.

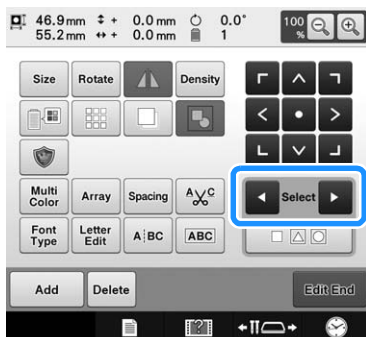

- The patterns are selected in the order or the opposite order that they were added to the pattern.

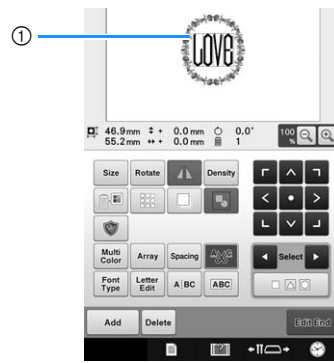

- ① Red frame indicating the pattern to be edited.

Memo

- If multiple patterns appear in the pattern editing screen, the basic editing procedure is to 1. select the pattern to be edited, and then 2. edit that pattern.

Selecting multiple patterns at the same time

Multiple patterns can easily be edited, for example, when moving patterns that are combined, if they are all selected together.

1 Touch [Multiple Selection Icon].

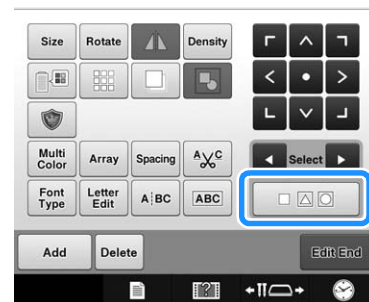

- The Multiple Selection screen appears.

- 2 Select the multiple patterns by dragging your finger in the screen to create a box around the desired patterns.

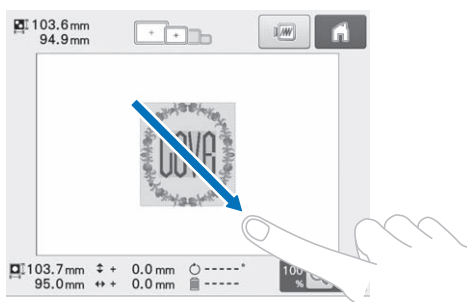

Memo

- Multiple patterns can be selected or deselected from the multiple selection screen. Touch ◀ or ▶ to check the patterns to be selected, and then touch

Set .

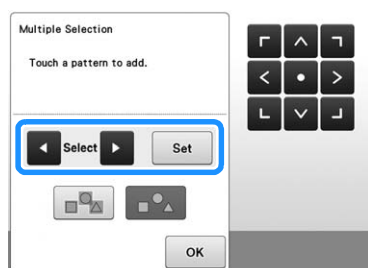

The selected pattern is surrounded with a red box.

- Touch to select all patterns in the pattern display area.
- Touch to deselect all selected patterns.
- The patterns can also be selected by touching them in the screen.
- While the Multiple Selection screen is displayed, patterns can be moved with .

- 3 Touch to return to the pattern editing screen.

- The multiple selected patterns are surrounded with a red box.

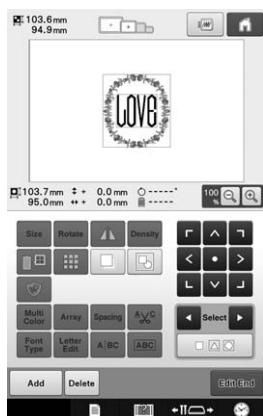

Grouping multiple selected patterns

If the multiple patterns selected in “Selecting multiple patterns at the same time” on page 147 are grouped, they can be edited as a single pattern.

- 1 Touch so that it changes to .

→ The selected patterns are grouped.

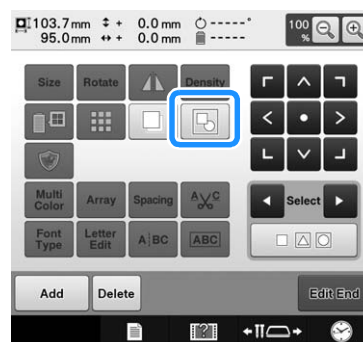

- Each touch of the key turns either on or off.



The selected pattern group is ungrouped.

The displayed patterns are grouped.

Moving a pattern

Determine where in the embroidery frame the pattern will be embroidered. If multiple patterns are combined, move each pattern to lay out the design.

- 1 Touch the key for the direction where you wish to move the pattern.



→ The pattern moves in the direction of the arrow on the key.

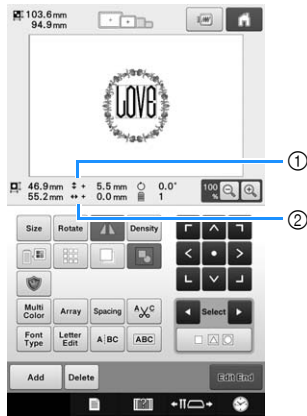

- ① Shows the vertical distance moved from center.
- ② Shows the horizontal distance moved from center.

Memo

- If you wish to group combined patterns, refer to “Grouping multiple selected patterns” on page 148.
- To return the pattern to its position before it was moved (center of the embroidery frame), touch .

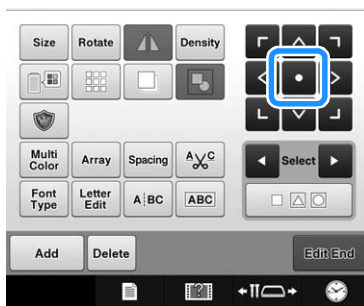



The pattern can also be moved by dragging it. If a USB mouse is connected, move the mouse to position the pointer on the desired pattern, and then hold in the left mouse button while dragging the pattern. The pattern can also be dragged by selecting it directly in the screen with your finger or the touch pen.

Memo

- The pattern can also be moved by touching the arrow keys in the screens that appear when any of the other editing keys are touched.
- The arrow keys in the embroidering settings screen are used to move the frame to select the embroidering position.
- The pattern can also be moved to the desired position by dragging it with your finger.

Flipping a pattern horizontally

- 1 Touch  so that it changes to .

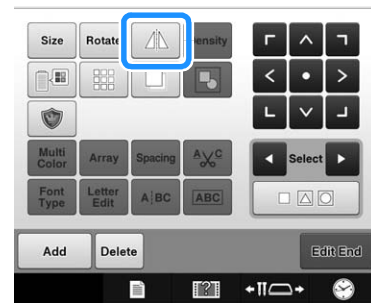

- The pattern is flipped horizontally.
- Each touch of the key turns the setting either on or off.



Horizontal flip turned off



Flipped horizontally

Changing the size of a pattern (Normal resizing mode)

The size of the pattern can be increased or decreased to between 90% and 120% of its original size.

1 Touch .

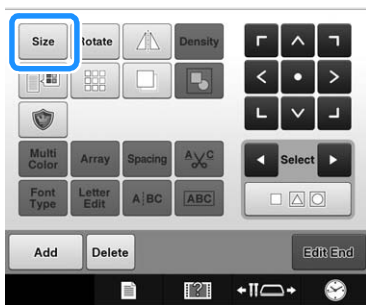



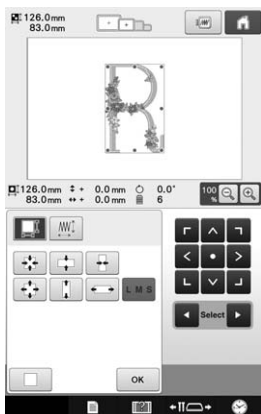

→ The screen shown below appears.

- The pattern rotation handle appears in the screen. The pattern can be rotated while it is being resized. For details on rotating the pattern, refer to "Adjusting the angle" on page 91.



Example: Original angle





-  Reduces without changing the height-to-width proportion.
-  Reduces only in the vertical direction.
-  Reduces only in the horizontal direction.
-  Enlarges without changing the height-to-width proportion.
-  Enlarges only in the vertical direction.

 Enlarges only in the horizontal direction.





 Normal resizing mode
Enlarges/reduces without changing the number of stitches.

 Stitch Recalculator mode
Enlarges/reduces while thread density is maintained.

 Select
Selects a pattern to be resized.

 Moves the pattern in the direction of the arrow on the key.

 Touch this key to return the pattern to its original size.

 OK
Closes the screen.

 Available only with character patterns.
Touch this key to switch the size of the character pattern.

2 If is not selected, touch .

If a new pattern is selected,  is selected. Simply continue with step 3.

3 Touch the keys to adjust the pattern to the desired size.

Each touch of a key slightly enlarges or reduces the pattern.

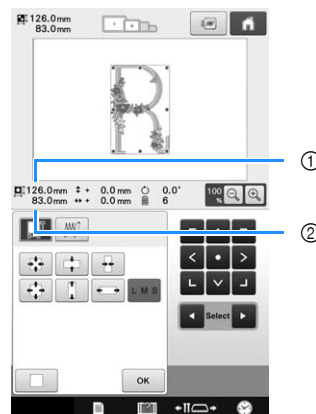

The size of the pattern is displayed after a key is touched to change it.

① Vertical length

② Horizontal width

- The size that the pattern can be enlarged depending on the pattern or character.
- Depending on the pattern or character, if it is rotated 90 degrees it may be enlarged even more.
- If the pattern is rotated, the vertical and horizontal directions may be reversed.
- To return the pattern to its original size, touch



4 If necessary, touch the arrow keys to adjust the position of the pattern.

(For more details, refer to page 148.)

5 After making the desired changes, touch

OK .

→ The pattern editing screen appears again.

CAUTION

- After changing the size of the pattern, check the icons for the embroidery frames that can be used and use only the indicated frames. If a frame other than those indicated are used, the presser foot may hit the embroidery frame and cause injuries.

Changing the pattern size while maintaining the desired thread density (stitch recalculator)

In the embroidery edit screen, the size of the pattern can be changed while the desired thread density is maintained.

With this function, the pattern will be enlarged or reduced at a larger ratio than with normal pattern resizing.

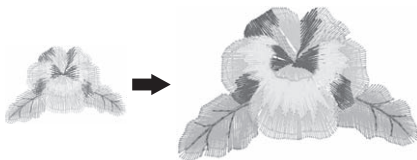

Note

- In order to check the finished embroidery before sewing on your project, sew trial embroidery using the same fabric and thread as those in your project.
- This function cannot be used with character patterns, frame patterns, repeated (border) patterns and large buttonhole patterns. However, a repeated pattern can be created from a pattern resized using this function.
- Patterns with a large number of stitches (about 100,001 or more) cannot be resized while maintaining a desired thread density. The maximum limit for the number of stitches differs depending on the data size of pattern.
- If this function is used, thread density is maintained while the pattern is enlarged/reduced. However, the needle drop point pattern is not entirely maintained. Use the normal resizing mode  depending on the results of trial embroidering.

1 Press .

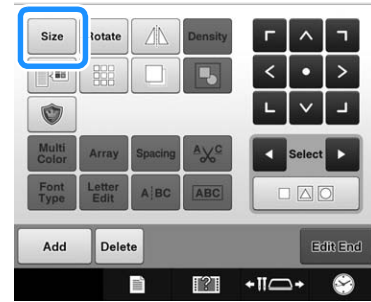

→ The following screen is displayed. (Refer to page 150)

2 Press to enter Stitch Recalculator mode ().

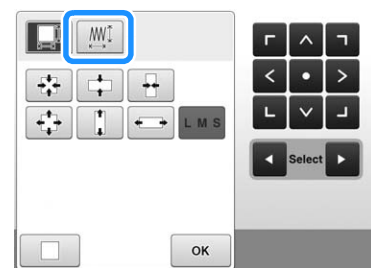

Memo

- Stitch Recalculator cannot be used if  does not appear.

3 When the following message appears, touch

OK .

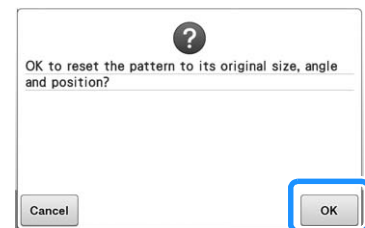

→ The pattern will be returned to its original size, angle, and position as it was before it was edited.

4 Select how to change the pattern size. (Refer to page 150.)

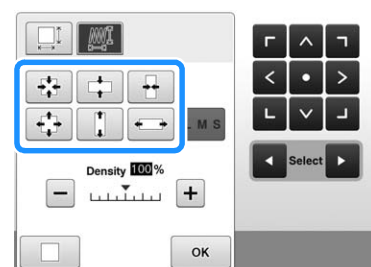

Memo

- In Stitch Recalculator mode, the pattern can be reduced/enlarged between 60% and 120%.
- With the density scale bar, the thread density can be changed. A setting between 80% and 120% in 5% increments can be specified.

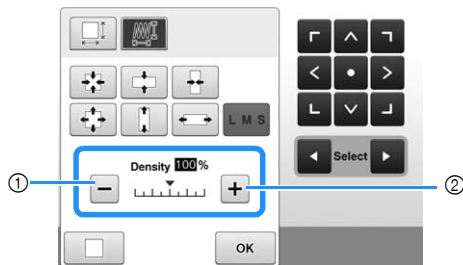

- ① Touch **-** to make the pattern less dense.
- ② Touch **+** to make the pattern more dense.

5 Touch **OK** .

Note

- Depending on the pattern, embroidering may not be possible at the appropriate thread density. Before sewing on your project, be sure to embroider a trial sample on a piece of scrap fabric that is the same as the fabric used in the project, using the same needle and embroidery thread.
- If the pattern is enlarged and there is space between stitches, a better effect can be achieved by increasing the thread density.
- If the pattern is reduced and the stitching is too thick, a better effect can be achieved by reducing the thread density.

⚠ CAUTION

- Depending on the pattern, the stitching may become entangled or the needle may break when the pattern is reduced. If this occurs, slightly enlarge the pattern.
- After changing the size of the pattern, check the icons for the embroidery frames that can be used and use only the indicated frames. If a frame other than those indicated are used, the presser foot may hit the embroidery frame and cause injuries.

Rotating a pattern

The pattern can be rotated in either direction to the desired angle.

1 Touch **Rotate** .

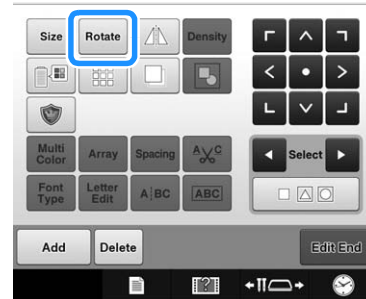

→ The screen shown below appears.

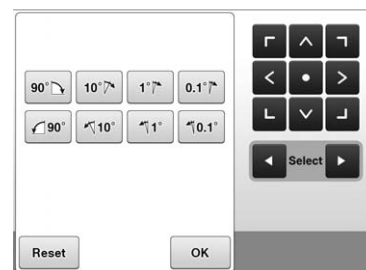

- For details on each key, refer to “Adjusting the angle” on page 91.

2 Touch the keys to adjust the pattern to the desired angle.

Each touch of a key rotates the pattern.

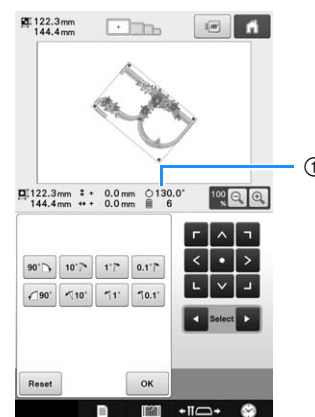

- ① Shows the angle of the pattern after a key is touched to change it.

- To return the pattern to its original angle, touch **Reset** .

3 If necessary, touch the arrow keys to adjust the position of the pattern.

(For more details, refer to page 148.)

4 After making the desired changes, touch

 .

→ The pattern editing screen appears again.

CAUTION

- After changing the angle of the pattern, check the icons for the embroidery frames that can be used and use only the indicated frames. If a frame other than those indicated are used, the presser foot may hit the embroidery frame and cause injuries.

Memo

- If  in the embroidering settings screen is used, the entire combined pattern can be rotated. (For details, refer to “Rotating the entire pattern” on page 172.)
- If the pattern is too large or the pattern is too close to the edge of the embroidery field, all of the rotating options may not apply.

Changing the text arrangement of a character

Characters can be arranged on a horizontal line, on a slant or on an arc.

1 Touch .



→ The screen shown below appears.

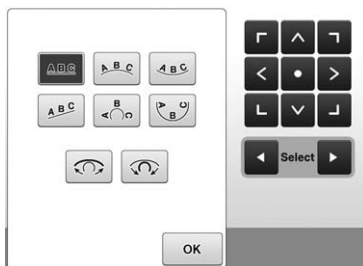





- For details on each key, refer to “Changing the text arrangement” on page 132.

2 Touch the key of the desired text arrangement.

3 After selecting the desired text arrangement, the bend of the curve can be adjusted. If necessary, touch and to adjust the bend of the curve.

Memo

- When selecting ,  and  change to  and . You can increase or decrease the incline.

4 If necessary, touch the arrow keys to adjust the position of the pattern.

(For more details, refer to page 148.)

5 After making the desired changes, touch

 .

→ The pattern editing screen appears again.

Memo

- The text arrangement specified when the character was selected on page 132 can be changed at this point.

Changing the character spacing

The spacing between the characters can be made wider or narrower.

1 Touch .

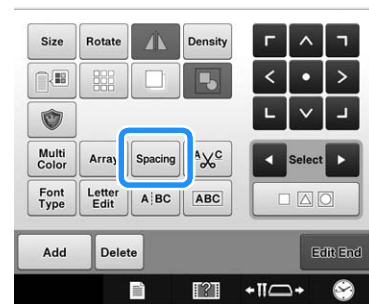

→ The character spacing screen appears.

2 Touch the keys to adjust the characters to the desired spacing.

Each touch of a key slightly increases or decreases the character spacing.

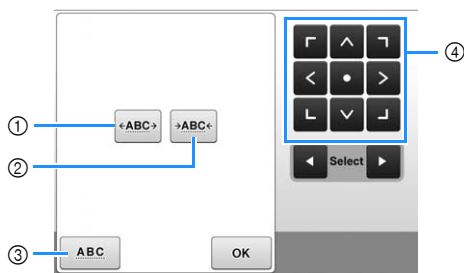

- ① Increases the space between characters equally.
- ② Decreases the space between characters equally.
- ③ Selects the standard character spacing (original character spacing).
- ④ Moves the pattern in the direction of the arrow on the key.

3 If necessary, touch the arrow keys to adjust the position of the pattern.

(For more details, refer to page 148.)

4 After making the desired changes, touch



Separating combined character patterns

Combined character patterns can be separated to adjust the character spacing or to separately edit the patterns after all character have been entered.

1 Touch .

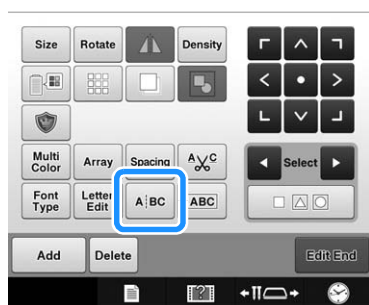

→ The following screen is displayed.

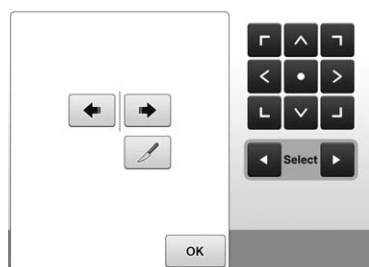

2 Use to select where the pattern is to be separated, and then touch to separate it. For this example, the pattern will be separated between “T” and “a”.

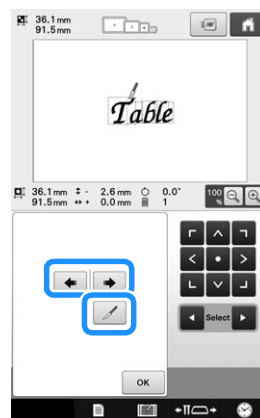

3 Use and to select a pattern, and then use to adjust the character spacing.

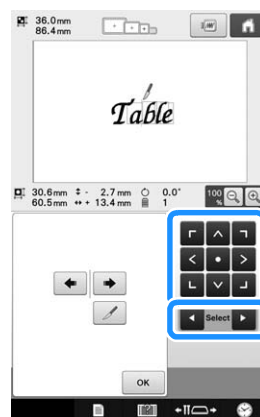

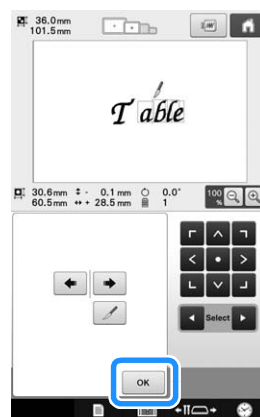

4 Touch .



Trimming the threads between characters

If the machine is set to trim the threads between the characters, the jump stitches between the characters are reduced and any other necessary procedures after embroidering are reduced. However, the embroidering time will increase if the threads are trimmed between each of the characters.

- 1 Touch  so that it changes to .

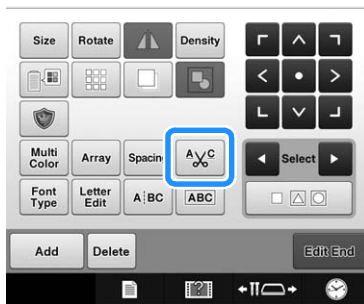

- Each touch of the key turns the setting either on or off.



Combining the separated character patterns

Two separated lines of character patterns can be combined. The characters can be aligned to the specified order. You cannot combine the lines of character patterns if the text contains a line feed using the Line Feed function.

- 1 Touch .



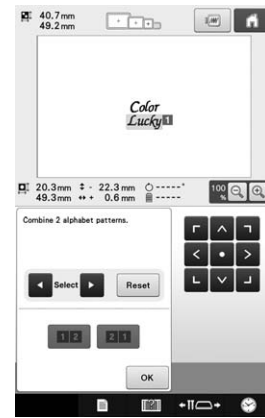

→ The following screen is displayed.



Memo

- The selected character is assigned as Number 1.

- 2 Select the group of character patterns that you want to combine.

- You can select the patterns by touching them on the screen, or touching  or  to check the patterns to be selected, and then touch .

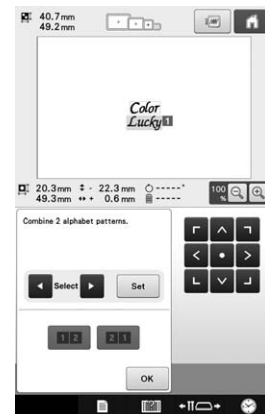

→ Numbers 1 and 2 are assigned temporarily to the patterns.

- 3 Touch  or  to choose the order of the 2 patterns.

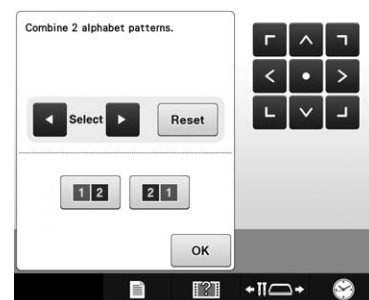

- Touch **OK** to return to the previous screen.

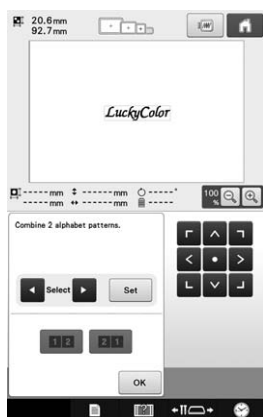

Specifying multi-color text

The alphabet pattern characters selected on page 130 are set to black. The color of the characters can be changed using the change thread color key; however, to change the color of individual characters, touch the Multi Color key to turn it on, and then specify the color for each character.

- Touch **Multi Color** so that it changes to **Multi Color**.



- Each touch of the key turns the setting either on or off.



- For details on changing the thread color, refer to "Changing the colors of the pattern" on page 157.

Changing the character font

In the pattern editing screen, the font used in the selected pattern can be changed.

- Touch **Font Type**.

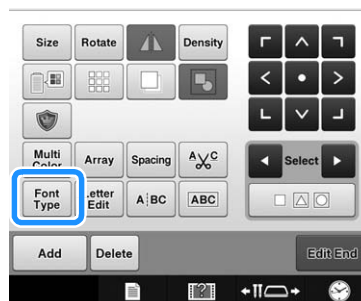

- Use **Select** to select the character pattern whose font is to be changed, and then select the desired font.

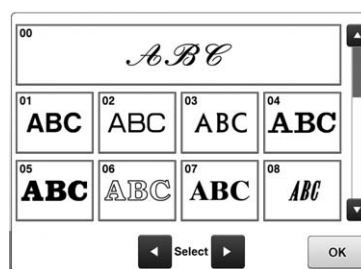

- Touch **OK**.

Changing the font and size of individual characters

The font and size of individual characters in a character pattern can be changed.

- Touch **Letter Edit**.

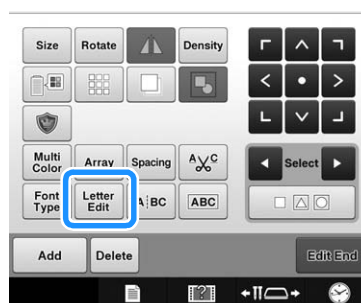

- Touch **OK** to select the individual character to be edited.

- 3 Select a character size below  to change the character to the desired size.

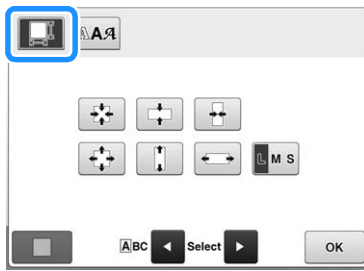

- 4 Touch , and then select the desired font.

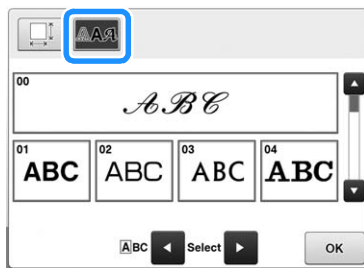

- 5 Touch .

Changing the thread density (only for selected character and frame patterns)

The thread density for some character and frame patterns can be changed.

A setting between 80% and 120% in 5% increments can be specified.

- 1 Touch .

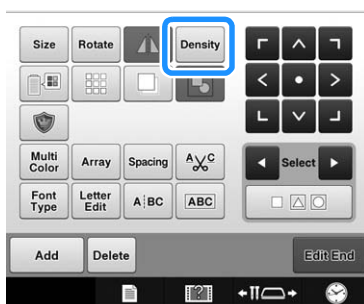

→ The screen shown below appears.

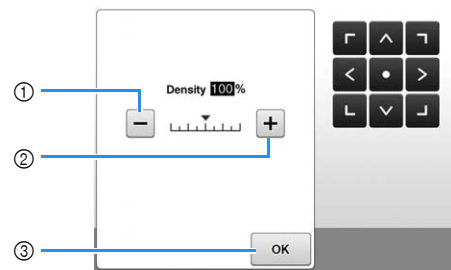

- ① Selects a less thread density
② Selects a more thread density
③ Touch this key to close this screen.

■ Selects a less/more thread density

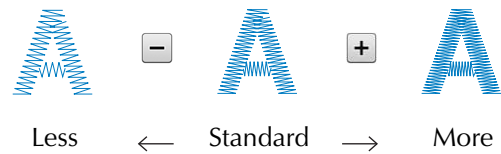

- 2 Touch the keys to select the desired thread density.

Each touch of a key slightly increases or decreases the thread density.

- To return to the original thread density (standard), select "100%".

- 3 After making the desired changes, touch



→ The pattern editing screen appears again.

Changing the colors of the pattern

The colors of the pattern can be changed and previewed on the screen.

By changing the colors of the pattern, the same pattern can be viewed in various ways.

If your thread colors are registered in a color thread table and if you used the table for changing color, the thread spools can be assigned with the thread colors that you have. And the pattern displayed in the screen will appear with colors that are almost the same as the actual thread colors.

With this operation, the colors of all patterns will be changed, not just those of the pattern being edited.

1 Touch .

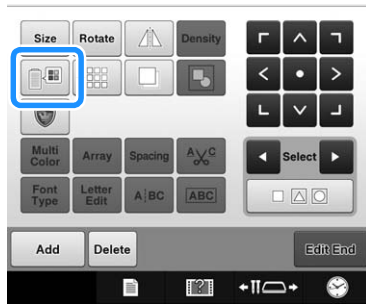

→ The change thread color screen appears.

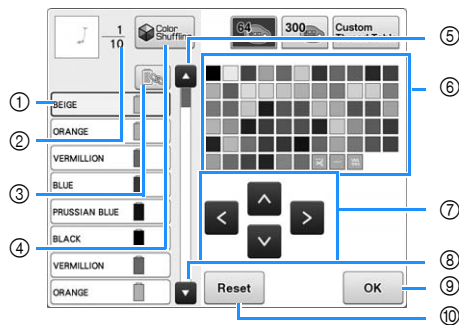

- ① The thread color surrounded with a blue box in the thread color sequence display is the color that is being changed.
- ② Shows the number of thread color changes. The top value shows the position in the sewing order for the color at the top of the thread color sequence display and the bottom value shows the total number of thread color changes.
- ③ Use this key to combine all thread colors that are the same so they can be selected.
- ④ Using the Color Shuffling function. Select the desired color scheme from the new suggested color schemes to change the overall tone of the pattern. (Refer to "Find new color schemes with the color shuffling function" on page 159.)
- ⑤ Selects the previous color in the thread color sequence display.
- ⑥ Thread color table
Select a color from this table.
- ⑦ Use these keys to select a color from the thread color table.
- ⑧ Selects the next color in the thread color sequence display.
- ⑨ Touch this key after selecting a color.
- ⑩ Touch this key to return the colors to those before this screen appeared.

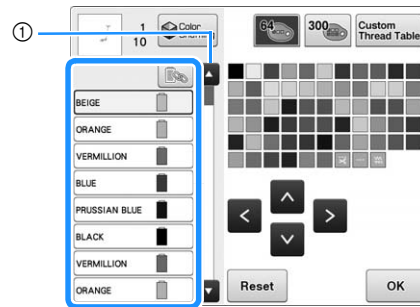

2 From the thread color sequence display, select the thread color whose color is to be changed.

- If the desired thread color is not displayed, use the scroll bar on the right side to display it.



① Scroll bar

→ The selected thread color is surrounded with a blue frame.

- To combine the same thread color when it is used more than once, select the thread color, and then touch . The key changes to , and all thread colors in the thread color sequence display that are the same as the one that was selected are highlighted in blue.

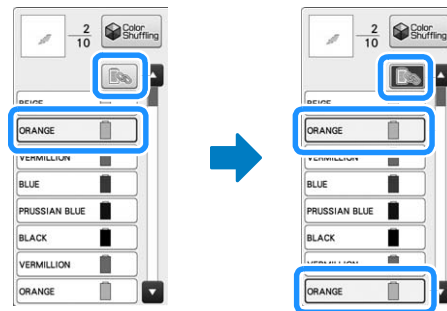

- The part of the pattern whose thread color is to be changed can be directly selected in the pattern.

3 Touch , , and , or directly touch the desired color, to select the new color from the color palette.

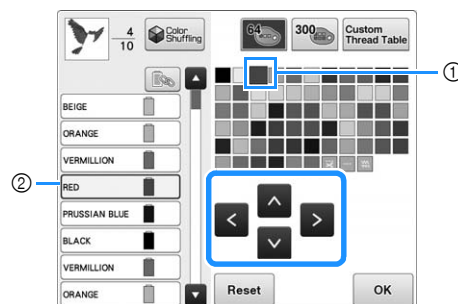

- ① The color that appears enlarged is the color that is selected.
- ② Displays the name of the selected thread color
→ In the pattern display area, the color of the selected part of the pattern is changed.

4 Touch  .

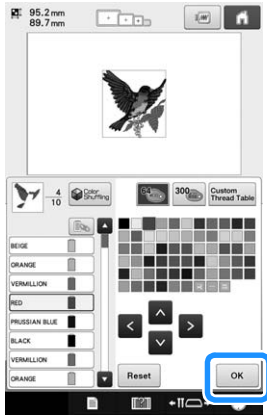

- The color change is confirmed.
- The pattern editing screen appears again.

 **Memo**

- The color thread table can be changed to a custom thread table that you create to reflect the thread colors that you have. (Refer to “Creating a custom thread table” on page 167.)

Find new color schemes with the color shuffling function

■ The Color Shuffling function

With the Color Shuffling function, the machine suggests new color schemes for the embroidery pattern that you have selected. After you select the desired effect from one of the four available color schemes (“Random”, “Vivid”, “Gradient” and “Soft”) the sample for the selected effect is displayed.

1 Press  .

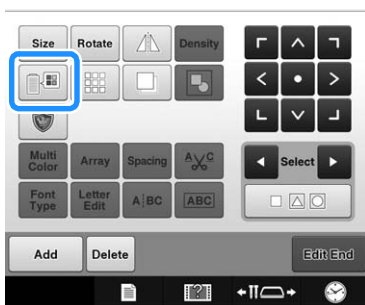

- The change thread color screen appears.

2 Press  .

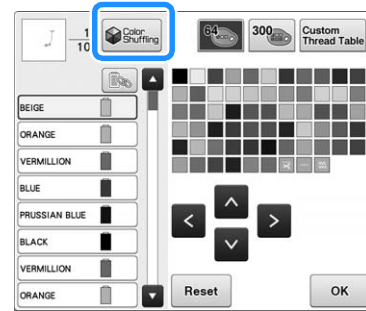

- If  has been selected in this screen, every part in the pattern with the same thread color in the original color scheme will be changed to the same thread color in the new color scheme displayed by the machine.

 OFF

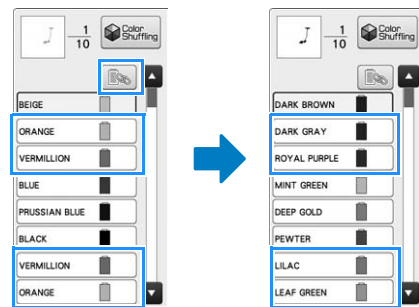

 ON

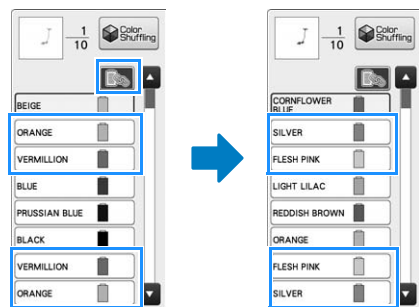

 **Note**

- This function may not be available depending on the pattern you select (ex. a bordered embroidery pattern). If the color shuffling key is grayed out, select another pattern.
- If you have not created a custom thread table, the color shuffling function cannot be used with thread table (300 colors). In that case, use the thread table (64 colors) instead or create colors in the custom thread table. Refer to “Creating a custom thread table” on page 167



3 Select the color group you want to use.

- You can select the color shuffling function from the following color groups. ① Thread colors currently on the spool stand, ② thread table (64 colors: preset color table) and ③ custom thread table (300 colors: color table that you can set as you like).
- By setting the embroidery thread colors of the brand you have on the custom thread table, you can create your embroidery pattern with your own thread colors.

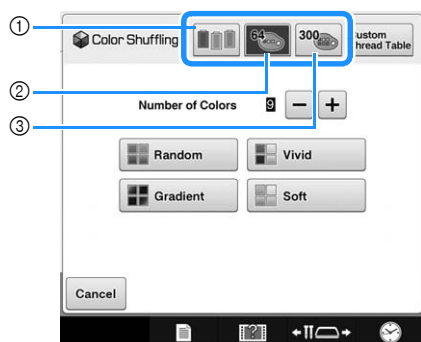

4 Select the number of colors you want to use and then select the desired effect.

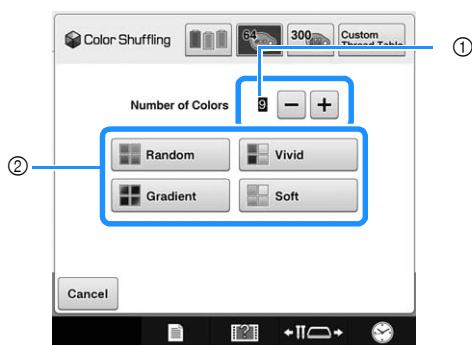

- Number of colors to be used in the pattern
- Effects for schemes
 - When "Random" or "Gradient" is selected, follow the instructions under "When "Random" or "Gradient" is selected" on page 161.



Note

- You cannot select more thread colors than the number in the selected color group.

Memo

- Selection for the desired number of colors must stay within the range for the number of thread changes for the pattern you selected.
- When using this function the PES data pattern recalled on the machine, and the "PES Thread Code" is set to "ON" in the Settings Screen, the thread colors which are not in the thread table of the machine will not be used to make the color schemes. You can get the color schemes using all the thread colors in the selected pattern by setting "PES Thread Code" to "OFF" in the Settings Screen. (Refer to "Selecting the thread color information for "PES" format data" on page 183.)

5 Press the desired color scheme from samples.

- Touch **Refresh** to display the new schemes.



- Touch to review the previous schemes after touching **Refresh**.



Note

- Maximum 10 pages of schemes can be reviewed. After 10 pages of schemes, the oldest page is deleted every time you touch

Refresh

6 Press **Set** to select the displayed color scheme.

- * Touch **Cancel** to return to the previous screen.
- * You can continue selecting color schemes from the selected page prior to touching **Set**.
- * Touch **◀** or **▶** to display the other color schemes.



→ The change thread color screen appears again.



Note

- The following settings in the settings screen cannot be changed in this function;
 - Thread color brand selection
 - Reserved needle setting
 - "PES Thread Code" setting

When "Random" or "Gradient" is selected

1 Touch **Auto Manual** to select the desired thread palette mode.

→ If the thread colors to be used will not be selected, select "Auto".

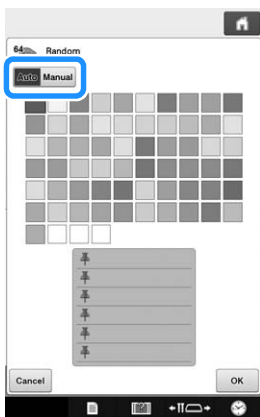

With "Random"
Up to six thread colors can be pinned.
A random color scheme will be created from the pinned colors.

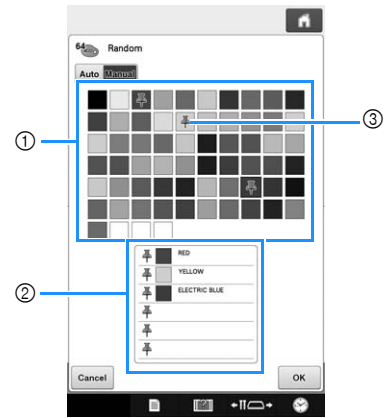

- ① Select the thread colors from the palette.
- ② The selected thread colors appear in the list.
- ③ Push pins appear on the colors used in the color scheme. Touch the pinned color twice, to unpin the unwanted color.

With "Gradient"

Only one thread color can be selected.
A gradient will be created with the selected color.

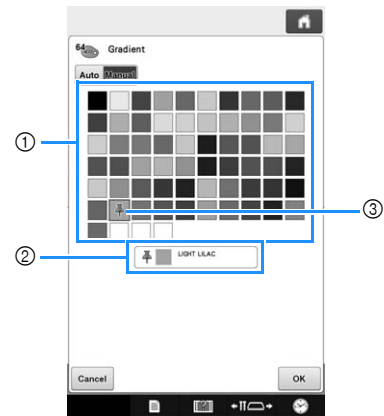

- ① Select the thread color from the palette.
- ② The selected thread color appear in the list.
- ③ A push pin appears on the color used in the color scheme. Touch the pinned color twice, to unpin the unwanted color.

2 Touch **OK**.

→ The sample image is displayed with the created color scheme.

- Continue with step **5** on page 160.



2 Select the direction in which the pattern will be repeated.

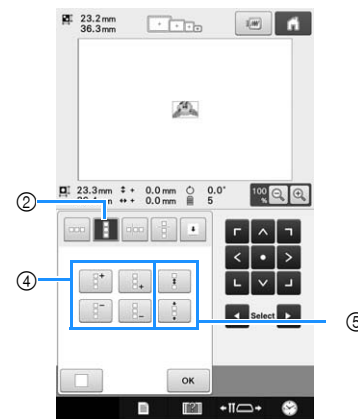
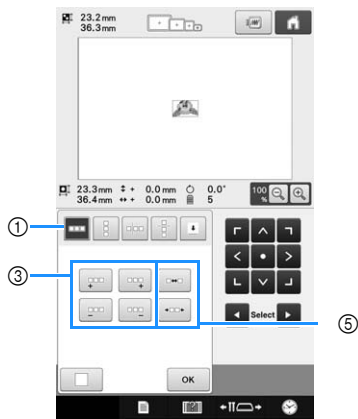

- ① Horizontal direction
 - ② Vertical direction
 - ③ Repeating and deleting horizontal keys
 - ④ Repeating and deleting vertical keys
 - ⑤ Spacing keys
- The pattern direction indicator will change depending on the direction selected.

3 Use to repeat the pattern on left and to repeat the pattern at the right.

- To delete the left pattern, touch .
- To delete the right pattern, touch .

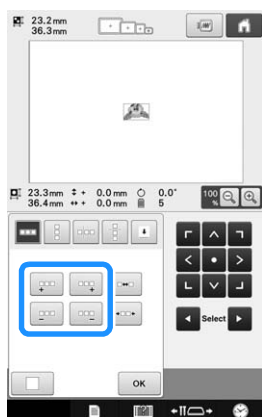

4 Adjust the spacing of the repeated pattern.

- To widen spacing, touch .
- To tighten spacing, touch .

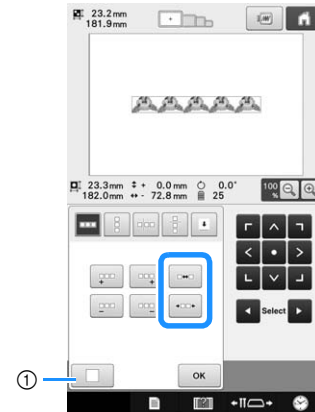

- ① Touch to change a repeated pattern back to one single pattern.



Memo

- You can only adjust the spacing of patterns included in the red frame.

5 Complete repeated patterns by repeating steps 2 through 4.

6 After making the desired changes, touch



The pattern editing screen appears again.



Memo

- When there are two or more patterns, all patterns will be grouped together as one pattern in the red frame.

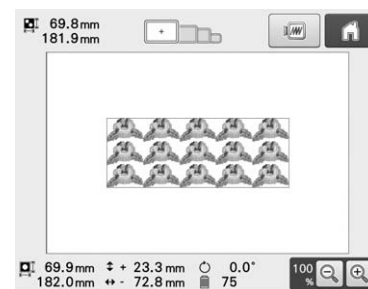



- When changing the direction in which the pattern will be repeated, all of the patterns in the red frame will automatically be grouped as one repeating unit. See the following section on how to repeat one element of a repeated pattern.

■ Repeating one element of a repeated pattern

By using the Cut function, you can select one element of a repeated pattern and repeat only that single element. This function allows you to design complex repeated patterns.

1 Choose the direction in which the repeated pattern will be cut.

- Touch  to cut horizontally.
- Touch  to cut vertically.

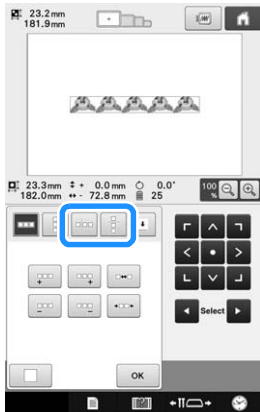

→ The pattern direction indicator will change depending on the direction selected.

2 Use and to select the cut line.

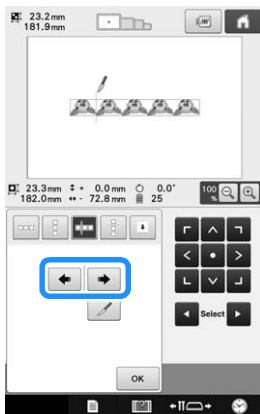

→ The cut line will move.

3 Touch .

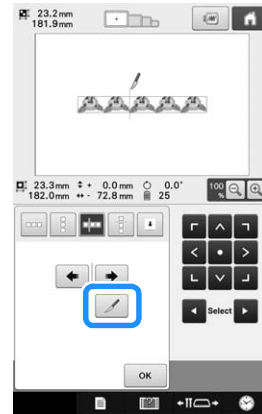

→ The repeated pattern will be divided into separate elements.

4 Touch .

5 Use and to select the element to repeat.

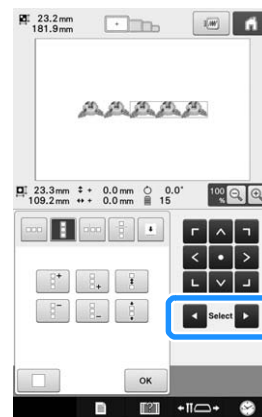

6 Repeat the selected element.

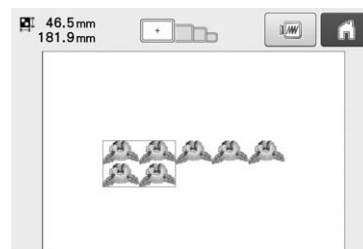

7 After making the desired changes, touch

OK .

The pattern editing screen appears again.



Note

- Once you have cut a repeated pattern into separate elements, you cannot return to the original repeated pattern.
- Each element can be edited separately in the edit screen. Refer to “Selecting the pattern to be edited” on page 147.

Assigning thread marks

By sewing thread marks, you can easily align patterns when sewing a series. When sewing is finished on a pattern, a thread mark in the shape of an arrow will be sewn using the final thread. When sewing a series of patterns, use the point of this arrow for positioning the following designs to be sewn.



Memo

- When repeatedly sewing individual patterns, thread marks can be sewn around the perimeter of the pattern only.

1 Touch .

2 Touch .

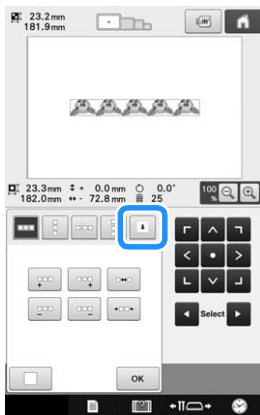

3 Touch to select the thread mark to be sewn.

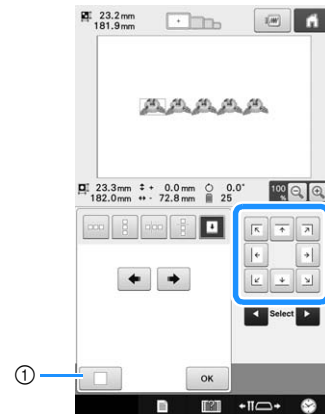

① Touch to cancel thread mark setting.



Memo

- When there are two or more elements, use and or and to select a pattern that you want to assign a thread mark(s) to.

4 Touch .



Note

- If the combined border pattern is rotated in the embroidering settings screen, the thread mark will be removed.

Embroidering the pattern repeatedly

After creating the repeated pattern, rehoop the embroidery frame and keep sewing for the next pattern.



Memo

- The optional border frame allows you to easily rehoop the fabric without removing the embroidery frame from the machine.

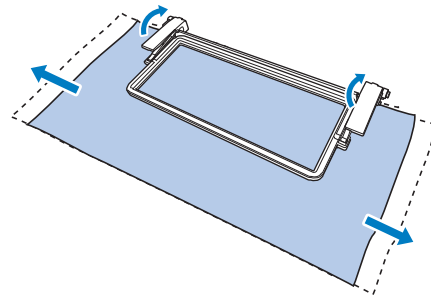

1 Create the repeated pattern with the thread mark at the center of the end of the pattern.

Refer to "Assigning thread marks" on page 165.

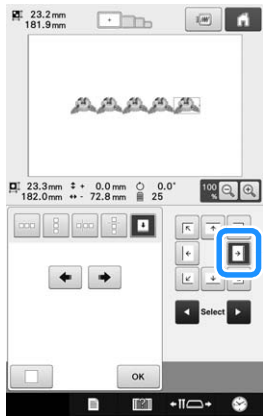

2 Touch **OK, **Edit/End**, then **Embroidery**.**

3 Touch **Lock, and then press the start/stop button to start embroidering.**

→ When embroidering is finished, the thread mark is sewn with the last thread color.

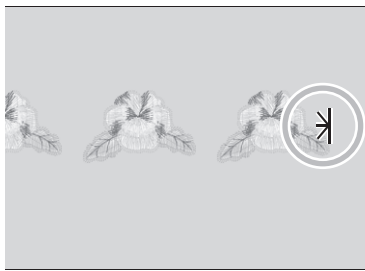

4 Remove the embroidery frame.

5 Rehoop the fabric in the embroidery frame.



Note

• Adjust the position of the fabric so that the embroidering area for the next pattern is within the embroidering area of the embroidery sheet.

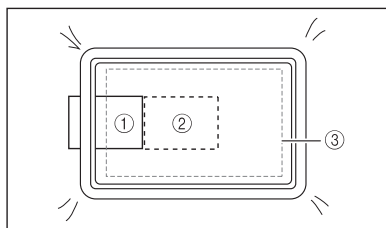

- ① Pattern embroidered first
- ② Position of pattern to be embroidered next
- ③ Embroidering area of embroidery sheet

6 Attach the embroidery frame to the machine, and then touch **Thread Mark in the embroidering settings screen.**

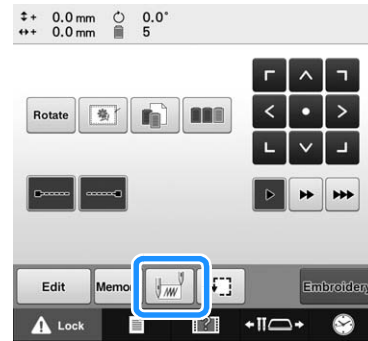

7 Touch **Left to set the starting point to the left side of the pattern.**

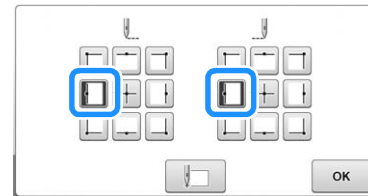

8 Touch **OK.**

9 Align the needle drop point with the thread mark sewn in the fabric.

Refer to "Changing the Embroidering Position" on page 89.

10 If the pattern position cannot be aligned using the positioning keys, rehoop the fabric, and then try again to align the position with the positioning keys.



Note

• After you have aligned the position of the combined border pattern, do not rotate the pattern in the embroidering settings screen. If the pattern is rotated in the embroidering settings screen, you cannot sew the pattern properly aligned even if the thread mark and the starting point are aligned.

11 Touch **OK to return to the previous screen.**

12 Remove the thread mark.

13 Touch **Embroidery.**

14 Touch **Lock, and then press the start/stop button to start embroidering.**

Creating a custom thread table

You can create a custom thread table containing the thread colors that you most often use. You can select thread colors offered by the machine's extensive list of thread colors from nine different thread brands. You can select any color and move the color to your custom thread table.



Note



- Some machine models may already have an additional 300 Robison-Anton thread colors contained in the custom thread table.
- You have the option to completely clear, or to restore the Custom Thread Table to the original factory setting. Visit our website at "<http://s.brother/cpbac>" for Custom Thread Table Clear/Restore Program and instructions.

Before creating a custom thread table, select a pattern and display the pattern editing screen. (Refer to page 40 and 66.)

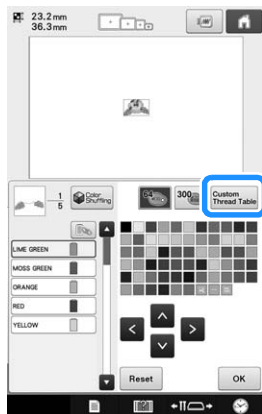
- 1 Touch  and then touch .



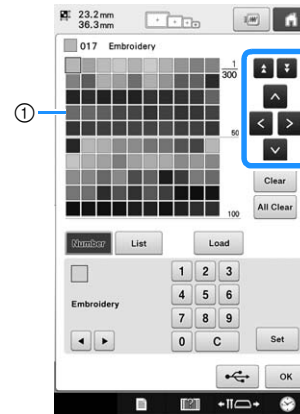

- 2 Use     to choose where to add a color on the custom thread table.

- You can choose color box from the custom thread from the custom thread table by directly touching the screen.
- You can scroll through 100 colors at a time using  and  on the custom thread table.



- ① Custom thread table

- 3 Use   to select one of the thread brands in the machine.

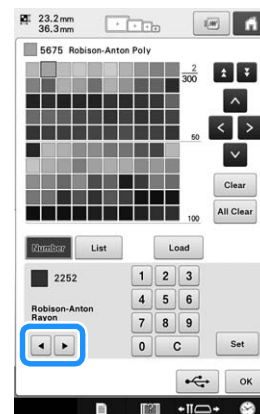

4 Use **1** **2** **3** **4** **5** **6** **7** **8**
9 **0** to enter a color's 4-digit number.

- If you make a mistake, touch **C** to erase the entered number, and then enter the correct number.

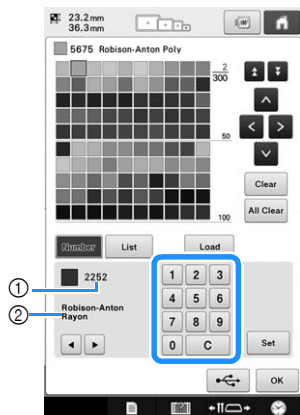

- ① Entered thread color number
- ② Thread brand

5 Touch **Set**.

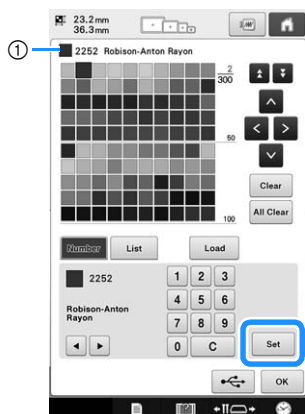

- ① Selected thread color
→ The selected thread color is set in the custom thread table.



Note

- If **Set** is not touched, the thread color number will not be changed.

6 Repeat the previous steps until all desired thread colors are specified.

- To delete a specified thread color from the palette, touch **Clear**.
- To delete all specified thread colors from the palette, touch **All Clear**.



Note

- When setting up custom thread table, touch **^**, **<**, **>** or **v** or touch the next square directly to set the next color after each selection. Machine will not advance to the next square automatically.

7 Touch **OK** to return to the original screen.

■ Adding a color to the custom thread table from the list

1 Repeat the previous step **1** on page 167.

2 Touch **List** to display the thread list.

3 Use **▲** **▼** to select a thread color.

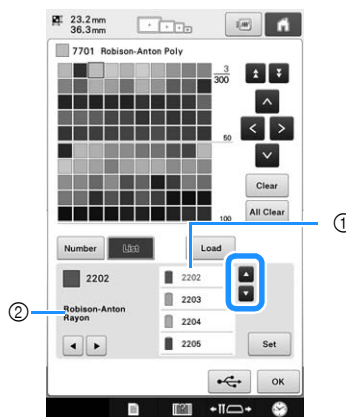

- ① Thread list
- ② Thread brand

4 Touch **Set**.

5 Repeat the previous steps until all desired thread colors are specified.

- To delete a specified color from the palette, touch



Note

- When setting up custom thread table, touch **^**, **<**, **>** or **v** or touch the next square directly to set the next color after each selection. Machine will not advance to the next square automatically.

6 Touch **OK to return to the original screen.**

Choosing a color from the custom thread table

You can select a color from the up to 300 thread colors you have set in the custom thread table.

1 Touch .

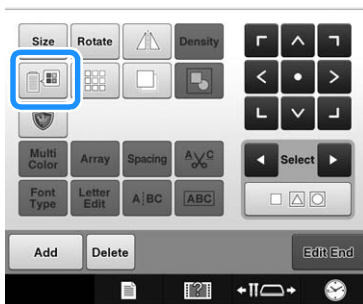

→ The 64 embroidery threads table screen displays.

2 Touch .

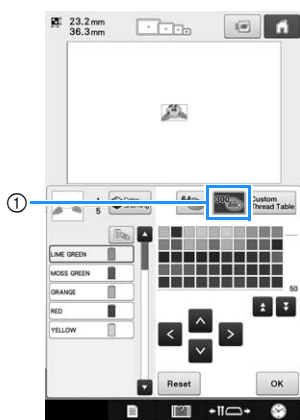

① Custom thread change key

→ The custom thread (300 embroidery threads) table screen will appear.

3 Touch **^ **<** **>** **v** to choose a new color from the custom thread table.**

- Use **▲** and **▼** to scroll through the custom thread table.
- Touch **Reset** to return to the original color.
- You can choose colors from the custom thread (300 embroidery threads) table by directly touching the screen.

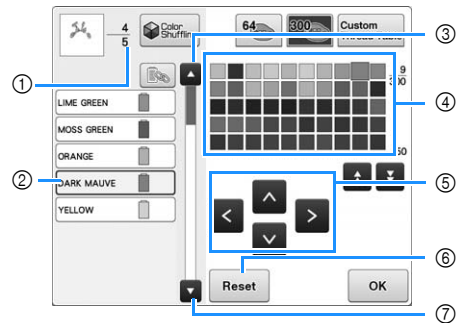

- Shows the number of thread color changes. The top value shows the position in the sewing order for the color selected in the thread color sequence display, and the bottom value shows the total number of thread color changes.
 - The part of the pattern in the thread color sequence display surrounded with a blue box in the thread color sequence display is the part whose color is being changed.
 - Moves to the previous color in the thread color sequence display.
 - Color thread table
Select a color from this table.
 - Use these arrows to navigate the color selection within the color thread table.
 - Touch this key to return to the original color.
 - Moves to the next color in the thread color sequence display.
- The display shows the changed colors.

4 Touch **OK.**



Saving and recalling the custom thread table using USB media

You can save a custom thread table data file to USB media, and then you can recall the saved data from USB media again.



Note

- Custom thread table data can only be saved to USB media. You cannot save the data in the machine's memory or in the computer.
- Custom thread table data is saved as ".pcp" data file.



■ Saving the custom thread table in USB media

- 1 Insert the USB media into the USB port on the right side of the machine.

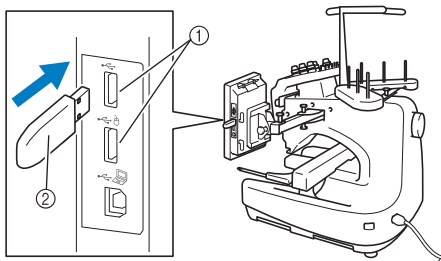
For details on connecting USB media, refer to "Using USB media" on page 75.



- 1 USB ports
- 2 USB media

- 2 Touch  and then touch .

- 3 Press .

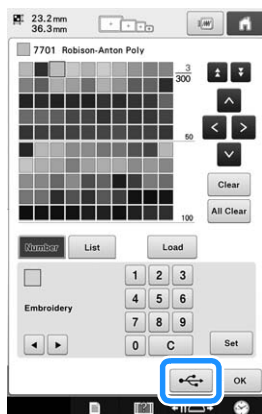

- 4 Touch , and then select the port where the data is to be saved.



→ The "Saving..." screen is displayed. When the data is saved, the display returns to the original screen automatically.



Note

- Do not insert or remove USB media while "Saving..." screen is displayed. You will lose some or all of the data you are saving.



■ Recalling the custom thread table in USB media

- 1 Insert the USB media containing the custom thread table data into the USB port for media.



Note

- You can only recall one custom thread table data at a time. Do not store two or more ".pcp" data file in USB media.

- 2 Touch  and then touch .

- 3 Touch .

→ The "Saving..." screen is displayed. When the data is loaded to the machine, the display returns to the original screen automatically.



Note

- Do not insert or remove USB media while "Saving..." screen is displayed. You will lose some or all of the data you are saving.
- To delete all the specified colors from the custom thread palette, touch .

Duplicating a pattern

1 Touch .

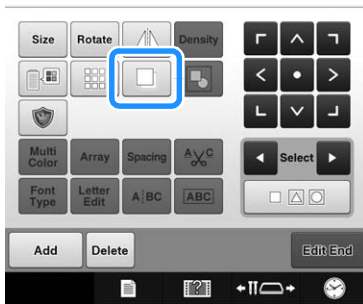

→ The duplicate appears, overlapping the original pattern as well as offset downward and to the right.

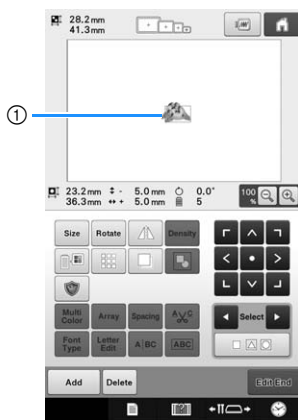

① Duplicated pattern

Deleting a pattern

1 Touch .

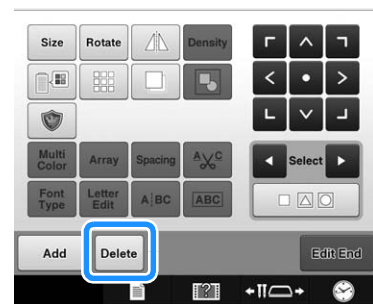

→ The screen shown below appears.

2 Touch .

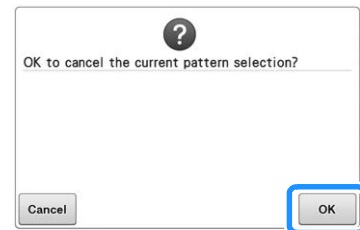

→ The pattern is deleted.

- To quit deleting the pattern, touch .



Note

- If multiple patterns are displayed, only the pattern selected will be deleted.

Editing the Embroidery Pattern (Embroidering Settings Screen)

In the embroidering settings screen, a single pattern can be edited if patterns were not combined or an entire combined pattern can be edited as a single pattern. In addition, the arrow keys can be used to move the pattern in the pattern editing screen or move the embroidery frame in the embroidering settings screen. Touching these keys moves the embroidery frame.

Rotating the entire pattern

The entire pattern can be rotated.

1 Touch **Rotate**.

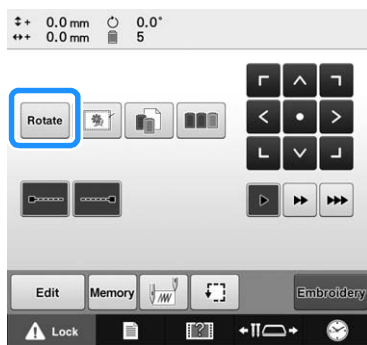

→ The screen shown below appears.

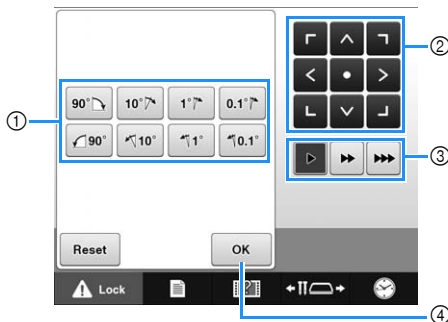

- ① Enables the entire pattern to be rotated.
- ② Enables the embroidery frame to be moved.
- ③ Select the speed to move the frame. (For more details, refer to page 89.)
- ④ Touch this key to close this screen.

2 Touch the keys to adjust the pattern to the desired angle.

(For more details, refer to page 152.)

3 If necessary, touch the arrow keys to adjust the position of the embroidery frame.

(For more details, refer to page 91.)

4 After making the desired changes, touch



→ The embroidering settings screen appears again.

Editing a Combined Pattern

In this section, we will combine text with floral alphabet pattern, which we will then edit.
Example)



1 Touch .



2 Select .



3 Select .



→ This pattern will be positioned at the center of the embroidery area.

4 To select the pattern, touch .

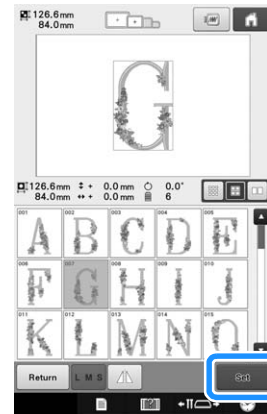

→ The pattern editing screen appears.

5 Touch .

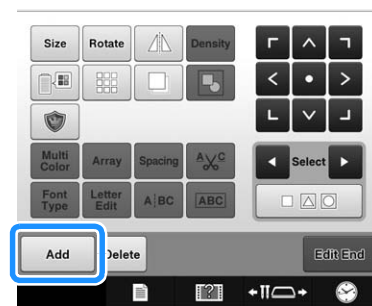

→ The pattern type selection screen appears again.

6 Touch .

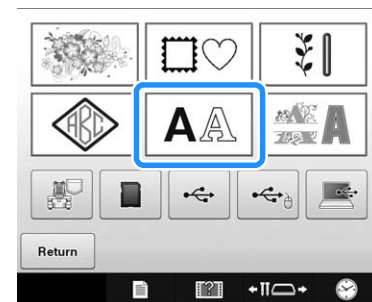

5

7 Touch **ABC**.

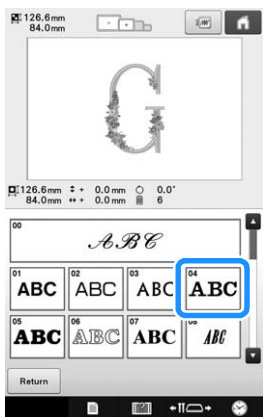

8 Type "ood".

Touch the tab for lowercase letters to display the lowercase letters input screen, and then touch "o", "o", then "d".



- The selected letters appear at the center of the embroidery area.
- To change the size of the pattern, select "o", and then touch **L M S** to select the desired size.
 - To change the text arrangement, touch **Array**, and then select the desired text arrangement.

9 Type **↵** to enter a line feed.



10 Type "Job".



11 Touch **≡** to align the text to the left.





12 After selecting the characters, touch **Set**.

→ The pattern editing screen appears.

13 Touch **▼**/**↵**/**▶** and adjust the position of the letters so that they are well balanced.



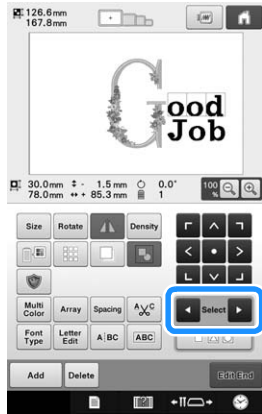

- 14** Check the balance of the entire pattern, and, if you wish to edit the pattern, touch  and  to select the pattern to be edited.

If a USB mouse is connected, the pattern can be selected by clicking it. Move the mouse to position the pointer over the desired pattern, and then click the left mouse button. In addition, patterns can be selected by directly touching the screen with your finger or touch pen.



Example: To reduce  size.

- 15** Touch  and  to move the red frame around .

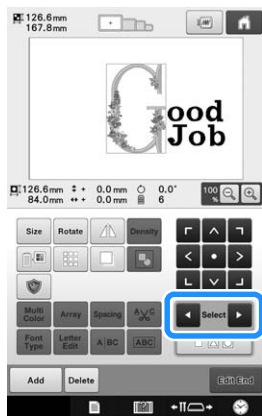

- 16** Touch .





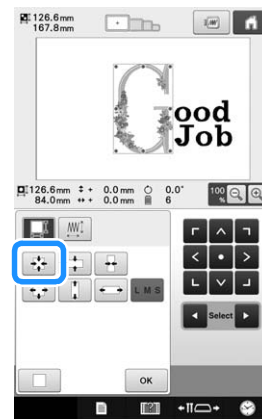

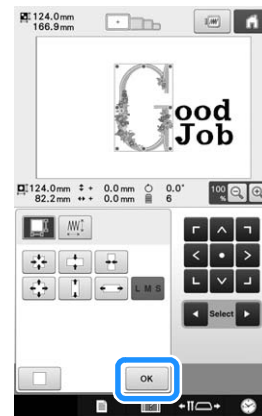

- 17** Touch  to reduce the pattern proportionately.



- 18** After reducing the pattern, touch  to return to the pattern editing screen.



- To adjust other parts of the pattern, touch  and  again, and then adjust the pattern as desired.
- If it is difficult to view the text and the pattern, touch  to enlarge the pattern and then touch , ,  or  to preview.



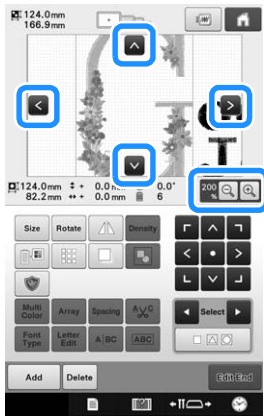

 **Memo**

- Touch  to group this combined pattern. (Refer to “Grouping multiple selected patterns” on page 148.)

19 After finishing all editing, touch **Edit End** and then **Embroidery**.

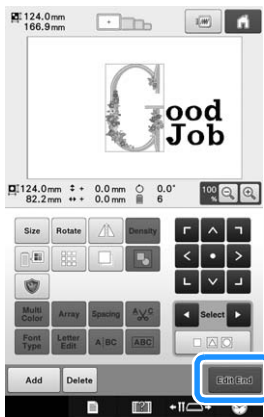

→ The embroidering settings screen appears.

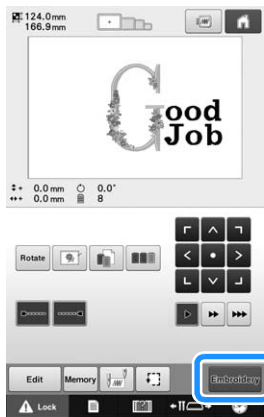



- To return to the pattern editing screen and continue editing the pattern, touch **Edit**.

This chapter contains descriptions on the use of the settings key and the machine operations guide key, introduced on page 36. Details on changing the basic embroidery machine settings and viewing operations on the LCD will be provided.

Using the Settings Key

Touch  (settings key) to change many of the basic embroidery machine settings.

Understanding the settings screen

There are six pages in the settings screen. Touch  and  in the lower-center of the screen until the desired page is displayed. The  key appears on all pages.

Page 1

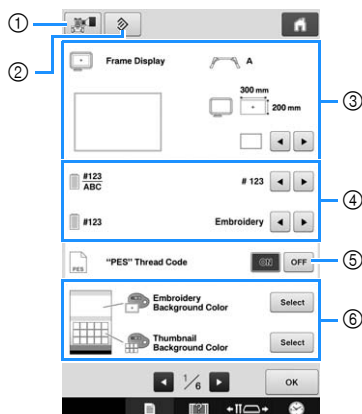

- ① An image of the current settings screen can be saved on USB media.
- ② The settings on the page containing this key will be reverted to their defaults.
- ③ The guides (centerpoint marker and grid) for the pattern display area can be specified. (Refer to page 180.)
- ④ Changing the thread color display
The color information in the thread color sequence display and the needle bar thread information can be switched to the color name, the thread brand and color number or the sewing time. (Refer to page 182.)
- ⑤ PES Thread Code
You can display the thread color for "PES" format data according to the machine setting, or setting from the embroidery editing software. (Refer to page 183.)
- ⑥ Embroidery Background Color/Thumbnail Background Color
Depending on the color of the embroidery, changing the background color of the pattern display area and thumbnails may make them more visible and easier to select. (Refer to page 183.)

Page 2

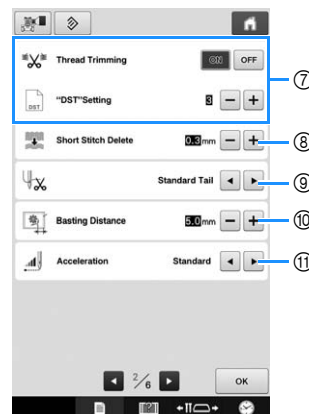

- ⑦ "DST" Setting
Specifies whether or not jumpstitches are cut. In addition, when using Tajima embroidery data (.dst), you can specify whether or not the thread is cut according to the specified number of jump codes. (Refer to page 184.)
- ⑧ Short Stitch Delete
Specifies the length of short stitches that are to be deleted. (Refer to page 184.)
- ⑨ Thread Tail
Specifies the length of upper thread that remains threaded through the needle after the thread is trimmed (length of thread passed through the eye of the needle). (Refer to page 185.)
- ⑩ Basting Distance
Specify the distance between the pattern and the basting stitching.
It can be set to 0.0 mm to 12.0 mm.
When the embroidery machine is purchased, "5.0 mm" is selected. Refer to "Basting Embroidery" on page 105 when using this setting.
- ⑪ Acceleration
Specifies the acceleration from the initial speed (when sewing begins) until the maximum sewing speed is reached.



Note

- If the settings for "DST" Setting ⑦ or "Short Stitch Delete" ⑧ are changed from the previous setting, the new settings are only applied to the next embroidery.

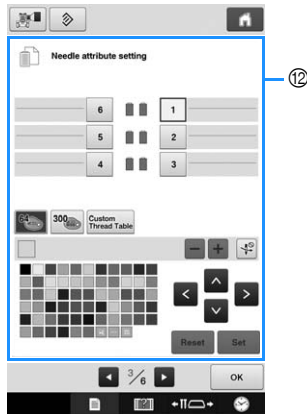

- ⑫ **Reserved Needle**
A specific thread color can be set to a needle bar. The specified color remains assigned to the needle bar specified here until the setting is cancelled. You can also specify the maximum sewing speed for a needle bar as well as cancel automatic needle threading. This feature is not accessible through the embroidering screen. (Refer to page 120.)

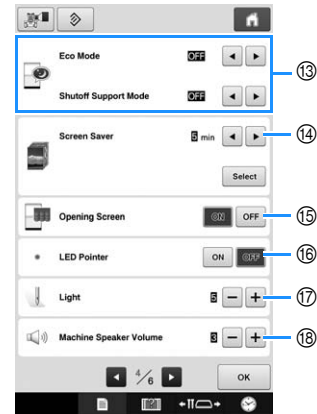

- ⑬ **Eco Mode** and **Shutoff Support Mode**. (Refer to page 185.)
- ⑭ **Screen Saver**
Select the length of time until the screen saver appears, and change the image of the screen saver. (Refer to page 186.)
- ⑮ **Opening Screen**
The machine can be set so that the opening screen is either displayed (“ON”) or not displayed (“OFF”) when the machine is turned on. If you set the “Opening Screen” to “ON”, the opening movie screen starts when the machine is turned on. The initial pattern type selection screen appears after touching the screen. If you set the “Opening Screen” to “OFF”, the initial pattern type selection screen appears when the machine is turned on. When the embroidery machine is purchased, “ON” is selected.
- ⑯ **LED Pointer**
The LED pointer function can be set on or off.
- ⑰ **Light**
The brightness of the sewing light can be adjusted. The brightness of the sewing light can be set to “OFF” or a setting between “1” and “5”. When “OFF” is selected, the sewing light does not turn on. When the machine is purchased, “5” is selected. (Refer to page 17.)
- ⑱ **Speaker**
The volume of operation sounds (which are produced when a key is touched in a screen or a button is pressed in the operation panel) and alarm sounds (which indicate that an error has occurred) can be changed. The speaker volume can be set to “OFF” or a setting between “1” and “5”. When “OFF” is selected, no sound is produced from the speaker. When the embroidery machine is purchased, “3” is selected. (Refer to page 18.)

Page 5

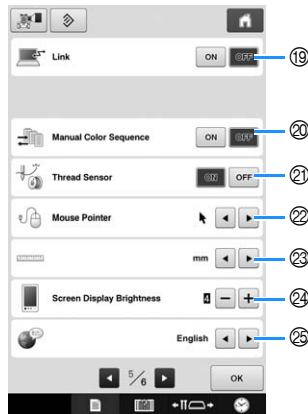

- 19 Link function
Set the Link function on or off. (Refer to page 142)
- 20 Manual Color Sequence
Set the "Manual Color Sequence" on or off. (Refer to page 108)
- 21 Thread Sensor
Set "Thread Sensor" to either "ON" or "OFF". If thread sensor is set to "OFF", the machine does not stop until embroidering is finished, even if the thread breaks or there is no more thread in the bobbin. Set thread sensor to "ON", except when it is necessary to set it to "OFF".
When the machine is purchased, "ON" is selected.

Note

- Normally, set thread sensor to "ON". When thread sensor is set to "OFF", the machine will not be able to detect if the upper thread has become tangled. Continuing to use the machine with tangled thread may cause damage.

- 22 Mouse Pointer
The shape can be selected for the pointer that appears when a USB mouse is connected. Depending upon the background color, select the desired shape from the three that are available.
When the embroidery machine is purchased,  is selected.
* The setting remains selected even if the machine is turned off.
- 23 Units of Measure
The units of measurements can be set to millimeters or inches.
When the embroidery machine is purchased, "mm" is selected.
- 24 Brightness of the Screen Display
The brightness of the screen display can be adjusted.
The screen will appear dimmer if the number on the settings screen decreases. The screen will appear brighter as the number increases.
When the embroidery machine is purchased, "4" is selected.
- 25 LANGUAGES
The language setting can be specified.

Page 6

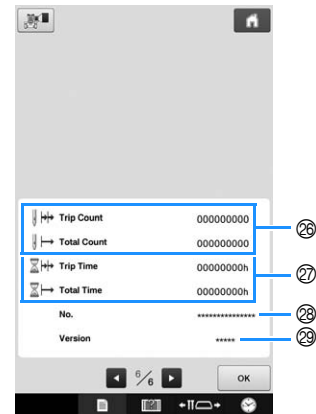

- 26 The Total Count counter shows the total number of stitches sewn, and the Trip Count counter show the number of stitches that have been sewn since the machine's last maintenance.
- 27 The Total Time counter shows the total amount of time that the machine has been used, and the Trip Time counter shows the amount of time that the machine has been used since its last maintenance.
* Use counters 26 and 27 as a standard for performing periodic maintenance and for receiving maintenance for the machine.
- 28 The "No. ##" is the number for the embroidery machine.
- 29 Version
Shows the version of the software installed on this embroidery machine. (Refer to page 231.)

Note

- Check with your local authorized Brother dealer or at "<http://s.brother/cpbac>" for details on available updates.

Details of each of the settings are described in the following sections. After specifying the desired settings, touch  to return to the screen that was displayed before the settings screen was displayed.

Note

- Some settings cannot be changed while sewing.

Changing the display guides

The guides in the pattern display area can be set. The machine automatically detects the type of embroidery frame holder and embroidery frame that are installed and displays them.

The guide settings can be specified from page 1 of the settings screen.

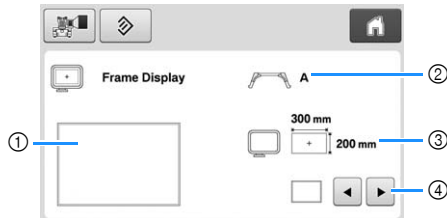





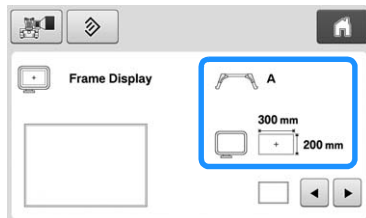

- ① How the guides will appear with the specified settings can be previewed here.
- ② Type of embroidery frame holder
Displays the type of the embroidery frame holder.
- ③ Area
Displays the size of the embroidery frame that is actually installed.
- ④ Centerpoint marker or grid lines
Select the type of the centerpoint marker and the grid lines, and whether or not to display them.

■ Type of the embroidery frame holder

The machine automatically detects the type of embroidery frame holder that is installed. If no embroidery frame holder is specified, the setting for “Cap frame/Cylinder frame” is displayed.



Embroidery frame holder A (included)	 A
Embroidery frame holder B (included)	 B
Embroidery frame holder C (Optional)	 C
Embroidery frame holder D (Optional)	 D
Embroidery frame holder E (Optional)	 E
Cap frame/Cylinder frame (Optional)	

Refer to “Types of embroidery frames/frame holders and their applications” on page 82.

■ Size of the embroidery frame

The machine automatically detects the type of embroidery frame that is installed and displays it.



Extra-large embroidery frame
200 mm (H) × 300 mm (W)
(7-7/8 inches (H) × 11-3/4 inches (W))



Flat frame (optional)
200 mm (H) × 300 mm (W)
(7-7/8 inches (H) × 11-3/4 inches (W))



Large embroidery frame
130 mm (H) × 180 mm (W)
(5-1/8 inches (H) × 7-1/8 inches (W))

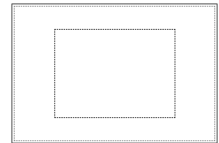

Medium embroidery frame
100 mm (H) × 100 mm (W)
(4 inches (H) × 4 inches (W))

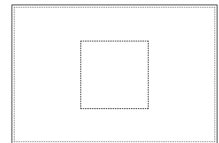

Small embroidery frame
40 mm (H) × 60 mm (W)
(1-1/2 inches (H) × 2-3/8 inches (W))

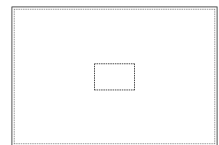

Quilt frame (optional)
200 mm (H) × 200 mm (W)
(7-7/8 inches (H) × 7-7/8 inches (W))

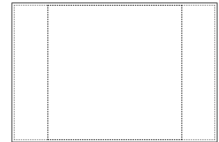

Border frame (optional)
100 mm (H) × 300 mm (W)
(4 inches (H) × 11-3/4 inches (W))



Sleeve frame (optional)
200 mm (H) × 70 mm (W)
(7-7/8 inches (H) × 2-3/4 mm (W))

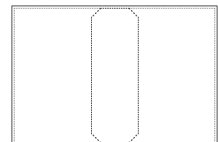



Advanced cap frame 2
(optional)
60 mm (H) x 130 mm (W)
(2-3/8 inches (H) x 5-1/8 inches (W))

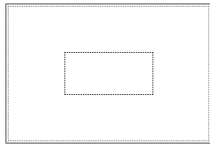

Advanced cap frame
(optional)
50 mm (H) x 130 mm (W)
(2 inches (H) x 5-1/8 inches (W))

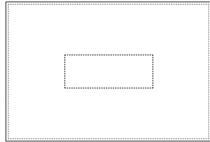

Cylinder frame (optional)
80 mm (H) x 90 mm (W)
(3 inches (H) x 3-1/2 inches (W))

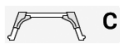
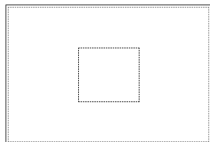

Round frame (optional)
ø 160 mm
(ø 6 inches)

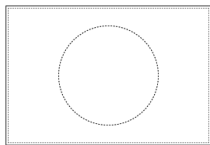

Round frame (optional)
ø 130 mm
(ø 5 inches)

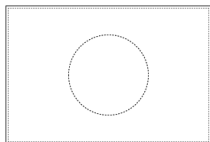

Round frame (optional)
ø 100 mm
(ø 4 inches)

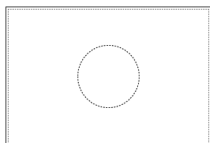

Clamp frame M (optional)
100mm (H) x 100mm (W)
(4 inches (H) x 4 inches (W))

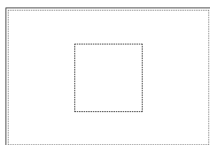

Clamp frame S/SL/SR
(optional)
24mm (H) x 45mm (W)
(7/8 inch (H) x 1-3/4 inches (W))

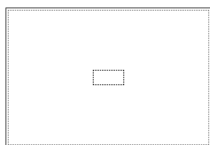

Compact frame 70
(optional)
41mm (H) x 70mm (W)
(1-5/8 inches (H) x 2-3/4 inches (W))

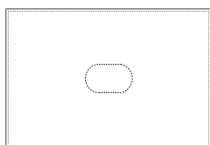

Compact frame 50
(optional)
50mm (H) x 50mm (W)
(2 inches (H) x 2 inches (W))

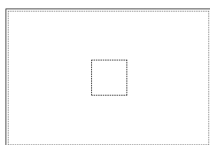

Compact frame 44
(optional)
38mm (H) x 44mm (W)
(1-1/2 inches (H) x 1-3/4 inches (W))



Compact frame Portrait orientation (optional)
75mm (H) x 33mm (W)
(2-15/16 inches (H) x 1-5/16 inches (W))

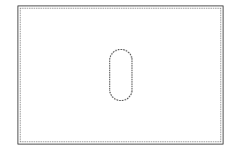

Magnetic frame (optional)
50mm (H) x 50mm (W)
(2 inches (H) x 2 inches (W))

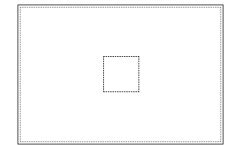

Centerpoint marker and grid lines

The centerpoint is indicated with a red plus sign (+). When the embroidery machine is purchased, the centerpoint marker and grid lines are not displayed.

- 1 Touch and to select the type of the centerpoint marker and the grid lines, and whether or not to display them.

The centerpoint marker is displayed as specified.

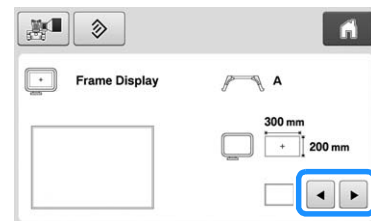

Grid lines
(10 mm spacing)

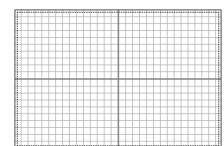

Grid lines
(25 mm spacing)

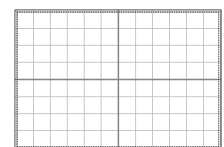

Cross grid lines

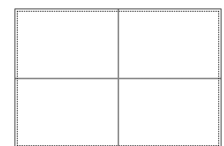

Centerpoint marker

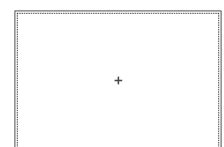

Centerpoint marker and grid lines (10 mm spacing)

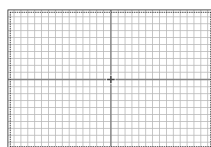

Centerpoint marker and grid lines (25 mm spacing)

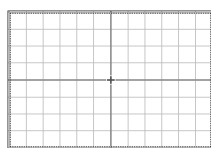

Centerpoint mark with cross grid lines

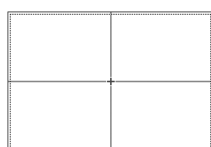

No centerpoint marker or grid lines



Changing the thread color information

You can display the name of the thread colors, embroidery thread number or the embroidering time.

When the embroidery machine is purchased, the thread color number (#123) is selected.

The thread color display setting can be specified from page 1 of the settings screen.

1 Touch ◀ and ▶ to display the name of the thread colors, the embroidery thread number or the embroidering time.

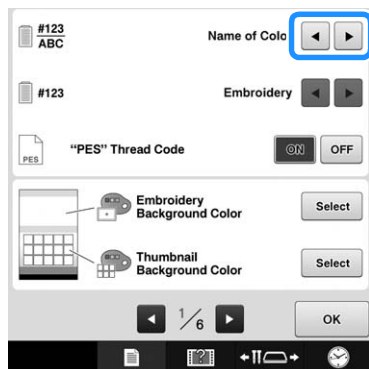

2 When the thread number [#123] is displayed, touch ◀ and ▶ to select from six embroidery thread brands pictured below.

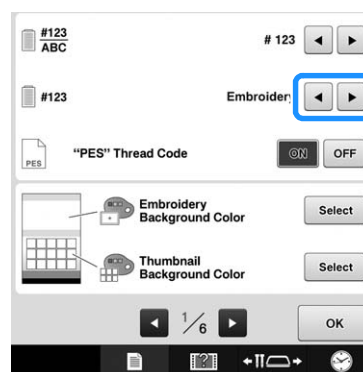

Sample displays

Thread color number (#123)

Madeira Poly (Polyester)	Madeira Rayon (Rayon)
1848 Madeira Poly 1	1049 Madeira Rayon 1
1770 Madeira Poly 2	1369 Madeira Rayon 2
1986 Madeira Poly 3	1081 Madeira Rayon 3
1637 Madeira Poly 4	1037 Madeira Rayon 4
Sulky (Rayon)	Robison-Anton (Polyester)
1177 Sulky 1	5622 R-A Poly 1
1176 Sulky 2	9091 R-A Poly 2
1511 Sulky 3	5561 R-A Poly 3
1037 Sulky 4	5678 R-A Poly 4
Embroidery (Polyester)	Country (Cotton*)
513 Embroidery 1	444 Country 1
515 Embroidery 2	446 Country 2
807 Embroidery 3	158 Country 3
900 Embroidery 4	149 Country 4

* Depending on the country or area, cotton-like polyester thread is sold.

Thread color name

Name of Color

LIME GREEN	1
MOSS GREEN	2
CARMINE	3
RED	4

Time			
Time			
▶ 2	min		1
1	min		2
1	min		3
1	min		4

Memo

- The thread colors in the thread color sequence display and in the patterns in the pattern display area are displayed in the original thread color (i.e. the thread colors that have been built-in the machine). The thread color numbers are displayed with the number (or the nearest number) for the brand specified here.
- Colors on the screen may vary slightly from actual spool colors.

Selecting the thread color information for “PES” format data

You can display the thread color for “PES” format data according to the machine setting, or setting from the PE-DESIGN, PE-DESIGN Lite or PED-BASIC (embroidery editing software).

(Refer to “Changing the thread color information” on page 182 for the machine setting of thread color.)

The “PES Thread Code” can be selected from page 1 of the settings screen.

ON: The thread color information displayed according to the PE-DESIGN, PE-DESIGN Lite or PED-BASIC (embroidery editing software)

OFF: The thread color information displayed according to the machine setting.

When the machine is purchased, “ON” is selected.

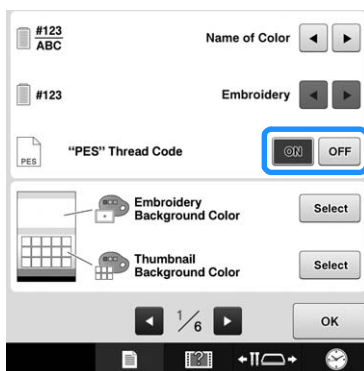

Changing the background colors of the embroidery patterns or thumbnails

The background colors of the pattern display area and pattern thumbnails. Depending on the pattern color, select the desired background color from the 66 settings available. Different background colors can be selected for the pattern display area and pattern thumbnails.

When the embroidery machine is purchased, white color is selected.

The background color settings can be specified from page 1 of the settings screen.

1 Touch

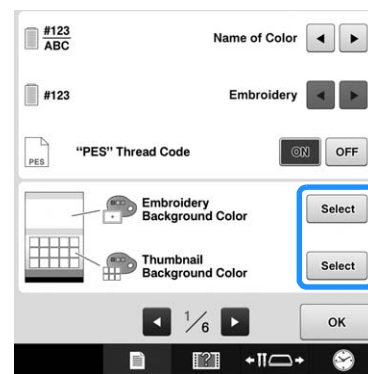

2 Select the background color from the 66 settings available.

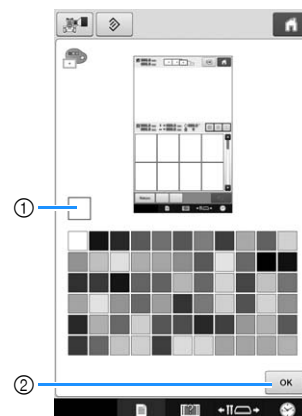

① Selected color

② Touch to return to the settings screen.

Memo

- The setting remains selected even if the machine is turned off.



Specifying jumpstitch trimming / "DST" jump codes for trimming

You can specify whether or not jumpstitches are cut. In addition, when using Tajima embroidery data (.dst), you can specify whether or not the thread is cut according to the specified number of jump codes.

ON: The machine cuts the upper and bobbin thread before the jumpstitch. When Tajima embroidery data (.dst) is used, the machine converts the "jump" code to a trim code, based on the number specified on the next line.

OFF: The machine does not cut either a jumpstitch or the "jump" code in Tajima embroidery data (.dst).

When the machine is purchased, "ON" is selected and the number of jumps is set to "3".

The "DST" thread trim settings can be specified from page 2 of the settings screen.



Note

- If the setting is changed from the previous setting, the new setting is only applied to the next embroidery.

- 1 Touch **ON** or **OFF** to select the desired setting.

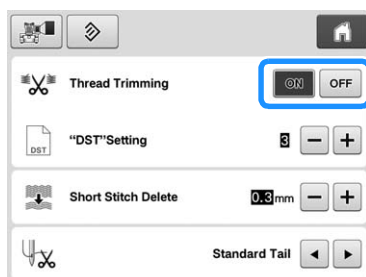

Note

- This setting is not applied to the trimming of threads between characters in alphabet patterns. (Refer to "Trimming the threads between characters" on page 155.)



Memo

- The number of jump codes cannot be specified for data other than Tajima embroidery data (.dst).

When using Tajima embroidery data (.dst)

- 2 If "ON" is selected, touch **+** and **-** to select the number of feed codes.

The desired setting is displayed.

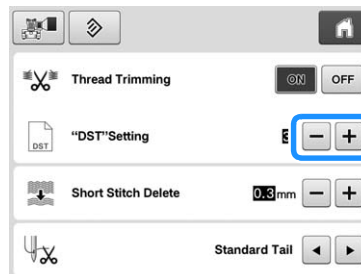

- A value between 1 and 8 can be specified. For example, if 3 is specified, sequential 3 jump codes will be converted to the trim code. But sequential 2 jump codes will not be converted to the trim code, it will be sewed as the feed (jump) stitch.



Note

- You need to set the jump number same as the number that was used when the particular Tajima data was created. If the jump number is not matched, either unexpected trim or no trimming at trim expected point will happen.

Deleting short stitches

If embroidery data other than our original patterns are used, the stitch length may be too short, possibly resulting in the thread or the needle breaking. In order to prevent this problem from occurring, the machine can be set to delete stitches with a short stitch length. Stitches with a length less than that specified in this function, can be deleted.

When the embroidery machine is purchased, "0.3" was selected (delete stitches with a length of 0.3 mm or less).

1 Touch **+** and **-** to select the stitch length.

The desired size is displayed.

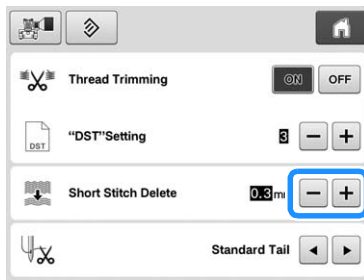

- A value between 0 and 1 millimeters if the units of measurements is set to "mm" (or a value between 0 and 0.04 inch if the units of measurements is set to "inch") can be specified.



Note

- If the setting is changed from the previous setting, the new setting is only applied to the next embroidery.

Specifying the remaining length of thread

This setting specifies whether the length of upper thread that remains threaded through the needle after the thread is trimmed (length of thread passed through the eye of the needle) has a standard tail or long tail.

When the embroidery machine is purchased, "Standard Tail" is selected.

The setting for the remaining length of thread can be specified from page 2 of the settings screen.

1 Touch **◀** and **▶** to select the setting.

The desired length is displayed.

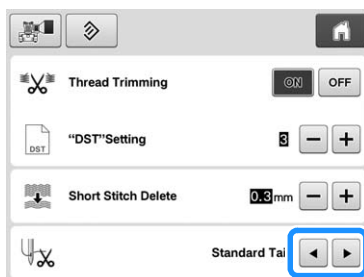

- If the machine misses stitches with a standard length of thread after it is trimmed, select "Long Tail".
- When using metallic thread, select "Long Tail".

Selecting the "Eco Mode" or "Shutoff Support Mode"

You can save the machine power by setting the eco mode or the shutoff support mode.

If you leave the machine without using for a specified period of time, the machine enters in one of these modes.

"Eco Mode";

Machine will enter a sleep mode. Touch the screen or "Start/Stop" button to continue embroidering.

"Shutoff Support Mode";

Machine will turn off after set period of time. Turn machine off and then back on to restart embroidering.

Condition	Eco Mode	Shutoff Support Mode
Available time	OFF, 10 - 120 (minute)	OFF, 1 - 12 (hour)
"Start/Stop" button	Green flashing	Green slow flashing
Suspended function	Machine light, Screen display	All functions
After recovering	The machine starts from the previous operation.	You need to turn off the machine.

Press the "Start/Stop" button or touch the screen display to recover from these modes.

These settings can be specified from page 4 of the settings screen.

1 Use **◀** or **▶** to select the time until entering the mode.

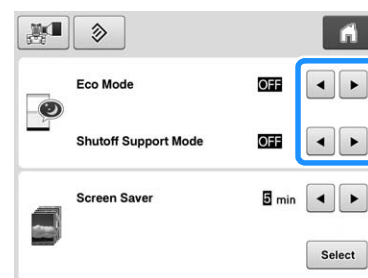

Note

- If you turn off the machine while the machine is in the "Eco Mode" or the "Shutoff Support Mode", wait for about 5 seconds before turning on the machine again.



Changing the screen saver settings

■ Specifying the length of time until the screen saver is displayed

The screen saver is displayed when no machine operation is performed for the specified length of time.

A setting between “OFF” (0) and “60” minutes can be set in 1-minute increments.

When the embroidery machine is purchased, “5 min” is selected.

The screen saver settings can be specified from page 4 of the settings screen.

- 1 Touch ◀ and ▶ to select the desired setting.

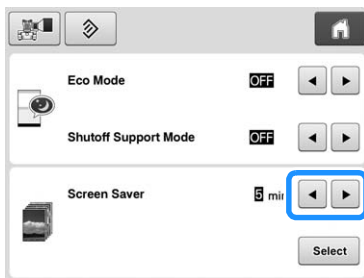

■ Changing the screen saver image

You can select your own personal images for the screen saver of your machine.

Before changing the screen saver image, prepare the image on your computer or USB media.

When the embroidery machine is purchased, the default setting is selected.

The screen saver settings can be specified from page 4 of the settings screen.

Compatible image files

Format	JPEG format (.jpg)
File size	Max. 2 MB for each image
File dimension	800 × 1280 pixels or less, (If the width is more than 800 pixels, the image imported will be reduced to a width of 800 pixels.)
Number allowed	5 or less

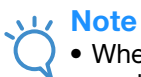

Note

- When using USB media, make sure that it contains only your own personal images to be selected for the screen saver.
- Images saved on an SD card cannot be selected for the screen saver. Use images from the computer or USB media.
- Folders are recognized. Open the folder that holds your personal images.

- 1 Touch **Select**.

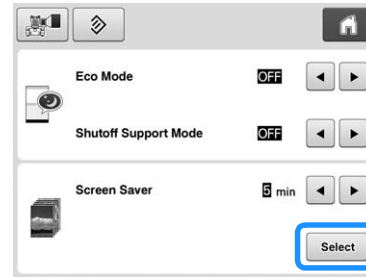

- 2 Touch **Customize**.

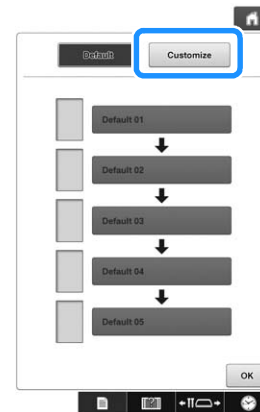

- 3 Connect the USB media or the computer (using a USB cable) that contains your personal image to the USB port of the machine.

- Refer to page 74 about USB connectivity.

- 4 Touch **Customize 01** to select the first image.

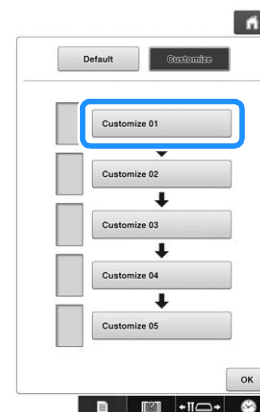

- The images will appear in a list in this screen. Select the desired number to specify the image.

5 Select the device that is connected.

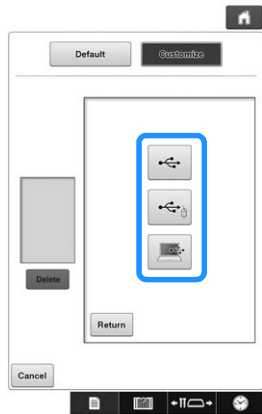

- Touch when connecting USB media to the top USB port.
 - Touch when connecting USB media to the center USB port.
 - Touch when connecting a computer using a USB cable, and then copy your personal images into "Removable Disk", which appears on the desktop of the computer.
- A list of your personal images appear on the screen.
- Touch to delete the selected image.
 - Touch to return to the previous screen.

Note

- SD card cannot be recalled.

6 Touch a file name to select image and then touch .

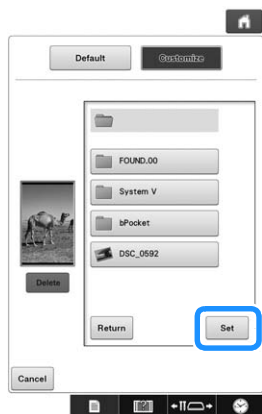

- The selected image is stored on your machine.
- Touch to return to the previous screen.

7 Following the same procedure from step **4**, select the remaining images.

Using the Machine Operations Guide Key

This machine contains information based on the contents of the Operation Manual, such as basic machine operations. Touch (machine operations guide key), and then select either to view the operation guides or to play tutorial videos.

Viewing the operation guides

■ Contents of Categories

Principal Parts

Displays and explains principal parts of the machine and their functions.

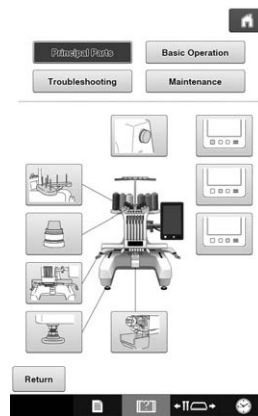

Basic Operation

Illustrates basic threading and hooping instruction.

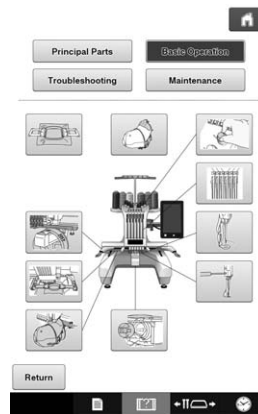

Troubleshooting

Basic guide for problems solving.

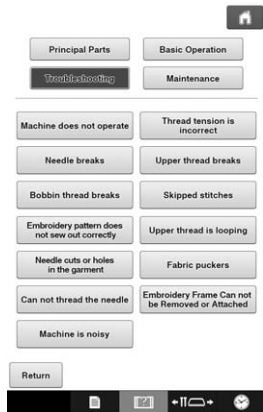

Maintenance

Instruction for maintaining your machine.

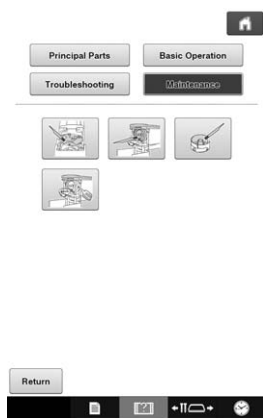

Example: To learn how to thread the upper thread

1 Touch .



→ The machine operations guide screen appears.

2 Touch .

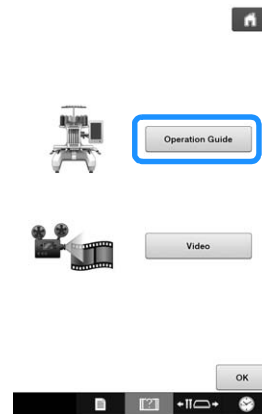

3 Touch .

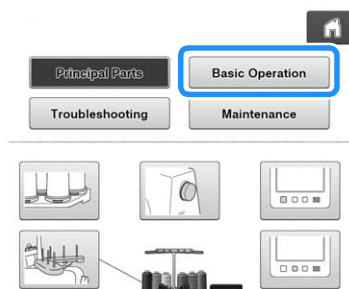



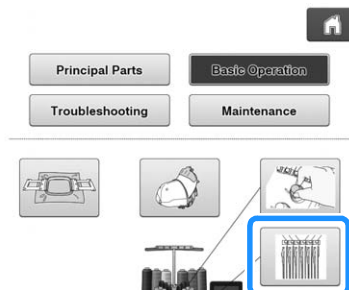

→ The list of basic operations appears.

4 Touch .



→ The procedure for threading the upper thread appears.

5 Read the instructions.

- Touch  to display the next page.
- Touch  to display the previous page.
-  and  may appear in some pages. Touch these keys to scroll up or down through the page.

6 Touch  may appear in some pages.

Playing a tutorial video

This machine provides tutorial videos on how to use the machine. Together with the help guides, which offer descriptions through text and illustrations, the tutorial videos assist with machine operation.

- 1 Press .
- 2 Press .
- 3 Press the title of the desired tutorial video.

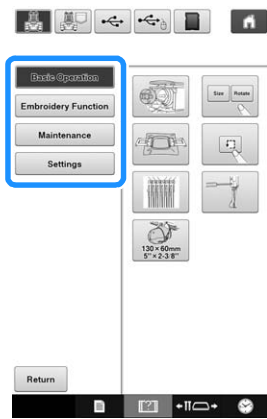





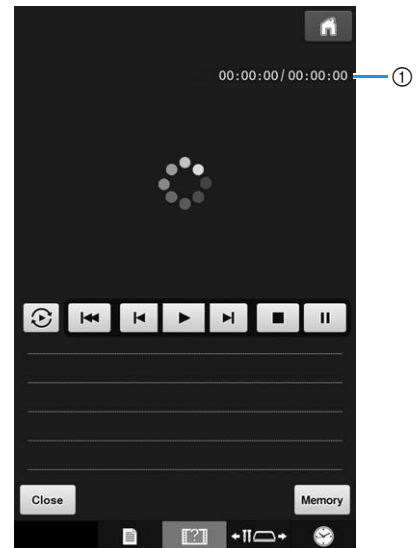



→ The selected tutorial video begins playing.

4 Play the tutorial video.



- ① Number of seconds elapsed/Total number of seconds

Operation keys

	Play
	Stop
	Pause
	Skip back 10 seconds
	Skip forward 10 seconds
	Return to beginning
	Repeat
	Delete video (when playing from the machine's memory)
	Save to machine (when playing from USB media)



Memo

- A frequently viewed tutorial video can be saved to  (favorites) of the machine, from where it can be played.

- 5 After you are finished playing the video, touch .

Playing MPEG-4 (MP4) videos

Your MP4 videos can be played from USB media. In addition, the MP4 video can be saved to the machine so that a tutorial video on creating a project, for example, can be viewed at any time.

Videos that can be played

MP4 file format: Video - H.264/MPEG-4 AVC, Audio - AAC
Size: 450 (H) × 800 (W)

Memo

- MP4 file size will be changed to fit the screen. If you view the large MP4 file, the file will be reduced to fit the screen. If you view the smaller MP4 file, the file will be expanded to fit the screen.
- Some type of MP4 file cannot viewed with the machine.

1 Press .

2 Press .

3 Select the device where the video is saved.

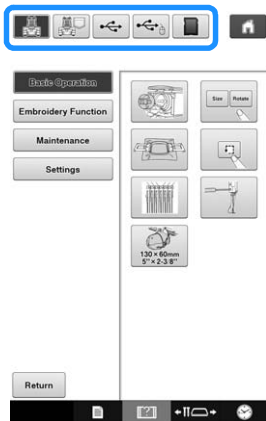

 : play a tutorial video

 : Play a video saved on the machine (favorites)

 : Play a video from USB media plugged into the USB port

 : Play a video from USB media plugged into the USB port for mouse

 : Play a video from SD card inserted in the machine

* To return to the previous screen, touch .

4 Select the video that you want to play.



* To return to the previous screen, touch .

5 Play the video.

* Use the operation keys as described in “Playing a tutorial video” on page 189.

Note

- Up to about 1 GB of MP4 videos can be saved on the machine. When the maximum capacity has been reached, delete unnecessary videos.

6 After you are finished playing the video, touch .

This chapter provides descriptions of techniques for sewing applications, pointers for creating beautiful embroidery, and details on maintenance procedures and corrective measures that should be taken when a problem occurs.



Appliqué Sewing

This section describes the procedure for sewing appliqués.

Sewing appliqué patterns

Some of the built-in embroidery patterns can be used for sewing appliqués. Follow the procedures described below to sew appliqués using the patterns with “APPLIQUE MATERIAL”, “APPLIQUE POSITION” or “APPLIQUE” in the region display at the top of the thread color sequence display.

“APPLIQUE MATERIAL”, “APPLIQUE POSITION” and “APPLIQUE” are assigned to a specific needle bar number.

*Depending on the thread color display setting, the display may appear as  (Appliqué Material),  (Appliqué Position) or  (Appliqué).

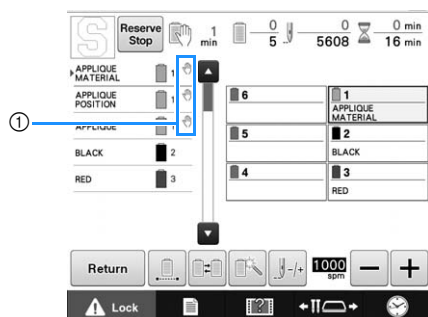

- ①  appears in the screen at places where the machine is stopped.

■ Procedure for sewing appliqués

- 1 Place stabilizer on the back of the appliqué fabric/material.
- 2 Frame the fabric for the appliqué (from step 1) in the embroidery frame, and then sew an “APPLIQUE MATERIAL” pattern. The line that indicates where the appliqué will be cut out is sewn, and then the machine stops.

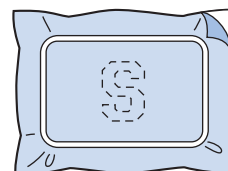

- 3 Remove the appliqué fabric from the embroidery frame, and then carefully cut along the sewn cutline.

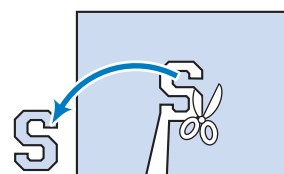

- If the appliqué is cut out along the inside of the sewn cutline, the appliqué may not be correctly attached to the fabric. Therefore, carefully cut out the appliqué along the sewn cutline. If this step is not performed carefully, the appliqué will not be cleanly finished. In addition, carefully remove any excess threads.

- 4 Frame the base fabric or garment in the embroidery frame, and then sew an “APPLIQUE POSITION” pattern. The appliqué position is sewn, and then the machine stops.

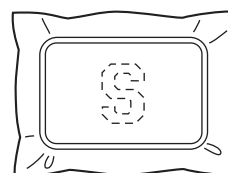

- 5** Lightly apply fabric glue or spray adhesive to the back of the appliqué piece that was cut out, and then attach the appliqué piece to the base fabric at the position sewn using the “APPLIQUE POSITION” pattern in step 4.

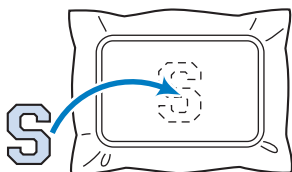

- If an iron-on stabilizer is used to attach the appliqué piece to the base fabric, iron the pieces together without removing the base fabric from the embroidery frame.

- 6** After attaching the appliqué piece, sew an “APPLIQUE” pattern. The appliqué is finished.

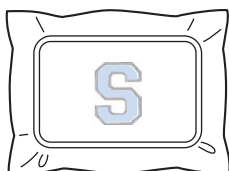

- Depending on the pattern, an “APPLIQUE” pattern may not be available. In this case, sew the appliqué using thread in the color of a part of the embroidery.

- 7** Finish sewing the embroidery.

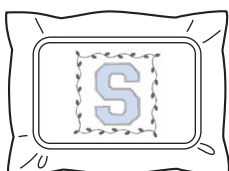

Using a frame pattern to create appliqués (1)

Appliqués can be created by sewing two frame patterns of the same size and shape—one sewn with straight stitches and the other sewn with satin stitches.

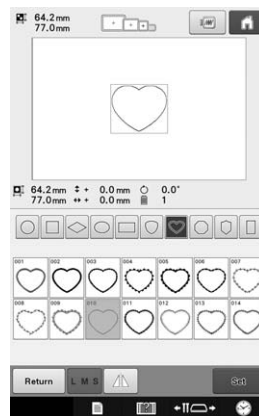

- 1** Select a frame pattern sewn with straight stitches to embroider onto the fabric for the appliqué. Carefully cut outside of the stitching.

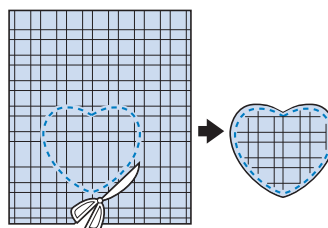

- 2** Embroider the same pattern on the base fabric.

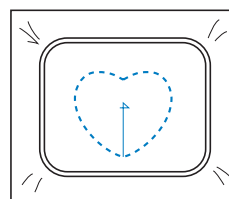

- 3** Lightly apply fabric glue or spray adhesive to the back of the appliqué piece that was cut out in step **1**, and then attach the appliqué piece to the base fabric.

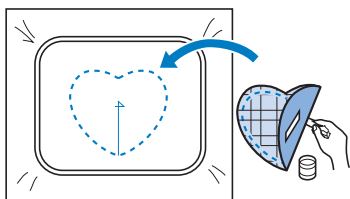

- 4** Select the satin-stitched frame pattern with the same shape to embroider the appliqué attached in step **3**.

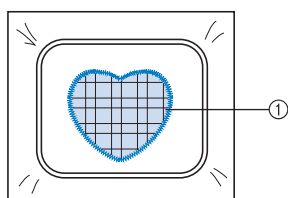
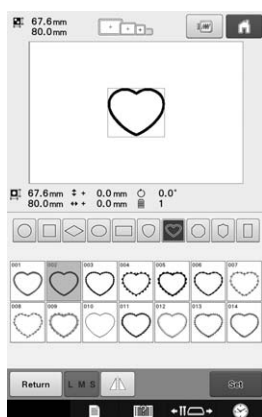

① Appliqué



Note

- If the size or sewing position of the straight-stitched frame pattern is changed, be sure to change the size or sewing position of the satin-stitched frame pattern in the same way.

Using a frame pattern to create appliqués (2)

There is another way of sewing appliqués. With this method, there is no need to change the fabric in the embroidery frame. The appliqué can be created by sewing two frame patterns of the same size and shape—one sewn with straight stitches and the other sewn with satin stitches.

- 1** Select a frame pattern sewn with straight stitches to embroider onto the base fabric.

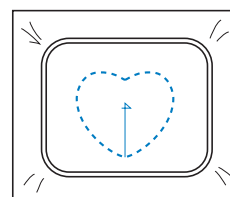
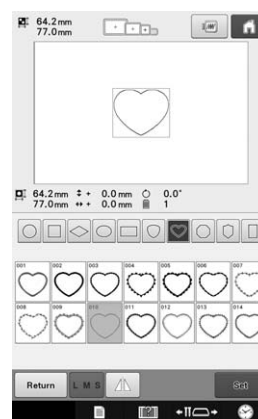

- 2** Place the appliqué fabric over the embroidery sewn in step **1**. Make sure that the area surrounded by the stitching is not larger than the area of the appliqué fabric.

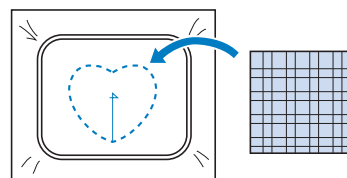

3 Embroider over the appliqué fabric using the same frame pattern.

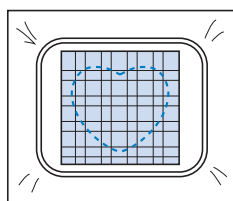

- Be sure to stop the machine before the cross at the center is sewn.

4 Remove the embroidery frame from the machine, and then cut off the excess appliqué fabric along the outside of the stitching.

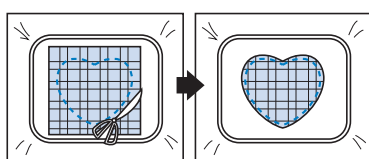

Note

- Leave the fabric in the embroidery frame when cutting off the excess appliqué fabric. In addition, do not apply extreme pressure to the framed fabric, otherwise the fabric could become loose.

5 Select the satin-stitched frame pattern with the same shape.

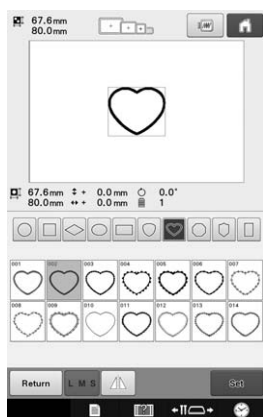

Note

- If the size or sewing position of the straight-stitched frame pattern is changed, be sure to change the size or sewing position of the satin-stitched frame pattern in the same way.

6 Attach the embroidery frame removed in step 4, and then finish embroidering the appliqué.

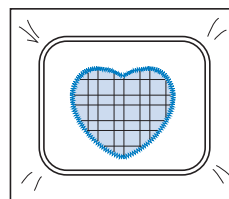

Sewing Large-size (Split) Embroidery Patterns

Large-size (split) embroidery patterns created with PE-DESIGN Ver.7 or later can be sewn. With large-size embroidery patterns, embroidery designs larger than the embroidery hoop are divided into multiple sections, which combine to create a single pattern after each section is sewn.

For details on creating large-size embroidery patterns and for more detailed sewing instructions, refer to the operation manual included with PE-DESIGN Ver.7 or later.

The following procedure describes how to read the large-size embroidery pattern shown below from USB media and embroider it.

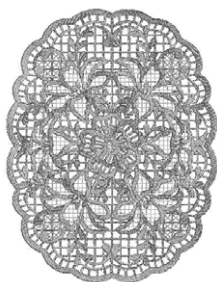

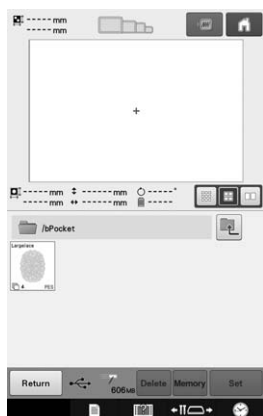

- 1 **Connect to the machine the media containing the created large-size embroidery pattern, and then select the large-size embroidery pattern to be embroidered.**

* For details on recalling patterns, refer to "Recalling from USB media/SD card" on page 138 and "Recalling from the computer" on page 139.



→ A screen appears so that a section of the large-size embroidery pattern can be selected.

- 2 **Select section  to be embroidered, then touch .**

- Select the sections in alphabetical order.
- A maximum of 10 sections can be displayed in one page with normal thumbnail size. If there are 11 or more sections in the pattern, touch  or  to display the previous or next page. With large thumbnail size, a maximum of 4 sections can be displayed in one page. With small thumbnail size, a maximum of 21 sections can be displayed in one page.

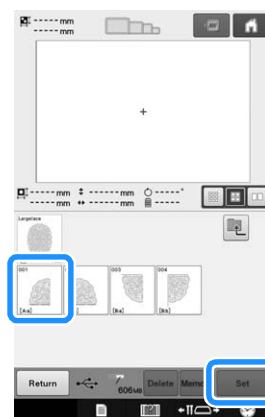

- 3 **If necessary, edit the pattern. Then, touch .**

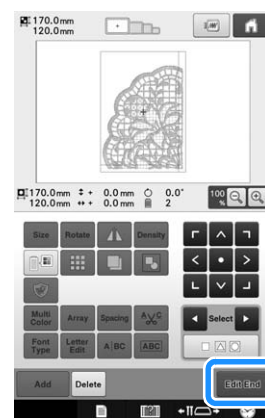

- For details, refer to "Editing the Embroidery Pattern (Pattern Editing Screen)" on page 146.

- 4 **Confirm the pattern size, and then select the appropriate fabric and the embroidery frame.**

- Be sure to select fabric of the size of combined pattern.

- 5 Hoop the appropriate part of the fabric. In this case, hoop upper-left part of the fabric.

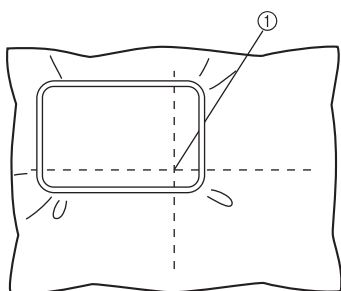

① Center of fabric

- 6 Touch **Embroidery**.

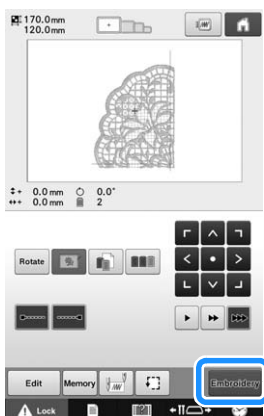

Memo

- The pattern can be rotated to either the left or right when **Rotate** is touched.

- 7 Touch **Lock**, and then press the start/stop button to embroider the pattern section.

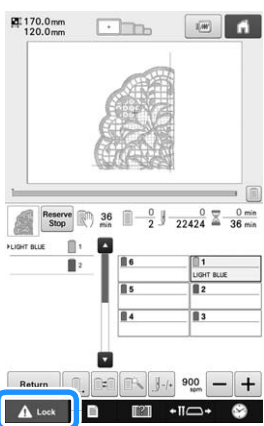

Note

- The last step of the stitching of the pattern section will be an alignment stitching. Use this stitching for placement of adjacent pattern section.

- 8 When embroidering is finished, the following screen appears. Touch **OK**.

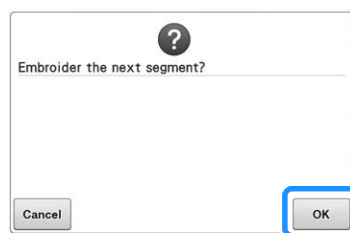

→ A screen appears so that a section of the large-size embroidery pattern can be selected.

- 9 Touch  to select the next section of the pattern, and then touch **Set**.

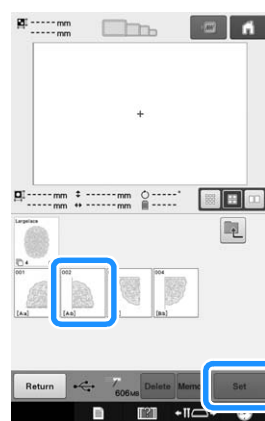

- 10 Touch **Edit/End**, and then **Embroidery**.

- 11 Hoop the fabric for the next design section aligning on the alignment stitching. In this case, align the left side of the hoop on the right side of the design section embroidered in step 6.

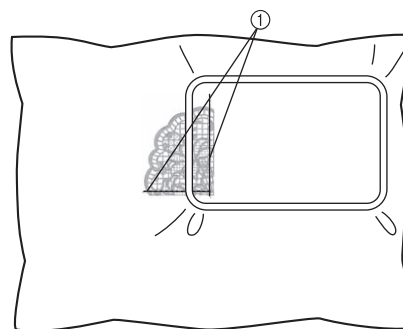

① Alignment stitching



Note

- Make sure that the alignment stitching is completely within the embroidery field. Set the embroidery sheet inside the embroidery frame and align the grid with the alignment stitching for easier placement.

- 12 Repeat steps 7 to 10 to embroider and combine the remaining sections of the pattern.

Helpful Tips for the Operation of the Machine

This section provides descriptions to operations useful in the operation of this machine.

Checking the thread tension of built-in patterns

We will sew this pattern to check the thread tension.



- 1 Touch .



→ The embroidery pattern categories appear.

- 2 Touch .

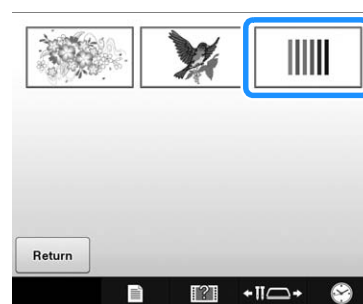

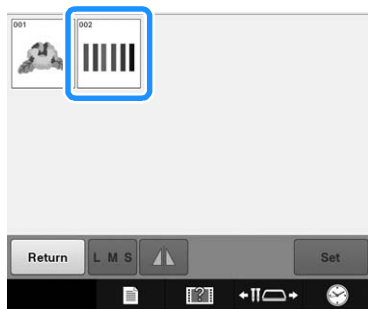

→ The list of embroidery patterns appears.

3 Touch .

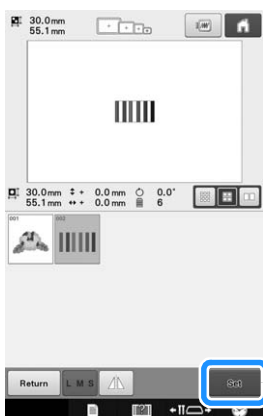

4 Touch .



5 Touch .



6 Touch .

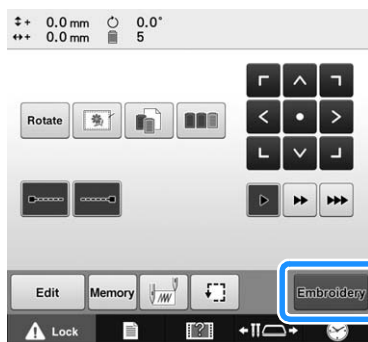

7 Touch  (unlock key), and then press the start/stop button to begin embroidering.

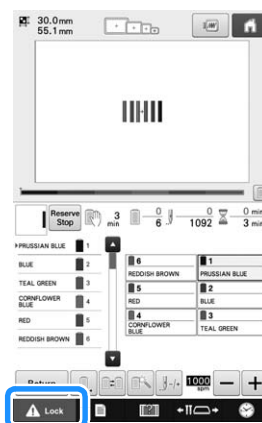

8 Correct thread tension. On the wrong side of the fabric, the bobbin thread should be about one third of the stitch width, as a standard.

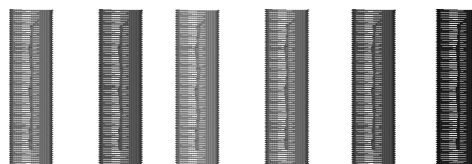

 **Note**
 • If adjustment is necessary, refer to instructions on page 102, 103.

Sewing a pattern aligned with a mark on the fabric

By specifying the beginning of stitching and the end of stitching, the exact position of the pattern can be checked.

For example, when sewing text along a line in the fabric pattern, the beginning of the stitching can be set in the lower-left corner so that the position can be checked, and then the beginning of stitching can be reset. Next, the beginning of stitching can be set in the lower-right corner to check the position. The straight line connecting the first point and the second point is the baseline for the text. If the baseline that the text follows leaves the fabric pattern, the embroidering position can be adjusted.

- 1 Touch  in the embroidering settings screen.

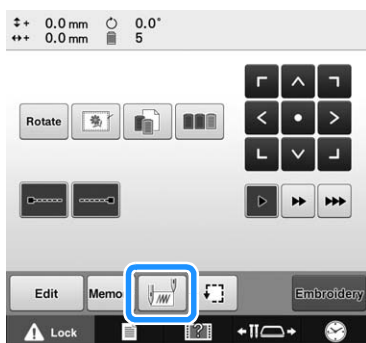

- 2 Set the beginning of stitching in the lower-left corner.

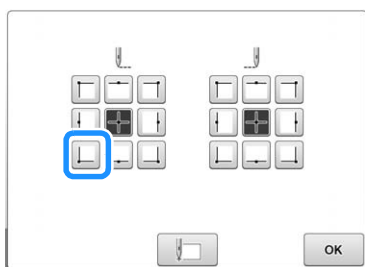

→ The frame moves so that the needle drop point aligns with the beginning of stitching.

- 3 With a fabric marker, mark this point on the fabric.

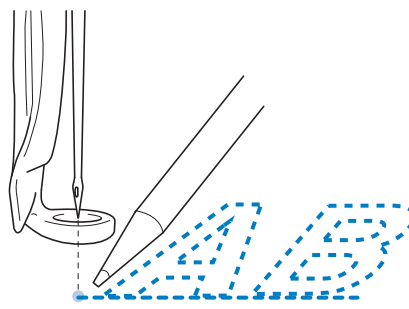

Memo

- If the LED pointer is set to "ON", it shows you the needle drop point.

- 4 Set the beginning of stitching in the lower-right corner.

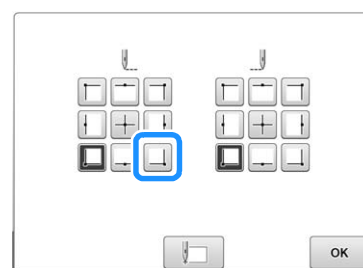

→ The frame moves so that the needle drop point aligns with the beginning of stitching.

- 5 With a fabric marker, mark this point on the fabric.

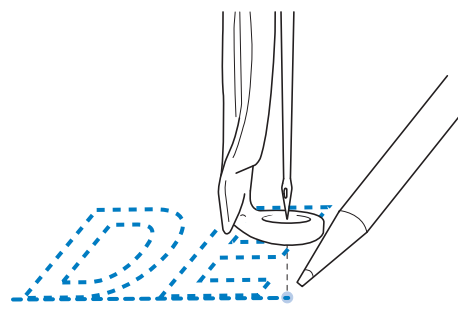

- 6 Remove the embroidery frame from the machine, and then connect these two points to check the embroidering position.



- If the baseline is misaligned or intersects another line, reframe the fabric in the embroidery frame or adjust the position of the pattern.

Color thread table

Additional explanations of the machine's built-in color thread table and the custom thread table are provided below.

Normally, the thread colors in the thread color sequence display and in the pattern display area are displayed in the colors of the machine's built-in color thread table. The thread color numbers with these thread colors are displayed with the thread color number (or the nearest number) for the brand specified on the first page of the settings screen. Therefore, the finished embroidery colors may have a slightly different tinge.

However, since the custom thread table specified on the change thread color screen in the pattern editing screen is created by specifying thread colors by the thread color numbers and color names from individual brands in the machine's built-in color library, the thread table is displayed with those original thread colors.

If pattern colors changed using the custom thread table, pattern can be previewed with colors nearest to the actual embroidered thread colors.

Create color thread tables from the colors of threads that you have and use them to display the patterns in your own thread colors.

(Refer to "Creating a custom thread table" on page 167, and "Choosing a color from the custom thread table" on page 169 for the change thread color function.)

Normal thread color display

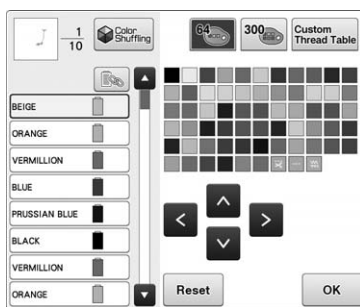

Thread color display using a custom thread

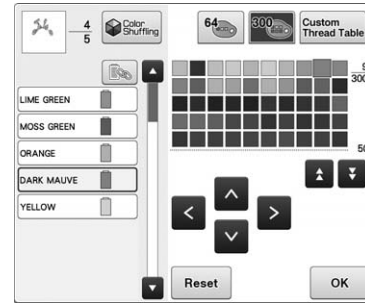

Colors of Tajima (.dst) embroidery data

Tajima data (.dst) does not contain pattern color information. The data is created by combining only shapes.

For example, the following embroidery data appears as shown below in the Tajima format (.dst)

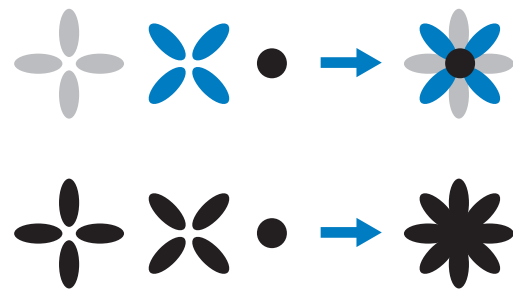

In order for the parts of the pattern to be differentiated when Tajima data is used with this machine, the pattern is displayed with colors automatically applied in the default thread color sequence. Since the thread colors are applied according to the sewing order of the parts, regardless of the design of the pattern, colors may be applied that seem unusual for the design, for example, an orange-colored fruit may be displayed in blue.

When using Tajima data, be sure to preview the sewn image on the screen and change the colors from the change thread color screen.

It is recommended to try the Manual color sequence if you use Tajima data very often. Using the Manual color sequence, you can directly change the color setting according to your thread spool setting. Set "Manual Color Sequence" to "ON" in the settings screen. (Refer to page 108.)

Creating Beautiful Embroidery

The various precautions concerning the thread, embroidery frames and stabilizers (backings) that must be observed in order to create beautiful embroidery are described below.

Threads

Embroidery thread can be costly, therefore caring for it should be a priority. No matter how well a thread is manufactured, it must be appropriately stored if it is to sew properly. This is especially true when one considers the time that lapses between delivery to the thread user and the moment the thread is actually used on the embroidery machine. It is important that embroidery threads be stored in an environment that is free of damaging agents such as excessive heat, light or moisture.

Embroidery threads are best stored in an area that is as clean and dust-free as possible. It is also important that the storage area be free of smoke, fumes and gases. Certain gases may cause the thread to yellow. These fumes originate from such appliances as gas heaters or from gas or diesel engines.

Direct sunlight is also extremely destructive for embroidery threads. Boxes of thread should not be left open and exposed to direct sunlight. If possible, skylights and windows should be diffused. The best type of lighting for embroidery thread is tungsten-filament or fluorescent tubes. It is important to remember that prolonged exposure to these harmful sources may also cause the colors of cardboard boxes and other objects to fade.

Temperature and humidity also pose a threat to embroidery threads. The ideal conditions are between 59 °F and 77 °F (or 15 °C and 25 °C). Humidity should be between 40% and 60%. These conditions should be kept as constant as possible in order to prevent mildew from forming. Excessive temperatures can also cause lubrication problems that ultimately result in thread breaks. Damp conditions can affect paper bobbins as the cardboard will swell and the thread can become oversized. It is also important to realize that even if the overall storage conditions are good, there may be "spot problems" where a thread is exposed to a heat source or bright lights. Ensuring that thread does not become damaged requires that stock be frequently rotated and that threads are not left in the same place for an extremely long time.

Choice of thread is a major factor in improving production time. The thread run ability, strength, consistency and weight all affect output. These qualities determine how well the machine will sew and the number of thread breaks during sewing.

Thread breaks have an important influence on production. Each thread break reduces output by at least 0.07% a day (7.5 hours), assuming that it takes 20 seconds to rethread a needle. For every reduction of 14 thread breaks per a day, output can be improved by more than 1.0 %.

Stabilizers (backing)

Backing and topping serve to stabilize and support the product being embroidered so the stitches can be sewn with the least amount of interference or instability. They serve as stabilizers for your embroidery work. Without the proper type of stabilizer, the fabric may move too much within the embroidery frame causing poor alignment of the embroidery. At times, topping will be required in order to manage fabrics with a pile-like surface, such as towels, corduroy and piqué knit. There are many types of backing and toppings with various weights for the various fabrics that you may be sewing.

There are four types of stabilizers (backing) that can be used in embroidery: cut-away, tear-away, water soluble and self-adhesive. In these four types, various weights, sizes and textures are available. When selecting the stabilizer type for a particular fabric, consider the design size in addition to the stitch count and stitch type used in the design.

Finally, make sure that the stabilizer is not stretched. Some backings may not stretch vertically or horizontally but may stretch diagonally. **DO NOT USE THESE TYPES.** This type of backing will stretch during sewing and may cause the design to shift.

1. Polyester mesh cut-away stabilizer works extremely well with light-colored fabrics since it prevents a shadow from showing through on the front after you have trimmed away the excess. This type of backing is ideal whenever you need stability with a light and soft touch in your finished product, for example, with baby garments.
2. Cut-away stabilizer is excellent for medium- to heavyweight knits, however it can also be used on woven material. It will hold a large number of stitches and with two or three layers can hold a tremendous amount of stitches. This type of backing is also available in black for those who want the inside of their garments to look as good as the outside. Black stabilizer is very useful on similarly colored garments of lightweight fabrics. The black backing is less likely to show through as compared to white backing.

3. Tear-away stabilizer can be used on mediumweight woven fabrics and sturdy fabrics such as canvas, poplin and denim. This stabilizer will hold many stitches especially when used in two or more layers. This type of stabilizer is made of a non-woven material that enables it to easily be torn away from the edges of your embroidery design when it is completed. This stabilizer is also available in black.
4. Water-soluble stabilizer is useful when you need to keep the nap or pile, for example, on towels, from interfering with the placement of stitches. Fabrics such as terry cloth, corduroy, velvet and faux fur are examples of materials that have a nap or pile that can actually penetrate embroidery stitches as your machine sews. The result is an unfinished and often sloppy appearance when fibers of the fabric poke out between the finished stitches of an embroidery design. In these situations, water-soluble stabilizer is used as a topping to hold the fibers of the fabric flat so the stitches can be placed on top neatly and accurately. Water-soluble stabilizer is also used as a backing when stitching lace or other motifs where the desired result is only the stitching. This is accomplished with water-soluble stabilizer, which can easily be pulled off of the fabric after embroidering is completed and any remnants can easily be dissolved with water. Water-soluble stabilizer is also used as a backing on towels, where you often need some stabilization, but any remnants of a formal backing must not be visible in the finished product.
5. Self-adhesive (peel-and-stick) backing is used on those difficult-to-hoop fabrics. This backing is applied (with sticky side up) to the underside of the frame, enabling your fabric to “stick on” the exposed surface in the embroidery area. When the embroidery is finished, the fabric can be removed, the excess backing can be disposed of and the process repeated.

Hooping techniques

“Use the right tool for the right job” is a statement many of us have heard throughout the years. This statement holds true even in the embroidery industry. The wrong size or type of embroidery frame may result in poor design alignment during sewing or damage the product altogether. You can take a perfectly created design and ruin the final results by simply not using the correct frame size, type or technique designed for its application.

■ Frame Basics

Tubular frames: This type of frame allows tubular fabric or pre-assembled garments to be placed around the hook assembly. It allows embroidering of the front of a garment without stitching through the back of it.

Cap frame: These are specialized embroidery frames (hoops) designed to hold caps for embroidering.

Hooping fabric: The framed fabric and backing should be perfectly flat and free of wrinkles or bubbles. If there are bubbles or wrinkles that must be removed, be sure that you pull on the fabric and backing together. Pull no more than is necessary to make the fabric flat and smooth. Overstretching the fabric during this process may cause puckers around the finished design when the frame is removed. Gaps may also be generated between design parts.

Inner/outer frame positioning: There should be a slight ridge (3 mm (1/8 inch)) of fabric and backing below the outer frame on the back side. Tighten the screw only if the inner frame feels loose. Avoid overtightening the screw as this will cause puckers in the fabric and may “strip” the screw.

■ When embroidering thick fabric

If the fabric slips within the frame or cannot be correctly hooped, wrap masking tape or bias tape around the outer frame. The tape will provide resistance so that the fabric does not easily slip.

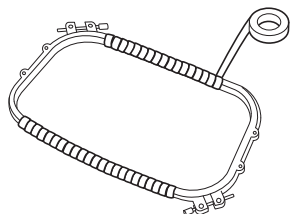

Fabric/stabilizer compatibility chart

Fabric/ Garment	No. of Backing Pieces	No. of Topping Pieces	Comments
Terry cloth	1 tear-away	1 water-soluble	Increase density and/or satin stitch width. Fine details and small lettering tend to get caught in the terry loops.
Satin jacket	Heavy lining: None Light or no lining: 1 tear-away	None	If garment slips in frame, causing alignment problems, wrap inner frame with masking tape or fabric bias tape. This provides a rough surface to grip garment and also helps minimize frame burn.
Cotton sheeting	1 tear-away	None	High-density or highly detailed designs may require more backing. If so, use two pieces of lightweight backing instead of one piece of heavy backing.
Denim	1 tear-away	None	Reduce speed if needle begins to heat up and the thread breaks.
Headwear	Optional	Optional	Change needles more often than usual because the buckram backing dulls needles faster. A lightweight tear-away backing helps reduce thread breaks and regulates thread tension. Use a topping on corduroy or foam cap fronts.
Dress shirt (woven)	1 tear-away	None	High-density or highly detailed designs may require more backing. If so, use two pieces of lightweight backing instead of one piece of heavy backing.
Golf shirt	1 cut-away	Optional	Use topping for designs containing small lettering or a lot of detail, and also for piqué knits.
Canton fleece	1 tear-away	Optional	Use a topping if the garment has a textured surface, such as a basketweave or pronounced twill.
Canvas	1 tear-away	None	Frame tightly.
Corduroy	1 tear-away	1 water-soluble	A higher stitch density or more understitches, as well as a topping, may be necessary to prevent stitches from sinking into the fabric.
Lingerie or silk	1 or 2 lightweight tear-away	Optional	Reduce sewing speed. The thread tension should be low. Use topping for designs with high detail or small lettering. For very fine fabrics, use a thinner thread. Avoid extremely narrow satin stitching on letters or details; instead increase satin stitch width or use a bean stitch. Gently remove (don't pull) backing and topping from garment.
Sweater knit	1 cut-away or adhesive tear- away	1 water-soluble	Use tightly woven organza or curtain fabric in a matching color as a backing for bulky or "holey" knits.
Sweatshirt	1 cut-away or adhesive tear- away	Optional	Highly detailed designs may require two layers of lightweight cut-away stabilizer. Use a topping on extra-thick fabrics or with fine-detail designs.
T-shirt	1 light-weight cut-away or adhesive tear- away	Optional	Use a topping on designs with fine detail or small lettering. Tensions should be light. Avoid stitch-heavy designs.



Note

- Due to the wide variety of fabrics and stabilizers available, the above information should be used as guideline only. If unsure of a particular fabric/stabilizer combination, please sew test a sample prior to the finished garment.

Using the Optional Bobbin Winder

When winding the bobbin thread onto a metal bobbin, use the optional bobbin winder. The procedures for using the optional bobbin winder are described below.

Precautions



For precautions concerning the power supply, refer to page 29.





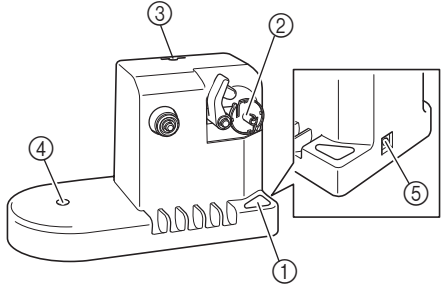

⚠ CAUTION

- Be sure to place the bobbin winder on a level, stable surface.
- Only use the bobbins supplied with this bobbin winder.

Optional bobbin winder and its accessories

Check that the following bobbin winder and accessories are included.

	Part Name	Part Code
1.	 <p>① Main power switch ② Bobbin winder shaft ③ Hole for thread guide ④ Hole for spool pin ⑤ DC input connector</p>	Bobbin winder PRBW1
2.		Spool pin XC5949-051
3.		Spool cushion XA0679-050

	Part Name	Part Code
4.		Thread guide XC6644-151
5.		AC adapter* —
6.		Power supply cord* —
7.		Metal bobbin × 5 100376-051
8.		Spool cap 130012-054
9.		Weight (L) XC5974-151
10.		Weight (S) XC6631-051

* Visit your authorized Brother dealer.



Memo

- The part code of the bobbin winder set may differ depending on the country/area where the machine was purchased.
- Depending on the model you purchased, the bobbin winder may be included with the machine.

Setting up the optional bobbin winder

Attach the spool pin, spool cushion and thread guide to the bobbin winder.

1 Insert the spool pin and the spool cushion.

Lower the holder, and then insert the spool pin straight into the hole. And insert the spool cushion.

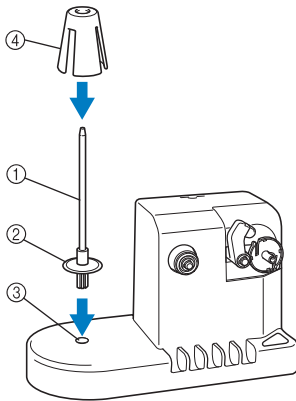

- ① Spool pin
- ② Spool pin holder
- ③ Hole for spool pin
- ④ Spool cushion

2 Insert the thread guide.

Insert the thread guide straight into the hole with the pins on the thread guide aligned with the notches on the sides of the hole.

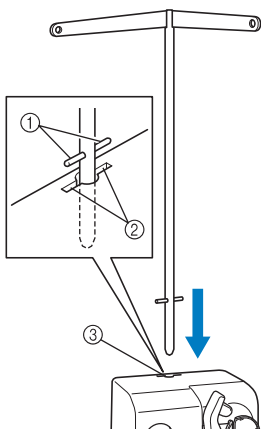

- ① Pins on thread guide
- ② Notches on hole for thread guide
- ③ Hole for thread guide
- Firmly insert the thread guide as far as possible and make sure that it is secure.

Connecting the AC adapter

1 Insert the plug of the power supply cord into the AC adapter.

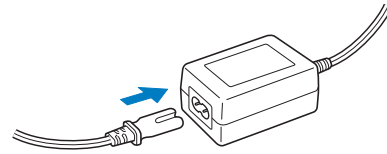

2 Plug the cord on the AC adapter into the DC input connector of the bobbin winder, and then insert the plug of the power supply cord into a household electrical outlet.

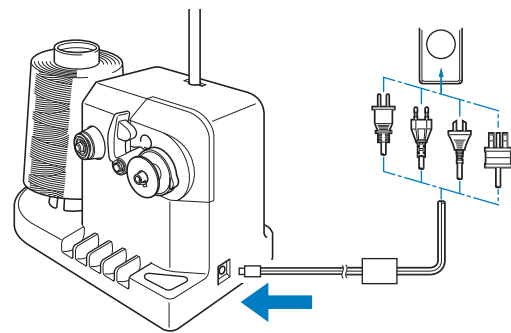

- Be sure to firmly insert the plug on the AC adapter into the DC input connector of the bobbin winder.

⚠ CAUTION

- Be sure to use the included power cord. Using any other power cord may result in damage.
- Be sure to use the included AC adapter. Using any other AC adapter may result in damage.
- Before connecting or disconnecting the AC adapter, be sure that the unit is not operating.
- After using the bobbin winder, disconnect it from the electrical outlet.

Winding the bobbin

Prepare the bobbin and the spool of bobbin thread. Use cotton or spun polyester bobbin thread (from 74 dtex/2 to 100 dtex/2).

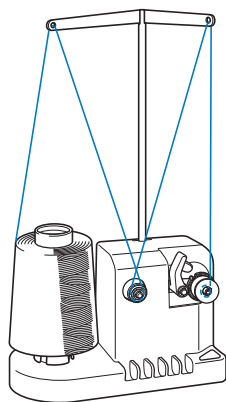

- 1 Align the groove in the bobbin with the spring on the bobbin winder shaft, and set the bobbin on the shaft.

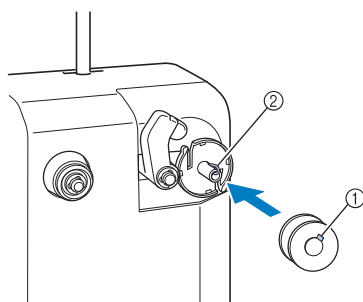

- 1 Groove in the bobbin
- 2 Spring on the shaft

- 2 Set the thread spool on the spool pin.

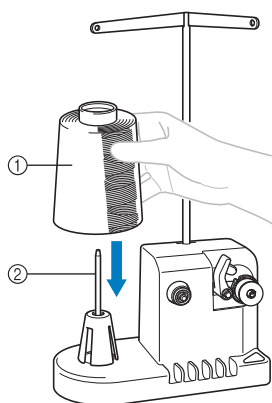

- 1 Thread spool
- 2 Spool pin



Note

- When using a small spool, remove the spool cushion and set the spool directly onto the spool pin. Also use the included spool cap to keep the small spool stable.

- 3 Pass the thread through the hole in the left of the thread guide toward the front of the winder.

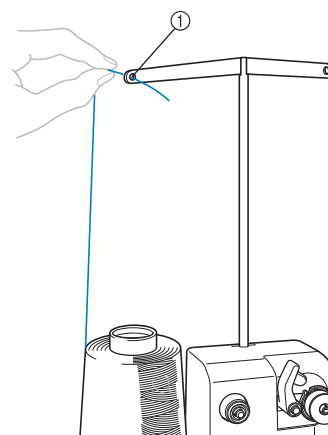

- 1 Hole in the thread guide

- 4 Pass the thread around the tension disc as shown in the illustration. Make sure that the thread is correctly fed into the tension disc.

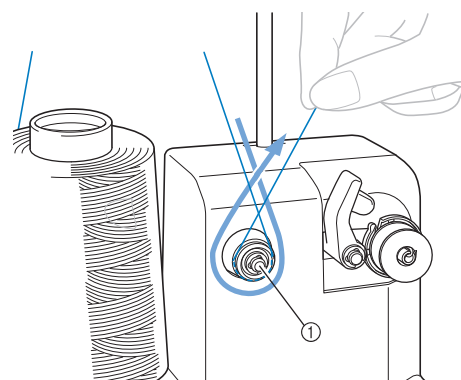

- 1 Tension disc

- 5** Pass the thread through the hole in the right of the thread guide toward the back of the machine.

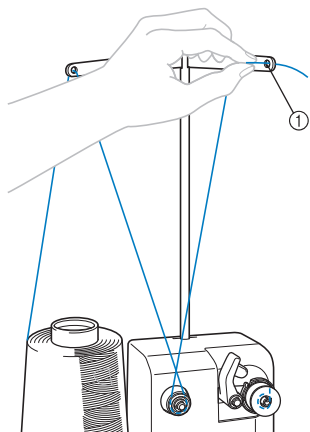

① Hole in the thread guide

- 6** Wind the thread clockwise around the bobbin 4 or 5 times, as shown in the illustration.

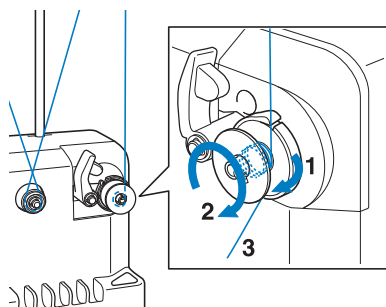

- 7** Pass the end of the thread through the guide slit in the bobbin winder seat, and pull the thread. The cutter will cut the thread.

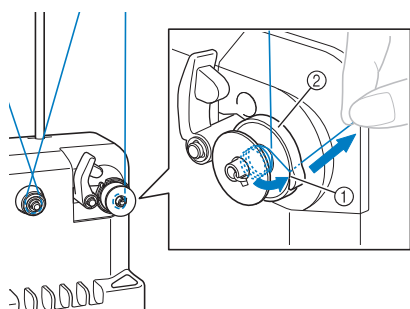

① Guide slit
② Bobbin winder seat



Note

- Be sure to follow the procedure described. If the bobbin is wound without the thread being cut with the cutter, when the bobbin thread runs low, the thread may become tangled around the bobbin and cause the needle to break.

- 8** Slide the bobbin holder, until it clicks into place.

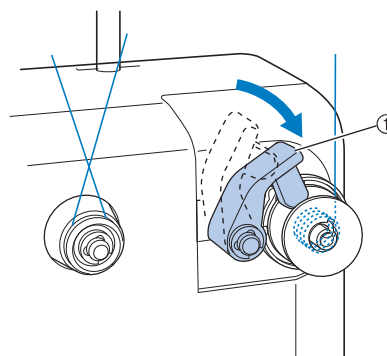

① Bobbin holder

- 9** Press the main power switch to start winding the bobbin.

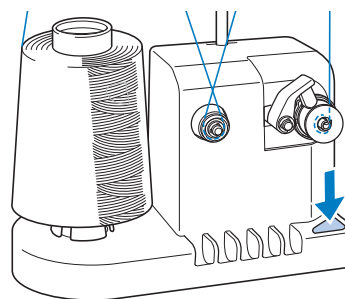

→ Start winding the bobbin.

- 10** The bobbin will stop rotating automatically when it is done winding, and the bobbin holder will return to its original position.

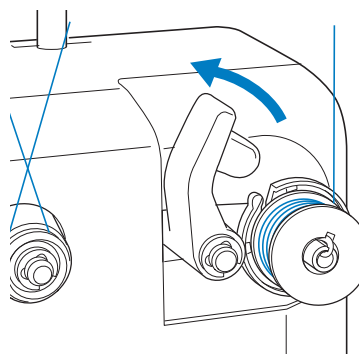

11 Remove the bobbin.

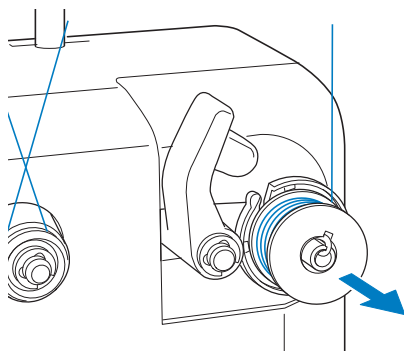

Note

- When removing the bobbin, do not pull on the bobbin winder seat. Doing so could loosen or remove the bobbin winder seat, resulting in damage to the bobbin winder.

12 Pull the thread through the guide slit in the bobbin winder seat to cut the thread with the cutter.

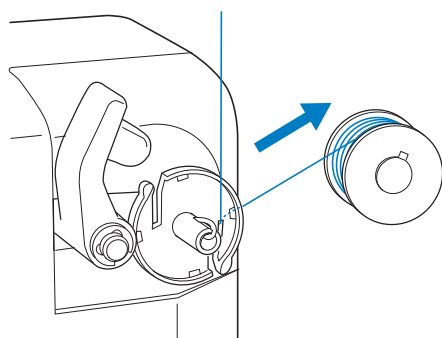

■ If bobbin winding is stopped before it is finished:

The bobbin winder stops automatically if the thread does not feed, for example, if it becomes tangled on the spool pin. If this occurs, correctly thread the bobbin winder, and then wind the bobbin correctly.

⚠ CAUTION

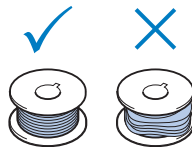
- Check that the bobbin thread has been wound correctly, otherwise the needle may break or the thread tension will be incorrect. 
- Be sure to clean the bobbin case each time that the bobbin is changed. Thread wax and dust easily collect around the hole in the tension-adjusting spring on the bobbin case, resulting in an incorrect thread tension. For details, refer to “Cleaning the bobbin case” on page 212.
- Be sure to check the tension of the bobbin thread each time that the bobbin is changed.
- Depending on the bobbin thread type, the tension of the bobbin thread may differ. Be sure to check the tension of the bobbin thread and adjust the tension if necessary. For a metal bobbin, use both weights, large (L) and small (S). For detailed instructions on how to adjust the bobbin tension, refer to page 102.

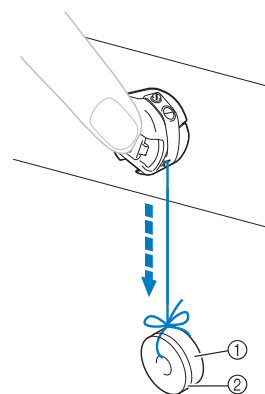

- ① Weight (L) (Part Code: XC5974-151)
- ② Weight (S) (Part Code: XC6631-051)

Maintenance

Simple embroidery machine maintenance operations are described below. Always keep the machine clean, otherwise malfunctions may occur.

Cleaning the LCD

If the surface of the LCD is dirty, lightly wipe it with a soft dry cloth. Do not use organic cleansers or detergents.

Cleaning the machine surface

If the surface of the machine is slightly dirty, wipe it with a soft dry cloth. If the machine is heavily dirty, lightly soak a cloth in neutral detergent, squeeze it out firmly, and then wipe the surface of the machine. After cleaning it once with a wet cloth, wipe it again with a dry cloth.

⚠ CAUTION

- Unplug the power supply cord before cleaning the machine, otherwise injuries or an electric shock may occur.



Note

- Do not use chemical products, such as benzene or thinner.

Cleaning the hook

Periodically remove lint and dust for better performance from Hook race area.

Use the included cleaning brush.

- 1 Turn off the embroidery machine.

⚠ CAUTION

- Unplug the power supply cord before cleaning the machine, otherwise injuries or an electric shock may occur.

- 2 Open the hook cover, and remove the bobbin case. (Refer to page 33.)

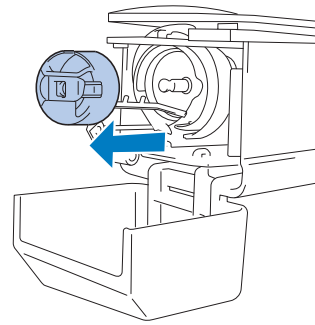

- 3 Use the included cleaning brush to remove any lint and dust from the hook and its surrounding area.

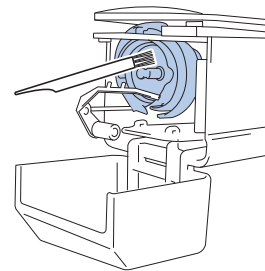

⚠ CAUTION

- If the hook is scratched or damaged, consult your authorized Brother dealer.

- 4 After cleaning is finished, insert the bobbin case into the hook, and then close the hook cover. (Refer to page 34.)

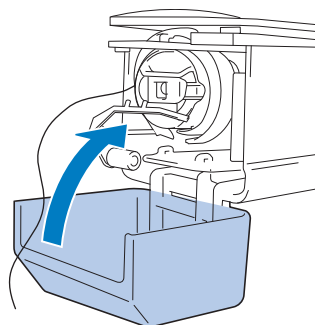

Cleaning around the needle plate

If lint and dust collect around the moving knife, the fixed knife or the thread retaining plate, the thread may not be cut correctly and the error message may appear, or various parts of the machine may be damaged. Make sure to clean around the needle plate once a month.

Use an offset screwdriver and the included cleaning brush.

1 Turn off the embroidery machine.

⚠ CAUTION

- Unplug the power supply cord before cleaning the machine, otherwise injuries or an electric shock may occur.

2 Remove the needle plate.

With an offset screwdriver, loosen the screws, and then remove the needle plate, and then open the hook cover.

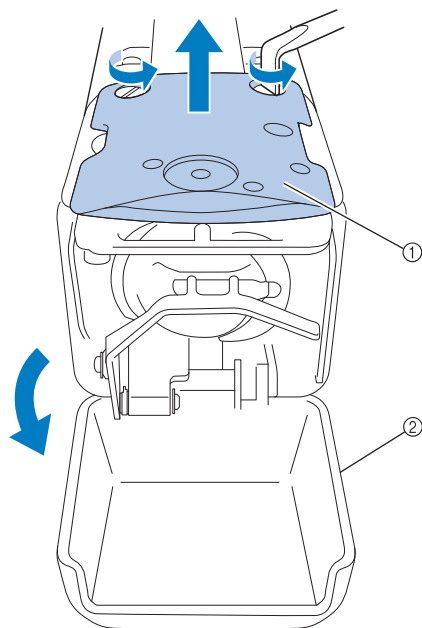

- ① Needle plate
- ② Hook cover

3 Remove the spacer.

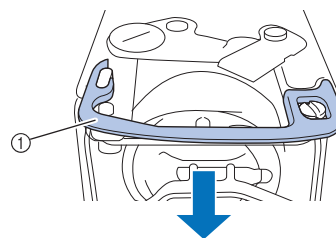

- ① Spacer

4 Use the included cleaning brush to remove any lint and dust from the moving knife, the fixed knife, the thread retaining plate, and their surrounding areas.

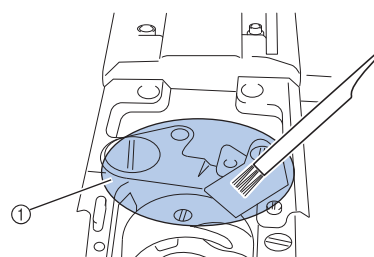

- ① Remove all lint in this area

5 After cleaning is finished, install the spacer back.

First, position the spacer so that it hooks around the elliptical notch, then position the spacer so that it surrounds the screw head. Slide the spacer in the direction of the arrow to secure it.

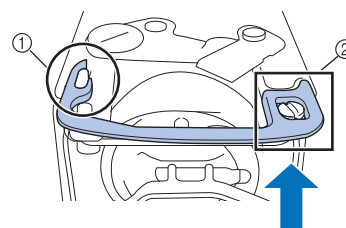

- ① Elliptical notch
- ② Screw head

- 6** Attach the needle plate in the opposite way that it was removed in step 2, and then close the hook cover.

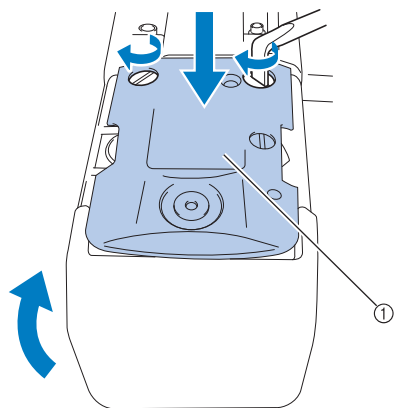

① Needle plate

Cleaning the bobbin case

Thread wax and dust easily collect around the hole in the tension-adjusting spring on the bobbin case, resulting in an incorrect thread tension. Therefore, it should be cleaned each time when the bobbin is changed.

Use a piece of paper with the thickness of a business card.

- 1** Open the hook cover, remove the bobbin case, and then remove the bobbin. (Refer to page 33.)

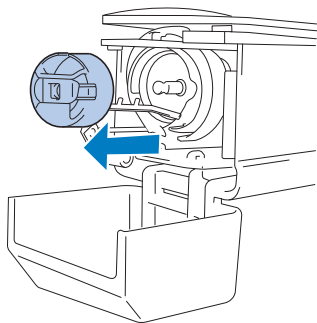

- 2** Slide the paper under the tension-adjusting spring to remove any dust.

Use a corner of the paper to remove any dust from around the hole.

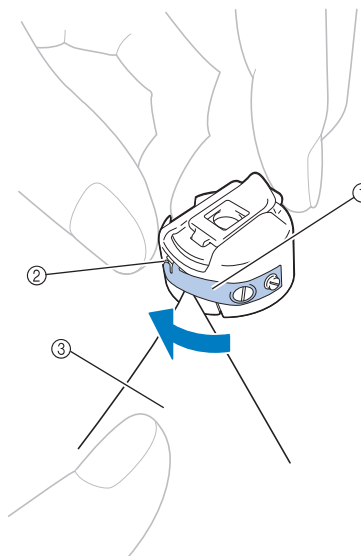

- ① Tension-adjusting spring
② Hole
③ Paper



Note

- Do not bend the tension-adjusting spring. In addition, do not use anything other than thick paper or paper of the specified thickness to clean the bobbin case.

- 3** Use the included cleaning brush to remove any lint and dust from inside the bobbin case.

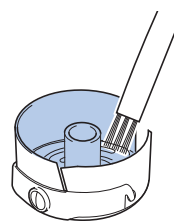

- 4** After cleaning is finished, insert the bobbin into the bobbin case and the bobbin case into the hook, and then close the hook cover. (Refer to page 33, 34.)

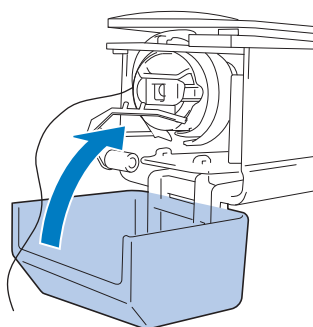

Cleaning the thread paths of the upper threads

If dust or lint has accumulated in the thread guides or tension unit in the paths of the upper threads, the thread may break while embroidery is being sewn. Periodically clean the thread paths.

■ Cleaning the thread guides

- 1** Use the included cleaning brush to remove any lint and dust from below the thread guide plates.

Clean the thread guide plates for both the upper thread guides and the middle thread guides.

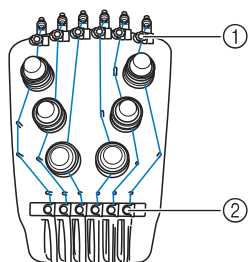

- ① Upper thread guide
② Middle thread guide

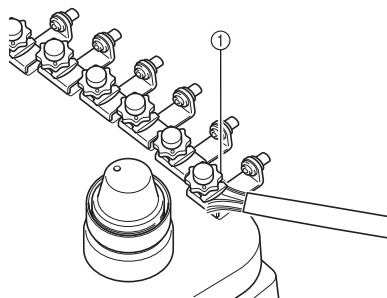

- ① Thread guide plate

■ Disassembling and cleaning the tension unit

- 1** To remove tension dial, turn dial counterclockwise as shown on illustration.

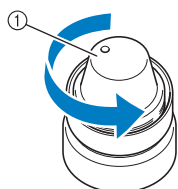

- ① Tension dial

- 2** Using the included cleaning brush, remove any lint and dust from the two pieces of felt washers (top, bottom) inside the tension dial.

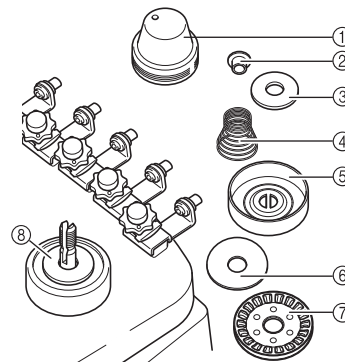

- ① Tension dial
② Nylon shoulder washer
③ Nylon washer only for tension number 4
④ Tension spring
⑤ Tension base spring
⑥ Felt washer (top)
⑦ Tension disc
⑧ Felt washer (bottom)

3 Reassembling the tension unit.



Note

- When reassembling the tension unit, be sure not to install the tension disc upside-down. There is a magnet on the bottom.

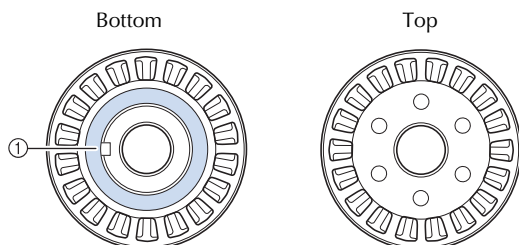

① Magnet

- When reassembling the tension unit, be careful not to lose any parts or install any parts in an incorrect order. The machine may not operate correctly if the tension units are incorrectly reassembled.
- When reassembling the tension unit, only tension number 4 has one more part than the other tension units.

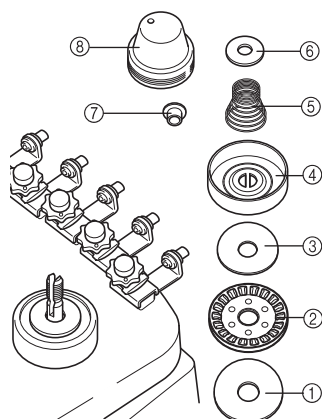

- ① Felt washer (bottom)
- ② Tension disc (magnet on the bottom)
- ③ Felt washer (top)
- ④ Tension base spring
- ⑤ Tension spring
- ⑥ Nylon washer (only for tension number 4)
- ⑦ Nylon shoulder washer
- ⑧ Tension dial

- When reassembling the tension unit, be careful not to lose any parts or install any parts in an incorrect order. The machine may not operate correctly if the tension units are incorrectly reassembled.

Oiling the machine

In order to extend the life of the embroidery machine's parts and keep the machine operating correctly, be sure to oil the machine before the first time that it is used. If too little oil was applied to the race, an error message may appear. Afterward, put a drop of oil onto the hook once a day before use, and put a drop of oil to the lower needle bar felt washer every 40 to 50 hours of machine use.

■ Oiling the race

1 Touch .

2 Touch .

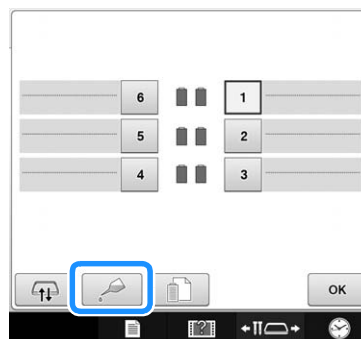

→ Following message appears.

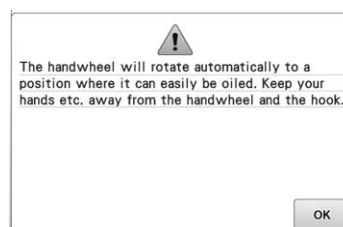

3 Open the hook cover, and remove the bobbin case. (Refer to page 33, 34.)

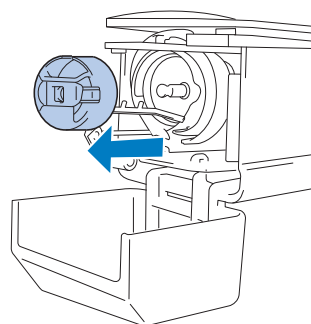

4 Touch .

→ The race moves to the correct position for oiling.

5 Put a drop of oil onto the hook.

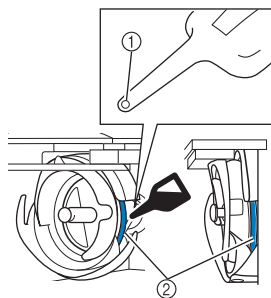

Front angle view

Side view

- ① Punch a small hole in oil bottle.
 - ② Apply oil here.
- Use a pointed object to punch a small hole in the tip of the included oiler before using it.

6 Touch appeared in the following screen.

→ The race backs to its original position.

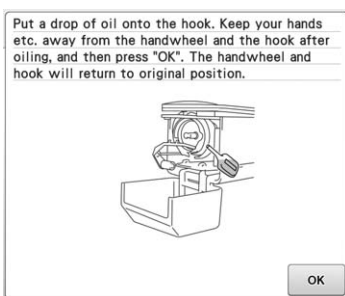

7 After oiling, insert the bobbin case into the hook, and then close the hook cover. (Refer to page 34.)

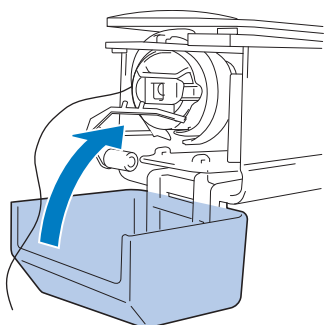

■ Oiling the needle bars

From embroidering screen, select one needle bar at a time. (Refer to page 56 for needle bar screen). Turn the handwheel counterclockwise bringing the needle bar to its lowest position. Put one drop of oil, as high as possible on the needle bar above the felt washer.

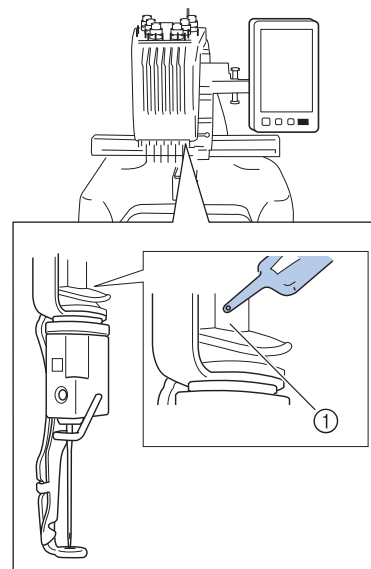

- ① Apply oil here.
- Too much oil may drip onto sewing project.



Note

- Put a drop of oil onto the hook once a day before use.
- Apply one drop of oil on the lower needle bar above the felt washer every 40 – 50 hours of sewing time.
- Apply only sewing machine oil. Use of any other type of oil may result in damage to the embroidery machine.
- Do not apply too much oil. Fabric or thread may get contaminated. If too much oil is applied, wipe off any excess with a rag.
- If the thread breaks while sewing or the operating noise of the hook becomes loud, apply oil onto the race hook.

About the maintenance message



Once this message appears, it is recommended to take your machine to your nearest authorized Brother dealer for a regular maintenance check. Although this message will disappear and the machine will continue to function once you touch **OK**, the message will display several more times until the appropriate maintenance is performed.

Please take the time to arrange for the maintenance that your machine requires once this message appears. Such steps will help to ensure you receive continued, uninterrupted hours of machine operation for the future.

Troubleshooting

On-screen troubleshooting

This embroidery machine is equipped with an easy-to-use troubleshooting feature for problems during sewing. Touch the key that shows the problem, and then check for the causes that are displayed.

1 Touch .

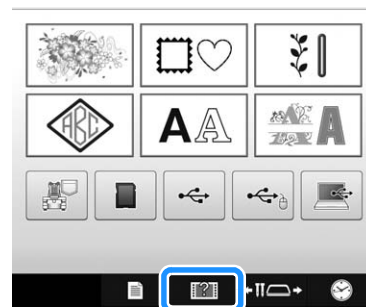

2 Touch **Operation Guide**, and then touch **Troubleshooting**.

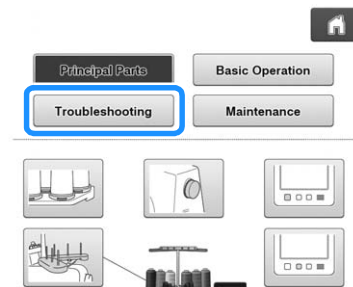

3 Touch the key that contains a description of the problem.



4 Check the items that are displayed. After checking the desired information, touch



5 Touch **Return**.



→ The Operation Guide and the Video screen appear.

Troubleshooting

If the machine does not operate correctly, check for the following points/issues before requesting service.

If the suggested remedy does not correct the problem, contact your authorized Brother dealer.

If the reference page is “*”, consult your nearest authorized Brother dealer.

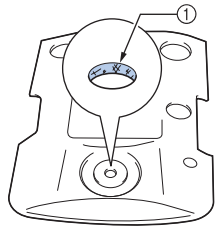
Symptom		Page
The embroidery machine does not operate.		
The machine is not turned on.	<ul style="list-style-type: none"> • Turn on the embroidery machine. 	p.35
The machine has not been unlocked.	<ul style="list-style-type: none"> • Touch the unlock key. 	p.57
The start/stop button was not pressed.	<ul style="list-style-type: none"> • With the machine unlocked, press the start/stop button. 	p.57
The embroidery frame cannot be attached to the machine.		
The embroidery frame holder attached to the machine is not appropriate for the selected embroidery frame.	<ul style="list-style-type: none"> • Select the appropriate embroidery frame holder for the embroidery frame. 	p.80
The embroidery frame cannot be removed or attached.		
Depending on the position where the machine’s carriage has stopped, it may be difficult to remove or attach the embroidery frame.	<ul style="list-style-type: none"> • Touch the “Needle bar/Frame move key” to position the carriage, so the embroidery frame can easily be removed or attached. 	p.81
The needle breaks.		
The needle is not installed correctly.	<ul style="list-style-type: none"> • Correctly install the needle. 	p.79
The needle set screw is loose.	<ul style="list-style-type: none"> • Use the Allen screw driver to securely tighten the needle set screw. 	p.79
The needle is bent or blunt.	<ul style="list-style-type: none"> • Replace the needle with a new one. 	p.30 p.79
The area around the hole in the needle plate is damaged.	 <p>① Scratches/Burrs</p> <ul style="list-style-type: none"> • Replace the needle plate. 	*

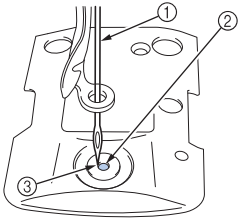
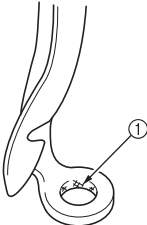
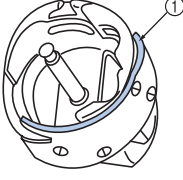

Symptom		Page
Probable Cause/Remedy		Page
The needle breaks.		
The needle hits/touches the needle plate.	 <p>① Needle ② Hole in needle plate ③ Needle hits hole</p> <ul style="list-style-type: none"> • Replace the needle. 	p.79 *
The presser foot is set too high and not correctly positioned. The needle hits/touches the presser foot.		*
The area around the embroidery foot hole is damaged.	 <p>① Scratches or Burrs</p> <ul style="list-style-type: none"> • Replace the presser foot. 	*
Sliding surface on hook race is not smooth. There are scratches or burrs on it.	 <p>① Hook race area</p>	*
The bobbin or bobbin case are not correctly installed.	<ul style="list-style-type: none"> • Remove and reinstall bobbin and bobbin case. 	p.33 p.34
The hook is not correctly installed.		*
The hook stopper is not correctly installed, the hook is making a complete rotation.		*

Symptom		Page
Probable Cause/Remedy		Page
The needle breaks.		
The upper thread is not threaded correctly. The upper thread is catching somewhere.	<ul style="list-style-type: none"> • Pull the upper thread by hand from below the presser foot, and check that the thread moves smoothly. If the thread does not move, it is not threaded correctly. Thread the upper thread correctly. Make sure the thread is caught by the needle bar thread guide. 	p.50
The upper thread tension is set too high. It does not run.	<ul style="list-style-type: none"> • Decrease the upper thread tension and make sure tension disc rotates when pulling on thread. 	p.103
A bobbin designed specifically for this machine is not used.	<ul style="list-style-type: none"> • Use the correct bobbin. 	p.30
The needle and the hook are not correctly passing each other.	<ul style="list-style-type: none"> • Hook timing may be OFF. 	*
There is backlash play (forward/backward) in the needle bar case.		*
The thread density of the embroidery data is too fine. Three or more overlapping stitches are being sewn.	<ul style="list-style-type: none"> • Using a data design system, correct the thread density and over stitching settings in the embroidery data. 	p.123
The thread is not cut automatically.		
Lint or dust has accumulated around the needle plate (moving knife, fixed knife or thread retaining plate).	<ul style="list-style-type: none"> • Remove any lint or dust around the needle plate. 	p.211
A bobbin case designed specifically for this machine is not used.	<ul style="list-style-type: none"> • Use the correct bobbin case. 	-
Lint or dust has accumulated in the thread tension disc.	<ul style="list-style-type: none"> • Remove the tension dials, and then remove any lint or dust accumulated between the felt washers. 	p.213
After the threads are automatically cut, the upper thread is too short and comes out of the needle.		
Lint or dust has accumulated around the needle plate (moving knife, fixed knife or thread retaining plate).	<ul style="list-style-type: none"> • Remove any lint or dust around the needle plate. 	p.211

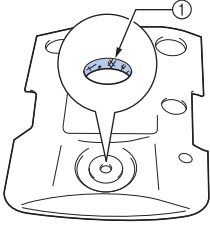
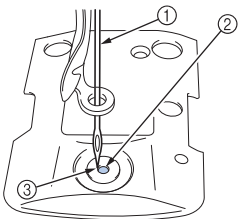
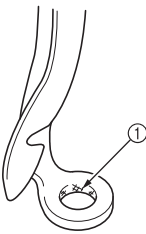
Symptom		Page
Probable Cause/Remedy		Page
The upper thread breaks.		
The needle is not correctly installed. • Correctly install the needle.		p.79
The needle set screw is loose. • Use the Allen screw driver to tighten the needle set screw.		p.79
The needle is bent or blunt. • Replace the needle with a new one.		p.30 p.79
The area around the hole in the needle plate is damaged. 		*
① Scratches/Burrs • Replace the needle plate.		
The needle is touching the needle plate. 		*
① Needle ② Needle plate hole ③ Needle touching hole		
The presser foot is set too high and not correctly positioned. The needle hits/touches the presser foot.		*
The area around the embroidery foot hole is damaged. 		*
① Scratches/Burrs • Replace the presser foot.		
Using a specialty thread like a metallic thread. • Slow down the machine sewing speed.		p.116

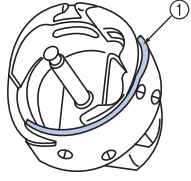
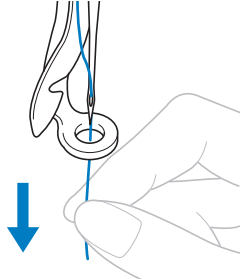
Symptom		Page
Probable Cause/Remedy		Page
The upper thread breaks.		
Sliding surface on hook is not smooth. There are burrs on it. 		*
① Hook race area		
The thread is loose in the hook area. • Remove the loose thread. If the thread is tangled in the hook, clean the hook.		p.210
The play between the hook and the race is too much.		*
The hook does not rotate smoothly. • Remove lint, clean and apply oil.		p.210 p.214
The space between the hook stopper and the hook cannot be adjusted.		*
The upper thread is not threaded correctly. 		p.50
• Pull the upper thread by hand from below the presser foot, and check that the thread moves smoothly. If the thread does not move smoothly, it is not correctly threaded. Un-thread the machine and re-thread the machine. Make sure the thread is correctly positioned in the needle bar thread guide.		
Upper thread is not positioned in upper or middle thread guide. • Make sure thread passes completely under upper and middle thread guide.		p.50
There are knots or tangles in the thread. • Remove any knots or tangles.		-
The upper thread tension is too high. • Decrease the upper thread tension.		p.103
The lower thread tension is incorrect. The thread does not roll out of the bobbin case smoothly. • Adjust the lower thread tension.		p.102
The bobbin case is damaged. • Replace the bobbin case with a new one.		p.30



Symptom		
	Probable Cause/Remedy	Page
The upper thread breaks.		
The bobbin thread is not wound correctly.	<ul style="list-style-type: none"> Check that the bobbin is wound so that it is about 80% full and that the thread is evenly wound. If the bobbin is not correctly wound, replace the bobbin with one that is correctly wound or rewind the bobbin. 	p.30
A bobbin designed specifically for this machine is not used.	<ul style="list-style-type: none"> Use the correct bobbin. 	p.30
The automatic needle-threading mechanism is broken.		*
Adhesive is attached to the needle.	<ul style="list-style-type: none"> Replace the needle. 	p.79
The fabric is not taut.	<ul style="list-style-type: none"> Firmly set the fabric in the embroidery frame so that it is taut. 	p.42 p.85
The thread quality is poor.	<ul style="list-style-type: none"> The thread quality is too weak due to age of thread. Replace thread. 	–
The embroidery data contains stitches with a pitch of zero.	<ul style="list-style-type: none"> Delete all stitches with a zero pitch. 	p.184
The embroidery data contains many stitches with an extremely small pitch.	<ul style="list-style-type: none"> Delete all stitches with a small pitch. 	p.184
The thread density of the embroidery data is too fine.	<p>Three or more overlapping stitches are being sewn.</p> <ul style="list-style-type: none"> Using a data design system, correct the thread density and over stitching settings in the embroidery data. 	p.123
Lint or dust has accumulated in the thread tension disc.	<ul style="list-style-type: none"> Remove the tension dials, and then remove any lint or dust accumulated between the felt washers. 	p.213
The bobbin thread breaks.		
The bobbin thread is not correctly threaded.	<ul style="list-style-type: none"> Correctly thread the bobbin thread. 	p.33
The bobbin is scratched or does not rotate smoothly.	<ul style="list-style-type: none"> Replace the bobbin. 	p.33
The bobbin case is damaged.	<ul style="list-style-type: none"> Replace the bobbin case. 	p.33
The thread is tangled.	<ul style="list-style-type: none"> Remove the thread jammed and clean the hook. 	p.210
A bobbin designed specifically for this machine is not used.	<ul style="list-style-type: none"> Use the correct bobbin. 	p.30
Lint or dust has accumulated in the thread tension disc.	<ul style="list-style-type: none"> Remove the tension dials, and then remove any lint or dust accumulated between the felt washers. 	p.213

Symptom		
	Probable Cause/Remedy	Page
Stitches are skipped.		
The upper thread is not threaded correctly.	<ul style="list-style-type: none"> Thread the upper thread correctly. 	p.50
The needle is bent or blunt.	<ul style="list-style-type: none"> Replace the needle with a new one. 	p.30 p.79
The needle is not installed correctly.	<ul style="list-style-type: none"> Correctly install the needle. 	p.79
Dust has accumulated under the needle plate or in the hook.	<ul style="list-style-type: none"> Clean the hook and the needle plate. 	p.210 p.211
The needle and the hook are not correctly passing each other.		*
The thread twist is either too tight or too loose.	<ul style="list-style-type: none"> Improper twisting results in irregular loop formation. Try using a new spool. 	–
The embroidery pattern is misaligned.		
The thread is tangled.	<ul style="list-style-type: none"> Use tweezers to remove any tangled thread from the hook. 	–
The fabric is not secured in the embroidery frame (for example, the fabric is not taut).	<ul style="list-style-type: none"> If the fabric is not taut, the pattern may become misaligned or the stitching may shrink. Be sure to correctly frame the fabric in the embroidery frame. 	p.42 p.85
The embroidery frame is too large for the size of the embroidery.	<ul style="list-style-type: none"> Use an embroidery frame that is close to the size of the embroidery. 	p.80
The thumbscrews on the embroidery frame holder are loose.	<ul style="list-style-type: none"> Use the included disc-shaped screwdriver to firmly tighten the thumbscrews. 	p.28
Stabilizer (backing) is not used.	<ul style="list-style-type: none"> Use stabilizer (backing) when embroidering on thin or stretch fabrics, fabrics with a coarse weave or fabrics that easily allow the stitching to shrink. <p><When using the optional cap frame> Use hard stabilizer when embroidering on a cap made of soft material.</p>	p.84
The embroidery frame is not correctly attached to the carriage.	<ul style="list-style-type: none"> Correctly attach the embroidery frame to the carriage. Make sure that the pins on the left and right arms of the embroidery frame holder securely fit into the holes in the handles on the embroidery frame. 	p.45
The carriage or the embroidery frame is hitting objects.	<ul style="list-style-type: none"> The pattern may become misaligned if the carriage or embroidery frame is hitting objects. Make sure that there are no objects within the operating field of the embroidery frame. 	–
The fabric is caught or pinched.	<ul style="list-style-type: none"> Stop the machine, and then correctly position the fabric. 	–

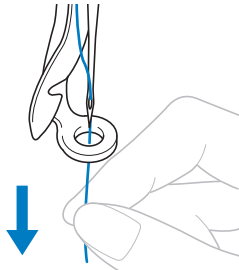
Symptom		
Probable Cause/Remedy	Page	
The embroidery pattern is misaligned.		
<p>The carriage moved while removing embroidery frame.</p> <ul style="list-style-type: none"> The pattern may become misaligned if the presser foot was hit or the carriage was moved while replacing bobbin thread, changing needle, or working near embroidery frame. <p>Be careful when removing and reattaching the embroidery frame while replacing bobbin thread, changing needle, or working near embroidery frame.</p> <p>If the carriage is moved, turn the machine off, then on again. The correct frame position at the time that the machine was stopped is stored in the machine's memory, and the embroidery frame is returned to the correct position.</p>	-	
<p>The design was not digitized correctly.</p> <ul style="list-style-type: none"> The design may need more pull compensation or underlay to accommodate stretchy or high-napped fabrics. 	-	
The size of the installed embroidery frame is not correctly detected.		
<p>The thumbscrews on the embroidery frame holder are loose.</p> <ul style="list-style-type: none"> Use the included disc-shaped screwdriver to firmly tighten the thumbscrews. 	p.28	
The starting position for the embroidery frame is horizontally misaligned.		
<p>The thumbscrews on the embroidery frame holder are loose.</p> <ul style="list-style-type: none"> Use the included disc-shaped screwdriver to firmly tighten the thumbscrews. 	p.28	
There are loops in the upper thread.		
<p>The upper thread tension is low.</p>  <ul style="list-style-type: none"> After passing the upper thread through the hole in the presser foot, pull the thread by hand to check the thread tension. If it is difficult to determine, compare it with other needle bars where looping does not occur. 	-	

Symptom		
Probable Cause/Remedy	Page	
There are loops in the upper thread.		
<p>The thread tension does not correspond to the amount that the thread tension knob was tightened.</p> <ul style="list-style-type: none"> If the thread tension cannot be adjusted, thread wax and dust may have collected in the upper or middle thread guide plates, causing the thread tension guide plates to rise. Clean the thread tension guide plates. 	p.213	
<p>Thread is not correctly threaded around upper thread tension discs.</p> <ul style="list-style-type: none"> Clean upper thread tension disc. Rethread and make sure tension disc rotates when pulling on thread. 	p.213	
<p>The thread quality is poor.</p> <ul style="list-style-type: none"> Try sewing with different thread. If the problem no longer occurs after the thread is changed, the thread quality is the problem. Replace the thread with one of good quality. 	-	
The machine is noisy.		
<p>Lint may be wound in the hook.</p> <ul style="list-style-type: none"> Clean the hook. 	p.210	
<p>The upper thread is not threaded correctly.</p> <ul style="list-style-type: none"> Check the thread path, and then thread the upper thread again. 	p.50	
<p>The hook is damaged.</p> <ul style="list-style-type: none"> Replace the hook. 	*	
<p>Not enough oil was applied.</p> <ul style="list-style-type: none"> Oil recommended parts. 	p.214	
The needle threader cannot be used.		
<p>The needle is not at the correct position.</p> <ul style="list-style-type: none"> Touch the key to move the desired needle bar to be threaded into embroidering position. 	p.56	
<p>Recommended needles are not used on this machine.</p> <ul style="list-style-type: none"> Replace and use recommended needle. 	p.30 p.79	
<p>The needle is not installed correctly.</p> <ul style="list-style-type: none"> Correctly install the needle. 	p.30 p.79	
<p>The hook on the automatic needle-threading mechanism is bent.</p>	*	
The thread tension is incorrect.		
<p>The upper thread is not threaded correctly.</p> <ul style="list-style-type: none"> Check the thread path, and then thread the upper thread again. 	p.50	
<p>The bobbin thread is not correctly threaded.</p> <ul style="list-style-type: none"> Correctly thread the bobbin thread. 	p.33	
<p>The lower thread tension is incorrect.</p> <ul style="list-style-type: none"> Adjust the tension of the bobbin thread. 	p.102	
<p>Lint or dust has accumulated in the thread tension disc.</p> <ul style="list-style-type: none"> Remove the tension dials, and then remove any lint or dust accumulated between the felt washers. 	p.213	

Symptom		
Probable Cause/Remedy		Page
The upper thread comes out of the needle when embroidering begins.		
If a short length of thread remains after the thread is trimmed, the needle may become unthreaded when embroidering begins again. <ul style="list-style-type: none"> Set the remaining length of thread to "Long Tail" on the second page of the settings screen. 	p.185	
The upper thread does not reach the bobbin thread when embroidering begins.		
There is no more thread in the bobbin, the thread does not feed from the bobbin, or the thread that is fed from the bobbin is too short. <ul style="list-style-type: none"> Correctly thread the lower thread. 	p.33	
Although the thread is not broken, a broken thread error occurs and the machine stops.		
If the thread breakage sensor in the thread tension disc of the thread tension knobs cannot detect that the thread is being fed, even if the machine is running, a broken thread error occurs and the machine is stopped. If the thread came out of the thread tension disc, even though the thread is not broken, the machine detects that the thread is not being fed and stops. <ul style="list-style-type: none"> Clean the tension unit. Correctly pass the thread through the thread tension disc. If the broken thread error occurs after the machine is cleaned and rethreaded, the sensor may be damaged. Consult your nearest authorized Brother dealer. 	p.52 p.213	
The thread is worn.		
Lint or dust has accumulated in the thread tension disc. <ul style="list-style-type: none"> Remove the tension dials, and then remove any lint or dust accumulated between the felt washers. 	p.213	
Jumpstitches are long.		
Lint or dust has accumulated in the thread tension disc. <ul style="list-style-type: none"> Remove the tension dials, and then remove any lint or dust accumulated between the felt washers. 	p.213	
There are needle cuts or holes in the garment.		
The needle is dull. <ul style="list-style-type: none"> Replace the needle. Dull needles have a difficult time passing through the garment, causing fabrics to tear. 	p.30 p.79	
The fabric is too delicate. <ul style="list-style-type: none"> The simple penetration of the needle could damage delicate fabrics. Use stabilizer on top of fabric. 	p.204	



Symptom		
Probable Cause/Remedy		Page
There is puckering in the fabric.		
The thread tension is too tight. <ul style="list-style-type: none"> Adjust the tension according to the type of fabric and thread being used. Polyester thread will stretch during sewing especially if the tensions are set too high. After the stitching is complete, the thread returns to its original strength, causing puckers in the fabric. 	p.103	
The framing tension of the fabric is incorrect. <ul style="list-style-type: none"> Tightly frame non-stretchable, woven fabrics. Loose framing will cause the fabric to bunch up under the stitching. Tautly frame soft knits using a stable backing. Overstretching the garment will cause it to look puckered when the frame is removed. 	p.203	
The column stitches are too long. <ul style="list-style-type: none"> Re-digitize the design with fill stitching or with multiple rows of column stitching. 	–	
There is puckering in the fabric.		
The needle is dull. <ul style="list-style-type: none"> Dull needles push fabric down and damage material. Replace the needle. 	p.30 p.79	
The design density is too heavy. <ul style="list-style-type: none"> Too many stitches in an area pull fabric, causing it to pucker. Slightly decrease the design density by 5% to 10%. 	p.184	
The LCD cannot be read.		
The LDC screen is too bright or too dark. <ul style="list-style-type: none"> Adjust the brightness of the screen display. 	p.179	
When embroidering thick fabric, the fabric cannot be correctly hooped.		
Fabric slips within the frame because of its thickness. <ul style="list-style-type: none"> Wrap masking tape or bias tape around the outer frame. The tape will provide resistance so that the fabric does not easily slip. 	p.203	

CAUTION

- This machine is equipped with a thread detecting mechanism. If the machine is not threaded with the upper thread, the machine will not operate correctly, even if the start/stop button is pressed after unlocking the machine.**
- If the machine suddenly stops:**
 - Turn off the machine, and unplug the power cord.**
 - Restart the machine with the correct operating procedure. Refer to page 35.**

Error messages

If the start/stop button is pressed while the machine is not correctly set up or if an incorrect operation is performed, the machine stops and informs you of the error with a buzzer and an error message. If an error message appears, correct the problem according to the instructions in the message.

To close the message, touch  or perform the correct operation, then touch . If the message appears again, consult your nearest authorized Brother dealer.

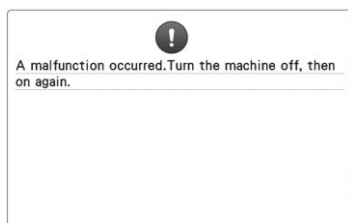

Some malfunction occurred.

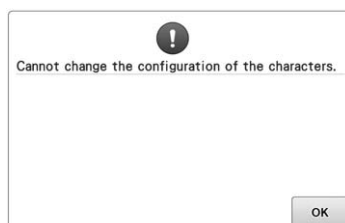

There are too many characters in the curved text arrangement for the selected embroidery frame.

Change the text arrangement or the embroidery frame.

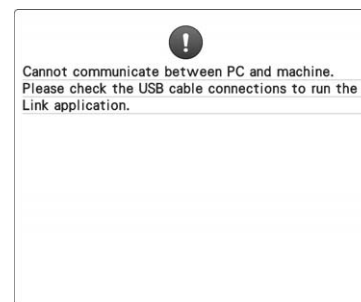

Machine cannot receive any data from the PC in the Link mode.

Turn off the machine, and check the USB connection. After connect the USB cord securely, turn on the machine again. (Refer to page 142)

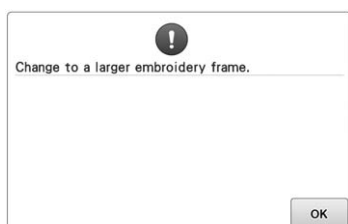

The installed embroidery frame is too small.

Check which embroidery frames can be used, and then install a larger embroidery frame. (Refer to page 42.)



The upper thread broke, the thread came out of the thread tension disc or a thread guide, or the machine is not threaded correctly.

Check that the thread passes under the upper and middle thread guides, and correctly thread the upper thread. (Refer to page 50.) If the thread is not broken, clean the thread guides and the tension unit. (Refer to page 213.)

The bobbin thread broke or ran out.

Check that there is thread on the bobbin and that approximately 50 mm (2 inches) of thread has been pulled out, and then re-install the bobbin. (Refer to page 33.)

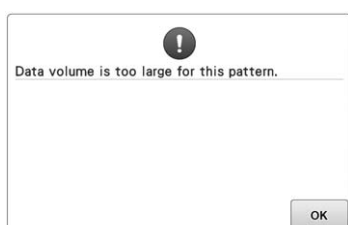

The patterns you are editing take up too much memory, or you are editing too many patterns for the memory.

Lint or dust has accumulated in the thread tension disc.

Remove the tension dials, and then remove any lint or dust accumulated between the felt washers. (Refer to page 213.)

The thread tension is too tight.

Check the tensions of the upper thread and bobbin thread, and then adjust them. (Refer to page 102.)

* Since there may be many other causes, refer to the Troubleshooting table.
The upper thread breaks. (Refer to page 219.)
The bobbin thread breaks. (Refer to page 220.)

* Touch  to move the needle back or forward. (Refer to page 97.)

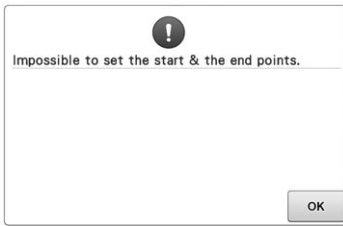

Sewing cannot begin from the specified starting position.

Change the starting position or rehoop the fabric and change the embroidering position. (Refer to 85, 113.)

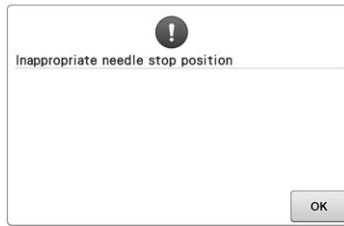

The needle has stopped at an incorrect position.

Turn the handwheel so that the mark on the handwheel is at the top.



The needle bar case could not be moved to its initial position.

Touch to automatically reset the needle bar case.

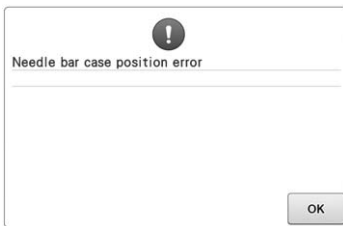

The needle bar case has stopped at an incorrect position.

Touch to automatically reset the needle bar case.

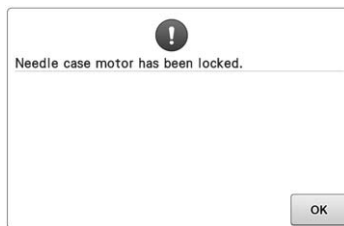

The needle bar case motor has locked up.

Touch to automatically reset the needle bar case.

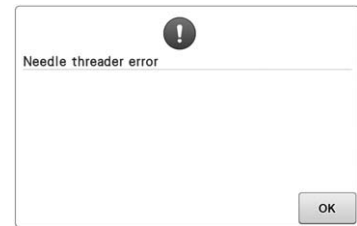

The automatic needle-threading mechanism did not operate correctly.

Remove the thread entangled in the automatic needle-threading mechanism, and then touch .

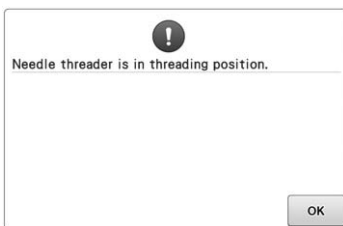

Another operation was performed while the automatic needle-threading mechanism was threading the needle.

Press the automatic needle threading button, and then perform the other operation after the needle is threaded. (Refer to page 54.)

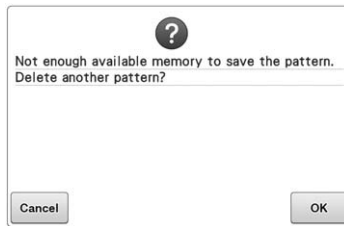

The pattern could not be saved because the memory is full.

Delete some patterns.

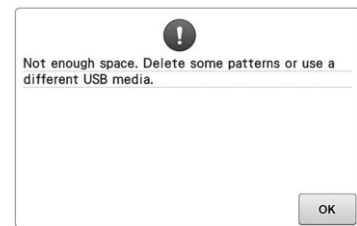

The memory capacity of the USB media has been exceeded.

There is too much data in either the machine or the USB media.

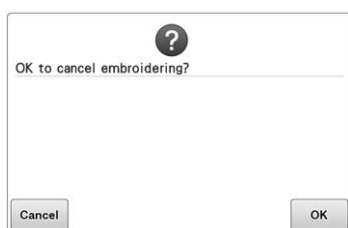

Return was touched in the embroidering settings screen.

Touch **OK** to return to the embroidering settings screen. The previous embroidery in the embroidering screen will be canceled.

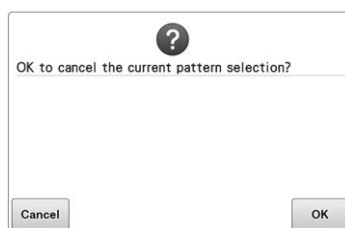

The selected pattern is going to be deleted because **Return** was touched.

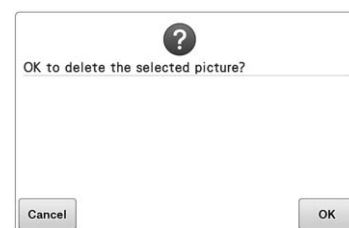

The image is going to be deleted.

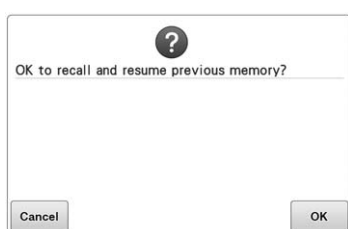

The machine was turned off while sewing, then turned on again.

Touch **OK** to return the machine to the condition (pattern position and number of stitches) when it was turned off. Follow the procedure described in "Resume Embroidering After Turning Off the Machine" on page 101 to align the needle position and sew the remainder of the pattern.



Reset was touched while thread colors were being changed.



A saved combined pattern is being rotated in the embroidering settings screen.

Color sorting for the combined border pattern will be canceled when **OK** is touched. In addition, the thread marks will be removed even if they have been set.

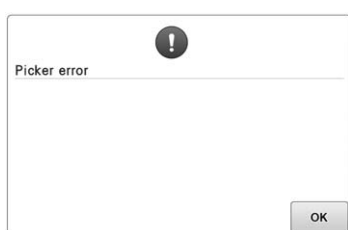

The thread picker did not operate correctly.

Remove the thread entangled on the thread picker.

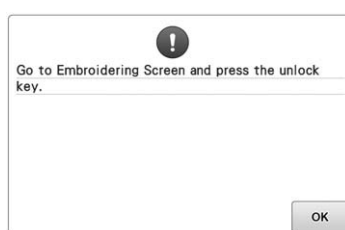

The thread trimming button was pressed while a screen other than the embroidering screen or embroidering settings screen was displayed.

Display either the embroidering screen or embroidering settings screen before using the thread trimming function.

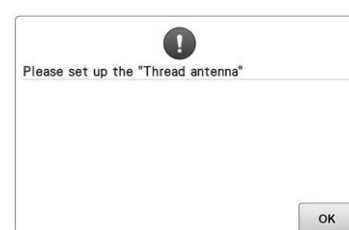

Thread guide assembly support is not prepared.

Prepare the thread guide assembly. (Refer to page 26.)

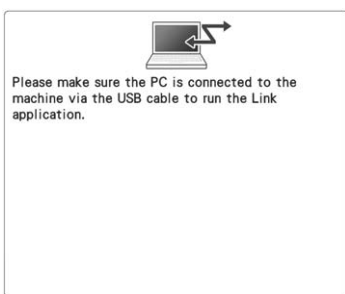

Machine failed to communicate with the PC in the Link mode.

Turn off the machine, and on again.

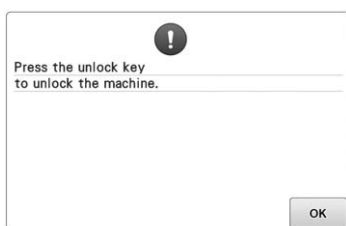

The thread trimming button was pressed before the machine was unlocked.

Touch  to use the thread trimming function.



The machine needs maintenance. (Refer to page 216.)



The machine is retrieving a previously saved pattern.



The machine was stopped while the needle bar case was moving.

Touch  to automatically reset the needle bar case.

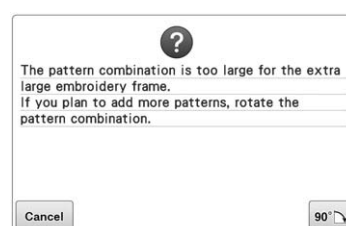

The combined character pattern is too large for the embroidery frame.

Rotate the pattern 90 degrees and then continue combining characters.

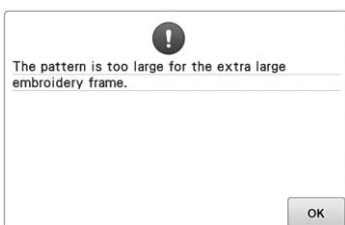

The combined character pattern is too large to fit in the extra-large embroidery frame.

Change the character pattern combination.

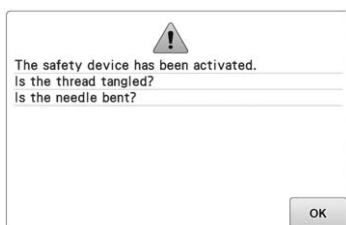

The motor has locked up due to tangled thread or for other reasons related to thread delivery.

If the thread is entangled in the bobbin case, clean the race, and then oil it. (Refer to page 212 and 216.)



The USB media is write-protected.

Cancel the write protection.

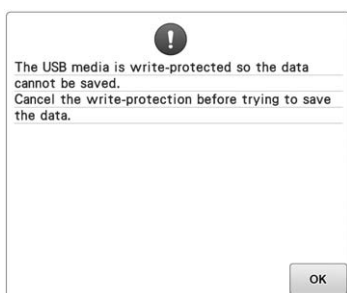

The USB media is write-protected.
Touch **OK**, and cancel the write protection.

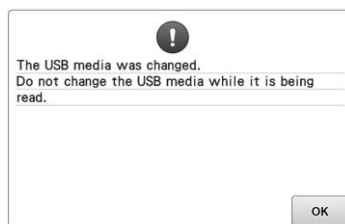

You tried to select a pattern after the USB media in which the pattern is saved has been changed.

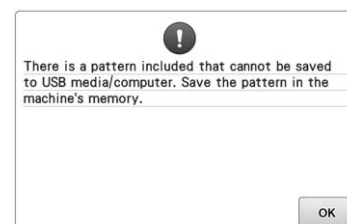

You tried to save a copyright-protected pattern to USB media or a computer.
According to copyright laws, patterns that are illegal to reproduce or edit cannot be saved to USB media or a computer. Save the pattern in the machine's memory.

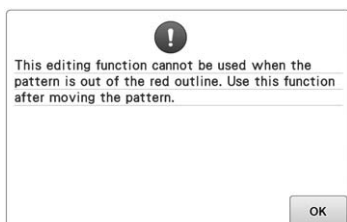

You tried to use an editing function while the pattern is not completely within the red outline.
Move the pattern so the red outline is completely within the embroidery area.

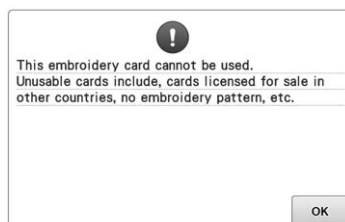

An unusable embroidery card is inserted.
Remove the embroidery card.



The file format is incompatible with this machine.
Check the list of compatible file formats. (Refer to page 186.)

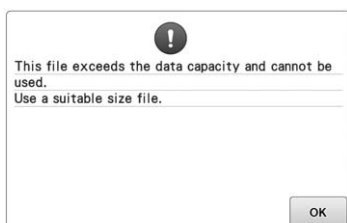

The file size exceeds the data capacity of the machine.
Confirm the file size and format. (Refer to page 186.)



A large-size (split) embroidery pattern was selected to be combined with another embroidery pattern.
This pattern can not be combined.



The pattern has too many stitches and cannot be used.
Data with stitches that exceed specifications (500,000 stitches) cannot be displayed. Use data design software to reduce the number of stitches.



You tried to retrieve a pattern that was downloaded for a different machine.



You tried to use incompatible media.



The USB media is transmitting.



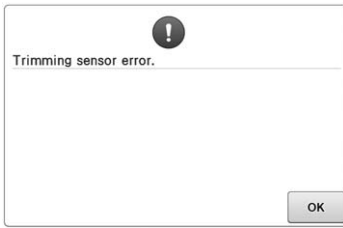

Dust may have accumulated within the moving cutter.
Clean the moving cutter. (Refer to page 211.)

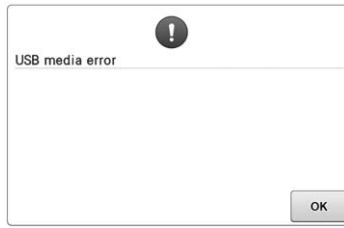

An error has occurred with the USB media.

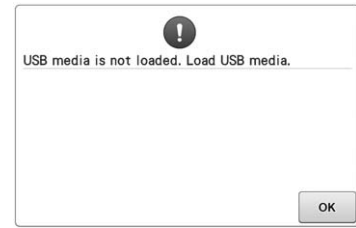

You tried to recall or save a pattern while no USB media is loaded.
Load USB media.

If any of the following messages appear, consult your nearest authorized Brother dealer.

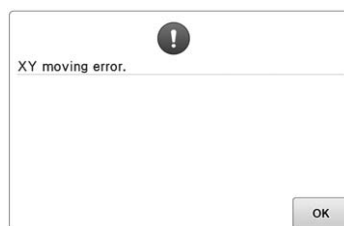
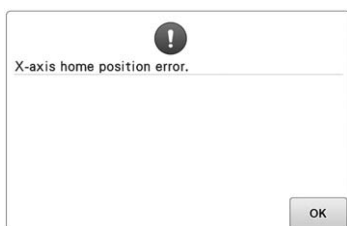
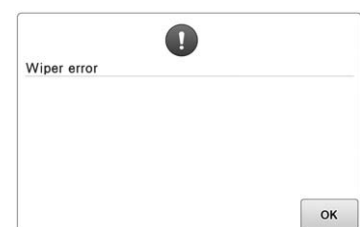
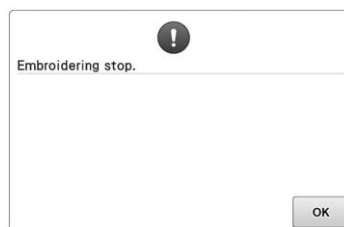
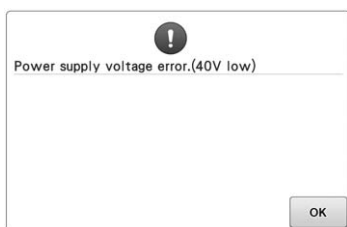
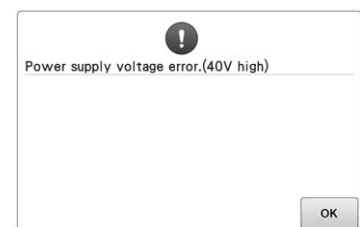
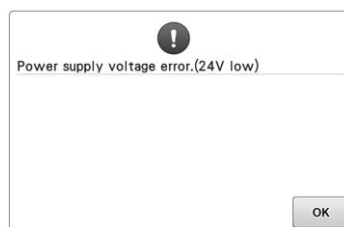
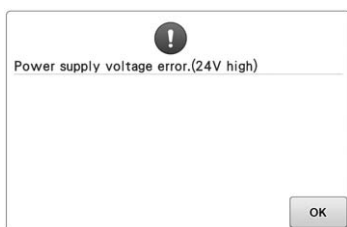
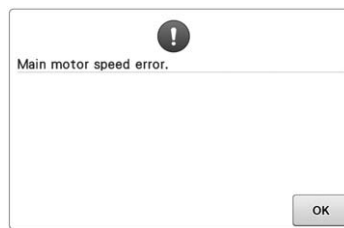
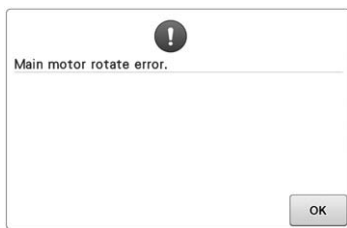
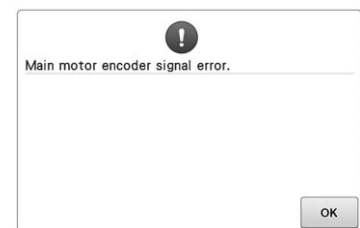
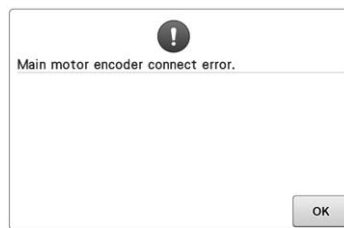
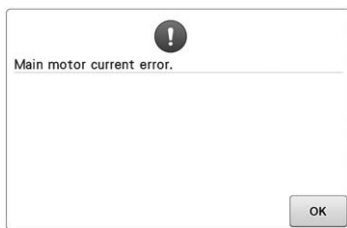
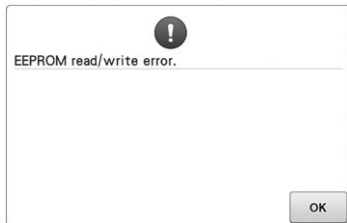
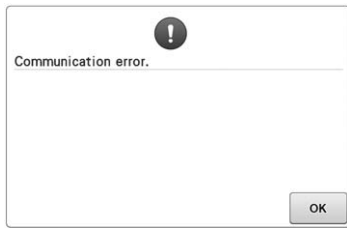

If the machine does not respond when a key is pressed

If nothing happens when a key on the screen is touched (no key can be selected or the keys are misaligned), adjust the touch panel as described below.

- 1 Touch anywhere inside the touch panel, and turn the machine off, then on again.

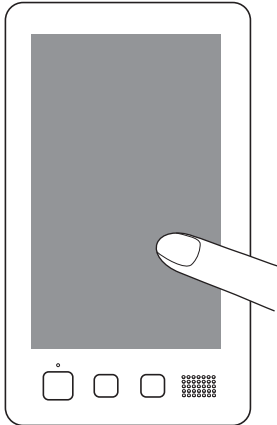

- Continue touching the touch panel until the screen shown below appears.
 - The start/stop button is red.
- The adjustments screen appears.

- 2 Use the included touch pen to touch the center of the numbered crosses on the screen, from 1 to 13.

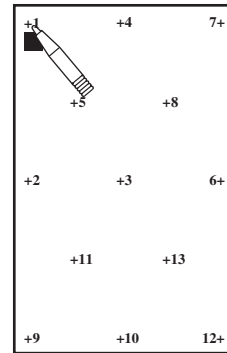

- AD Value X and AD Value Y numbers change with the touch of each numbered cross to show variables.
- If the buzzer sounds when cross number 13 is touched, an error occurred during setting, and "ERROR" appears on the screen. Touch the crosses again, starting with the number indicated on the screen.

⚠ CAUTION

- Be sure to use the included touch pen to adjust the touch panel. Do not use a mechanical pencil, screwdriver or any other hard or sharp object. Do not apply pressure to the LCD screen display, otherwise damage to the display may result.

- 3 After making the necessary touch panel adjustment, "SUCCESS" will show on the screen.



Note

- If the keys still do not respond, even after the touch panel is adjusted, or if the touch panel cannot be adjusted, contact your nearest authorized Brother dealer.

- 4 Turn the machine off, and on again.

Specifications

Embroidery machine specifications

Item	Specification
Weight	38 kg (84 lb)
Machine size	512 (W) × 587 (D) × 762 (H) mm (20-5/32 (W) × 23 (D) × 30 (H) inches)
Sewing speed	Maximum / Tubular: 1,000 spm, Cap: 600 spm Speed range / Max.: 1,000 spm, Min.: 400 spm
Hook Type	Vertical rotary hook
Hook size	Normal size (Type L)
Needle	HA130EBBR / #11
Number of needle	6 needles
Thread tension	Manual
Cap sewing	(Option) 60 mm (H) × 130 mm (W) (2-3/8 inches (H) × 5-1/8 inches (W))
Tubular sewing	(4 frames available) 200 mm (H) × 300 mm (W) (7-7/8 inches (H) × 11-3/4 inches (W)), 130 mm (H) × 180 mm (W) (5-1/8 inches (H) × 7-1/8 inches (W)), 100 mm (H) × 100 mm (W) (4 inches (H) × 4 inches (W)), 40 mm (H) × 60 mm (W) (1-1/2 inches (H) × 2-3/8 inches (W))
Thread trimming	Upper and lower thread
Thread breakage sensor	Yes / Upper thread and bobbin thread
Automatic needle threader	Yes
Communication with PC	USB port
Data storage	USB media/SD card (SD and SDHC)

Upgrading Your Machine's Software

You can use USB media to download software upgrades for your embroidering machine. When an upgrade program is available on " <http://s.brother/cpbac> ", please download the files following the instructions on the website and steps below.

You can use USB to download software upgrades/updates (*****.upf) for your sewing machine.



Note

- Check that no data other than the upgrade file is saved on the USB media being used for this upgrade.

Upgrade procedure

- 1 While pressing the automatic threading button, turn the main power to on.

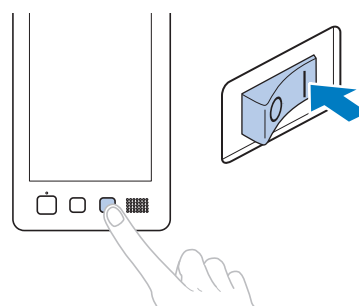

→ The following screen will appear on the LCD.

- 2 Touch .

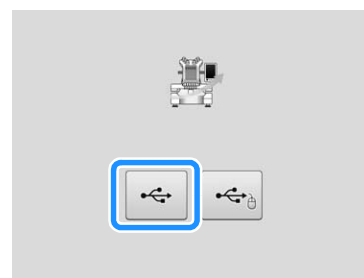

- 3** Insert the USB media into the USB port on the machine. The media device should only contain the upgrade file.

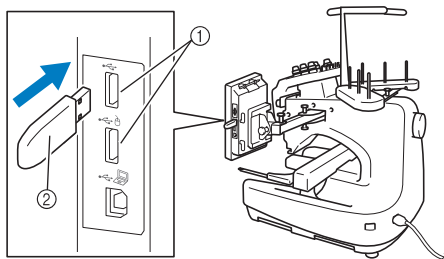

- ① USB ports
② USB media

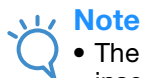

Note

- The access lamp will begin blinking after inserting USB media, and it will take about 5 to 6 seconds to recognize the media. (Time will differ depending on the USB media).

- 4** Touch .



→ The upgrade file is downloaded.



Note

- If an error occurs, a red text error message will appear. When the download is performed successfully, following message will appear.

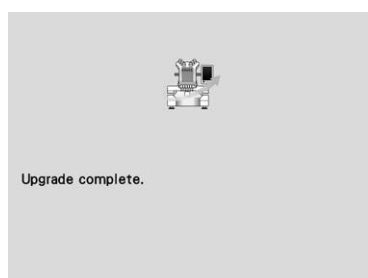

- 5** Remove the USB media, and turn the machine off and on again.

Index

Symbols

"DST" Setting 177, 184

A

Acceleration 177
 Accessories 19
 Adjusting
 angle 91
 edited patterns 148
 legs 24
 operation panel 25
 sewing speed 116
 thread tension 102
 touch panel 230
 Alphabet patterns 130
 Appliqué alphabet 134, 191
 Appliqué sewing 106, 191
 Array key 67, 132, 153
 Arrow key 89, 148
 Automatic lock stitch 112
 Automatic needle-threading button 18, 54
 Automatic needle-threading mechanism 54

B

Background colors 183
 Backing 202
 Basic procedures 32
 Basting 105
 Bobbin 30
 installing 33
 Bobbin case 33, 34, 102, 212
 reinstalling 34
 removing 33
 Bobbin winder 205
 Border frame 165
 Border function 162

C

Canton fleece 204
 Canvas 204
 Carriage 17
 Centerpoint 181
 Change thread color key 67, 157, 159
 Changing
 basting distance 177
 character spacing 153
 colors of the pattern 157
 display guides 180
 embroidering position 89
 font 156
 language 179
 size 150, 151, 156
 text arrangement of a character 153
 thread color display 182
 thread density 157
 thread spools 95
 units of measurements 179

Checking
 needle bars and thread colors 48
 preview image 41
 thread spool changes 94
 Cleaning
 around the needle plate 211
 bobbin case 212
 hook 210
 LCD 210
 machine surface 210
 maintenance message 216
 oiling machine 214
 thread paths 213
 Clock set 36, 37
 Color information 182
 Color shuffling 159
 Color thread table 200
 Combining patterns 146, 155
 Computer
 connecting 123
 port 75
 Corduroy 204
 Cotton sheeting 204
 Custom thread table 167, 169

D

Decorative Alphabet Patterns 133
 Delete key 66, 131
 Deleting
 pattern 171
 short stitches 184
 Denim 204
 Density key 67, 157
 Deselect region setting 110
 Display 31, 63
 Display guides 180
 Distance from center (horizontal) 66
 Distance from center (vertical) 66
 Dress shirt (woven) 204
 DST 73, 124, 184, 200
 Duplicating a pattern 171

E

Eco mode 185
 Edit end key 66
 Edit key 69
 Editing 40, 146, 172
 combined pattern 173
 restart from beginning or middle 97, 99
 Editing patterns as a group 148
 Embroidering
 corner of fabric 87
 small fabric 87
 tape or ribbon 87
 Embroidering position 89
 Embroidering screen 48, 71
 Embroidering settings screen 46, 68, 172

Embroidery	
basic method	57
repeatedly sewing	114
Embroidery data	123
Embroidery frame	
attaching to the machine	44
hooping	42
removing	60
types	82
Embroidery frame holders	80
Embroidery frame indicators	42, 66, 68
Embroidery key	69
Embroidery patterns	125
editing	40, 146
selecting	38
Embroidery thread	50
Enlarge the pattern image	146
Error messages	223

F

Fabric	31, 86
recommendations	31
removing	61
Fabric/stabilizer compatibility chart	204
Features	7
Feet	17
Flipping a pattern	149
Forward/Backward stitch key	72, 97, 99
Frame patterns	126
Front view	17

G

Golf shirt	204
Grouping	148

H

Handwheel	18
Headwear	204
Hook	210
Hook cover/Hook	17
Hooping	42, 85, 203
Horizontal mirror image key	149

J

Jump code	184
Jumpstitch trimming	184

L

Language	179
Large buttonhole patterns	127
LCD	18, 31, 63
LED pointer	178
Lingerie	204
Link function	142
Linked characters	115
Lock stitching key	69, 112
Locking mechanism	57
Locking the needle bar	90
Lower thread guide	17

M

Machine operations guide key	187
------------------------------	-----

Main power switch	18, 35, 61
Maintenance	188, 210
Manual color sequence	108
Manual needle bar settings	120
Maximum sewing speed key	72, 116
Memory key	135, 136
Monogram and frame designs	127
Mouse pointer shape	179
Moving a pattern	148
Moving needle	56
MPEG-4 (MP4) videos	190
Multi color key	67, 156

N

Names of machine parts	17
Needle	30
changing	79
threading	54
Needle bar case	17
Needle bar key	49, 72
Needle bar/Frame move key	36
Needle plate	211
Next page key	65
Number of thread color changes	65, 66, 68

O

Oiling	214
Opening screen	178
Operation panel	17, 18, 25
Optional accessories	21

P

Pattern display area	36
Pattern editing screen	40, 66, 146
Pattern list screen	39, 65
Pattern selection	124
Pattern selection key	147
Pattern size	66, 68
Pattern type selection screen	38, 64
Pointer shape	179
Positioning key	66, 69, 89, 148
Power supply cord	35, 61
Power supply plug	18
Preview key	65, 66, 69
Previewing the Image	41
Previous page key	65
Principal parts	17, 187

R

Region display	71
Remaining length	185
Reserve stop key	72, 117, 119
Reserved needle	120, 178
Resume embroidering	101
Retrieving	
from computer	139
from the machine's memory	137
from USB media/SD card	138
Return key	65, 72
Right-side/rear view	18
Rotate all key	69, 91, 172
Rotate key	67, 152
Rotation angle	66, 68

S

Satin jacket	204
Saving	
to computer	136
to the machine's memory	135
to USB media/SD card	135
Screen	31, 36, 37, 63
brightness	179
Screen saver settings	186
SD card	74, 135, 138
Selecting	
edited pattern	147
embroidery pattern	38, 124
Selecting the thread color	183
Separating combined character patterns	154
Set key	65
Setting up	23
Sewing	
appliqué	191
pattern aligned with a mark on the fabric	199
Sewing light	17, 178
Sewing order	71
Sewing speed	116
Sewing the embroidery	57
Sewing time	71
Short stitch delete	177, 184
Shutoff support mode	185
Silk	204
Six-needle machine	7
Size	65, 66, 68
Size key	65, 67, 150
Spacing key	67, 153
Speaker	18
speaker volume	178
Specifications	231
Split (large-size) embroidery patterns	195
Spool change indicator	71, 95
Spool stand	17
Stabilizer	84, 202, 204
Standard Tail	177, 185
Start/stop button	18, 57
Starting/ending position key	69, 113, 114
Stitch count	71
Stitch recalculation	151
Stitch simulator screen	41
Stopping embroidering	59
at color changes	117
pause	118
Sweater knit	204
Sweatshirt	204

T

Tajima data	184, 200
Temporary needle bar setting key	72, 119
Tension dial	103
Terry cloth	204
Thread	30, 31, 50, 201
Thread color	200
Thread color display	182
Thread color set up display	72
Thread color sorting	162
Thread density	157
Thread guide	17
Thread guide assembly	26
Thread mark	165
Thread recommendations	31

Thread sensor	179
Thread spools	95
changing	95
easily changing	96
Thread tail length	185
Thread tension	102, 209
Thread tension disc	52
Thread tension knobs	17, 103
Thread trimming button	18, 59
Thread trimming key	155
Threading	
needle	54
upper thread	48, 50
Tips for machine operation	197
Touch panel	18
Trial sewing key	47, 69
Troubleshooting	188, 216
T-shirt	204
Tutorial video	189

U

Uninterrupted embroidering (one color)	119
Units of measurements	179
Unlock key	57, 72
Upgrading machine's software	231
Upper thread guide pretension knob	103
Upper threading	48
USB connectivity	74
computer	75
mouse	75
USB media	75
Utility embroidery patterns	127

V

Ventilation slots	18
Version	179
Volume of speaker	178











Please visit us at <http://s.brother/cpbac> where you can get product support and answers to frequently asked questions (FAQs).



English
884-T20
Printed in Taiwan



XG8257-101①