

brother

Wireless Network Setup Guide

Cutting Machine

Product Code: 893-Z05/Z09

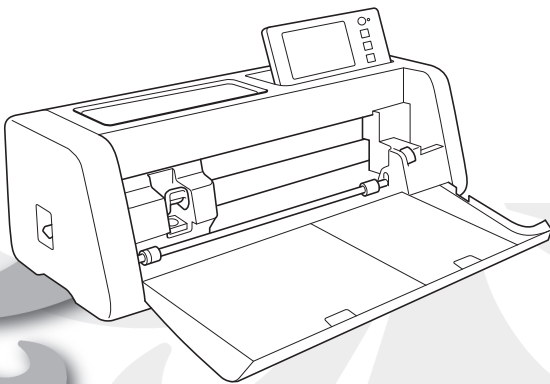

Trademarks

WPA™ and WPA2™ are trademarks of Wi-Fi Alliance®.

Compilation and Publication

Under the supervision of Brother Industries, Ltd., this manual has been compiled and published, covering the latest product descriptions and specifications.

The contents of this manual and the specifications of this product are subject to change without notice.

Brother reserves the right to make changes without notice in the specifications and materials contained herein and shall not be responsible for any damages (including consequential) caused by reliance on the materials presented, including but not limited to typographical and other errors relating to the publication.

Copyright and License

©2022 Brother Industries, Ltd. All rights reserved.

This product includes software developed by the following vendors:

©1983-1998 PACIFIC SOFTWARES, INC.

©2008 Devicescape Software, Inc.

INTRODUCTION

Thank you for purchasing this cutting machine.

This guide provides setup instructions so that you can use a wireless network to send data created in CanvasWorkspace to your cutting machine (hereafter referred to as “machine”) as well as save data that you have edited on your machine to CanvasWorkspace. Carefully read the instructions in this guide and complete the setup to easily transfer data without the need for any device such as a USB flash drive.

Before using this machine, carefully read the “IMPORTANT SAFETY INSTRUCTIONS” in “Product Safety Guide”.

For basic operations of your machine, refer to “Operation Manual”. The Operation Manual can be downloaded from <<http://s.brother/cmoae/>>.

For information on the operations of CanvasWorkspace, refer to the “Help” menu in CanvasWorkspace.

In addition, after you have finished reading this guide, store it where it can quickly be accessed for future reference.

Transfer Data Using Wireless LAN

With this function, patterns edited in the dedicated application CanvasWorkspace or patterns data in Artspira can be transferred to the machine via a wireless network connection.

For details on transferring pattern data, refer to the Operation Manual.

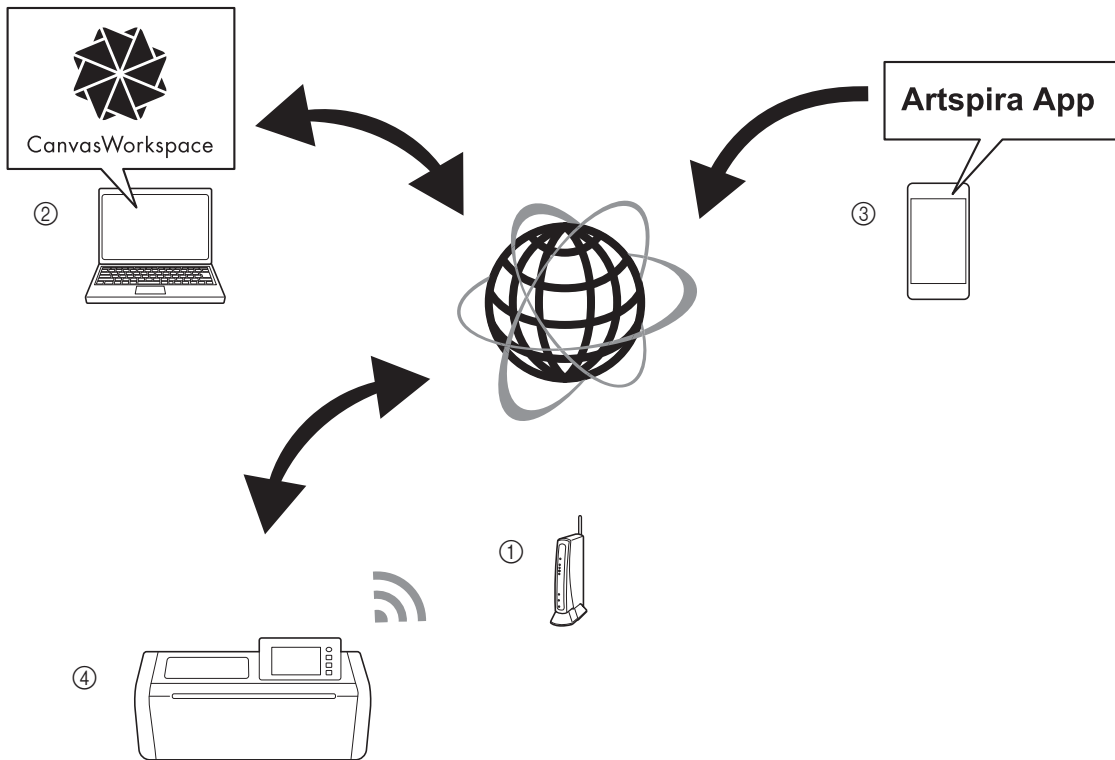

- ① Wireless network access point/router
- ② Computer connected to wireless network
- ③ Mobile device connected to wireless network (Artspira App installed)
- ④ Your machine

Perform the setup with the following steps.

- 1 Set up Wireless Network Connection**
- 2 Login to CanvasWorkspace Internet version.**

- In order to use CanvasWorkspace, a CanvasWorkspace Login ID is necessary. If you do not have a free account, go to <<http://CanvasWorkspace.Brother.com>> to create a new account.

- 3 Register machine under CanvasWorkspace.**

CONTENTS

- INTRODUCTION 1**
- Transfer Data Using Wireless LAN 1**
- Quick Wireless Network Setup Instructions 3**
- Connect Machine to a Wireless Network 6**
 - Activate the Wireless Network 6
 - Set up the Wireless Network 6
 - Check the Wireless Network Setup/Status 9
 - Using the “Others” Menu 9
- Register Machine Under CanvasWorkspace 10**
- Troubleshooting 13**
 - How can I find the wireless security information (Network Name (SSID) and Network Password) 13
 - Error codes/Error messages 13

Quick Wireless Network Setup Instructions

For quick and easy instructions on how to set up your wireless network, please follow the steps below. For more detailed setup procedure, please refer to page 6, and if a connection is not established correctly and an error message appears, see “Error codes/Error messages” on page 13.

■ Requirements for the wireless network connection

The wireless network connection complies with IEEE 802.11 n/g/b standards and uses the 2.4 GHz frequency.

The Wireless Network Name (SSID) and Password (KEY)* for your wireless access point/router are required to connect your machine to a wireless network.

Find this information and note it first.

Make sure that you have the right password and note some password are case (upper case & lower case) sensitive.

Network Name (SSID)	Network Password (Network Key)

* Your network name selection should match the wireless network that your PC or mobile device is connected.

1 Turn on the machine.

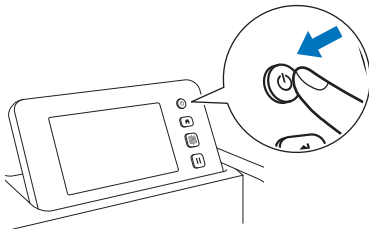

▶ When the following message appears, touch the “OK” key.



2 Touch or in the home screen.

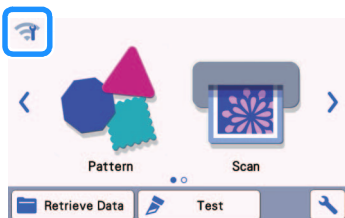

3 Select “ON” for “WLAN Enable”.

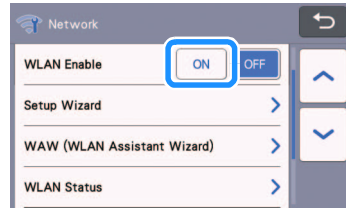

4 Under “Network” settings screen as shown below, touch “Setup Wizard”.

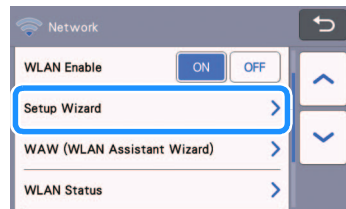

▶ Available Network Name (SSID) will be displayed.

For step 5 & 6 please refer to “Requirements for the wireless network connection” before step 1. You'll need your Wireless Network Name (SSID) and Network Password (Network Key).

5 Select your Network Name (SSID), and then touch the “OK” key.

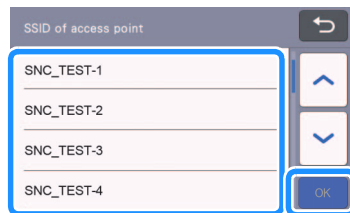

6 Type in the Network Password (Key), and then touch the “OK” key.

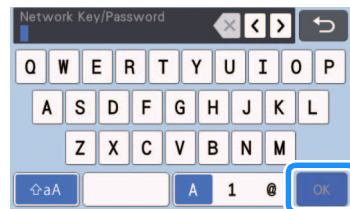

- 7 When the message shown below appears, touch the “Yes” key.

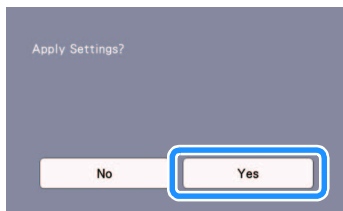

- 8 When a connection is established, the following message appears, touch the “Next” key.

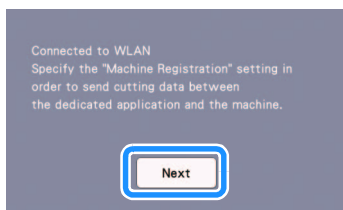

- 9 Once you have completed reading the message appears on the following screen, touch the “Register” key.

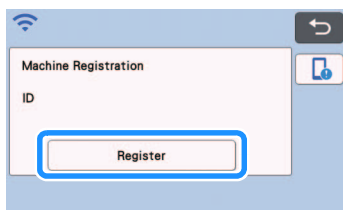

- 10 After the following screen, describing how to obtain the PIN code, appears, leave the screen displayed, and then continue with the following operation using CanvasWorkspace Internet version.

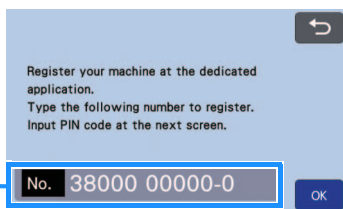

①

Machine number

- 11 Open CanvasWorkspace Internet version (<http://CanvasWorkspace.Brother.com>) on your computer and then log in.



Note

- First time users should obtain a free account.
- If you already have an account with CanvasWorkspace, you can use the same login ID and password to login.

- 12 Click  in the upper-right corner of the screen.

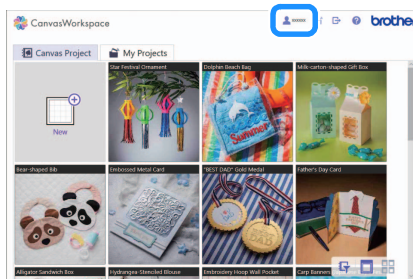

► The page for managing your account appears.

- 13 Click “Machine(s) Registration”.

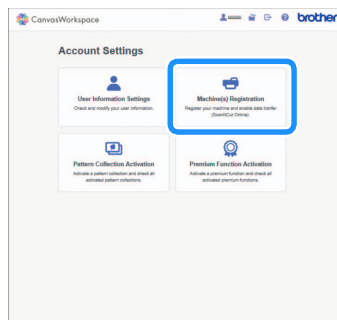

- 14 Click “Register a New Machine”.

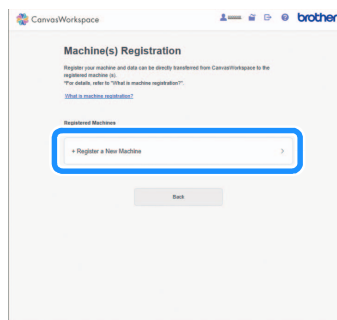

- 15 Type in your machine number, and then click the “OK”.

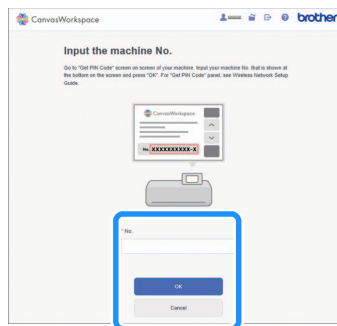

Memo

- Your machine number appears on your machine in the screen shown in step 10 describing how to obtain the PIN code.

- 16 Note the four-digit PIN code that appears on the screen.

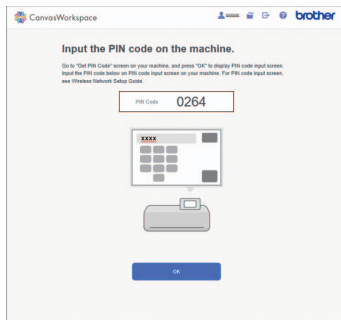

- 17 Go back to your machine's screen and then touch the "OK" key.

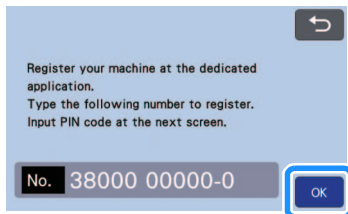

▶ The PIN code input screen appears.

- 18 Type in the four-digit PIN code that appeared in the CanvasWorkspace screen, and then touch the "OK" key.

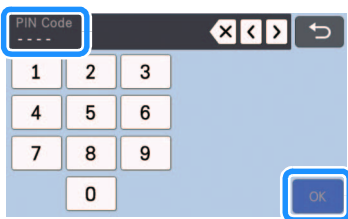

- 19 Touch the "OK" key.

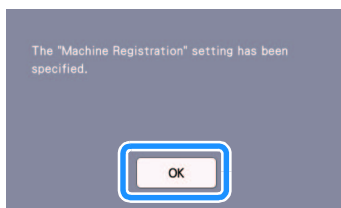

▶ The account registration screen appears.

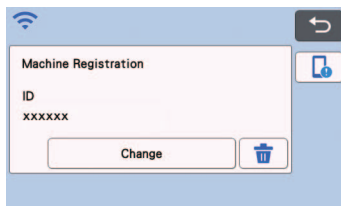

▶ Touch  twice to go back to the home screen.

The Wireless network connection has completed!
Now, you can transfer data between your cutting machine and CanvasWorkspace or the Artspira app!
For details on transferring the data, refer to Operation Manual.

Connect Machine to a Wireless Network

The following procedures are detailed information for network settings.

Activate the Wireless Network

1 Turn on the machine.

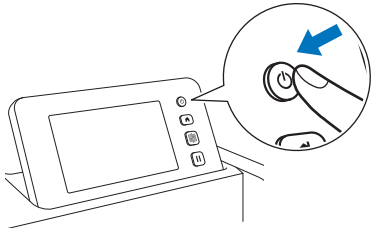

▶ When the following message appears, touch the “OK” key.

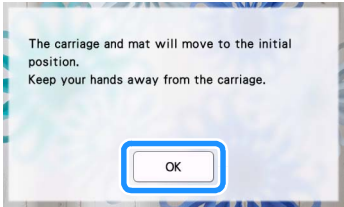

2 Touch  or  in the home screen.

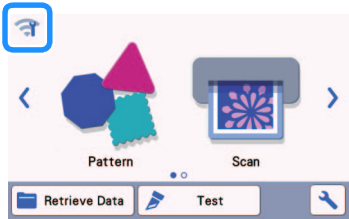

▶ The network settings screen appears.

Memo

- Another way to access the “Network” menu is to click  located at the bottom of the home screen.

3 Select “ON” for “WLAN Enable”.

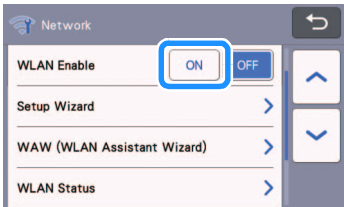

▶ Your machine will begin to emit the wireless network signal.

Memo

- Another way to turn “ON” the “WLAN Enable” is by selecting “Yes” when the message below appears in the “Setup Wizard”.

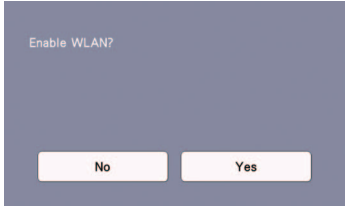

Set up the Wireless Network

Wireless LAN connection can be set up by using the wizard (recommended) or alternative method.

Requirements for the wireless network connection

The wireless network connection complies with IEEE 802.11 n/g/b standards and uses the 2.4 GHz frequency.

Memo

- A wireless network cannot be set up with WPA/WPA2 Enterprise. For the authentication methods your machine supports, see “Err-03” on page 14.

Connect Using Setup Wizard (Recommended)

1 The Wireless Network Name (SSID) & Network Password (KEY)* are required to connect your machine to a wireless network.

* Network Password is also described as the Network Key, Security Key, or Encryption Key.

Network Name (SSID)	Network Password (Network Key)

Note

- If you do not know this information (Network Name (SSID) and Network Password (Key)), you cannot continue the wireless setup.
- How can I find this information?
 - 1) You should see the documentation provided with your wireless access point/router.
 - 2) The default Network Name (SSID) could be the manufacturer's name or the model name.
 - 3) If you do not know the security information, please consult the router manufacturer, your system administrator, or internet provider.
 - 4) Some Wireless Network Name (SSID) and Network Password (Key) are case (upper case and lower case) sensitive. Please properly record your information.

2 Touch or in the home screen.

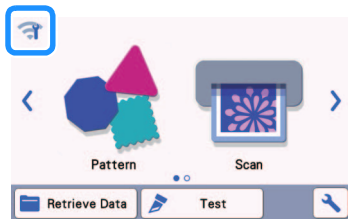

- ▶ The network settings screen appears.

Memo

- Another way to access the "Network" menu is to click  located at the bottom of the home screen.

3 Under "Network" settings screen as shown below, touch "Setup Wizard".

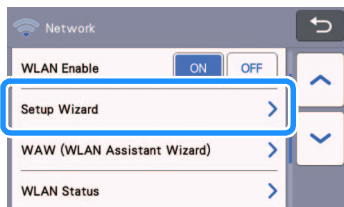

- ▶ Available Network Name (SSID) will be displayed.

4 Select your Network Name (SSID), and then touch the "OK" key.

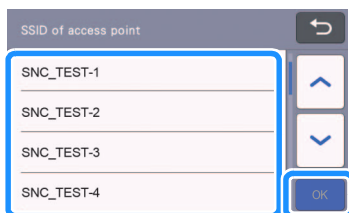

- ▶ The screen for entering the Network Password (Key) appears.

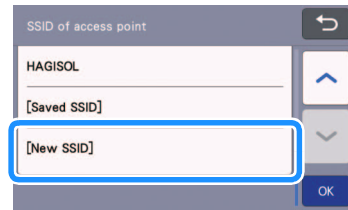

Note

- If the desired Network Name (SSID) is not displayed, specify it as described below.
 - 1) Select "[New SSID]", and then touch the "OK" key.* "[New SSID]" appears at the bottom of the list of detected SSIDs.



- 2) Type in the desired Network Name (SSID), and then touch the "OK" key.
- 3) Specify the authentication method and encryption mode and then touch the "OK" key.

Memo

-  appears beside a previously connected network from the list of available networks. Since the Network Password (Key) has been saved for the network beside , a connection to that network can be re-established without having to re-enter the connection information (Network Password, etc.).
- The previously entered Network Password (Key) for a maximum of 12 connections are saved with "[Saved SSID]". Touch the "[Saved SSID]" key to display the connection information.

5 Type in the Network Password (Key) noted in step 1, and then touch the "OK" key.

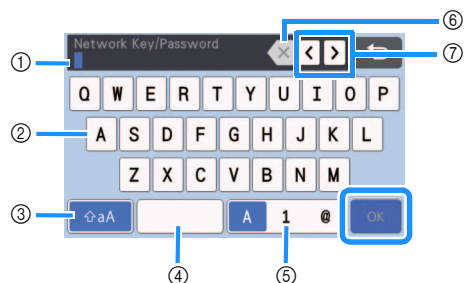

- ① Character input display
- ② Character keys
- ③ Uppercase/lowercase selection key
- ④ Space key
- ⑤ Letter/number/special character selection key
- ⑥ Backspace key (Deletes the character at the cursor's position.)
- ⑦ Cursor keys (Move the cursor to the left or right.)

6 When the message shown below appears, touch the “Yes” key.

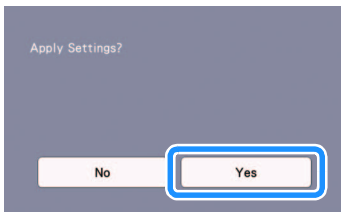

► The following screen appears when a connection is established.

Touch the “Next” key, and then continue with “Register Machine Under CanvasWorkspace” on page 10.

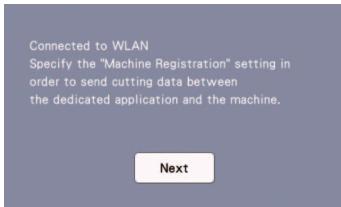

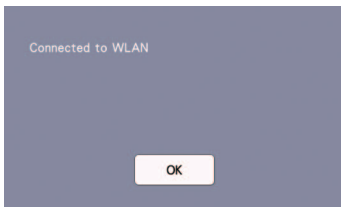

 **Memo**

- If you have already completed the machine registration under CanvasWorkspace, the following screen appears. Touch the “OK” key to complete the wireless network setup.



 **Note**

- If a connection was not successfully established:
 - If the message “Wrong Network Key: Err-04” appeared, the Network Password (Key) may have been entered incorrectly. Touch the “OK” key, and then repeat the procedure from step 3 of “Connect Using Setup Wizard (Recommended)” on page 6.
 - For details on other causes, see “Error codes/Error messages” on page 13.
- While connected, the strength of the signal is indicated by the blue icon  in the upper-left corner of screens such as the home screen.

 : Strong signal

 : Medium signal

 : Weak signal

 : No signal

- After your wireless network has been set up, your machine will connect to the wireless network each time the machine is turned on. However, “WLAN Enable” in the network settings screen must remain set to “ON”.

Check the Wireless Network Setup/Status

Follow these instructions when you can't establish the wireless network connection.

- 1 Under "Network" settings screen as shown below, touch "WLAN Status".

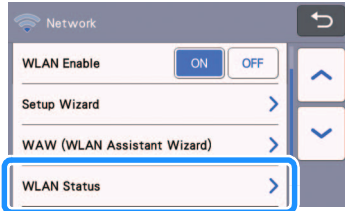

- ▶ The wireless network connection status, protocol, signal strength and Network Name (SSID) are displayed.

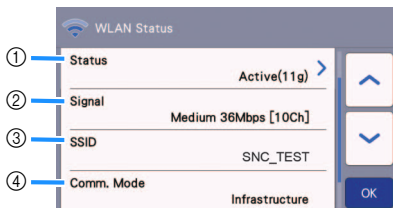

- 1 Displays the connection status.
When "Active (xxx)" is indicated:
The machine is connected to a wireless network. The characters within the parentheses indicate the protocol of the wireless network being used.

When "Connection Fail: Err-xx" is indicated:
The machine failed to establish a connection. "Err-xx" indicates the error number. See "Error codes/Error messages" on page 13.
- 2 Displays the wireless signal strength; communication speed and channel being used.
- 3 Displays the Network Name (SSID).
- 4 Displays the communication mode. The communication mode is fixed to the infrastructure mode.

Using the "Others" Menu

The "Others" menu is at the bottom of the network settings screen.

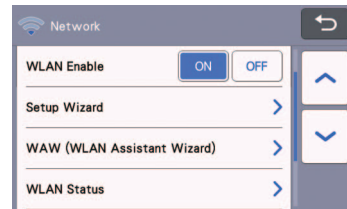

The "Others" menu contains the following items.

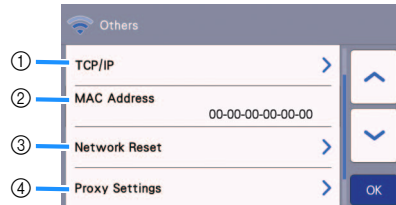

- 1 TCP/IP can be manually entered.
- 2 Displays the MAC address.
- 3 All applied network settings will be reset to manufacturers original settings when the machine was purchased. Any information you inputted will be removed (erased). After setting this function, turn the machine off, then on again.
- 4 Use this when proxy settings are required.

Register Machine Under CanvasWorkspace

Once you have registered your machine under CanvasWorkspace, you can now transfer data to and from CanvasWorkspace and your machine.

This section describes the procedure for linking a machine with a specific number to a CanvasWorkspace login ID.

If the setup is not completed correctly and an error message appears, see “Error codes/Error messages” on page 13.



Note

- A computer that is connected to the network and can run CanvasWorkspace is required.
- Before continuing with this procedure, setup for the connection between your machine and wireless network must be completed. If your machine is not connected to the network, first follow the procedure in “Connect Machine to a Wireless Network” on page 6.

In the following procedures, **[MACHINE]** indicates operations performed from your machine, and **[COMPUTER]** indicates operations performed in CanvasWorkspace.

[MACHINE]

- 1 The following screen message will appear after the wireless network connection setup, touch the “Register” key.

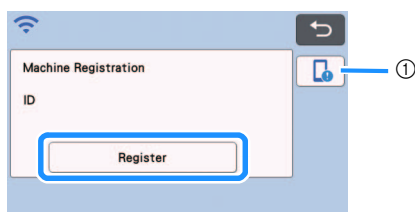

- 1 App Guide key



Memo

- Press the App Guide key to display app instructions related to the machine.
- If the connection is interrupted after the wireless network connection has been set up, the machine can be registered with “Machine Registration” in the settings screen.

- 2 After the following screen, describing how to obtain the PIN code, appears, leave the screen displayed, and then continue with the next **[COMPUTER]** operation.

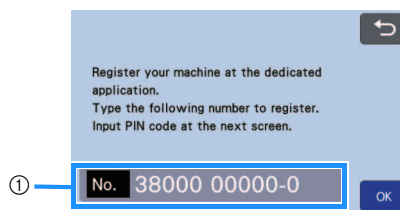

- 1 Machine number



Note

- Do not touch the “OK” key yet. Your machine number appearing in the screen will be used in the following step.

[COMPUTER]

The screens in the following descriptions are those that appear when CanvasWorkspace is opened on a computer.

- 3 Open CanvasWorkspace Internet version (<http://CanvasWorkspace.Brother.com>) on your computer and then log in.



Note

- First time users should obtain a free account.
- If you already have an account with CanvasWorkspace (formerly ScanNCutCanvas), you can use the same login ID and password to login.

4 Click  in the upper-right corner of the screen.

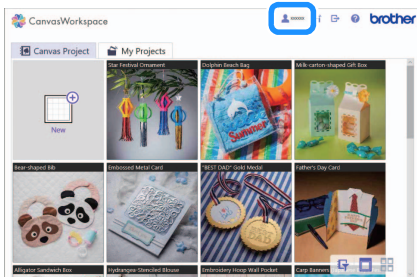

▶ The page for managing your account appears.

5 Click “Machine(s) Registration”.

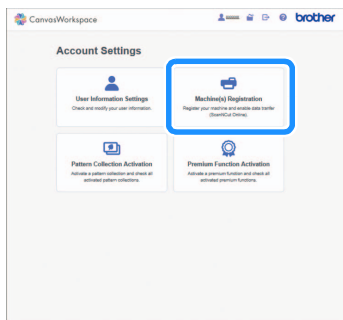

6 Click “Register a New Machine”.

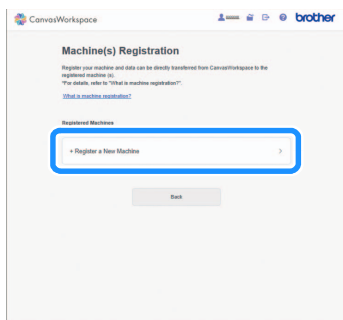

Note

- If the maximum amount of registered machines has been reached, select the registered machine that you are not using and click “Remove” in the “Registered Machine Information” screen, and then register the new machine.

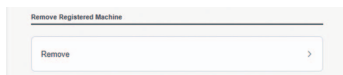

7 Type in your machine number, and then click the “OK” button.

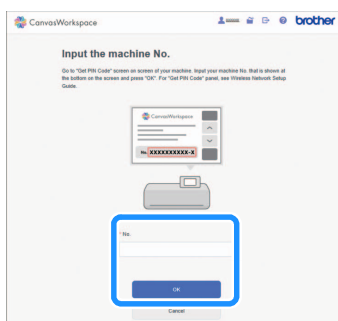

Memo

- Your machine number appears on your machine in the screen shown in step 2 describing how to obtain the PIN code.

▶ A four-digit PIN code appears in the screen.

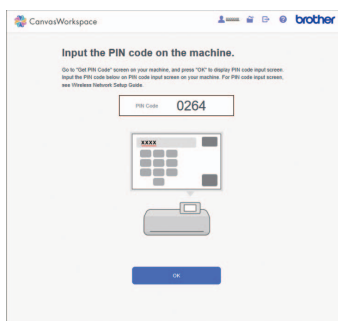

[MACHINE]

8 Touch the “OK” key.

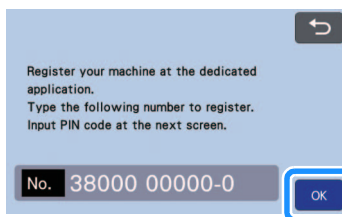

▶ The PIN code input screen appears.

9 Type in the four-digit PIN code that appeared in the CanvasWorkspace screen, and then touch the “OK” key.

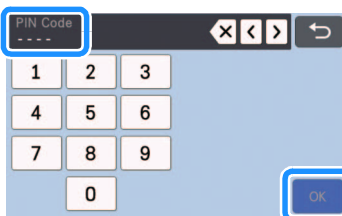

▶ The following screen appears.

10 Touch the “OK” key.

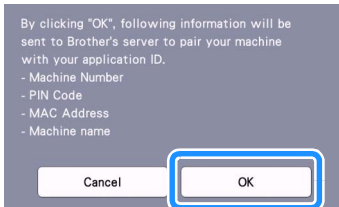

- ▶ The machine information is transferred to the server.

11 Touch the “OK” key.

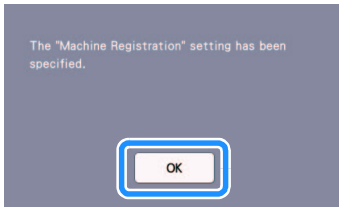

- ▶ The account registration screen appears.

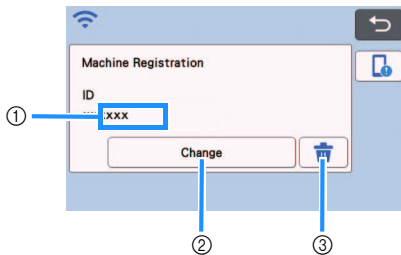

- ① Login ID registered with the machine
- ② Touch this key to link your machine with a different login ID. Then perform the registration operation again, referring to “Deleting the linked login ID” on page 12.
- ③ Touch this key to delete the currently linked login ID. For the detail, refer to “Deleting the linked login ID” on page 12.

This completes the registration of your machine with CanvasWorkspace.

Note

- If an error occurs while transferring data, refer to “ERROR MESSAGES” in the Operation Manual.

For details on transferring data between CanvasWorkspace and your machine, refer to “Operation Manual”.

■ Deleting the linked login ID

To completely delete a linked login ID from the machine, follow the procedure below.

1 Touch .

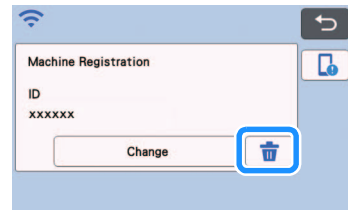

2 Touch the “OK” key.

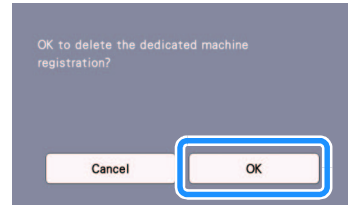

- ▶ The login ID is deleted, and the following screen appears.



Memo

- Touch the “Register” key to register your machine again.

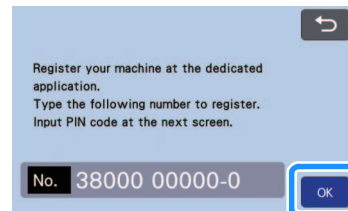
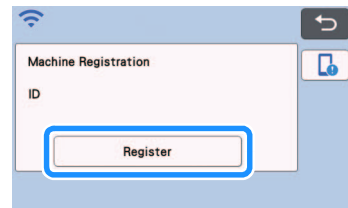

- ▶ For details on the procedure, refer to “Register Machine Under CanvasWorkspace” on page 10.

Please do not contact Brother Customer Service for assistance without the wireless security information. We cannot assist you in locating your network security settings.

How can I find the wireless security information (Network Name (SSID) and Network Password)

- 1) You should see the documentation provided with your wireless access point/router.
- 2) The default Network Name (SSID) could be the manufacturer's name or the model name.
- 3) If you do not know the security information, please consult the router manufacturer, your system administrator, or internet provider.
- 4) Some Wireless Network Name (SSID) and Network Password (Key) are case (upper case and lower case) sensitive. Please properly record your information.

- * The Network Password may also be described as the Network Key, Security Key or Encryption Key.
- * If the wireless access point/router is not broadcasting the Network Name (SSID), the Network Name (SSID) will not automatically be detected. You will have to manually enter the Network Name (SSID).

Error codes/Error messages

The following table contains a list of the various messages that may appear during setup or while registering the machine with CanvasWorkspace as well as the appropriate solutions.

Perform the necessary operation according to the instructions in the message or the solution described here.

If the problem persists, contact the retailer who sold you this machine or the nearest authorized service center.

When Setting Up the Wireless Network

Error code	Cause/Solution
Err-01	<p>The wireless network setting is not activated. Activate the wireless network.</p> <p>See "Activate the Wireless Network" on page 6</p>
Err-02	<p>The wireless access point/router cannot be detected.</p> <ol style="list-style-type: none"> 1. Check the following 4 points. <ul style="list-style-type: none"> - Make sure that the wireless access point/ router is powered on. - Move your machine to an area with no items which obstruct the wireless network signal, such as metal doors or walls, or closer to the wireless access point/router. - Temporarily place your machine within about 1 m (3.3 feet) from the wireless access point when you are configuring the wireless settings. - If your wireless access point/router is using MAC address filtering, confirm the MAC address of this machine is allowed in the filter. 2. If you manually entered the Network Name (SSID) and security information (Network Name (SSID)/authentication method/encryption method/Network Password (Network Key)), the information may be incorrect. Reconfirm the Network Name (SSID) and security information and re-enter the correct information as necessary. <p>See "How can I find the wireless security information (Network Name (SSID) and Network Password)" on page 13 to confirm.</p>

Error code	Cause/Solution												
Err-03	<p>The Authentication/Encryption methods used by the selected wireless access point/router are not supported by your machine.</p> <p>For infrastructure mode, change the authentication and encryption methods of the wireless access point/router. Your machine supports the following authentication methods:</p> <table border="1"> <thead> <tr> <th>Authentication method</th> <th>Encryption method</th> </tr> </thead> <tbody> <tr> <td rowspan="2">WPA-Personal</td> <td>TKIP</td> </tr> <tr> <td>AES</td> </tr> <tr> <td>WPA2-Personal</td> <td>AES</td> </tr> <tr> <td rowspan="2">Open</td> <td>WEP</td> </tr> <tr> <td>None (without encryption)</td> </tr> <tr> <td>Shared key</td> <td>WEP</td> </tr> </tbody> </table> <p>If your problem is not solved, the Network Name (SSID) or network settings you entered may be incorrect. Reconfirm the wireless network settings.</p> <p>See “How can I find the wireless security information (Network Name (SSID) and Network Password)” on page 13 to confirm.</p>	Authentication method	Encryption method	WPA-Personal	TKIP	AES	WPA2-Personal	AES	Open	WEP	None (without encryption)	Shared key	WEP
Authentication method	Encryption method												
WPA-Personal	TKIP												
	AES												
WPA2-Personal	AES												
Open	WEP												
	None (without encryption)												
Shared key	WEP												
Err-04	<p>The security information (Network Name (SSID)/Network Password (Network Key)) is incorrect.</p> <p>Reconfirm the Network Name (SSID) and security information (Network Password (Network Key)).</p> <p>See “How can I find the wireless security information (Network Name (SSID) and Network Password)” on page 13 to confirm.</p>												
Err-05	<p>The wireless security information (Authentication method/Encryption method/Network Password (Network Key)) is incorrect.</p> <p>Reconfirm the wireless security information (Authentication method/Encryption method/Network Password (Network Key)) in the table of Err-03.</p> <p>See “How can I find the wireless security information (Network Name (SSID) and Network Password)” on page 13 to confirm.</p>												
Err-20	<p>The machine is still trying to connect to your wireless network. Please wait a few minutes, and then check the WLAN status.</p>												

When Registering the Machine with CanvasWorkspace

Error message	Cause/Solution
A network error occurred.	<p>A network error occurred during communication.</p> <p>Check the following.</p> <ul style="list-style-type: none"> - Is your wireless access point/router turned on? - Is the network cable of your wireless access point/router plugged in?
Errors occurred in network function.	<p>An internal malfunction occurred.</p> <p>Contact the retailer where you purchased this machine or the nearest authorized service center.</p>
Registration failed.	<p>Registration of the PIN code failed. Internal data may be corrupted.</p> <p>Contact the retailer where you purchased this machine or the nearest authorized service center.</p>
Unconnected to the internet server. Check the proxy setting.	<p>The proxy settings are incorrect.</p> <p>Check the proxy settings of your wireless network and your machine.</p>
Unconnected to the network. Check the network connection status.	<p>The machine is not connected to the network.</p> <ul style="list-style-type: none"> - Check that there is a good network connection. - A network connection may not yet be established. <p>Wait a while, and then try again.</p>

Please visit us at <http://s.brother/cpoac/> where you can get product support and answers to frequently asked questions (FAQs).

These machines are approved for use in the country of purchase only. Local Brother companies or their dealers will only support machines purchased in their own countries.