

Sewing Guide

This guide describes useful sewing tips as well as procedures for using the various utility stitches.

Be sure to first read the "IMPORTANT SAFETY INSTRUCTIONS" in the Operation Manual.

Refer to the Operation Manual for detailed instruction.

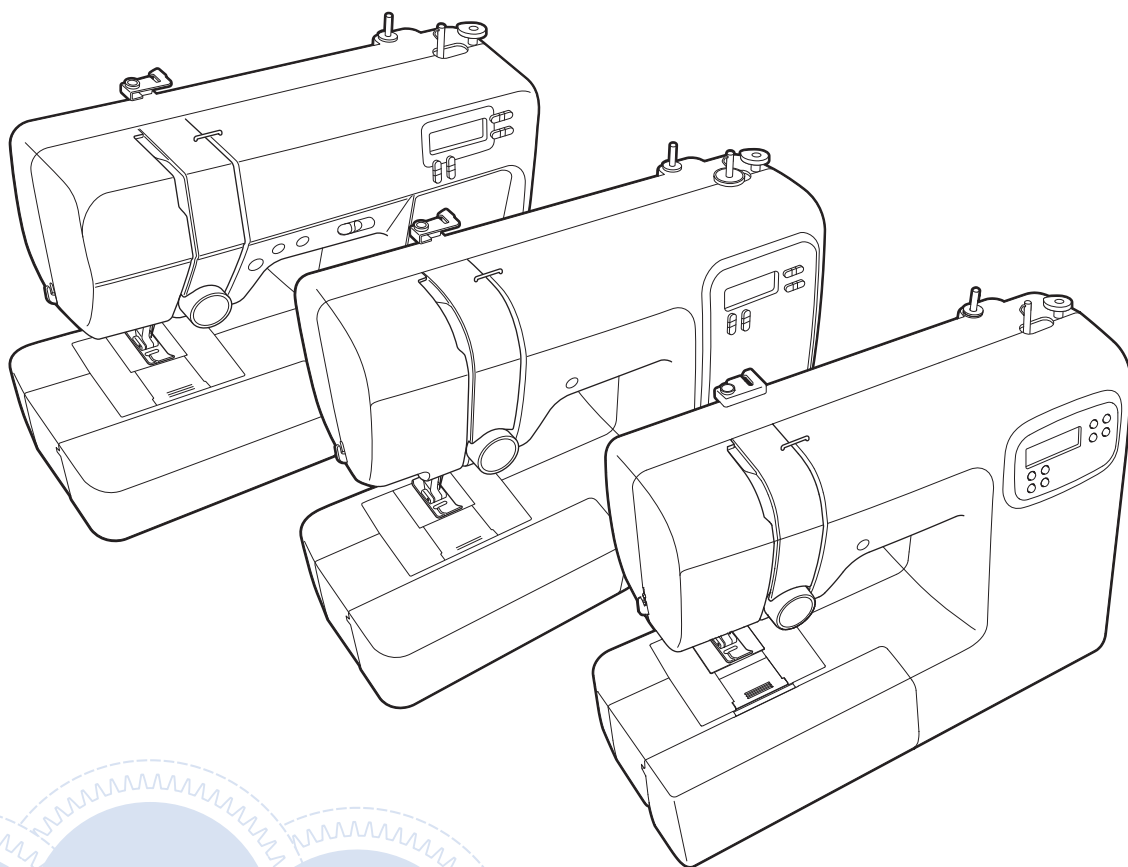

CONTENTS

USEFUL SEWING TIPS.....	3
Sewing Tips.....	3
Trial sewing.....	3
Changing the sewing direction.....	4
Sewing curves.....	5
Sewing cylindrical pieces.....	6
Sewing an Even Seam Allowance.....	7
Changing the needle position.....	7
Aligning the fabric with a needle plate marking.....	8
Aligning the fabric with zigzag foot “J”.....	9
Sewing Various Fabrics.....	10
Sewing thick fabrics.....	10
Sewing thin fabrics.....	11
Sewing stretch fabrics.....	12
Sewing leathers or vinyl fabrics.....	13
Sewing hook-and-loop fastener tape.....	14
Sewing Decorative Stitch Patterns.....	15
UTILITY STITCHES.....	16
Basic Stitching.....	17
Changing the needle position.....	17
Overcasting Stitches.....	18
Using overcasting foot “G”.....	18
Using zigzag foot “J”.....	19
Blind Hem Stitching.....	20
Buttonhole Sewing.....	23
Sewing buttonholes on stretch fabrics.....	26
Button Sewing (for models equipped with the button fitting foot “M”).....	27
Zipper Insertion.....	29
Inserting a centered zipper.....	29
Appliqué, Patchwork and Quilt Stitching.....	31
Appliqué stitching.....	31
Patchwork (crazy quilt) stitching.....	32
Piecing.....	33
Quilting.....	34
Free motion quilting.....	36
Other Stitching Applications.....	38
Elastic attaching.....	38
Bar tack stitching.....	39
Fagoting.....	40
Scallop stitching.....	41
Smocking.....	42
Shell tuck stitching.....	43
Joining.....	44
Heirloom stitching.....	45
MAKING ADJUSTMENT.....	46
INDEX.....	47

USEFUL SEWING TIPS

Sewing Tips

■ Trial sewing

Before starting your sewing project, we recommend sewing trial stitches using thread and scrap fabric that are the same as those used for your project.

While checking the sewing results, adjust the thread tension as well as the stitch length and width according to the number of fabric layers and stitch that is sewn.

Note

- Other factors, such as fabric thickness, stabilizer material, etc., also have an effect on the stitch, so you should always sew a few trial stitches before beginning your project.
- When sewing satin stitch patterns, there may be shrinking or bunching of stitches, so be sure to use a stabilizer material.

■ **Changing the sewing direction**

- 1** When the stitching reaches a corner, stop the machine.

Leave the needle lowered (in the fabric). If the needle remains up when the machine stops sewing, lower the needle.

- 2** Raise the presser foot lever.

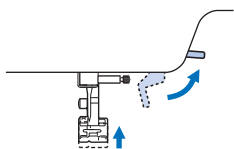

- 3** Turn the fabric.

Turn the fabric using the needle as a pivot.

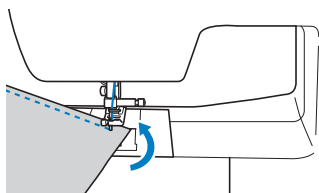

- 4** Lower the presser foot lever and continue sewing.

■ Sewing curves

Sew slowly while slightly changing the sewing direction to sew around the curve. For details on sewing with an even seam allowance, refer to “Sewing an Even Seam Allowance” on page 7.

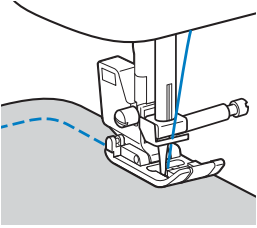

When sewing along a curve while using a zigzag stitch, select a shorter stitch length in order to obtain a finer stitch.

■ Sewing cylindrical pieces

Removing the flat bed attachment allows for free-arm sewing, making it easier to sew cylindrical pieces such as sleeve cuffs and pant legs.

- 1 Pull the flat bed attachment off to the left.**

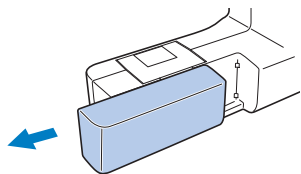

- 2 Slide the part that you wish to sew onto the free arm, and then sew from the top.**

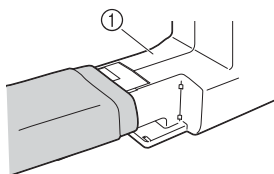

① Free arm

- 3 When you are finished with free arm sewing, install the flat bed attachment back in its original position.**

Sewing an Even Seam Allowance

To sew an even seam, start sewing so that the seam allowance is to the right of the presser foot, and the edge of the fabric is aligned with either the right edge of the presser foot or a marking on the needle plate.

■ Changing the needle position

The needle position used as the baseline is different for the straight stitch (left needle position) and the straight stitch (middle (center) needle position).

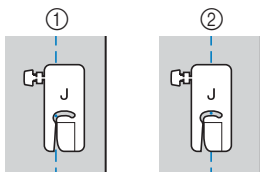

- ① Straight stitch (left needle position)
- ② Straight stitch (middle (center) needle position)

When the stitch width of the straight stitch (left needle position) is set to its standard setting (0.0 mm), the distance from the needle position to the right side of the presser foot is 12 mm (1/2 inch). If the stitch width is changed (between 0 and 7.0 mm (1/4 inch)), the needle position will also change. By changing the stitch width and sewing with the right side of the presser foot aligned with the edge of the fabric, a seam allowance can be sewn with a fixed width.

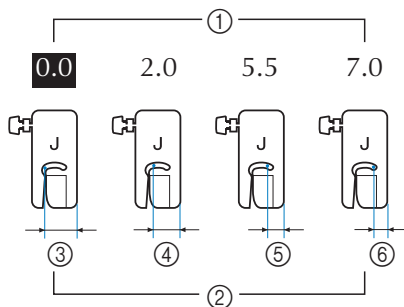

- ① Stitch width setting
- ② Distance from the needle position to the right side of the presser foot
- ③ 12.0 mm (1/2 inch)
- ④ 10.0 mm (3/8 inch)
- ⑤ 6.5 mm (1/4 inch)
- ⑥ 5.0 mm (3/16 inch)

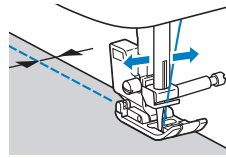

- For details of needle position, refer to “Changing the needle position” on page 17.

■ Aligning the fabric with a needle plate marking

The markings on the needle plate show the distance from the needle position of a seam sewn with the straight stitch (left needle position). Sew while keeping the edge of the fabric aligned with a marking on the needle plate. The distance between the markings in the upper scale is 1/8 inch (3 mm) and the distance between the markings in the grid is 5 mm (3/16 inch).

For stitches with a left needle position (Stitch width: 0.0 mm)

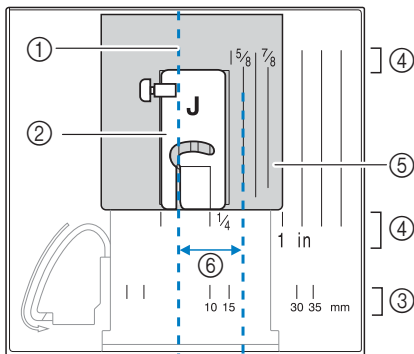

- ① Seam
- ② Presser foot
- ③ Millimeters
- ④ Inches
- ⑤ Needle plate
- ⑥ 16 mm (5/8 inch)

■ Aligning the fabric with zigzag foot “J”

The marking on zigzag foot “J” can be used to sew about 5 mm (3/16 inch) from the edge of the fabric. When using this feature, select a straight stitch, and set the stitch width to 2.0 mm.

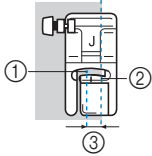

- ① Stitch width 2.0 mm
- ② Marking
- ③ 5 mm (3/16 inch)

Sewing Various Fabrics

■ Sewing thick fabrics

□ If the fabric does not fit under the presser foot

The presser foot lever can be raised to two different positions. If the fabric does not fit under the presser foot, for example, when sewing together thick fabrics, raise the presser foot lever to its highest position so that the fabric can be placed under the presser foot.

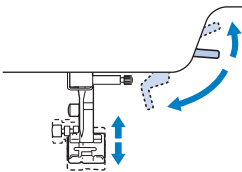

□ If the fabric does not feed

When sewing thick fabric such as denim or quilting, the fabric may not feed at the start of sewing if the presser foot is not level, as shown below. In this case, use the presser foot locking pin (black button on the left side) of zigzag foot "J" so that the presser foot remains level while sewing, allowing the fabric to be fed smoothly.

If the presser foot misalignment is too large, place thick paper or fabric (with the same thickness as the fabric being sewn) under the heel of the presser foot to be able to start sewing smoothly.

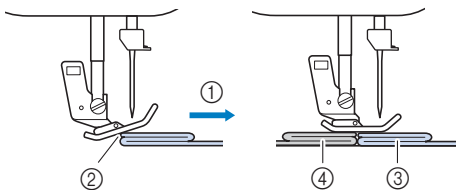

- ① Sewing direction
- ② Misalignment
- ③ Fabric being sewn
- ④ Fabric or thick paper

- 1 Raise the presser foot lever.
- 2 Align the beginning of stitching, and then position the fabric.
- 3 While holding zigzag foot "J" level, push in and hold the presser foot locking pin (black button on the left side), and lower the presser foot lever.

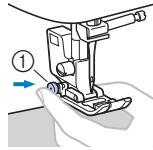

- ① Presser foot locking pin (black button)

- 4 Release the presser foot locking pin (black button).

→ The presser foot remains level, allowing the fabric to be fed.

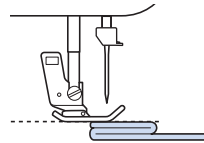

→ After the seam is sewn, the presser foot will return to its original angle.

⚠ CAUTION

- If fabric more than 6 mm (15/64 inch) thick is sewn or if the fabric is pushed with too much force, the needle may bend or break.

■ Sewing thin fabrics

When sewing thin fabrics, the stitching may become misaligned or the fabric may not feed correctly. If this occurs, place thin paper or stabilizer material under the fabric and sew it together with the fabric. When you have finished sewing, tear off any excess paper.

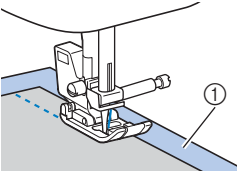

① Stabilizer material or paper

■ Sewing stretch fabrics

First, baste the pieces of fabric together, and then sew without stretching the fabric. If the stitching is misaligned, place non-woven water soluble stabilizer under the fabric and sew them together.

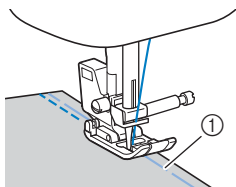

① Basting

For best results when sewing on knit fabrics use the stretch stitches. Also be sure to use a needle for knits (Ball Point needle (gold colored)). The recommended stitches and their stitches are shown below.



* Stitches may differ depending on the model. Check stitch selections on the machine's body, and then select the stitch number.

Note

- Be sure to follow manufacturer's instructions when using water soluble stabilizer. It may not be compatible with some fabrics.
-

■ Sewing leathers or vinyl fabrics

When sewing fabrics that may stick to the presser foot, such as leather or vinyl fabrics, replace the presser foot with the walking foot* or non stick foot*.

* Items sold separately, please contact your authorized Brother dealer.

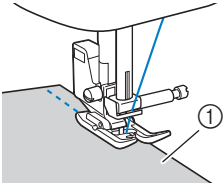

① Leather

If the leather or vinyl fabric sticks to the flat bed attachment, sew with copy paper or tracing paper placed on top of the flat bed attachment so the fabric moves smoothly.

If the paper is positioned so that it does not cover the needle plate, the paper will not be sewn together with the fabric.

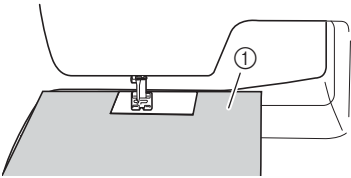

① Copy paper or tracing paper

💡 Note

- The walking foot can only be used with straight or zigzag stitch patterns. Do not sew reverse stitches with the walking foot.
- When sewing with the walking foot, sew at a speed between slow and medium.
- When using the walking foot, test sew on a scrap piece of leather or vinyl that is to be used in project to make sure foot does not leave any marks.

■ Sewing hook-and-loop fastener tape

⚠ CAUTION

- Use only the adhesive-free hook-and-loop fastener tape which is designed for sewing. When the glue adheres to the needle or the bobbin case, it may cause malfunction.
- If the hook-and-loop fastener tape is sewn with the thin needle (65/9-75/11), the needle may bend or break.

💡 Note

- Before sewing, baste together the fabric and the hook-and-loop fastener tape.

Make sure that the needle passes through the hook-and-loop fastener tape by turning the handwheel and lower the needle into the hook-and-loop fastener tape before sewing. And then, sew the edge of the hook-and-loop fastener tape at a slow speed.

If the needle does not pass through the hook-and-loop fastener tape, replace the needle with the needle size for thicker fabrics. For details, refer to “Fabric/Thread/Needle Combinations” on the Operation Manual.

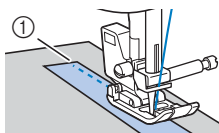

① Edge of the hook-and-loop fastener tape

Sewing Decorative Stitch Patterns

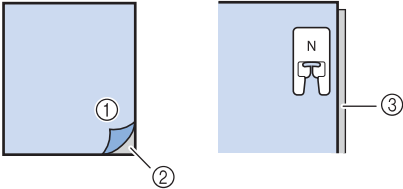
Fabric	<p>When sewing on stretch fabrics, lightweight fabrics, or fabrics with coarse weaves, attach stabilizer on the wrong side of the fabric. An alternative would be to place the fabric on thin paper such as tracing paper.</p>  <p>① Fabric ② Stabilizer ③ Thin paper</p>
Thread	#50 - #60
Needle	<p>With lightweight, regular, or stretch fabrics: the Ball point needle (gold colored) 90/14 With heavyweight fabrics: home machine needle 90/14</p>

UTILITY STITCHES

You can see the “Stitch chart” from “ <http://s.brother/cmkg/> ”.

CAUTION

- **Before replacing the presser foot, be sure to turn off the machine, otherwise injuries may occur if the foot controller or any button is accidentally pressed and the machine starts sewing. For details on changing the presser foot, refer to the Operation Manual.**

Basic Stitching

Straight stitches are used for sewing plain seams.

1 Baste or pin together the fabric pieces.

2 Attach zigzag foot "J".

3 Select a stitch.



* Stitches may differ depending on the model. Check stitch selections on the machine's body, and then select the stitch number.

4 Lower the needle into the fabric at the beginning of the stitching.

5 Start sewing.

- For details, refer to "Starting to sew" on the Operation Manual.
- For details on sewing reverse/reinforcement stitches, refer to "Sewing reverse/reinforcement stitches" on the Operation Manual.

6 When sewing is finished, cut the thread.

- For details, refer to "Starting to sew" on the Operation Manual.



■ Changing the needle position

With the straight stitch and the triple stretch stitch, the needle position can be adjusted. Pressing "+" of the stitch width keys moves the needle to the right; pressing "-" of the stitch width keys moves the needle to the left.

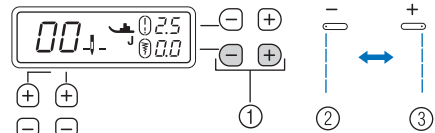

- ① Stitch width keys
- ② Left needle position
- ③ Right needle position

Overcasting Stitches

Sew overcasting stitches along the edges of cut fabric to prevent them from fraying.

■ Using overcasting foot “G”

1 Attach overcasting foot “G”.

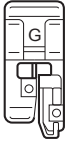

2 Select a stitch.



* Stitches may differ depending on the model. Check stitch selections on the machine’s body, and then select the stitch number.

⚠ CAUTION

- When using overcasting foot “G”, be sure to select a stitch that can be used with overcasting foot “G”. If you sew with the incorrect stitch, the needle may hit the presser foot, bending the needle or damaging the presser foot.

3 Position the fabric with the edge of the fabric against the presser foot guide, and then lower the presser foot lever.

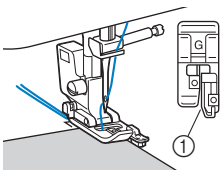

① Presser foot guide

4 Rotate the handwheel toward you (counterclockwise). Check that the needle does not touch the presser foot.

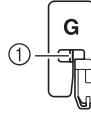

① The needle should not touch the presser foot center bar.

5 Sew with the edge of the fabric against the presser foot guide.

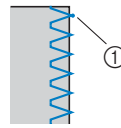

① Needle drop point

⚠ CAUTION

- Be sure to pull the fabric backward after finished sewing. If you pull the fabric toward side or forward, the presser foot pin may be damaged.
- If thread is tangled on the presser foot, remove the entangled thread, and then raise the presser foot lever to remove the presser foot. If the presser foot is raised while entangled with thread, the presser foot may be damaged.

6 Stop sewing when you are finished, and raise the presser foot and needle to pull the fabric under the presser foot towards the back of the machine.

■ Using zigzag foot “J”

1 Attach zigzag foot “J”.

2 Select a stitch.



* Stitches may differ depending on the model. Check stitch selections on the machine’s body, and then select the stitch number.

3 Sew along the edge of the fabric with the needle dropping off the edge at the right.

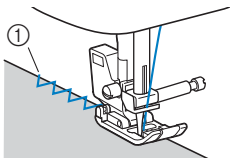

① Needle drop point

Blind Hem Stitching

Secure the lower edge of skirts and pants with a blind hem.

Memo

- When the size of cylindrical pieces is too small to slide onto the arm or the length is too short, the fabric will not feed and desired results may not be achieved.

1 Turn the skirt or pants inside out.

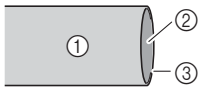

- ① Wrong side of fabric
- ② Right side of fabric
- ③ Lower edge of fabric

2 Fold the lower edge of fabric to the desired length to be hemmed and then press.

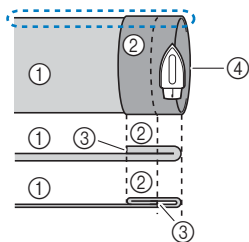

<Thick fabric>

<Normal fabric>

<Seen  from the side>

- ① Wrong side of fabric
- ② Right side of fabric
- ③ Lower edge of fabric
- ④ Desired length for hem

3 Using tailor's chalk, mark the fabric about 5 mm (3/16 inch) from the edge of the fabric, and then baste it.

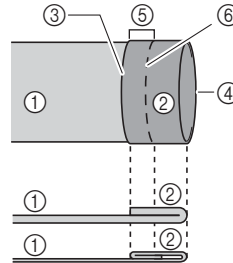

<Thick fabric>

<Normal fabric>

<Seen from the side>

- ① Wrong side of fabric
- ② Right side of fabric
- ③ Lower edge of fabric
- ④ Desired length for hem
- ⑤ 5 mm (3/16 inch)
- ⑥ Basting

4 Fold back the fabric inside along the basting.

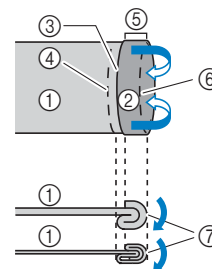

<Thick fabric>

<Normal fabric>

<Seen from the side>

- ① Wrong side of fabric
- ② Right side of fabric
- ③ Lower edge of fabric
- ④ Desired length for hem
- ⑤ 5 mm (3/16 inch)
- ⑥ Basting
- ⑦ Basting point

- 5** Unfold the edge of fabric, and position the fabric with the wrong side facing up.

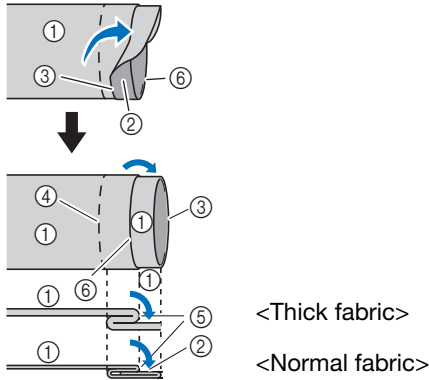

<Seen from the side>

- ① Wrong side of fabric
- ② Right side of fabric
- ③ Edge of fabric
- ④ Desired edge of hem
- ⑤ Basting point
- ⑥ Basting

- 6** Attach blind stitch foot “R”.

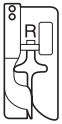

- 7** Select a stitch.



* Stitches may differ depending on the model. Check stitch selections on the machine's body, and then select the stitch number.

- 8** Remove the flat bed attachment to use the free arm.

- 9** Slide the item that you wish to sew onto the free arm, make sure that the fabric feeds correctly, and then start sewing.

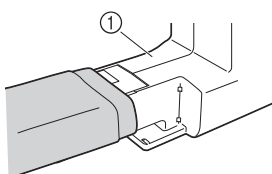

- ① Free arm

- 10** Position the fabric with the edge of the folded hem against the presser foot guide, and then lower the presser foot lever.

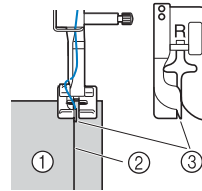

- ① Wrong side of fabric
- ② Fold of hem
- ③ Presser foot guide

- 11** Adjust the stitch width until the needle slightly catches the fold of the hem.

For details of stitch width, refer to the Operation Manual.

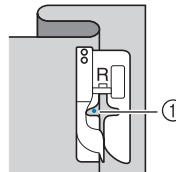

- ① Needle drop point

When you change the needle drop point, raise the needle, and then change the stitch width.

* To make fine adjustments to the needle drop point, adjust the stitch width setting. (The stitch width setting is in neither millimeters nor inches.)

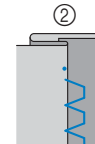
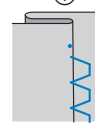
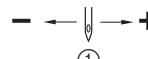

- ① Thick fabric
- ② Normal fabric

 **Memo**

- Blind hem stitches cannot be sewn if the left needle drop point does not catch the fold. If the needle catches too much of the fold, the fabric cannot be unfolded and the seam appearing on the right side of the fabric will be very large, leaving an unattractive finish.

12 Sew with the fold of the hem against the presser foot guide.

13 Stop sewing when you are finished, and raise the presser foot and needle to pull the fabric under the presser foot towards the back of the machine.

 **Note**

- Be sure to pull the fabric towards the back of the machine after sewing. If you pull the fabric toward side or forward, the presser foot may be damaged.

14 Remove the basting stitching and turn the fabric with the right side facing out.

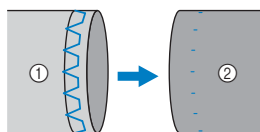

- ① Wrong side of fabric
- ② Right side of fabric

Buttonhole Sewing

The maximum buttonhole length is about 28 mm (1-1/8 inches) (diameter + thickness of the button).

Buttonholes are sewn from the front of the presser foot to the back, as shown below.

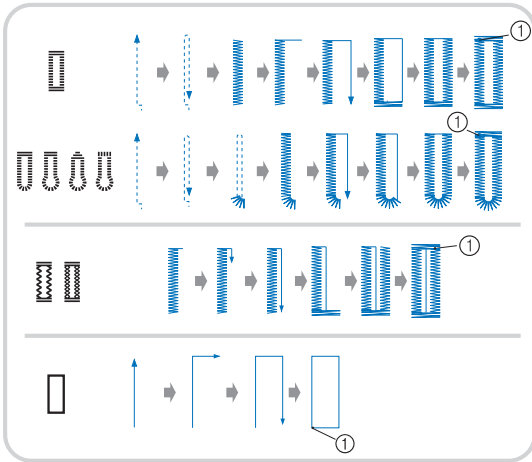

① Reinforcement stitching

* Stitches may differ depending on the model. Check stitch selections on the machine's body, and then select the stitch number.

The part names of buttonhole foot "A", which is used to create buttonholes, are indicated below.

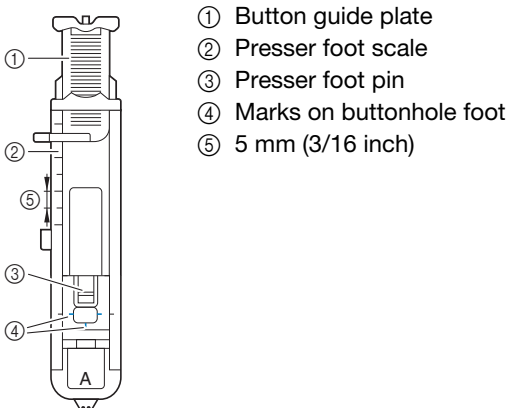

Note

- Before sewing buttonholes, check the stitch length and width by sewing a trial buttonhole on a scrap piece of fabric used for your project.

- 1 Use chalk to mark on the fabric the position and length of the buttonhole.

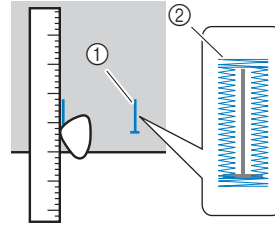

- ① Marks on fabric
- ② Buttonhole sewing

- 2 Pull out the button guide plate of buttonhole foot "A", and then insert the button that will be put through the buttonhole.

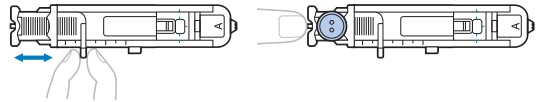

- * If the button does not fit in the button guide plate

Add together the diameter and thickness of the button, and then set the button guide plate to the calculated length. (The distance between the markings on the presser foot scale is 5 mm (3/16 inch).)

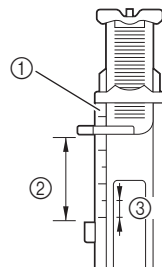

- ① Presser foot scale
- ② Length of buttonhole (diameter + thickness of button)
- ③ 5 mm (3/16 inch)

Example: For a button with a diameter of 15 mm (9/16 inch) and a thickness of 10 mm (3/8 inch), the button guide plate should be set to 25 mm (1 inch) on the scale.

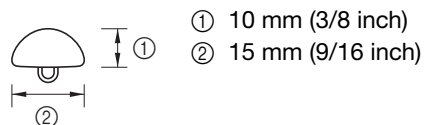

→The size of the buttonhole is set.

3 Attach buttonhole foot "A".

Before attaching the buttonhole foot "A", pass the upper thread underneath the presser foot through the hole.

4 Select a stitch.



* Stitches may differ depending on the model. Check stitch selections on the machine's body, and then select the stitch number.

5 Position the fabric with the front end of the buttonhole mark aligned with the red marks on the sides of the buttonhole foot, and then lower the presser foot lever.

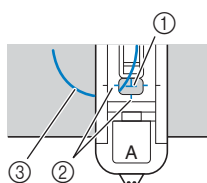

- ① Mark on fabric (front)
- ② Red marks on buttonhole foot
- ③ Upper thread

Note

- When lowering the presser foot, do not push in the front of the presser foot, otherwise the bar tack will not be sewn with the correct size.

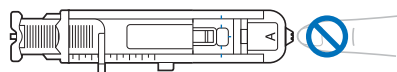

6 Pull down the buttonhole lever as far as possible.

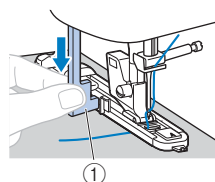

- ① Buttonhole lever

The buttonhole lever is positioned behind the bracket on the buttonhole foot.

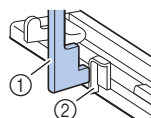

- ① Buttonhole lever
- ② Bracket

7 Gently hold the end of the upper thread in your left hand, and then start sewing.

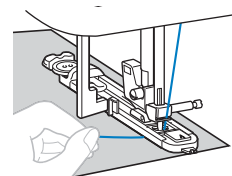

→Once sewing is completed, the machine automatically sews reinforcement stitches, then stops.

8 Raise the needle and presser foot, then remove the fabric, and then cut the threads.

9 Raise the buttonhole lever to its original position.

10 Insert a pin along the inside of one bar tack at the end of the buttonhole stitching to prevent the stitching from being cut.

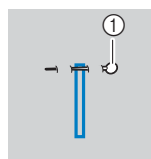

- ① Pin

- 11** Use the seam ripper to cut towards the pin and open the buttonhole.

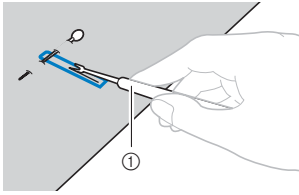

① Seam ripper

For keyhole buttonholes, use the eyelet punch to make a hole in the rounded end of the buttonhole, and then use the seam ripper to cut open the buttonhole.

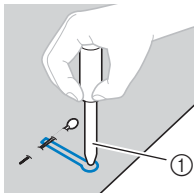

① Eyelet punch

- When using the eyelet punch, place thick paper or some other protective sheet under the fabric before punching the hole in the fabric.

⚠ CAUTION

- When opening the buttonhole with the seam ripper, do not place your hands in the cutting direction, otherwise injuries may result if the seam ripper slips.
- Do not use the seam ripper in any other way than how it is intended.

■ **Sewing buttonholes on stretch fabrics**

Available on models with the following stitches.



When sewing buttonholes on stretch fabrics, use a gimp thread.

- 1** Hook the gimp thread onto the part of buttonhole foot “A” shown in the illustration.

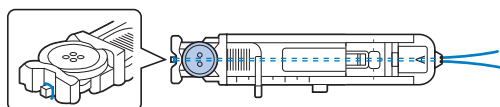

- 2** It fits into the grooves, and then loosely tie it.

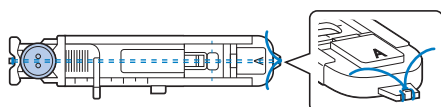

- 3** Attach buttonhole foot “A”.

- 4** Select a stitch.



* Stitches may differ depending on the model. Check stitch selections on the machine’s body, and then select the stitch number.

- 5** Adjust the stitch width to the thickness of the gimp thread.

- 6** Lower the presser foot lever and the buttonhole lever, and then start sewing.

- 7** When sewing is finished, gently pull the gimp thread to remove any slack.

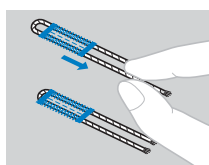

- 8** Use a handsewing needle to pull the gimp thread to the wrong side of the fabric, and then tie it.

Button Sewing (for models equipped with the button fitting foot “M”)

Buttons can be sewn on with the machine. Buttons with two or with four holes can be attached.

- 1 Measure the distance between the holes in the button to be attached.



- 2 Raise the presser foot lever, and then slide the feed dog position switch, located at the rear of the machine on the base, to **▲** (to the left as seen from the rear of the machine).

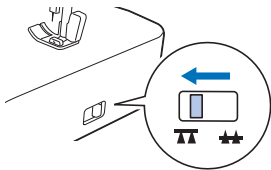

→ The feed dogs are lowered.

- 3 Attach button fitting foot “M”.

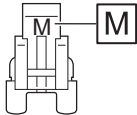

- 4 Select the zigzag stitch.



* Check the stitch number on the machine's body, and set the machine for that stitch.

- 5 Adjust the stitch width so that it is the same as the distance between the holes in the button.

- 6 Place the button in the position where it will be sewn, and lower the presser foot lever.

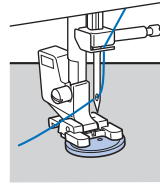

- When attaching four-hole buttons, first sew the two holes closest to you. Then, slide the button so that the needle goes into the two holes toward the rear of the machine, and then sew them in the same way.

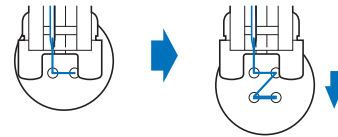

- 7 Turn the handwheel toward you (counterclockwise) to check that the needle correctly goes into the two holes of the button.

If it seems as if the needle will hit the button, remeasure the distance between the holes in the button. Adjust the stitch width to the distance between the button holes.

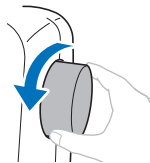

⚠ CAUTION

- When sewing, be sure that the needle does not touch the button, otherwise the needle may bend or break.

8 Sew about 10 stitches at a slow speed.

(For models equipped with the sewing speed controller on the machine)
Set the sewing speed controller to the left so that the speed will be slow.

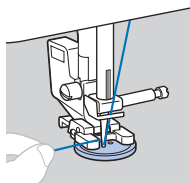

9 Use scissors to cut the upper thread and the bobbin thread at the beginning of the stitching.

Pull the upper thread at the end of the stitching to the wrong side of the fabric, and then tie it with the bobbin thread.

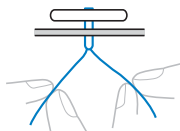

10 When you are finished attaching the button, slide the feed dog position switch, to ▲▲ (to the right as seen from the rear of the machine) and turn the handwheel to raise the feed dogs.

Memo

- The feed dogs come up when you start sewing again.
-

Zipper Insertion

■ Inserting a centered zipper

Stitching is sewn on both pieces of fabric butted against each other.

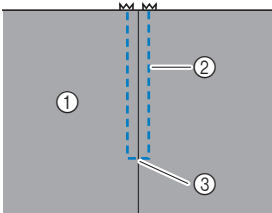

- ① Right side of fabric
- ② Stitching
- ③ End of zipper opening

1 Attach zigzag foot "J".

2 Sew straight stitches up to the zipper opening.

With the right sides of the fabric facing each other, sew reverse stitches after reaching the zipper opening.

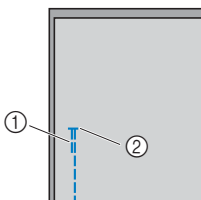

- ① Reverse stitches
- ② End of zipper opening

3 Baste the fabric from the zipper opening to the edge of the fabric.

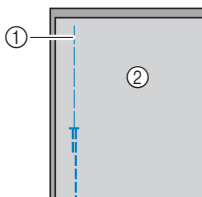

- ① Basting stitching
- ② Wrong side of fabric

4 Press open the seam allowance from the wrong side of the fabric.

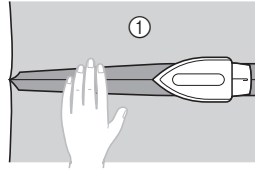

- ① Wrong side of fabric

5 Align the seam with the center of the zipper, and then baste the zipper in place to the seam allowance.

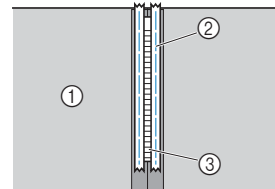

- ① Wrong side of fabric
- ② Basting stitching
- ③ Zipper

6 Remove about 5 cm (2 inches) from the end of the basting on the outside.

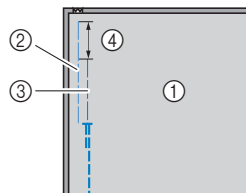

- ① Wrong side of fabric
- ② Zipper basting
- ③ Outside basting
- ④ 5 cm (2 inches)

- 7** Attach the presser foot holder to the right pin of zipper foot “1”.

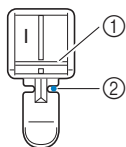

- ① Pin on the right side
- ② Needle drop point

- 8** Select the straight stitch (middle (center) needle position).



- * Check the stitch number on the machine’s body, and set the machine for that stitch.

⚠ CAUTION

- When using zipper foot “1”, be sure to select the straight stitch (middle (center) needle position), and slowly turn the handwheel toward you (counterclockwise) to check that the needle does not touch the presser foot. If a different stitch is selected or the needle hits the presser foot, the needle may bend or break.

- 9** Topstitch around the zipper.

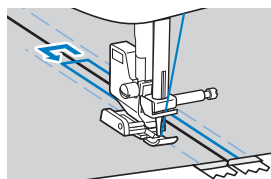
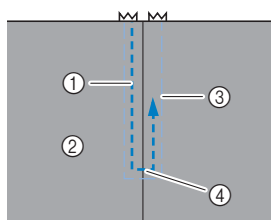

- ① Stitching
- ② Right side of fabric
- ③ Basting stitching
- ④ End of zipper opening

⚠ CAUTION

- When sewing, be sure that the needle does not touch the zipper, otherwise the needle may bend or break.

📖 Memo

- If the presser foot contacts the zipper slider, leave the needle lowered (in the fabric) and raise the presser foot. After moving the slider so it will not contact the presser foot, lower the presser foot and continue sewing.

- 10** Remove the basting stitching.

Appliqué, Patchwork and Quilt Stitching

■ Appliqué stitching

- 1 Baste or glue the appliqué piece to the base fabric to secure it.

Note

- If glue is used to hold the appliqué in place on the fabric, do not apply glue to areas that will be sewn with the machine. If glue adheres to the needle or bobbin case, the machine may be damaged.

- 2 Attach the zigzag foot “J”.

- 3 Select a stitch.

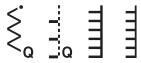

- * Stitches may differ depending on the model. Check stitch selections on the machine’s body, and then select the stitch number.
- * When none of the above stitches is available, select “  ”, and at the beginning and end of sewing, pull the upper thread to the wrong side of the fabric, and then tie it with the bobbin thread.
- * Do not use reverse stitching and automatic reverse/reinforcement stitching.

- 4 Turn the handwheel toward you (counterclockwise), and then begin sewing around the edge of the appliqué, making sure that the needle drops just outside of the appliqué.

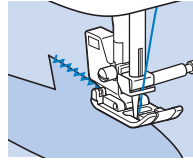

When sewing around corners, stop the machine with the needle in the fabric just outside of the appliqué, raise the presser foot lever, and then turn the fabric as needed to change the sewing direction.

■ Patchwork (crazy quilt) stitching

1 Fold the edge of the top piece of fabric and place it over the lower piece.

2 Attach zigzag foot “J”.

3 Select a stitch.

- The stitches shown below are examples. Select the desired stitch.



- * Stitches may differ depending on the model. Check stitch selections on the machine’s body, and then select the stitch number.

4 Sew the two pieces of fabric together so the stitch pattern spans over both pieces.

Use pins if necessary.

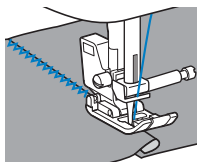

⚠ CAUTION

- Do not stitch over pins.

■ Piecing

Sewing together two pieces of fabric is called “piecing”. The fabric pieces should be cut with a 6.5 mm (1/4 inch) seam allowance.

Sew a piecing straight stitch 6.5 mm (1/4 inch) from either the right side or the left side of the presser foot.

1 Baste or pin along the seam allowance of the fabric that you wish to piece together.

2 Attach zigzag foot “J”.

3 Select a stitch.



* Check the stitch number on the machine’s body, and set the machine for that stitch.

4 Sew with the side of the presser foot aligned with the edge of the fabric.

□ **For a seam allowance on the right side**

Align the edge of the fabric with the right side of the presser foot, and set the stitch width 5.5 mm (7/32 inch) and sew using

stitch .

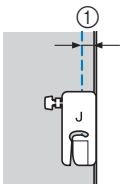

① 6.5 mm (1/4 inch)

□ **For a seam allowance on the left side**

Align the left side of the presser foot with the edge of the fabric, and set the stitch width

1.5 mm (1/16 inch) and sew using stitch .

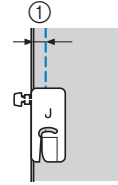

① 6.5 mm (1/4 inch)

Memo

- To change the width of the seam allowance (needle position), adjust the stitch width. For details, refer to “Setting the stitch length and stitch width” on the Operation Manual and “Sewing an Even Seam Allowance” on page 7.

■ Quilting

Sandwiching batting between the top and bottom layers of fabric is called “quilting”. Quilts can easily be sewn using the walking foot* and the quilting guide*.

* Items sold separately, please contact your authorized Brother dealer.

💡 Note

- Thread the needle manually when using the walking foot, or attach the walking foot only after threading the needle using the needle threader.
- When quilting, use a 90/14 home sewing machine needle.
- The walking foot can only be used with straight or zigzag stitch patterns. Do not sew reverse stitches with the walking foot.
- When sewing with the walking foot, sew at a speed between slow and medium.
- When using the walking foot, test sew on a scrap piece of fabric that is to be used in project.

- 1 Baste the fabric to be quilted.**
- 2 Remove the presser foot and the presser foot holder.**
 - For details, refer to “Replacing the presser foot” on the Operation Manual.
- 3 Hook the connecting fork of the walking foot onto the needle clamp screw.**

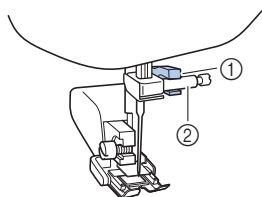

- ① Connecting fork
- ② Needle clamp screw

- 4 Lower the presser foot lever, and then tighten the presser foot holder screw with the screwdriver.**

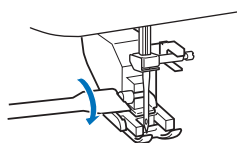

⚠ CAUTION

- Be sure to securely tighten the screws with the screwdriver, otherwise the needle may touch the presser foot, causing it to bend or break.
- Before starting to sew, slowly turn the handwheel toward you (counterclockwise) and check that the needle does not touch the presser foot. If the needle hits the presser foot, the needle may bend or break.

- 5 Select a stitch.**



- * Stitches may differ depending on the model. Check stitch selections on the machine’s body, and then select the stitch number.
- * When none of the above stitches is available, select “”, and at the beginning and end of sewing, pull the upper thread to the wrong side of the fabric, and then tie it with the bobbin thread.
- * Do not use reverse stitching and automatic reverse/reinforcement stitching.

- 6 Place one hand on each side of the presser foot, and then evenly guide the fabric while sewing.**

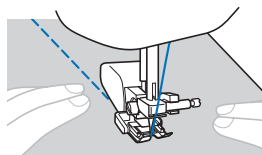

Using the quilting guide (sold separately)

Use the quilting guide to sew parallel stitches that are equally spaced.

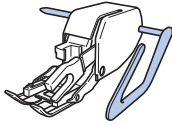
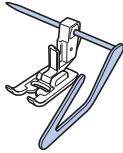
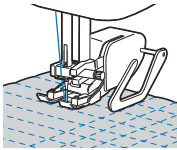
1 **Insert the stem of the quilting guide into the hole at the rear of the walking foot or presser foot holder.** **Walking foot** **Presser foot holder****2** **Adjust the stem of the quilting guide so that the guide aligns with the seam that has already been sewn.**

■ Free motion quilting

We recommend attaching the foot controller and sewing at a consistent speed.

(For models equipped with the sewing speed controller on the machine)

You can adjust the sewing speed with the sewing speed controller on the machine.

⚠ CAUTION

- **With free motion quilting, control the feeding speed of the fabric to match the sewing speed. If the fabric is moved faster than the sewing speed, the needle may break or other damage may result.**

The quilting foot* is used for free motion quilting with zigzag or decorative stitches or for free motion quilting of straight lines on fabric with an uneven thickness.

* Items sold separately, please contact your authorized Brother dealer.

□ Quilting foot

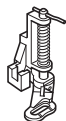

- 1 Slide the feed dog position switch, located at the rear of the machine on the base, to  (to the left as seen from the rear of the machine).

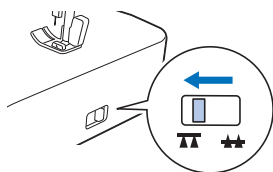

→ The feed dogs are lowered.

- 2 Select a stitch.



- * Stitches may differ depending on the model. Check stitch selections on the machine's body, and then select the stitch number.
- * When none of the above stitches is available, select "  ", and at the beginning and end of sewing, pull the upper thread to the wrong side of the fabric, and then tie it with the bobbin thread.
- * Do not use reverse stitching and automatic reverse/reinforcement stitching.

- 3 Remove the presser foot and the presser foot holder.

- When removing the presser foot holder, turn off the machine. For details, refer to the Operation Manual.

- 4 Attach the quilting foot by positioning the pin of the quilting foot above the needle clamp screw and aligning the lower-left of the quilting foot and the presser bar.

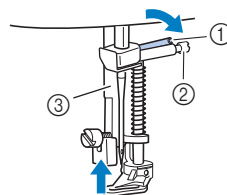

- ① Pin
- ② Needle clamp screw
- ③ Presser bar

💡 Note

- Make sure that the quilting foot is not slanted.

- 5** Hold the quilting foot in place with your right hand, and tighten the presser foot holder screw using the screwdriver with your left hand.

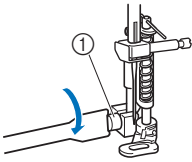

① Presser foot holder screw

⚠ CAUTION

- Be sure to securely tighten the screws with the included screwdriver. Otherwise, the needle may touch the quilting foot, causing it to bend or break.

- 6** Use both hands to hold the fabric taut, and then move the fabric at a consistent pace in order to sew uniform stitches roughly 2.0 mm - 2.5 mm (approx. 1/16 inch - 3/32 inch) in length.

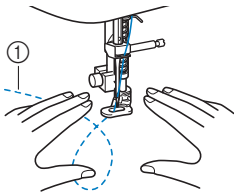

① Stitch

- 7** After sewing is finished, slide the feed dog position switch lever to **▲▲** (to the right as seen from the rear of the machine) and turn the handwheel to raise the feed dogs.

Other Stitching Applications

■ Elastic attaching

When elastic tape is attached to the cuff or waist of a piece of clothing, the finished dimensions will be that of the stretched elastic tape. Therefore, it is necessary that a suitable length of the elastic tape be used.

1 Pin the elastic tape to the wrong side of the fabric.

Pin the elastic tape to the fabric at a few points to make sure that the tape is uniformly positioned on the fabric.

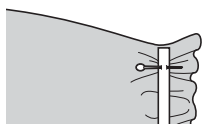

2 Attach zigzag foot "J".

3 Select a stitch.



- * Check the stitch number on the machine's body, and set the machine for that stitch.

4 Sew the elastic tape to the fabric while stretching the tape so that it is the same length as the fabric.

While pulling the fabric behind the presser foot with your left hand, pull the fabric at the pin nearest the front of the presser foot with your right hand.

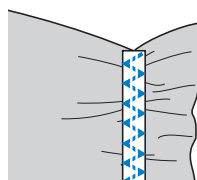
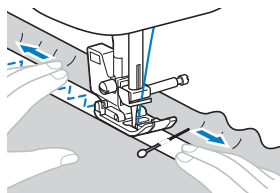

⚠ CAUTION

- When sewing, be sure that the needle does not touch any pins, otherwise the needle may bend or break.

■ Bar tack stitching

Available on models with the following stitch.



Bar tacks are used to reinforce points subject to strain, such as pocket corners and openings.

As an example, the procedure for sewing bar tacks at pocket corners is described below.

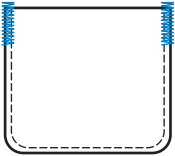

1 Determine the length of the bar tack.

Set the button guide plate on buttonhole foot "A" to the length of the bar tack. (The distance between the markings on the presser foot scale is 5 mm (3/16 inch).)

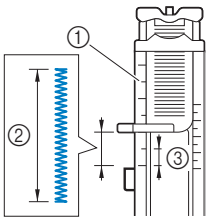

- ① Presser foot scale
- ② Length of bar tack
- ③ 5 mm (3/16 inch)

- A bar tack with a maximum length of about 28 mm (1-1/8 inches) can be sewn.

2 Attach buttonhole foot "A".

Before attaching the buttonhole foot "A", pass the upper thread underneath the presser foot through the hole.

3 Select a stitch.



- * Check the stitch number on the machine's body, and set the machine for that stitch.

4 Position the fabric so that the opening of the pocket faces toward you, and then lower the presser foot lever so that the needle drops 2 mm (1/16 inch) in front of the pocket opening.

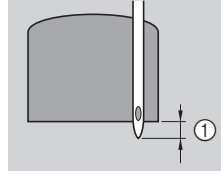

- ① 2 mm (1/16 inch)

5 Pull down the buttonhole lever as far as possible.

6 Gently hold the end of the upper thread in your left hand, and then start sewing.

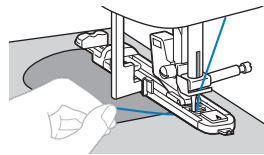

7 After sewing is finished, raise the presser foot lever, remove the fabric, and then cut the threads.

8 Raise the buttonhole lever to its original position.

■ **Fagoting**

Available on models with the following stitches.



Stitching across an open seam is called “fagoting”. It is used on blouses and children's clothing. This stitch is more decorative when thicker thread is used.

- 1** Use an iron to fold the two pieces of fabric along their seams.
- 2** Baste the two pieces of fabric, separated by about 4 mm (3/16 inch), onto thin paper or a sheet of water soluble stabilizer.
If you draw a line down the middle of the thin paper, or water soluble stabilizer, sewing is easier.

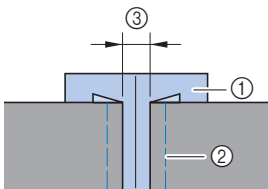

- ① Thin paper or water soluble stabilizer
- ② Basting stitching
- ③ 4 mm (3/16 inch)

- 3** Attach zigzag foot “J”.
- 4** Select a stitch.

 - * Stitches may differ depending on the model. Check stitch selections on the machine’s body, and then select the stitch number.
- 5** Set the stitch width to 7.0 mm (1/4 inch).

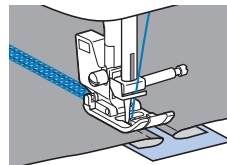
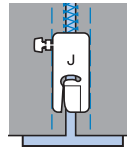
- 6** Sew with the center of the presser foot aligned along the center of the two pieces of fabric.



- 7** After sewing is finished, remove the paper.

■ Scallop stitching

Available on models with the following stitch.



The wave-shaped repeated stitch pattern that looks like shells is called “scalloping”. It is used on the collars of blouses and to decorate the edges of projects.

1 Attach monogramming foot “N”.

2 Select a stitch.



- * Check the stitch number on the machine’s body, and set the machine for that stitch.

3 Stitch along the edge of the fabric, making sure not to sew directly on the edge of the fabric.

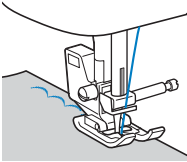

4 Trim along the stitches.

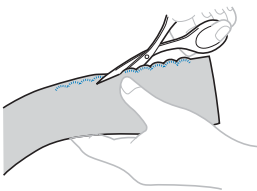

- Be careful not to cut the stitches.

■ **Smocking**

Available on models with the following stitches.



The decorative stitch created by stitching or embroidering over gathers is called “smocking”. It is used to decorate the front of blouses or cuffs.

The smocking stitch adds texture and elasticity to fabric.

- 1 Attach zigzag foot “J”.
- 2 Select the straight stitch, and then adjust the stitch length to 4.0 mm (3/16 inch) and loosen the thread tension.
- 3 Sew parallel stitching at intervals of 1 cm (3/8 inch) and pull the bobbin threads to create gathers.

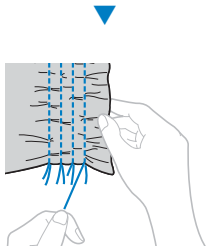
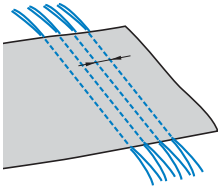

- 4 Select a stitch.



* Stitches may differ depending on the model. Check stitch selections on the machine’s body, and then select the stitch number.

- 5 **Stitch between the straight stitches and pull out the threads for the straight stitches.**

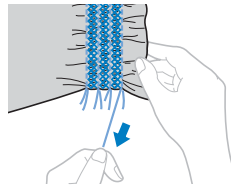
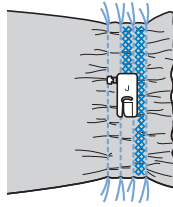

■ Shell tuck stitching

Available on models with the following stitch.



The gathers that look like shells are called “shell tucks”. They are used to decorate trims, the front of blouses or cuffs made of thin fabrics.

- 1 Draw equally spaced lines along the bias, and then fold the fabric along the lines.**

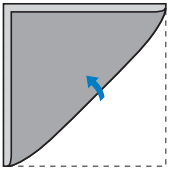

- 2 Attach zigzag foot “J”.**

- 3 Select a stitch, and then increase the thread tension.**



* Check the stitch number on the machine’s body, and set the machine for that stitch.

- 4 Sew while making sure that the needle drops slightly off the edge of the fabric.**

One fold at a time, continue folding the fabric along the line, then sewing it.

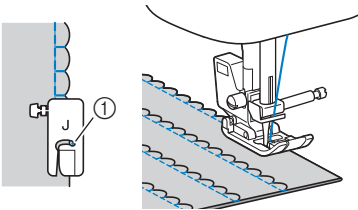

① Needle drop point

- 5 After sewing is finished, remove the fabric. Unfold the fabric, and then iron the tucks down to one side.**

■ Joining

Available on models with the following stitches.



Decorative bridging stitches can be sewn over the seam allowance of joined fabrics. This is used when making a crazy quilt.

- 1 **Attach zigzag foot “J”.**
- 2 **Sew together the right sides of the two pieces of fabric, and then open up the seam allowances.**

- 3 **Select a stitch.**



- * Stitches may differ depending on the model. Check stitch selections on the machine's body, and then select the stitch number.

- 4 **Turn the fabric over so that the right side faces up, and then sew over the seam with the center of the presser foot aligned with the seam.**

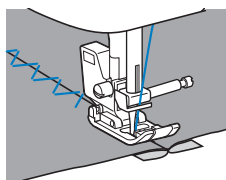

■ Heirloom stitching

(for models equipped with the monogramming foot “N”)

When sewing with the wing needle, the needle holes are enlarged, creating a lace-like decorative stitch. This is used to decorate hems and tablecloths on thin or medium weight fabrics in addition to plain weave fabrics.

1 Install the wing needle.



- Use a 130/705H 100/16 wing needle.
- For details on replacing a needle, refer to the Operation Manual.
- The needle threader cannot be used with the wing needle, otherwise the machine may be damaged. Manually pass the thread through the eye of the needle from the front to the back.

2 Attach monogramming foot “N”.

3 Select a stitch.



- * Stitches may differ depending on the model. Check stitch selections on the machine’s body, and then select the stitch number.

4 Start sewing.

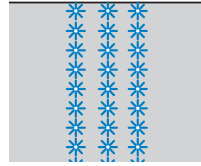

⚠ CAUTION

- When sewing with the wing needle, select a stitch width of 6.0 mm (15/64 inch) or less, otherwise the needle may bend or break.
- After adjusting the stitch width, slowly turn the handwheel toward you (counterclockwise) and check that the needle does not touch the presser foot. If the needle hits the presser foot, the needle may bend or break.

MAKING ADJUSTMENT

(Available on models with 25 or more stitches.)
 Your stitch pattern may sometimes turn out poorly, depending on the type or thickness of fabric, the stabilizer material used, sewing speed, etc. If your sewing does not turn out well, sew trial stitches using the same conditions as the real sewing, and adjust the stitch pattern as explained below. If the stitch pattern does not turn out well even after making adjustments based on the stitch pattern described below, make adjustments for each stitch pattern individually.

Memo

- This adjustment can be made to  (Quilting stippling stitch), decorative stitches, satin stitches and cross stitches. For details on the built-in stitch patterns, refer to "Stitch Chart" (<http://s.brother/cmkg/>).

- 1 Turn off the machine.**
- 2 Holding down the key ①, turn on the machine.**
- 3 After the machine has turned on, release the key ①.**
 → The display changes to the stitch adjustment display.
- 4 Adjust stitches with the stitch length keys.**

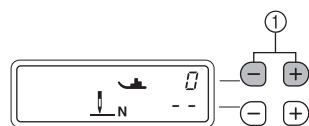

① Stitch length keys

- If the stitch pattern is bunched:
 Press the "+" stitch length key several times.

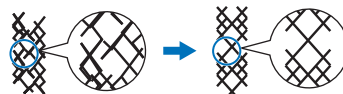

- If the stitch pattern has gaps:
 Press the "-" stitch length key several times.

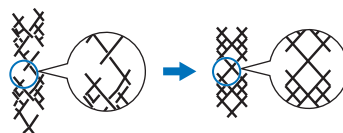

- 5 Sew the stitch pattern again.**
 - * If the stitch pattern still comes out poorly, make adjustments again until the stitch pattern comes out correctly.

Note

- Sewing speed controller cannot be used with this stitch pattern.

INDEX

A	
Appliqué	31
B	
Bar tack stitch	39
Basic stitching	17
Blind hem stitch	20
Button sewing	27
Buttonhole	23
C	
Cylindrical pieces	6
D	
Denim	10
E	
Elastic tape	38
Even seam allowance	7
F	
Fabric	10
Fagoting	40
Feed dog position switch	36
Free motion quilting	36
H	
Heirloom stitching	45
Hook-and-loop fastener tape	14
J	
Joining	44
L	
Leather	13
N	
Needle position	7, 17
O	
Overcasting stitches	18
P	
Patchwork	32
Piecing	33
Q	
Quilting	34
Quilting guide	35
S	
Scallop stitching	41
Shell tuck stitch	43
Smocking	42
Stretch fabrics	12
T	
Thick fabrics	10
Thin fabrics	11
V	
Vinyl fabrics	13
W	
Walking foot	34
Wing needle	45
Z	
Zipper	29

Please visit us at <http://s.brother/cpkag/> where you can get the support information (Sewing Guide, Stitch Chart, Instruction Videos, FAQs, etc.) for your Brother product.



To get information about Videos, please go to <http://s.brother/cvkag/>.



Brother SupportCenter is a mobile app that provides the support information (Instruction Videos, FAQs, etc.) for your Brother product. Visit the Google Play™ or App Store to download.



Google Play™



App Store

Trademarks

App Store is a service mark of Apple Inc.

Android and Google Play are trademarks of Google, Inc.

Use of these trademarks are subject to Google Permissions.