

brother

Embroidery Design Guide
Guide till broderimönster
Broderidesign oversigt
Příručka k navrhování výšivek
Hímzésminta-útmutató
Przewodnik projektowania haftów
Catalog cu modele de broderii

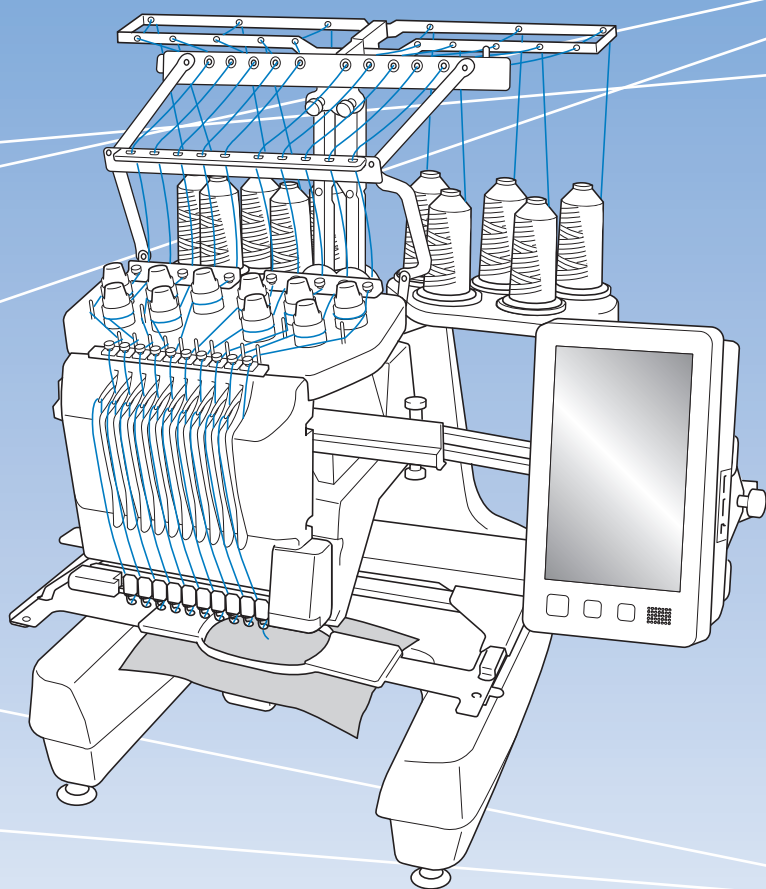

Note

Embroidery time and size of each design in this guide may differ from the information on the machine display. Please use as a reference purpose only.

Obs!

Broderitid och storlek på varje design i denna guide kan skilja sig från informationen på maskinens display. Använd endast som referensändamål.

Bemærk

BrodeBroderitiden og størrelsen af de enkelte mønstre i denne guide kan variere fra oplysningerne i maskinens display. Disse oplysninger er kun vejledende.

Poznámka

Doba vyšívání a velikost jednotlivých návrhů v tomto průvodci se může lišit od informací na displeji stroje. Používejte pouze pro orientaci.

Megjegyzés

Az útmutatóban megjelenő hímzési idők és mintaméretek eltérhetnek a gép kijelzőjén megjelenő információktól. Csak referenciaként használja.

Uwaga

Czas wykonania i rozmiar poszczególnych wzorów w niniejszej instrukcji może się różnić od informacji na wyświetlaczu maszyny. Dane te mają charakter jedynie poglądowy.

Notă

Timpul de coasere și dimensiunea de brodată a fiecărui model din acest ghid pot să difere față de informațiile afișate pe ecranul mașinii. Vă rugăm să folosiți aceste informații numai în scop informativ.

Contents

Summary of Embroidery Patterns	3
Pattern type selection screen	3
Embroidery Patterns	3
Frame Patterns	5
Utility embroidery patterns / Large buttonhole patterns	6
Monograms	7
Character patterns	8
Decorative Alphabet Patterns	19
Quilting border patterns	23
Embroidery Pattern Color Change Table	24
Embroidery Patterns	24
Utility embroidery patterns / Large buttonhole patterns	41
Monograms	46
Decorative Alphabet Patterns	48
Examples of Combinations	87
Font Name Chart	95

Innehåll

Översikt över broderimönster	3
Skärmen för val av mönstertyp	3
Broderimönster	3
Rammönster	5
Brodemönster/ Stora knapphålmönster	6
Monogram	7
Monogrammönster	8
Dekoratitiv alfabete-mönster	19
Mönster för quiltningsram	23
Broderimönster färgändringstabell	24
Broderimönster	24
Brodemönster/ Stora knapphålmönster	41
Monogram	46
Dekoratitiv alfabete-mönster	48
Exempel på kombinationer	87
Tabell över namn på teckensnitt	95

Indholdsfortegnelse

Oversigt over broderimønstre	3
Skærm til valg af mønstertype	3
Broderimønstre	3
Rammemønstre	5
Nyttestingsbroderimønstre/ Store knapphålmønstre	6
Monogrammer	7
Bogstaver	8
Mønstre med dekorativt alfabet	19
Quiltekantmønstre	23
Oversigt over mønstrenes farveskift	24
Broderimønstre	24
Nyttestingsbroderimønstre/ Store knapphålmønstre	41
Monogrammer	46
Mønstre med dekorativt alfabet	48
Eksempler på kombinationer	87
Skema over skrifttypernavne	95

Obsah

Shrnutí vyšivacích vzorů	3
Obrazovka pro výběr typu vzoru	3
Vzory vyšívání	3
Vzor rámečků	5
Užitné vyšivací vzory/ Vzory pro velkou knoflíkovou díрку	6
Monogramy	7
Znakové vzory	8
Vzory dekorativní abecedy	19
Prošívání bordurových vzorů	23
Tabulka s variantami barev vyšivacích vzorů	24
Vzory vyšívání	24
Užitné vyšivací vzory/ Vzory pro velkou knoflíkovou díрку	41
Monogramy	46
Vzory dekorativní abecedy	48
Příklady kombinací	87
Tabulka s názvy písem	95

Tartalomjegyzék

A hímzésminták összefoglalása	3
Mintatípus-választó képernyő	3
Hímzésminták	3
Keretminta	5
Hasznos öltés hímzésmintához/ Minta nagy gomblyukhoz	6
Monogramok	7
Karakter minták	8
Dekorációs ábécé minták	19
Steppelt szegélyminták	23
A hímzésminták színcsere-táblázata	24
Hímzésminták	24
Hasznos öltés hímzésmintához/ Minta nagy gomblyukhoz	41
Monogramok	46
Dekorációs ábécé minták	48
Példák a különböző kombinációkra	87
Betűtípus-névtáblázat	95

Spis treści

Podsumowanie wzorów haftów	3
Ekran wyboru rodzaju ściegu	3
Wzory haftu	3
Wzór ramki	5
Wzory haftów użytkowych/ Wzory obszycia dużej dziurki na guzik	6
Monogramy	7
Wzory liter	8
Wzory alfabetu dekoracyjnego	19
Wzory obrzeży pikowanych	23
Tabela zmiany kolorów wzorów haftów	24
Wzory haftu	24
Wzory haftów użytkowych/ Wzory obszycia dużej dziurki na guzik	41
Monogramy	46
Wzory alfabetu dekoracyjnego	48
Przykłady połączeń	87
Tabela nazw czcionek	95

Cuprins

Sumarul modelelor de broderie	3
Ecran de selectare a tipului de model	3
Modele de broderie	3
Model de chenar	5
Modele de broderie utilitară/ Modele de butonieră mare	6
Monograme	7
Modele de caractere	8
Modele cu alfabet decorativ	19
Modele pentru matlasarea bordurilor	23
Tabel de modificare a culorilor modelului de broderie	24
Modele de broderie	24
Modele de broderie utilitară/ Modele de butonieră mare	41
Monograme	46
Modele cu alfabet decorativ	48
Exemple de combinații	87
Diagrama cu numele fonturilor	95

Summary of Embroidery Patterns Översikt över broderimönster Oversigt over broderimønstre Shrnutí vyšívacích vzorů A hímzsminták összefoglalása Podsumowanie wzorów haftów Sumarul modelelor de broderie

- ◆ Pattern type selection screen
- ◆ Skærm til valg af mønstertype
- ◆ Mintatípus-választó képernyő
- ◆ Ecran de selectare a tipului de model

- ◆ Skärmen för val av mönstertyp
- ◆ Obrazovka pro výběr typu vzoru
- ◆ Ekran wyboru rodzaju ściegu

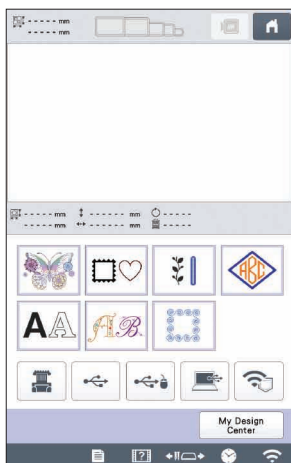

- ◆ Embroidery Patterns
- ◆ Broderimønstre
- ◆ Hímzsminták
- ◆ Modele de broderie

- ◆ Broderimönster
- ◆ Vzory vyšívání
- ◆ Wzory haftu

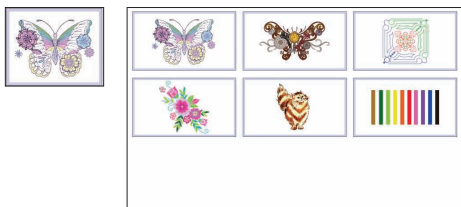

- "Featured" Designs
- Udvalgte-designs
- „Kiemelt” minták
- Modele promovate

- Utvalda mönster
- Propagované návrhy
- Wzory „Wyróżnione”

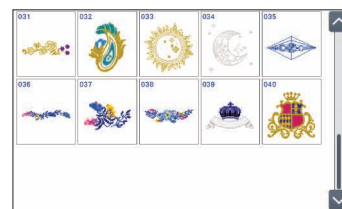

- "Steam Punk" Designs
- "Steam Punk"-design
- „Steam Punk” minták
- Modele „Steam Punk”

- Steampunk-mönster
- Návrhy Steam Punk
- Wzory „Steam Punk”



- "Quilt" Designs
- "Quilt"-design
- „Steppelt” minták
- Modele pentru matlasat



- Quiltningsmönster
- Návrhy prošívání
- Wzory „Projekt pikowania”



- "Craft" Designs
- Hobby mønstre
- „Művészi” minták
- Modele „Artă”

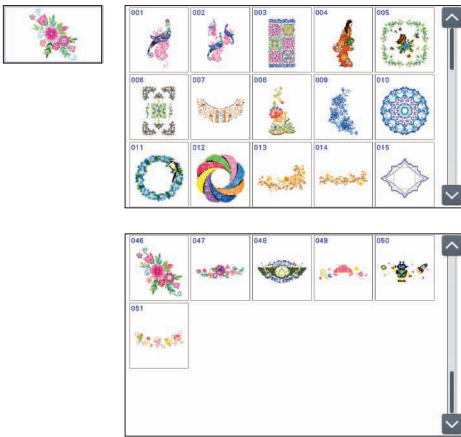

- Hobbymönster
- Řemeslné designy
- Wzory „Artystyczne”



- "Variety" Designs
- Mange forskellige broderier
- „Egyéb” minták
- Modele „Varietate”

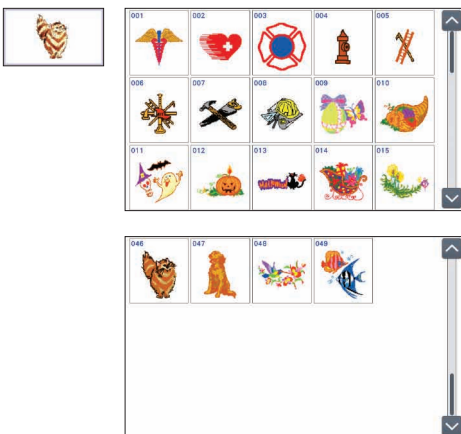

- Varierande designer
- Pestré designy
- Wzory „Różne”



- Common Design Patterns
- Test broderier
- Általános mintázatok
- Modele utilizate frecvent

- Vanliga designmönster
- Běžné vzory designů
- Typowe wzory haftu

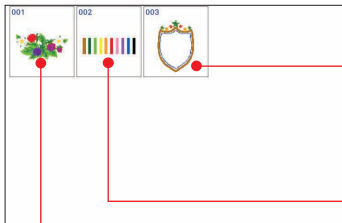

For tutorial practice
 För övning
 Til prøvesyning
 Pro praktické cvičení
 Gyakorláshoz
 Praktyczna nauka
 Pentru exersarea practicilor din cursul introductiv

For tutorial practice of embroidering appliqué
 För övningar i att brodera applikationer
 Til prøvesyning af applikationsbroderi
 Cvičení vyšívání aplikace
 A rátétminták hímzésének gyakorlásához
 Do ćwiczeń podczas nauki haftowania aplikacji
 Pentru noțiuni introductive despre brodarea aplicațiilor

For checking the thread tension
 För kontroll av trådspänningen
 Til kontrol af trådspænding
 Pro kontrolu napětí niti
 A szálfeszesség ellenőrzéséhez
 Aby sprawdzić naprężenie nici
 Pentru a verifica tensiunea firului

- ◆ Frame Patterns
- ◆ Rammemønstre
- ◆ Keretminta
- ◆ Model de chenar

- ◆ Rammönster
- ◆ Vzor rámečků
- ◆ Wzór ramki

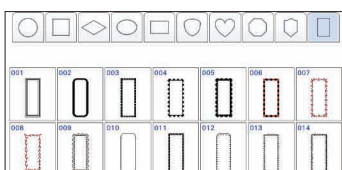
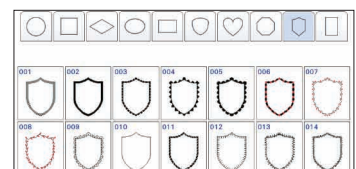
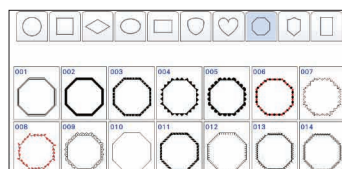
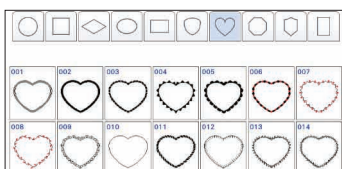
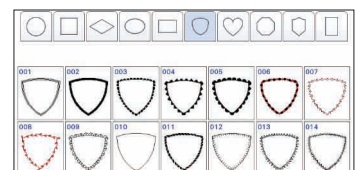
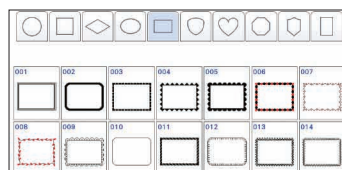
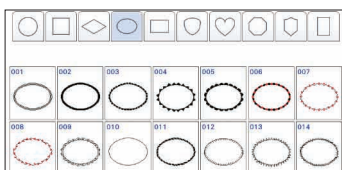
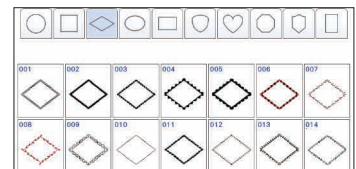
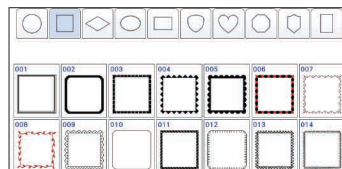
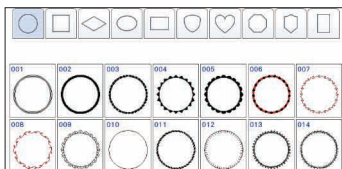
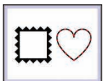

- ◆ Utility embroidery patterns / Large buttonhole patterns
- ◆ Nyttestingsbroderimønstre/ Store knaphulsmønstre
- ◆ Hasznos öltés hímzésmintához/ Minta nagy gomblyukhoz
- ◆ Modele de broderie utilitară/ Modele de butonieră mare

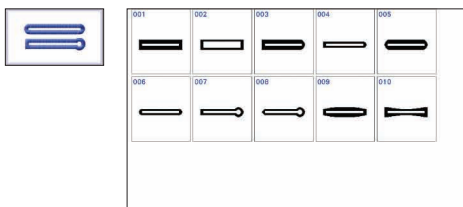
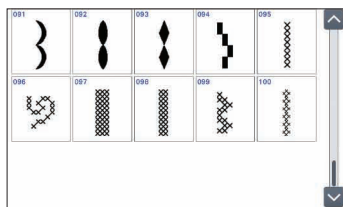
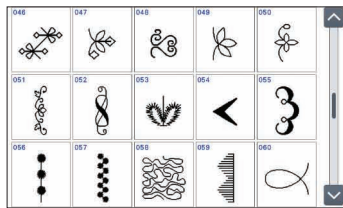
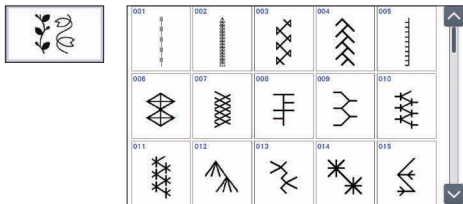
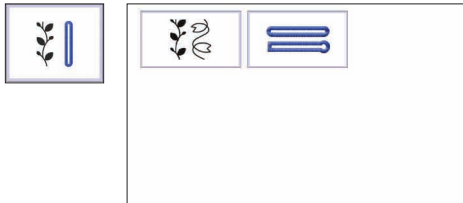

- ◆ Brodermönster/ Stora knaphålsmönster
- ◆ Užiténé vyšívací vzory/ Vzory pro velkou knoflíkovou díрку
- ◆ Wzory haftów użytkowych/ Wzory obszycia dużej dziurki na guzik

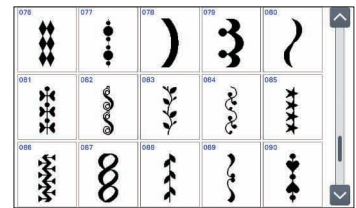
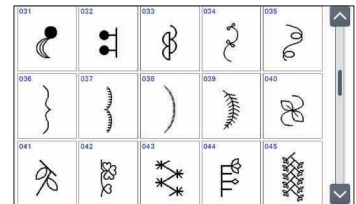
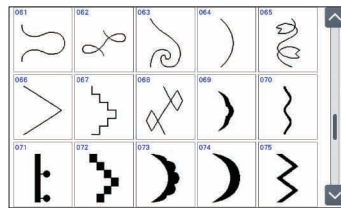
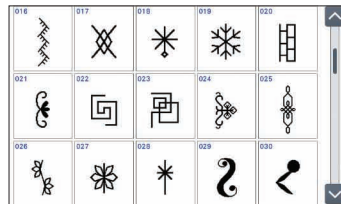

- ◆ Monograms
- ◆ Monogrammer
- ◆ Monogramok
- ◆ Monogramme

- ◆ Monogram
- ◆ Monogramy
- ◆ Monogramy

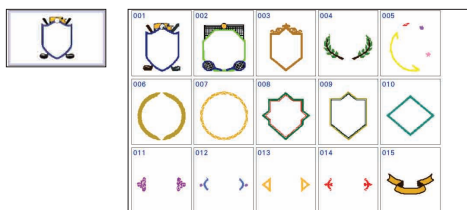
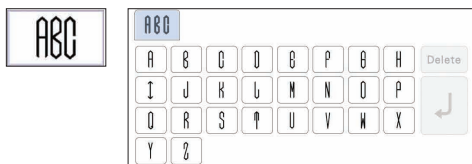
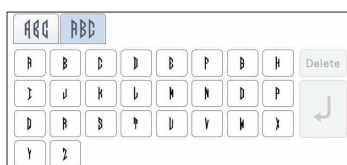
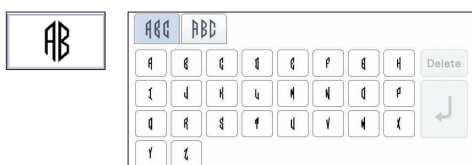
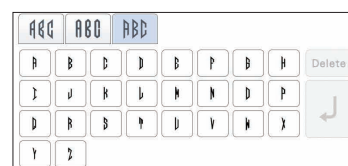
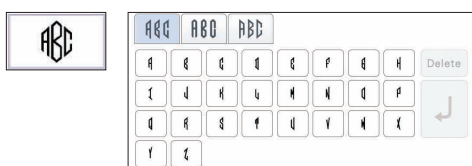
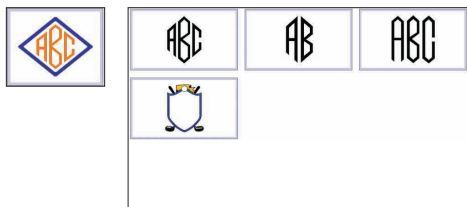

- *Monogram frames
- *Monogram-rammer
- *Monogram keretek
- *Modele cu monogramme

- *Monogramramar
- *Rámečky pro monogramy
- *Ramki do monogramów

- ◆ Character patterns
- ◆ Bogstaver
- ◆ Karakter minták
- ◆ Modele de caractere

- ◆ Monogrammönster
- ◆ Znakové vzory
- ◆ Wzory liter



00	<i>ABC</i>				01	ABC	
02	ABC	03	ABC	04	ABC	05	ABC
06	ABC	07	ABC	08	ABC	09	ABC
32	<i>ABCDEF</i>		33	ABCDEFGH			
34	あいう	35	あいう	36	あいう		

10	<i>ABC</i>	11	<i>ABC</i>	12	<i>ABC</i>	13	<i>ABC</i>
14	<i>ABC</i>	15	<i>ABC</i>	16	<i>ABC</i>	17	<i>ABC</i>
18	<i>ABC</i>	19	<i>ABC</i>	20	<i>ABC</i>	21	<i>ABC</i>

22	<i>ABC</i>	23	<i>ABC</i>	24	<i>ABC</i>	25	<i>ABC</i>
26	<i>ABB</i>	27	<i>ABB</i>				
28	ABCDE	29	ABCDE	30	ABCDE	31	ABCDE



ABC	abc	0-9..	&?!	ÁÁá	ÑÑñ	Delete
<i>A B C D E F G H</i>	<i>I J K L M N O P</i>	<i>Q R S T U V W X</i>	<i>Y Z</i>			

ABC	abc	0-9..	&?!	ÁÁá	ÑÑñ	Delete
<i>a b c d e f g h</i>	<i>i j k l m n o p</i>	<i>q r s t u v w x</i>	<i>y z</i>			

ABC	abc	0-9..	&?!	ÁÁá	ÑÑñ	Delete
<i>0 1 2 3 4 5 6 7</i>	<i>8 9 # % & € ¥</i>	<i>- + * / = . ,</i>				

ABC	abc	0-9..	&?!	ÁÁá	ÑÑñ	Delete
<i>g p / @ < > / /</i>	<i>/ / / \ ~ . . @</i>	<i>@ # " " " ' ' ' .</i>				

ABC	abc	0-9..	&?!	ÁÁá	ÑÑñ	Delete
<i>A A A A à á â ã</i>	<i>ä å æ Ç ç Đ È É</i>	<i>Ê Ë è é ê ë Í Ì</i>	<i>Î ï ÿ</i>			

ABC	abc	0-9..	&?!	ÁÁá	ÑÑñ	Delete
<i>N N ñ ò ó ô õ ø ö œ</i>	<i>ƒ ŧ Ũ ů ù ú û ü ž</i>	<i>Ɔ ɔ ɒ ɓ ɔ ɔ ɔ</i>				

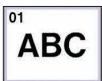

ABC	abc	0-9..	&?!	ÁÁá	ÑÑñ	Delete
A B C D E F G H	I J K L M N O P	Q R S T U V W X	Y Z			

ABC	abc	0-9..	&?!	ÁÁá	ÑÑñ	Delete
a b c d e f g h	i j k l m n o p	q r s t u v w x	y z			

ABC	abc	0-9..	&?!	ÁÁá	ÑÑñ	Delete
0 1 2 3 4 5 6 7	8 9 # % \$ £ € ¥	- + * / = . ,				

ABC	abc	0-9..	&?!	ÁÁá	ÑÑñ	Delete
& ? ! @ < > ()	[] / \ ~ : ; ©	® ™ " " " ' ' ' .				

ABC	abc	0-9..	&?!	ÁÁá	ÑÑñ	Delete
Â Ã Ä Å Æ à á â ã	ä å æ Ç ç Đ È É	Ê Ë è é ê ë Í Ì	Î ï ÿ			

ABC	abc	0-9..	&?!	ÁÁá	ÑÑñ	Delete
Ñ Ñ ñ Ò Ó Ø Ó Œ	ò ó ô õ ø ö œ ƒ	ŧ Ũ ů ù ú û ü ž	Ɔ ɔ ɒ ɓ ɔ ɔ			

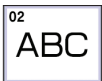

ABC	abc	0-9..	&?!	ÁÁá	ÑÑñ	Delete
A B C D E F G H	I J K L M N O P	Q R S T U V W X	Y Z			

ABC	abc	0-9..	&?!	ÁÁá	ÑÑñ	Delete
a b c d e f g h	i j k l m n o p	q r s t u v w x	y z			

ABC	abc	0-9..	&?!	ÁÁá	ÑÑñ	Delete
0 1 2 3 4 5 6 7	8 9 # % \$ £ € ¥	- + * / = . ,				

ABC	abc	0-9..	&?!	ÁÁá	ÑÑñ	Delete
Œ ? ! @ < > ()	[] / \ ~ : ; ©	® ™ " " " ' ' ' .				

ABC	abc	0-9..	&?!	ÁÁá	ÑÑñ	Delete
Â Ã Ä Å Æ à á â ã	ä å æ Ç ç Đ È É	Ê Ë è é ê ë Í Ì	Î ï ÿ			

ABC	abc	0-9..	&?!	ÁÁá	ÑÑñ	Delete
Ñ Ñ ñ Ò Ó Ø Ó Œ	ò ó ô õ ø ö œ ƒ	ŧ Ũ ů ù ú û ü ž	Ɔ ɔ ɒ ɓ ɔ ɔ			

Summary of Embroidery Patterns
 Oversigt over broderimønstre
 A hímzéminták összefoglalása
 Sumarul modelelor de broderie

Översikt över broderimönster
 Shrnutí vyšívacích vzorů
 Podsumowanie wzorów haftów

03
ABC

ABC	abc	0-9..	&?!	ÁÁá	NÑh			
A	B	C	D	E	F	G	H	Delete
I	J	K	L	M	N	O	P	↵
Q	R	S	T	U	V	W	X	
Y	Z							↵

ABC	abc	0-9..	&?!	ÁÁá	NÑh			
&	?	!	@	<	>	()	Delete
¡	í	/	\	~	:	:	©	↵
®	™	“	”	”	’	’	’	↵

ABC	abc	0-9..	&?!	ÁÁá	NÑh			
a	b	c	d	e	f	g	h	Delete
i	j	k	l	m	n	o	p	↵
q	r	s	t	u	v	w	x	
y	z							↵

ABC	abc	0-9..	&?!	ÁÁá	NÑh			
À	Ä	Å	Æ	à	á	â	ã	Delete
ä	å	æ	Ç	ç	Đ	È	É	↵
Ê	Ë	è	é	ê	ë	Ĝ	ğ	↵
Í	İ	ı	ı	ı	ı	ı	ı	-

ABC	abc	0-9..	&?!	ÁÁá	NÑh			
0	1	2	3	4	5	6	7	Delete
8	9	#	%	\$	£	€	¥	↵
-	+	x	÷	=	*	.	,	↵

ABC	abc	0-9..	&?!	ÁÁá	NÑh			
Ñ	Ñ	ñ	Ö	Ö	ø	Õ	Œ	Delete
ò	ó	ô	õ	ø	œ	ř		↵
Ş	ş	ŕ	Ů	Ů	ů	ú	û	↵
ü	ı	þ	þ	ß				↵

04
ABC

ABC	abc	0-9..	&?!	ÁÁá	NÑh			
A	B	C	D	E	F	G	H	Delete
I	J	K	L	M	N	O	P	↵
Q	R	S	T	U	V	W	X	
Y	Z							↵

ABC	abc	0-9..	&?!	ÁÁá	NÑh			
&	?	!	@	<	>	()	Delete
¡	í	/	\	~	:	:	©	↵
®	™	“	”	”	’	’	’	↵

ABC	abc	0-9..	&?!	ÁÁá	NÑh			
a	b	c	d	e	f	g	h	Delete
i	j	k	l	m	n	o	p	↵
q	r	s	t	u	v	w	x	
y	z							↵

ABC	abc	0-9..	&?!	ÁÁá	NÑh			
À	Ä	Å	Æ	à	á	â	ã	Delete
ä	å	æ	Ç	ç	Đ	È	É	↵
Ê	Ë	è	é	ê	ë	İ	ı	↵
İ	ı	ı	ı	ı	ı	ı	ı	-

ABC	abc	0-9..	&?!	ÁÁá	NÑh			
0	1	2	3	4	5	6	7	Delete
8	9	#	%	\$	£	€	¥	↵
-	+	x	÷	=	*	.	,	↵

ABC	abc	0-9..	&?!	ÁÁá	NÑh			
Ñ	Ñ	ñ	Ö	Ö	ø	Õ	Œ	Delete
ò	ó	ô	õ	ø	œ	ř		↵
Ť	Ů	Ů	ů	ú	ú	ú	ž	↵
þ	þ	ß						↵

05
ABC

ABC	abc	0-9..	&?!	ÁÁá	NÑh			
A	B	C	D	E	F	G	H	Delete
I	J	K	L	M	N	O	P	↵
Q	R	S	T	U	V	W	X	
Y	Z							↵

ABC	abc	0-9..	&?!	ÁÁá	NÑh			
&	?	!	@	()	/	’	Delete

ABC	abc	0-9..	&?!	ÁÁá	NÑh			
a	b	c	d	e	f	g	h	Delete
i	j	k	l	m	n	o	p	↵
q	r	s	t	u	v	w	x	
y	z							↵

ABC	abc	0-9..	&?!	ÁÁá	NÑh					
À	Ä	Å	Æ	à	á	â	ã	Delete		
ä	å	æ	Ç	ç	è	é	ê	ë	ı	↵

ABC	abc	0-9..	&?!	ÁÁá	NÑh			
0	1	2	3	4	5	6	7	Delete
8	9	-	.	,				↵

ABC	abc	0-9..	&?!	ÁÁá	NÑh			
Ñ	ñ	Ö	ø	ò	ó	ø	Û	Delete
ù	ü	ß						↵

06
ABC

ABC	abc	0-9..	&?!	ÁÁá	NÑh			
A	B	C	D	E	F	G	H	Delete
I	J	K	L	M	N	O	P	↵
Q	R	S	T	U	V	W	X	
Y	Z							↵

ABC	abc	0-9..	&?!	ÁÁá	NÑh			
&	?	!	©	<	>	[]	Delete
¡	í	/	\	~	:	:	©	↵
©	™	os	pp	oo	o	6	9	↵

ABC	abc	0-9..	&?!	ÁÁá	NÑh			
a	b	c	d	e	f	g	h	Delete
i	j	k	l	m	n	o	p	↵
q	r	s	t	u	v	w	x	
y	z							↵

ABC	abc	0-9..	&?!	ÁÁá	NÑh			
À	Ä	Å	Æ	à	á	â	ã	Delete
ä	å	æ	Ç	ç	Đ	È	É	↵
Ê	Ë	è	é	ê	ë	Ĝ	ğ	↵
Í	İ	ı	ı	ı	ı	ı	ı	-

ABC	abc	0-9..	&?!	ÁÁá	NÑh			
0	1	2	3	4	5	6	7	Delete
8	9	#	%	\$	£	€	¥	↵
-	+	x	÷	=	*	.	,	↵

ABC	abc	0-9..	&?!	ÁÁá	NÑh			
Ñ	Ñ	ñ	Ö	Ö	ø	Õ	Œ	Delete
ò	ó	ô	õ	ø	œ	ř		↵
Ş	ş	ŕ	Ů	Ů	ů	ú	û	↵
ü	ı	þ	þ	ß				↵

07
ABC

ABC	abc	0-9..	&?!	ÁÁá	NÑh			
A	B	C	D	E	F	G	H	Delete
I	J	K	L	M	N	O	P	↵
Q	R	S	T	U	V	W	X	
Y	Z							↵

ABC	abc	0-9..	&?!	ÁÁá	NÑh			
a	b	c	d	e	f	g	h	Delete
i	j	k	l	m	n	o	p	↵
q	r	s	t	u	v	w	x	
y	z							↵

ABC	abc	0-9..	&?!	ÁÁá	NÑh			
0	1	2	3	4	5	6	7	Delete
8	9	#	%	\$	£	€	¥	↵
-	+	x	÷	=	*	.	,	↵

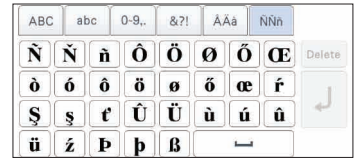

08
ABC

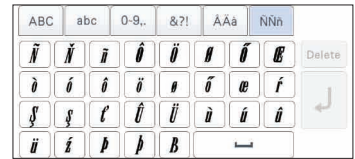

09
ABC

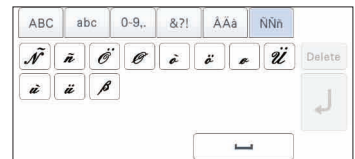
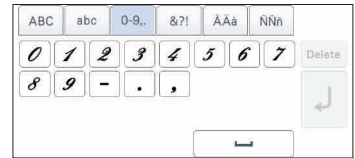
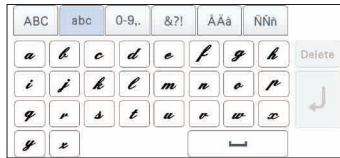

10
ABC

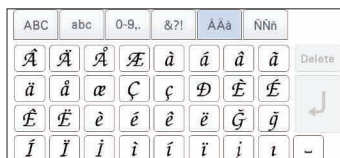

11
ABC

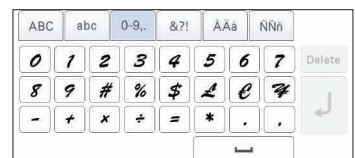
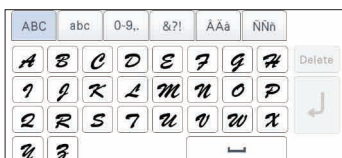

Summary of Embroidery Patterns
 Oversigt over broderimønstre
 A hímzéminták összefoglalása
 Sumarul modelelor de broderie

Översikt över broderimönster
 Shrnutí vyšívacích vzorů
 Podsumowanie wzorów haftów

12
 ABC

ABC	abc	0-9..	&?!	ÁÁá	ÑÑñ	Delete	
A	B	C	D	E	F	G	H
I	J	K	L	M	N	O	P
Q	R	S	T	U	V	W	X
Y	Z						

ABC	abc	0-9..	&?!	ÁÁá	ÑÑñ	Delete	
&	?	!	@	<	>	()
[]	/	\	~	:	:	©
®	™	"	"	"	'	'	'

ABC	abc	0-9..	&?!	ÁÁá	ÑÑñ	Delete	
a	b	c	d	e	f	g	h
i	j	k	l	m	n	o	p
q	r	s	t	u	v	w	x
y	z						

ABC	abc	0-9..	&?!	ÁÁá	ÑÑñ	Delete	
À	Á	Â	Æ	à	á	â	ä
å	ä	æ	ç	ç	ð	é	ë
ê	ë	è	é	é	ê	ë	ğ
í	ï	ï	ï	ï	ï	ï	-

ABC	abc	0-9..	&?!	ÁÁá	ÑÑñ	Delete	
0	1	2	3	4	5	6	7
8	9	#	%	\$	£	€	¥
-	+	x	+	=	*	.	,

ABC	abc	0-9..	&?!	ÁÁá	ÑÑñ	Delete	
Ñ	Ñ	ñ	Ò	Ò	ø	Ó	œ
ò	ó	ô	ö	ø	œ	í	
š	š	ř	Ů	Ů	ů	ů	à
ü	z	ß	ß	ß			

13
 ABC

ABC	abc	0-9..	&?!	ÁÁá	ÑÑñ	Delete	
A	B	C	D	E	F	G	H
I	J	K	L	M	N	O	P
Q	R	S	T	U	V	W	X
Y	Z						

ABC	abc	0-9..	&?!	ÁÁá	ÑÑñ	Delete	
&	?	!	@	<	>	()
[]	/	\	~	:	:	©
®	™	"	"	"	'	'	'

ABC	abc	0-9..	&?!	ÁÁá	ÑÑñ	Delete	
a	b	c	d	e	f	g	h
i	j	k	l	m	n	o	p
q	r	s	t	u	v	w	x
y	z						

ABC	abc	0-9..	&?!	ÁÁá	ÑÑñ	Delete	
Ā	Ā	Ā	Æ	ā	ā	ā	ā
ā	ā	æ	ç	ç	ð	ē	ē
ē	ē	è	é	é	ê	ë	ğ
í	ï	ï	ï	ï	ï	ï	-

ABC	abc	0-9..	&?!	ÁÁá	ÑÑñ	Delete	
0	1	2	3	4	5	6	7
8	9	#	%	\$	£	€	¥
-	+	x	+	=	*	.	,

ABC	abc	0-9..	&?!	ÁÁá	ÑÑñ	Delete	
Ā	Ā	ā	ō	ō	ø	ō	œ
ā	ā	ā	ā	ā	ā	œ	í
š	š	ř	Ů	Ů	ů	ů	à
ü	z	ß	ß	ß			

14
 ABC

ABC	abc	0-9..	&?!	ÁÁá	ÑÑñ	Delete	
A	B	C	D	E	F	G	H
I	J	K	L	M	N	O	P
Q	R	S	T	U	V	W	X
Y	Z						

ABC	abc	0-9..	&?!	ÁÁá	ÑÑñ	Delete	
&	?	!	@	<	>	()
[]	/	\	~	:	:	©
®	™	"	"	"	'	'	'

ABC	abc	0-9..	&?!	ÁÁá	ÑÑñ	Delete	
a	b	c	d	e	f	g	h
i	j	k	l	m	n	o	p
q	r	s	t	u	v	w	x
y	z						

ABC	abc	0-9..	&?!	ÁÁá	ÑÑñ	Delete	
Ā	Ā	Ā	Æ	ā	ā	ā	ā
ā	ā	æ	ç	ç	ð	ē	ē
ē	ē	è	é	é	ê	ë	ğ
í	ï	ï	ï	ï	ï	ï	-

ABC	abc	0-9..	&?!	ÁÁá	ÑÑñ	Delete	
0	1	2	3	4	5	6	7
8	9	#	%	\$	£	€	¥
-	+	x	+	=	*	.	,

ABC	abc	0-9..	&?!	ÁÁá	ÑÑñ	Delete	
Ā	Ā	ā	ō	ō	ø	ō	œ
ā	ā	ā	ā	ā	ā	œ	í
š	š	ř	Ů	Ů	ů	ů	à
ü	z	ß	ß	ß			

15
 ABC

ABC	abc	0-9..	&?!	ÁÁá	ÑÑñ	Delete	
A	B	C	D	E	F	G	H
I	J	K	L	M	N	O	P
Q	R	S	T	U	V	W	X
Y	Z						

ABC	abc	0-9..	&?!	ÁÁá	ÑÑñ	Delete	
Œ	?	!	@	<	>	()
[]	/	\	~	:	:	©
®	™	"	"	"	'	'	'

ABC	abc	0-9..	&?!	ÁÁá	ÑÑñ	Delete	
a	b	c	d	e	f	g	h
i	j	k	l	m	n	o	p
q	r	s	t	u	v	w	x
y	z						

ABC	abc	0-9..	&?!	ÁÁá	ÑÑñ	Delete	
Ā	Ā	Ā	Æ	ā	ā	ā	ā
ā	ā	æ	ç	ç	ð	ē	ē
ē	ē	è	é	é	ê	ë	ğ
í	ï	ï	ï	ï	ï	ï	-

ABC	abc	0-9..	&?!	ÁÁá	ÑÑñ	Delete	
0	1	2	3	4	5	6	7
8	9	#	%	\$	£	€	¥
-	+	x	+	=	*	.	,

ABC	abc	0-9..	&?!	ÁÁá	ÑÑñ	Delete	
Ñ	Ñ	ñ	Ò	Ò	ø	Ó	œ
ò	ó	ô	ö	ø	œ	í	
š	š	ř	Ů	Ů	ů	ů	à
ü	z	ß	ß	ß			

16
 ABC

ABC	abc	0-9..	&?!	ÁÁá	ÑÑñ	Delete	
A	B	C	D	E	F	G	H
I	J	K	L	M	N	O	P
Q	R	S	T	U	V	W	X
Y	Z						

ABC	abc	0-9..	&?!	ÁÁá	ÑÑñ	Delete	
a	b	c	d	e	f	g	h
i	j	k	l	m	n	o	p
q	r	s	t	u	v	w	x
y	z						

ABC	abc	0-9..	&?!	ÁÁá	ÑÑñ	Delete	
0	1	2	3	4	5	6	7
8	9	#	%	\$	£	€	¥
-	+	x	+	=	*	.	,

ABC	abc	0-9..	&?!	ÁÁá	ÑÑñ			
&	?	!	@	<	>	()	Delete
[]	/	\	~	:	:	©	↵
®	™	"	"	"	'	'	'	↵

ABC	abc	0-9..	&?!	ÁÁá	ÑÑñ			
Á	Ä	Å	Æ	à	á	â	ã	Delete
ä	å	æ	ç	ç	ð	ë	é	↵
ê	ë	è	é	é	ë	ğ	ğ	↵
í	ï	ï	ï	ï	ï	ï	ï	-

ABC	abc	0-9..	&?!	ÁÁá	ÑÑñ			
Ñ	Ñ	ñ	Ó	Ö	Ø	Ó	Œ	Delete
ò	ó	ô	ö	ø	œ	í		↵
š	š	ŧ	Ũ	Ū	ù	ú	ú	↵
ü	ž	Ɔ	Ɔ	Ɔ				↵

17
ABC

ABC	abc	0-9..	&?!	ÁÁá	ÑÑñ			
A	B	C	D	E	F	G	H	Delete
I	J	K	L	M	N	O	P	↵
Q	R	S	T	U	V	W	X	↵
Y	Z							↵

ABC	abc	0-9..	&?!	ÁÁá	ÑÑñ			
a	b	c	d	e	f	g	h	Delete
i	j	k	l	m	n	o	p	↵
q	r	s	t	u	v	w	x	↵
y	z							↵

ABC	abc	0-9..	&?!	ÁÁá	ÑÑñ			
0	1	2	3	4	5	6	7	Delete
8	9	-	.	.				↵

ABC	abc	0-9..	&?!	ÁÁá	ÑÑñ			
&	?	!	@	()	/	'	Delete

ABC	abc	0-9..	&?!	ÁÁá	ÑÑñ			
Á	Ä	Å	Æ	à	á	â	ã	Delete
ä	å	æ	ç	ç	ð	ë	é	↵
ê	ë	è	é	é	ë	ğ	ğ	↵
í	ï	ï	ï	ï	ï	ï	ï	-

ABC	abc	0-9..	&?!	ÁÁá	ÑÑñ				
Ñ	Ñ	ñ	Ö	Ø	ò	ö	ø	Ū	Delete
ù	ü	Ɔ						↵	

18
ABC

ABC	abc	0-9..	&?!	ÁÁá	ÑÑñ			
A	B	C	D	E	F	G	H	Delete
I	J	K	L	M	N	O	P	↵
Q	R	S	T	U	V	W	X	↵
Y	Z							↵

ABC	abc	0-9..	&?!	ÁÁá	ÑÑñ			
a	b	c	d	e	f	g	h	Delete
i	j	k	l	m	n	o	p	↵
q	r	s	t	u	v	w	x	↵
y	z							↵

ABC	abc	0-9..	&?!	ÁÁá	ÑÑñ			
0	1	2	3	4	5	6	7	Delete
8	9	#	%	\$	£	€	¥	↵
-	+	x	÷	=	*	.	,	↵

ABC	abc	0-9..	&?!	ÁÁá	ÑÑñ			
&	?	!	@	<	>	()	Delete
[]	/	\	~	:	:	©	↵
®	™	"	"	"	'	'	'	↵

ABC	abc	0-9..	&?!	ÁÁá	ÑÑñ			
Á	Ä	Å	Æ	à	á	â	ã	Delete
ä	å	æ	ç	ç	ð	ë	é	↵
ê	ë	è	é	é	ë	ğ	ğ	↵
í	ï	ï	ï	ï	ï	ï	ï	-

ABC	abc	0-9..	&?!	ÁÁá	ÑÑñ				
Ñ	Ñ	ñ	Ö	Ø	ò	ö	ø	Ū	Delete
ù	ü	Ɔ	Ɔ	Ɔ				↵	

19
ABC

ABC	abc	0-9..	&?!	ÁÁá	ÑÑñ			
A	B	C	D	E	F	G	H	Delete
I	J	K	L	M	N	O	P	↵
Q	R	S	T	U	V	W	X	↵
Y	Z							↵

ABC	abc	0-9..	&?!	ÁÁá	ÑÑñ			
a	b	c	d	e	f	g	h	Delete
i	j	k	l	m	n	o	p	↵
q	r	s	t	u	v	w	x	↵
y	z							↵

ABC	abc	0-9..	&?!	ÁÁá	ÑÑñ			
0	1	2	3	4	5	6	7	Delete
8	9	#	%	\$	£	€	¥	↵
-	+	x	÷	=	*	.	,	↵

ABC	abc	0-9..	&?!	ÁÁá	ÑÑñ			
&	?	!	@	<	>	()	Delete
[]	/	\	~	:	:	©	↵
®	™	"	"	"	'	'	'	↵

ABC	abc	0-9..	&?!	ÁÁá	ÑÑñ			
Á	Ä	Å	Æ	à	á	â	ã	Delete
ä	å	æ	ç	ç	ð	ë	é	↵
ê	ë	è	é	é	ë	ğ	ğ	↵
í	ï	ï	ï	ï	ï	ï	ï	-

ABC	abc	0-9..	&?!	ÁÁá	ÑÑñ				
Ñ	Ñ	ñ	Ö	Ø	ò	ö	ø	Ū	Delete
ù	ü	Ɔ	Ɔ	Ɔ				↵	

20
ABC

ABC	abc	0-9..	&?!	ÁÁá	ÑÑñ			
A	B	C	D	E	F	G	H	Delete
I	J	K	L	M	N	O	P	↵
Q	R	S	T	U	V	W	X	↵
Y	Z							↵

ABC	abc	0-9..	&?!	ÁÁá	ÑÑñ			
a	b	c	d	e	f	g	h	Delete
i	j	k	l	m	n	o	p	↵
q	r	s	t	u	v	w	x	↵
y	z							↵

ABC	abc	0-9..	&?!	ÁÁá	ÑÑñ			
0	1	2	3	4	5	6	7	Delete
8	9	#	%	\$	£	€	¥	↵
-	+	x	÷	=	*	.	,	↵

ABC	abc	0-9..	&?!	ÁÁá	ÑÑñ			
&	?	!	@	<	>	()	Delete
[]	/	\	~	:	:	©	↵
®	™	"	"	"	'	'	'	↵

ABC	abc	0-9..	&?!	ÁÁá	ÑÑñ			
Á	Ä	Å	Æ	à	á	â	ã	Delete
ä	å	æ	ç	ç	ð	ë	é	↵
ê	ë	è	é	é	ë	ğ	ğ	↵
í	ï	ï	ï	ï	ï	ï	ï	-

ABC	abc	0-9..	&?!	ÁÁá	ÑÑñ				
Ñ	Ñ	ñ	Ö	Ø	ò	ö	ø	Ū	Delete
ù	ü	Ɔ	Ɔ	Ɔ				↵	

21
ABC

ABC	abc	0-9..	&?!	ÁÁá	NÑn	Delete	
A	B	G	D	E	F	G	H
I	J	K	L	M	N	O	P
Q	R	S	T	U	V	W	X
Y	Z						

ABC	abc	0-9..	&?!	ÁÁá	NÑn	Delete	
Š	?	!	@	<	>	()
l	l	/	\	~	:	:	©
®	™	“	”	”	’	’	’

ABC	abc	0-9..	&?!	ÁÁá	NÑn	Delete	
a	b	c	d	e	f	g	h
i	j	k	l	m	n	o	p
q	r	s	t	u	v	w	x
y	z						

ABC	abc	0-9..	&?!	ÁÁá	NÑn	Delete	
À	À	À	Æ	à	á	â	ã
ä	å	æ	ç	ç	Đ	È	É
Ê	Ë	è	é	é	Ĝ	ğ	
Í	İ	İ	i	í	ı	ı	-

ABC	abc	0-9..	&?!	ÁÁá	NÑn	Delete	
0	1	2	3	4	5	6	7
8	9	#	%	\$	£	€	¥
-	+	x	÷	=	*	.	,

ABC	abc	0-9..	&?!	ÁÁá	NÑn	Delete	
Ñ	Ñ	ñ	Ò	Ò	ó	Œ	Œ
ò	ó	ô	õ	ø	ø	œ	ř
Š	š	ŧ	Ũ	Ū	ù	ú	û
ü	ž	Ɔ	Ɔ	Ɔ			

22
ABC

ABC	abc	0-9..	&?!	ÁÁá	NÑn	Delete	
A	B	C	D	E	F	G	H
I	J	K	L	M	N	O	P
Q	R	S	T	U	V	W	X
Y	Z						

ABC	abc	0-9..	&?!	ÁÁá	NÑn	Delete	
&	?	!	@	<	>	()
l	l	/	\	~	:	:	©
®	™	“	”	”	’	’	’

ABC	abc	0-9..	&?!	ÁÁá	NÑn	Delete	
a	b	c	d	e	f	g	h
i	j	k	l	m	n	o	p
q	r	s	t	u	v	w	x
y	z						

ABC	abc	0-9..	&?!	ÁÁá	NÑn	Delete	
À	À	À	Æ	à	á	â	ã
ä	å	æ	ç	ç	Đ	È	É
Ê	Ë	è	é	é	Ĝ	ğ	
Í	İ	İ	i	í	ı	ı	-

ABC	abc	0-9..	&?!	ÁÁá	NÑn	Delete	
0	1	2	3	4	5	6	7
8	9	#	%	\$	£	€	¥
-	+	x	÷	=	*	.	,

ABC	abc	0-9..	&?!	ÁÁá	NÑn	Delete	
Ñ	Ñ	ñ	Ò	Ò	ó	Œ	Œ
ò	ó	ô	õ	ø	ø	œ	ř
Š	š	ŧ	Ũ	Ū	ù	ú	û
ü	ž	Ɔ	Ɔ	Ɔ			

23
ABC

ABC	abc	0-9..	&?!			Delete	
A	B	C	D	E	F	G	H
I	J	K	L	M	N	O	P
Q	R	S	T	U	V	W	X
Y	Z						

ABC	abc	0-9..	&?!			Delete	
&	?	!	<	>	[]	/
\	~	:	:	“	”	’	’

ABC	abc	0-9..	&?!			Delete	
a	b	c	d	e	f	g	h
i	j	k	l	m	n	o	p
q	r	s	t	u	v	w	x
y	z						

ABC	abc	0-9..	&?!			Delete	
0	1	2	3	4	5	6	7
8	9	-	=	.	,		

24
ABC

ABC	abc	0-9..	&?!	ÁÁá	NÑn	Delete	
A	B	C	D	E	F	G	H
I	J	K	L	M	N	O	P
Q	R	S	T	U	V	W	X
Y	Z						

ABC	abc	0-9..	&?!	ÁÁá	NÑn	Delete	
&	?	!	@	<	>	()
l	l	/	\	~	:	:	©
®	™	“	”	”	’	’	’

ABC	abc	0-9..	&?!	ÁÁá	NÑn	Delete	
a	b	c	d	e	f	g	h
i	j	k	l	m	n	o	p
q	r	s	t	u	v	w	x
y	z						

ABC	abc	0-9..	&?!	ÁÁá	NÑn	Delete	
À	À	À	Æ	à	á	â	ã
ä	å	æ	ç	ç	Đ	È	É
Ê	Ë	è	é	é	Ĝ	ğ	
Í	İ	İ	i	í	ı	ı	-

ABC	abc	0-9..	&?!	ÁÁá	NÑn	Delete	
0	1	2	3	4	5	6	7
8	9	#	%	\$	£	€	¥
-	+	x	÷	=	*	.	,

ABC	abc	0-9..	&?!	ÁÁá	NÑn	Delete	
Ñ	Ñ	ñ	Ò	Ò	ó	Œ	Œ
ò	ó	ô	õ	ø	ø	œ	ř
Š	š	ŧ	Ũ	Ū	ù	ú	û
ü	ž	Ɔ	Ɔ	Ɔ			

25
ABC

ABC	abc	0-9..	&?!	ÁÁá	NÑn	Delete	
A	B	C	D	E	F	G	H
I	J	K	L	M	N	O	P
Q	R	S	T	U	V	W	X
Y	Z						

ABC	abc	0-9..	&?!	ÁÁá	NÑn	Delete	
a	b	c	d	e	f	g	h
i	j	k	l	m	n	o	p
q	r	s	t	u	v	w	x
y	z						

ABC	abc	0-9..	&?!	ÁÁá	NÑn	Delete	
0	1	2	3	4	5	6	7
8	9	#	%	\$	£	€	¥
-	+	x	÷	=	*	.	,

ABC	abc	0-9..	&?!	ÁÁá	NNñ	
&	?	!	@	<	>	() Delete
[]	/	\	~	:	; ©
®	™	"	"	"	'	'

ABC	abc	0-9..	&?!	ÁÁá	NNñ	
À	Ä	Å	Æ	à	á	â
ä	å	æ	ç	ç	ð	è
é	ë	ê	é	è	ë	î
í	ï	ì	í	î	ï	-

ABC	abc	0-9..	&?!	ÁÁá	NNñ	
Ñ	Ń	ñ	Ō	Ŏ	ø	ó
ò	ó	ô	õ	ø	ö	œ
ŝ	š	ŕ	Ů	Ű	ú	ú
ü	ž	ƀ	Ɓ	Ƃ		

26 АБВ

АБВ	ЧШЩ	абв	чшщ	0-9..		
А	Б	В	Г	Д	Е	Ё Ж Delete
З	И	Й	К	Л	М	Н О
П	Р	С	Т	У	Ф	Х Ц

АБВ	ЧШЩ	абв	чшщ	0-9..		
Ч	Ш	Щ	Ъ	Ы	Ь	Э Ю Delete
Я	Ґ	Є	І	Ї	Ў	Ҁ ҁ
Ј	Љ	Њ	Џ	Ѓ	Ѕ	Ї

АБВ	ЧШЩ	абв	чшщ	0-9..		
а	б	в	г	д	е	ё ж Delete
з	и	й	к	л	м	н о
п	р	с	т	у	ф	х ц

АБВ	ЧШЩ	абв	чшщ	0-9..		
ч	ш	щ	ъ	ы	ь	э ю Delete
я	ґ	є	і	ї	ў	Ҁ ҁ
ј	љ	њ	џ	ѓ	ѕ	ї

АБВ	ЧШЩ	абв	чшщ	0-9..		
0	1	2	3	4	5	6 7 Delete
8	9	,	.	-	&	? !
()	/	'			

27 АБВ

АБВ	ЧШЩ	абв	чшщ	0-9..		
А	Б	В	Г	Д	Е	Ё Ж Delete
З	И	Й	К	Л	М	Н О
П	Р	С	Т	У	Ф	Х Ц

АБВ	ЧШЩ	абв	чшщ	0-9..		
Ч	Ш	Щ	Ъ	Ы	Ь	Э Ю Delete
Я	Ґ	Є	І	Ї	Ў	Ҁ ҁ
Ј	Љ	Њ	Џ	Ѓ	Ѕ	Ї

АБВ	ЧШЩ	абв	чшщ	0-9..		
а	б	в	г	д	е	ё ж Delete
з	и	й	к	л	м	н о
п	р	с	т	у	ф	х ц

АБВ	ЧШЩ	абв	чшщ	0-9..		
ч	ш	щ	ъ	ы	ь	э ю Delete
я	ґ	є	і	ї	ў	Ҁ ҁ
ј	љ	њ	џ	ѓ	ѕ	ї

АБВ	ЧШЩ	абв	чшщ	0-9..		
0	1	2	3	4	5	6 7 Delete
8	9	,	.	-	&	? !
()	/	'			

28 ABCDE

ABC	abc	0-9..	&?!	ÁÁá	NNñ	
A	B	C	D	E	F	G H Delete
I	J	K	L	M	N	O P
Q	R	S	T	U	V	W X
Y	Z					

ABC	abc	0-9..	&?!	ÁÁá	NNñ	
a	b	c	d	e	f	g h Delete
i	j	k	l	m	n	o p
q	r	s	t	u	v	w x
y	z					

ABC	abc	0-9..	&?!	ÁÁá	NNñ	
0	1	2	3	4	5	6 7 Delete
8	9	#	%	\$	£	€ ¥
-	+	x	÷	=	*	.
,						

ABC	abc	0-9..	&?!	ÁÁá	NNñ	
&	?	!	@	<	>	() Delete
[]	/	\	~	:	; ©
®	™	"	"	"	'	'

ABC	abc	0-9..	&?!	ÁÁá	NNñ	
À	Ä	Å	Æ	à	á	â
ä	å	æ	ç	ç	ð	è
é	ë	ê	é	è	ë	î
í	ï	ì				

ABC	abc	0-9..	&?!	ÁÁá	NNñ	
Ñ	Ń	ñ	Ō	Ŏ	ø	ó
ò	ó	ô	õ	ø	ö	œ
ŝ	š	ŕ	Ů	Ű	ú	ú
ƀ	Ɓ	Ƃ				

29 ABCDE

ABC	abc	0-9..	&?!	ÁÁá	NNñ	
A	B	C	D	E	F	G H Delete
I	J	K	L	M	N	O P
Q	R	S	T	U	V	W X
Y	Z					

ABC	abc	0-9..	&?!	ÁÁá	NNñ	
a	b	c	d	e	f	g h Delete
i	j	k	l	m	n	o p
q	r	s	t	u	v	w x
y	z					

ABC	abc	0-9..	&?!	ÁÁá	NNñ	
0	1	2	3	4	5	6 7 Delete
8	9	#	%	\$	£	€ ¥
-	+	x	÷	=	*	.
,						

ABC	abc	0-9..	&?!	ÁÁá	NNñ	
&	?	!	@	<	>	() Delete
[]	/	\	~	:	; ©
®	™	"	"	"	'	'

ABC	abc	0-9..	&?!	ÁÁá	NNñ	
À	Ä	Å	Æ	à	á	â
ä	å	æ	ç	ç	ð	è
é	ë	ê	é	è	ë	î
í	ï	ì				

ABC	abc	0-9..	&?!	ÁÁá	NNñ	
Ñ	Ń	ñ	Ō	Ŏ	ø	ó
ò	ó	ô	õ	ø	ö	œ
ŝ	š	ŕ	Ů	Ű	ú	ú
ƀ	Ɓ	Ƃ				

Summary of Embroidery Patterns
 Oversigt over broderimønstre
 A hímzéminták összefoglalása
 Sumarul modelelor de broderie

Översikt över broderimönster
 Shrutí vyšívacích vzorů
 Podsumowanie wzorów haftów

30
 ABCDE

ABC	abc	0-9..	&?!	ÁÁá	NÑñ	Delete	
A	B	C	D	E	F	G	H
I	J	K	L	M	N	O	P
Q	R	S	T	U	V	W	X
Y	Z						

ABC	abc	0-9..	&?!	ÁÁá	NÑñ	Delete	
&	?	!	@	()	/	'

ABC	abc	0-9..	&?!	ÁÁá	NÑñ	Delete	
a	b	c	d	e	f	g	h
i	j	k	l	m	n	o	p
q	r	s	t	u	v	w	x
y	z						

ABC	abc	0-9..	&?!	ÁÁá	NÑñ	Delete		
À	Á	Â	Ã	Ä	à	á	â	
ä	å	ç	ç	è	é	ê	ë	
ì	í	î						

ABC	abc	0-9..	&?!	ÁÁá	NÑñ	Delete	
0	1	2	3	4	5	6	7
8	9	-	.	.			

ABC	abc	0-9..	&?!	ÁÁá	NÑñ	Delete	
Ñ	ñ	Ë	Ë	à	á	â	ä
ø	Û	ü	ü	ü	ü	β	

31
 ABCDE

ABC	abc	0-9..	&?!	ÁÁá	NÑñ	Delete	
A	B	C	D	E	F	G	H
I	J	K	L	M	N	O	P
Q	R	S	T	U	V	W	X
Y	Z						

ABC	abc	0-9..	&?!	ÁÁá	NÑñ	Delete	
&	?	!	@	()	/	'

ABC	abc	0-9..	&?!	ÁÁá	NÑñ	Delete	
a	b	c	d	e	f	g	h
i	j	k	l	m	n	o	p
q	r	s	t	u	v	w	x
y	z						

ABC	abc	0-9..	&?!	ÁÁá	NÑñ	Delete		
À	Á	Â	Ã	Ä	à	á	â	
ä	å	ç	ç	è	é	ê	ë	
ì	í	î						

ABC	abc	0-9..	&?!	ÁÁá	NÑñ	Delete	
0	1	2	3	4	5	6	7
8	9	-	.	.			

ABC	abc	0-9..	&?!	ÁÁá	NÑñ	Delete	
Ñ	ñ	Ë	Ë	à	á	â	ä
ø	Û	ü	ü	ü	ü	β	

32
 ABCDE

ABC	abc	0-9..	&?!	ÁÁá	NÑñ	Delete	
A	B	C	D	E	F	G	H
I	J	K	L	M	N	O	P
Q	R	S	T	U	V	W	X
Y	Z						

ABC	abc	0-9..	&?!	ÁÁá	NÑñ	Delete	
&	?	!	@	()	/	'

ABC	abc	0-9..	&?!	ÁÁá	NÑñ	Delete	
a	b	c	d	e	f	g	h
i	j	k	l	m	n	o	p
q	r	s	t	u	v	w	x
y	z						

ABC	abc	0-9..	&?!	ÁÁá	NÑñ	Delete		
À	Á	Â	Ã	Ä	à	á	â	
ä	å	ç	ç	è	é	ê	ë	
ì	í	î						

ABC	abc	0-9..	&?!	ÁÁá	NÑñ	Delete	
0	1	2	3	4	5	6	7
8	9	-	.	.			

ABC	abc	0-9..	&?!	ÁÁá	NÑñ	Delete	
Ñ	ñ	Ë	Ë	à	á	â	ä
ø	Û	ü	ü	ü	ü	β	

33
 ABCDEFGH

ABC	abc	0-9..					Delete
A	B	C	D	E	F	G	H
I	J	K	L	M	N	O	P
Q	R	S	T	U	V	W	X
Y	Z						

ABC	abc	0-9..					Delete
a	b	c	d	e	f	g	h
i	j	k	l	m	n	o	p
q	r	s	t	u	v	w	x
y	z						

ABC	abc	0-9..					Delete
0	1	2	3	4	5	6	7
8	9	#	%	\$	€	¥	
-	+	x	÷	=	*	.	,

あいう

Katakana characters: One of the character sets of Japanese.

Katakana-tecken: en japansk teckenuppsättning.

Katakana-tegn: et japansk alfabet.

Znaky písma katakana: jedna ze sad japonských znaků.

Katakana karakter: A japán karakterkészlet egy eleme.

Znaki Katakana: jeden z japońskich zestawów znaków.

Caractere Katakana: Unul din seturile de caractere japoneze.

Hiragana characters: One of the character sets of Japanese.

Hiragana-tecken: en japansk teckenuppsättning.

Hiragana-tegn: et japansk alfabet.

Znaky písma hiragana: jedna ze sad japonských znaků.

Hiragana karakter: A japán karakterkészlet egy eleme.

Znaki Hiragana: jeden z japońskich zestawów znaków.

Caractere Hiragana: Unul din seturile de caractere japoneze.

Arabic numerals, Japanese Kanji numerals

Arabiska siffror, japanska Kanji-siffror

Arabiske tal, japanske Kanji-tal

Arabské číslice, japonské číslice kandži

Arab számok, japán kandzsi számok

Cyfry arabskie, japońskie cyfry Kanji

Numerale arabe, numerale japoneze Kanji

Kanji characters often used in daily life / symbols.

Kanji-tecken: används ofta för dagligt bruk / symboler.

Kanji-tegn: bruges ofte i hverdagen/symboler.

Znaky kandži: často používané v každodenním životě / symboly.

Kandzsi karakter: A mindennapi életben / szimbólumként gyakran használt karakter.

Znaki Kanji: często używane w życiu codziennym i symbolach.

Caractere Kanji: Utilizate adesea în viața de zi cu zi / ca simboluri.

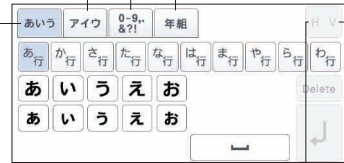

Horizontal
Vågrät
Vandret
Horizontálně
Horizontális
Pozíome
Orizontale

Vertical
Lodrät
Lodret
Vertikálně
Vertikális
Pionowe
Verticale

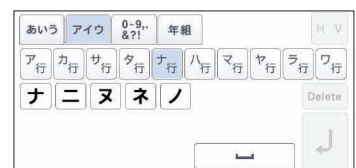
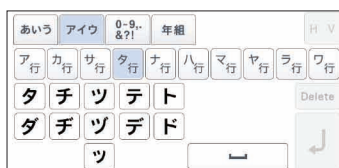
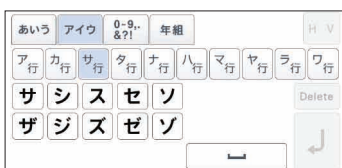
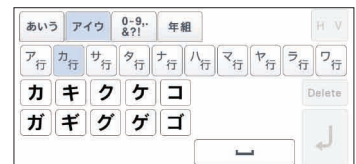
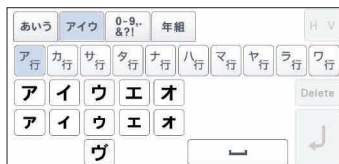
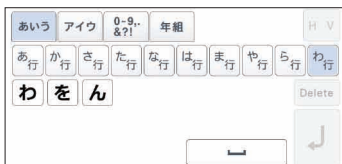
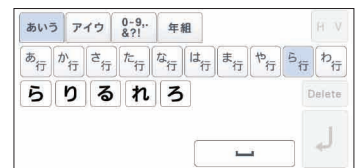
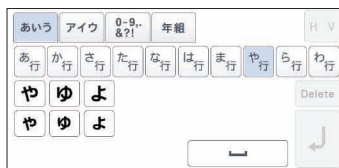
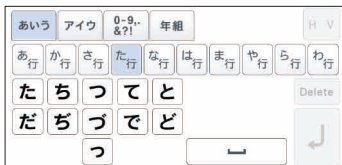
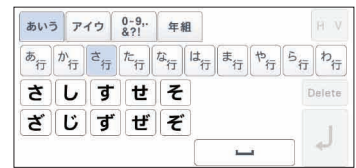
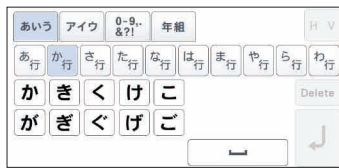
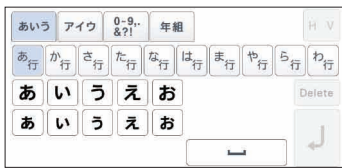

Summary of Embroidery Patterns
 Oversigt over broderimønstre
 A hímzésminták összefoglalása
 Sumarul modelelor de broderie

Översikt över broderimönster
 Shrnutí vyšívacích vzorů
 Podsumowanie wzorów haftów

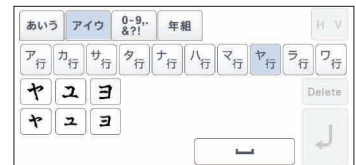
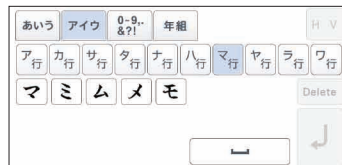
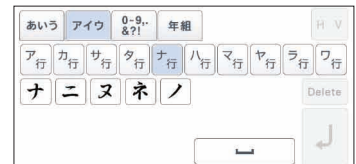
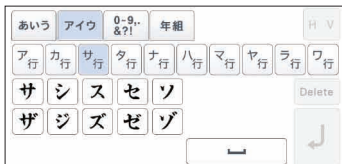
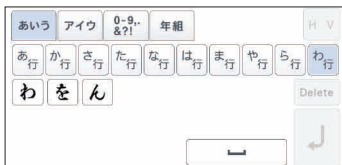
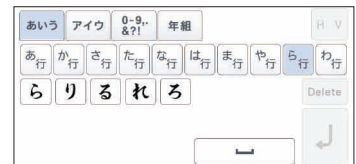
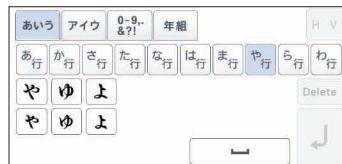
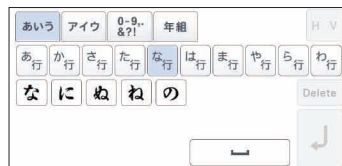
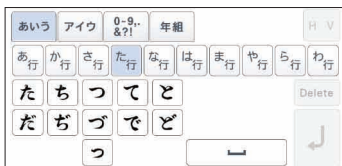
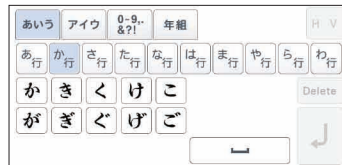
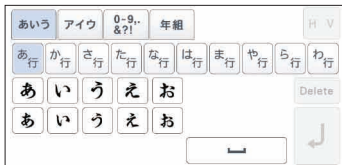
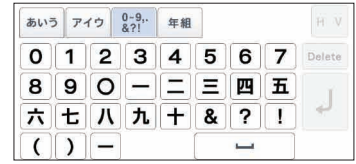
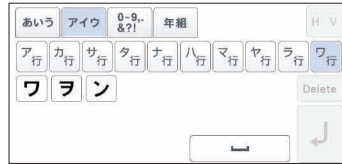
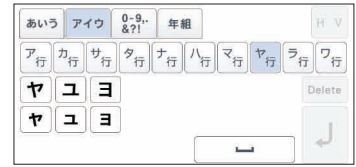

35
 あいう

あいう アイウ 0-9.&?! 年組 H V

ア	カ	サ	タ	ナ	ハ	マ	ヤ	ラ	ワ
ラ	リ	ル	レ	ロ					

Delete

あいう アイウ 0-9.&?! 年組 H V

ア	カ	サ	タ	ナ	ハ	マ	ヤ	ラ	ワ
ワ	ラ	ン							

Delete

あいう アイウ 0-9.&?! 年組 H V

0	1	2	3	4	5	6	7	Delete
8	9	〇	一	二	三	四	五	↓
六	七	八	九	十	&	?	!	
()	-						

あいう アイウ 0-9.&?! 年組 H V

生	年	月	日	才	小	中	学	Delete
校	組	火	水	木	金	土	保	↓
育	幼	稚	園	番	部	班	会	
係	名	前						

36 あいう

あいう アイウ 0-9.&?! 年組 H V

あ	い	う	え	お					
あ	い	う	え	お					

Delete

あいう アイウ 0-9.&?! 年組 H V

あ	い	う	え	お					
か	き	く	け	こ					
が	ぎ	ぐ	げ	ご					

Delete

あいう アイウ 0-9.&?! 年組 H V

あ	い	う	え	お					
さ	し	す	せ	そ					
ざ	じ	ず	ぜ	ぞ					

Delete

あいう アイウ 0-9.&?! 年組 H V

あ	い	う	え	お					
た	ち	つ	て	と					
だ	ぢ	づ	で	ど					
っ									

Delete

あいう アイウ 0-9.&?! 年組 H V

あ	い	う	え	お					
な	に	ぬ	ね	の					

Delete

あいう アイウ 0-9.&?! 年組 H V

あ	い	う	え	お					
は	ひ	ふ	へ	ほ					
ば	び	ぶ	べ	ぼ					
ぱ	ぴ	ぷ	ぺ	ぽ					

Delete

あいう アイウ 0-9.&?! 年組 H V

あ	い	う	え	お					
ま	み	む	め	も					

Delete

あいう アイウ 0-9.&?! 年組 H V

あ	い	う	え	お					
や	ゆ	よ							
や	ゆ	よ							

Delete

あいう アイウ 0-9.&?! 年組 H V

あ	い	う	え	お					
ら	り	る	れ	ろ					

Delete

あいう アイウ 0-9.&?! 年組 H V

あ	い	う	え	お					
わ	を	ん							

Delete

あいう アイウ 0-9.&?! 年組 H V

ア	イ	ウ	エ	オ					
ア	イ	ウ	エ	オ					
ウ									

Delete

あいう アイウ 0-9.&?! 年組 H V

ア	カ	サ	タ	ナ	ハ	マ	ヤ	ラ	ワ
カ	キ	ク	ケ	コ					
ガ	ギ	グ	ゲ	ゴ					

Delete

あいう アイウ 0-9.&?! 年組 H V

ア	カ	サ	タ	ナ	ハ	マ	ヤ	ラ	ワ
サ	シ	ス	セ	ソ					
ザ	ジ	ズ	ゼ	ゾ					

Delete

あいう アイウ 0-9.&?! 年組 H V

ア	カ	サ	タ	ナ	ハ	マ	ヤ	ラ	ワ
タ	チ	ツ	テ	ト					
ダ	ヂ	ヅ	デ	ド					
ッ									

Delete

あいう アイウ 0-9.&?! 年組 H V

ア	カ	サ	タ	ナ	ハ	マ	ヤ	ラ	ワ
ナ	ニ	ヌ	ネ	ノ					

Delete

あいう アイウ 0-9.&?! 年組 H V

ア	カ	サ	タ	ナ	ハ	マ	ヤ	ラ	ワ
ハ	ヒ	フ	ヘ	ホ					
バ	ビ	ブ	ベ	ボ					
パ	ピ	プ	ペ	ポ					

Delete

あいう アイウ 0-9.&?! 年組 H V

ア	カ	サ	タ	ナ	ハ	マ	ヤ	ラ	ワ
マ	ミ	ム	メ	モ					

Delete

あいう アイウ 0-9.&?! 年組 H V

ア	カ	サ	タ	ナ	ハ	マ	ヤ	ラ	ワ
ヤ	ユ	ヨ							
ヤ	ユ	ヨ							

Delete

あいう アイウ 0-9.&?! 年組 H V

ア	カ	サ	タ	ナ	ハ	マ	ヤ	ラ	ワ
ラ	リ	ル	レ	ロ					

Delete

あいう アイウ 0-9.&?! 年組 H V

ア	カ	サ	タ	ナ	ハ	マ	ヤ	ラ	ワ
ワ	ラ	ン							

Delete

あいう アイウ 0-9.&?! 年組 H V

0	1	2	3	4	5	6	7	Delete
8	9	〇	一	二	三	四	五	↓
六	七	八	九	十	&	?	!	
()	-						

あいう アイウ 0-9.&?! 年組 H V

生	年	月	日	才	小	中	学	Delete
校	組	火	水	木	金	土	保	↓
育	幼	稚	園	番	部	班	会	
係	名	前						

- ◆ Decorative Alphabet Patterns
- ◆ Mønstre med dekorativt alfabet
- ◆ Dekorációs ábécé minták
- ◆ Modele cu alfabet decorativ

- ◆ Dekorativt alfabete-mønster
- ◆ Vzory dekorativní abecedy
- ◆ Wzory alfabetu dekoracyjnego

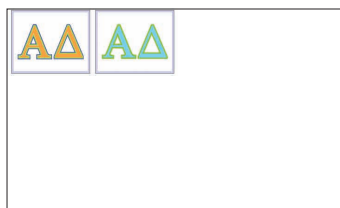
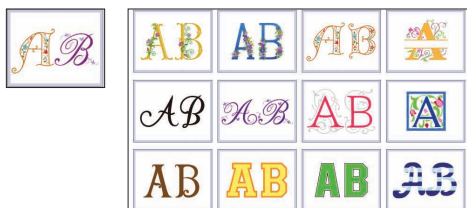

- Floral Alphabet (Gold)
- Blomsteralfabet (guld)
- Virágos ábécé (arany)
- Alfabet floral (auriu)

- Blomsteralfabet (guld)
- Květinová abeceda (zlatá)
- Alfabet kwiatowy (Złoty)

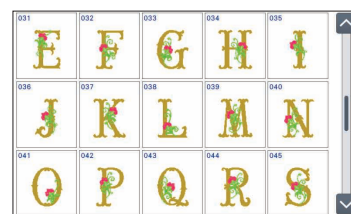
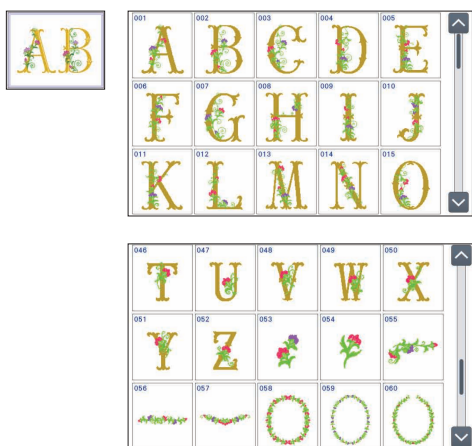

- Floral Alphabet (Blue)
- Blomsteralfabet (blå)
- Virágos ábécé (kék)
- Alfabet floral (albastru)

- Blomsteralfabet (blått)
- Květinová abeceda (modrá)
- Alfabet kwiatowy (Niebieski)

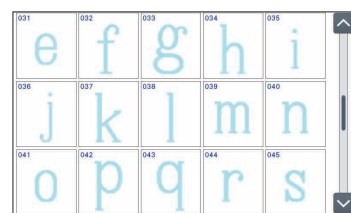
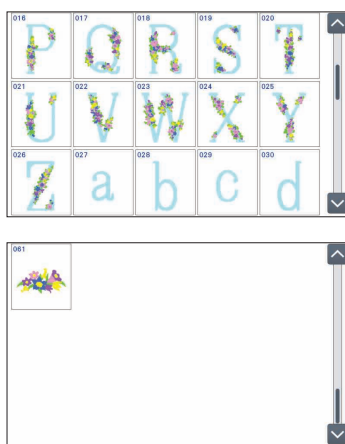

- Floral Alphabet
- Blomsteralfabet
- Virágos ábécé
- Alfabet floral



- Blomstermönster
- Květinová abeceda
- Kwiatowy alfabet

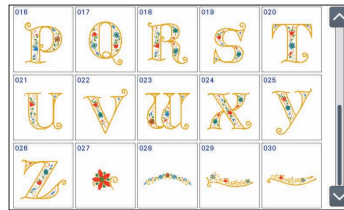

- Split Monogram
- Opdelte monogram
- Monogram megosztása
- Monogramă secționată

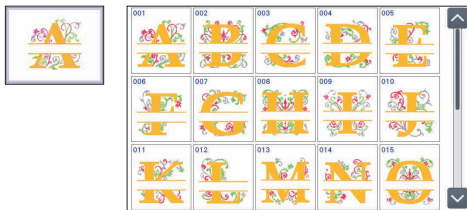

- Delat monogram
- Dělený monogram
- Podzielony monogram

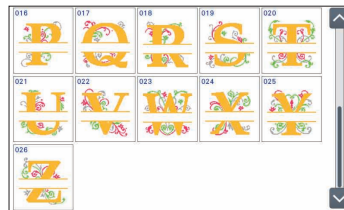

- Calligraphy
- Kalligráfi
- Kalligráfia
- Caligrafie

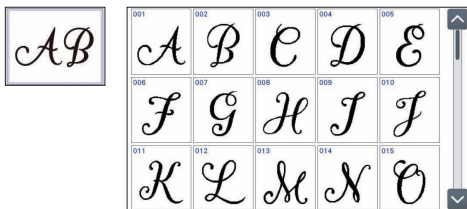

- Kalligráfi
- Kaligrafie
- Kaligrafia

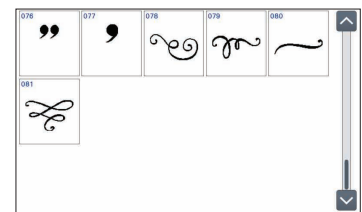
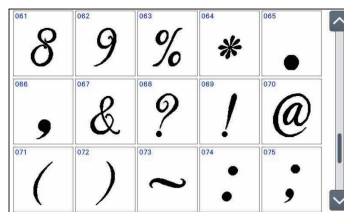
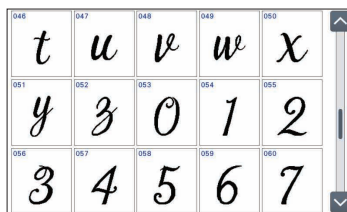
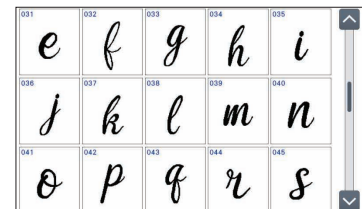
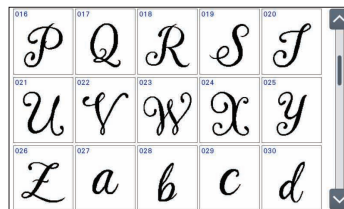

- Vine Alphabet
- Alfabet med vinranker
- Szőlő ábécé
- Alfabet cu modele de viță de vie

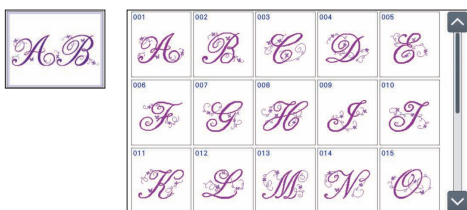

- Alfabetet med vinrankor
- Abeceda z vinné révy
- Alfabet z winorośli

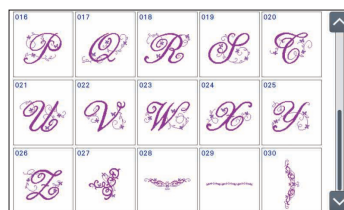

- Line Alphabet
- Dekorativt alfabet
- Vonal ábécé
- Alfabet cu linii

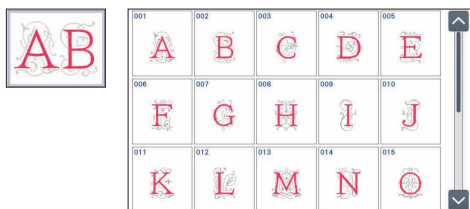

- Dekorativt alfabet
- Řádková abeceda
- Alfabet liniowy

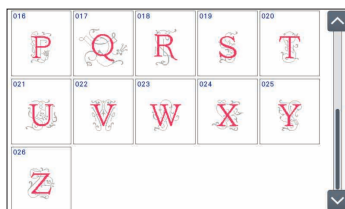

- Renaissance Alphabet
- Renæssancealfabet
- Reneszánsz betűk
- Alfabet renesantist



- Renæssancealfabet
- Renesanční abeceda
- Alfabet renesansowy



- Vintage Alphabet
- Gammeldags alfabet
- Régi ábécé
- Alfabet vintage

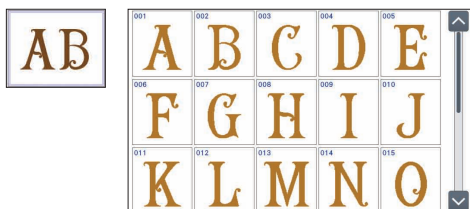

- Vintage-bokstäver
- Starodávná abeceda
- Starodawny alfabet

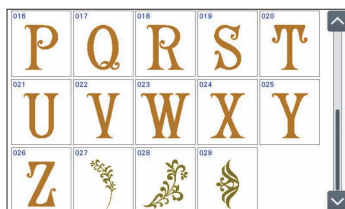

- Appliqué Alphabet
- Applikationsalfabet
- Rátétes betűk
- Monogram cu aplicații

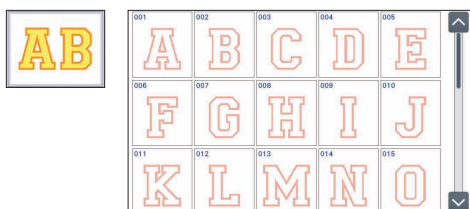

- Applikationsalfabet
- Aplikace písmen
- Alfabet ozdobny

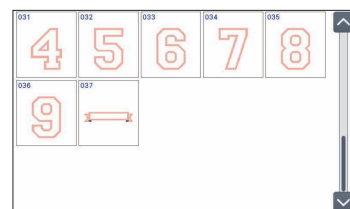
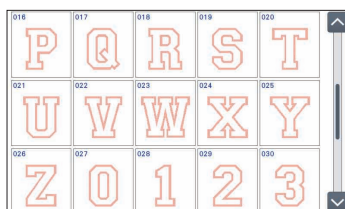

- Block Alphabet
- Trykt alfabet
- Szögletes ábécé
- Alfabet bloc

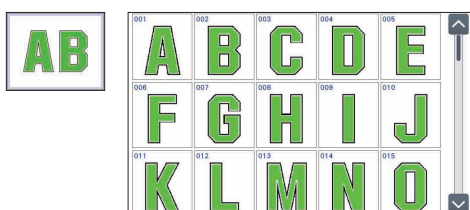

- Tryckt alfabet
- Blokóvá abeceda
- Alfabet drukowany

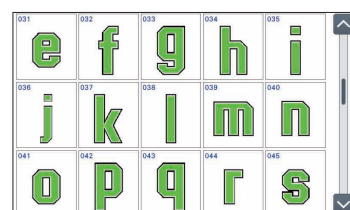
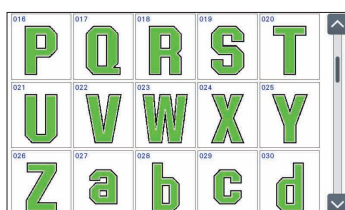

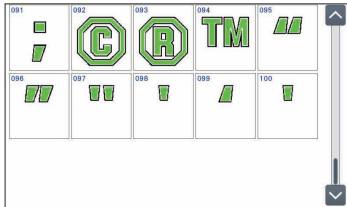
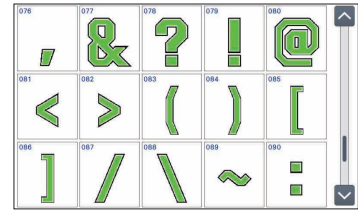
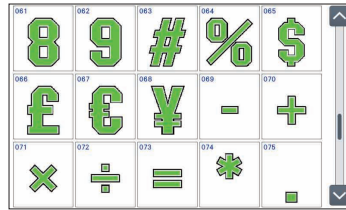
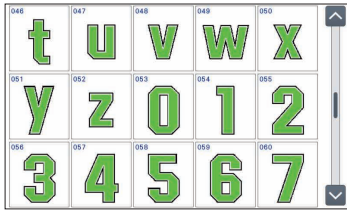

- Striped Alphabet
- Stribet alfabet
- Csíkos ábécé
- Alfabet în dungii

- Randigt alfabet
- Pruhovaná abeceda
- Alfabet w paski

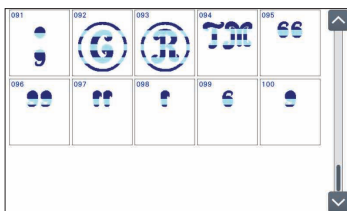
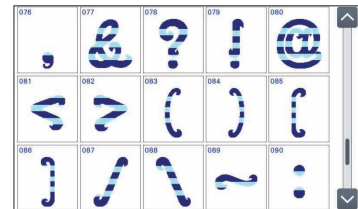
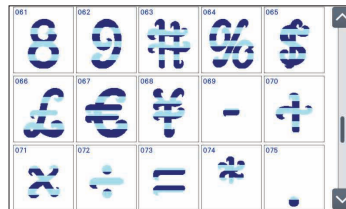
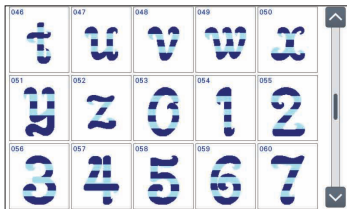
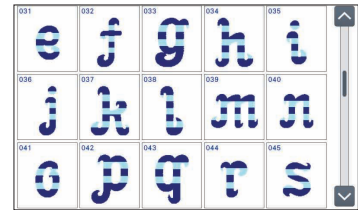
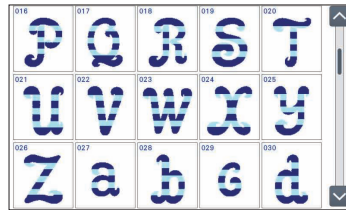
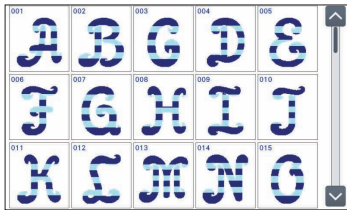

- Greek Alphabet
- Græsk alfabet
- Görög betűk
- Modele cu alfabetul grec

- Mönster med det grekiska alfabetet
- Vzory řecké abecedy
- Wzory alfabetu greckiego

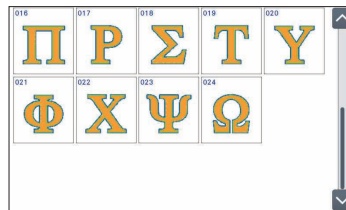

- Appliqué Greek Alphabet
- Applikation – græsk alfabet
- Görög ábécés felvarrt díszítés
- Aplicație alfabet grecesc

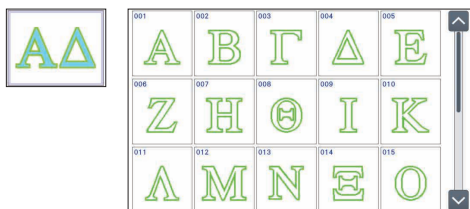

- Applikation grekiska-bokstäver
- Našivaná ozdobná řecká abeceda
- Aplikacja – alfabet grecki

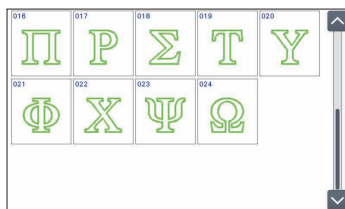

- ◆ Quilting border patterns
- ◆ Quiltekantmønstre
- ◆ Steppelt szegélyminták
- ◆ Modele pentru matlasarea bordurilor

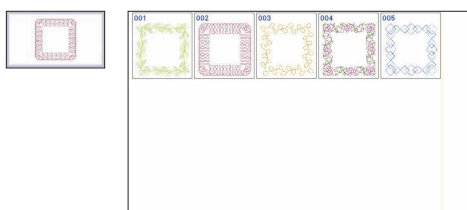
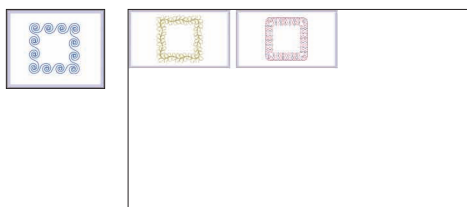

- ◆ Mönster för quiltningsram
- ◆ Prošívání bordurových vzorů
- ◆ Wzory obrzeży pikowanych

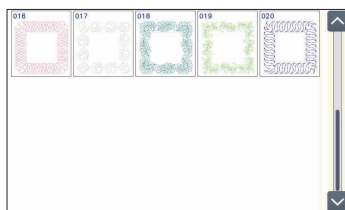

Embroidery Pattern Color Change Table

Oversigt over mønstrenes farveskift

A hímzsminták színcsere-táblázata

Tabel de modificare a culorilor modelului de broderie

Broderimönster färgändringstabell

Tabulka s variantami barev vyšívacích vzorů

Tabela zmiany kolorów wzorów haftów

Embroidery time and size of each design in this guide may differ from the information on the machine display. Please use as a reference purpose only. The color numbers in this guide are for the Embroidery thread brand unless otherwise noted.

- Patterns marked with ● have been rotated. Check your design placement prior to embroidering.
- ★ Refer to the operation manual for the embroidery machine for details on how to embroider appliquéés.

Broderitiden og størrelsen af de enkelte mønstre i denne guide kan variere fra oplysningerne i maskinens display. Disse oplysninger er kun vejledende. Farvenumrene i denne guide gælder broderitrådmærket, medmindre andet er angivet.

- Mønstre markeret med ● er blevet drejet. Kontroller designets placering før brodering.
- ★ Se i brugsanvisningen til broderimaskinen for at få oplysninger om, hvordan man broderer applikationer.

Az útmutatóban megjelenő hímzési idők és mintaméreték eltérhetnek a gép kijelzőjén megjelenő információktól. Csak referenciaként használja. Az útmutatóban szereplő színszámok a hímzőfonal- márkára vonatkoznak, ha más jelzés nem található.

- A ● szimbólummal megjelölt minták el vannak forgatva. Hímzés előtt ellenőrizze a minta elhelyezését.
- ★ A rátéthímzés módjára vonatkozó részletekért olvassa el a hímzőgép használati utasítását.

Timpul de coasere și dimensiunea de brodat a fiecărui model din acest ghid pot să difere față de informațiile afișate pe ecranul mașinii. Vă rugăm să folosiți aceste informații numai în scop informativ.

Numererele culorilor din acest ghid sunt pentru marca de fire de broderie dacă nu se specifică altceva.

- Modelele marcate cu ● au fost rotite. Verificați amplasarea modelului înainte de brodat.
- ★ Consultați manualul de utilizare al mașinii de brodat pentru detalii despre brodarea aplicațiilor.

Broderitid och storlek på varje design i denna guide kan skilja sig från informationen på maskinens display. Använd endast som referensändamål. Färgnumrering i den här guiden är för märket Trådbroderi om inget annat anges.

- Mönster markerade med ● har roterats. Kontrollera designens placering innan du broderar.
- ★ Information om hur du broderar applikationer finns i brodermaskinens bruksanvisning.

Doba vyšívání a velikost jednotlivých návrhů v tomto průvodci se může lišit od informací na displeji stroje. Používejte pouze pro orientaci. Čísla barev v této příručce platí pro značku vyšívací nitě, pokud není uvedeno jinak.

- Vzory označené puntíkem ● byly otočeny. Před zahájením vyšívání zkontrolujte umístění designu.
- ★ Podrobnosti o vyšívání aplikací najdete v uživatelské příručce vyšívacího stroje.

Czas wykonania i rozmiar poszczególnych wzorów w niniejszej instrukcji może się różnić od informacji na wyświetlaczu maszyny. Dane te mają charakter jedynie poglądowy.

- Numery kolorów w niniejszej instrukcji zgodnie są z marką nici do haftowania, chyba że podano inaczej.
- Wzory oznaczone symbolem ● zostały obrócone. Przed rozpoczęciem haftowania sprawdź ułożenie projektu.
- ★ Aby uzyskać informacje na temat haftowania aplikacji, należy zapoznać się z instrukcją obsługi hafciarki.

◆ Embroidery Patterns

◆ Broderimønstre

◆ Hímzsminták

◆ Modele de broderie

- "Featured" Designs
- Udvalgte-designs
- „Kiemelt” minták
- Modele promovate

◆ Broderimönster

◆ Vzory vyšívání

◆ Wzory haftu

- Utvalda mönster
- Propagované návrhy
- Wzory „Wyróżnione”



● No. 001

92 min	
1	(001)
2	(804)
3	(019)
4	(804)
5	(085)
6	(126)
7	(070)
8	(086)
9	(085)
10	(206)
11	(513)
12	(005)
13	(001)

Order to embroider
Ordningsföljd vid brodering
Rækkefølge for broderi
Příkaz k vyšívání
Hímzési sorrend
Zamów do wyhaftowania
Ordinea de brodat

Embroidery thread color
Tidsåtgång för broderiet
Tidsforbrug for broderi
Barva vyšívací nitě
Hímzőcérna színe
Kolor nici haftu
Culoarea firului folosit la brodat

Time required for embroidering
Tidsåtgång för broderiet
Tidsforbrug for broderi
Požadovaný čas pro vyšívání
Hímzéshez szükséges idő
Czas wymagany do wykonania haftu
Durata necesară pentru efectuarea broderiei

Embroidery thread color number
Brodertrådens färgnummer
Trådfarvenummer for broderi
Číslo barvy vyšívací nitě
Hímzőcérna színekódja
Numer koloru nici haftu
Numărul culorii firului folosit la brodat

↓ 195.9 mm
↔ 355.6 mm

Embroidery size
Broderiets storlek
Broderistørrelse
Velikost výšivky
Hímzsméret
Rozmiar haftu
Dimensiunea broderiei

● No. 002

17 min	
1	(804)
2	(070)
3	(399)
↓ 153.6 mm	
↔ 355.3 mm	



No. 004

53 min	
1	(405)
2	(534)
3	(086)
↓ 195.8 mm	
↔ 357.8 mm	

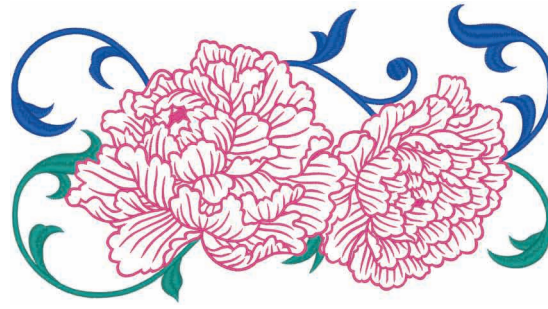

No. 005

8 min	
1	(405)
2	(030)
↓ 197.0 mm	
↔ 64.3 mm	



No. 007



● No. 003

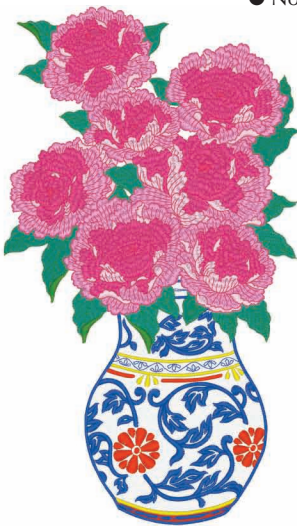

● No. 006



85 min			
1	(070)	8	(502)
2	(612)	9	(328)
3	(542)	10	(206)
4	(612)	11	(027)
5	(810)	12	(010)
6	(027)	13	(328)
7	(328)		
↓ 189.2 mm ↔ 333.4 mm			

195 min					
1	(534)	17	(086)	33	(030)
2	(515)	18	(807)	34	(206)
3	(085)	19	(534)	35	(405)
4	(079)	20	(515)	36	(534)
5	(086)	21	(085)	37	(515)
6	(807)	22	(079)	38	(085)
7	(534)	23	(086)	39	(079)
8	(515)	24	(807)	40	(086)
9	(085)	25	(534)	41	(807)
10	(079)	26	(515)	42	(534)
11	(086)	27	(085)	43	(515)
12	(807)	28	(079)	44	(085)
13	(534)	29	(086)	45	(079)
14	(515)	30	(807)	46	(086)
15	(085)	31	(001)	47	(807)
16	(079)	32	(405)		

↓ 195.2 mm ↔ 342.2 mm

171 min			
1	(030)	14	(513)
2	(509)	15	(206)
3	(612)	16	(010)
4	(804)	17	(027)
5	(027)	18	(328)
6	(328)	19	(509)
7	(513)	20	(513)
8	(328)	21	(328)
9	(206)	22	(206)
10	(027)	23	(027)
11	(010)	24	(205)
12	(328)	25	(328)
13	(509)		

↓ 195.4 mm ↔ 354.8 mm



No. 008

28 min					
1	(534)	9	(126)	17	(019)
2	(542)	10	(017)	18	(126)
3	(534)	11	(534)	19	(348)
4	(017)	12	(399)	20	(030)
5	(030)	13	(030)	21	(534)
6	(019)	14	(534)	22	(019)
7	(126)	15	(017)	23	(017)
8	(019)	16	(126)		

↓ 130.7 mm ↔ 354.0 mm

No. 009



137 min			
1 (001)	17 (707)	33 (810)	49 (001)
2 (010)	18 (810)	34 (804)	50 (804)
3 (124)	19 (124)	35 (502)	51 (124)
4 (810)	20 (810)	36 (542)	52 (010)
5 (804)	21 (707)	37 (001)	53 (810)
6 (502)	22 (001)	38 (707)	54 (124)
7 (542)	23 (010)	39 (502)	55 (707)
8 (001)	24 (124)	40 (399)	56 (001)
9 (707)	25 (810)	41 (804)	57 (017)
10 (010)	26 (804)	42 (707)	58 (804)
11 (124)	27 (502)	43 (010)	59 (502)
12 (810)	28 (542)	44 (124)	60 (542)
13 (804)	29 (001)	45 (707)	61 (001)
14 (502)	30 (707)	46 (017)	62 (707)
15 (542)	31 (010)	47 (804)	
16 (001)	32 (124)	48 (707)	

↓ 176.3 mm ↔ 350.9 mm

No. 010



103 min			
1 (001)	13 (001)	25 (804)	37 (017)
2 (810)	14 (010)	26 (810)	38 (804)
3 (124)	15 (017)	27 (399)	39 (810)
4 (017)	16 (542)	28 (707)	40 (124)
5 (804)	17 (001)	29 (001)	41 (707)
6 (399)	18 (010)	30 (010)	42 (001)
7 (707)	19 (707)	31 (124)	43 (017)
8 (010)	20 (804)	32 (810)	44 (804)
9 (017)	21 (707)	33 (804)	45 (542)
10 (542)	22 (001)	34 (542)	46 (502)
11 (001)	23 (542)	35 (707)	47 (399)
12 (707)	24 (124)	36 (001)	48 (707)

↓ 162.6 mm ↔ 349.7 mm

No. 011



37 min	
1 (124)	11 (810)
2 (810)	12 (804)
3 (804)	13 (542)
4 (542)	14 (502)
5 (502)	15 (017)
6 (017)	16 (010)
7 (010)	17 (001)
8 (001)	18 (707)
9 (707)	19 (399)
10 (124)	20 (707)

↓ 97.1 mm ↔ 122.6 mm

No. 012



27 min	
1 (214)	
2 (085)	
3 (019)	
4 (542)	
5 (085)	
6 (405)	

↓ 122.9 mm
↔ 151.0 mm

No. 017



8 min	
1 (869)	
2 (707)	

↓ 195.4 mm
↔ 53.9 mm

No. 013



15 min	
1 (214)	
2 (405)	
3 (019)	
4 (542)	

↓ 161.3 mm
↔ 58.0 mm

No. 018



13 min	
1 (058)	
2 (707)	
3 (058)	
4 (869)	
5 (707)	

↓ 54.9 mm
↔ 124.8 mm

No. 014



6 min	
1 (019)	
2 (085)	

↓ 57.6 mm
↔ 57.6 mm

No. 019



No. 015



36 min	
1 (399)	
2 (515)	
3 (517)	
4 (107)	
5 (807)	
6 (001)	
7 (900)	
8 (001)	
9 (515)	
10 (517)	
11 (107)	
12 (807)	
13 (086)	
14 (001)	
15 (900)	
16 (001)	

↓ 195.6 mm
↔ 47.6 mm

34 min	
1 (001)	11 (126)
2 (017)	12 (206)
3 (502)	13 (502)
4 (126)	14 (206)
5 (399)	15 (085)
6 (206)	16 (017)
7 (126)	17 (502)
8 (804)	18 (704)
9 (085)	19 (001)
10 (017)	

↓ 56.0 mm ↔ 293.9 mm

No. 016



22 min	
1 (399)	
2 (515)	
3 (517)	
4 (107)	
5 (807)	
6 (086)	
7 (001)	
8 (900)	

↓ 53.9 mm
↔ 112.4 mm

No. 020



16 min	
1 (900)	
2 (001)	
3 (208)	
4 (513)	
5 (612)	
6 (019)	
7 (086)	
8 (807)	

↓ 49.6 mm
↔ 120.5 mm

No. 021



26 min	
1	(515)
2	(030)
3	(001)
4	(005)
5	(019)
6	(126)
7	(707)
8	(126)
9	(005)
10	(323)
11	(017)
12	(206)
13	(030)
14	(019)
15	(515)
16	(019)
17	(030)
18	(005)
19	(001)
20	(707)

↓ 190.6 mm
 ↔ 62.2 mm

No. 022



11 min	
1	(001)
2	(019)
3	(323)
4	(214)
5	(030)
6	(206)
7	(058)
8	(126)
9	(017)

↓ 53.6 mm
 ↔ 56.7 mm

No. 023



21 min	
1	(086)
2	(307)
3	(206)
4	(001)
5	(017)
6	(085)
7	(707)
8	(086)
9	(515)
10	(323)
11	(206)
12	(001)
13	(307)
14	(323)
15	(005)
16	(707)

↓ 174.4 mm
 ↔ 58.1 mm

No. 024



11 min	
1	(126)
2	(513)
3	(542)
4	(001)
5	(005)
6	(124)
7	(542)
8	(058)
9	(126)
10	(086)
11	(019)
12	(206)

↓ 55.2 mm
 ↔ 49.0 mm

No. 025



49 min	
1	(517)
2	(515)
3	(810)
4	(030)
5	(209)
6	(620)
7	(869)
8	(328)
9	(517)
10	(515)
11	(214)
12	(328)
13	(517)
14	(515)
15	(030)
16	(337)
17	(620)
18	(869)
19	(810)
20	(030)
21	(209)
22	(517)
23	(515)
24	(869)
25	(030)
26	(209)
27	(517)
28	(515)
29	(620)
30	(328)
31	(620)
32	(517)
33	(515)
34	(030)
35	(209)
36	(810)
37	(030)
38	(620)
39	(869)

↓ 138.9 mm ↔ 277.0 mm

No. 026



21 min	
1	(517)
2	(515)
3	(030)
4	(337)
5	(030)
6	(209)
7	(517)
8	(515)
9	(869)
10	(620)
11	(030)
12	(209)
13	(810)
14	(030)
15	(214)
16	(328)
17	(517)
18	(515)
19	(810)
20	(869)

↓ 142.8 mm ↔ 120.7 mm

No. 027



18 min	
1	(030)
2	(209)
3	(517)
4	(515)
5	(214)
6	(328)
7	(810)
8	(869)
9	(517)
10	(515)
11	(214)
12	(328)
13	(810)
14	(869)
15	(810)
16	(030)
17	(209)

↓ 195.3 mm ↔ 59.3 mm

No. 028



4 min	
1	(030)
2	(209)
3	(517)
4	(515)

↓ 47.1 mm
 ↔ 41.3 mm

No. 029



No. 026

46 min					
1	(019)	9	(613)	17	(613)
2	(328)	10	(807)	18	(807)
3	(534)	11	(328)	19	(214)
4	(613)	12	(534)	20	(534)
5	(019)	13	(019)	21	(019)
6	(328)	14	(613)	22	(328)
7	(214)	15	(807)	23	(019)
8	(807)	16	(328)	24	(534)

↓ 195.2 mm ↔ 342.2 mm

No. 030



2 min	
1	(328)
2	(613)

↓ 12.5 mm
 ↔ 95.6 mm

No. 031



4 min	
1	(328)
2	(613)

↓ 29.2 mm
 ↔ 95.7 mm

No. 032



5 min	
1	(534)
2	(019)
3	(328)
4	(019)
5	(534)

↓ 56.3 mm
 ↔ 44.5 mm



No. 033

15 min	
1	(348)
2	(328)
↓ 141.8 mm	
↔ 142.9 mm	



No. 034

6 min	
1	(399)
↓ 121.0 mm	
↔ 113.9 mm	

No. 035

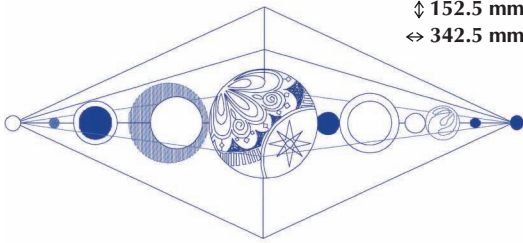

13 min	
1	(070)
2	(406)
3	(070)
4	(406)
↓ 152.5 mm	
↔ 342.5 mm	



No. 036

7 min			
1	(607)	5	(079)
2	(420)	6	(086)
3	(206)	7	(019)
4	(214)	8	(007)
↓ 24.6 mm ↔ 114.6 mm			



No. 038

30 min			
1	(079)	7	(206)
2	(086)	8	(214)
3	(019)	9	(079)
4	(607)	10	(086)
5	(420)	11	(007)
6	(001)	12	(420)
↓ 59.0 mm ↔ 192.3 mm			



No. 037

6 min			
1	(607)	5	(079)
2	(420)	6	(086)
3	(206)	7	(007)
4	(214)	8	(420)
↓ 38.5 mm ↔ 64.0 mm			



No. 039

11 min	
1	(399)
2	(614)
3	(007)
4	(900)
5	(399)
6	(001)
7	(005)
↓ 47.2 mm	
↔ 85.3 mm	



No. 040

10 min	
1	(107)
2	(007)
3	(214)
4	(328)
↓ 66.6 mm	
↔ 68.8 mm	

- "Steam Punk" Designs
- "Steam Punk"-design
- „Steam Punk” minták
- Modele „Steam Punk”

- Steampunk-mönster
- Návrhy Steam Punk
- Wzory „Steam Punk”



No. 001



110 min			
1	(328)	9	(542)
2	(058)	10	(058)
3	(005)	11	(817)
4	(704)	12	(704)
5	(328)	13	(323)
6	(058)	14	(058)
7	(328)	15	(869)
8	(005)	16	(328)
17	(058)	25	(058)
18	(328)	26	(707)
19	(058)	27	(704)
20	(817)	28	(214)
21	(542)	29	(058)
22	(704)		
23	(005)		
24	(323)		

↓ 195.9 mm ↔ 355.4 mm

No. 002



30 min			
1	(058)	9	(005)
2	(005)	10	(058)
3	(328)	11	(005)
4	(704)	12	(707)
5	(869)	13	(542)
6	(323)	14	(707)
7	(058)	15	(005)
8	(323)		

↓ 114.7 mm ↔ 126.7 mm

No. 003



53 min			
1	(843)	5	(058)
2	(328)	6	(328)
3	(058)	7	(058)
4	(328)	8	(328)
9	(058)	13	(817)
10	(214)	14	(058)
11	(707)		
12	(005)		

↓ 167.1 mm ↔ 231.4 mm



No. 004

37 min			
1 (005)	4 (323)	7 (005)	10 (058)
2 (817)	5 (328)	8 (058)	11 (704)
3 (058)	6 (058)	9 (328)	12 (707)

↓ 115.7 mm ↔ 231.0 mm



No. 007

52 min	
1 (607)	4 (900)
2 (542)	5 (807)
3 (807)	6 (612)
4 (900)	7 (542)
5 (807)	8 (900)
6 (612)	9 (807)

↓ 195.8 mm
 ↔ 194.7 mm



No. 005

32 min				
1 (328)	5 (005)	9 (707)	13 (058)	17 (542)
2 (058)	6 (704)	10 (005)	14 (869)	18 (707)
3 (328)	7 (707)	11 (704)	15 (005)	
4 (058)	8 (817)	12 (328)	16 (058)	

↓ 58.8 mm ↔ 271.2 mm



No. 008

50 min			
1 (399)	3 (804)		
2 (001)	4 (399)		

↓ 127.5 mm ↔ 325.4 mm



No. 006

15 min	
1 (612)	4 (406)
2 (406)	5 (900)
3 (900)	
4 (406)	
5 (900)	

↓ 96.8 mm
 ↔ 303.0 mm

- "Quilt" Designs
- "Quilt"-design
- „Steppelt” minták
- Modele pentru matlasat

- Quiltningsmönster
- Návrhy prošívaní
- Wzory „Projekt pikowania”

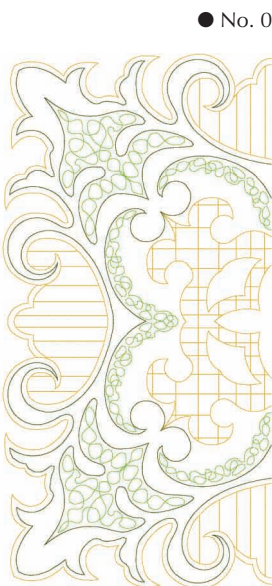

● No. 001

17 min		
1 (517)		
2 (513)		
3 (214)		

↓ 176.6 mm
 ↔ 352.8 mm



No. 002

5 min	
1 (517)	
2 (214)	

↓ 176.0 mm
 ↔ 88.8 mm



No. 003

7 min		
1 (517)		
2 (030)		
3 (214)		

↓ 92.4 mm
 ↔ 92.4 mm



● No. 004

22 min			
1 (804)			
2 (399)			
3 (804)			
4 (542)			

↓ 177.8 mm
 ↔ 354.9 mm

● No. 005

23 min

- 1 (804)
- 2 (399)
- 3 (804)
- 4 (542)

↓ 175.2 mm
 ↔ 354.5 mm

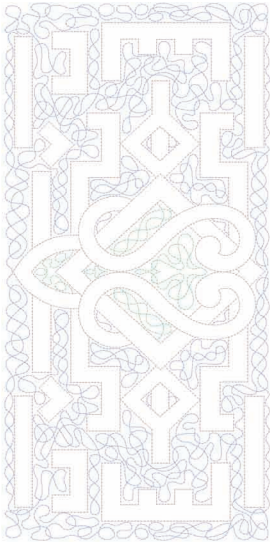

No. 009

5 min

- 1 (019)
- 2 (509)
- 3 (209)
- 4 (509)
- 5 (209)

↓ 92.0 mm
 ↔ 92.5 mm



No. 010

10 min

- 1 (415)
- 2 (620)
- 3 (807)

↓ 195.4 mm
 ↔ 195.4 mm

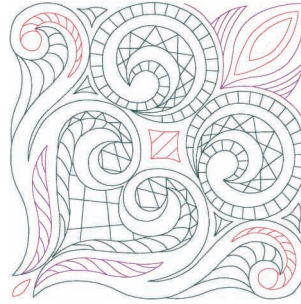

No. 006

10 min

- 1 (804)
- 2 (399)
- 3 (804)
- 4 (399)
- 5 (542)

↓ 176.5 mm
 ↔ 176.5 mm

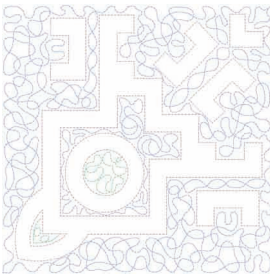

No. 011

15 min

- 1 (807)

↓ 172.5 mm
 ↔ 344.9 mm



No. 007

13 min

- 1 (019)
- 2 (005)
- 3 (509)
- 4 (019)
- 5 (509)

↓ 194.9 mm
 ↔ 194.6 mm

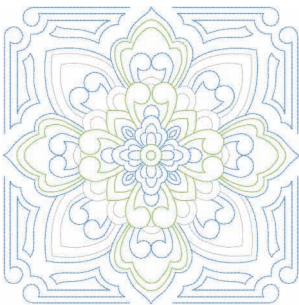

No. 012

8 min

- 1 (807)

↓ 194.5 mm
 ↔ 264.1 mm



No. 008

7 min

- 1 (005)
- 2 (209)
- 3 (509)
- 4 (209)

↓ 195.6 mm
 ↔ 195.6 mm

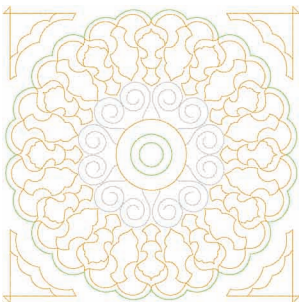

No. 013

12 min

- 1 (030)

↓ 176.9 mm
 ↔ 352.8 mm

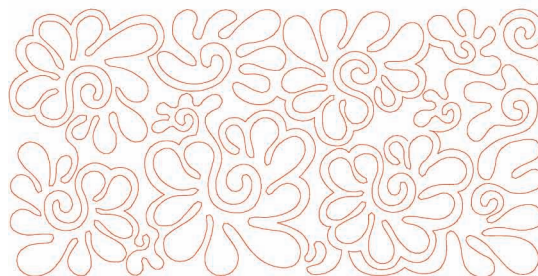

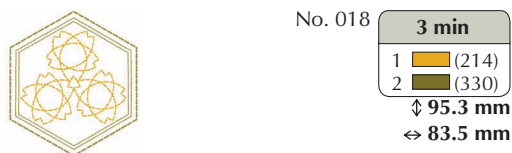
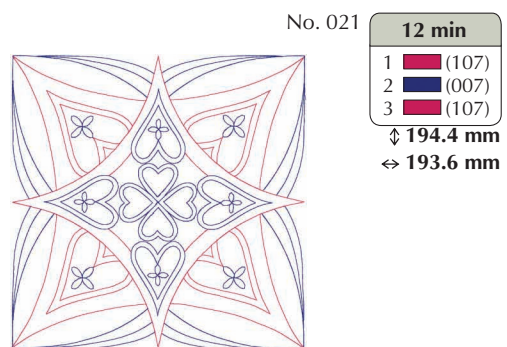
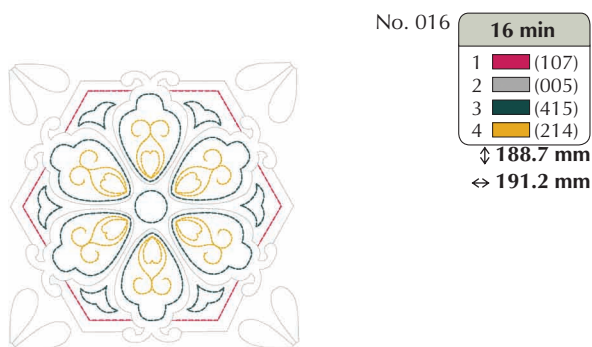
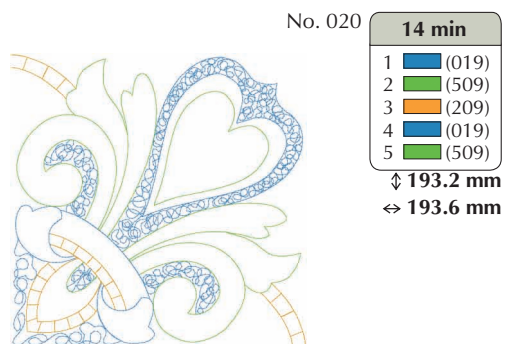
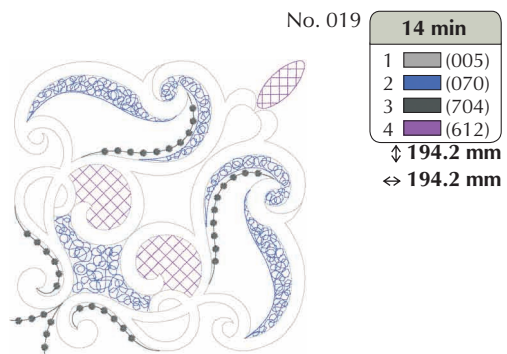

- "Craft" Designs
- Hobby mønstre
- „Művészi” minták
- Modele „Artă”

- Hobbymönster
- Remeslné designy
- Wzory „Artystyczne”



● No. 001



78 min			
1	(070)	21	(086)
2	(085)	22	(900)
3	(086)	23	(613)
4	(085)	24	(070)
5	(810)	25	(406)
6	(085)	26	(900)
7	(206)	27	(206)
8	(810)	28	(542)
9	(085)	29	(509)
10	(086)	30	(086)
11	(206)	31	(206)
12	(542)	32	(509)
13	(070)	33	(613)
14	(613)	34	(542)
15	(406)	35	(070)
16	(542)	36	(406)
17	(509)	37	(509)
18	(086)	38	(613)
19	(206)	39	(086)
20	(070)	40	(206)

↓ 168.3 mm ↔ 355.3 mm

● No. 004



80 min			
1	(030)	16	(019)
2	(001)	17	(307)
3	(337)	18	(214)
4	(307)	19	(307)
5	(019)	20	(019)
6	(214)	21	(214)
7	(307)	22	(517)
8	(019)	23	(812)
9	(214)	24	(515)
10	(307)	25	(058)
11	(058)	26	(001)
12	(001)	27	(307)
13	(030)	28	(030)
14	(337)	29	(214)
15	(307)	30	(058)

↓ 110.8 mm ↔ 244.8 mm

● No. 002



93 min			
1	(085)	19	(542)
2	(086)	20	(070)
3	(085)	21	(406)
4	(124)	22	(086)
5	(085)	23	(900)
6	(124)	24	(542)
7	(085)	25	(086)
8	(086)	26	(085)
9	(124)	27	(612)
10	(070)	28	(070)
11	(612)	29	(086)
12	(406)	30	(406)
13	(509)	31	(086)
14	(542)	32	(804)
15	(900)	33	(070)
16	(086)	34	(804)
17	(612)	35	(086)
18	(509)		

↓ 195.8 mm ↔ 351.9 mm

No. 005



87 min			
1	(515)	35	(843)
2	(027)	36	(010)
3	(513)	37	(810)
4	(058)	38	(010)
5	(208)	39	(323)
6	(070)	40	(513)
7	(019)	41	(534)
8	(209)	42	(019)
9	(208)	43	(208)
10	(800)	44	(843)
11	(405)	45	(010)
12	(058)	46	(810)
13	(513)	47	(010)
14	(534)	48	(323)
15	(019)	49	(070)
16	(208)	50	(208)
17	(843)	51	(001)
18	(010)	52	(058)
19	(810)	53	(010)
20	(010)	54	(070)
21	(323)	55	(058)
22	(513)	56	(620)
23	(534)	57	(513)
24	(019)	58	(534)
25	(208)	59	(707)
26	(843)	60	(208)
27	(010)	61	(513)
28	(810)	62	(534)
29	(010)	63	(707)
30	(323)	64	(208)
31	(513)	65	(070)
32	(534)	66	(900)
33	(019)	67	(843)
34	(208)	68	(800)

↓ 199.0 mm ↔ 199.0 mm

● No. 003

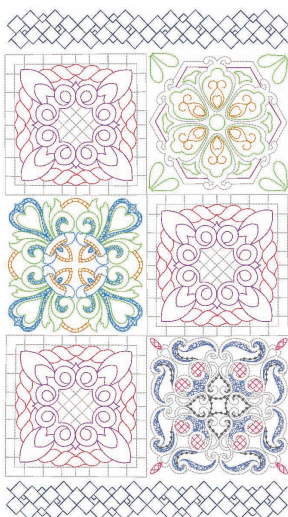

52 min			
1	(005)	13	(005)
2	(620)	14	(620)
3	(509)	15	(807)
4	(209)	16	(005)
5	(509)	17	(620)
6	(019)	18	(807)
7	(509)	19	(005)
8	(209)	20	(620)
9	(005)	21	(807)
10	(817)	22	(005)
11	(070)	23	(406)
12	(086)		

↓ 193.8 mm ↔ 348.8 mm

● No. 006



102 min			
1	(070)	30	(607)
2	(399)	31	(804)
3	(517)	32	(704)
4	(513)	33	(214)
5	(509)	34	(399)
6	(804)	35	(517)
7	(399)	36	(804)
8	(517)	37	(613)
9	(804)	38	(070)
10	(613)	39	(607)
11	(070)	40	(804)
12	(607)	41	(704)
13	(804)	42	(214)
14	(704)	43	(399)
15	(214)	44	(214)
16	(399)	45	(517)
17	(517)	46	(070)
18	(804)	47	(607)
19	(613)	48	(214)
20	(070)	49	(399)
21	(607)	50	(214)
22	(804)	51	(517)
23	(704)	52	(070)
24	(214)	53	(607)
25	(399)	54	(214)
26	(517)	55	(517)
27	(804)	56	(804)
28	(613)	57	(517)
29	(070)	58	(804)

↓ 199.9 mm ↔ 299.8 mm

No. 007



56 min			
1	(348)	5	(339)
2	(869)	6	(348)
3	(019)	7	(019)
4	(348)	8	(869)
9	(323)	13	(323)
10	(348)	14	(348)
11	(019)	15	(869)
12	(869)		

↓ 174.4 mm ↔ 345.1 mm

● No. 008



46 min			
1	(323)	15	(807)
2	(328)	16	(070)
3	(517)	17	(405)
4	(513)	18	(513)
5	(070)	19	(209)
6	(328)	20	(328)
7	(206)	21	(513)
8	(807)	22	(328)
9	(405)	23	(206)
10	(209)	24	(807)
11	(807)	25	(405)
12	(030)	26	(070)
13	(209)	27	(030)
14	(206)		

↓ 192.6 mm ↔ 348.0 mm

● No. 009

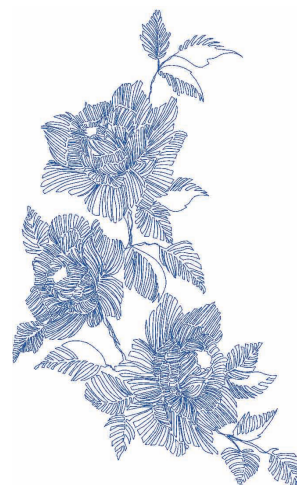

12 min	
1	(405)

↓ 194.6 mm
↔ 325.0 mm

No. 010



47 min	
1	(612)
2	(405)
3	(542)
4	(001)
5	(019)
6	(405)
7	(542)
8	(405)
9	(019)
10	(001)
11	(070)

↓ 153.0 mm ↔ 153.5 mm

No. 011



41 min	
1	(515)
2	(509)
3	(808)
4	(007)
5	(017)
6	(019)
7	(812)
8	(126)
9	(515)
10	(509)
11	(808)
12	(007)
13	(017)
14	(019)
15	(812)
16	(126)
17	(019)
18	(007)
19	(812)
20	(001)
21	(126)
22	(900)
23	(515)
24	(900)

↓ 121.2 mm ↔ 125.6 mm

No. 012



20 min	
1	(399)
2	(900)
3	(205)
4	(612)
5	(405)
6	(209)
7	(019)
8	(085)
9	(509)
10	(807)

↓ 93.3 mm
↔ 93.5 mm

No. 013



20 min

1	(348)
2	(209)
3	(323)
4	(209)
5	(206)
6	(348)
7	(323)
8	(209)

↓ 95.3 mm
↔ 175.3 mm

No. 018



15 min

1	(209)	6	(339)
2	(206)	7	(323)
3	(209)	8	(001)
4	(900)	9	(843)
5	(206)	10	(900)

↓ 55.2 mm ↔ 118.9 mm

No. 019



3 min

1	(328)
---	-------

↓ 58.1 mm
↔ 46.8 mm

No. 014



26 min

1	(348)	5	(209)	9	(348)	13	(209)
2	(209)	6	(348)	10	(209)		
3	(323)	7	(323)	11	(323)		
4	(206)	8	(209)	12	(206)		

↓ 94.7 mm ↔ 295.7 mm

No. 020



121 min

1	(005)	12	(509)	23	(307)
2	(513)	13	(800)	24	(214)
3	(005)	14	(507)	25	(005)
4	(307)	15	(513)	26	(800)
5	(001)	16	(509)	27	(001)
6	(005)	17	(507)	28	(800)
7	(019)	18	(005)	29	(507)
8	(513)	19	(513)	30	(509)
9	(509)	20	(019)	31	(019)
10	(307)	21	(509)	32	(900)
11	(513)	22	(507)		

↓ 195.5 mm ↔ 345.6 mm

No. 015

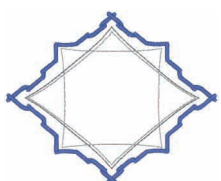

4 min

1	(005)
2	(817)
3	(607)

↓ 77.3 mm
↔ 95.1 mm

★ No. 016



14 min

1	---(800)	5	(348)
2	---(800)	6	(058)
3	---(800)	7	(399)
4	---(800)	8	(328)

↓ 82.5 mm ↔ 81.3 mm

No. 021



34 min

1	(307)	7	(800)	13	(800)	19	(800)
2	(509)	8	(001)	14	(307)	20	(507)
3	(507)	9	(005)	15	(005)	21	(001)
4	(513)	10	(399)	16	(214)	22	(415)
5	(509)	11	(513)	17	(509)	23	(214)
6	(507)	12	(509)	18	(001)		

↓ 54.2 mm ↔ 293.0 mm

No. 017



44 min

1	(202)	11	(019)	21	(513)	31	(513)
2	(019)	12	(202)	22	(507)	32	(507)
3	(513)	13	(126)	23	(019)	33	(613)
4	(507)	14	(030)	24	(202)	34	(086)
5	(086)	15	(086)	25	(613)	35	(030)
6	(019)	16	(202)	26	(086)	36	(405)
7	(613)	17	(001)	27	(202)	37	(513)
8	(001)	18	(513)	28	(001)	38	(202)
9	(126)	19	(507)	29	(126)		
10	(405)	20	(405)	30	(019)		

↓ 55.7 mm ↔ 292.6 mm

No. 022



31 min

1	(208)	5	(339)	9	(005)	13	(323)
2	(001)	6	(005)	10	(900)		
3	(206)	7	(900)	11	(010)		
4	(900)	8	(339)	12	(058)		

↓ 57.0 mm ↔ 289.3 mm

No. 023 **48 min**

1	■ (900)
2	■ (030)

↓ 193.9 mm
 ⇔ 230.4 mm

No. 024 **47 min**

1	■ (900)
2	■ (030)

↓ 196.2 mm
 ⇔ 225.7 mm

No. 025 **20 min**

1	■ (900)
2	■ (030)

↓ 144.9 mm
 ⇔ 125.7 mm

No. 026 **15 min**

1	■ (900)
2	■ (030)

↓ 108.4 mm
 ⇔ 102.1 mm

No. 027 **15 min**

1	■ (900)
2	■ (030)

↓ 95.0 mm
 ⇔ 109.3 mm

No. 028 **21 min**

1	■ (900)
2	■ (030)

↓ 111.6 mm
 ⇔ 143.6 mm

No. 029 **8 min**

1	■ (900)
2	■ (030)

↓ 97.7 mm
 ⇔ 85.6 mm

No. 030 **13 min**

1	■ (900)
2	■ (030)

↓ 96.7 mm
 ⇔ 93.5 mm

No. 031 **10 min**

1	■ (900)
2	■ (030)

↓ 97.7 mm
 ⇔ 73.4 mm

No. 032 **32 min**

1	■ (807)
2	■ (086)
3	■ (612)
4	■ (607)
5	■ (019)
6	■ (405)
7	■ (534)
8	■ (509)
9	■ (206)
10	■ (126)
11	■ (807)

↓ 160.4 mm
 ⇔ 126.0 mm

No.023 Ryuu:Dragon/Drake/Drage/Drak/Sárkány/Smok/Dragon
 No.024 Zen:Zen/Zen/Zen/Zen/Zen/Zen/Zen/Zen
 No.025 Takumi:Artisan/Hantverkare/Håndværker/Řemeslník/Kézműves/Rzemieślnik/Artizan
 No.026 Huku:Good fortune/Lycka till/Held/Stěstěna/Jó szerencsét/Sprzysający los/Noroc
 No.027 Chi:Wisdom/Visdom/Visdom/Moudrost/Bölcsesség/Mądrość/Intelepciune
 No.028 Samurai:Samurai/Samuraj/Samurai/Samuraj/Szamuráj/Samuraj/Samurai
 No.029 Bi:Beauty/Skönhet/Skönhed/Krása/Szépség/Piękno/Frumusețe
 No.030 Ai:Love/Kärlek/Kærlighed/Láska/Szeretet/Miłość/Dragoste
 No.031 Heiwa:Peace/Fred/Fred/Mír/Béke/Pokój/Pace
 No.032 Yume:Dream/Dröm/Drøm/Sen/Álom/Marzenie/Vis

Patterns No.023 – No.032, are designed by Taisen Okamoto.
 Mönster med nr 023–032 har designats av Taisen Okamoto.
 Mönster nr. 023–032 er designet af Taisen Okamoto.
 Vzory č. 023 – č. 032 navrhli Taisen Okamoto.
 A 023–032-es mintákat Taisen Okamoto tervezte.
 Wzory o numerach od 023 do 032 zostały zaprojektowane przez Taisen Okamoto.
 Modelele Nr.023 – Nr.032 sunt create de Taisen Okamoto.

No. 033 **31 min**

1	■ (420)	6	■ (420)	11	■ (399)	16	■ (399)
2	■ (079)	7	■ (079)	12	■ (420)	17	■ (420)
3	■ (017)	8	■ (420)	13	■ (079)	18	■ (001)
4	■ (027)	9	■ (027)	14	■ (027)	19	■ (027)
5	■ (399)	10	■ (017)	15	■ (017)	20	■ (420)

↓ 65.3 mm ⇔ 290.5 mm

No. 034 **27 min**

1	■ (017)	7	■ (420)	13	■ (027)	19	■ (420)
2	■ (420)	8	■ (027)	14	■ (079)	20	■ (017)
3	■ (027)	9	■ (079)	15	■ (399)	21	■ (420)
4	■ (079)	10	■ (399)	16	■ (420)	22	■ (079)
5	■ (399)	11	■ (017)	17	■ (001)	23	■ (027)
6	■ (017)	12	■ (420)	18	■ (027)	24	■ (399)

↓ 99.4 mm ⇔ 174.0 mm



No. 035

18 min

- 1 (607)
- 2 (019)
- 3 (810)
- 4 (070)

↓ 81.7 mm
↔ 279.8 mm



No. 036

9 min

- 1 (607)
- 2 (019)
- 3 (810)
- 4 (070)

↓ 90.6 mm
↔ 92.8 mm



No. 037

132 min

- 1 (509)
- 2 (513)
- 3 (515)
- 4 (027)
- 5 (001)
- 6 (017)
- 7 (542)
- 8 (206)
- 9 (208)
- 10 (509)
- 11 (513)
- 12 (515)
- 13 (027)
- 14 (001)
- 15 (017)
- 16 (542)
- 17 (206)
- 18 (208)

↓ 189.7 mm
↔ 348.9 mm



No. 038

59 min

- 1 (017)
- 2 (804)
- 3 (502)
- 4 (810)
- 5 (001)
- 6 (607)
- 7 (804)
- 8 (019)
- 9 (085)
- 10 (001)

↓ 182.4 mm
↔ 193.4 mm



No. 039

34 min

- 1 (509)
- 2 (017)
- 3 (001)
- 4 (202)
- 5 (079)
- 6 (804)
- 7 (807)
- 8 (027)
- 9 (509)
- 10 (001)
- 11 (202)
- 12 (027)
- 13 (502)
- 14 (017)
- 15 (079)
- 16 (807)
- 17 (027)

↓ 171.5 mm
↔ 125.9 mm



No. 040

119 min

- 1 (348)
- 2 (399)
- 3 (328)
- 4 (001)
- 5 (017)
- 6 (406)
- 7 (328)
- 8 (001)
- 9 (017)
- 10 (019)
- 11 (406)
- 12 (328)
- 13 (001)
- 14 (017)
- 15 (019)
- 16 (406)
- 17 (328)
- 18 (001)
- 19 (017)
- 20 (019)
- 21 (406)
- 22 (328)

↓ 175.1 mm
↔ 348.4 mm



No. 041

49 min

- 1 (800)
- 2 (507)
- 3 (001)
- 4 (620)
- 5 (206)
- 6 (405)
- 7 (800)
- 8 (620)

↓ 193.2 mm
↔ 188.8 mm



No. 042

23 min

- 1 (001)
- 2 (030)
- 3 (019)
- 4 (509)
- 5 (800)
- 6 (509)
- 7 (030)

↓ 67.0 mm
↔ 176.0 mm



No. 043

57 min

- 1 (843)
- 2 (005)
- 3 (843)
- 4 (399)
- 5 (005)
- 6 (804)
- 7 (843)
- 8 (804)
- 9 (399)
- 10 (804)
- 11 (005)
- 12 (843)
- 13 (399)
- 14 (804)
- 15 (005)
- 16 (843)
- 17 (810)

↓ 193.0 mm
↔ 340.5 mm



● No. 044

50 min	
1	(328)
2	(323)
3	(124)
4	(542)
5	(810)
6	(086)
7	(804)
8	(607)
9	(206)
10	(328)

↓ 178.9 mm
 ↔ 341.9 mm

● No. 045



92 min			
1	(509)	21	(515)
2	(810)	22	(534)
3	(515)	23	(509)
4	(534)	24	(202)
5	(085)	25	(085)
6	(086)	26	(107)
7	(810)	27	(085)
8	(612)	28	(086)
9	(202)	29	(810)
10	(534)	30	(509)
11	(509)	31	(810)
12	(614)	32	(534)
13	(107)	33	(107)
14	(509)	34	(612)
15	(534)	35	(614)
16	(085)	36	(086)
17	(810)	37	(202)
18	(086)	38	(612)
19	(612)	39	(107)
20	(107)		

↓ 195.4 mm ↔ 331.7 mm

No. 046



38 min			
1	(509)	10	(085)
2	(515)	11	(614)
3	(810)	12	(612)
4	(086)	13	(107)
5	(810)	14	(202)
6	(085)	15	(107)
7	(612)	16	(086)
8	(515)	17	(509)
9	(534)		

↓ 132.6 mm ↔ 125.8 mm

No. 047



53 min			
1	(509)	9	(614)
2	(810)	10	(612)
3	(515)	11	(202)
4	(534)	12	(085)
5	(086)	13	(807)
6	(085)	14	(612)
7	(534)	15	(085)
8	(509)	16	(086)
17	(807)	25	(807)
18	(534)	26	(085)
19	(509)	27	(612)
20	(515)	28	(614)
21	(534)	29	(202)
22	(202)	30	(807)
23	(807)		
24	(614)		

↓ 89.6 mm ↔ 291.8 mm

★ No. 048



116 min					
1	---><(517)	9	(517)	17	(010)
2	(406)	10	(704)	18	(517)
3	(517)	11	(001)	19	(001)
4	(704)	12	(337)	20	(406)
5	(001)	13	(058)	21	(001)
6	(337)	14	----(517)	22	(406)
7	(058)	15	~~~~(517)	23	(001)
8	(406)	16	(517)	24	(406)

↓ 163.3 mm ↔ 350.1 mm

No. 049



14 min					
1	(206)	5	(206)	9	(206)
2	(086)	6	(001)	10	(807)
3	(019)	7	(085)		
4	(017)	8	(086)		

↓ 48.2 mm ↔ 156.8 mm

No. 050



24 min					
1	(001)	6	(209)	11	(513)
2	(205)	7	(513)	12	(205)
3	(800)	8	(001)	13	(019)
4	(019)	9	(800)		
5	(405)	10	(900)		

↓ 65.1 mm ↔ 153.9 mm

No. 51



10 min					
1	(348)	5	(086)	9	(323)
2	(206)	6	(017)	10	(001)
3	(812)	7	(085)		
4	(206)	8	(513)		

↓ 35.3 mm ↔ 95.6 mm

- "Variety" Designs
- Mange forskellige broderier
- „Egyéb” minták
- Modele „Varietate”

- Varierande designer
- Pestré designy
- Wzory „Różne”



No. 001

6 min	
1	(208)
2	(323)
3	(405)
4	(420)
5	(030)
6	(107)

↓ 48.6 mm
↔ 63.1 mm

No. 008

9 min	
1	(005)
2	(001)
3	(205)
4	(017)
5	(704)
6	(900)

↓ 48.4 mm
↔ 64.2 mm

No. 013

11 min	
1	(614)
2	(900)
3	(209)
4	(800)
5	(030)

↓ 36.4 mm
↔ 93.8 mm

No. 002

4 min	
1	(800)
2	(001)

↓ 37.7 mm
↔ 59.8 mm

No. 009

15 min	
1	(027)
2	(612)
3	(070)
4	(502)
5	(019)
6	(085)
7	(206)
8	(086)
9	(001)
10	(070)

↓ 52.4 mm
↔ 63.0 mm

No. 014

14 min	
1	(406)
2	(507)
3	(513)
4	(205)
5	(513)
6	(612)
7	(019)
8	(001)
9	(086)
10	(328)
11	(800)
12	(205)

↓ 56.1 mm
↔ 71.7 mm

No. 003

8 min	
1	(420)
2	(800)

↓ 94.8 mm
↔ 94.7 mm

No. 010

14 min	
1	(214)
2	(323)
3	(339)
4	(030)
5	(515)
6	(513)
7	(209)
8	(208)
9	(612)
10	(620)
11	(339)

↓ 52.8 mm
↔ 69.3 mm

No. 015

9 min	
1	(001)
2	(017)
3	(206)
4	(807)
5	(612)
6	(515)

↓ 54.5 mm
↔ 76.3 mm

No. 004

2 min	
1	(339)
2	(058)

↓ 26.6 mm
↔ 11.4 mm

No. 011

10 min	
1	(010)
2	(027)
3	(001)
4	(620)
5	(205)
6	(900)
7	(030)
8	(339)
9	(405)
10	(030)

↓ 60.6 mm
↔ 68.2 mm

No. 016

34 min	
1	(205)
2	(206)
3	(107)
4	(030)
5	(800)
6	(307)
7	(843)
8	(001)
9	(399)
10	(005)
11	(323)
12	(058)
13	(205)
14	(206)

↓ 124.6 mm
↔ 76.3 mm

No. 005

1 min	
1	(208)
2	(058)
3	(339)

↓ 28.9 mm
↔ 15.7 mm

No. 006

5 min	
1	(208)
2	(001)
3	(030)
4	(058)

↓ 41.6 mm
↔ 38.1 mm

No. 007

7 min	
1	(005)
2	(323)
3	(214)
4	(900)

↓ 42.7 mm
↔ 58.4 mm

No. 012

10 min	
1	(208)
2	(515)
3	(513)
4	(058)
5	(209)
6	(339)
7	(030)

↓ 50.1 mm
↔ 73.5 mm

No. 017

13 min	
1	(348)
2	(323)
3	(005)
4	(800)
5	(614)
6	(058)
7	(515)
8	(420)
9	(707)

↓ 53.0 mm
↔ 59.4 mm

No. 018



8 min	
1	(205)
2	(208)
3	(030)
4	(019)
5	(415)
6	(513)
7	(509)
8	(001)
9	(704)

↓ 51.3 mm
 ↔ 61.9 mm

No. 024

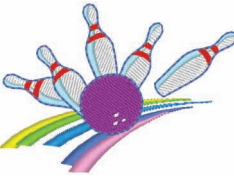

9 min	
1	(205)
2	(513)
3	(019)
4	(070)
5	(810)
6	(001)
7	(017)
8	(800)
9	(620)
10	(070)

↓ 50.7 mm
 ↔ 71.7 mm

No. 029



24 min	
1	(513)
2	(206)
3	(001)
4	(810)
5	(017)
6	(085)
7	(086)
8	(017)
9	(086)
10	(405)
11	(085)

↓ 94.4 mm ↔ 124.2 mm

No. 019



11 min	
1	(030)
2	(208)
3	(900)
4	(208)

↓ 52.5 mm
 ↔ 59.5 mm

No. 025



15 min	
1	(206)
2	(807)
3	(007)
4	(005)
5	(001)
6	(807)
7	(405)
8	(807)
9	(206)
10	(900)
11	(214)

↓ 57.8 mm
 ↔ 58.6 mm

No. 030



7 min	
1	(019)
2	(509)
3	(085)
4	(086)
5	(900)
6	(001)
7	(704)

↓ 51.2 mm
 ↔ 80.6 mm

No. 020



11 min	
1	(001)
2	(307)
3	(348)
4	(005)
5	(704)
6	(019)
7	(030)
8	(614)
9	(214)
10	(900)
11	(001)

↓ 48.5 mm
 ↔ 63.5 mm

No. 026



14 min	
1	(086)
2	(017)
3	(019)
4	(405)
5	(001)
6	(810)
7	(086)
8	(206)

↓ 76.3 mm
 ↔ 73.8 mm

No. 031



5 min	
1	(707)
2	(070)
3	(509)
4	(515)
5	(807)

↓ 43.0 mm
 ↔ 93.1 mm

No. 021



11 min	
1	(001)
2	(208)
3	(030)
4	(607)
5	(513)
6	(420)
7	(900)

↓ 56.8 mm
 ↔ 50.0 mm

No. 027



8 min	
1	(405)
2	(019)
3	(001)
4	(086)
5	(206)
6	(810)
7	(017)

↓ 23.0 mm
 ↔ 95.2 mm

No. 032



4 min	
1	(085)
2	(017)
3	(019)
4	(086)

↓ 45.0 mm
 ↔ 16.2 mm

No. 022



11 min	
1	(323)
2	(005)
3	(205)
4	(513)
5	(515)
6	(107)
7	(209)
8	(001)
9	(030)
10	(900)

↓ 45.0 mm
 ↔ 57.2 mm

No. 028



5 min	
1	(017)
2	(124)
3	(086)
4	(085)
5	(019)

↓ 62.0 mm
 ↔ 46.7 mm

No. 033



10 min	
1	(208)
2	(420)
3	(415)
4	(205)
5	(001)

↓ 77.5 mm
 ↔ 85.3 mm

No. 023

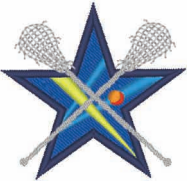

7 min	
1	(405)
2	(019)
3	(027)
4	(209)
5	(030)
6	(007)
7	(005)

↓ 55.4 mm
 ↔ 57.8 mm

No. 034



12 min	
1	(001)
2	(704)
3	(707)
4	(019)
5	(399)
6	(206)
7	(323)
8	(058)
9	(339)

↓ 73.7 mm
 ↔ 81.4 mm

No. 035



6 min

1	(019)
2	(513)
3	(509)
4	(507)
5	(513)

↓ 45.4 mm
↔ 46.2 mm

No. 036



4 min

1	(001)
2	(507)
3	(086)

↓ 35.8 mm
↔ 49.5 mm

No. 037



3 min

1	(202)
2	(001)
3	(507)

↓ 35.4 mm
↔ 21.7 mm

No. 038



25 min

1	(812)
2	(214)
3	(030)
4	(337)
5	(107)
6	(507)

↓ 58.8 mm
↔ 65.1 mm

No. 039



7 min

1	(010)
2	(513)
3	(515)
4	(800)
5	(513)
6	(206)
7	(079)
8	(086)
9	(214)
10	(337)

↓ 32.4 mm
↔ 49.5 mm

No. 040



14 min

1	(001)	7	(513)
2	(017)	8	(086)
3	(019)	9	(214)
4	(214)	10	(800)
5	(205)	11	(339)
6	(058)		

↓ 49.7 mm ↔ 87.7 mm

No. 041



16 min

1	(205)	7	(001)
2	(513)	8	(339)
3	(800)	9	(399)
4	(086)	10	(707)
5	(405)	11	(001)
6	(607)		

↓ 77.2 mm ↔ 70.7 mm

No. 042



4 min

1	(900)
---	-------

↓ 41.4 mm
↔ 69.7 mm

No. 043



9 min

1	(086)	4	(017)
2	(079)	5	(019)
3	(027)	6	(420)

↓ 49.3 mm ↔ 63.3 mm

No. 044



14 min

1	(001)
2	(205)
3	(328)
4	(323)
5	(534)
6	(513)
7	(517)
8	(086)

↓ 65.0 mm
↔ 52.1 mm

No. 045



5 min

1	(519)
---	-------

↓ 28.2 mm
↔ 137.8 mm

No. 046



11 min

1	(843)
2	(348)
3	(079)
4	(323)
5	(337)
6	(513)
7	(058)

↓ 60.1 mm
↔ 44.4 mm

No. 047



12 min

1	(214)
2	(328)
3	(323)
4	(030)
5	(843)
6	(339)

↓ 74.7 mm
↔ 50.0 mm

No. 048



16 min

1	(001)	6	(513)
2	(339)	7	(405)
3	(612)	8	(085)
4	(804)	9	(030)
5	(800)	10	(205)

↓ 50.4 mm ↔ 82.7 mm

No. 049



17 min

1	(001)
2	(019)
3	(205)
4	(209)
5	(085)
6	(030)
7	(900)
8	(405)
9	(339)

↓ 76.5 mm
↔ 69.9 mm

- Common Design Patterns
- Test broderier
- Általános mintázatok
- Modele utilizate frecvent

- Vanliga designmönster
- Běžné vzory designů
- Typowe wzory haftu



No. 001

9 min	
1	(513)
2	(515)
3	(807)
4	(800)
5	(620)
6	(607)
7	(613)
8	(001)
9	(206)

↓ 29.5 mm
↔ 56.6 mm

No. 002

6 min			
1	(323)	6	(800)
2	(507)	7	(085)
3	(513)	8	(612)
4	(205)	9	(420)
5	(209)	10	(900)

↓ 30.0 mm ↔ 96.1 mm

No. 003

6 min	
1	(323)
2	(323)
3	(323)
4	(323)
5	(405)
6	(515)
7	(030)
8	(214)

↓ 94.3 mm
↔ 66.3 mm

For tutorial practice
För kontroll av trådspänningen
Til kontrol af trådspænding
Pro kontrolu napětí niti
A szálfeszesség ellenőrzéséhez
Aby sprawdzić napięcie nici
Pentru a verifica tensiunea firului

For checking the thread tension
För övning
Til prøvesyning
Pro praktické cvičení
Gyakorlászoz
Praktyczna nauka
Pentru exersarea practicilor din cursul introductiv

For tutorial practice of embroidering appliqué
För övningar i att brodera applikationer
Til prøvesyning af applikationsbroderi
Cvičení vyšívání aplikace
A rátétminták hímzésének gyakorlásához
Do ćwiczeń podczas nauki haftowania aplikacji
Pentru notiuni introductive despre broderea aplicațiilor

- ◆ Utility embroidery patterns / Large buttonhole patterns
- ◆ Nyttestingsbroderimønstre/ Store knaphulsmønstre
- ◆ Hasznos öltés hímzsmintához/ Minta nagy gomblyukhoz
- ◆ Modele de broderie utilitară/ Modele de butonieră mare

- ◆ Brodermönster/ Stora knapphålsmönster
- ◆ Užité vyšivací vzory/ Vzory pro velkou knoflíkovou díрку
- ◆ Wzory haftów użytkowych/ Wzory obszycia dużej dziurki na guzik



- Utility embroidery patterns
- Nyttestingsbroderimønstre
- Hasznos öltés hímzsmintához
- Modele de broderie utilitară

- Brodermönster
- Užité vyšivací vzory
- Wzory haftów użytkowych



No. 001

1 min	
1	(900)

↓ 31.5 mm
↔ 0.1 mm

No. 004

1 min	
1	(900)

↓ 16.8 mm
↔ 7.0 mm

No. 007

1 min	
1	(900)

↓ 19.2 mm
↔ 7.0 mm

No. 010

1 min	
1	(900)

↓ 15.8 mm
↔ 9.2 mm

No. 002

1 min	
1	(900)

↓ 30.4 mm
↔ 3.0 mm

No. 005

1 min	
1	(900)

↓ 38.0 mm
↔ 3.0 mm

No. 008

1 min	
1	(900)

↓ 11.0 mm
↔ 7.0 mm

No. 011

1 min	
1	(900)

↓ 19.7 mm
↔ 9.0 mm

No. 003

1 min	
1	(900)

↓ 16.5 mm
↔ 7.0 mm

No. 006

1 min	
1	(900)

↓ 8.4 mm
↔ 7.0 mm

No. 009

1 min	
1	(900)

↓ 19.5 mm
↔ 12.0 mm

No. 012

1 min	
1	(900)

↓ 10.8 mm
↔ 12.0 mm

No. 013

1 min
1 (900)
↓ 11.4 mm
↔ 11.9 mm



No. 021

1 min
1 (900)
↓ 33.0 mm
↔ 12.0 mm



No. 029

1 min
1 (900)
↓ 29.0 mm
↔ 14.9 mm



No. 037

1 min
1 (900)
↓ 48.1 mm
↔ 8.1 mm



No. 014

1 min
1 (900)
↓ 13.6 mm
↔ 13.6 mm



No. 022

1 min
1 (900)
↓ 16.0 mm
↔ 12.4 mm



No. 030

1 min
1 (900)
↓ 15.7 mm
↔ 11.2 mm



No. 038

1 min
1 (900)
↓ 82.3 mm
↔ 19.4 mm



No. 015

1 min
1 (900)
↓ 14.4 mm
↔ 7.0 mm



No. 023

1 min
1 (900)
↓ 15.4 mm
↔ 12.0 mm



No. 031

1 min
1 (900)
↓ 19.1 mm
↔ 11.4 mm



No. 039

1 min
1 (900)
↓ 28.0 mm
↔ 11.9 mm



No. 016

1 min
1 (900)
↓ 38.0 mm
↔ 8.0 mm



No. 024

1 min
1 (900)
↓ 20.8 mm
↔ 12.2 mm



No. 032

1 min
1 (900)
↓ 13.0 mm
↔ 7.9 mm



No. 040

1 min
1 (900)
↓ 16.8 mm
↔ 12.0 mm



No. 017

1 min
1 (900)
↓ 12.6 mm
↔ 8.4 mm



No. 025

1 min
1 (900)
↓ 42.0 mm
↔ 13.2 mm



No. 033

1 min
1 (900)
↓ 21.4 mm
↔ 8.0 mm



No. 041

1 min
1 (900)
↓ 19.2 mm
↔ 12.0 mm



No. 018

1 min
1 (900)
↓ 10.8 mm
↔ 8.4 mm



No. 026

1 min
1 (900)
↓ 16.8 mm
↔ 10.0 mm



No. 034

1 min
1 (900)
↓ 29.7 mm
↔ 11.0 mm



No. 042

1 min
1 (900)
↓ 29.2 mm
↔ 12.0 mm



No. 019

1 min
1 (900)
↓ 15.8 mm
↔ 12.4 mm



No. 027

1 min
1 (900)
↓ 8.7 mm
↔ 8.0 mm



No. 035

1 min
1 (900)
↓ 24.1 mm
↔ 12.0 mm



No. 043

1 min
1 (900)
↓ 17.6 mm
↔ 15.6 mm



No. 020

1 min
1 (900)
↓ 16.8 mm
↔ 7.0 mm



No. 028

1 min
1 (900)
↓ 11.4 mm
↔ 5.0 mm



No. 036

1 min
1 (900)
↓ 45.0 mm
↔ 7.0 mm



No. 044

1 min
1 (900)
↓ 17.6 mm
↔ 9.0 mm



No. 045

1 min
1 ■ (900)
↓ 47.5 mm
↔ 20.0 mm



No. 053

1 min
1 ■ (900)
↓ 13.0 mm
↔ 14.6 mm



No. 061

1 min
1 ■ (900)
↓ 33.7 mm
↔ 40.0 mm



No. 069

1 min
1 ■ (900)
↓ 24.5 mm
↔ 9.0 mm



No. 046

1 min
1 ■ (900)
↓ 16.4 mm
↔ 21.8 mm



No. 054

1 min
1 ■ (900)
↓ 14.4 mm
↔ 11.9 mm



No. 062

1 min
1 ■ (900)
↓ 46.0 mm
↔ 80.0 mm



No. 070

1 min
1 ■ (900)
↓ 57.0 mm
↔ 9.0 mm



No. 047

1 min
1 ■ (900)
↓ 15.5 mm
↔ 14.0 mm



No. 055

1 min
1 ■ (900)
↓ 31.6 mm
↔ 14.9 mm



No. 063

1 min
1 ■ (900)
↓ 65.3 mm
↔ 40.3 mm



No. 071

1 min
1 ■ (900)
↓ 32.0 mm
↔ 10.0 mm



No. 048

1 min
1 ■ (900)
↓ 16.2 mm
↔ 14.8 mm



No. 056

1 min
1 ■ (900)
↓ 39.2 mm
↔ 7.0 mm



No. 064

1 min
1 ■ (900)
↓ 77.3 mm
↔ 19.9 mm



No. 072

1 min
1 ■ (900)
↓ 33.5 mm
↔ 20.0 mm



No. 049

1 min
1 ■ (900)
↓ 18.1 mm
↔ 12.7 mm



No. 057

1 min
1 ■ (900)
↓ 41.8 mm
↔ 9.6 mm



No. 065

1 min
1 ■ (900)
↓ 85.9 mm
↔ 42.1 mm



No. 073

1 min
1 ■ (900)
↓ 37.5 mm
↔ 21.0 mm



No. 050

1 min
1 ■ (900)
↓ 25.2 mm
↔ 15.1 mm



No. 058

1 min
1 ■ (900)
↓ 45.7 mm
↔ 45.9 mm



No. 066

1 min
1 ■ (900)
↓ 50.0 mm
↔ 40.0 mm



No. 074

1 min
1 ■ (900)
↓ 36.0 mm
↔ 20.0 mm



No. 051

1 min
1 ■ (900)
↓ 71.8 mm
↔ 16.9 mm



No. 059

1 min
1 ■ (900)
↓ 35.8 mm
↔ 12.0 mm



No. 067

1 min
1 ■ (900)
↓ 84.0 mm
↔ 42.0 mm



No. 075

1 min
1 ■ (900)
↓ 57.0 mm
↔ 24.5 mm



No. 052

1 min
1 ■ (900)
↓ 50.5 mm
↔ 13.5 mm



No. 060

1 min
1 ■ (900)
↓ 28.0 mm
↔ 39.9 mm



No. 068

1 min
1 ■ (900)
↓ 50.0 mm
↔ 40.0 mm



No. 076

1 min
1 ■ (900)
↓ 30.0 mm
↔ 10.0 mm



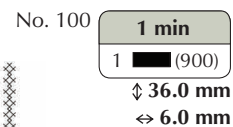
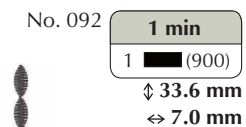
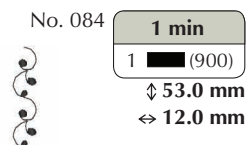
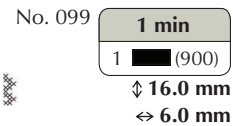
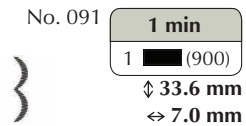
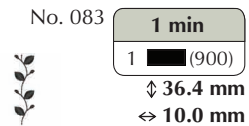
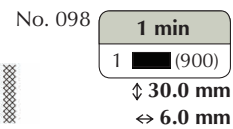
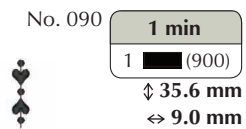
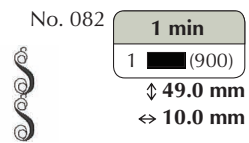
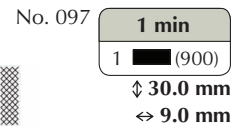
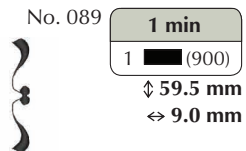
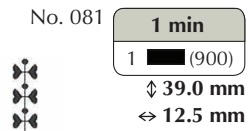
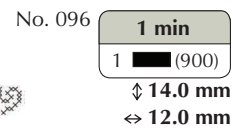
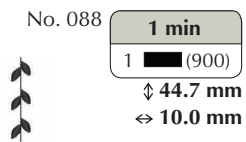
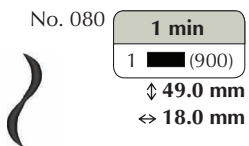
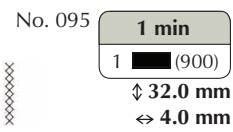
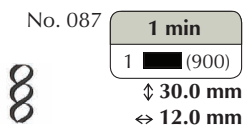
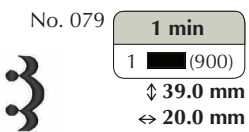
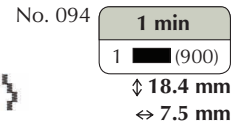
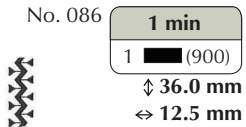
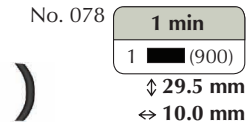
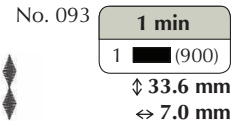
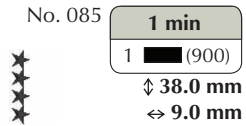
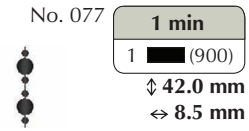

- Large buttonhole patterns
- Store knaphulsmönstre
- Minta nagy gomblyukhoz
- Modele de butonieră mare

- Stora knapphålsmönster
- Vzory pro velkou knoflíkovou díрку
- Wzory obszycia dużej dziurki na guzik



No. 001

L: 2 min	L : ⚡ 9.1 mm
M: 1 min	↔ 99.8 mm
S: 1 min	M : ⚡ 8.5 mm
1 ■ (900)	↔ 75.0 mm
	S : ⚡ 7.9 mm
	↔ 50.0 mm

No. 006

L: 1 min	L : ⚡ 5.8 mm
M: 1 min	↔ 99.9 mm
S: 1 min	M : ⚡ 5.4 mm
1 ■ (900)	↔ 74.9 mm
	S : ⚡ 5.0 mm
	↔ 50.0 mm

No. 002

L: 1 min	L : ⚡ 9.1 mm
M: 1 min	↔ 99.9 mm
S: 1 min	M : ⚡ 8.5 mm
1 ■ (900)	↔ 75.0 mm
	S : ⚡ 7.9 mm
	↔ 50.0 mm

No. 007

L: 2 min	L : ⚡ 9.2 mm
M: 1 min	↔ 100.0 mm
S: 1 min	M : ⚡ 8.4 mm
1 ■ (900)	↔ 75.0 mm
	S : ⚡ 8.0 mm
	↔ 49.9 mm

No. 003

L: 2 min	L : ⚡ 9.1 mm
M: 1 min	↔ 99.8 mm
S: 1 min	M : ⚡ 8.5 mm
1 ■ (900)	↔ 74.9 mm
	S : ⚡ 7.9 mm
	↔ 50.0 mm

No. 008

L: 2 min	L : ⚡ 9.2 mm
M: 1 min	↔ 99.8 mm
S: 1 min	M : ⚡ 8.4 mm
1 ■ (900)	↔ 75.0 mm
	S : ⚡ 8.0 mm
	↔ 50.0 mm

No. 004

L: 1 min	L : ⚡ 5.8 mm
M: 1 min	↔ 99.8 mm
S: 1 min	M : ⚡ 5.4 mm
1 ■ (900)	↔ 74.9 mm
	S : ⚡ 5.0 mm
	↔ 50.0 mm

No. 009

L: 2 min	L : ⚡ 9.1 mm
M: 1 min	↔ 99.9 mm
S: 1 min	M : ⚡ 8.5 mm
1 ■ (900)	↔ 75.0 mm
	S : ⚡ 7.9 mm
	↔ 49.9 mm

No. 005

L: 2 min	L : ⚡ 9.1 mm
M: 1 min	↔ 99.8 mm
S: 1 min	M : ⚡ 8.5 mm
1 ■ (900)	↔ 74.9 mm
	S : ⚡ 7.9 mm
	↔ 50.0 mm

No. 010

L: 2 min	L : ⚡ 9.2 mm
M: 1 min	↔ 100.0 mm
S: 1 min	M : ⚡ 8.6 mm
1 ■ (900)	↔ 74.9 mm
	S : ⚡ 8.0 mm
	↔ 50.0 mm

- ◆ Monograms
- ◆ Monogrammer
- ◆ Monogramok
- ◆ Monograme

- ◆ Monogram
- ◆ Monogramy
- ◆ Monogramy

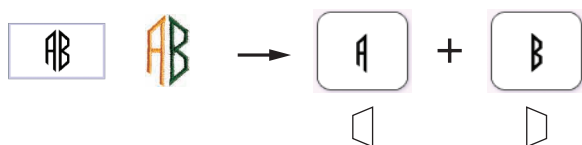
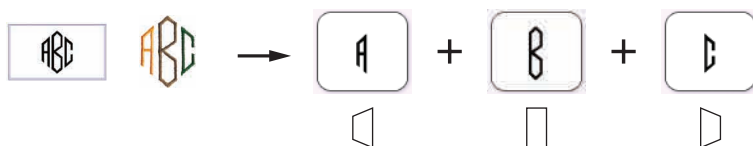

- Monogram Frames
- Monogram-rammer
- Monogram keretek
- Modele cu monograme

- Monogramramar
- Rámečky pro monogramy
- Ramki do monogramów

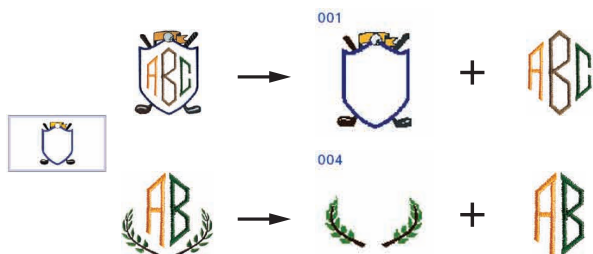

- Monogram Frames
- Monogram-rammer
- Monogram keretek
- Modele cu monograme

- Monogramramar
- Rámečky pro monogramy
- Ramki do monogramów



No. 001

L: 6 min
M: 4 min
S: 3 min
1 (001)
2 (058)
3 (208)
4 (707)
5 (007)

L : \diamond 94.4 mm
 \diamond 73.6 mm
 M : \diamond 64.1 mm
 \diamond 50.1 mm
 S : \diamond 40.9 mm
 \diamond 31.2 mm

No. 008

L: 2 min
M: 2 min
S: 1 min
1 (507)
2 (800)

L : \diamond 94.9 mm
 \diamond 94.4 mm
 M : \diamond 63.6 mm
 \diamond 63.9 mm
 S : \diamond 39.9 mm
 \diamond 40.2 mm

No. 002

L: 6 min
M: 5 min
S: 4 min
1 (001)
2 (513)
3 (208)
4 (007)
5 (900)

L : \diamond 90.1 mm
 \diamond 81.6 mm
 M : \diamond 60.2 mm
 \diamond 54.9 mm
 S : \diamond 38.8 mm
 \diamond 36.1 mm

No. 009

L: 3 min
M: 2 min
S: 1 min
1 (900)
2 (515)
3 (214)

L : \diamond 94.6 mm
 \diamond 72.3 mm
 M : \diamond 59.5 mm
 \diamond 46.0 mm
 S : \diamond 37.2 mm
 \diamond 28.8 mm

No. 003

L: 3 min
M: 2 min
S: 1 min
1 (323)

L : \diamond 93.8 mm
 \diamond 64.5 mm
 M : \diamond 61.4 mm
 \diamond 42.6 mm
 S : \diamond 40.3 mm
 \diamond 27.5 mm

No. 010

L: 2 min
M: 1 min
S: 1 min
1 (534)

L : \diamond 83.4 mm
 \diamond 98.7 mm
 M : \diamond 56.1 mm
 \diamond 66.8 mm
 S : \diamond 35.1 mm
 \diamond 41.8 mm

No. 004

L: 3 min
M: 2 min
S: 2 min
1 (515)
2 (058)

L : \diamond 48.4 mm
 \diamond 92.5 mm
 M : \diamond 31.2 mm
 \diamond 59.5 mm
 S : \diamond 19.1 mm
 \diamond 36.4 mm

No. 011

L: 1 min
M: 1 min
S: 1 min
1 (620)

L : \diamond 25.2 mm
 \diamond 89.4 mm
 M : \diamond 16.8 mm
 \diamond 57.4 mm
 S : \diamond 9.1 mm
 \diamond 34.0 mm

No. 005

L: 2 min
M: 2 min
S: 1 min
1 (205)
2 (085)
3 (612)
4 (800)

L : \diamond 92.5 mm
 \diamond 78.9 mm
 M : \diamond 59.6 mm
 \diamond 50.9 mm
 S : \diamond 34.9 mm
 \diamond 29.7 mm

No. 012

L: 1 min
M: 1 min
S: 1 min
1 (070)
2 (612)

L : \diamond 22.7 mm
 \diamond 90.0 mm
 M : \diamond 14.5 mm
 \diamond 57.3 mm
 S : \diamond 8.9 mm
 \diamond 34.6 mm

No. 006

L: 4 min
M: 2 min
S: 1 min
1 (328)

L : \diamond 77.5 mm
 \diamond 78.2 mm
 M : \diamond 50.0 mm
 \diamond 50.4 mm
 S : \diamond 29.7 mm
 \diamond 29.9 mm

No. 013

L: 1 min
M: 1 min
S: 1 min
1 (208)

L : \diamond 28.3 mm
 \diamond 91.4 mm
 M : \diamond 18.4 mm
 \diamond 59.0 mm
 S : \diamond 11.5 mm
 \diamond 36.1 mm

No. 007

L: 2 min
M: 2 min
S: 1 min
1 (214)
2 (843)

L : \diamond 84.8 mm
 \diamond 84.8 mm
 M : \diamond 55.0 mm
 \diamond 54.9 mm
 S : \diamond 33.9 mm
 \diamond 33.9 mm

No. 014

L: 1 min
M: 1 min
S: 1 min
1 (800)

L : \diamond 24.4 mm
 \diamond 88.1 mm
 M : \diamond 15.1 mm
 \diamond 56.7 mm
 S : \diamond 8.4 mm
 \diamond 38.9 mm

No. 015

L: 2 min
M: 1 min
S: 1 min
1 (214)
2 (058)

L : \diamond 24.3 mm
 \diamond 54.4 mm
 M : \diamond 15.5 mm
 \diamond 34.7 mm
 S : \diamond 9.3 mm
 \diamond 20.8 mm

◆ Decorative Alphabet Patterns
 ◆ Mønstre med dekorativt alfabet
 ◆ Dekorációs ábécé minták
 ◆ Modele cu alfabet decorativ

◆ Dekorativt alfabete-mönster
 ◆ Vzory dekorativní abecedy
 ◆ Wzory alfabetu dekoracyjnego

- Floral Alphabet (Gold)
- Blomsteralfabet (guld)
- Virágos ábécé (arany)
- Alfabet floral (auriu)

- Blomsteralfabet (guld)
- Květinová abeceda (zlatá)
- Alfabet kwiatowy (Złoty)

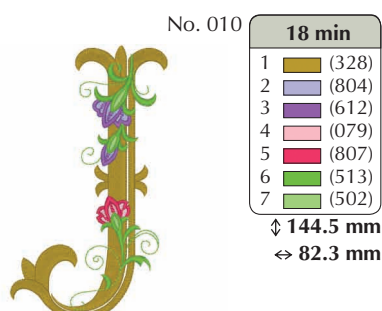
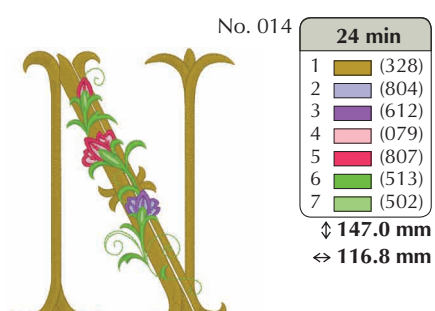
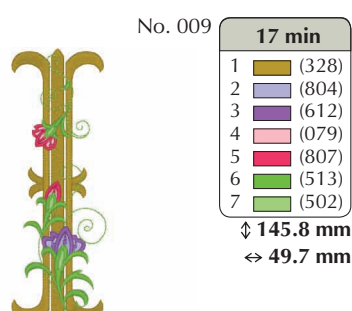
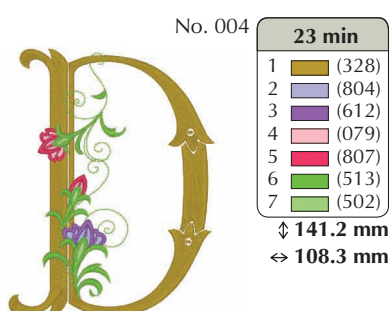
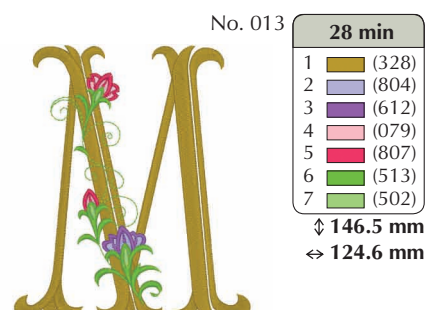
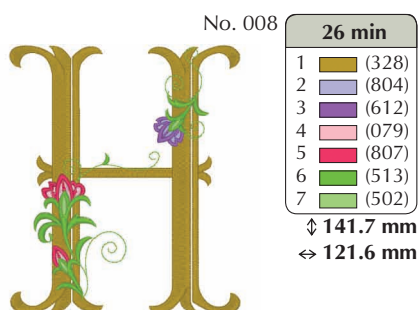
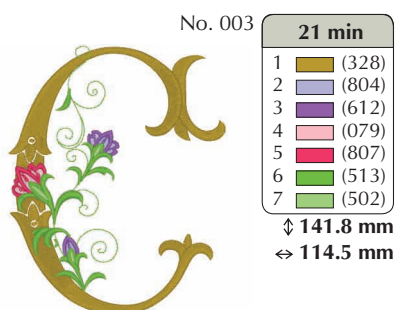
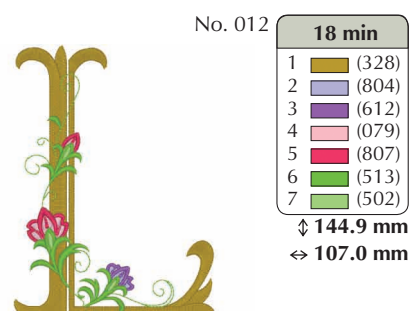
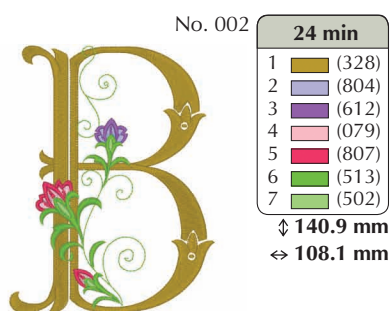
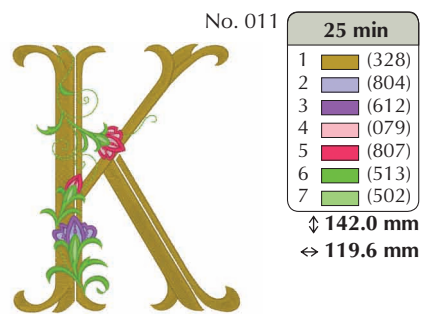
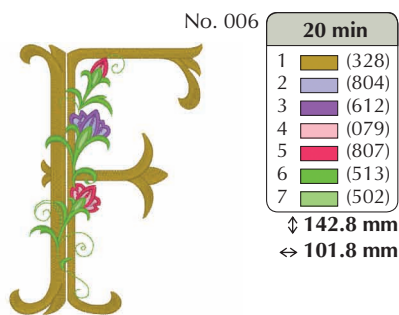
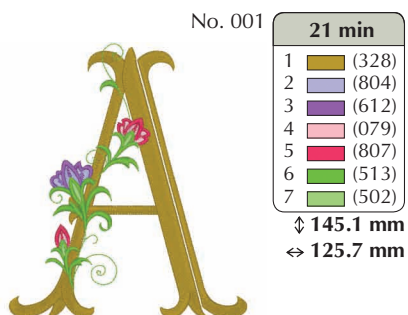

No. 016



21 min	
1	(328)
2	(804)
3	(612)
4	(079)
5	(807)
6	(513)
7	(502)

↓ 143.4 mm
 ↔ 99.6 mm

No. 020



21 min	
1	(328)
2	(804)
3	(612)
4	(079)
5	(807)
6	(513)
7	(502)

↓ 144.5 mm
 ↔ 118.4 mm

No. 024



22 min	
1	(328)
2	(804)
3	(612)
4	(079)
5	(807)
6	(513)
7	(502)

↓ 142.3 mm
 ↔ 115.9 mm

No. 017



25 min	
1	(328)
2	(804)
3	(612)
4	(079)
5	(807)
6	(513)
7	(502)

↓ 142.7 mm
 ↔ 118.2 mm

No. 021



21 min	
1	(328)
2	(804)
3	(612)
4	(079)
5	(807)
6	(513)
7	(502)

↓ 144.6 mm
 ↔ 118.5 mm

No. 025



20 min	
1	(328)
2	(804)
3	(612)
4	(079)
5	(807)
6	(513)
7	(502)

↓ 142.8 mm
 ↔ 116.3 mm

No. 018



25 min	
1	(328)
2	(804)
3	(612)
4	(079)
5	(807)
6	(513)
7	(502)

↓ 143.4 mm
 ↔ 112.5 mm

No. 022



21 min	
1	(328)
2	(804)
3	(612)
4	(079)
5	(807)
6	(513)
7	(502)

↓ 145.5 mm
 ↔ 121.5 mm

No. 026



23 min	
1	(328)
2	(804)
3	(612)
4	(079)
5	(807)
6	(513)
7	(502)

↓ 142.8 mm
 ↔ 92.9 mm

No. 019



25 min	
1	(328)
2	(804)
3	(612)
4	(079)
5	(807)
6	(513)
7	(502)

↓ 144.1 mm
 ↔ 99.4 mm

No. 023



28 min	
1	(328)
2	(804)
3	(612)
4	(079)
5	(807)
6	(513)
7	(502)

↓ 146.2 mm
 ↔ 124.8 mm

◆ Example ◆ Exempel ◆ Eksempel ◆ Příklad
 ◆ Példa ◆ Przykład ◆ Exemplu

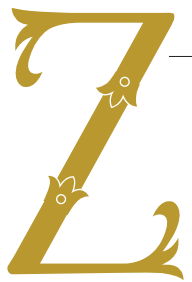

23 min	
1	(328)
2	(804)
3	(612)
4	(079)
5	(807)
6	(513)
7	(502)

↓ 142.8 mm
 ↔ 92.9 mm

No. 027



4 min	
1	(328)
2	(079)
3	(807)
4	(513)
5	(502)

↓ 51.9 mm
 ↔ 45.9 mm

No. 029



4 min	
1	(328)
2	(079)
3	(807)
4	(513)
5	(502)

↓ 52.2 mm
 ↔ 41.1 mm

No. 031



5 min	
1	(328)
2	(079)
3	(807)
4	(513)
5	(502)

↓ 53.1 mm
 ↔ 37.3 mm

No. 028



4 min	
1	(328)
2	(079)
3	(807)
4	(513)
5	(502)

↓ 51.7 mm
 ↔ 39.6 mm

No. 030



4 min	
1	(328)
2	(079)
3	(807)
4	(513)
5	(502)

↓ 51.9 mm
 ↔ 39.3 mm

No. 032



4 min	
1	(328)
2	(079)
3	(807)
4	(513)
5	(502)

↓ 52.1 mm
 ↔ 36.6 mm

No. 033



4 min	
1	(328)
2	(079)
3	(807)
4	(513)
5	(502)

↓ 51.9 mm
↔ 42.7 mm

No. 038



4 min	
1	(328)
2	(079)
3	(807)
4	(513)
5	(502)

↓ 52.5 mm
↔ 38.9 mm

No. 043



4 min	
1	(328)
2	(079)
3	(807)
4	(513)
5	(502)

↓ 52.6 mm
↔ 43.3 mm

No. 048



4 min	
1	(328)
2	(079)
3	(807)
4	(513)
5	(502)

↓ 52.8 mm
↔ 43.9 mm

No. 034



5 min	
1	(328)
2	(079)
3	(807)
4	(513)
5	(502)

↓ 52.2 mm
↔ 44.3 mm

No. 039



6 min	
1	(328)
2	(079)
3	(807)
4	(513)
5	(502)

↓ 53.3 mm
↔ 46.4 mm

No. 044



5 min	
1	(328)
2	(079)
3	(807)
4	(513)
5	(502)

↓ 52.3 mm
↔ 40.7 mm

No. 049



5 min	
1	(328)
2	(079)
3	(807)
4	(513)
5	(502)

↓ 53.3 mm
↔ 46.5 mm

No. 035



4 min	
1	(328)
2	(079)
3	(807)
4	(513)
5	(502)

↓ 53.9 mm
↔ 23.8 mm

No. 040



5 min	
1	(328)
2	(079)
3	(807)
4	(513)
5	(502)

↓ 52.9 mm
↔ 43.1 mm

No. 045



4 min	
1	(328)
2	(079)
3	(807)
4	(513)
5	(502)

↓ 52.6 mm
↔ 35.0 mm

No. 050



4 min	
1	(328)
2	(079)
3	(807)
4	(513)
5	(502)

↓ 51.7 mm
↔ 42.0 mm

No. 036



4 min	
1	(328)
2	(079)
3	(807)
4	(513)
5	(502)

↓ 52.6 mm
↔ 30.1 mm

No. 041



4 min	
1	(328)
2	(079)
3	(807)
4	(513)
5	(502)

↓ 52.8 mm
↔ 42.6 mm

No. 046



4 min	
1	(328)
2	(079)
3	(807)
4	(513)
5	(502)

↓ 53.0 mm
↔ 42.0 mm

No. 051



4 min	
1	(328)
2	(079)
3	(807)
4	(513)
5	(502)

↓ 53.8 mm
↔ 42.2 mm

No. 037



5 min	
1	(328)
2	(079)
3	(807)
4	(513)
5	(502)

↓ 52.4 mm
↔ 43.4 mm

No. 042



4 min	
1	(328)
2	(079)
3	(807)
4	(513)
5	(502)

↓ 52.1 mm
↔ 36.9 mm

No. 047



4 min	
1	(328)
2	(079)
3	(807)
4	(513)
5	(502)

↓ 52.5 mm
↔ 42.8 mm

No. 052



4 min	
1	(328)
2	(079)
3	(807)
4	(513)
5	(502)

↓ 52.4 mm
↔ 33.4 mm

No. 053



4 min	
1	(804)
2	(612)
3	(079)
4	(807)
5	(513)
6	(502)

↓ 34.4 mm
↔ 22.7 mm

No. 055



6 min					
1	(804)	3	(079)	5	(513)
2	(612)	4	(807)	6	(502)

↓ 39.3 mm ↔ 75.4 mm

No. 057



11 min											
1	(804)	7	(804)	13	(079)						
2	(612)	8	(612)	14	(807)						
3	(079)	9	(079)	15	(513)						
4	(807)	10	(807)	16	(502)						
5	(513)	11	(513)								
6	(502)	12	(502)								

↓ 27.9 mm ↔ 121.9 mm

No. 054



2 min	
1	(079)
2	(807)
3	(513)
4	(502)

↓ 39.8 mm
↔ 25.6 mm

No. 056



10 min											
1	(804)	5	(513)	9	(079)						
2	(612)	6	(502)	10	(807)						
3	(079)	7	(804)	11	(513)						
4	(807)	8	(612)	12	(502)						

↓ 23.4 mm ↔ 123.7 mm



No. 058

21 min		
1 (079)	7 (513)	13 (079)
2 (807)	8 (502)	14 (807)
3 (513)	9 (079)	15 (513)
4 (502)	10 (807)	16 (502)
5 (079)	11 (513)	
6 (807)	12 (502)	

↕ 103.6 mm ↔ 94.9 mm



No. 060

9 min	
1 (513)	
2 (807)	
3 (513)	
4 (807)	

↕ 106.7 mm
 ↔ 93.4 mm



No. 063

1 min	
1 (513)	

↕ 147.2 mm
 ↔ 61.8 mm



No. 059

43 min		
1 (079)	17 (513)	33 (804)
2 (807)	18 (502)	34 (612)
3 (804)	19 (079)	35 (513)
4 (612)	20 (807)	36 (502)
5 (513)	21 (804)	37 (079)
6 (502)	22 (612)	38 (807)
7 (079)	23 (513)	39 (804)
8 (807)	24 (502)	40 (612)
9 (804)	25 (079)	41 (513)
10 (612)	26 (807)	42 (502)
11 (513)	27 (804)	43 (079)
12 (502)	28 (612)	44 (807)
13 (079)	29 (513)	45 (804)
14 (807)	30 (502)	46 (612)
15 (804)	31 (079)	47 (513)
16 (612)	32 (807)	48 (502)

↕ 195.4 mm ↔ 157.3 mm



No. 061

6 min	
1 (513)	
2 (807)	
3 (513)	
4 (807)	

↕ 42.6 mm
 ↔ 142.0 mm



No. 064

14 min	
1 (804)	13 (804)
2 (612)	14 (612)
3 (079)	15 (079)
4 (807)	16 (807)
5 (513)	17 (513)
6 (502)	18 (502)
7 (804)	19 (804)
8 (612)	20 (612)
9 (079)	21 (079)
10 (807)	22 (807)
11 (513)	23 (513)
12 (502)	24 (502)

↕ 73.3 mm ↔ 72.8 mm



No. 062

19 min		
1 (513)	4 (807)	7 (513)
2 (807)	5 (513)	8 (807)
3 (513)	6 (807)	

↕ 195.4 mm ↔ 158.5 mm

- Floral Alphabet (Blue)
- Blomsteralfabet (blå)
- Virágos ábécé (kék)
- Alfabet floral (albastru)

- Blomsteralfabet (blått)
- Květinová abeceda (modrá)
- Alfabet kwiatowy (Niebieski)

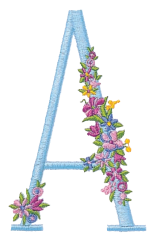

No. 001

15 min	
1	(017)
2	(513)
3	(810)
4	(070)
5	(612)
6	(205)

↓ 125.9 mm
↔ 78.6 mm

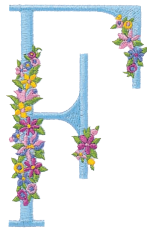

No. 006

21 min	
1	(017)
2	(513)
3	(070)
4	(810)
5	(205)
6	(612)

↓ 125.9 mm
↔ 81.4 mm

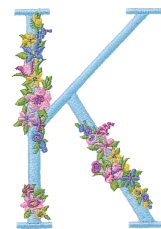

No. 011

21 min	
1	(017)
2	(513)
3	(810)
4	(612)
5	(205)
6	(070)

↓ 125.8 mm
↔ 87.8 mm

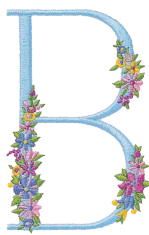

No. 002

19 min	
1	(017)
2	(513)
3	(810)
4	(205)
5	(070)
6	(612)

↓ 127.4 mm
↔ 83.1 mm



No. 007

18 min	
1	(017)
2	(513)
3	(205)
4	(612)
5	(070)
6	(810)

↓ 126.6 mm
↔ 84.0 mm



No. 012

12 min	
1	(017)
2	(513)
3	(810)
4	(205)
5	(612)
6	(070)

↓ 126.0 mm
↔ 77.2 mm



No. 003

15 min	
1	(017)
2	(513)
3	(810)
4	(205)
5	(612)
6	(070)

↓ 125.8 mm
↔ 81.7 mm

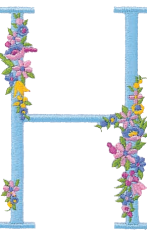

No. 008

18 min	
1	(017)
2	(513)
3	(612)
4	(810)
5	(205)
6	(070)

↓ 126.0 mm
↔ 90.4 mm



No. 013

23 min	
1	(017)
2	(513)
3	(205)
4	(612)
5	(810)
6	(070)

↓ 125.9 mm
↔ 103.7 mm



No. 004

17 min	
1	(017)
2	(513)
3	(205)
4	(810)
5	(612)
6	(070)

↓ 127.2 mm
↔ 86.3 mm



No. 009

11 min	
1	(017)
2	(513)
3	(612)
4	(810)
5	(070)
6	(205)

↓ 125.9 mm
↔ 26.1 mm



No. 014

16 min	
1	(017)
2	(513)
3	(070)
4	(810)
5	(612)
6	(205)

↓ 125.8 mm
↔ 86.6 mm



No. 005

21 min	
1	(017)
2	(513)
3	(810)
4	(070)
5	(612)
6	(205)

↓ 126.1 mm
↔ 85.9 mm



No. 010

10 min	
1	(017)
2	(513)
3	(612)
4	(810)
5	(070)
6	(205)

↓ 125.8 mm
↔ 49.8 mm



No. 015

16 min	
1	(017)
2	(513)
3	(612)
4	(810)
5	(070)
6	(205)

↓ 125.3 mm
↔ 95.0 mm

No. 016



13 min

1	(017)
2	(513)
3	(810)
4	(070)
5	(205)
6	(612)

↓ 126.0 mm
 ↔ 73.4 mm

No. 022

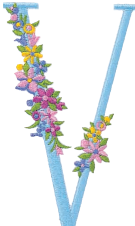

13 min

1	(017)
2	(513)
3	(810)
4	(070)
5	(612)
6	(205)

↓ 126.0 mm
 ↔ 77.8 mm

No. 027



5 min

1	(017)
---	-------

↓ 79.8 mm
 ↔ 58.8 mm

No. 017



22 min

1	(017)
2	(513)
3	(810)
4	(612)
5	(205)
6	(070)

↓ 129.4 mm
 ↔ 95.3 mm

No. 023

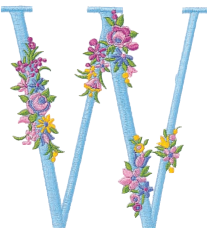

24 min

1	(017)
2	(513)
3	(612)
4	(810)
5	(070)
6	(205)

↓ 125.8 mm
 ↔ 119.4 mm

No. 028



6 min

1	(017)
---	-------

↓ 125.9 mm
 ↔ 60.7 mm

No. 018



17 min

1	(017)
2	(513)
3	(612)
4	(070)
5	(810)
6	(205)

↓ 126.0 mm
 ↔ 83.0 mm

No. 024

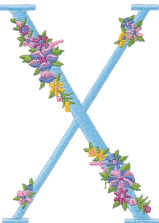

17 min

1	(017)
2	(513)
3	(070)
4	(810)
5	(205)
6	(612)

↓ 126.1 mm
 ↔ 91.6 mm

No. 029



4 min

1	(017)
---	-------

↓ 83.1 mm
 ↔ 56.2 mm

No. 019



15 min

1	(017)
2	(513)
3	(810)
4	(612)
5	(205)
6	(070)

↓ 125.9 mm
 ↔ 70.3 mm

No. 025



15 min

1	(017)
2	(513)
3	(070)
4	(810)
5	(612)
6	(205)

↓ 125.9 mm
 ↔ 84.8 mm

No. 030



6 min

1	(017)
---	-------

↓ 125.9 mm
 ↔ 60.7 mm

No. 020



14 min

1	(017)
2	(513)
3	(810)
4	(205)
5	(612)
6	(070)

↓ 126.1 mm
 ↔ 70.0 mm

No. 026



15 min

1	(017)
2	(513)
3	(810)
4	(205)
5	(612)
6	(070)

↓ 125.9 mm
 ↔ 70.0 mm

No. 031



4 min

1	(017)
---	-------

↓ 82.9 mm
 ↔ 56.7 mm

No. 021

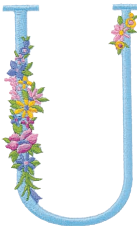

13 min

1	(017)
2	(513)
3	(810)
4	(612)
5	(070)
6	(205)

↓ 126.1 mm
 ↔ 79.9 mm

No. 032



4 min

1	(017)
---	-------

↓ 126.0 mm
 ↔ 55.4 mm

No. 033



8 min

1	(017)
---	-------

↓ 125.9 mm
 ↔ 86.3 mm

h

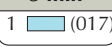
No. 034 **5 min**
1  (017)
↓ 126.0 mm
↔ 62.8 mm

o

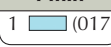
No. 041 **4 min**
1  (017)
↓ 82.0 mm
↔ 55.8 mm

v

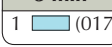
No. 048 **3 min**
1  (017)
↓ 79.8 mm
↔ 56.7 mm

i

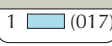
No. 035 **3 min**
1  (017)
↓ 110.0 mm
↔ 19.4 mm

p

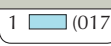
No. 042 **6 min**
1  (017)
↓ 126.0 mm
↔ 68.7 mm

w

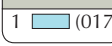
No. 049 **6 min**
1  (017)
↓ 80.0 mm
↔ 82.2 mm

j

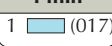
No. 036 **4 min**
1  (017)
↓ 157.9 mm
↔ 39.9 mm

q

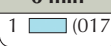
No. 043 **6 min**
1  (017)
↓ 126.0 mm
↔ 68.7 mm

x

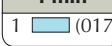
No. 050 **4 min**
1  (017)
↓ 80.0 mm
↔ 59.9 mm

k

No. 037 **6 min**
1  (017)
↓ 126.0 mm
↔ 66.4 mm

r

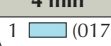
No. 044 **4 min**
1  (017)
↓ 80.5 mm
↔ 54.0 mm

y

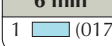
No. 051 **6 min**
1  (017)
↓ 125.8 mm
↔ 84.7 mm

l

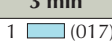
No. 038 **3 min**
1  (017)
↓ 126.0 mm
↔ 19.5 mm

s

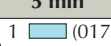
No. 045 **5 min**
1  (017)
↓ 81.1 mm
↔ 50.1 mm

z

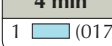
No. 052 **4 min**
1  (017)
↓ 79.9 mm
↔ 52.2 mm

m

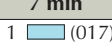
No. 039 **7 min**
1  (017)
↓ 80.1 mm
↔ 90.2 mm

t

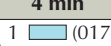
No. 046 **4 min**
1  (017)
↓ 127.1 mm
↔ 51.8 mm

n

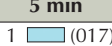
No. 040 **5 min**
1  (017)
↓ 80.0 mm
↔ 65.3 mm

u

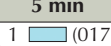
No. 047 **5 min**
1  (017)
↓ 80.0 mm
↔ 65.3 mm



No. 053

6 min	
1	(513)
2	(612)
3	(810)
4	(070)
5	(205)
↓ 95.4 mm	
↔ 24.7 mm	



No. 054

5 min	
1	(513)
2	(810)
3	(612)
4	(205)
5	(070)
↓ 47.9 mm	
↔ 20.5 mm	



No. 055

2 min	
1	(513)
2	(810)
3	(205)
4	(612)
↓ 25.7 mm	
↔ 17.0 mm	



No. 056

2 min	
1	(513)
2	(810)
3	(070)
4	(612)
↓ 25.8 mm	
↔ 24.0 mm	



No. 057

1 min	
1	(513)
2	(070)
3	(810)
↓ 17.9 mm	
↔ 13.1 mm	

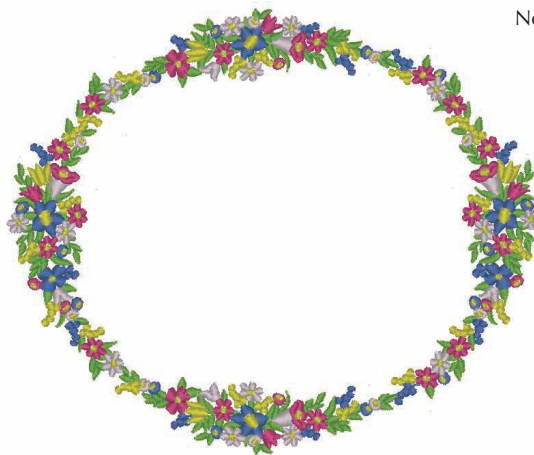

No. 058

66 min	
1	(513)
2	(070)
3	(124)
4	(086)
5	(205)
6	(513)
7	(070)
8	(124)
9	(086)
10	(205)
↓ 198.8 mm	
↔ 239.3 mm	



No. 059

14 min	
1	(513)
2	(070)
3	(810)
4	(612)
5	(205)
↓ 76.2 mm	
↔ 95.8 mm	



No. 060

11 min	
1	(513)
2	(070)
3	(810)
4	(612)
5	(205)
↓ 37.6 mm	
↔ 109.4 mm	



No. 061

9 min	
1	(513)
2	(070)
3	(810)
4	(612)
5	(205)
↓ 41.6 mm	
↔ 79.8 mm	

- Floral Alphabet
- Blomsteralfabet
- Virágos ábécé
- Alfabet floral

- Blomstermönster
- Květinová abeceda
- Kwiatowy alfabet



No. 001

13 min	
1	(214)
2	(348)
3	(019)
4	(515)
5	(030)

↓ 135.5 mm
↔ 132.4 mm

No. 006

10 min	
1	(214)
2	(348)
3	(515)
4	(030)
5	(019)

↓ 117.8 mm
↔ 88.9 mm

No. 011

14 min	
1	(214)
2	(348)
3	(019)
4	(515)
5	(030)

↓ 105.4 mm
↔ 117.7 mm

No. 002

14 min	
1	(214)
2	(348)
3	(030)
4	(515)
5	(019)

↓ 121.4 mm
↔ 92.0 mm

No. 007

14 min	
1	(214)
2	(348)
3	(515)
4	(030)
5	(019)

↓ 139.9 mm
↔ 100.2 mm

No. 012

11 min	
1	(214)
2	(348)
3	(030)
4	(515)
5	(019)

↓ 105.3 mm
↔ 100.1 mm

No. 003

11 min	
1	(214)
2	(348)
3	(030)
4	(515)
5	(019)

↓ 123.1 mm
↔ 102.6 mm

No. 008

12 min	
1	(214)
2	(348)
3	(515)
4	(030)
5	(019)

↓ 127.6 mm
↔ 105.8 mm

No. 013

14 min	
1	(214)
2	(348)
3	(515)
4	(019)
5	(030)

↓ 129.4 mm
↔ 144.5 mm

No. 004

13 min	
1	(214)
2	(348)
3	(515)
4	(030)
5	(019)

↓ 109.5 mm
↔ 104.7 mm

No. 009

8 min	
1	(214)
2	(348)
3	(019)
4	(515)
5	(030)

↓ 123.6 mm
↔ 63.8 mm

No. 014

13 min	
1	(214)
2	(348)
3	(515)
4	(030)
5	(019)

↓ 110.6 mm
↔ 108.6 mm

No. 005

12 min	
1	(214)
2	(348)
3	(030)
4	(515)
5	(019)

↓ 123.1 mm
↔ 102.7 mm

No. 010

8 min	
1	(214)
2	(348)
3	(030)
4	(515)
5	(019)

↓ 140.8 mm
↔ 80.4 mm

No. 015

13 min	
1	(214)
2	(348)
3	(030)
4	(515)
5	(019)

↓ 102.8 mm
↔ 91.1 mm

No. 016



12 min	
1	(214)
2	(348)
3	(030)
4	(515)
5	(019)

↓ 112.1 mm
 ⇔ 101.7 mm

No. 022



10 min	
1	(214)
2	(348)
3	(019)
4	(515)
5	(030)

↓ 126.0 mm
 ⇔ 123.4 mm

No. 027



1 min	
1	(214)
2	(030)
3	(515)

↓ 18.2 mm
 ⇔ 22.4 mm

No. 017



13 min	
1	(214)
2	(348)
3	(019)
4	(515)
5	(030)

↓ 120.7 mm
 ⇔ 93.2 mm

No. 023



13 min	
1	(214)
2	(348)
3	(030)
4	(515)
5	(019)

↓ 102.2 mm
 ⇔ 125.7 mm

No. 028



9 min	
1	(214)
2	(515)
3	(019)
4	(030)

↓ 49.3 mm
 ⇔ 186.1 mm

No. 018



14 min	
1	(214)
2	(348)
3	(019)
4	(515)
5	(030)

↓ 113.9 mm
 ⇔ 110.4 mm

No. 024



15 min	
1	(214)
2	(348)
3	(515)
4	(030)
5	(019)

↓ 103.7 mm
 ⇔ 121.6 mm

No. 029



6 min	
1	(019)
2	(214)
3	(030)

↓ 57.3 mm
 ⇔ 172.8 mm

No. 019



12 min	
1	(214)
2	(348)
3	(019)
4	(515)
5	(030)

↓ 121.0 mm
 ⇔ 93.8 mm

No. 025



11 min	
1	(214)
2	(348)
3	(019)
4	(515)
5	(030)

↓ 138.1 mm
 ⇔ 120.0 mm

No. 030



6 min	
1	(214)
2	(030)
3	(019)

↓ 40.9 mm
 ⇔ 179.5 mm

No. 020



11 min	
1	(214)
2	(348)
3	(019)
4	(515)
5	(030)

↓ 102.5 mm
 ⇔ 104.1 mm

No. 026



12 min	
1	(214)
2	(348)
3	(019)
4	(515)
5	(030)

↓ 104.8 mm
 ⇔ 120.9 mm

No. 021



10 min	
1	(214)
2	(348)
3	(515)
4	(019)
5	(030)

↓ 103.2 mm
 ⇔ 108.0 mm

◆ Example
 ◆ Exempel
 ◆ Eksempel
 ◆ Příklad
 ◆ Példa
 ◆ Przykład
 ◆ Exemplu



13 min	
1	(214)
2	(348)
3	(019)
4	(515)
5	(030)

↓ 135.5 mm
 ⇔ 132.4 mm

- Split Monogram
- Opdelt monogram
- Monogram megosztása
- Monogramă sectionată

- Delat monogram
- Dělený monogram
- Podzielony monogram

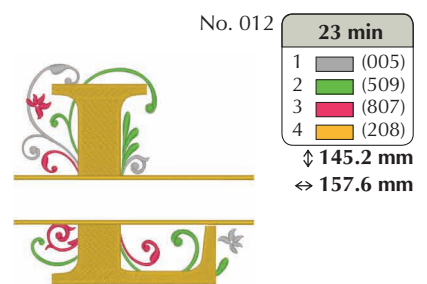
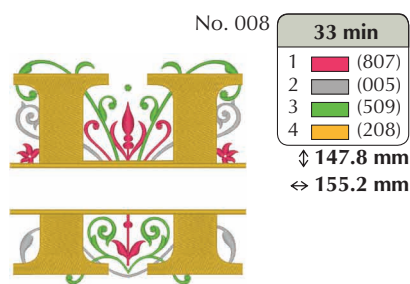
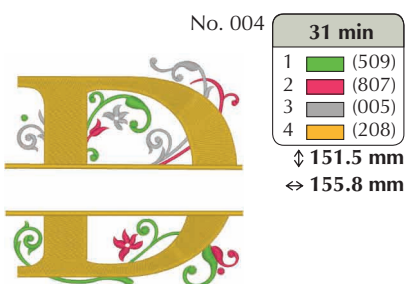
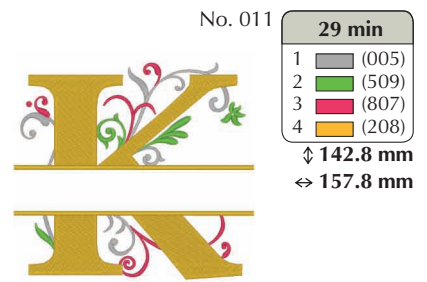
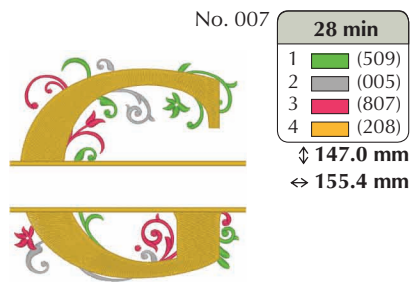
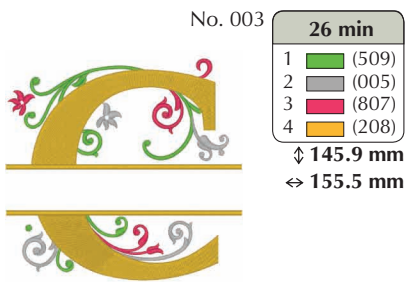
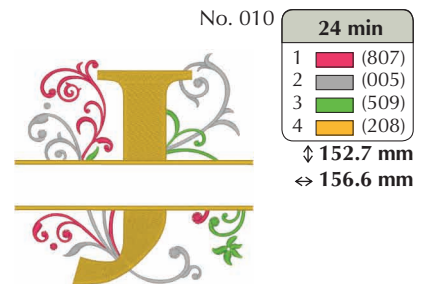
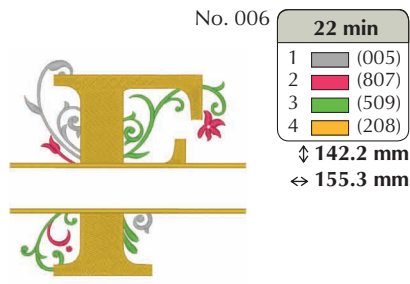
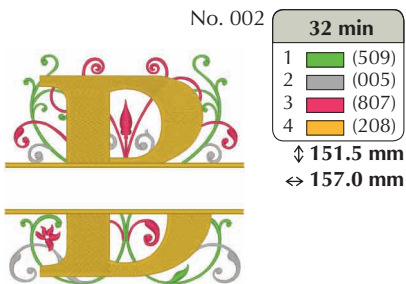
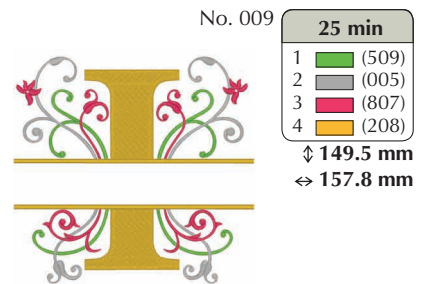
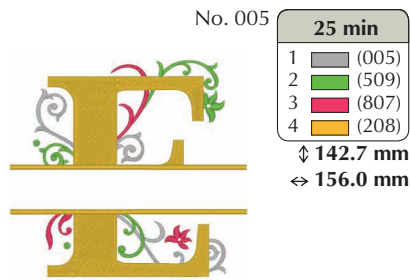
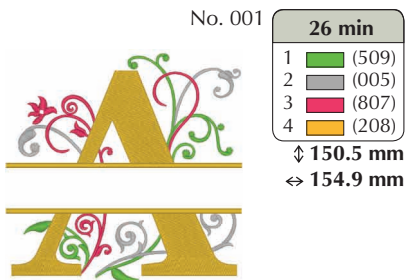

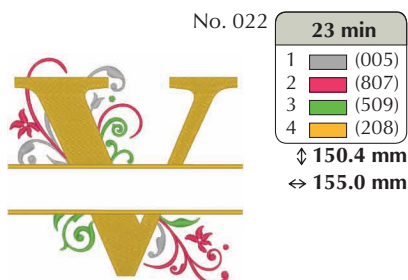
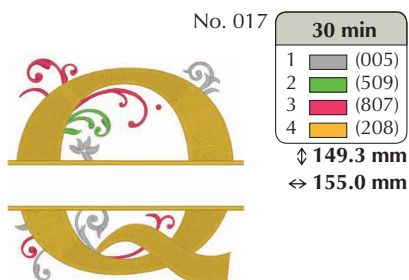
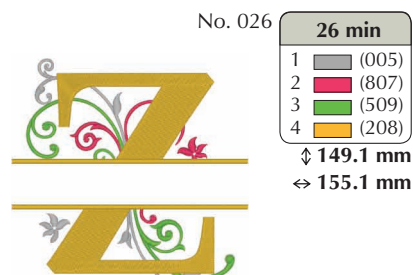
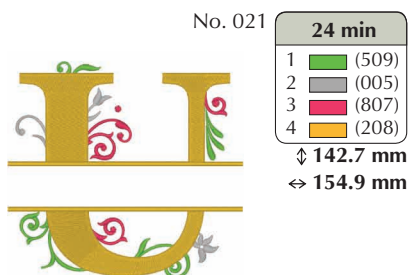
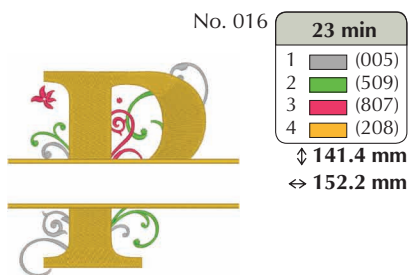
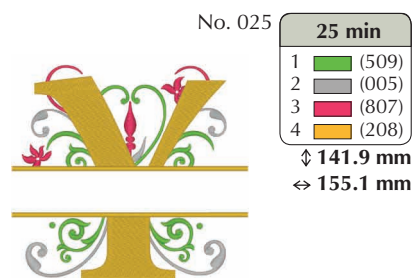
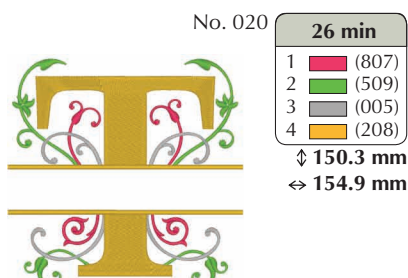
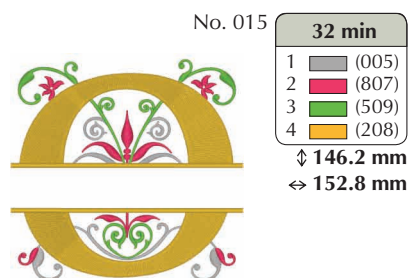
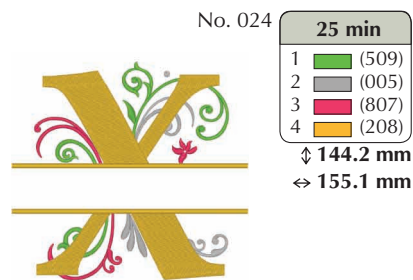
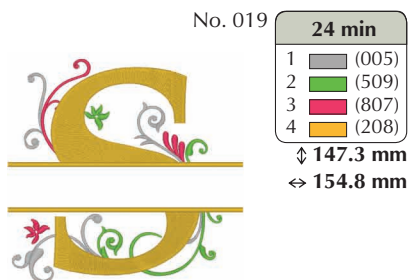
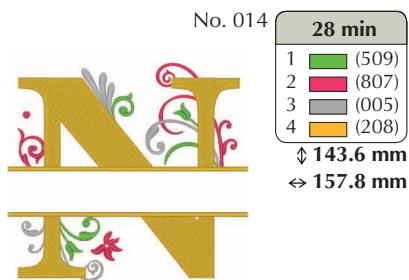
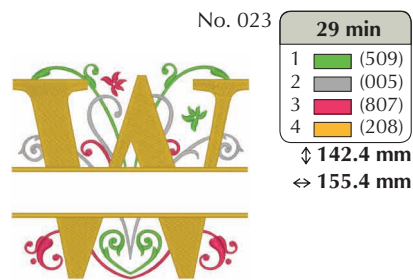
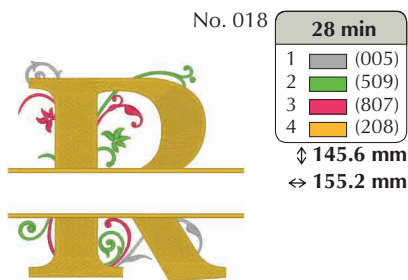

- Calligraphy
- Kalligrafi
- Kalligráfia
- Caligrafie

- Kalligrafi
- Kaligrafie
- Kaligrafia



No. 001

10 min

1 ■ (900)

↓ 129.3 mm

↔ 155.4 mm

No. 005

10 min

1 ■ (900)

↓ 125.6 mm

↔ 84.2 mm

No. 009

8 min

1 ■ (900)

↓ 128.2 mm

↔ 103.8 mm

No. 002

11 min

1 ■ (900)

↓ 132.8 mm

↔ 97.7 mm

No. 006

9 min

1 ■ (900)

↓ 130.3 mm

↔ 118.5 mm

No. 010

10 min

1 ■ (900)

↓ 154.1 mm

↔ 108.5 mm

No. 003

9 min

1 ■ (900)

↓ 127.0 mm

↔ 88.6 mm

No. 007

10 min

1 ■ (900)

↓ 134.2 mm

↔ 82.5 mm

No. 011

13 min

1 ■ (900)

↓ 141.8 mm

↔ 145.5 mm

No. 004

12 min

1 ■ (900)

↓ 125.7 mm

↔ 103.3 mm

No. 008

11 min

1 ■ (900)

↓ 134.2 mm

↔ 143.4 mm

No. 012

12 min

1 ■ (900)

↓ 144.5 mm

↔ 141.7 mm

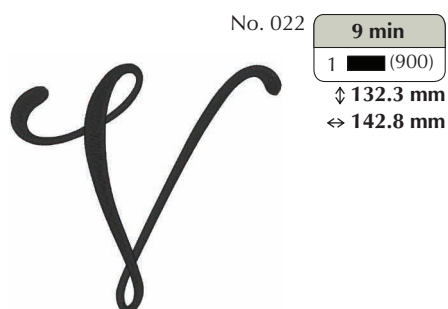
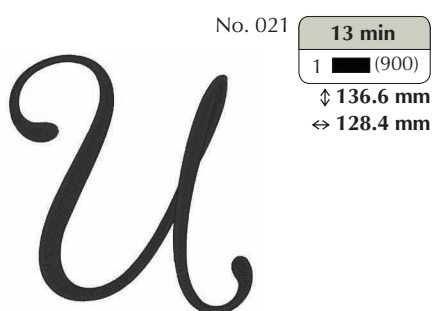
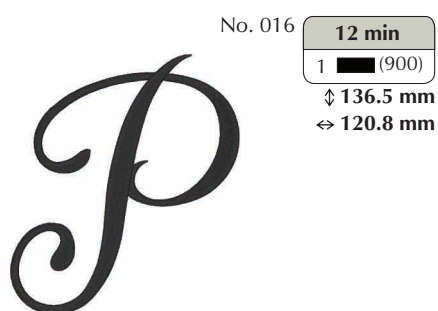
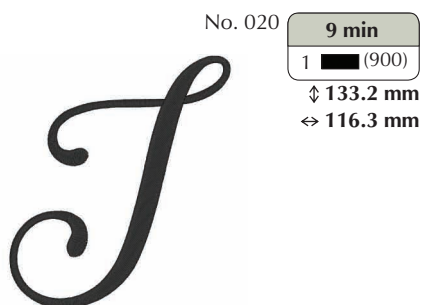
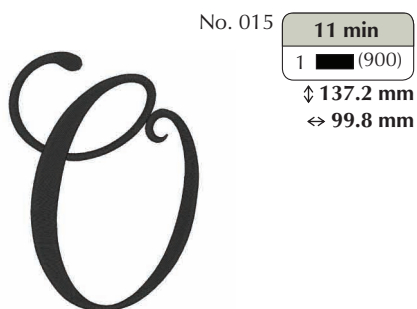
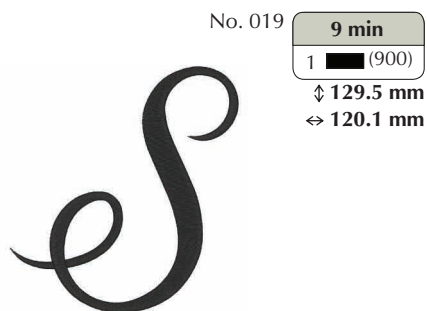
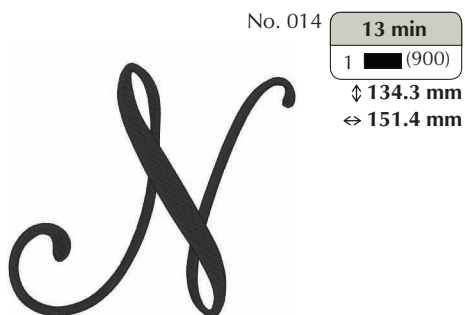
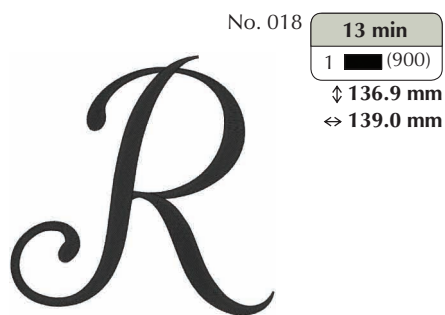
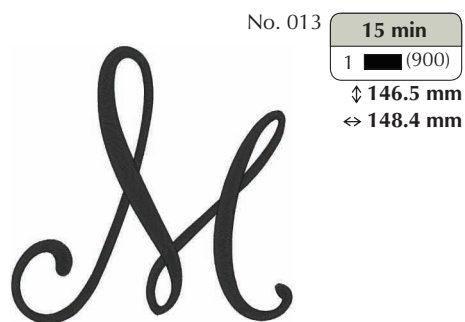

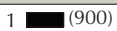
No. 023 **15 min**
1  (900)
↓ 140.0 mm
↔ 158.1 mm





No. 028 **8 min**
1  (900)
↓ 112.6 mm
↔ 55.1 mm





No. 034 **7 min**
1  (900)
↓ 113.2 mm
↔ 58.4 mm





No. 024 **13 min**
1  (900)
↓ 134.4 mm
↔ 117.2 mm





No. 029 **3 min**
1  (900)
↓ 57.8 mm
↔ 45.7 mm





No. 035 **3 min**
1  (900)
↓ 66.2 mm
↔ 31.0 mm





No. 025 **11 min**
1  (900)
↓ 138.1 mm
↔ 95.9 mm



No. 030 **8 min**
1  (900)
↓ 120.5 mm
↔ 75.4 mm





No. 036 **5 min**
1  (900)
↓ 115.3 mm
↔ 58.4 mm





No. 026 **12 min**
1  (900)
↓ 137.6 mm
↔ 148.9 mm





No. 031 **4 min**
1  (900)
↓ 58.9 mm
↔ 47.7 mm





No. 037 **8 min**
1  (900)
↓ 113.4 mm
↔ 61.8 mm





No. 027 **5 min**
1  (900)
↓ 58.0 mm
↔ 62.8 mm



No. 032 **7 min**
1  (900)
↓ 145.7 mm
↔ 49.4 mm





No. 038 **5 min**
1  (900)
↓ 112.9 mm
↔ 44.5 mm





No. 039 **8 min**
1  (900)
↓ 61.5 mm
↔ 80.5 mm





No. 040 **5 min**
1  (900)
↓ 61.6 mm
↔ 61.9 mm



No. 033 **7 min**
1  (900)
↓ 111.4 mm
↔ 63.7 mm



No. 040 **5 min**
1  (900)
↓ 61.6 mm
↔ 61.9 mm



No. 041

4 min
1 ■ (900)
↓ 62.1 mm
↔ 54.0 mm



No. 048

4 min
1 ■ (900)
↓ 61.9 mm
↔ 51.6 mm



No. 055

6 min
1 ■ (900)
↓ 96.0 mm
↔ 71.1 mm



No. 042

6 min
1 ■ (900)
↓ 109.1 mm
↔ 67.3 mm



No. 049

6 min
1 ■ (900)
↓ 61.8 mm
↔ 77.6 mm



No. 056

7 min
1 ■ (900)
↓ 97.9 mm
↔ 62.1 mm



No. 043

7 min
1 ■ (900)
↓ 112.9 mm
↔ 60.8 mm



No. 050

3 min
1 ■ (900)
↓ 58.5 mm
↔ 63.2 mm



No. 057

6 min
1 ■ (900)
↓ 96.0 mm
↔ 62.7 mm



No. 044

4 min
1 ■ (900)
↓ 65.5 mm
↔ 54.5 mm



No. 051

7 min
1 ■ (900)
↓ 112.0 mm
↔ 62.6 mm



No. 052

6 min
1 ■ (900)
↓ 103.9 mm
↔ 69.8 mm



No. 058

6 min
1 ■ (900)
↓ 97.1 mm
↔ 65.9 mm



No. 045

3 min
1 ■ (900)
↓ 64.8 mm
↔ 47.3 mm



No. 046

4 min
1 ■ (900)
↓ 94.2 mm
↔ 44.9 mm



No. 053

6 min
1 ■ (900)
↓ 96.7 mm
↔ 63.0 mm



No. 059

7 min
1 ■ (900)
↓ 101.4 mm
↔ 64.8 mm



No. 047

5 min
1 ■ (900)
↓ 60.6 mm
↔ 64.5 mm



No. 054

3 min
1 ■ (900)
↓ 95.6 mm
↔ 34.9 mm



No. 060

4 min
1 ■ (900)
↓ 95.8 mm
↔ 57.0 mm



No. 061 **7 min**
 1 (900)
 ↓ 95.8 mm
 ⇔ 63.9 mm



No. 068 **7 min**
 1 (900)
 ↓ 125.5 mm
 ⇔ 63.6 mm



No. 074 **1 min**
 1 (900)
 ↓ 41.5 mm
 ⇔ 17.9 mm



No. 062 **6 min**
 1 (900)
 ↓ 108.7 mm
 ⇔ 62.0 mm



No. 069 **4 min**
 1 (900)
 ↓ 125.3 mm
 ⇔ 42.4 mm



No. 075 **1 min**
 1 (900)
 ↓ 47.9 mm
 ⇔ 19.6 mm



No. 076 **1 min**
 1 (900)
 ↓ 16.4 mm
 ⇔ 22.9 mm



No. 063 **8 min**
 1 (900)
 ↓ 95.5 mm
 ⇔ 74.7 mm



No. 070 **9 min**
 1 (900)
 ↓ 93.9 mm
 ⇔ 81.0 mm



No. 077 **1 min**
 1 (900)
 ↓ 16.4 mm
 ⇔ 11.0 mm



No. 064 **2 min**
 1 (900)
 ↓ 34.2 mm
 ⇔ 33.7 mm



No. 071 **4 min**
 1 (900)
 ↓ 131.7 mm
 ⇔ 59.3 mm



No. 078 **8 min**
 1 (900)
 ↓ 88.5 mm
 ⇔ 160.2 mm



No. 065 **1 min**
 1 (900)
 ↓ 10.8 mm
 ⇔ 10.5 mm



No. 072 **4 min**
 1 (900)
 ↓ 132.0 mm
 ⇔ 59.2 mm



No. 079 **8 min**
 1 (900)
 ↓ 75.6 mm
 ⇔ 161.0 mm

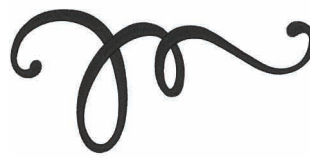

No. 066 **1 min**
 1 (900)
 ↓ 16.5 mm
 ⇔ 11.7 mm



No. 073 **2 min**
 1 (900)
 ↓ 17.7 mm
 ⇔ 65.0 mm



No. 080 **3 min**
 1 (900)
 ↓ 37.1 mm
 ⇔ 123.3 mm



No. 067 **7 min**
 1 (900)
 ↓ 97.4 mm
 ⇔ 74.0 mm



No. 081 **14 min**
 1 (900)
 ↓ 121.1 mm
 ⇔ 189.2 mm

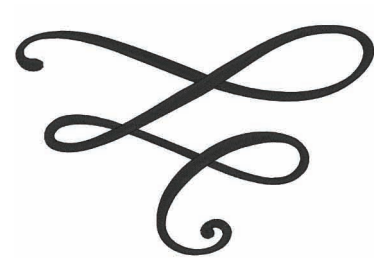

- Vine Alphabet
- Alfabet med vinranker
- Szőlő ábécé
- Alfabet cu modele de viță de vie

- Alfabetet med vinrankor
- Abeceda z vinné révy
- Alfabet z winorośli



No. 001

L: 14 min
S: 5 min
1 (620)
2 (612)

L : \updownarrow 108.6 mm
 \leftrightarrow 165.6 mm
 S : \updownarrow 54.3 mm
 \leftrightarrow 82.8 mm

No. 007

L: 11 min
S: 4 min
1 (620)
2 (612)

L : \updownarrow 109.0 mm
 \leftrightarrow 140.6 mm
 S : \updownarrow 54.3 mm
 \leftrightarrow 70.4 mm

No. 013

L: 13 min
S: 4 min
1 (620)
2 (612)

L : \updownarrow 108.3 mm
 \leftrightarrow 170.0 mm
 S : \updownarrow 54.1 mm
 \leftrightarrow 85.0 mm

No. 002

L: 13 min
S: 4 min
1 (620)
2 (612)

L : \updownarrow 108.7 mm
 \leftrightarrow 145.3 mm
 S : \updownarrow 54.4 mm
 \leftrightarrow 72.6 mm

No. 008

L: 14 min
S: 5 min
1 (620)
2 (612)

L : \updownarrow 108.2 mm
 \leftrightarrow 166.8 mm
 S : \updownarrow 54.3 mm
 \leftrightarrow 83.3 mm

No. 014

L: 12 min
S: 4 min
1 (620)
2 (612)

L : \updownarrow 108.9 mm
 \leftrightarrow 169.4 mm
 S : \updownarrow 54.6 mm
 \leftrightarrow 84.8 mm

No. 003

L: 11 min
S: 4 min
1 (620)
2 (612)

L : \updownarrow 107.6 mm
 \leftrightarrow 146.6 mm
 S : \updownarrow 53.9 mm
 \leftrightarrow 73.3 mm

No. 009

L: 9 min
S: 3 min
1 (620)
2 (612)

L : \updownarrow 109.6 mm
 \leftrightarrow 136.2 mm
 S : \updownarrow 55.0 mm
 \leftrightarrow 68.3 mm

No. 015

L: 9 min
S: 3 min
1 (620)
2 (612)

L : \updownarrow 107.7 mm
 \leftrightarrow 157.4 mm
 S : \updownarrow 53.9 mm
 \leftrightarrow 78.7 mm

No. 004

L: 13 min
S: 4 min
1 (620)
2 (612)

L : \updownarrow 109.4 mm
 \leftrightarrow 159.8 mm
 S : \updownarrow 54.6 mm
 \leftrightarrow 80.0 mm

No. 010

L: 11 min
S: 4 min
1 (620)
2 (612)

L : \updownarrow 108.4 mm
 \leftrightarrow 141.9 mm
 S : \updownarrow 54.3 mm
 \leftrightarrow 71.0 mm

No. 016

L: 11 min
S: 4 min
1 (620)
2 (612)

L : \updownarrow 109.3 mm
 \leftrightarrow 134.2 mm
 S : \updownarrow 54.7 mm
 \leftrightarrow 67.2 mm

No. 005

L: 10 min
S: 4 min
1 (620)
2 (612)

L : \updownarrow 109.9 mm
 \leftrightarrow 130.6 mm
 S : \updownarrow 55.0 mm
 \leftrightarrow 65.3 mm

No. 011

L: 13 min
S: 5 min
1 (620)
2 (612)

L : \updownarrow 110.3 mm
 \leftrightarrow 170.2 mm
 S : \updownarrow 55.2 mm
 \leftrightarrow 85.3 mm

No. 017

L: 11 min
S: 4 min
1 (620)
2 (612)

L : \updownarrow 109.8 mm
 \leftrightarrow 167.1 mm
 S : \updownarrow 54.9 mm
 \leftrightarrow 83.5 mm

No. 006

L: 11 min
S: 4 min
1 (620)
2 (612)

L : \updownarrow 107.8 mm
 \leftrightarrow 157.2 mm
 S : \updownarrow 54.0 mm
 \leftrightarrow 78.8 mm

No. 012

L: 11 min
S: 4 min
1 (620)
2 (612)

L : \updownarrow 107.6 mm
 \leftrightarrow 150.0 mm
 S : \updownarrow 53.9 mm
 \leftrightarrow 75.0 mm

No. 018

L: 14 min
S: 5 min
1 (620)
2 (612)

L : \updownarrow 109.3 mm
 \leftrightarrow 163.0 mm
 S : \updownarrow 54.7 mm
 \leftrightarrow 81.5 mm

No. 019

L: 12 min
S: 4 min
1 (620)
2 (612)

L : \updownarrow 108.8 mm
 \leftrightarrow 147.8 mm
 S : \updownarrow 54.5 mm
 \leftrightarrow 73.8 mm



No. 025

L: 10 min
S: 4 min
1 (620)
2 (612)

L : \updownarrow 106.1 mm
 \leftrightarrow 132.1 mm
 S : \updownarrow 53.1 mm
 \leftrightarrow 65.9 mm



No. 020

L: 11 min
S: 4 min
1 (620)
2 (612)

L : \updownarrow 108.3 mm
 \leftrightarrow 146.5 mm
 S : \updownarrow 54.2 mm
 \leftrightarrow 73.2 mm



No. 026

L: 11 min
S: 4 min
1 (620)
2 (612)

L : \updownarrow 111.8 mm
 \leftrightarrow 140.0 mm
 S : \updownarrow 55.9 mm
 \leftrightarrow 70.0 mm



No. 021

L: 12 min
S: 4 min
1 (620)
2 (612)

L : \updownarrow 107.1 mm
 \leftrightarrow 156.8 mm
 S : \updownarrow 53.6 mm
 \leftrightarrow 78.3 mm



No. 027

L: 7 min
S: 3 min
1 (620)
2 (612)

L : \updownarrow 114.6 mm
 \leftrightarrow 115.2 mm
 S : \updownarrow 57.4 mm
 \leftrightarrow 57.7 mm



No. 022

L: 9 min
S: 4 min
1 (620)
2 (612)

L : \updownarrow 106.1 mm
 \leftrightarrow 142.1 mm
 S : \updownarrow 53.2 mm
 \leftrightarrow 70.9 mm



No. 028

L: 8 min
S: 4 min
1 (620)
2 (612)

L : \updownarrow 62.8 mm
 \leftrightarrow 238.6 mm
 S : \updownarrow 31.5 mm
 \leftrightarrow 119.2 mm



No. 023

L: 14 min
S: 5 min
1 (620)
2 (612)

L : \updownarrow 106.7 mm
 \leftrightarrow 165.2 mm
 S : \updownarrow 53.4 mm
 \leftrightarrow 82.6 mm



No.029

L: 6 min
S: 4 min
1 (620)
2 (612)

L : \updownarrow 24.1 mm
 \leftrightarrow 349.8 mm
 S : \updownarrow 13.4 mm
 \leftrightarrow 195.4 mm



No. 024

L: 12 min
S: 4 min
1 (620)
2 (612)

L : \updownarrow 106.0 mm
 \leftrightarrow 166.6 mm
 S : \updownarrow 53.2 mm
 \leftrightarrow 83.4 mm



No.030

5 min
1 (612)
2 (620)

\updownarrow 184.8 mm
 \leftrightarrow 56.2 mm



- Line Alphabet
- Dekorativt alfabet
- Vonal ábécé
- Alfabet cu linii

- Dekorativt alfabet
- Řádková abeceda
- Alfabet liniowy



No. 001

L: 13 min
S: 9 min
1 (005)
2 (807)

L : ↓ 125.1 mm
 ⇔ 103.3 mm
 S : ↓ 95.9 mm
 ⇔ 79.1 mm

No. 006

L: 14 min
S: 10 min
1 (005)
2 (807)

L : ↓ 124.8 mm
 ⇔ 80.6 mm
 S : ↓ 95.8 mm
 ⇔ 61.8 mm

No. 011

L: 14 min
S: 10 min
1 (005)
2 (807)

L : ↓ 125.0 mm
 ⇔ 95.6 mm
 S : ↓ 95.8 mm
 ⇔ 73.4 mm

No. 002

L: 13 min
S: 9 min
1 (005)
2 (807)

L : ↓ 124.8 mm
 ⇔ 86.6 mm
 S : ↓ 95.7 mm
 ⇔ 66.4 mm

No. 007

L: 12 min
S: 9 min
1 (005)
2 (807)

L : ↓ 125.0 mm
 ⇔ 87.6 mm
 S : ↓ 95.8 mm
 ⇔ 67.2 mm

No. 012

L: 13 min
S: 9 min
1 (005)
2 (807)

L : ↓ 124.9 mm
 ⇔ 88.1 mm
 S : ↓ 95.8 mm
 ⇔ 67.6 mm

No. 003

L: 12 min
S: 8 min
1 (005)
2 (807)

L : ↓ 124.8 mm
 ⇔ 85.6 mm
 S : ↓ 95.8 mm
 ⇔ 65.8 mm

No. 008

L: 16 min
S: 11 min
1 (005)
2 (807)

L : ↓ 125.0 mm
 ⇔ 89.8 mm
 S : ↓ 95.7 mm
 ⇔ 68.8 mm

No. 013

L: 20 min
S: 15 min
1 (005)
2 (807)

L : ↓ 125.0 mm
 ⇔ 117.6 mm
 S : ↓ 95.8 mm
 ⇔ 90.4 mm

No. 004

L: 14 min
S: 10 min
1 (005)
2 (807)

L : ↓ 124.8 mm
 ⇔ 95.8 mm
 S : ↓ 95.8 mm
 ⇔ 73.8 mm

No. 009

L: 7 min
S: 5 min
1 (005)
2 (807)

L : ↓ 124.9 mm
 ⇔ 66.0 mm
 S : ↓ 95.8 mm
 ⇔ 50.6 mm

No. 014

L: 15 min
S: 11 min
1 (005)
2 (807)

L : ↓ 124.8 mm
 ⇔ 96.0 mm
 S : ↓ 95.8 mm
 ⇔ 73.6 mm

No. 005

L: 14 min
S: 10 min
1 (005)
2 (807)

L : ↓ 124.8 mm
 ⇔ 87.8 mm
 S : ↓ 95.8 mm
 ⇔ 67.4 mm

No. 010

L: 9 min
S: 7 min
1 (005)
2 (807)

L : ↓ 124.9 mm
 ⇔ 75.4 mm
 S : ↓ 95.8 mm
 ⇔ 57.8 mm

No. 015

L: 14 min
S: 10 min
1 (005)
2 (807)

L : ↓ 124.6 mm
 ⇔ 96.8 mm
 S : ↓ 95.8 mm
 ⇔ 74.4 mm

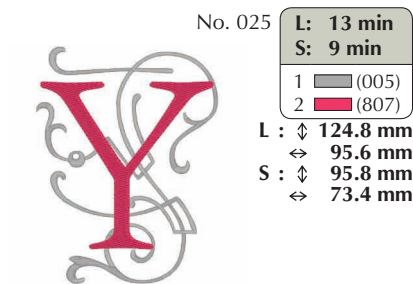
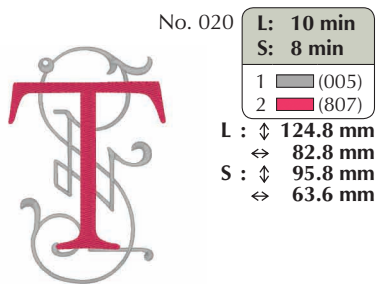
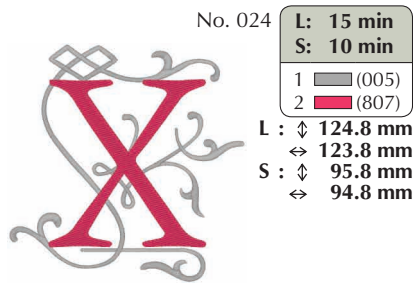
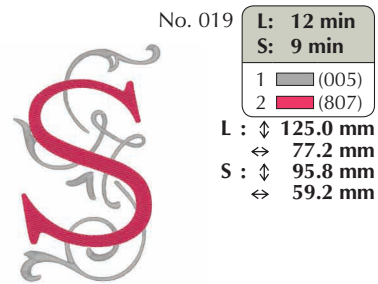
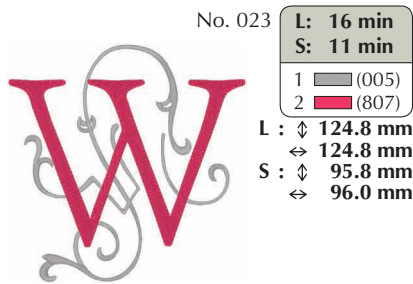
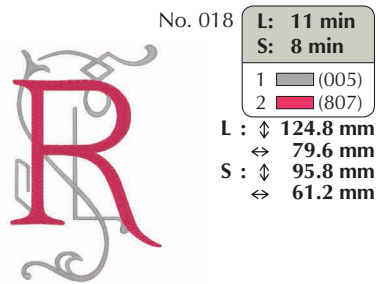
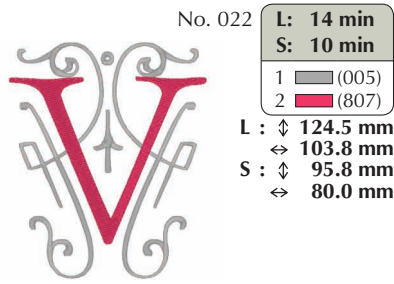
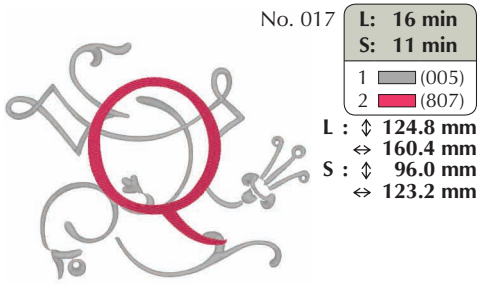
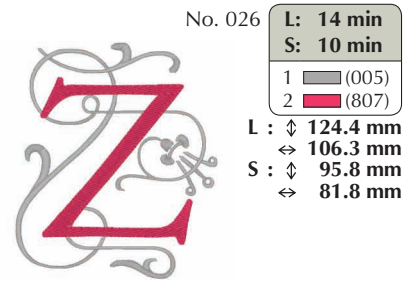
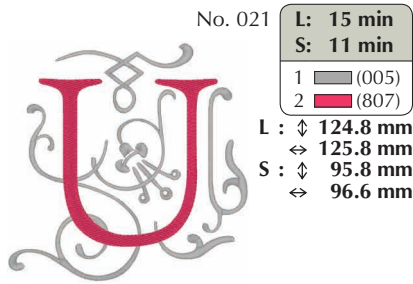
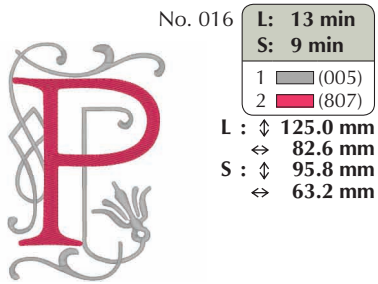

Patterns No.001 - No.026, are designed by Hang to Dry.
 Utformningarna 001 - 026 är skapade av Hang to Dry.
 Mønstre nr. 001-026 er lavet af Hang to Dry.
 Vzory č. 001 - č. 026 byly navrženy společností Hang to Dry.
 Az 001 ... 026 mintákat a Hang to Dry tervezte.
 Wzorce od nr 001 do nr 026 zostały zaprojektowane przez Hang to Dry.
 Modelele nr.001 - nr.026 sunt create de Hang to Dry.

- Renaissance Alphabet
- Renæssancealfabet
- Reneszánsz betűk
- Alfabet renesantist

- Renässansalfabet
- Renesanční abeceda
- Alfabet renesansowy



No. 001

L: 7 min
S: 5 min

1	(513)
2	(807)
3	(085)
4	(420)
5	(406)

L: \downarrow 49.9 mm
 \leftrightarrow 50.0 mm
S: \downarrow 33.0 mm
 \leftrightarrow 33.0 mm

No. 006

L: 8 min
S: 6 min

1	(517)
2	(507)
3	(810)
4	(339)
5	(323)

L: \downarrow 49.9 mm
 \leftrightarrow 49.9 mm
S: \downarrow 32.9 mm
 \leftrightarrow 32.9 mm

No. 011

L: 7 min
S: 5 min

1	(513)
2	(085)
3	(206)
4	(405)
5	(420)

L: \downarrow 50.0 mm
 \leftrightarrow 49.9 mm
S: \downarrow 32.9 mm
 \leftrightarrow 32.9 mm

No. 002

L: 8 min
S: 5 min

1	(507)
2	(070)
3	(339)
4	(323)

L: \downarrow 50.0 mm
 \leftrightarrow 50.0 mm
S: \downarrow 33.0 mm
 \leftrightarrow 33.0 mm

No. 007

L: 9 min
S: 7 min

1	(513)
2	(613)
3	(206)
4	(337)
5	(209)

L: \downarrow 50.0 mm
 \leftrightarrow 49.9 mm
S: \downarrow 32.9 mm
 \leftrightarrow 32.9 mm

No. 012

L: 8 min
S: 6 min

1	(517)
2	(804)
3	(206)
4	(107)
5	(807)

L: \downarrow 50.0 mm
 \leftrightarrow 50.0 mm
S: \downarrow 33.0 mm
 \leftrightarrow 33.0 mm

No. 003

L: 7 min
S: 5 min

1	(517)
2	(206)
3	(209)
4	(086)
5	(807)

L: \downarrow 49.9 mm
 \leftrightarrow 49.9 mm
S: \downarrow 32.9 mm
 \leftrightarrow 32.9 mm

No. 008

L: 9 min
S: 6 min

1	(517)
2	(124)
3	(812)
4	(339)
5	(323)

L: \downarrow 49.9 mm
 \leftrightarrow 50.0 mm
S: \downarrow 33.0 mm
 \leftrightarrow 33.0 mm

No. 013

L: 9 min
S: 6 min

1	(507)
2	(085)
3	(206)
4	(348)
5	(323)

L: \downarrow 49.9 mm
 \leftrightarrow 49.9 mm
S: \downarrow 33.0 mm
 \leftrightarrow 33.0 mm

No. 004

L: 8 min
S: 5 min

1	(517)
2	(307)
3	(513)
4	(126)
5	(209)

L: \downarrow 50.0 mm
 \leftrightarrow 49.9 mm
S: \downarrow 33.0 mm
 \leftrightarrow 33.0 mm

No. 009

L: 8 min
S: 6 min

1	(509)
2	(124)
3	(807)
4	(399)
5	(704)

L: \downarrow 49.9 mm
 \leftrightarrow 49.9 mm
S: \downarrow 32.9 mm
 \leftrightarrow 32.9 mm

No. 014

L: 6 min
S: 4 min

1	(507)
2	(613)
3	(214)
4	(337)

L: \downarrow 49.9 mm
 \leftrightarrow 50.0 mm
S: \downarrow 33.0 mm
 \leftrightarrow 33.0 mm

No. 005

L: 7 min
S: 5 min

1	(507)
2	(513)
3	(348)
4	(337)

L: \downarrow 49.9 mm
 \leftrightarrow 49.9 mm
S: \downarrow 32.9 mm
 \leftrightarrow 32.9 mm

No. 010

L: 7 min
S: 5 min

1	(509)
2	(209)
3	(206)
4	(517)
5	(507)

L: \downarrow 50.0 mm
 \leftrightarrow 50.0 mm
S: \downarrow 32.9 mm
 \leftrightarrow 32.9 mm

No. 015

L: 8 min
S: 6 min

1	(704)
2	(124)
3	(206)
4	(534)
5	(507)

L: \downarrow 49.9 mm
 \leftrightarrow 50.0 mm
S: \downarrow 33.0 mm
 \leftrightarrow 33.0 mm

No. 016

L: 8 min
S: 5 min

1	(513)
2	(804)
3	(070)
4	(107)
5	(807)

L: \downarrow 50.0 mm
 \leftrightarrow 49.9 mm
S: \downarrow 33.0 mm
 \leftrightarrow 33.0 mm



No. 021

L: 7 min
S: 5 min

1	(534)
2	(804)
3	(810)
4	(085)

L: \downarrow 49.9 mm
 \leftrightarrow 50.0 mm
S: \downarrow 33.0 mm
 \leftrightarrow 33.0 mm



No. 026

L: 6 min
S: 4 min

1	(517)
2	(614)
3	(405)
4	(406)

L: \downarrow 50.0 mm
 \leftrightarrow 50.0 mm
S: \downarrow 32.9 mm
 \leftrightarrow 32.9 mm



No. 017

L: 8 min
S: 5 min

1	(507)
2	(406)
3	(206)
4	(214)

L: \downarrow 49.9 mm
 \leftrightarrow 49.9 mm
S: \downarrow 33.0 mm
 \leftrightarrow 33.0 mm



No. 022

L: 9 min
S: 7 min

1	(513)
2	(406)
3	(001)
4	(513)
5	(337)
6	(209)

L: \downarrow 50.0 mm
 \leftrightarrow 49.9 mm
S: \downarrow 32.9 mm
 \leftrightarrow 32.9 mm



No. 027

2 min

1	(420)
2	(214)
3	(405)

\downarrow 75.0 mm
 \leftrightarrow 79.9 mm

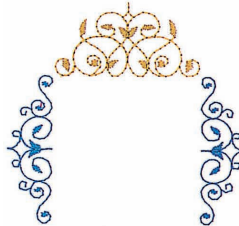

No. 018

L: 11 min
S: 7 min

1	(509)
2	(607)
3	(812)
4	(613)
5	(614)

L: \downarrow 49.9 mm
 \leftrightarrow 49.9 mm
S: \downarrow 32.9 mm
 \leftrightarrow 32.9 mm



No. 023

L: 9 min
S: 6 min

1	(509)
2	(209)
3	(517)
4	(507)

L: \downarrow 50.0 mm
 \leftrightarrow 50.0 mm
S: \downarrow 32.9 mm
 \leftrightarrow 32.9 mm



No. 028

2 min

1	(399)
---	-------

\downarrow 70.0 mm
 \leftrightarrow 49.9 mm

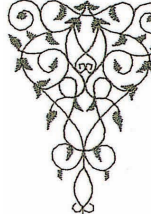

No. 019

L: 6 min
S: 3 min

1	(107)
2	(509)
3	(405)
4	(406)

L: \downarrow 49.9 mm
 \leftrightarrow 49.9 mm
S: \downarrow 32.9 mm
 \leftrightarrow 32.9 mm



No. 024

L: 8 min
S: 6 min

1	(509)
2	(812)
3	(126)
4	(804)
5	(613)

L: \downarrow 49.9 mm
 \leftrightarrow 50.0 mm
S: \downarrow 32.9 mm
 \leftrightarrow 33.0 mm



No. 029

3 min

1	(420)
2	(214)
3	(405)
4	(399)

\downarrow 96.0 mm
 \leftrightarrow 52.9 mm



No. 020

L: 8 min
S: 6 min

1	(513)
2	(420)
3	(206)
4	(126)
5	(209)

L: \downarrow 49.9 mm
 \leftrightarrow 50.0 mm
S: \downarrow 33.0 mm
 \leftrightarrow 33.0 mm



No. 025

L: 7 min
S: 4 min

1	(513)
2	(206)
3	(405)
4	(420)

L: \downarrow 49.9 mm
 \leftrightarrow 49.9 mm
S: \downarrow 32.9 mm
 \leftrightarrow 32.9 mm



- Vintage Alphabet
- Gammeldags alfabet
- Régi ábécé
- Alfabet vintage

- Vintage-bokstäver
- Starodávná abeceda
- Starodawny alfabet



<p>No. 001</p> <p>18 min</p> <p>1  (323)</p> <p>↓ 148.0 mm</p> <p>↔ 129.6 mm</p> <p>A</p>	<p>No. 007</p> <p>19 min</p> <p>1  (323)</p> <p>↓ 150.4 mm</p> <p>↔ 111.7 mm</p> <p>G</p>	<p>No. 013</p> <p>29 min</p> <p>1  (323)</p> <p>↓ 149.2 mm</p> <p>↔ 150.1 mm</p> <p>M</p>
<p>No. 002</p> <p>20 min</p> <p>1  (323)</p> <p>↓ 149.9 mm</p> <p>↔ 110.9 mm</p> <p>B</p>	<p>No. 008</p> <p>22 min</p> <p>1  (323)</p> <p>↓ 149.1 mm</p> <p>↔ 125.6 mm</p> <p>H</p>	<p>No. 014</p> <p>22 min</p> <p>1  (323)</p> <p>↓ 149.7 mm</p> <p>↔ 131.1 mm</p> <p>N</p>
<p>No. 003</p> <p>15 min</p> <p>1  (323)</p> <p>↓ 152.9 mm</p> <p>↔ 102.3 mm</p> <p>C</p>	<p>No. 009</p> <p>10 min</p> <p>1  (323)</p> <p>↓ 149.1 mm</p> <p>↔ 58.0 mm</p> <p>I</p>	<p>No. 015</p> <p>20 min</p> <p>1  (323)</p> <p>↓ 151.7 mm</p> <p>↔ 107.1 mm</p> <p>O</p>
<p>No. 004</p> <p>19 min</p> <p>1  (323)</p> <p>↓ 149.3 mm</p> <p>↔ 111.7 mm</p> <p>D</p>	<p>No. 010</p> <p>12 min</p> <p>1  (323)</p> <p>↓ 148.8 mm</p> <p>↔ 93.9 mm</p> <p>J</p>	<p>No. 016</p> <p>17 min</p> <p>1  (323)</p> <p>↓ 149.4 mm</p> <p>↔ 111.7 mm</p> <p>P</p>
<p>No. 005</p> <p>20 min</p> <p>1  (323)</p> <p>↓ 149.1 mm</p> <p>↔ 109.7 mm</p> <p>E</p>	<p>No. 011</p> <p>21 min</p> <p>1  (323)</p> <p>↓ 149.4 mm</p> <p>↔ 125.1 mm</p> <p>K</p>	<p>No. 017</p> <p>19 min</p> <p>1  (323)</p> <p>↓ 149.6 mm</p> <p>↔ 108.3 mm</p> <p>Q</p>
<p>No. 006</p> <p>16 min</p> <p>1  (323)</p> <p>↓ 149.3 mm</p> <p>↔ 107.4 mm</p> <p>F</p>	<p>No. 012</p> <p>14 min</p> <p>1  (323)</p> <p>↓ 149.2 mm</p> <p>↔ 107.1 mm</p> <p>L</p>	<p>No. 018</p> <p>21 min</p> <p>1  (323)</p> <p>↓ 149.5 mm</p> <p>↔ 123.2 mm</p> <p>R</p>

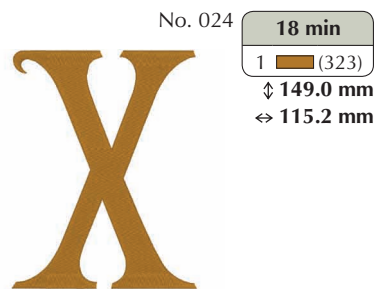
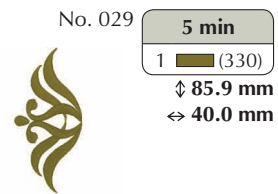
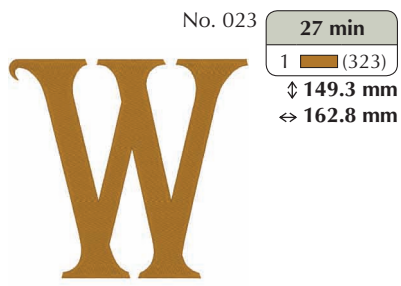
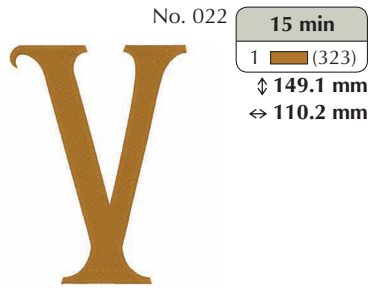
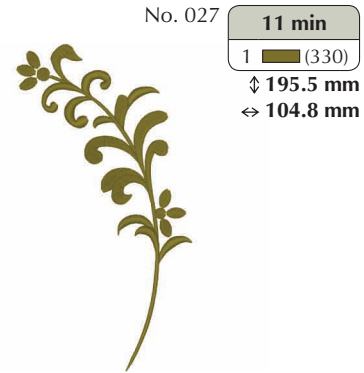
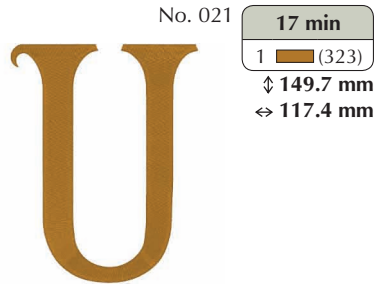
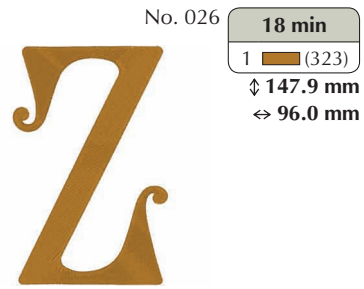
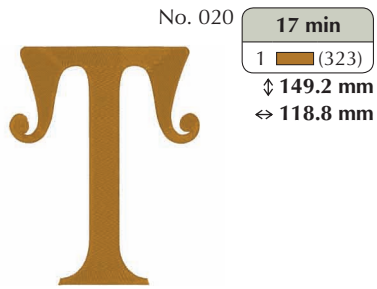
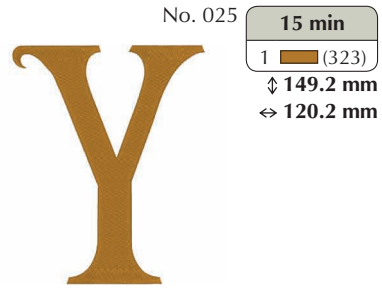
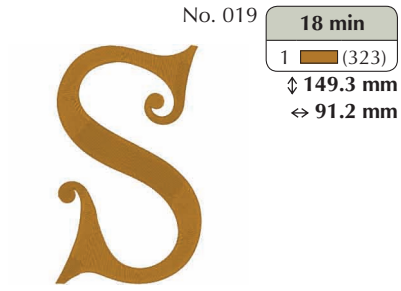

- Appliqué Alphabet
- Applikationsalfabet
- Rátétes betűk
- Monogramme cu aplicații

- Applikationsalfabet
- Aplikace písmen
- Alfabet ozdobny

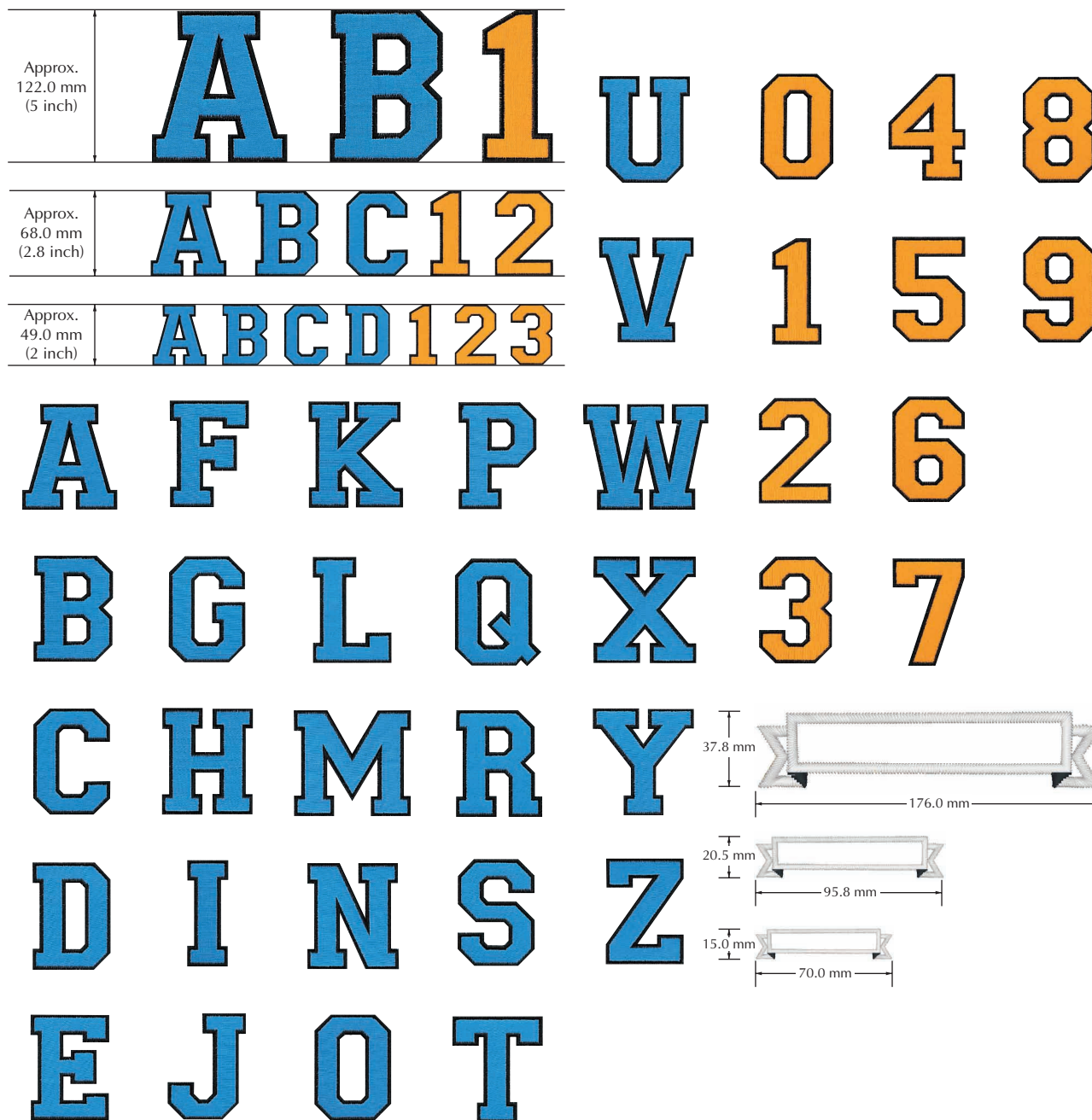

- ★ Refer to the operation manual for the embroidery machine for details on how to embroider appliqués.
- ★ Information om hur du broderar applikationer finns i brodyrmaskinens bruksanvisning.
- ★ Se i brugsanvisningen til broderimaskinen for at få oplysninger om, hvordan man broderer applikationer.
- ★ Podrobné informace o vyšívání aplikací najdete v uživatelské příručce vyšívacího stroje.
- ★ A rátétek hímzésének részleteiről tájékozódjon a hímzőgép használati utasításából.
- ★ Aby uzyskać informacje na temat haftowania aplikacji, należy zapoznać się z instrukcją obsługi hafciarki.
- ★ Consultați manualul de utilizare a mașinii de brodat pentru detalii despre brodarea aplicațiilor.

- Block Alphabet
- Trykt alfabet
- Szögletes ábécé
- Alfabet bloc

- Tryckt alfabet
- Bloková abeceda
- Alfabet drukowany



No. 001

38 min	
1	█ (509)
2	▢ (001)
3	■ (900)
↓ 152.3 mm	
↔ 111.6 mm	



No. 007

41 min	
1	█ (509)
2	▢ (001)
3	■ (900)
↓ 152.3 mm	
↔ 103.1 mm	



No. 013

54 min	
1	█ (509)
2	▢ (001)
3	■ (900)
↓ 152.3 mm	
↔ 124.8 mm	



No. 002

44 min	
1	█ (509)
2	▢ (001)
3	■ (900)
↓ 152.3 mm	
↔ 103.1 mm	



No. 008

40 min	
1	█ (509)
2	▢ (001)
3	■ (900)
↓ 152.3 mm	
↔ 103.1 mm	



No. 014

45 min	
1	█ (509)
2	▢ (001)
3	■ (900)
↓ 152.3 mm	
↔ 103.1 mm	



No. 003

35 min	
1	█ (509)
2	▢ (001)
3	■ (900)
↓ 152.3 mm	
↔ 103.1 mm	



No. 009

20 min	
1	█ (509)
2	▢ (001)
3	■ (900)
↓ 152.3 mm	
↔ 39.0 mm	



No. 015

40 min	
1	█ (509)
2	▢ (001)
3	■ (900)
↓ 152.3 mm	
↔ 103.1 mm	



No. 004

41 min	
1	█ (509)
2	▢ (001)
3	■ (900)
↓ 152.3 mm	
↔ 103.1 mm	



No. 010

28 min	
1	█ (509)
2	▢ (001)
3	■ (900)
↓ 152.3 mm	
↔ 103.5 mm	



No. 016

35 min	
1	█ (509)
2	▢ (001)
3	■ (900)
↓ 152.3 mm	
↔ 103.1 mm	



No. 005

34 min	
1	█ (509)
2	▢ (001)
3	■ (900)
↓ 152.3 mm	
↔ 90.8 mm	



No. 011

39 min	
1	█ (509)
2	▢ (001)
3	■ (900)
↓ 152.3 mm	
↔ 107.3 mm	



No. 017

41 min	
1	█ (509)
2	▢ (001)
3	■ (900)
↓ 152.3 mm	
↔ 109.2 mm	



No. 006

29 min	
1	█ (509)
2	▢ (001)
3	■ (900)
↓ 152.3 mm	
↔ 90.8 mm	

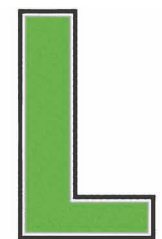

No. 012

24 min	
1	█ (509)
2	▢ (001)
3	■ (900)
↓ 152.3 mm	
↔ 90.8 mm	



No. 018

42 min	
1	█ (509)
2	▢ (001)
3	■ (900)
↓ 152.3 mm	
↔ 103.1 mm	

	<p>No. 019</p> <p>39 min</p> <p>1  (509) 2  (001) 3  (900)</p> <p>↓ 152.3 mm ↔ 103.5 mm</p>		<p>No. 026</p> <p>32 min</p> <p>1  (509) 2  (001) 3  (900)</p> <p>↓ 152.3 mm ↔ 96.9 mm</p>		<p>No. 033</p> <p>36 min</p> <p>1  (509) 2  (001) 3  (900)</p> <p>↓ 148.5 mm ↔ 85.8 mm</p>
	<p>No. 020</p> <p>26 min</p> <p>1  (509) 2  (001) 3  (900)</p> <p>↓ 152.3 mm ↔ 103.9 mm</p>		<p>No. 027</p> <p>28 min</p> <p>1  (509) 2  (001) 3  (900)</p> <p>↓ 106.7 mm ↔ 86.3 mm</p>		<p>No. 034</p> <p>31 min</p> <p>1  (509) 2  (001) 3  (900)</p> <p>↓ 152.3 mm ↔ 85.8 mm</p>
	<p>No. 021</p> <p>39 min</p> <p>1  (509) 2  (001) 3  (900)</p> <p>↓ 152.3 mm ↔ 103.1 mm</p>		<p>No. 028</p> <p>32 min</p> <p>1  (509) 2  (001) 3  (900)</p> <p>↓ 152.3 mm ↔ 85.8 mm</p>		<p>No. 035</p> <p>18 min</p> <p>1  (509) 2  (001) 3  (900)</p> <p>↓ 152.3 mm ↔ 33.7 mm</p>
	<p>No. 022</p> <p>36 min</p> <p>1  (509) 2  (001) 3  (900)</p> <p>↓ 152.3 mm ↔ 111.6 mm</p>		<p>No. 029</p> <p>24 min</p> <p>1  (509) 2  (001) 3  (900)</p> <p>↓ 106.7 mm ↔ 85.8 mm</p>		<p>No. 036</p> <p>23 min</p> <p>1  (509) 2  (001) 3  (900)</p> <p>↓ 194.1 mm ↔ 48.5 mm</p>
	<p>No. 023</p> <p>55 min</p> <p>1  (509) 2  (001) 3  (900)</p> <p>↓ 152.3 mm ↔ 141.4 mm</p>		<p>No. 030</p> <p>32 min</p> <p>1  (509) 2  (001) 3  (900)</p> <p>↓ 152.3 mm ↔ 85.8 mm</p>		<p>No. 037</p> <p>31 min</p> <p>1  (509) 2  (001) 3  (900)</p> <p>↓ 152.3 mm ↔ 88.5 mm</p>
	<p>No. 024</p> <p>34 min</p> <p>1  (509) 2  (001) 3  (900)</p> <p>↓ 152.3 mm ↔ 103.9 mm</p>		<p>No. 031</p> <p>27 min</p> <p>1  (509) 2  (001) 3  (900)</p> <p>↓ 106.7 mm ↔ 85.8 mm</p>		<p>No. 038</p> <p>18 min</p> <p>1  (509) 2  (001) 3  (900)</p> <p>↓ 152.3 mm ↔ 33.7 mm</p>
	<p>No. 025</p> <p>29 min</p> <p>1  (509) 2  (001) 3  (900)</p> <p>↓ 152.3 mm ↔ 112.7 mm</p>		<p>No. 032</p> <p>21 min</p> <p>1  (509) 2  (001) 3  (900)</p> <p>↓ 152.3 mm ↔ 63.2 mm</p>		



No. 039

38 min

1	■ (509)
2	□ (001)
3	■ (900)

↓ 106.7 mm
↔ 124.8 mm



No. 046

21 min

1	■ (509)
2	□ (001)
3	■ (900)

↓ 140.0 mm
↔ 67.8 mm

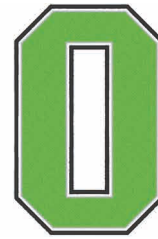

No. 053

39 min

1	■ (509)
2	□ (001)
3	■ (900)

↓ 152.3 mm
↔ 98.9 mm



No. 040

26 min

1	■ (509)
2	□ (001)
3	■ (900)

↓ 106.7 mm
↔ 85.8 mm



No. 047

26 min

1	■ (509)
2	□ (001)
3	■ (900)

↓ 106.7 mm
↔ 85.8 mm



No. 054

21 min

1	■ (509)
2	□ (001)
3	■ (900)

↓ 152.3 mm
↔ 56.7 mm



No. 041

26 min

1	■ (509)
2	□ (001)
3	■ (900)

↓ 106.7 mm
↔ 85.8 mm



No. 048

23 min

1	■ (509)
2	□ (001)
3	■ (900)

↓ 106.7 mm
↔ 93.8 mm



No. 055

35 min

1	■ (509)
2	□ (001)
3	■ (900)

↓ 152.3 mm
↔ 98.9 mm



No. 042

31 min

1	■ (509)
2	□ (001)
3	■ (900)

↓ 148.5 mm
↔ 85.8 mm



No. 049

38 min

1	■ (509)
2	□ (001)
3	■ (900)

↓ 106.7 mm
↔ 143.1 mm



No. 056

36 min

1	■ (509)
2	□ (001)
3	■ (900)

↓ 152.3 mm
↔ 98.9 mm



No. 043

31 min

1	■ (509)
2	□ (001)
3	■ (900)

↓ 148.5 mm
↔ 85.8 mm



No. 050

22 min

1	■ (509)
2	□ (001)
3	■ (900)

↓ 106.7 mm
↔ 88.8 mm



No. 057

35 min

1	■ (509)
2	□ (001)
3	■ (900)

↓ 152.3 mm
↔ 105.5 mm



No. 044

15 min

1	■ (509)
2	□ (001)
3	■ (900)

↓ 106.7 mm
↔ 58.7 mm



No. 051

26 min

1	■ (509)
2	□ (001)
3	■ (900)

↓ 148.5 mm
↔ 94.1 mm



No. 058

35 min

1	■ (509)
2	□ (001)
3	■ (900)

↓ 152.3 mm
↔ 98.9 mm



No. 045

26 min

1	■ (509)
2	□ (001)
3	■ (900)

↓ 106.7 mm
↔ 83.8 mm



No. 052

21 min

1	■ (509)
2	□ (001)
3	■ (900)

↓ 106.7 mm
↔ 75.2 mm



























































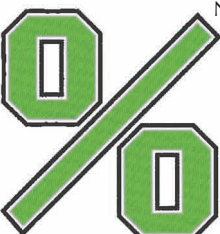































No. 059

40 min

1	■ (509)
2	□ (001)
3	■ (900)

↓ 152.3 mm
↔ 98.9 mm

	<p>No. 060</p> <p>26 min</p> <p>1  (509) 2  (001) 3  (900)</p> <p>↓ 152.3 mm ⇔ 98.9 mm</p>		<p>No. 067</p> <p>38 min</p> <p>1  (509) 2  (001) 3  (900)</p> <p>↓ 152.3 mm ⇔ 106.3 mm</p>		<p>No. 076</p> <p>8 min</p> <p>1  (509) 2  (001) 3  (900)</p> <p>↓ 53.9 mm ⇔ 46.6 mm</p>
	<p>No. 061</p> <p>41 min</p> <p>1  (509) 2  (001) 3  (900)</p> <p>↓ 152.3 mm ⇔ 98.9 mm</p>		<p>No. 068</p> <p>35 min</p> <p>1  (509) 2  (001) 3  (900)</p> <p>↓ 152.3 mm ⇔ 105.7 mm</p>		<p>No. 077</p> <p>44 min</p> <p>1  (509) 2  (001) 3  (900)</p> <p>↓ 152.3 mm ⇔ 136.9 mm</p>
	<p>No. 062</p> <p>40 min</p> <p>1  (509) 2  (001) 3  (900)</p> <p>↓ 152.3 mm ⇔ 98.9 mm</p>		<p>No. 069</p> <p>6 min</p> <p>1  (509) 2  (001) 3  (900)</p> <p>↓ 25.5 mm ⇔ 55.0 mm</p>		<p>No. 078</p> <p>30 min</p> <p>1  (509) 2  (001) 3  (900)</p> <p>↓ 152.3 mm ⇔ 103.1 mm</p>
	<p>No. 063</p> <p>39 min</p> <p>1  (509) 2  (001) 3  (900)</p> <p>↓ 152.3 mm ⇔ 117.7 mm</p>		<p>No. 070</p> <p>15 min</p> <p>1  (509) 2  (001) 3  (900)</p> <p>↓ 92.8 mm ⇔ 92.8 mm</p>		<p>No. 079</p> <p>21 min</p> <p>1  (509) 2  (001) 3  (900)</p> <p>↓ 152.3 mm ⇔ 41.1 mm</p>
	<p>No. 064</p> <p>50 min</p> <p>1  (509) 2  (001) 3  (900)</p> <p>↓ 152.3 mm ⇔ 144.9 mm</p>		<p>No. 071</p> <p>16 min</p> <p>1  (509) 2  (001) 3  (900)</p> <p>↓ 88.0 mm ⇔ 87.6 mm</p>		<p>No. 080</p> <p>56 min</p> <p>1  (509) 2  (001) 3  (900)</p> <p>↓ 152.3 mm ⇔ 137.5 mm</p>
	<p>No. 065</p> <p>41 min</p> <p>1  (509) 2  (001) 3  (900)</p> <p>↓ 182.6 mm ⇔ 98.9 mm</p>		<p>No. 073</p> <p>19 min</p> <p>1  (509) 2  (001) 3  (900)</p> <p>↓ 60.8 mm ⇔ 92.8 mm</p>		<p>No. 081</p> <p>15 min</p> <p>1  (509) 2  (001) 3  (900)</p> <p>↓ 108.2 mm ⇔ 71.0 mm</p>
	<p>No. 066</p> <p>36 min</p> <p>1  (509) 2  (001) 3  (900)</p> <p>↓ 152.3 mm ⇔ 101.0 mm</p>		<p>No. 074</p> <p>18 min</p> <p>1  (509) 2  (001) 3  (900)</p> <p>↓ 81.8 mm ⇔ 83.3 mm</p>		<p>No. 082</p> <p>15 min</p> <p>1  (509) 2  (001) 3  (900)</p> <p>↓ 108.3 mm ⇔ 71.1 mm</p>
			<p>No. 075</p> <p>6 min</p> <p>1  (509) 2  (001) 3  (900)</p> <p>↓ 34.4 mm ⇔ 38.5 mm</p>		

No. 083

23 min

1		(509)
2		(001)
3		(900)

↓ 198.6 mm
↔ 54.6 mm



No. 084

23 min

1		(509)
2		(001)
3		(900)

↓ 198.6 mm
↔ 54.6 mm



No. 085

26 min

1		(509)
2		(001)
3		(900)

↓ 198.6 mm
↔ 53.9 mm



No. 086

26 min

1		(509)
2		(001)
3		(900)

↓ 198.6 mm
↔ 53.9 mm



No. 087

18 min

1		(509)
2		(001)
3		(900)

↓ 156.8 mm
↔ 96.5 mm

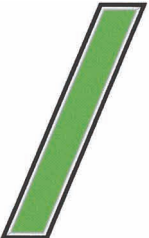

No. 088

18 min

1		(509)
2		(001)
3		(900)

↓ 156.8 mm
↔ 96.6 mm

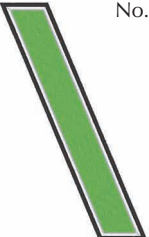

No. 089

12 min

1		(509)
2		(001)
3		(900)

↓ 52.1 mm
↔ 106.9 mm



No. 090

12 min

1		(509)
2		(001)
3		(900)

↓ 106.7 mm
↔ 38.7 mm



No. 091

13 min

1		(509)
2		(001)
3		(900)

↓ 126.0 mm
↔ 46.5 mm



No. 092

56 min

1		(509)
2		(001)
3		(900)

↓ 152.3 mm
↔ 152.3 mm



No. 093

59 min

1		(509)
2		(001)
3		(900)

↓ 152.3 mm
↔ 152.3 mm



No. 094

40 min

1		(509)
2		(001)
3		(900)

↓ 93.2 mm
↔ 146.9 mm



No. 095

15 min

1		(509)
2		(001)
3		(900)

↓ 53.5 mm
↔ 89.9 mm



No. 096

15 min

1		(509)
2		(001)
3		(900)

↓ 53.5 mm
↔ 90.3 mm



No. 097

13 min

1		(509)
2		(001)
3		(900)

↓ 49.8 mm
↔ 79.6 mm



No. 098

6 min

1		(509)
2		(001)
3		(900)

↓ 49.8 mm
↔ 34.9 mm



No. 099

7 min

1		(509)
2		(001)
3		(900)

↓ 53.5 mm
↔ 46.5 mm



No. 100

6 min

1		(509)
2		(001)
3		(900)

↓ 49.8 mm
↔ 35.0 mm



- Striped Alphabet
- Stribet alfabet
- Csíkos ábécé
- Alfabet în dungii

- Randigt alfabet
- Pruhoaná abeceda
- Alfabet w paski

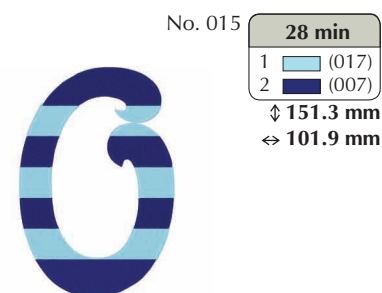
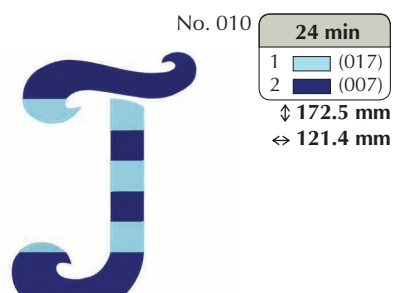
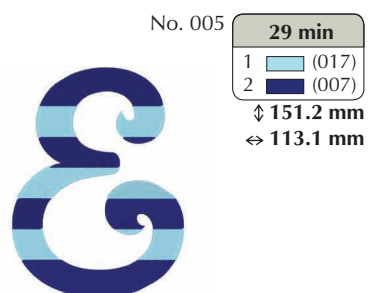
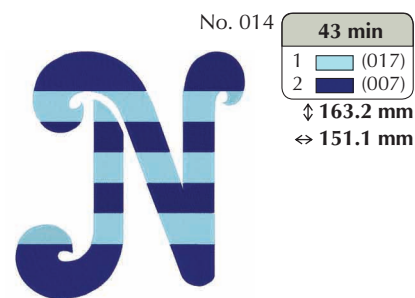
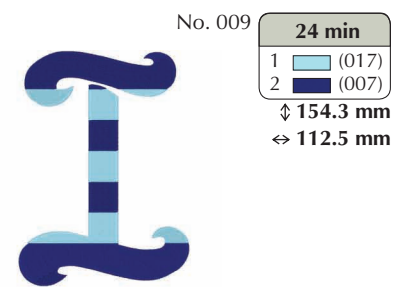
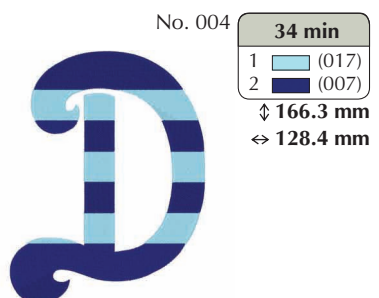
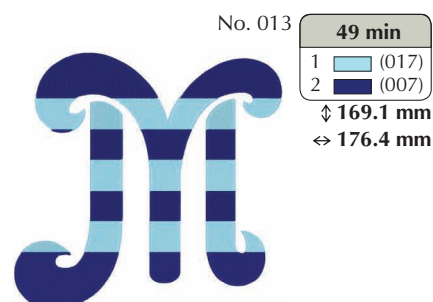
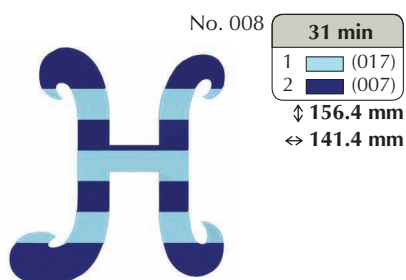
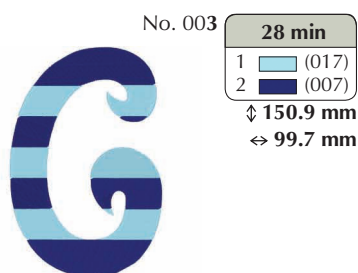
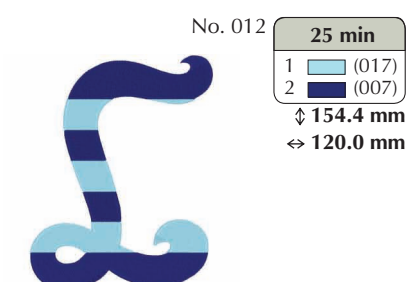
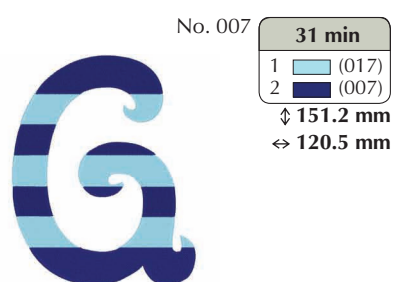
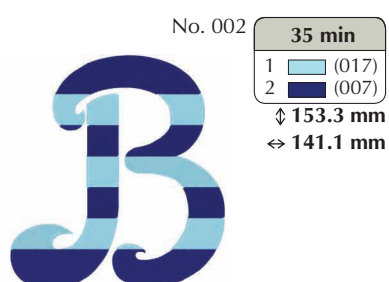
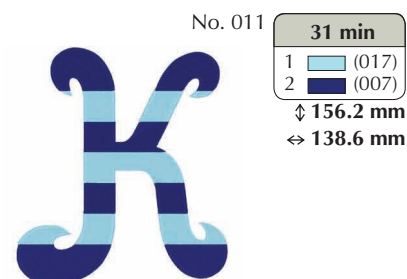
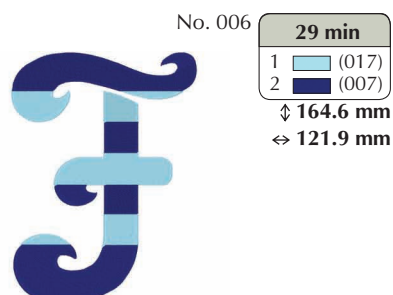
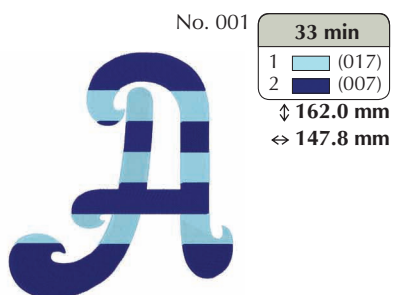



No. 016

32 min	
1	(017)
2	(007)
↓ 171.8 mm	
↔ 132.3 mm	



No. 022

27 min	
1	(017)
2	(007)
↓ 158.5 mm	
↔ 115.1 mm	



No. 028

24 min	
1	(017)
2	(007)
↓ 147.2 mm	
↔ 102.0 mm	



No. 017

32 min	
1	(017)
2	(007)
↓ 165.5 mm	
↔ 117.5 mm	



No. 023

42 min	
1	(017)
2	(007)
↓ 152.7 mm	
↔ 163.8 mm	



No. 029

16 min	
1	(017)
2	(007)
↓ 107.6 mm	
↔ 73.9 mm	

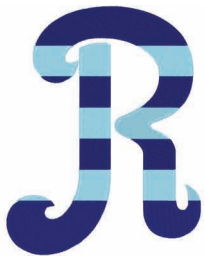

No. 018

34 min	
1	(017)
2	(007)
↓ 163.7 mm	
↔ 127.9 mm	



No. 024

29 min	
1	(017)
2	(007)
↓ 149.5 mm	
↔ 137.7 mm	



No. 030

24 min	
1	(017)
2	(007)
↓ 149.3 mm	
↔ 100.6 mm	



No. 019

33 min	
1	(017)
2	(007)
↓ 157.0 mm	
↔ 113.1 mm	



No. 025

29 min	
1	(017)
2	(007)
↓ 161.8 mm	
↔ 116.4 mm	



No. 031

18 min	
1	(017)
2	(007)
↓ 107.2 mm	
↔ 74.0 mm	

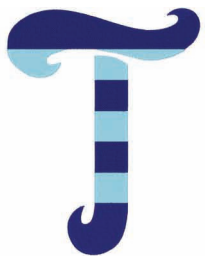

No. 020

22 min	
1	(017)
2	(007)
↓ 162.3 mm	
↔ 126.8 mm	



No. 026

27 min	
1	(017)
2	(007)
↓ 153.1 mm	
↔ 120.4 mm	



No. 032

20 min	
1	(017)
2	(007)
↓ 176.4 mm	
↔ 89.2 mm	



No. 021

29 min	
1	(017)
2	(007)
↓ 151.3 mm	
↔ 123.4 mm	



No. 027

18 min	
1	(017)
2	(007)
↓ 105.0 mm	
↔ 87.9 mm	



No. 033

23 min	
1	(017)
2	(007)
↓ 139.1 mm	
↔ 94.3 mm	



No. 034

25 min	
1	□ (017)
2	■ (007)
↓ 148.8 mm	
↔ 113.4 mm	

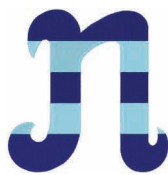

No. 040

20 min	
1	□ (017)
2	■ (007)
↓ 106.2 mm	
↔ 105.2 mm	



No. 046

18 min	
1	□ (017)
2	■ (007)
↓ 140.8 mm	
↔ 81.9 mm	



No. 035

14 min	
1	□ (017)
2	■ (007)
↓ 140.7 mm	
↔ 63.5 mm	



No. 041

17 min	
1	□ (017)
2	■ (007)
↓ 108.3 mm	
↔ 71.4 mm	



No. 047

20 min	
1	□ (017)
2	■ (007)
↓ 108.1 mm	
↔ 106.2 mm	



No. 036

17 min	
1	□ (017)
2	■ (007)
↓ 174.9 mm	
↔ 61.6 mm	



No. 042

22 min	
1	□ (017)
2	■ (007)
↓ 139.5 mm	
↔ 103.8 mm	



No. 048

17 min	
1	□ (017)
2	■ (007)
↓ 106.9 mm	
↔ 98.3 mm	



No. 037

26 min	
1	□ (017)
2	■ (007)
↓ 150.9 mm	
↔ 116.9 mm	



No. 043

21 min	
1	□ (017)
2	■ (007)
↓ 138.0 mm	
↔ 94.8 mm	



No. 049

26 min	
1	□ (017)
2	■ (007)
↓ 105.0 mm	
↔ 131.7 mm	



No. 038

17 min	
1	□ (017)
2	■ (007)
↓ 152.6 mm	
↔ 69.4 mm	



No. 044

13 min	
1	□ (017)
2	■ (007)
↓ 106.2 mm	
↔ 78.2 mm	



No. 050

18 min	
1	□ (017)
2	■ (007)
↓ 102.6 mm	
↔ 102.6 mm	



No. 039

29 min	
1	□ (017)
2	■ (007)
↓ 109.3 mm	
↔ 149.5 mm	



No. 045



18 min	
1	□ (017)
2	■ (007)
↓ 107.1 mm	
↔ 87.7 mm	



No. 051

24 min	
1	□ (017)
2	■ (007)
↓ 135.6 mm	
↔ 86.0 mm	



No. 052 **16 min**

1		(017)
2		(007)

↓ 104.7 mm
↔ 90.2 mm





No. 058 **31 min**

1		(017)
2		(007)

↓ 157.5 mm
↔ 100.7 mm





No. 064 **41 min**

1		(017)
2		(007)

↓ 154.0 mm
↔ 137.1 mm





No. 053 **25 min**

1		(017)
2		(007)

↓ 151.0 mm
↔ 96.6 mm





No. 059 **30 min**

1		(017)
2		(007)

↓ 151.3 mm
↔ 94.4 mm





No. 065 **32 min**

1		(017)
2		(007)

↓ 164.2 mm
↔ 100.3 mm





No. 054 **16 min**

1		(017)
2		(007)

↓ 155.5 mm
↔ 58.7 mm





No. 060 **21 min**

1		(017)
2		(007)

↓ 151.3 mm
↔ 103.4 mm





No. 066 **29 min**

1		(017)
2		(007)

↓ 153.3 mm
↔ 126.4 mm





No. 055 **25 min**

1		(017)
2		(007)

↓ 148.7 mm
↔ 103.0 mm





No. 061 **27 min**

1		(017)
2		(007)

↓ 153.1 mm
↔ 96.5 mm





No. 067 **34 min**

1		(017)
2		(007)

↓ 150.5 mm
↔ 129.0 mm





No. 056 **27 min**

1		(017)
2		(007)

↓ 151.6 mm
↔ 102.8 mm





No. 062 **27 min**

1		(017)
2		(007)

↓ 152.0 mm
↔ 92.7 mm





No. 068 **26 min**

1		(017)
2		(007)

↓ 157.6 mm
↔ 100.5 mm





No. 057 **28 min**

1		(017)
2		(007)

↓ 152.5 mm
↔ 109.7 mm





No. 063 **37 min**

1		(017)
2		(007)

↓ 162.5 mm
↔ 142.0 mm



No. 069 **4 min**

1		(017)
2		(007)

↓ 25.4 mm
↔ 52.4 mm



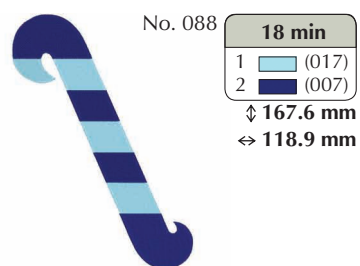
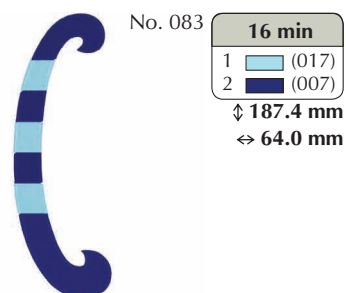
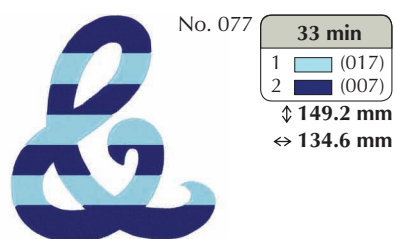
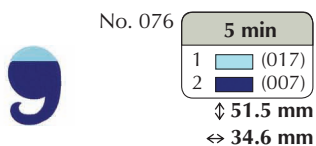
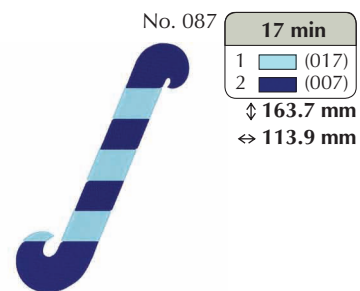
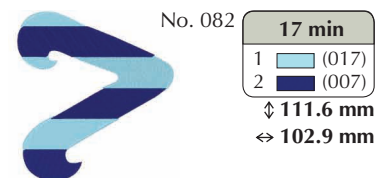
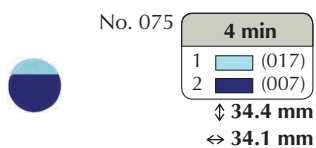
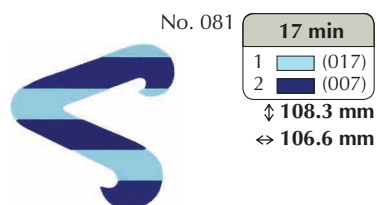
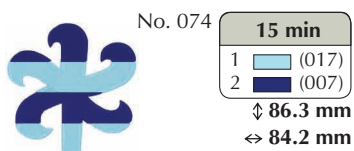
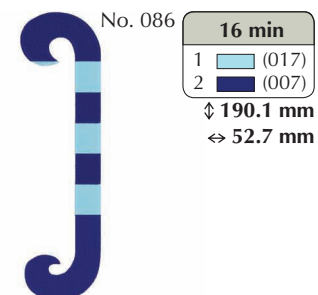
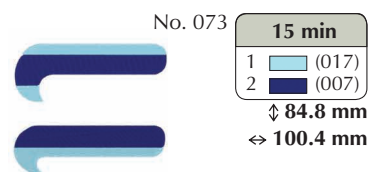
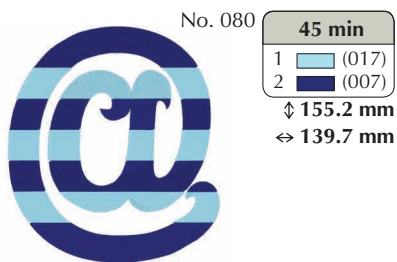
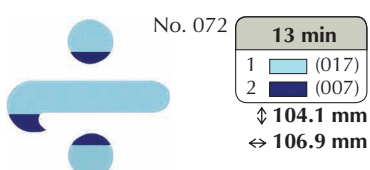
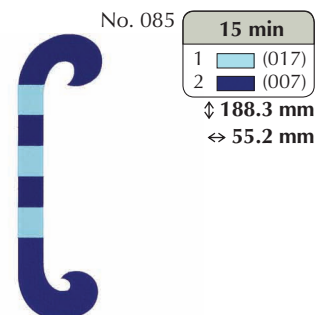
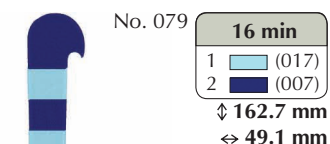
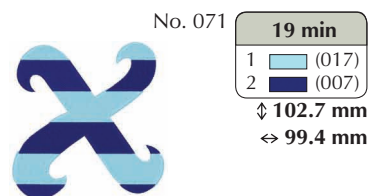
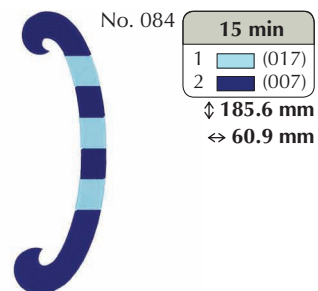
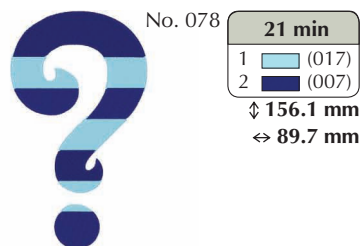
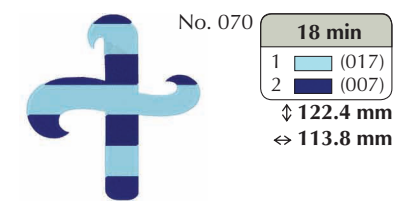

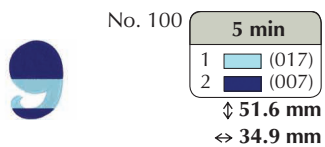
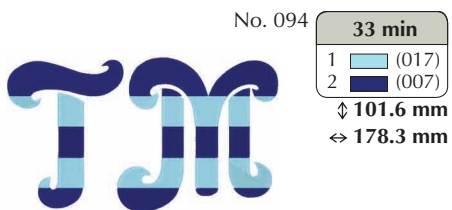
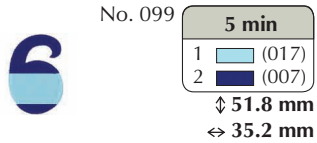
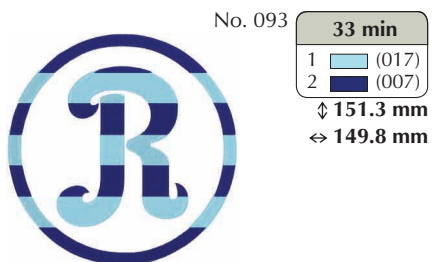
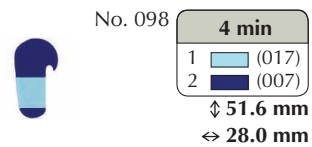
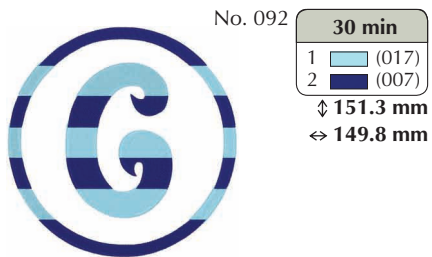
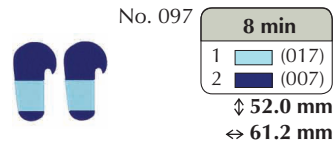
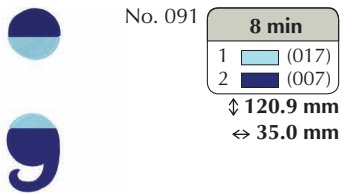
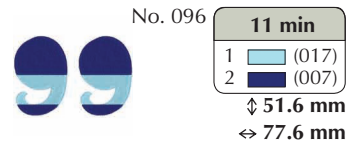
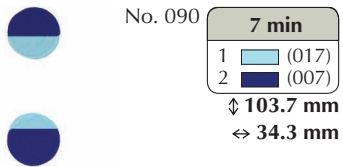
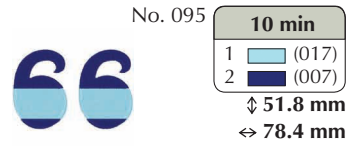

- Greek Alphabet
- Græsk alfabet
- Görög betűk
- Modele cu alfabetul grec

- Mönster med det grekiska alfabetet
- Vzory řecké abecedy
- Wzory alfabetu greckiego



	No. 001 4 min 1 (209) 2 (513) 3 (405) ↓ 55.7 mm ↔ 57.2 mm		No. 009 3 min 1 (209) 2 (513) 3 (405) ↓ 54.1 mm ↔ 27.0 mm		No. 017 5 min 1 (209) 2 (513) 3 (405) ↓ 54.4 mm ↔ 44.3 mm
	No. 002 6 min 1 (209) 2 (513) 3 (405) ↓ 54.3 mm ↔ 50.5 mm		No. 010 5 min 1 (209) 2 (513) 3 (405) ↓ 54.1 mm ↔ 57.4 mm		No. 018 5 min 1 (209) 2 (513) 3 (405) ↓ 54.1 mm ↔ 49.2 mm
	No. 003 4 min 1 (209) 2 (513) 3 (405) ↓ 54.2 mm ↔ 48.4 mm		No. 011 4 min 1 (209) 2 (513) 3 (405) ↓ 55.7 mm ↔ 54.3 mm		No. 019 4 min 1 (209) 2 (513) 3 (405) ↓ 54.1 mm ↔ 48.1 mm
	No. 004 5 min 1 (209) 2 (513) 3 (405) ↓ 55.6 mm ↔ 49.8 mm		No. 012 6 min 1 (209) 2 (513) 3 (405) ↓ 54.3 mm ↔ 68.0 mm		No. 020 4 min 1 (209) 2 (513) 3 (405) ↓ 53.9 mm ↔ 56.2 mm
	No. 005 4 min 1 (209) 2 (513) 3 (405) ↓ 54.1 mm ↔ 49.7 mm		No. 013 5 min 1 (209) 2 (513) 3 (405) ↓ 55.6 mm ↔ 55.6 mm		No. 021 7 min 1 (209) 2 (513) 3 (405) ↓ 54.3 mm ↔ 55.6 mm
	No. 006 4 min 1 (209) 2 (513) 3 (405) ↓ 53.9 mm ↔ 47.5 mm		No. 014 7 min 1 (209) 2 (513) 3 (405) ↓ 54.1 mm ↔ 48.7 mm		No. 022 5 min 1 (209) 2 (513) 3 (405) ↓ 54.1 mm ↔ 57.2 mm
	No. 007 5 min 1 (209) 2 (513) 3 (405) ↓ 54.2 mm ↔ 55.8 mm		No. 015 5 min 1 (209) 2 (513) 3 (405) ↓ 56.8 mm ↔ 52.7 mm		No. 023 6 min 1 (209) 2 (513) 3 (405) ↓ 54.3 mm ↔ 61.9 mm
	No. 008 7 min 1 (209) 2 (513) 3 (405) ↓ 56.8 mm ↔ 52.5 mm		No. 016 5 min 1 (209) 2 (513) 3 (405) ↓ 54.1 mm ↔ 58.9 mm		No. 024 6 min 1 (209) 2 (513) 3 (405) ↓ 55.9 mm ↔ 53.2 mm

- Appliqué Greek Alphabet
- Applikation – græsk alfabet
- Görög ábécés felvarrt díszítés
- Aplicație alfabet grecesc

- Applikation grekiska-bokstäver
- Našivaná ozdobná řecká abeceda
- Aplikacja – alfabet grecki

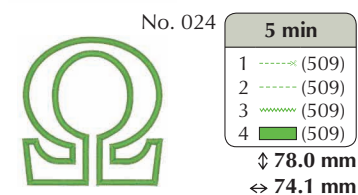
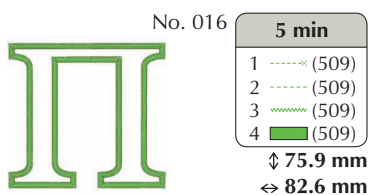
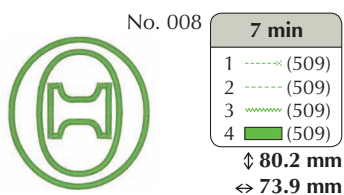
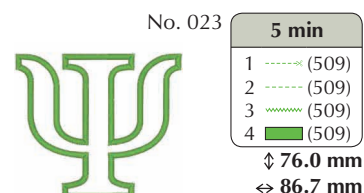
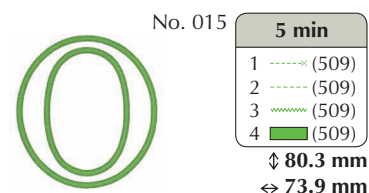
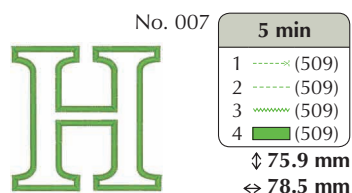
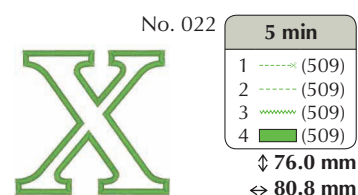
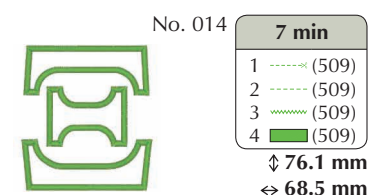
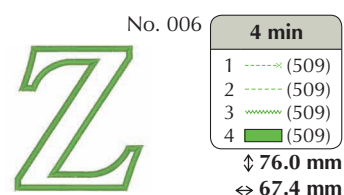
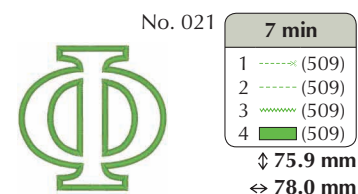
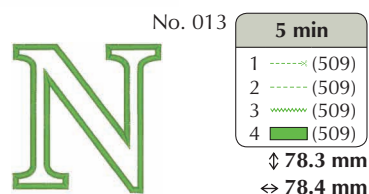
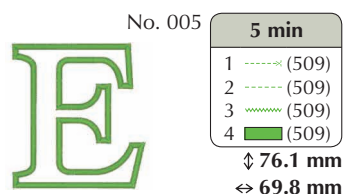
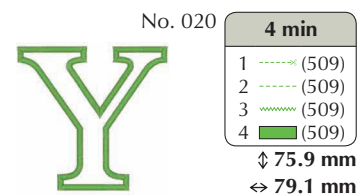
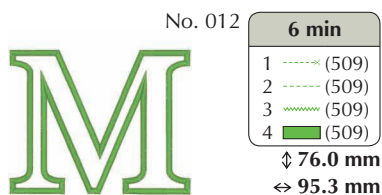
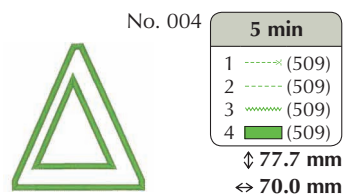
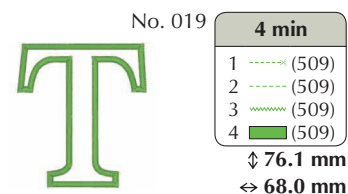
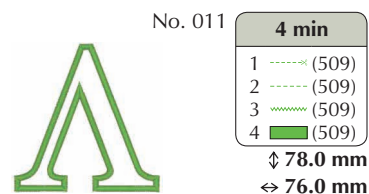
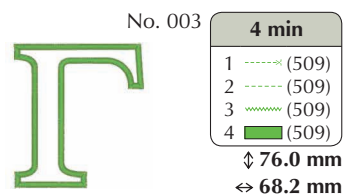
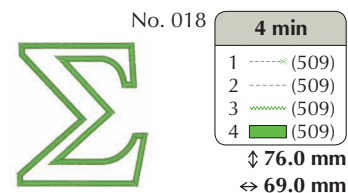
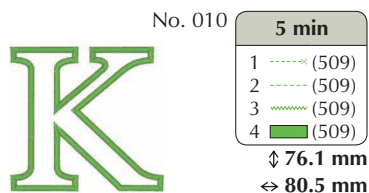
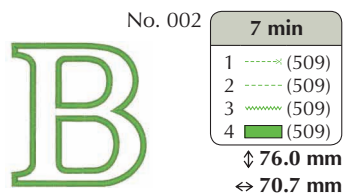
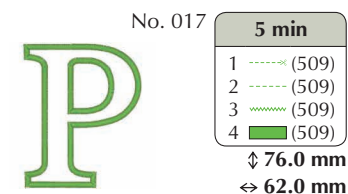
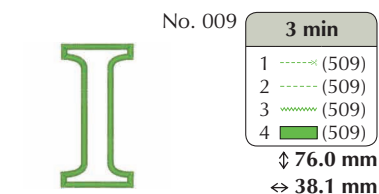
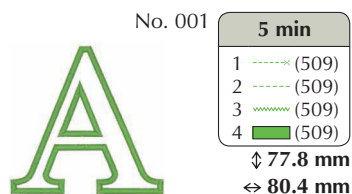

Refer to the operation manual for the embroidery machine for details on how to embroider appliqués.
 Information om hur du broderar applikationer finns i brodermaskinens bruksanvisning.
 Se i brugsanvisningen til brodermaskinen for at få oplysninger om, hvordan man broderer applikationer.
 Podrobne informácie o vyšívání aplikací najdete v uživatelské příručce vyšivacího stroje.
 A rátétek hímzésének részleteiről tájékozódjon a hímzőgép használati utasításából.
 Aby uzyskać informacje na temat haftowania aplikacji, należy zapoznać się z instrukcją obsługi hałciarki.
 Consultați manualul de utilizare a mașinii de brodat pentru detalii despre brodarea aplicațiilor.

Examples of Combinations Eksempler på kombinationer Példák a különböző kombinációkra Exemple de combinații

Exempel på kombinationer Příklady kombinací Przykłady połączeń

- Embroidery patterns on these pages are illustration images, which may be different from the patterns in your machine.
- Broderimønstrene på disse sider er illustrationsbilleder, som kan være forskellige fra mønstrene i din maskine.
- Az oldalakon látható hímzésminták csak illusztrációk, s különbözhetnek az Ön gépében található mintáktól.
- Modelele de broderie din aceste pagini sunt imagini ilustrate care pot fi diferite de modelele din mașina dumneavoastră.

- Broderimønstren på dessa sidor är illustrationer som kan skilja sig från mönstren i din maskin.
- Vyšivací vzory na těchto stranách jsou ilustrované obrázky, které se mohou lišit od vzorů ve vašem stroji.
- Wzory haftu przedstawione na tych stronach są ilustracjami i mogą różnić się od wzorów zapisanych w hafciarce.



 No.012, No.013 x 4, No.014



 No.043



 No.045, No.046

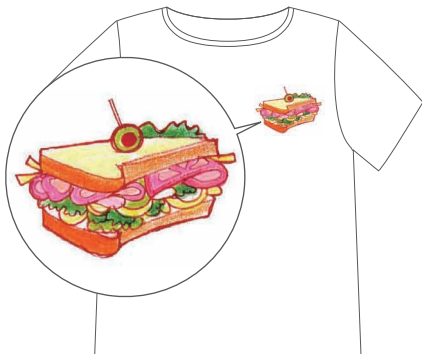

 No.039



 No.018



 No.015 x 3, No.016 x 2



 No.021



 No.023

Combinations

Broaden your embroidering world by combining the patterns

Kombinationer

Udvid dit broderiunivers ved at kombinere mønstrene

Kombinációk

Szélesítse ki hímzései világát a minták kombinálásával

Combiñații

Extindeți-vă opțiunile creative în universul broderiei combinând modelele

Kombinationer

Vidga din broderingsvärld genom att kombinera mönstren

Kombinace

Rozšiřte svůj svět vyšívání kombinováním různých vzorů

Połączenia

Świat haftu można powiększyć poprzez łączenie wzorów



 No.039

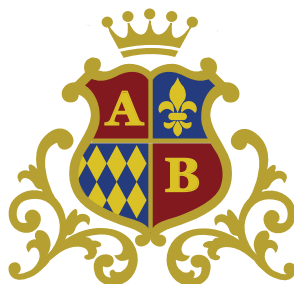

 No.040



 No.038



 No.039



 No.003, No.005 x 10



 No.033, No.034



 No.003, No.004,
No.005, No.006

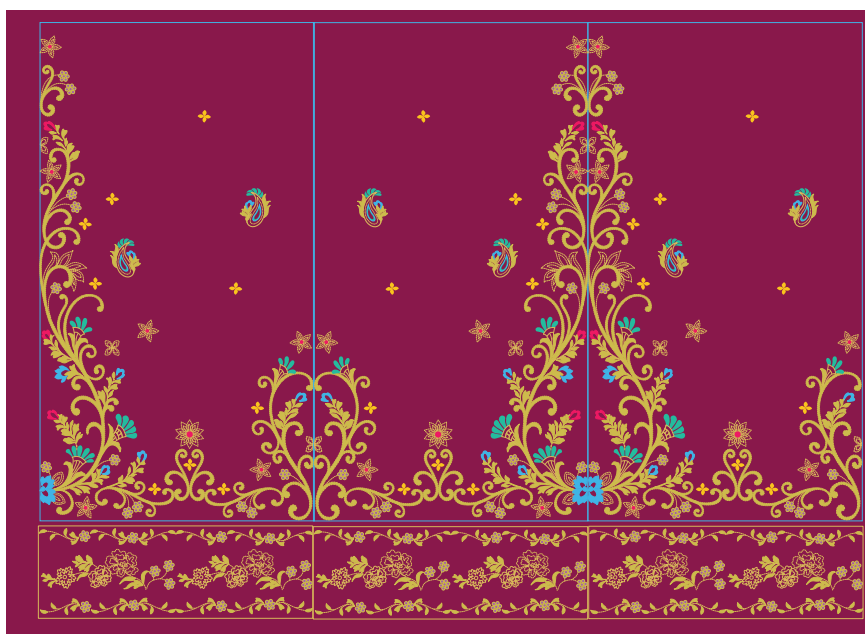

 No.029 x 3, No.030 x 12, No.031 x 6

Embroidering on caps

The optional wide cap frame enables you to embroider up to 360 mm x 60 mm (14 inches x 2-3/8 inches) size of embroidery patterns on caps.

Brodering på kasketter

Ved brug af den brede kasketramme (ekstraudstyr) kan du brodere broderimønstre på op til 360 mm x 60 mm (14 tommer x 2-3/8 tommer) på kasketter.

Hímzés sapkára

Az opcionális széles sapkakeret segítségével akár 360 mm x 60 mm (14 hüvelyk x 2-3/8 hüvelyk) méretű mintákat is hímezhet sapkákra.

Brodarea pe șepci

Ghergheful opțional mare pentru șepci vă permite să brodați pe șepci modele de broderie cu dimensiuni de până la 360 mm x 60 mm (14 in. x 2-3/8 in.).

Brodering av kepsar

Den brede kepsramen (tillval) gör att du kan brodera broderimönster på upp till 360 mm x 60 mm på kepsar.

Vyšívání čepice

Volitelný široký rámeček na čepice umožňuje vyšívat vzory o rozměrech 360 mm x 60 mm (14 palců x 2-3/8 palců) na čepice.

Haftowanie czapek

Opcjonalna szeroka ramka do mocowania czapek umożliwia haftowanie wzorów na czapkach o następujących maksymalnych wymiarach 360 mm x 60 mm (14 cali x 2-3/8 cala).



No.022



No.019

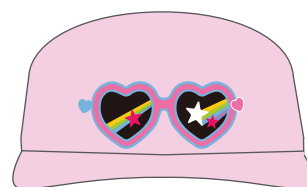

No.020



No.018

Even if you don't have the wide cap frame, you can enjoy embroidering using optional cap frames. Various embroidery designs help you to create your original caps.

Även om du inte har den bredda kepsramen kan du brodera med hjälp av

kepsramarna (tillval). Olika broderier hjälper dig att skapa originella kepsar.

Selv om du ikke har den brede kasketramme, kan du stadig brodere med kasketrammerne (ekstraudstyr). Med de forskellige broderidesigns kan du skabe dine egne originale kasketter.

Pokud nemáte široký rámeček na čepice, můžete vyšívat pomocí volitelných rámečků na čepice. Různé návrhy vyšívacích vzorů vám pomohou vytvořit originální čepice.

Az opcionális sapkakeret segítségével még a széles sapkakeretek hiányában is élvezheti a hímezést. Egyedi sapka létrehozásához számos hímezsminta nyújt segítséget.

Nawet w przypadku braku szerokiej ramki do mocowania czapek można haftować z wykorzystaniem opcjonalnych ramek do mocowania czapek. Różnorodne projekty haftu umożliwiają tworzenie oryginalnych czapek.

Chiar dacă nu dispuneți de ghergheful mare pentru șepci, puteți savura plăcerea de a broda folosind gherghefele opționale pentru șepci. Diversele desene de broderii vă ajută să creați șepci originale.

Specialty stabilizers create 3-D embroidery
Särskilda styvnadsmaterial skapar 3D-broderier
Med de særligt afstivende materialer kan du skabe broderier i 3D
Speciální stabilizátory vytvářejí 3D výšivky
Speciális stabilizálók háromdimenziós hímezés készítéséhez
Specjalistyczne podkłady tworzą hafty 3D
Stabilizatoarele specializate creează broderie 3D



No.019

Embroidering large patterns

You can embroider up to 360 mm × 360 mm (14 inches × 14 inches) size embroidery pattern using the optional jumbo frame. Simply embroider the first half of the design, turn the hoop 180 degrees and embroider the second half of the design.

Large patterns (up to 350 mm × 350 mm (13-3/4 inches × 13-3/4 inches) size embroidery) for the optional jumbo frame can be created by using the embroidery editing software version PE-DESIGN NEXT or later.

Some sample patterns are included in PE-DESIGN NEXT.

Brodering af store mønstre

Du kan brodere broderimønstre på op til 360 mm × 360 mm (14 tommer × 14 tommer) med den ekstra store ramme (ekstraudstyr). Broder den ene halvdel af designet. Drej derefter rammen 180 grader, og broder den anden halvdel af designet.

Med broderiredigeringssoftwaren version PE-DESIGN NEXT eller nyere kan du lave store mønstre (broderistørrelse på op til 350 mm × 350 mm (13-3/4 tommer × 13-3/4 tommer)) til den ekstra store ramme.

Der medfølger nogle prøvemønstre i PE-DESIGN NEXT.

Nagyméretű minták hímzése

Az opcionális jumbo kerettel maximálisan 360 mm × 360 mm (14 hüvelyk × 14 hüvelyk) méretű hímzésminták készíthetők.

Egyszerűen hímmezze ki a minta első részét, fordítsa el a keretet 180 fokkal, majd hímmezze ki a minta második részét is.

Az opcionális jumbo keretbe illő nagyméretű minták [max. 350 mm × 350 mm-es (13 3/4 hüvelyk × 13 3/4 hüvelyk) hímzés] létrehozásához használja a hímzésszerkesztő szoftver PE-DESIGN NEXT vagy annál újabb verzióját.

A PE-DESIGN NEXT program tartalmaz néhány mintát.

Modele de broderie mari

Utilizând ghergheful opțional jumbo, puteți broda modele de broderie cu dimensiuni de până la 360 mm × 360 mm (14 in. × 14 in.).

Brodați prima jumătate a modelului, înotarceți la 180 de grade și brodați cea de-a doua jumătate a modelului.

Modelele mari (broderie cu mărime până la 350 mm × 350 mm (13-3/4 in. × 13-3/4 in.)) pentru ghergheful opțional jumbo pot fi create folosind programul de editare de broderie versiunea PE-DESIGN NEXT sau o versiune ulterioară.

Câteva exemple de modele sunt incluse în PE-DESIGN NEXT.

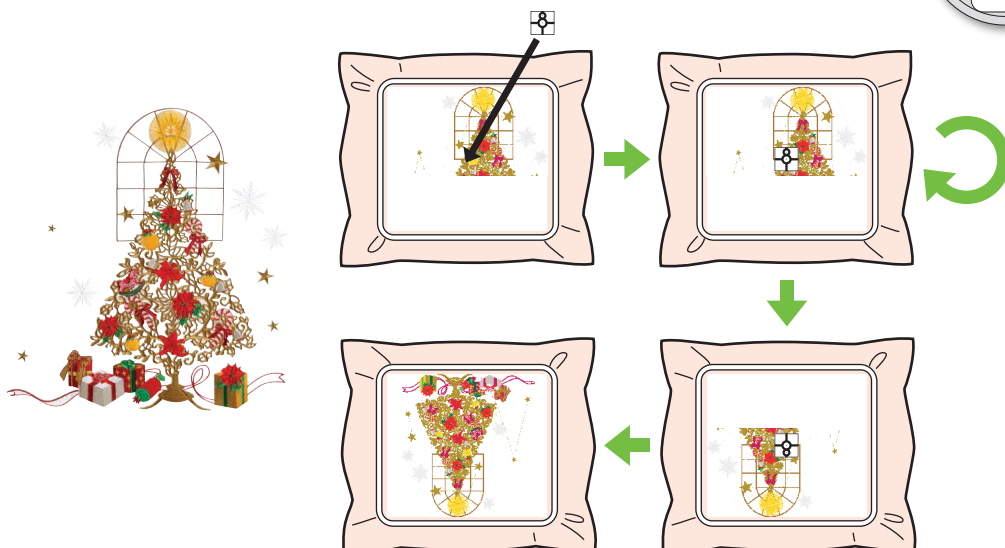

Brodera stora mönster

Du kan brodera broderimönster på upp till 360 mm × 360 mm med hjälp av jumboramen (tillval).

Brodera bara mönstrets första halva, vrid ramen 180 grader och brodera mönstrets andra halva.

Stora mönster (broderier på upp till 350 mm × 350 mm [13-3/4 tum × 13-3/4 tum]) för jumboramen (tillval) kan skapas med hjälp av broderiredigeringsprogramvaran PE-DESIGN NEXT eller en senare version.

Vissa enklare mönster medföljer PE-DESIGN NEXT.

Vyšívání velkých vzorů

Pomocí volitelného jumbo rámečku můžete vyšívat vyšivací vzor o rozměrech až 360 mm × 360 mm (14 palců × 14 palců). Jednoduše vyšijte první polovinu designu, otočte tkaninu o 180 stupňů a vyšijte druhou polovinu designu.

Velké vzory (až do velikosti vyšivky 350 mm × 350 mm (13-3/4 palců × 13-3/4 palců)) pro volitelný jumbo rámeček mohou být vytvořeny pomocí software pro editování výšivek verze PE-DESIGN NEXT nebo novější.

Některé příklady vzorů jsou zahrnuty v aplikaci PE-DESIGN NEXT.

Haftowanie dużych wzorów

Opcjonalna duża ramka umożliwia wyhaftowanie wzoru haftu o maksymalnych wymiarach 360 mm × 360 mm (14 cala × 14 cala).

Wyhaftuj połowę wzoru, następnie obróć obręcz o 180 stopni i wyhaftuj drugą połowę.

Duże wzory (o rozmiarze do 350 × 350 mm (13 3/4 × 13 3/4 cali)), haftowane przy użyciu opcjonalnych tamborków typu jumbo, można projektować za pomocą oprogramowania do tworzenia projektów haftów w wersji PE-DESIGN NEXT lub nowszej.

W wersji PE-DESIGN NEXT dostępne są przykładowe wzory.

Embroidering quilt patterns

The optional quilt frame and magnetic sash frame are best for embroidering quilt pieces of your favorite designs. The magnetic sash frame makes it easier to rehoop the fabric without removing the frame from the machine.

Brodering af quiltemønstre

Quilterammen eller den magnetiske ramme (ekstraudstyr) er bedst egnet til broderi af quiltede stykker med dine favoritdesigns. Den magnetiske ramme gør det lettere at sætte stoffet i rammen igen, uden at rammen skal fjernes fra maskinen.

Quilt minták hímzése

Az opcionális steppelő keret és a mágneses keret a legjobb megoldás a kedvenc steppelt minták elkészítéséhez. A mágneses keret segítségével az anyag könnyen újra befogható anélkül, hogy a keretet a gépből el kellene távolítani.

Brodarea modelelor matlasate

Ghergheturile opționale, gherghetul pentru matlasat și gherghetul magnetic, sunt recomandate la brodarea pieselor matlasate ale modelelor dumneavoastră favorite. Gherghetul magnetic vă ajută să prindeți din nou materialul fără să scoateți gherghetul din mașină.

Brodera kviltningsmönster

Den valfria quiltramen och den magnetiska sash-ramen är bäst för att brodera quiltning av dina favoritdesigns. Den magnetiska sash-ramen gör det enklare att binda om tyget utan att ta bort ramen från maskinen.

Vyšívání prošivaných vzorů

Volitelný prošívací rám a magnetický rám jsou nejlepší pro vyšívání prošivaných kousků vašich oblíbených návrhů. Magnetický rám usnadňuje opětovné upevnění látky na rám, aniž by bylo třeba vyjmout rám ze stroje.

Haftowanie wzorów na kołdrach pikowanych

Najlepszym rozwiązaniem do haftowania ulubionych wzorów jest opcjonalna ramka do pikowania i ramka magnetyczna. Ramka magnetyczna umożliwia ponowne mocowanie tkaniny bez zdejmowania ramki z maszyny.

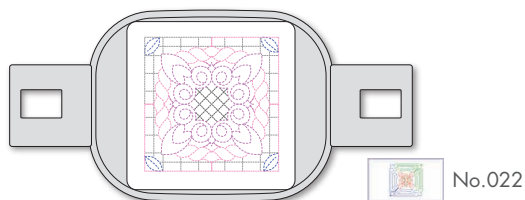

- Examples of combining patterns using the optional quilt frame
- Eksempler på kombinationer af mønstre med brug af quiltrammen (ekstraudstyr)
- Példák a különböző minták kombinációjára az opcionális steppelő keret használatával
- Exemple de combinare a modelelor folosind gherghetul opțional pentru matlasat

- Exempel på att kombinera mönster med den valfria quiltramen.
- Příklady kombinování vzorů při použití volitelného prošívacího rámu
- Przykłady łączonych wzorów z użyciem opcjonalnej ramki do pikowania

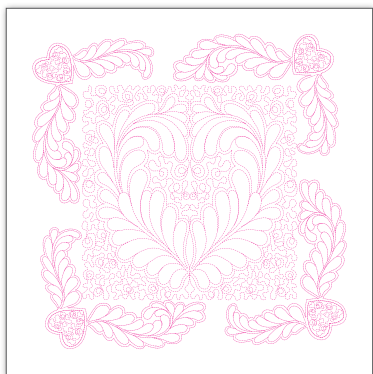

No.011 x 2, No.012 x 4

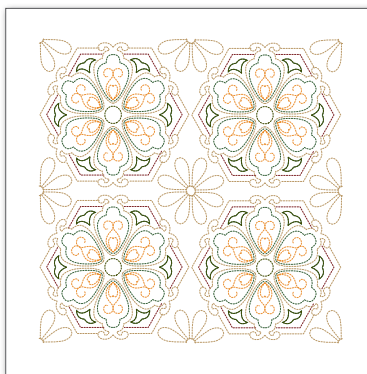

No.016 x 4

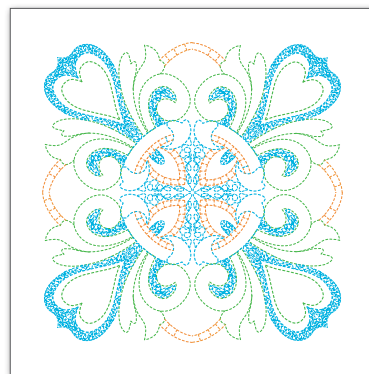

No.020 x 4

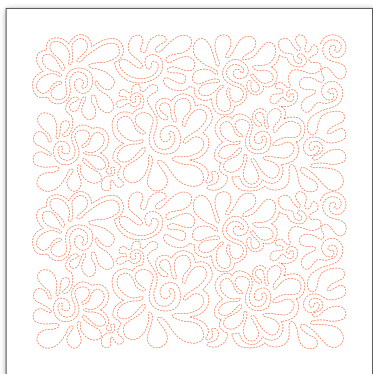

No.013 x 2

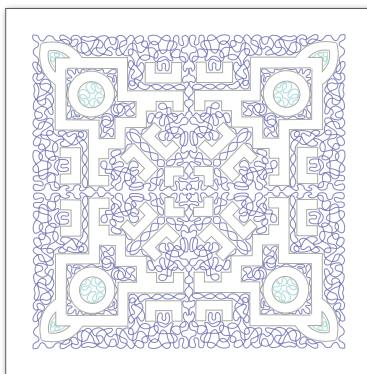

No.006 x 4

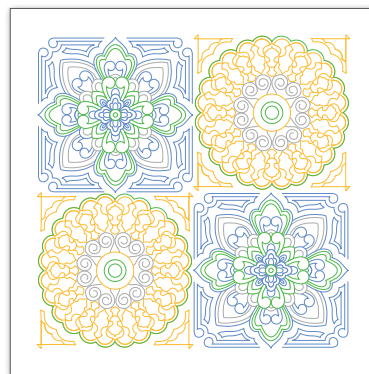

No.007 x 2, No.008 x 2

•Examples of combining patterns using the optional magnetic sash frame

•Eksempler på kombinationer af mønstre med brug af quilterammen (ekstraudstyr)

•Példák a különböző minták kombinációjára az opcionális mágneses keret használatával

•Exemple de combinare a modelelor folosind ghergheful magnetic optional

•Exempel på att kombinera mönster med den valfria magnetiska sash-ramen.

•Příklady kombinování vzorů při použití volitelného magnetického rámu

•Przykłady łączonych wzorów z użyciem opcjonalnej ramki magnetycznej

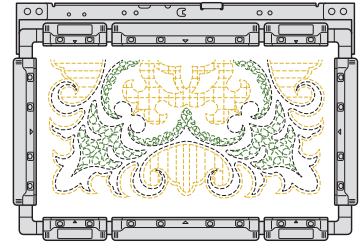

 No.001

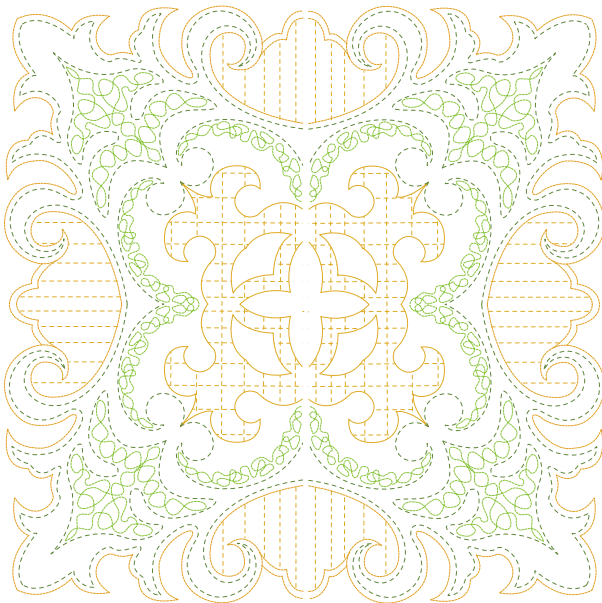

 No.001 x 2

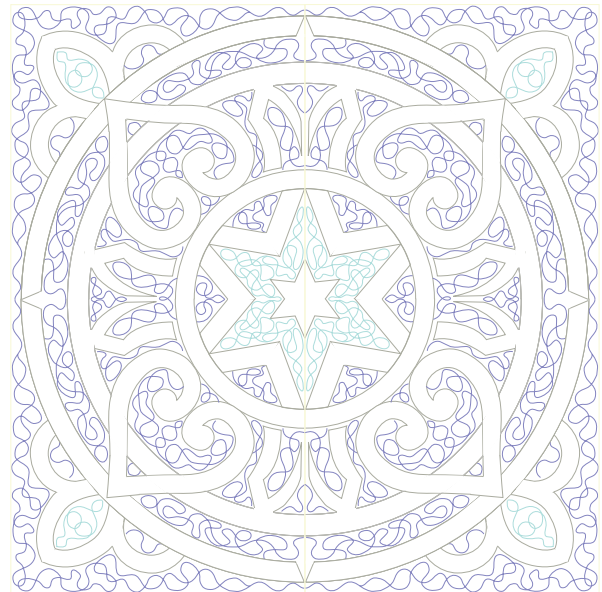

 No.004 x 2

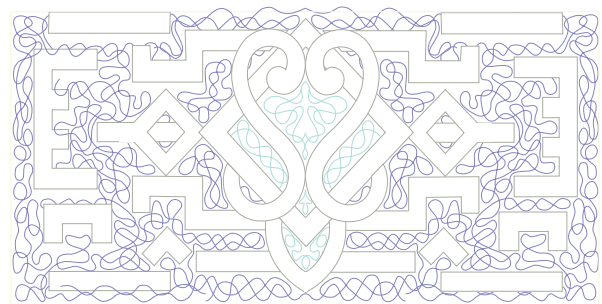

 No.005

Embroidering repeated patterns

The optional border frame and magnetic sash frame help you to embroider repeated patterns. They make it easier to rehoop the fabric without removing the frames from the machine.

Brodering af border (gentagne mønstre)

Kantrammen og den magnetiske ramme (ekstraustyr) er en hjælp ved broderi af gentagne mønstre. De gør det lettere at sætte stoffet i rammen igen, uden at rammerne skal fjernes fra maskinen.

Ismétlődő minták hímzése

Az opcionális szegélykeret és a mágneses keret megkönnyíti az ismétlődő hímzés minták készítését. Segítségükkel az anyag könnyen újra befogható anélkül, hogy a kereteket a gépből el kellene távolítani.

Brodarea modelelor repetitive

Ghergheturile opționale, gherghetur pentru borduri și gherghetur magnetic, vă ajută să brodați modele repetitive. Acestea vă ajută să prindeți din nou materialul fără să scoateți gherghetur din mașină.

- Examples of combining patterns using the optional border frame
- Eksempler på kombinationer af mønstre med brug af kantrammen (ekstraustyr)
- Példák a különböző minták kombinációjára az opcionális szegélykeret használatával
- Exemple de combinare a modelelor folosind gherghetur opțional pentru borduri

Brodera upprepade mönster

Med hjälp av den valfria kantbroderramen och den magnetiska sash-ramen kan du brodera upprepade mönster. De gör det lättare att binda om tyget utan att ta bort ramarna från maskinen.

Vyšívání opakovaných vzorů

Volitelný okrajový rám a magnetický rám vám pomohou při vyšívání opakovaných vzorů. Ušnadňují opětovné upevnění látky na rám, aniž by bylo třeba vyjmout rám ze stroje.

Haftowanie powtarzających się wzorów

Opcjonalna ramka do obrębiania i ramka magnetyczna umożliwiają haftowanie powtarzalnych wzorów. Ułatwiają ponowne mocowanie tkaniny bez zdejmowania ramek z maszyny.



- Exempel på att kombinera mönster med hjälp av den valfria kantbroderramen
- Příklady kombinování vzorů při použití volitelného okrajového rámu
- Przykłady łączonych wzorów z użyciem opcjonalnej ramki do obrębiania

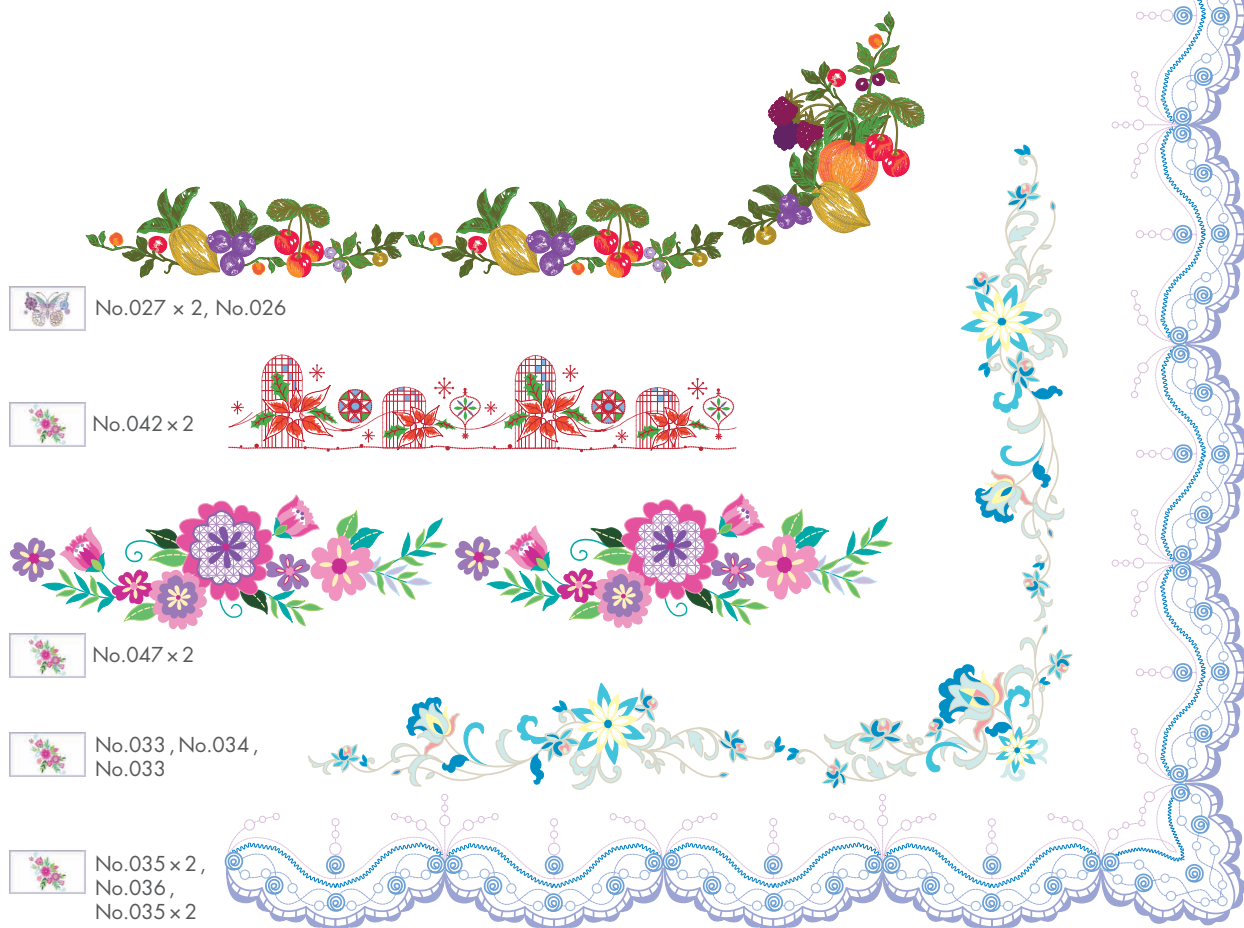

• Examples of combining patterns using the optional magnetic sash frame

• Eksempler på kombinationer af mønstre med brug af quilterammen (ekstraudstyr)

• Příklad a különböző minták kombinációjára az opcionális mágneses keret használatával

• Exemple de combinare a modelelor folosind gherghiful magnetic opțional

• Exempel på att kombinera mönster med den valfria magnetiska sash-ramen

• Příklady kombinování vzorů při použití volitelného magnetického rámu

• Przykłady łączonych wzorów z użyciem opcjonalnej ramki magnetycznej

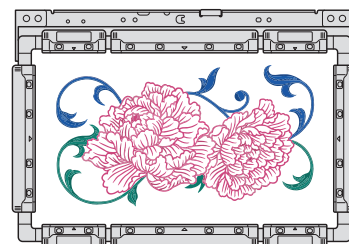

 No.004



 No.004 x 3

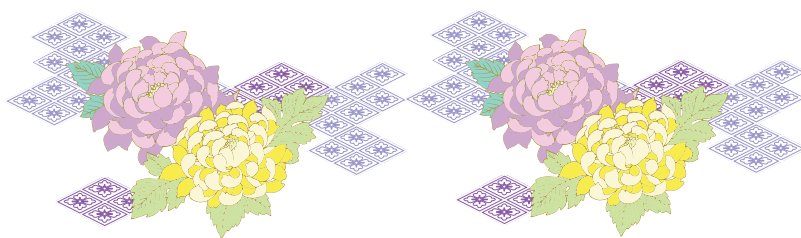

 No.007 x 2

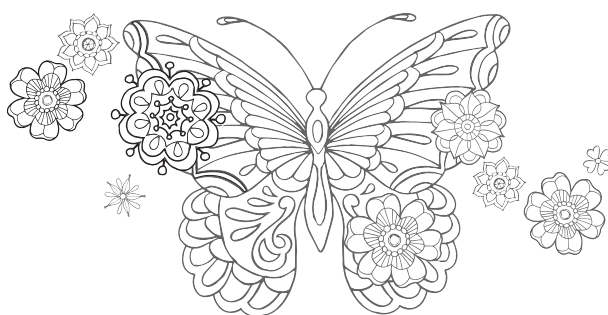

 No.009, No.010

- Monochrome
- Sort/hvid
- Monokróm
- Monocrom

- Svartvitt
- Monochromatický vzor
- Jednobarwny



 No.009, No.010

- Color
- Farve
- Szín
- Culoare
- Färg
- Barva
- Kolorowy



Font Name Chart
 Skema over skrifttypenavne
 Betűtípus-névtáblázat
 Diagrama cu numele fonturilor

Tabell över namn på teckensnitt
 Tabulka s názvy písem
 Tabela nazw czcionek

	Font Key/ Prov på teckensnitt / Skriftpetast / Tlačítko písma / Betűtípus-billentyű / Klucz czcionki / Tasta pentru fonturi	Font Name/ Namn på teckensnitt / Skriftpenavn / Název písma / Betűtípusnév / Nazwa czcionki / Numele fontului
1	⁰⁰ 	Künstlerschreibschrift
2	⁰¹ 	Block 01
3	⁰² 	Block 02
4	⁰³ 	Alaska
5	⁰⁴ 	Serif 01
6	⁰⁵ 	Serif 03
7	⁰⁶ 	Brussels Demi Outline
8	⁰⁷ 	Tennessee ExtraBold
9	⁰⁸ 	Serif 02
10	⁰⁹ 	Script 01
11	¹⁰ 	Calgary Mediumitaric
12	¹¹ 	Bermuda Script
13	¹² 	Sicilia Light Italic (Sicilia)
14	¹³ 	Kingston Regular
15	¹⁴ 	Luedickital
16	¹⁵ 	Toms Handwritten
17	¹⁶ 	Brunei
18	¹⁷ 	Block 03
19	¹⁸ 	Istanbul

	Font Key/ Prov på teckensnitt / Skriftpetast / Tlačítko písma / Betűtípus-billentyű / Klucz czcionki / Tasta pentru fonturi	Font Name/ Namn på teckensnitt / Skriftpenavn / Název písma / Betűtípusnév / Nazwa czcionki / Numele fontului
20	¹⁹ ABC	Los Angeles
21	²⁰ ABC	San Diego
22	²¹ ABC	Saipan
23	²² ABC	Cairo
24	²³ ABC	Gothic 01
25	²⁴ ABC	Germany
26	²⁵ ABC	Sofia Bold
27	²⁶ АБВ	Utah Bold Cyrillic
28	²⁷ АБВ	PC Tennessee Bold Cyrillic
29	²⁸ ABCDE	Helsinki Nallow S
30	²⁹ ABCDE	Antique Oakland S
31	³⁰ <i>ABCDE</i>	Riesa S
32	³¹ ABCDE	Germany S
33	³² <i>ABCDE</i>	Script 01 SR
34	³³ ABCDEFGH	Block 01 (Small font)
35	³⁴ あいう	Japanese Font 1/ Japanskt teckensnitt 1/ Skriftpen Japansk 1/ Japonské písmo 1/ 1-es japán betűkészlet/ Czcionka japońska 1/ Caractere japoneze 1
36	³⁵ あいう	Japanese Font 2/ Japanskt teckensnitt 2/ Skriftpen Japansk 2/ Japonské písmo 2/ 2-es japán betűkészlet/ Czcionka japońska 2/ Caractere japoneze 2
37	³⁶ あいう	Japanese Font 3/ Japanskt teckensnitt 3/ Skriftpen Japansk 3/ Japonské písmo 3/ 3-as japán betűkészlet/ Czcionka japońska 3/ Caractere japoneze 3

English
Swedish
Danish
Czech
Hungarian
Polish
Romanian

884-T15



XH5056-001