

Operation Manual Sewing

Sewing and Embroidery Machine

Product Code: 882-W33



Be sure to read this document before using the machine.
We recommend that you keep this document nearby for future reference.

INTRODUCTION

Thank you for purchasing this machine.

Before using this machine, carefully read the "IMPORTANT SAFETY INSTRUCTIONS", and then study this manual for the correct operation of the various functions. In addition, after you have finished reading this manual, keep it where it can quickly be accessed for future reference.

IMPORTANT SAFETY INSTRUCTIONS

Please read these safety instructions before attempting to use the machine.

DANGER - To reduce the risk of electric shock

- 1 Always unplug the machine from the electrical outlet immediately after using, when cleaning, making any user servicing adjustments mentioned in this manual, or if you are leaving the machine unattended.

WARNING - To reduce the risk of burns, fire, electrical shock, or injury to persons.

- 2 Always unplug the machine from the electrical outlet when making any adjustments mentioned in the instruction manual.

- To unplug the machine, switch the machine to the symbol "O" position to turn it off, then grasp the plug and pull it out of the electrical outlet. Do not pull on the cord.
- Plug the machine directly into the electrical outlet. Do not use an extension cord.
- Always unplug your machine if there is a power failure.

- 3 Electrical Hazards:

- This machine should be connected to an AC power source within the range indicated on the rating label. Do not connect it to a DC power source or inverter. If you are not sure what kind of power source you have, contact a qualified electrician.
- This machine is approved for use in the country of purchase only.

- 4 Never operate this machine if it has a damaged cord or plug, if it is not working properly, it has been dropped or damaged, or water is spilled on the unit. Return the machine to the nearest authorized Brother dealer for examination, repair, electrical or mechanical adjustment.

- While the machine is stored or in use if you notice anything unusual, such as an odor, heat, discoloration or deformation, stop using the machine immediately and unplug the power cord.
- When transporting the machine, be sure to carry it by its handle. Lifting the machine by any other part may damage the machine or result in the machine falling, which could cause injuries.
- When lifting the machine, be careful not to make any sudden or careless movements, which may cause a personal injury.

5 Always keep your work area clear:

- Never operate the machine with any air openings blocked. Keep ventilation openings of the machine and foot controller free from the build up of lint, dust, and loose cloth.
- Do not store objects on the foot controller.
- Never drop or insert foreign objects into any opening.
- Do not operate where aerosol (spray) products are being used or where oxygen is being administered.
- Do not use the machine near a heat source, such as a stove or iron; otherwise, the machine, power cord or garment being sewn may ignite, resulting in fire or an electric shock.
- Do not place this machine on an unstable surface, such as an unsteady or slanted table, otherwise the machine may fall, resulting in injuries.

6 Special care is required when sewing:

- Always pay close attention to the needle. Do not use bent or damaged needles.
- Keep fingers away from all moving parts. Special care is required around the machine needle.
- Switch the machine to the symbol "O" position to turn it off when making any adjustments in the needle area.
- Do not use a damaged or incorrect needle plate, as it could cause the needle to break.
- Do not push or pull the fabric when sewing, and follow careful instruction when free motion stitching so that you do not deflect the needle and cause it to break.

7 This machine is not a toy:

- Your close attention is necessary when the machine is used by or near children.
- This product contains small parts. Keep the product out of the reach of children to prevent accidental ingestion of small parts.
- The plastic bag that this machine was supplied in should be kept out of the reach of children or disposed of. Never allow children to play with the bag due to the danger of suffocation.
- Do not use the seam ripper in any other way than how it is intended.
- Do not use outdoors.

8 For a longer service life:

- When using and storing this machine, avoid direct sunlight and high humidity locations. Do not use or store the machine near a space heater, iron, halogen lamp, or other hot objects.
- Do not use cleansers or organic solvents, such as thinner, petroleum ether or alcohol, to clean the machine. Otherwise, the finish may peel off or become scratched.
- Do not oil the machine by yourself to prevent damaging it.
- Always consult the Operation Manual when replacing or installing any assemblies, the presser feet, needle, or other parts to assure correct installation.

9 For repair or adjustment:

- If the light unit is damaged, it must be replaced by an authorized Brother dealer.
- In the event a malfunction occurs or adjustment is required, first follow the troubleshooting table in the back of the Operation Manual to inspect and adjust the machine yourself. If the problem persists, please consult your local authorized Brother dealer.

Use this machine only for its intended use as described in the manual.

Use accessories recommended by the manufacturer as contained in this manual.

The contents of this manual and specifications of this product are subject to change without notice.

For additional product information and updates, visit our website at www.brother.com

SAVE THESE INSTRUCTIONS

This machine is intended for household use.

FOR USERS IN COUNTRIES EXCEPT EUROPEAN COUNTRIES

This appliance is not intended for use by persons (including children) with reduced physical, sensory or mental capabilities, or lack of experience and knowledge, unless they have been given supervision or instruction concerning use of the appliance by a person responsible for their safety. Children should be supervised to ensure that they do not play with the appliance.

FOR USERS IN EUROPEAN COUNTRIES

This appliance can be used by children aged from 8 years and above and persons with reduced physical, sensory or mental capabilities or lack of experience and knowledge if they have been given supervision or instruction concerning use of the appliance in a safe way and understand the hazards involved. Children shall not play with the appliance. Cleaning and user maintenance shall not be made by children without supervision.

FOR USERS IN THE UK, EIRE, MALTA AND CYPRUS ONLY

IMPORTANT

- In the event of replacing the plug fuse, use a fuse approved by ASTA to BS 1362, i.e. carrying the  mark, rating as marked on plug.
- Always replace the fuse cover. Never use plugs with the fuse cover omitted.
- If the available electrical outlet is not suitable for the plug supplied with this equipment, you should contact your authorized Brother dealer to obtain the correct lead.

Federal Communications Commission (FCC) Supplier's Declaration of Conformity (For U.S.A. Only)

Responsible Party: Brother International Corporation
200 Crossing Boulevard
P.O. Box 6911
Bridgewater, NJ 08807-0911 U.S.A.
TEL : (908) 704-1700

declares that the product

Product Name: Brother Sewing Machine
Model Number: XP3

This device complies with Part 15 of the FCC Rules. Operation is subject to the following two conditions: (1) this device may not cause harmful interference, and (2) this device must accept any interference received, including interference that may cause undesired operation.

This equipment has been tested and found to comply with the limits for a Class B digital device, pursuant to Part 15 of the FCC Rules. These limits are designed to provide reasonable protection against harmful interference in a residential installation. This equipment generates, uses, and can radiate radio frequency energy and, if not installed and used in accordance with the instructions, may cause harmful interference to radio communications. However, there is no guarantee that interference will not occur in a particular installation. If this equipment does cause harmful interference to radio or television reception, which can be determined by turning the equipment off and on, the user is encouraged to try to correct the interference by one or more of the following measures:

- Reorient or relocate the receiving antenna.
- Increase the separation between the equipment and receiver.
- Connect the equipment into an outlet on a circuit different from that to which the receiver is connected.
- Consult the authorized Brother dealer or an experienced radio/TV technician for help.
- This transmitter must not be co-located or operated in conjunction with any other antenna or transmitter.

Important

Changes or modifications not expressly approved by Brother Industries, Ltd. could void the user's authority to operate the equipment.

This equipment complies with FCC/IC radiation exposure limits set forth for an uncontrolled environment and meets the FCC radio frequency (RF) Exposure Guidelines and RSS-102 of the IC radio frequency (RF) Exposure rules. This equipment should be installed and operated keeping the radiator at least 20cm or more away from person's body.

For Users in Canada

This device complies with Industry Canada's licence-exempt RSSs. Operation is subject to the following two conditions:

- (1) This device may not cause interference; and
- (2) This device must accept any interference, including interference that may cause undesired operation of the device.

This equipment complies with FCC/IC radiation exposure limits set forth for an uncontrolled environment and meets the FCC radio frequency (RF) Exposure Guidelines and RSS-102 of the IC radio frequency (RF) Exposure rules. This equipment should be installed and operated keeping the radiator at least 20cm or more away from person's body.

For Users in Mexico

The operation of this equipment is subject to the following two conditions:

- (1) it is possible that this equipment or device may not cause harmful interference, and
- (2) this equipment or device must accept any interference, including interference that may cause undesired operation.

La operación de este equipo está sujeta a las siguientes dos condiciones:

- (1) es posible que este equipo o dispositivo no cause interferencia perjudicial y
- (2) este equipo o dispositivo debe aceptar cualquier interferencia, incluyendo la que pueda causar su operación no deseada.

Declaration of Conformity (Europe and Turkey only)

We, Brother Industries, Ltd. 15-1 Naeshiro-cho, Mizuho-ku, Nagoya 467-8561 Japan declare that this product is in conformity with the essential requirements of all relevant directives and regulations applied within the European Community.

The Declaration of Conformity (DoC) can be downloaded from Brother support website.

Visit support.brother.com

Declaration of Conformity for RE Directive 2014/53/EU (Europe and Turkey only) (Applicable to models with radio interfaces)

We, Brother Industries, Ltd. 15-1 Naeshiro-cho, Mizuho-ku, Nagoya 467-8561 Japan declare that these products are in conformity with the provisions of the RE Directive 2014/53/EU.

The Declaration of Conformity (DoC) can be downloaded from Brother support website. Visit support.brother.com

Wireless LAN (Models with Wireless LAN function only)

This machine supports wireless interface.

Frequency band(s): 2400-2483.5 MHz

Maximum radio-frequency power transmitted in the frequency band(s): Less than 20 dBm(e.i.r.p)

UK Declaration of Conformity (Great Britain only)

We, Brother Industries, Ltd. 15-1 Naeshiro-cho, Mizuho-ku, Nagoya 467-8561 Japan declare that these products are in conformity with the relevant UK legislation.

The Declaration of Conformity (DoC) can be downloaded from Brother support website. Visit support.brother.com

UK Declaration of Conformity for Radio Equipment Regulation 2017 (Great Britain only) (Applicable to models with radio interfaces)

We, Brother Industries, Ltd. 15-1 Naeshiro-cho, Mizuho-ku, Nagoya 467-8561 Japan declare that these products are in conformity with the provisions of the Radio Equipment Regulation 2017.

The Declaration of Conformity (DoC) can be downloaded from Brother support website. Visit support.brother.com

For Users in Norway

- * This subsection does not apply for the geographical area within a radius of 20 km from the centre of Ny-Alesund on Svalbard.
- * Dette underavsnittet gjelder ikke for det geografiske området innenfor en radius av 20 km fra sentrum av Ny-Ålesund på Svalbard.

For Users in Thailand

This telecommunication equipment conforms to NTC technical requirement.

Legal limitations for copying (United States/Canada)

Observe all copyright laws when using this product.

Color reproductions of certain documents are illegal and may result in either criminal or civil liability. This memorandum is intended to be a guide rather than a complete listing of every possible prohibition. In case of doubt, we suggest that you check with counsel as to any particular questionable documents.

The following documents issued by the United States/Canadian Government or any of its Agencies may not be copied:

- Money
- Bonds or other certificates of indebtedness
- Certificates of Deposit
- Internal Revenue Stamps (canceled or uncanceled)
- Selective Service or draft papers
- Passports
- United States/Canadian Postage Stamps (canceled or uncanceled)
- Food Stamps
- Immigration Papers
- Checks or drafts drawn by Governmental agencies
- Identifying badges or insignias

Copyrighted works cannot be copied. Sections of a copyrighted work can be copied for 'fair use'.

Multiple copies would indicate improper use.

Works of art should be considered the equivalent of copyrighted works.

Unlawful Use of Scanning Equipment (Other countries except United States/Canada)

It is an offence to make reproductions of certain items or documents with the intent to commit fraud. The following is a non-exhaustive list of documents which it may be unlawful to produce copies of. We suggest you check with your legal adviser and/or the relevant legal authorities if in doubt about a particular item or document:

- Currency
- Bonds or other certificates of debt
- Certificates of Deposit
- Armed forces service or draft papers
- Passports
- Postage stamps (cancelled or uncanceled)
- Immigration papers
- Welfare documents
- Cheques or drafts drawn by governmental agencies
- Identifying badges or insignias

Copyrighted works cannot be copied lawfully, subject to the “fair dealing” exception relating to sections of a copyrighted work. Multiple copies would indicate improper use. Works of art should be considered the equivalent of copyrighted works.

WARNING SIGN

■ Spool Stand

The warning label is attached to the bottom.

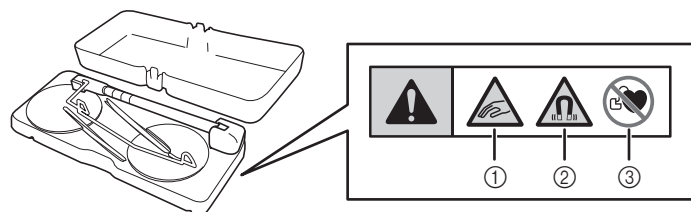

This product contains magnets.

- ① Be careful not to pinch your fingers or any objects between the spool stand and the upper cover of the machine.
- ② Be sure to keep the magnets away from precision electronics, computer disks, credit cards with a magnetic stripe, etc.
- ③ Do not use the spool stand if you have a pacemaker.

TRADEMARKS

SD is a trademark of SD-3C, LLC.

WPA™ and WPA2™ are trademarks of Wi-Fi Alliance®.

Any trade names and product names of companies appearing on Brother products, related documents and any other materials are all trademarks or registered trademarks of those respective companies.

COPYRIGHT AND LICENSE

This product includes software developed by the following vendor: ©2008 Devicescape Software, Inc.

OPEN SOURCE LICENSING REMARKS

This product includes open-source software.

To see the open source licensing remarks, please go to the manual download section on your model's home page of Brother Support website at "<https://s.brother/cpdab/>".

PRECAUTION FOR WIRELESS CONNECTION

Make sure you use a router or firewall when connecting your machine to the Internet to protect it against unauthorized access from the Internet.

HOW TO USE THIS MANUAL

The Operation Manuals for this machine consist of the Operation Manual (Sewing) and the Operation Manual (Embroidery). Refer to the appropriate Operation Manual according to your needs. For basic information about, for example, the included accessories or the settings screen, refer to chapter 1 of the Operation Manual (Sewing).

In the screens appearing in the step-by-step instructions, the parts referred to in the operations are marked with . Compare the screen in the directions with the actual screen, and carry out the operation.

If, while using the machine, you experience something you do not understand, or there is a function you would like to know more about, refer to the index at the back of the Operation Manual in conjunction with the table of contents to find the section of the manual you should refer to.

CONTENTS

INTRODUCTION.....	1	Using Advanced Multi-Function Foot Controller	63	1
IMPORTANT SAFETY INSTRUCTIONS	1	Sewing Reverse/Reinforcement Stitches.....	66	
WARNING SIGN.....	7	Automatic Reinforcement Stitching	66	
TRADEMARKS.....	7	Automatic Presser Foot Lowering Function and Thread Cutting Function.....	68	
COPYRIGHT AND LICENSE.....	7	Automatic Presser Foot Raising Function	68	
OPEN SOURCE LICENSING REMARKS.....	8	Sewing Curves.....	69	
PRECAUTION FOR WIRELESS CONNECTION	8	Changing Sewing Direction.....	69	2
HOW TO USE THIS MANUAL	8	Sewing Heavyweight Fabrics.....	69	
Chapter 1 Getting Ready	11	Sewing Hook-and-Loop Fastener Tape	70	
NAMES OF MACHINE PARTS AND THEIR FUNCTIONS	12	Sewing Lightweight Fabrics	71	3
INCLUDED ACCESSORIES	14	Sewing Stretch Fabrics.....	71	
Using the Accessory Case	14	Sewing Leathers or Vinyl Fabrics	71	
Using the Flat Bed Attachment.....	14	Sewing Cylindrical Pieces	71	
Using Fine Tipped Stylus Pen.....	15	STITCH SETTINGS	72	
Using the Multi-purpose Screwdriver	15	Setting the Stitch Width	72	
Assembling the Spool Stand	16	Setting the Stitch Length	73	
TURNING THE MACHINE ON/OFF	17	Setting the [L/R Shift]	73	
Setting Your Machine for the First Time	18	Setting the Thread Tension	74	
LCD SCREEN	19	USEFUL FUNCTIONS	75	
Using the Machine Setting Mode Key	20	Automatic Thread Cutting	75	
Sewing Settings.....	20	Pivoting.....	76	
General Settings	21	Using the Knee Lifter	77	
Embroidery Settings	23	Automatic Fabric Sensor System (Automatic Presser Foot Pressure).....	78	
Wireless LAN settings	24	Needle Position - Stitch Placement.....	78	
Setting Functions.....	24	Checking the Needle Location in the Screen	79	
Using the Machine Help Key	28	USING THE PROJECTOR.....	80	
Using the Operation Guide Function	29	Convenient Sewing Features by Using the Projector	80	
Using the Sewing Guide Function	30	About the Dual Purpose Stylus	80	
Playing a Tutorial Video.....	31	Installing a Battery in the Dual Purpose Stylus	80	
Playing MPEG-4 (MP4) Videos.....	32	Operating the Projector with the Dual Purpose Stylus	81	
Using the Stitch Pattern Explanation Function	32	Using the Dual Purpose Stylus Holder.....	81	
Viewing the Operation Manual (PDF File) on the Machine	33	PROJECTOR FUNCTIONS (UTILITY STITCHES AND CHARACTER/DECORATIVE STITCHES)....	82	
WIRELESS NETWORK CONNECTION FUNCTIONS	34	Projection Area of Projector	82	
Operations Available with a Wireless Network Connection	34	Projecting the Stitch Pattern with the Projector	82	
Specifying Wireless Network Connection Settings.....	34	Selecting a Stitch Pattern with the Dual Purpose Stylus.....	83	
Using the Wizard to Set Up the Wireless Network Connection	35	Editing a Stitch Pattern Selected with the Dual Purpose Stylus	83	
CONNECTING THE ACCESSORY TO THE MACHINE	37	Projecting the Guidelines with the Projector.....	84	
Using USB Media/SD Card (Sold Separately).....	37	Specifying the Sewing End Point.....	86	
Using a USB Mouse	37	Chapter 3 Utility Stitches	89	
Chapter 2 Sewing Basics	39	SELECTING UTILITY STITCHES	90	
LOWER THREADING.....	40	Selecting a Stitch	94	
Winding the Bobbin.....	40	Saving Your Stitch Settings	96	
Setting the Bobbin.....	44	SEWING THE STITCHES	97	
Pulling Up the Bobbin Thread.....	46	Straight Stitches	97	
UPPER THREADING	47	Dart Seam	101	
Upper Threading.....	47	Gathering	102	
Using the Twin Needle Mode	50	Flat Fell Seam	102	
Using the Spool Stand.....	52	Pintuck	103	
CHANGING THE NEEDLE.....	54	Zigzag Stitches	104	
Fabric/Thread/Needle Combinations	56	Elastic Zigzag Stitches	105	
CHANGING THE PRESSER FOOT	57	Overcasting.....	106	
Removing the Presser Foot	57	Quilting.....	107	
Attaching the Presser Foot	57	Hand-Look Quilting	116	
Attaching the Presser Foot with the Included Adapter	58	Blind Hem Stitches.....	117	
Using the Compact Dual Feed Foot	59	Appliqué	119	
SEWING	62	Shelltuck Stitches	120	
Sewing a Stitch	62	Scallop Stitches	120	
		Crazy Quilting.....	121	
		Smocking Stitches	121	
		Fagoting	122	
		Tape or Elastic Attaching	123	
		Heirloom.....	124	
		Basting	125	
				4
				5
				6

Zigzag Couching 126
 One-Step Buttonholes 128
 Four-Step Buttonholes 133
 Bar Tacks 135
 Button Sewing 136
 Eyelet 137
 Multi-directional Sewing (Straight Stitch and Zigzag
 Stitch)..... 138
 Zipper Insertion 139
 Changing the Start and End Angles of the Stitch Pattern (Stitch
 Tapering Function) 142

Chapter 4 Character/Decorative Stitches 145

SELECTING STITCH PATTERNS..... 146
 Selecting Decorative Stitch Patterns..... 148
 Selecting Character Stitch Patterns..... 148
SEWING STITCH PATTERNS 150
 Sewing Attractive Finishes 150
 Basic Sewing 150
 Making Adjustments 151
EDITING STITCH PATTERNS 153
 Changing the Size 156
 Changing the Length (for 7mm Satin Stitch Patterns
 Only)..... 156
 Creating a Vertical Mirror Image 156
 Creating a Horizontal Mirror Image 156
 Sewing a Stitch Pattern Continuously 156
 Changing Thread Density (for Large Satin Only) 157
COMBINING STITCH PATTERNS 158
 Combining Various Stitch Patterns..... 158
 Combining Large and Small Stitch Patterns..... 159
 Combining Horizontal Mirror Image Stitch Patterns..... 159
 Combining Stitch Patterns of Different Length 160
 Making Step Stitch Patterns 161
USING THE MEMORY FUNCTION..... 163
 Saving Stitch Patterns 163
 Retrieving Stitch Patterns 164
 Managing Saved File 165
 Transferring Stitch Patterns to the Machine (PE-DESIGN to this
 machine) 165

Chapter 5 MY CUSTOM STITCH 167

DESIGNING A STITCH..... 168
ENTERING STITCH DATA 170
 Editing Stitch Stored in the Machine 174
USING STORED CUSTOM STITCHES 175
 Storing Custom Stitches in Your List 175
 Retrieving Stored Stitches 176

Chapter 6 Appendix 177

CARE AND MAINTENANCE..... 178
 Restrictions on Oiling 178
 Precautions on Storing the Machine 178
 Cleaning the LCD Screen 178
 Cleaning the Machine Casing..... 178
 Cleaning the Race 178
 Cleaning the Cutter in the Bobbin Case Area 180
 About the Maintenance Message 180
TROUBLESHOOTING 181
 Frequent Troubleshooting Topics 181
 Upper Thread Is Too Tight..... 181
 Tangled Thread on Wrong Side of Fabric 182
 Incorrect Thread Tension..... 183
 Fabric Is Caught in the Machine and Cannot be
 Removed..... 184
 If the Thread Becomes Tangled Under the Bobbin Winder
 Seat 185
 List of Symptoms 186
ERROR MESSAGES 191
 How Can I Find the Wireless Security Information (SSID and
 Network Key) 193

SPECIFICATIONS 194
UPDATING YOUR MACHINE'S SOFTWARE... 196
 Update Procedure Using USB Media 196
 Update Procedure Using Wireless LAN Connection 197
STITCH SETTING CHART 198
INDEX..... 209



Chapter *1*
Getting Ready

Be sure to install the latest software.

Refer to “UPDATING YOUR MACHINE’S SOFTWARE” on page 196.

NAMES OF MACHINE PARTS AND THEIR FUNCTIONS

Front View

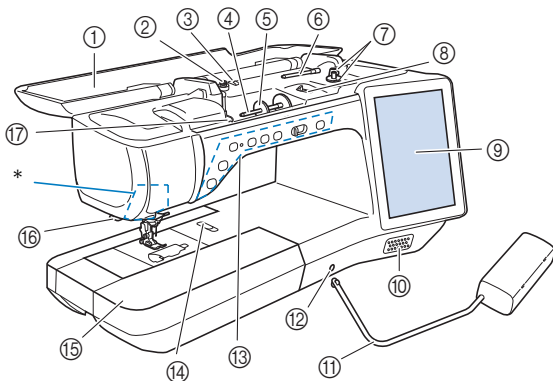

* Camera and projector (built-in)

IMPORTANT

- Do not place any object weighing 1 kg (2.2 lb) or more on the top cover, otherwise the cover may be damaged.
- Do not touch the camera or projector. Otherwise, it will not display properly.

- Top cover**
Open the top cover when threading the machine or winding the bobbin.
- Pretension disk**
Pass the thread around the pretension disk when winding the bobbin thread. (page 40)
- Thread guide for bobbin winding**
Pass the thread through this thread guide when winding the bobbin thread. (page 40)
- Spool pin**
Place a spool of thread on the spool pin. (page 47)
- Spool cap**
Use the spool cap to hold the spool of thread in place. (page 47)
- Supplemental spool pin**
Use this spool pin to wind the bobbin thread, or to sew with the twin needle. (page 40, page 50)
- Bobbin winder**
Use the bobbin winder when winding the bobbin. (page 40)
- Bobbin winding slider**
Adjust the amount of thread wound onto the bobbin. (page 42)
- LCD (liquid crystal display)**
Settings for the selected stitch and error messages appear in the LCD. (page 19)
- Speaker**
- Knee lifter**
Use the knee lifter to raise and lower the presser foot. (page 77)
- Knee lifter slot**
Insert the knee lifter into the slot. (page 77)
- Operation buttons (7 buttons) and sewing speed controller**
Use these buttons and the slide to operate the machine. (page 13)
- Needle plate lever**
Slide the lever toward you to remove the needle plate. (page 178)
- Flat bed attachment with accessory compartment**
Store presser feet and bobbins in the accessory compartment of the flat bed attachment. When sewing cylindrical pieces, remove the flat bed attachment. (page 14)
- Thread cutter**
Pass the threads through the thread cutter to cut them. (page 49)

17 Thread guide plate

Pass the thread around the thread guide plate when threading upper thread. (page 47)

Right-side/Rear View

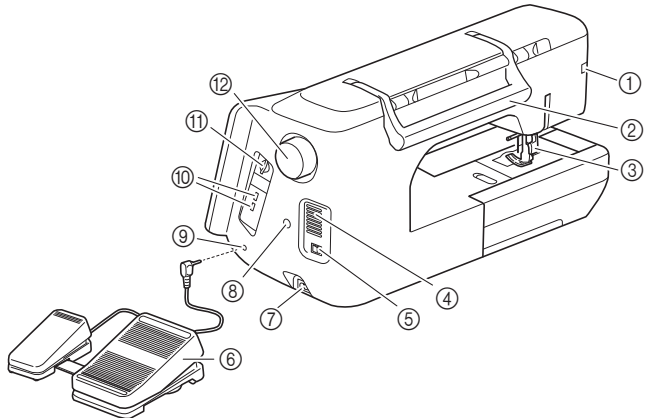

- Connector for the presser foot**
Connect the compact dual feed foot or embroidery foot with LED pointer (sold separately). (page 59)
- Handle**
Carry the machine by its handle when transporting the machine.
- Presser foot lever**
Raise and lower the presser foot lever to raise and lower the presser foot. (page 57)
- Air vent**
The air vent allows the air surrounding the motor to circulate. Do not cover the air vent while the machine is being used.
- Main power switch**
Use the main power switch to turn the machine ON and OFF. (page 17)
- Advanced multi-function foot controller**
Use the advanced multi-function foot controller to operate the machine. (page 63)
- Power cord receptacle**
Insert the power cord into the machine receptacle. (page 17)
- Dual purpose stylus holder connector**
Connect the included dual purpose stylus holder. (page 81)
- Foot controller jack**
Insert the foot controller plug into its jack on the machine. (page 64)
- USB port**
In order to send stitch patterns and embroidery patterns from/ to USB media, plug the USB media directly into the USB port.
- SD card slot**
Insert an SD card into the SD card slot in order to import/export stitch patterns and embroidery patterns.
- Handwheel**
Rotate the handwheel toward you (counterclockwise) to raise and lower the needle. The wheel should be turned toward the front of the machine.

Needle and Presser Foot Section

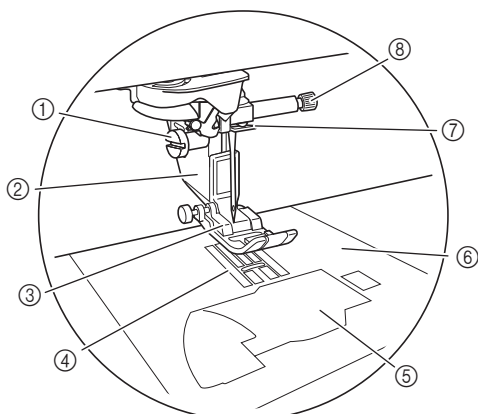

- ① **Presser foot holder screw**
Use the presser foot holder screw to hold the presser foot holder in place. (page 58)
- ② **Presser foot holder**
The presser foot is attached to the presser foot holder. (page 57)
- ③ **Presser foot**
The presser foot consistently applies pressure to the fabric as sewing takes place. Attach the appropriate presser foot for the selected stitch. (page 57)
- ④ **Feed dogs**
The feed dogs feed the fabric in the sewing direction.
- ⑤ **Bobbin cover**
Open the bobbin cover to set the bobbin. (page 44, page 105)
- ⑥ **Needle plate**
The needle plate is marked with guides to help sew straight seams. (page 99)
Remove the needle plate to clean the race. (page 178)
- ⑦ **Needle bar thread guide**
Pass the upper thread through the needle bar thread guide. (page 47)
- ⑧ **Needle clamp screw**
Use the needle clamp screw to hold the needle in place. (page 54)

Embroidery Unit

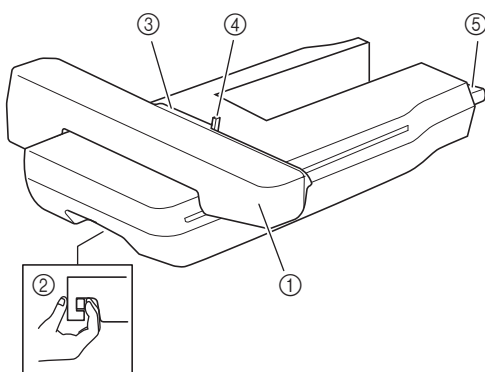





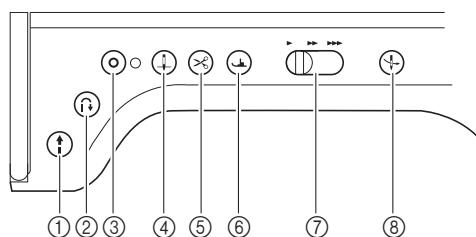

- ① **Carriage**
The carriage moves the embroidery frame automatically when embroidering.
- ② **Release lever (located under the embroidery unit)**
Press the release lever to remove the embroidery unit.
- ③ **Embroidery frame holder**
Insert the embroidery frame into the embroidery frame holder to hold the frame in place.
- ④ **Frame-securing lever**
Press the frame-securing lever down to secure the embroidery frame.
- ⑤ **Embroidery unit connection**
Insert the embroidery unit connection into the connection port of the machine (with the machine powered off) when attaching the embroidery unit.

Operation Buttons



- ① **“Start/Stop” button** 
Press this button and the machine will sew a few stitches at a slow speed and then begin sewing at the speed set by the sewing speed controller. Press the button again to stop the machine. Hold the button in to sew at the machine’s slowest speed. The button changes color according to the machine’s operation mode.

Green: The machine is ready to sew or is sewing.
Red: The machine cannot sew.
- ② **“Reverse Stitch” button** 
For straight, zigzag, and elastic zigzag stitch patterns that take reverse stitches, the machine will sew reverse stitches at low speed only while holding down the “Reverse Stitch” button. The stitches are sewn in the opposite position.
For other stitches, use this button to sew reinforcement stitches at the beginning and end of sewing. Press and hold this button, and the machine sews 3 stitches in the same spot and stops automatically. (page 66)
- ③ **“Reinforcement Stitch” button** 
Use this button to sew a single stitch repeatedly and tie-off. For character/decorative stitches, press this button to end with a full stitch instead of at a mid-point. The LED light beside this button lights up while the machine is sewing a full motif, and automatically turns off when the sewing is stopped. (page 66)
In addition, use this button to sew reinforcement stitches before cutting the thread when changing the bobbin thread in embroidery mode. This will prevent stitches from unraveling.
- ④ **“Needle Position” button** 
Use this button when changing sewing direction or for detailed sewing in small areas. Press this button to raise or lower the needle position. With this button, you can lower and raise the needle to sew a single stitch.
- ⑤ **“Thread Cutter” button** 
Press this button after sewing to automatically trim the excess thread.
- ⑥ **“Presser Foot Lifter” button** 
Press this button to lower the presser foot and apply pressure to the fabric. Press this button again to raise the presser foot.
- ⑦ **Sewing Speed controller** 
Use this controller to adjust the sewing speed. Move the slide to the left to sew at slower speeds. Move the slide to the right to sew at higher speeds.
- ⑧ **“Automatic Threading” button** 
Use this button to automatically thread the needle.

INCLUDED ACCESSORIES

For included accessories of your machine, refer to the additional sheet "Included Accessories".

Using the Accessory Case

■ Opening the Accessory Case

Slide the latches on the front of the accessory case outward to open it.

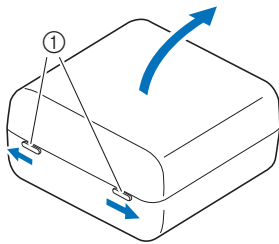

① Latches

■ Storing Bobbin Clips

Bobbin clips can be stored inside of the accessory case cover.

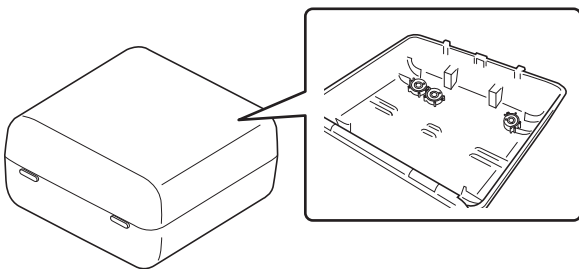

📖 Memo

- Placing bobbin clips on bobbins helps prevent the thread from unwinding from the bobbin. In addition, snapping bobbin clips together allows the bobbins to be conveniently stored and prevents them from rolling around if they are dropped.

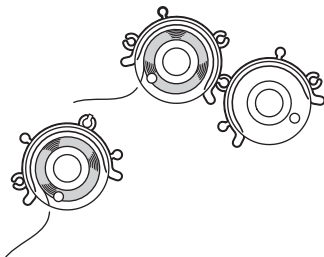

Using the Flat Bed Attachment

Pull the top of the flat bed attachment to open the accessory compartment.

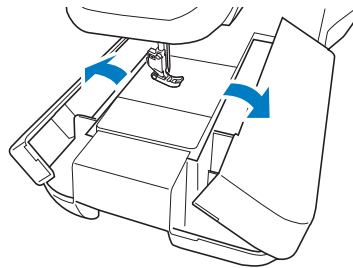

■ Using the Accessory Trays

Three presser foot storage trays are stored in the included accessory case.

For your convenience, a presser foot storage tray can be stored in the accessory compartment of the flat bed attachment.

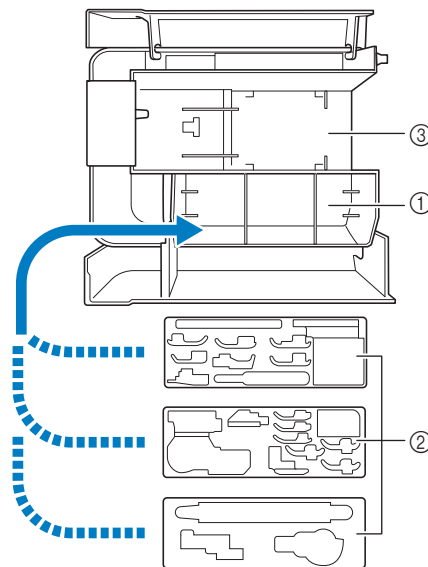

- ① Presser foot storage space of the flat bed attachment
- ② Presser foot storage trays
- ③ Needle plate storage space

Using Fine Tipped Stylus Pen

Touch the LCD screen using the fine tipped stylus pen. Since the pen tip is clearly visible, it is ideal for drawing.

⚠ WARNING

- The fine tipped stylus pen contains small parts. Keep the product out of the reach of children to prevent accidental ingestion of small parts.

IMPORTANT

- Touch the LCD screen with the transparent disc on the fine tipped stylus pen. Using any other part to touch the LCD screen may cause scratches.
- Do not pull on the transparent disc, otherwise damage may result.

- 1 While holding the handle, turn the pen tip cap to remove it.

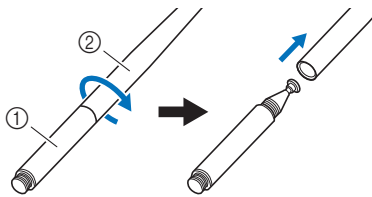

- ① Handle
- ② Pen tip cap

- 2 Attach the pen tip cap to the handle before using the pen.

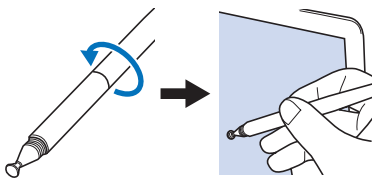

📖 Memo

- Touching the LCD screen with the fine tipped stylus pen at an excessive angle may prevent the contact position from being correctly detected.
- The soft point of the dual purpose stylus can be used to operate the LCD screen. (page 80)

Using the Multi-purpose Screwdriver

Since the screwdriver can be changed to three different positions, it can be extremely useful for the various machine preparations. With this machine, position "1" and position "3" are used.

■ Position "1"

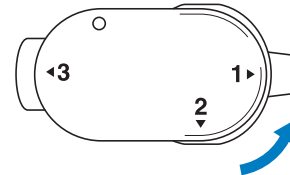

You can install/remove the presser foot holder, needle clamp screw.

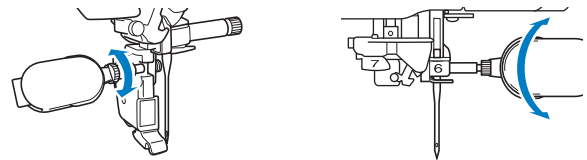

■ Position "3"

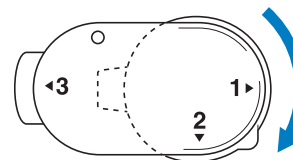

The multi-purpose screwdriver can be positioned over the screw on the embroidery frame to tighten the screw after hooping the fabric or when removing the fabric.

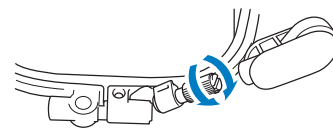

IMPORTANT

- When rotating the multi-purpose screwdriver, do not forcefully rotate it in the direction that it does not rotate; otherwise, it may break.

Assembling the Spool Stand

The included spool stand is useful when using thread spools with a large diameter (cross-wound thread). The spool stand can hold two spools of thread.

- 1 Hold in the tabs on the spool stand and remove the lid.

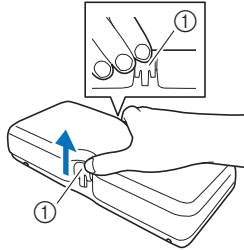

① Tabs

- 2 Raise the telescopic thread guide shaft and the two spool pins.

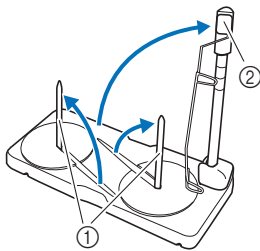

① Spool pins
② Telescopic thread guide shaft

- 3 Fully extend the telescopic thread guide shaft until the two internal stoppers snap into place.

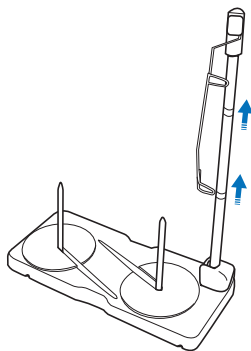

- 4 Turn the thread guide counterclockwise.

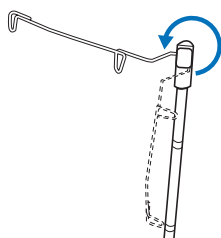

- 5 Open the upper cover of the machine, and then place the spool stand on the upper cover with the notches in the spool stand aligned with the tabs on the upper cover.

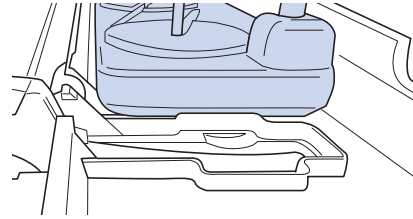

IMPORTANT

- Do not place any object weighing 1 kg (2.2 lb) or more on the top cover. Otherwise the cover may be damaged. The weight of the spool stand with its lid removed is about 280 g (0.6 lb).
- Do not lift the handle of the machine while the spool stand is installed.
- Do not push or pull the telescopic thread guide or spool pins with extreme force, otherwise damage may result.
- Do not place any object other than spools of thread on the spool support.
- Do not try to wind thread on the bobbin while sewing using the spool stand.

Note

- Make sure that the spool stand is firmly secured. Otherwise, the spool stand may fall during sewing.

Memo

- For details on winding the bobbin using the spool stand, refer to page 44.
- For details on upper threading using the spool stand, refer to page 52.

TURNING THE MACHINE ON/OFF

⚠ WARNING

- Use only regular household electricity for the power source. Using other power sources may result in fire, electric shock, or damage to the machine.
- Do not touch the plug with wet hands. Electric shock may result.
- Make sure that the plugs on the power cord are firmly inserted into the electrical outlet and the power cord receptacle on the machine. Otherwise, a fire, electric shock or malfunction may result.
- Turn the main power to OFF and remove the plug in the following circumstances to avoid a fire, electric shock or malfunction from occurring.
 - When you are away from the machine
 - After using the machine
 - When the power fails during use
 - When the machine does not operate correctly due to a bad connection or a disconnection
 - During electrical storms

⚠ CAUTION

- Use the power cord included with this machine. Otherwise, a fire or electric shock may result.
- Do not use extension cords or multi-plug adapters with many other appliances plugged in to them. Fire or electric shock may result.
- When unplugging the machine, always turn the main power to OFF first. Always grasp the plug to remove it from the outlet. Pulling on the cord may damage the cord, or lead to fire or electric shock.
- Do not allow the power cord to be cut, damaged, modified, forcefully bent, pulled, twisted, or bundled. Do not place heavy objects on the cord. Do not subject the cord to heat. These things may damage the cord, or cause fire or electric shock. If the cord or plug is damaged, take the machine to your authorized Brother dealer for repairs before continuing use.
- Do not insert the plug on the power cord into an electrical outlet that is in poor condition. A fire or electric shock may result.

- For U.S.A only
This appliance has a polarized plug (one blade wider than the other). To reduce the risk of electrical shock, this plug is intended to fit in a polarized outlet only one way. If the plug does not fit fully in the outlet, reverse the plug. If it still does not fit, contact a qualified electrician to install the proper outlet. Do not modify the plug in any way.

- 1 Insert the power supply cord into the power cord receptacle, then insert the plug into a wall outlet.

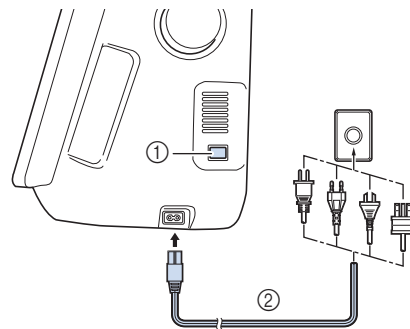

- ① Main power switch
② Power supply cord

- 2 Turn the main power switch to "1" to turn on the machine.

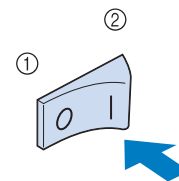

- ① OFF
② ON

📖 Memo

- When the machine is turned on, the needle and the feed dogs will make sounds when they move; this is not a malfunction.

- 3 Turn the main power switch to "O" to turn off the machine.

Setting Your Machine for the First Time

When you first turn on the machine, set the language and time/date to your language and local time/date. Follow the procedure below when the settings screen appears automatically.

- 1 Touch and to set your local language, and then touch .



- 2 The message screen, confirming if you want to set time/date, appears. Touch .

- 3 Touch or to set time/date. And then touch .

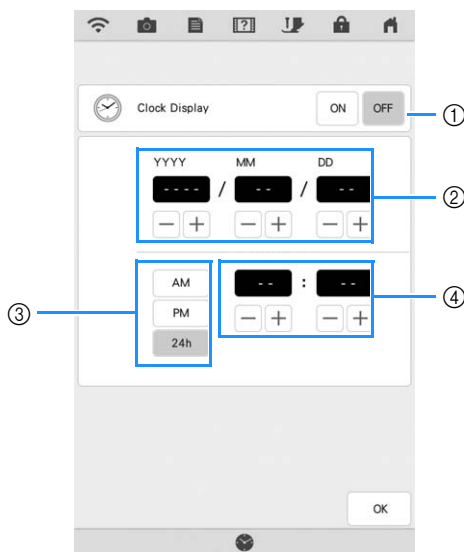

- 1 Touch to display the time on the screen.
- 2 Set the year (YYYY), month (MM) and date (DD).
- 3 Select whether 24h or 12h setting to display.
- 4 Set the current time.

→ The clock starts from 0 second of the time you set.

Memo

- The time/date you set may be cleared if you don't turn on the machine for an extended period of time.
- Time setting is also available by touching Time/Date key or Time on the LCD screen.

- 4 The following message about a wireless LAN connection appears. To set up a connection, touch , and then refer to steps 3 through 6 in "Using the Wizard to Set Up the Wireless Network Connection" on page 35 to finish setting up a wireless LAN connection.

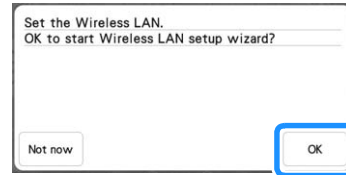

LCD SCREEN

When the machine is turned on, the opening movie is played. Touch anywhere on the screen for the home page screen to be displayed. Touch the LCD screen or a key with your finger, the included dual purpose stylus or fine tipped stylus pen to select a machine function.

IMPORTANT

- Only touch the screen with your finger, the included dual purpose stylus or fine tipped stylus pen. Do not use a sharp pencil, screwdriver, or other hard or sharp object. It is not necessary to press hard on the screen. Pressing too hard or using a sharp object may damage the screen.



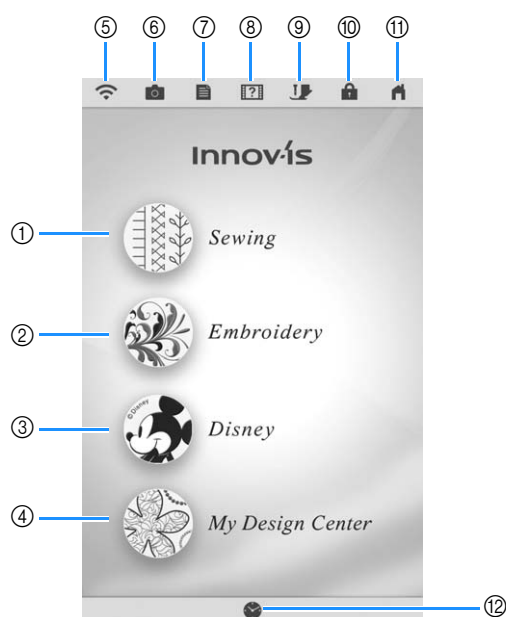

■ Home Page Screen



No.	Display	Key Name	Explanation	Page
①		Sewing key	Touch this key to sew utility stitches or character/decorative stitch patterns.	90, 146
②		Embroidery key	Attach the embroidery unit and touch this key to embroider patterns.	–
③		Disney key	Touch this key to embroider Disney patterns.	–
④		My Design Center key	Touch this key to start creating your custom design embroidery patterns.	–

No.	Display	Key Name	Explanation	Page
⑤		Wireless LAN key	Check the machine's signal strength. Touch this key to specify the wireless settings. If there is a new update file, the key appears as	34, 197
⑥		Camera view key	Touch this key to check the needle location as it is shown on the screen through the built-in camera.	79
⑦		Machine setting mode key	Touch this key to change the needle stop position, adjust the stitch patterns and embroidery patterns or screen, and change other machine settings.	20
⑧		Machine help key	Touch this key to see explanations on how to use the machine. You can see the tutorial videos and also the MP4 movie files that you have.	28
⑨		Presser foot/Needle exchange key	Touch this key before changing the needle, the presser foot, etc. This key locks all key and button functions to prevent operation of the machine.	44, 54, 57
⑩		Screen lock key	Touch this key to lock the screen. When the screen is locked, you can still sew, but cannot change any of the screen functions. Touch this key again to unlock the screen.	–
⑪		Home page screen key	Touch this key anytime it is displayed to return to the home page screen and select a different category - [Sewing], [Embroidery] or [My Design Center].	–
⑫		Time/Date key	Touch this key to set the clock to your local time.	18

Using the Machine Setting Mode Key

Touch  to change the default machine settings (needle stop position, embroidery speed, opening display, etc.). To display the different settings screens, touch  for “Sewing settings”,  for “General settings”,  for “Embroidery settings” or  for “Wireless LAN settings”.

Memo

- Touch  or  to display the previous or next page.

Sewing Settings

■ Page 1

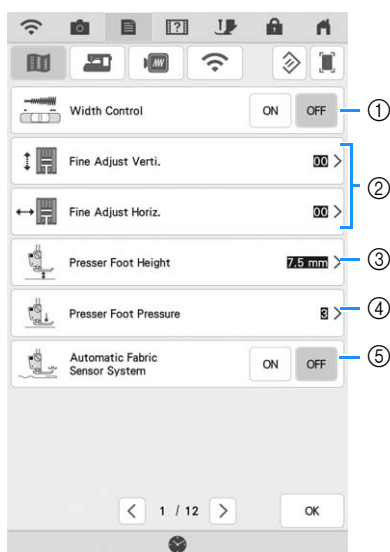

- ① Select whether to use the sewing speed controller to determine the zigzag width. (page 111)
When a straight stitch is selected, the sewing speed controller can be used to change the needle position ([L/R Shift]). (page 99)
- ② Make adjustments to character or decorative stitch patterns. (page 151)
- ③ Adjust the presser foot height. Select the height of the presser foot when the presser foot is raised.
- ④ Adjust the presser foot pressure. The higher the number, the greater the pressure will be. Set the pressure at [3] for normal sewing.
- ⑤ When set to [ON], the thickness of the fabric is automatically detected by an internal sensor while sewing. This enables the fabric to be fed smoothly. (page 70, page 78)

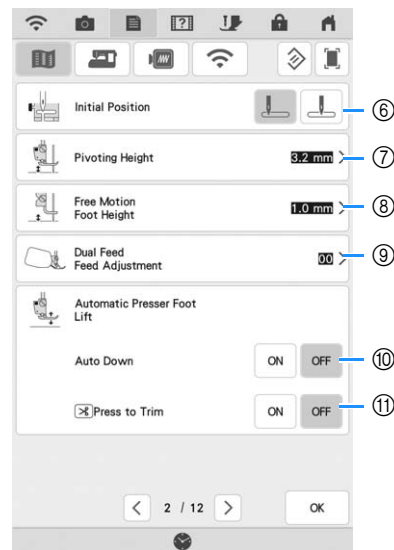

■ Page 2

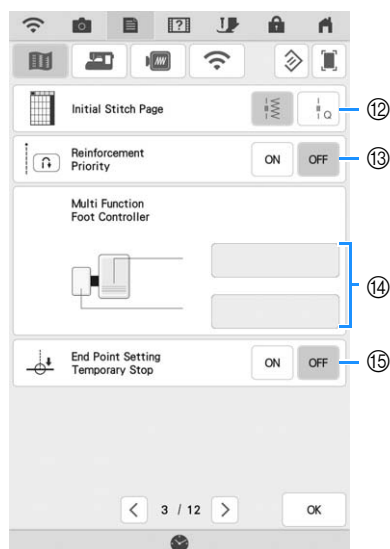

- ⑥ Select whether [1-01 Straight stitch (Left)] or [1-03 Straight stitch (Middle)] is the utility stitch that is automatically selected when the machine is turned on.
- ⑦ Change the height of the presser foot when sewing is stopped when the pivot setting is selected. (page 76)
- ⑧ Change the height of the presser foot when the machine is set to free motion sewing mode. (page 112)
- ⑨ Adjust the amount of fabric feeding of the compact dual feed foot. (page 60)
- ⑩ Pressing the “Start/Stop” button or depressing the foot controller automatically lowers the presser foot (if it is raised) before starting sewing.
- ⑪ Pressing the “Thread Cutter” button automatically lowers the presser foot before cutting the thread. The presser foot will be raised after the thread is cut.

Page 3



- ⑫ Select whether utility stitches () or quilting stitches () are displayed first in the stitch selection screen.
- ⑬ When set to [ON], reinforcement stitches are sewn at the beginning and/or end of sewing for a reinforcement stitch pattern, even when the “Reverse Stitch” button is pressed. (page 66)
- ⑭ You can activate this setting after connecting the multi-function foot controller. (These settings are not operable unless the multi-function foot controller is attached to the machine.) (page 63)
- ⑮ If this setting is set to [ON] with [End Point Setting] set to [ON] in the stitch edit menu, the machine will temporarily stop so the end point sticker can be peeled off. (page 86)

General Settings

Page 4

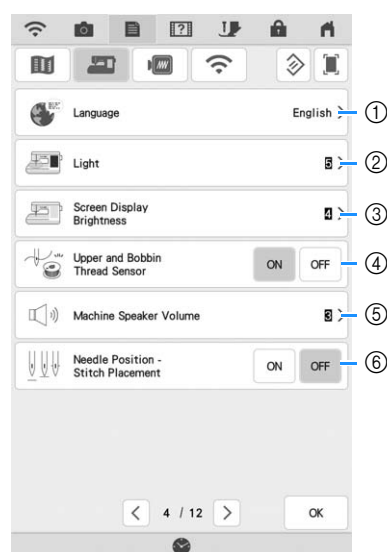

- ① Change the display language.
- ② Change the brightness of the needle area and work area lights.
- ③ If the screen is not very clear in certain environments, you can adjust the brightness of the screen.
- ④ Turn both the upper and bobbin thread sensor [ON] or [OFF]. If it is turned [OFF], the machine can be used without thread.
- ⑤ Change the speaker volume. Increase the number for louder volume, decrease for softer volume.
- ⑥ Select the operation of the [Needle Position - Stitch Placement] to [ON] or [OFF]. (page 78)

■ Page 5

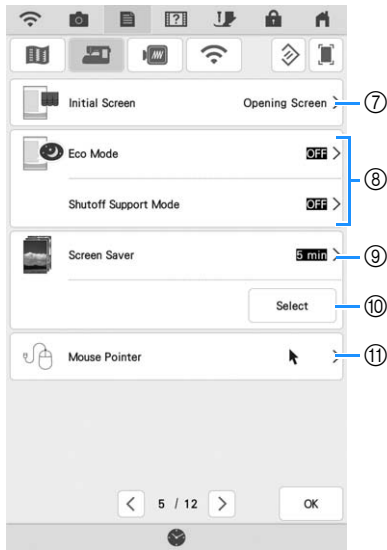

- ⑦ Select whether to display the opening screen video when the machine is turned on.
- ⑧ Select to save the machine power by setting the [Eco Mode] or the [Shutoff Support Mode]. (page 25)
- ⑨ Select the length of time until the screen saver appears.
- ⑩ Change the image of the screen saver. (page 25)
- ⑪ Change the shape of the pointer when a USB mouse is used. The setting remains selected even after the machine is turned off.

■ Page 6

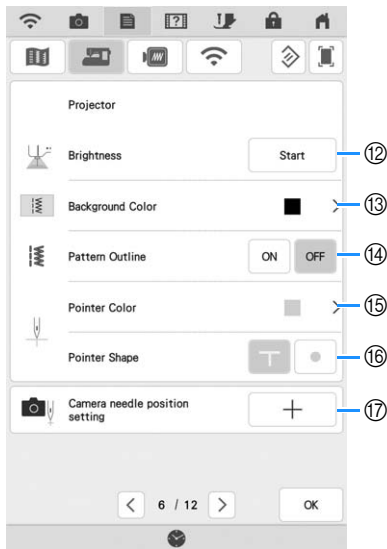

- ⑫ Select the brightness of the projector.
- ⑬ Select which background color will display when using projector function.
- ⑭ Select whether to display outline of the stitch pattern.
- ⑮ Select the color of the pointer.
- ⑯ Select a T shape or a point as the shape for the guideline marker.
- ⑰ Gauge the needle drop point to adjust the accuracy of the camera display area and of the projector projection area. (page 26)

■ Page 7

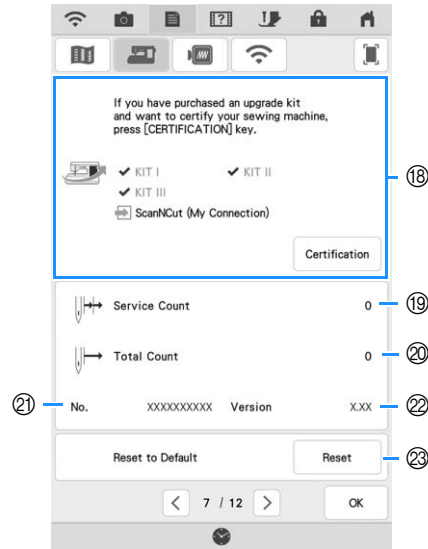

- ⑱ Use to certify your machine when you purchase one of the upgrade kits. KIT I, KIT II, and KIT III have been certified on this machine. Use to certify your machine when you use [My Connection] function with Brother cutting machine (sold separately). For details, visit the following webpage and refer to the “My Connection” Operation Manual.
<https://s.brother/cmdab/>
- ⑲ Display the service count which is a reminder to take your machine in for regular servicing. (Contact your authorized Brother dealer for details.)
- ⑳ Display the total number of stitches sewn on this machine.
- ㉑ The [No.] is the internal machine number for the machine.
- ㉒ Display the program version.
- ㉓ Erase all saved data, customized settings and network information in the machine.



Embroidery Settings

For details on embroidering settings, refer to the Operation Manual (Embroidery).

Page 8

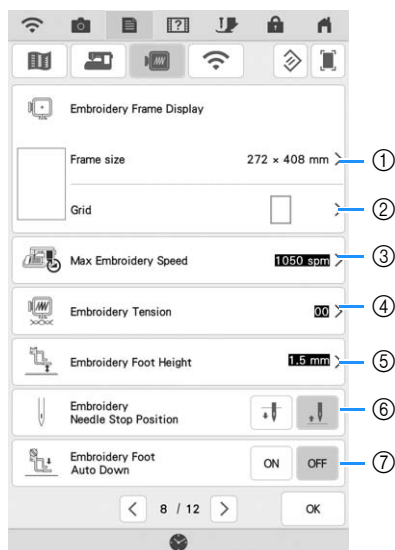

- ① Select the embroidery frame to be used.
- ② Change the center point marker or grid lines.
- ③ Adjust the maximum embroidery speed setting.
- ④ Adjust the upper thread tension for embroidering.
- ⑤ Select the height of the embroidery foot during embroidering.
- ⑥ Select the needle stop position for embroidering.
- ⑦ When set to [ON], pressing the “Start/Stop” button when the presser foot is raised automatically lowers the presser foot before starting embroidering.

Page 9

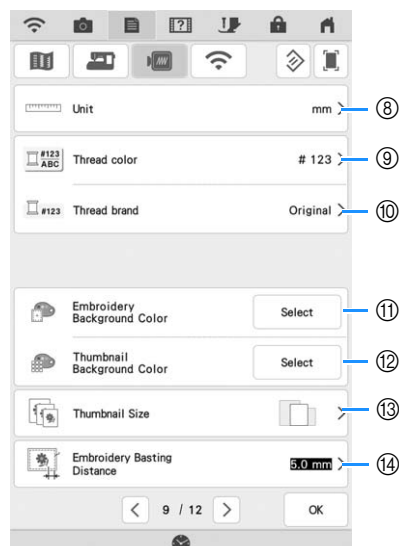

- ⑧ Change the display units (mm/inch).
- ⑨ Change the thread color display on the [Embroidery] screen: thread number or color name.
- ⑩ Select the thread brand of the thread color display. The thread brand setting is reflected the next time a pattern is imported.
- ⑪ Change the color of the background for the embroidery display area.
- ⑫ Change the color of the background for the thumbnail area.
- ⑬ Touch to specify the size of pattern thumbnails.
- ⑭ Adjust the distance between the pattern and the basting stitching.

Page 10

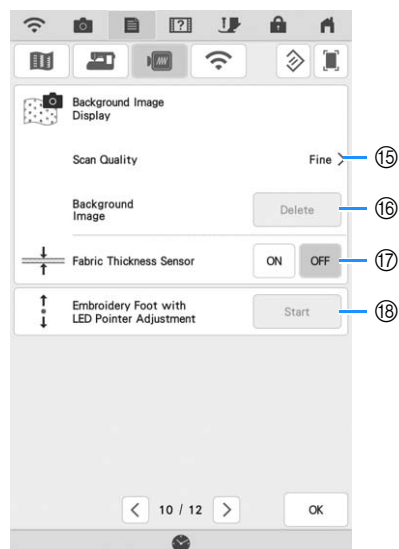

- ⑮ Select the quality for displaying the fabric in the screen.
- ⑯ Erase the scanned image.
- ⑰ When set to [ON], the built-in camera adjusts the display of the background image according to the thickness of the fabric.
- ⑱ Adjust the position and brightness of the embroidery foot “W+” with LED pointer (sold separately). (These settings are not available unless embroidery foot “W+” with LED pointer is installed on the machine.)

Wireless LAN settings

Page 11

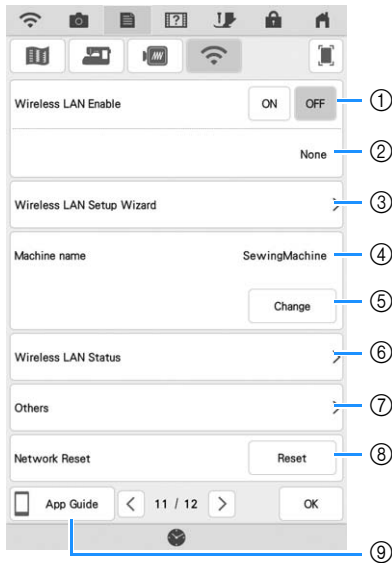

- ① Enable/disable the wireless LAN function.
- ② Display the connected SSID.
- ③ Set the machine to connect wireless LAN function.
- ④ Display the machine name of wireless LAN function.
- ⑤ Touch **Change** to change the machine name of wireless LAN function.
- ⑥ Check the wireless LAN status.
- ⑦ Display other menus.
- ⑧ Touch **Reset** to reset network operations.
- ⑨ Touch the key of the app whose information you want to display. On smart devices with a QR reader app installed, scan the QR code to display a screen that shows how to install the app. For details on each app, refer to the Operation Manual (Embroidery).



My Stitch Monitor: The machine's embroidering status can be monitored from your smart device.

My Design Snap: Images saved on a smart device can be transferred to the machine so that an embroidery pattern can be created in My Design Center.

Page 12

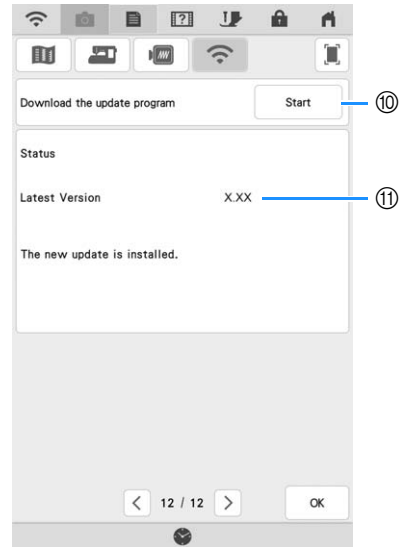

- ⑩ If there is a new program, download the update file. (page 197)
- ⑪ Display program information. (page 197)

Setting Functions

Saving a Settings Screen Image to USB Media

- 1** Insert the USB media into the USB port on the right side of the machine.

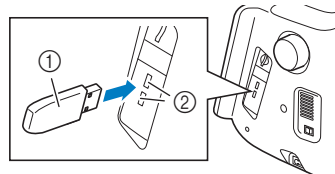

- ① USB media
- ② USB port

- 2** Touch .

→ The settings screen appears. Select the settings screen page that you want to save the screen image of.

- 3** Touch .

→ The image file will be saved in a folder labeled [bPocket].

■ Selecting the [Eco Mode] or [Shutoff Support Mode]

You can save the machine power by setting the [Eco Mode] and the [Shutoff Support Mode]. If you leave the machine without using for a specified period of time, the machine enters into one of these modes. Touch  to display [Eco Mode] and [Shutoff Support Mode]. (page 22)

[Eco Mode];

Machine will enter a sleep mode. Touch the screen or press the "Start/Stop" button to continue operating.

[Shutoff Support Mode];

Machine will enter the lower power mode after set period of time. Turn machine off and then back on to restart operating.

Memo

- If you turn off the machine while the machine is in the [Eco Mode] or the [Shutoff Support Mode], wait for about 5 seconds before turning on the machine again.
- For details on condition of the [Eco Mode] and [Shutoff Support Mode], refer to "SPECIFICATIONS" on page 194.

■ Changing the Screen Saver Image

Instead of the default image, you can select your own personal images for the screen saver of your machine.

Before changing the screen saver image, prepare the image on USB media.

For details on compatible image files, refer to "SPECIFICATIONS" on page 194.

1 Touch .

→ The settings screen appears.

2 Touch .

→ The General settings screen appears.

3 Display page 5 of the General settings screen.

4 Touch .

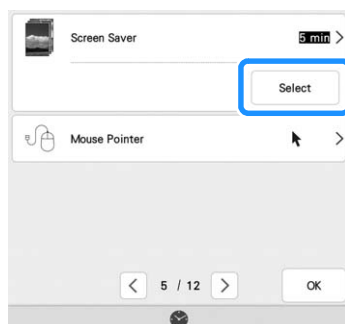



5 Touch .

6 Connect the USB media that contains your personal image to the USB port of the machine.

* Refer to page 37 about USB connectivity.

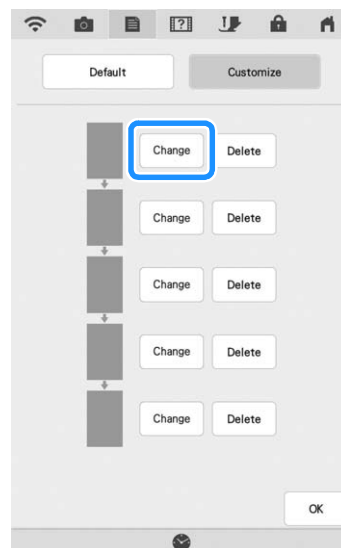
7 Touch to select the first image.



* The images will appear in a list in this screen. Select the desired  to specify the image.

* Touch  to delete the selected image.

8 Select the device that is connected.

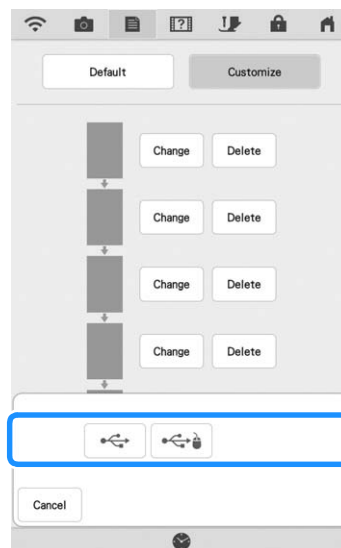

→ A list of your personal images appear on the screen.

- 9 Touch a file name to select image and then touch  .

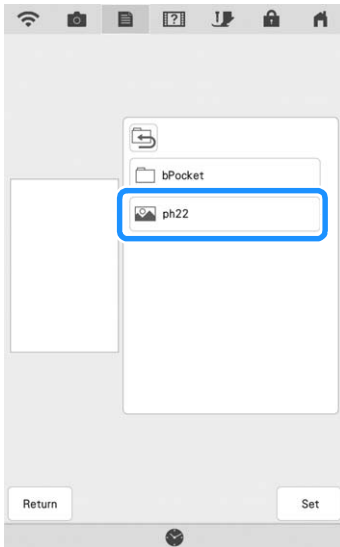

→ The selected image is stored on your machine.

- 10 Repeat the procedure from step 7 to select the remaining images.
- 11 Touch  to return to the original screen.

 **Memo**



- Touch [Default] to select default images for the screen saver.

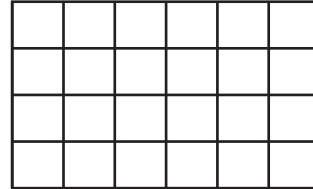

Needle Calibration Using the Built-in Camera

Setting the camera needle position is essential when you use camera or projector function. It is not necessary to perform this operation each time, but we recommend performing it when the needle is changed. Use the white calibration stickers (solid) included with the machine.



- 1 Touch  .
→ The settings screen appears.
- 2 Touch  .
→ The General settings screen appears.
- 3 Display page 6 of the General settings screen.
- 4 Touch  .

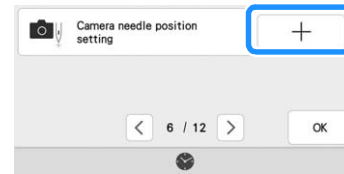

→ Camera needle position setting screen appears.

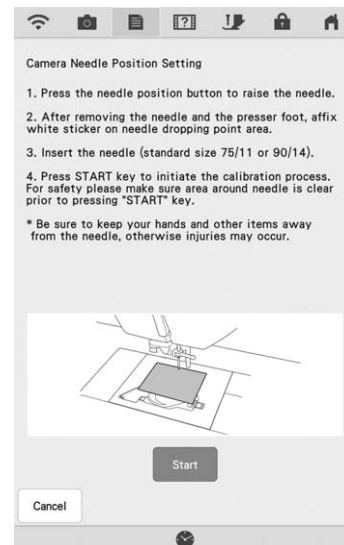

5 Follow the on-screen instructions to complete the procedure.

1. Press the needle position button to raise the needle.
2. After removing the needle and the presser foot, affix white sticker on needle dropping point area.

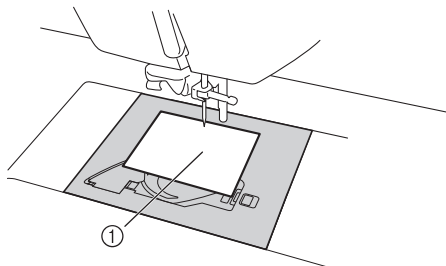

① White sticker

3. Insert the needle (standard size 75/11 or 90/14).

Note

- Use a new sticker. The camera needle position cannot be set correctly if there is a hole in sticker or if it is dirty. If you have no new stickers, contact your nearest authorized Brother dealer.

4. Touch to initiate the calibration process. For safety please make sure area around needle is clear prior to touching



→ Setting the camera needle position begins.

- ## 6 The operation is finished when [OK] appears. If [NG] appears, affix a new white sticker, and then touch . If multiple attempts to set the position are not successful, contact your nearest authorized Brother dealer.

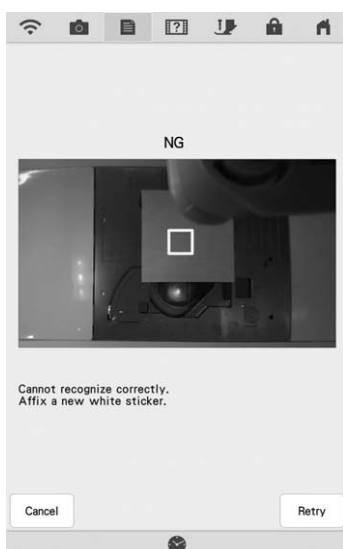

* Touch to memorize the calibration data.

* Touch to back to original screen without memorizing the calibration data.

7 Remove the sticker.

Using the Machine Help Key

Touch  to open the machine help screen. Seven functions are available from the screen shown below.

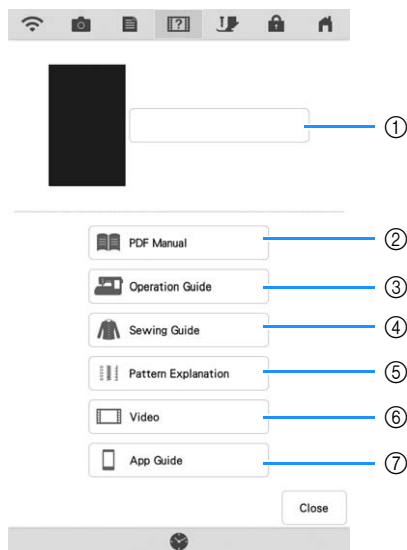

- ① Touch this key to continue viewing the Operation Manual (PDF file) or watching the video that was stopped.
- ② Touch this key to view the Operation Manual (PDF file).
- ③ Touch this key to see explanation for upper threading, winding the bobbin, changing the presser foot, preparing to embroider a pattern, and how to use the machine. (page 29)
- ④ Touch this key to select utility stitches when you are not sure which stitch to use or how to sew the stitch. (page 30)
- ⑤ Touch this key to see an explanation of the selected stitch. (page 32)
- ⑥ Touch this key to watch built-in tutorial videos or MPEG-4 (MP4) files from USB media. (page 31)
- ⑦ Touch the key of the app whose information you want to display. On smart devices with a QR reader app installed, scan the QR code to display a screen that shows how to install the app. For details on each app, refer to the Operation Manual (Embroidery).





My Stitch Monitor: The machine's embroidering status can be monitored from your smart device.

My Design Snap: Images saved on a smart device can be transferred to the machine so that an embroidery pattern can be created in My Design Center.

Using the Operation Guide Function

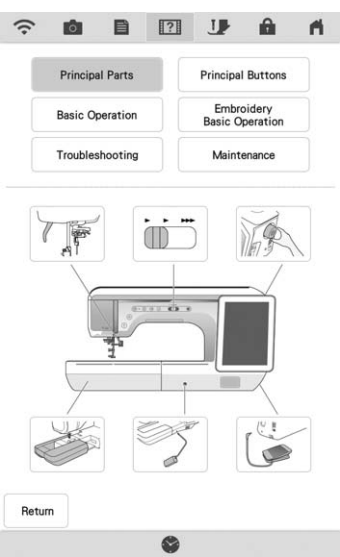
Touch  Operation Guide to open the screen shown below. Six categories are displayed at the top of the screen. Touch a key to see more information about that category.

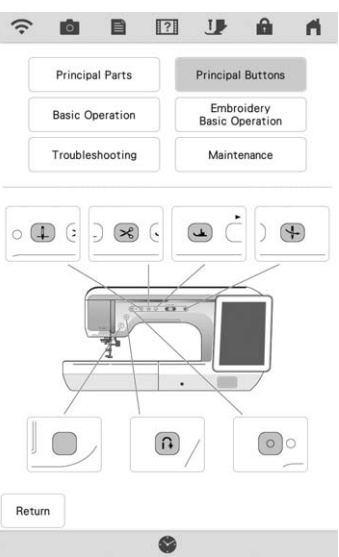
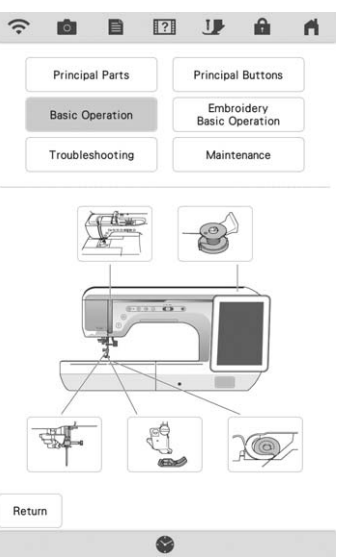
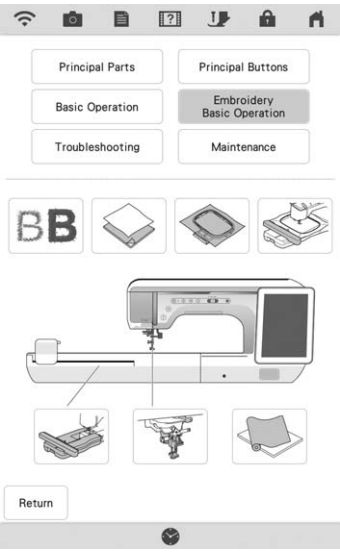
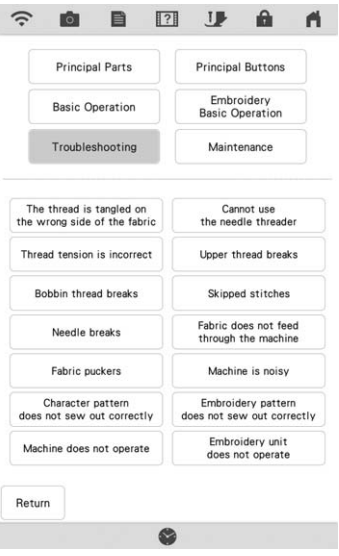
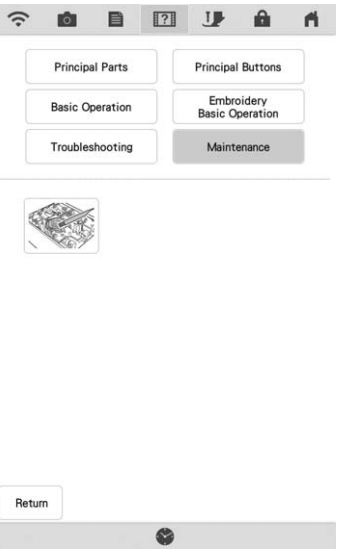
 <p>Principal Parts displays information about the main parts of the machine and their functions. This is the first screen displayed when you touch .</p>	 <p>Principal Buttons displays information about the operation buttons.</p>	 <p>Basic Operation displays information about threading the machine, changing presser feet, etc. Some of the functions are described in the videos. Watch these videos for a better understanding of the functions.</p>
 <p>Embroidery Basic Operation displays information about attaching the embroidery unit, preparing fabric for embroidering, etc. Some of the functions are described in the videos. Watch these videos for a better understanding of the functions.</p>	 <p>Troubleshooting displays troubleshooting information.</p>	 <p>Maintenance displays information about cleaning the machine, etc. Some of the functions are described in the videos. Watch these videos for a better understanding of the functions.</p>

Example: Displaying information about upper threading

1 Touch .

2 Touch  Operation Guide.

3 Touch  .

→ The lower half of the screen will change.

4 Touch  (upper threading).

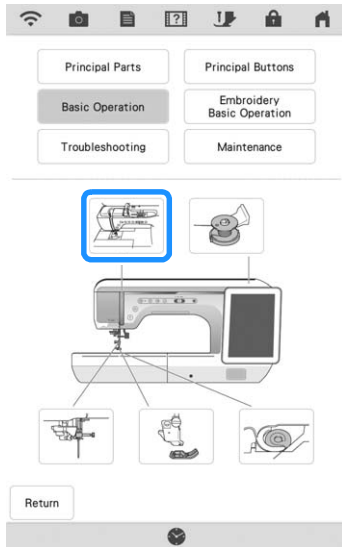

→ The screen shows instructions for threading the machine.

5 Read the instructions.

* Touch  to view the next page.

* Touch  to view the previous page.

6 Touch  to return to the original screen.

Using the Sewing Guide Function

The sewing guide function can be used to select stitch patterns from the Utility Stitch screen. Use this function when you are not sure which stitch to use for your application, or to get advice about sewing particular stitches. For example, if you want to sew overcasting, but you do not know which stitch to use or how to sew the stitch, you can use this screen to get advice. We recommend that beginners use this method to select stitches.

1 Enter Utility Stitch category from the home page.

2 Touch .

3 Touch  Sewing Guide.

4 Touch the key of the category whose sewing instructions you wish to view.

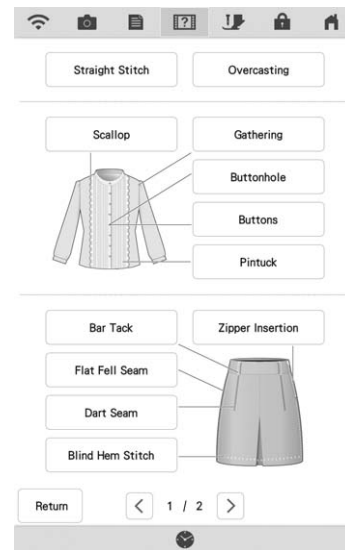

5 Read the explanations and select the appropriate stitch.



→ The screen displays directions for sewing the selected stitch. Follow the directions to sew the stitch.

Playing a Tutorial Video

This machine provides tutorial videos on how to use the machine. Together with the help guides, which offer descriptions through text and illustrations, the tutorial videos assist with machine operation.

Memo

- The specifications shown in the video may have different details than the actual product.

- Touch .
- Touch .
- Select the category and the tutorial video.







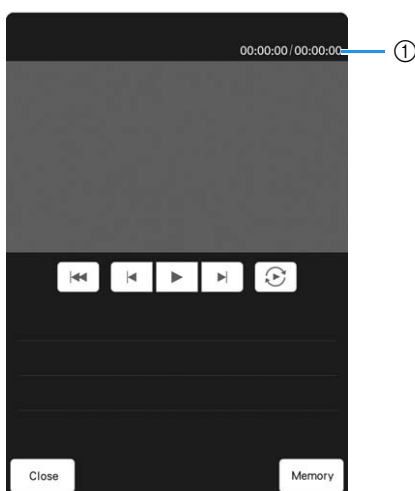



- Category
- Tutorial video

- Play the tutorial video.



- Number of seconds elapsed/Total number of seconds

Operation keys

	Play
	Pause
	Skip back 10 seconds
	Skip forward 10 seconds
	Return to beginning
	Repeat
	Delete video (when playing from the machine's memory)
	A video can be saved to machine, from where it can be played. The saved videos can be played by touching  (favorites). (page 32)

- After you are finished playing the video, touch .

Playing MPEG-4 (MP4) Videos





Your MP4 videos can be played from USB media. In addition, the MP4 video can be saved to the machine so that a tutorial video on creating a project, for example, can be viewed at any time. For details on supported file extensions, refer to "SPECIFICATIONS" on page 194.

Memo

- Some types of MP4 files cannot be viewed with the machine.

- 1 Touch .
- 2 Touch .
- 3 Select the device where the video is saved.



-  : Play a tutorial video
-  : Play a video saved on the machine (favorites)
-  : Play a video from USB media plugged into the USB port
-  : Play a video from USB media plugged into the USB port

- 4 Select the video that you want to play.

Memo



- Long video file names may be shortened when they are displayed.

- 5 Play the video.
 - * Use the operation keys as described in "Playing a Tutorial Video" on page 31.
- 6 After you are finished playing the video, touch .

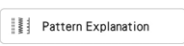

Using the Stitch Pattern Explanation Function

If you want to know more about the uses of a stitch pattern, select the stitch pattern and touch  and then  to see an explanation of the stitch selection. Descriptions are displayed for each stitch pattern in the Utility Stitch screen.

Example: Displaying information about 

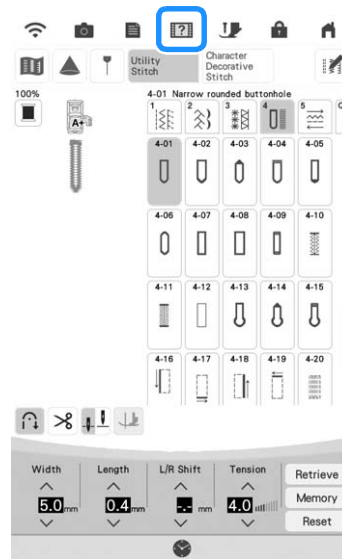
- 1 Touch .
- 2 Touch .





- 3 Touch .
 - The screen shows information.
- 4 Touch  to return to the original screen.

Memo

- The settings remain displayed to allow you to fine tune the stitch.

Viewing the Operation Manual (PDF File) on the Machine

The Operation Manual (PDF file) for this machine can be viewed on the machine.

- 1 Touch .
- 2 Touch  PDF Manual.
- 3 Select the document to be viewed.









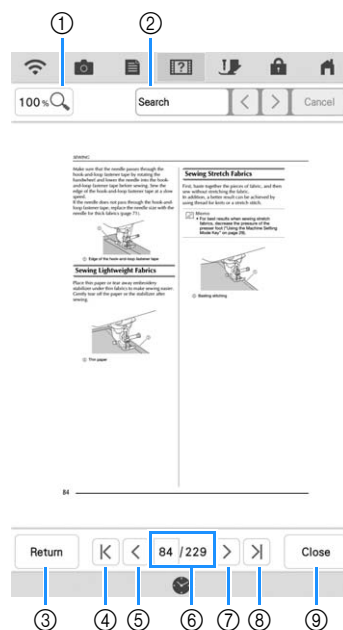

Memo

- The Operation Manual can be viewed in the currently selected display language. (Depending on the selected language, the English Operation Manual may be displayed.) For details on selecting the display language, refer to “Page 4” on page 21.

4 Read the Operation Manual.

Operation keys



①		Touch to select from 100%, 200% and 400%.
②		1. Touch to display a keyboard. 2. Enter the text to be searched for and then touch [Search]. 3. To search from the current page to the beginning of the document, touch  . To search from the current page to the end of the document, touch  .
③		Touch to return to the screen before the Operation Manual (PDF file) was opened.
④		Touch to display the first page.
⑤		Touch to display the previous page.
⑥		Shows the current page/total number of pages. Touch the current page number, and then enter a page number to display the desired page.
⑦		Touch to display the next page.
⑧		Touch to display the last page.
⑨		Touch to close the screen and exit the machine help screen.

Memo

- To zoom in or out on a page, pinch two fingers together or spread them apart. You can also move a page after zooming in by dragging it.

WIRELESS NETWORK CONNECTION FUNCTIONS

Operations Available with a Wireless Network Connection

This machine supports a wireless network connection. The following useful operations will be available if the machine is connected to a wireless network.

■ For upgrading

Directly download the update file to the machine. (page 197)



■ For embroidering

Memo

- For details on each function, refer to the Operation Manual (Embroidery).
- Conveniently check the operating status of the machine from your smart device by using the dedicated mobile application (My Stitch Monitor).

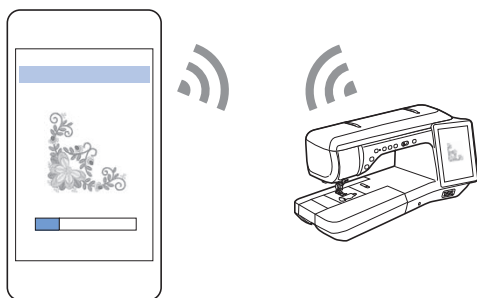

- Transfer an image from the smart device to the machine to create a design in My Design Center by using the dedicated mobile application (My Design Snap).

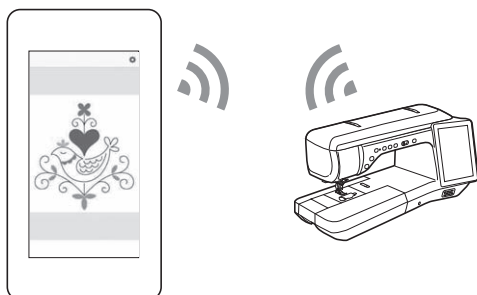

- Wirelessly transfer an embroidery pattern from your computer to the machine by using the dedicated Windows application (Design Database Transfer). The application can be downloaded from the following URL.
<https://s.brother/cadka/>
- * Settings must be specified in Design Database Transfer. For more information, refer to the manual for Design Database Transfer.

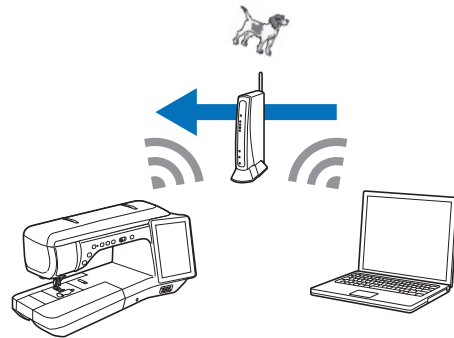

- Wirelessly transfer to the machine an embroidery pattern edited with embroidery editing software (PE-DESIGN version 11 or later) on a computer. Also, transfer to PE-DESIGN an embroidery pattern edited on the machine.
- * Settings must be specified in PE-DESIGN. For more information, refer to the manual for PE-DESIGN.

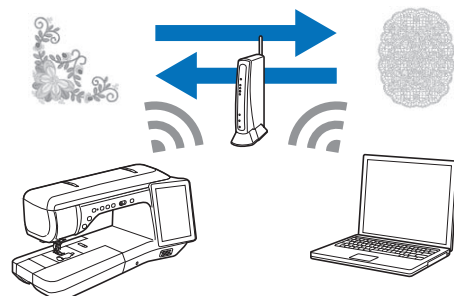

Specifying Wireless Network Connection Settings

The machine can be connected to your wireless network. For the requirements for a wireless network connection, refer to “SPECIFICATIONS” on page 194.

1 Touch



2 Set [Wireless LAN Enable] to [ON].

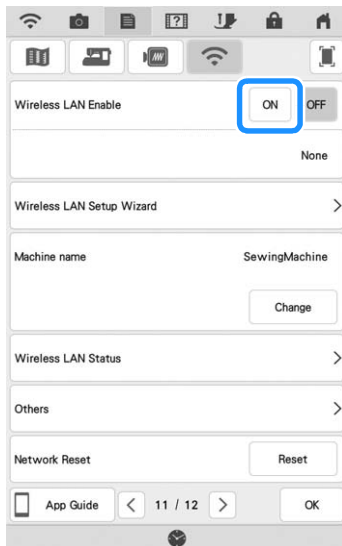

→ The machine will begin to emit the wireless network signal.

2 Touch > beside [Wireless LAN Setup Wizard].

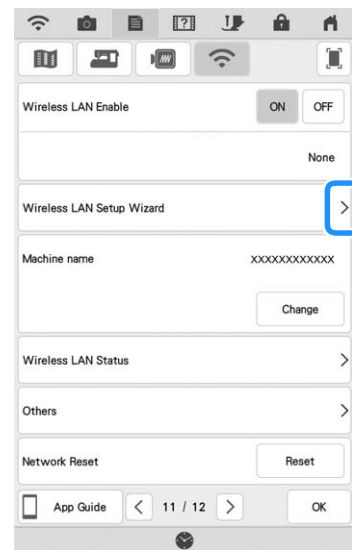

→ A list of available SSIDs appears.

Using the Wizard to Set Up the Wireless Network Connection

There are multiple ways to set up the wireless network connection. We recommend the method that uses the wizard on this machine.

1 In order to connect your machine to a wireless network, the security information (SSID and network key) for your home network will be required. The network key may also be called a password, security key or encryption key. First, find your security information and note it.

SSID	Network Key (Password)

Memo

- The wireless network connection cannot be set up if you do not have the security information.
- How to find the security information
 - ① Check the manual provided with your home network.
 - ② The default SSID may be the manufacturer's name or the model name.
 - ③ If you cannot find the security information, contact the manufacturer of the router, your network administrator or your Internet provider.
 - ④ Some SSIDs and network keys (passwords) are case (upper case and lower case) sensitive. Please properly record your information.

3 Select > beside the SSID that was noted in step 1.

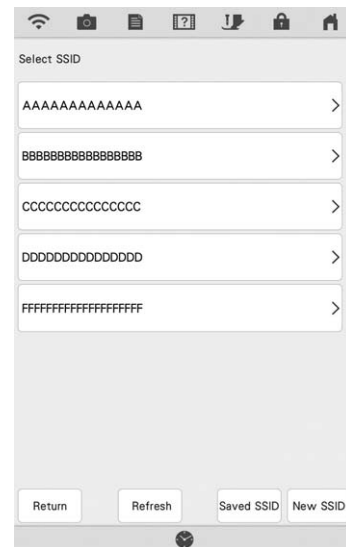

→ The screen for entering the network key (password) appears.

Memo

- If the desired network SSID does not appear in the list, touch **Refresh**.
- If the desired network SSID is not displayed, specify it as described below.
 - ① Select **New SSID**.
 - ② Enter the desired network SSID, and then touch **OK**.
 - ③ Select the authentication method and encryption mode.
- If the machine had already been connected to the home network, touch **Saved SSID**, and then select the saved SSID.

4 Enter the network key (password) that was noted, and then touch **OK**.

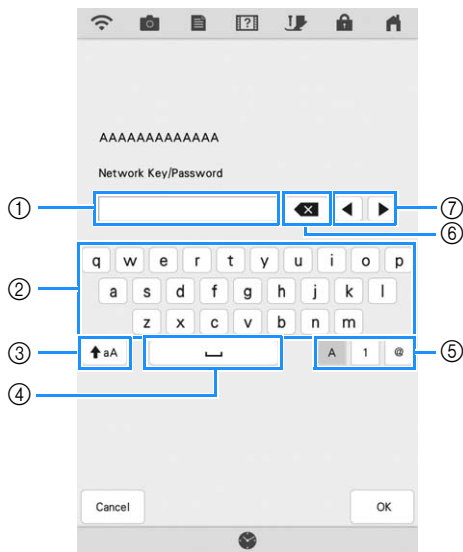

- ① Text input area
- ② Character keys
- ③ Caps key
- ④ Space key
- ⑤ Letters/numbers/symbols key
- ⑥ Backspace key (Deletes the character at the cursor's position.)
- ⑦ Cursor keys (Move the cursor to the left or right.)

5 When the following message appears, touch **OK**.



→ When a connection is established, the following message appears.

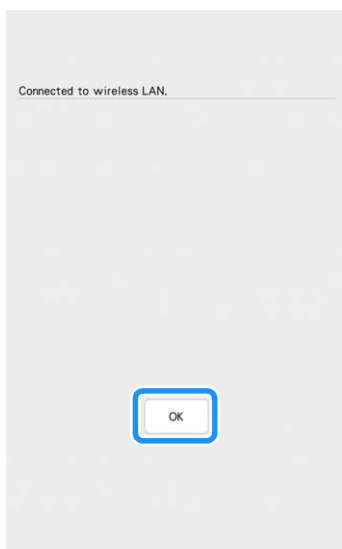

6 Touch **OK** to exit the setup.

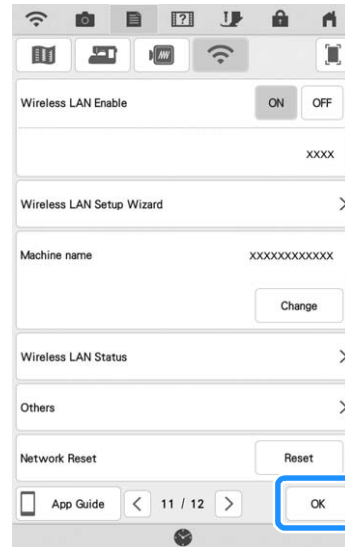

→ The name beside [Machine name] is the name that will be used when registering the machine with embroidery editing software (PE-DESIGN version 11 or later) or Design Database Transfer in order to transfer files.

Memo

- The name in the [Machine name] field will be used with the My Stitch Monitor App and My Design Snap App.
- While connected, the signal strength is indicated by the icon in the upper-left corner of the display.
- Once a wireless network connection has been set up, a wireless network connection will be established each time the machine is turned on. However, [Wireless LAN Enable] in the network settings screen must remain set to [ON].

Using the [Others] Menu

The [Others] menu contains the following items.

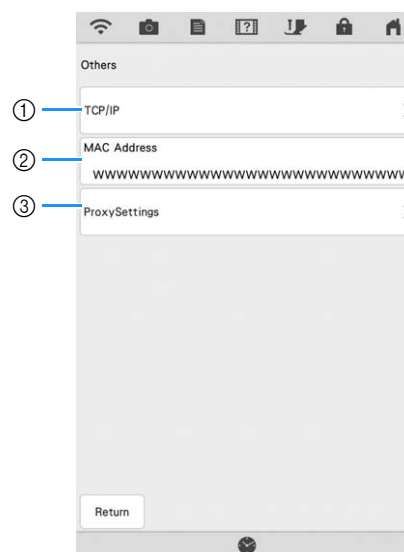

- ① TCP/IP settings can be manually entered.
- ② Shows the MAC address.
- ③ Use when proxy settings are required.

CONNECTING THE ACCESSORY TO THE MACHINE

Using USB Media/SD Card (Sold Separately)

When sending or reading stitch patterns using the USB media, connect the device to the USB port. When using SD card, insert the SD card into the SD card slot.

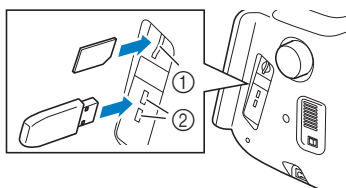

- ① SD card slot
- ② USB port

Memo

- USB media is widely used, however some USB media may not be usable with this machine. Please visit our website for more details.
- Depending on the type of USB media being used, either directly plug the USB device into the machine's USB port or plug the USB media Reader/Writer into the machine's USB port.
- Do not insert anything other than USB media into the USB port. Otherwise, the machine may be damaged.
- Do not insert anything other than SD card into the SD card slot. Otherwise, the machine may be damaged.

Using a USB Mouse

The USB mouse, connected to the machine, can be used to perform a variety of operations in the screens.

Connect a USB mouse to the USB port.

Memo

- Use a basic computer mouse to operate the machine functions. Some USB mouse devices may not be compatible with this machine.

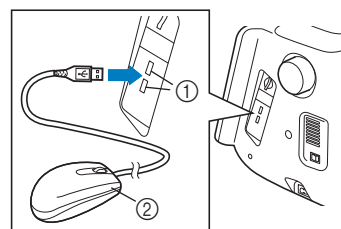

- ① USB port
- ② USB mouse

Memo

- The left mouse button can be used to perform operations such as choosing a design and choosing menu keys.
- The mouse pointer does not appear in the screen saver or opening screen.

Clicking a Key

When the mouse is connected, the pointer appears on the screen. Move the mouse to position the pointer over the desired key, and then click the left mouse button.

Memo

- Double-clicking has no effect.

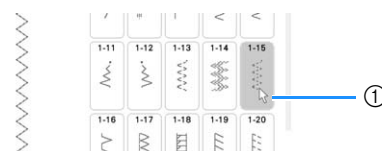

- ① Pointer

Changing Pages

If page numbers and a vertical scroll bar for additional pages are displayed, click the left mouse button with the pointer on </> or ^/↓ to display the previous or next page.





Chapter **2**
Sewing Basics

LOWER THREADING

Winding the Bobbin

IMPORTANT

- Use the plastic bobbins that came with this machine or bobbins of the same type: 11.5 mm (approx. 7/16 inch) plastic Class 15 (A style) bobbins, which are available from your Brother dealer.

Using the Supplemental Spool Pin

With this machine, you can wind the bobbin during sewing. While the main spool pin is being used for sewing, you can wind a bobbin by using the supplemental spool pin.

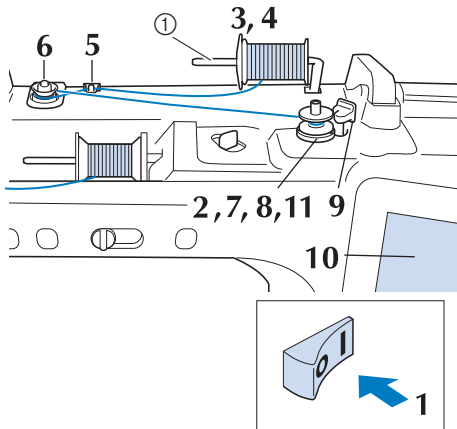

① Supplemental spool pin

- 1 Turn the main power to ON and open the top cover.
- 2 Align the groove in the bobbin with the spring on the bobbin winder shaft, and set the bobbin on the shaft.

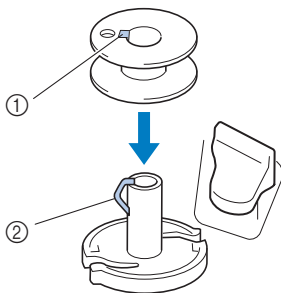

① Groove in the bobbin
② Spring on the shaft

- 3 Set the supplemental spool pin in the “up” position.

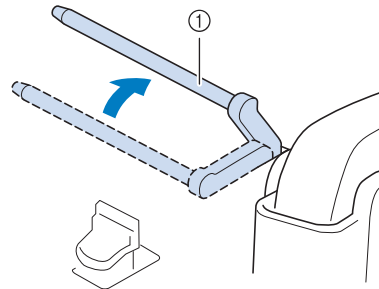

① Supplemental spool pin

- 4 Place the spool of thread on the supplemental spool pin, so that thread unrolls from the front. Push the spool cap onto the spool pin as far as possible to secure the thread spool.

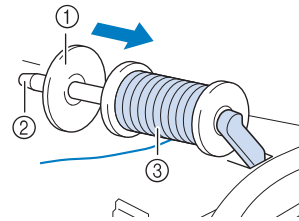

① Spool cap
② Spool pin
③ Thread spool

IMPORTANT

- If the spool or the spool cap is not installed correctly, the thread may become tangled around the spool pin and the machine may be damaged.
- Three spool cap sizes are available, allowing you to choose a spool cap that best fits the size of spool being used. If the spool cap is too small for the spool being used, the thread may catch on the slit in the spool or the machine may be damaged. When using mini king thread spool, use the thread spool insert. For details on thread spool insert (mini king thread spool), refer to “Note” on page 41.



Note

- When using the spool as shown below, use the thread spool insert (mini king thread spool). Make sure that the thread spool insert is firmly inserted. After installing it, pull out some thread, and check that the thread unwinds without getting caught.

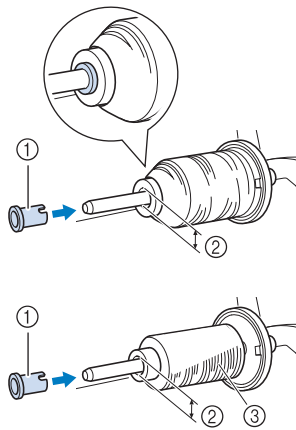

- ① Thread spool insert (mini king thread spool)
- ② Hole diameter 8.0 mm to 10.5 mm (5/16 inch to 13/32 inch)
- ③ Spool (cross-wound thread)

- When using thread that winds off quickly, such as transparent nylon thread or metallic thread, place the spool net over the spool before placing the spool of thread onto the spool pin. If the spool net is too long, fold it to fit the size of the spool.

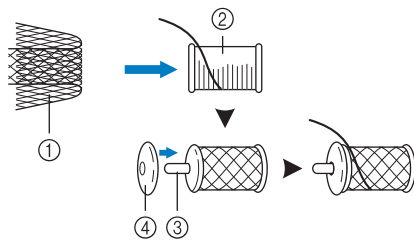

- ① Spool net
- ② Thread spool
- ③ Spool pin
- ④ Spool cap

- * When threading the spool with the spool net on, make sure that 5-6cm (approx. 2 - 2-1/2 inches) of thread is pulled out.
- * It may be necessary to adjust the thread tension when using the spool net.

- 5** With your right hand, hold the thread near the thread spool. With your left hand, hold the end of the thread, and use both hands to pass the thread through the thread guide.

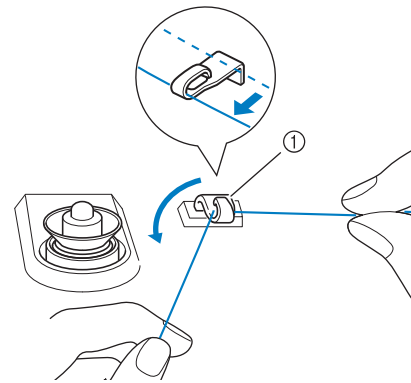

① Thread guide

- 6** Pass the thread around the pretension disk making sure that the thread is under the pretension disk.

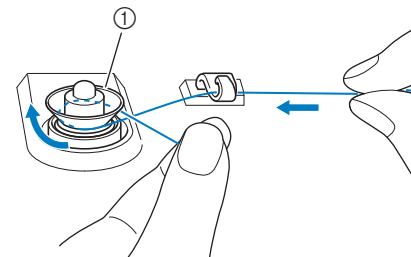

① Pretension disk
→ Make sure that the thread passes under the pretension disk.

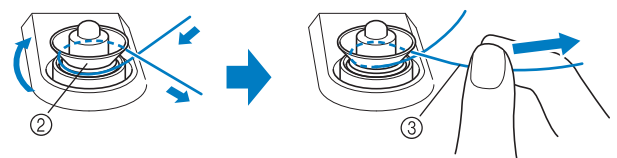

② Pretension disk
③ Pull it in as far as possible.
→ Check to make sure thread is securely set between pretension disks.

- 7** Wind the thread clockwise around the bobbin 5-6 times.

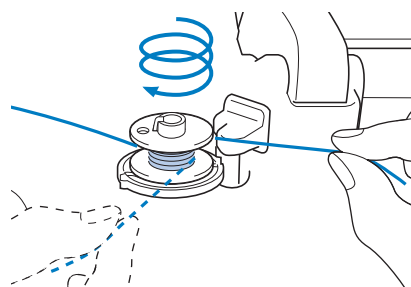

- 8** Pass the end of the thread through the guide slit in the bobbin winder seat, and pull the thread to the right to cut the thread with the cutter.

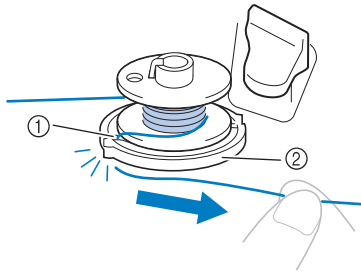

- ① Guide slit (with built-in cutter)
- ② Bobbin winder seat

⚠ CAUTION

- Be sure to follow the process described. Winding the bobbin without cutting the thread with the cutter may cause the bobbin to be wound incorrectly. In addition, the thread may become tangled around the bobbin when the bobbin thread starts to run out, possibly causing the needle to break, resulting in injuries.

- 9** Set the bobbin winding switch to the left, until it clicks into place.

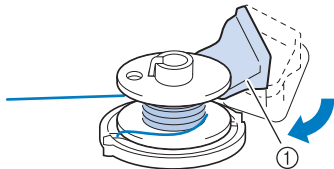

- ① Bobbin winding switch

📖 Memo

- Use the bobbin winding slider to adjust the amount of thread wound onto the bobbin to one of five levels.

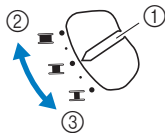

- ① Bobbin winding slider
- ② More
- ③ Less

→ The bobbin winding window appears.

- 10** Touch **Start**.

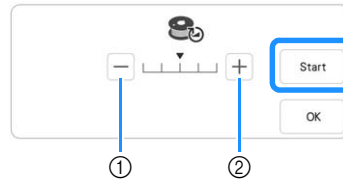

- ① Touch to decrease the winding speed.
- ② Touch to increase the winding speed.

→ Bobbin winding starts. **Start** changes to **Stop** while the bobbin is winding. The bobbin stops rotating when bobbin winding is completed. The bobbin winding switch will automatically return to its original position.

📖 Memo

- Stay near the machine while winding the bobbin to make sure the bobbin thread is being wound correctly. If the bobbin thread is wound incorrectly, touch **Stop**.
- Touch **OK** to minimize the bobbin winding window. Then, you can perform other operations, such as selecting a stitch or adjusting the thread tension, while the bobbin is being wound.
- Touch  (in top right of the LCD screen) to display the bobbin winding window again.



- The sound of winding the bobbin with stiff thread, such as nylon thread for quilting, may be different from the one produced when winding normal thread; however, this is not a sign of a malfunction.

IMPORTANT

- When winding transparent nylon thread on the bobbin, stop bobbin winding when the bobbin is 1/2 to 2/3 full. If the bobbin was fully wound with transparent nylon thread, it may not be wound neatly, or sewing performance may suffer. In addition, extreme pressure may be applied to the bobbin, it may not be possible to remove the bobbin from the bobbin winder shaft, or the bobbin may break.

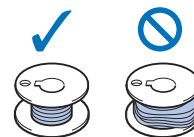

- After bobbin winding is finished, cut the thread and remove the bobbin.

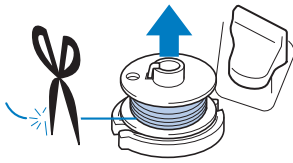

IMPORTANT

- When removing the bobbin, do not pull on the bobbin winder seat. Doing so could loosen or remove the bobbin winder seat, and could result in damage to the machine.

■ If the Thread Becomes Tangled Under the Bobbin Winder Seat

Refer to "If the Thread Becomes Tangled Under the Bobbin Winder Seat" on page 185.

■ Using the Spool Pin

You can use the main spool pin to wind the bobbin before sewing. You cannot use this spool pin to wind the bobbin while sewing.

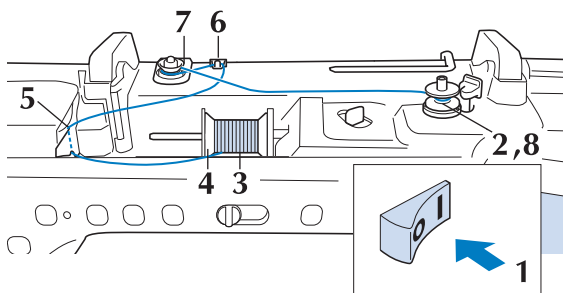

- Turn the main power to ON and open the top cover.
- Align the groove in the bobbin with the spring on the bobbin winder shaft, and set the bobbin on the shaft.

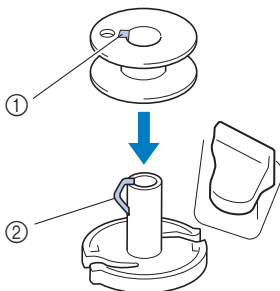

- Groove in the bobbin
- Spring on the shaft

- Pivot the spool pin so that it angles upward. Set the thread spool on the spool pin so that the thread unwinds from the front of the spool.

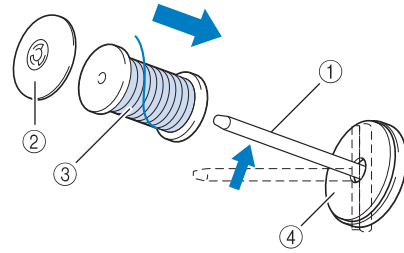

- Spool pin
- Spool cap
- Thread spool
- Spool felt

- Push the spool cap onto the spool pin as far as possible, then return the spool pin to its original position.
- While holding the thread with both hands, pull the thread up from under the thread guide plate.

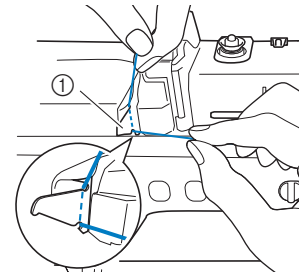

- Thread guide plate

- Pass the thread through the thread guide.

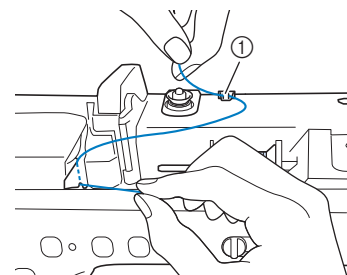

- Thread guide

- 7 Pass the thread around the pretension disk making sure that the thread is under the pretension disk.

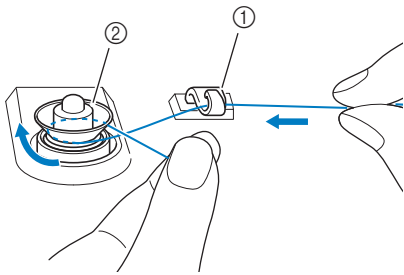

- ① Thread guide
- ② Pretension disk

- 8 Follow steps 7 through 11 on page 41 through 43.

Using the Spool Stand

To wind thread on the bobbin while the spool stand is installed, pass the thread from the spool through the thread guide on the telescopic thread guide, and then wind the bobbin according to steps 5 through 11 of "Using the Supplemental Spool Pin" on page 41 to page 43.

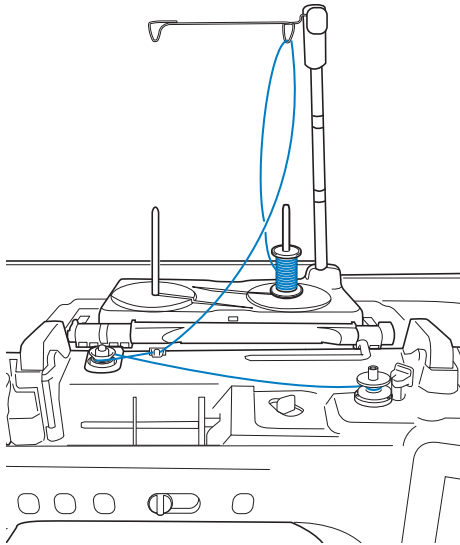

Memo

- Refer to page 16 to assemble the spool stand.
- Refer to page 52 to thread the machine using the spool stand.

IMPORTANT

- When winding thread on the bobbin, do not cross the bobbin winding thread with the upper thread in the thread guides.

Setting the Bobbin

Follow the steps below to install the bobbin with thread.

CAUTION

- Use a bobbin thread that has been correctly wound. Otherwise, the thread tension may be incorrect and the needle may break, causing injuries.

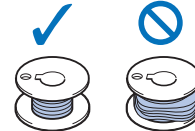

- Before inserting or changing the bobbin, be sure to touch  in the LCD to lock all keys and buttons, otherwise injuries may occur if the "Start/Stop" button or any other button is pressed and the machine starts sewing.

- 1 Touch  to lock all keys and buttons and raise the presser foot.

* If the message [OK to automatically lower the presser foot?] appears on the LCD screen, touch  to continue.

- 2 Slide the bobbin cover latch to the right.

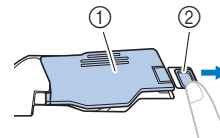

- ① Bobbin cover
- ② Latch
- The bobbin cover opens.

- 3 Remove the bobbin cover.

- 4 Hold the bobbin with your right hand and hold the end of the thread with your left hand.

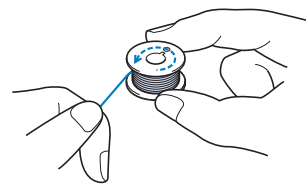

- 5** Set the bobbin in the bobbin case so that the thread unwinds to the left.

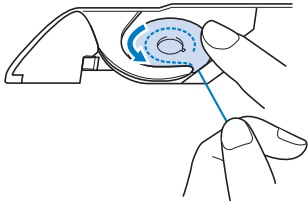

Note

- Be sure to hold down the bobbin with your finger and unwind the bobbin thread correctly. Otherwise, the thread may break or the thread tension will be incorrect.

- 6** Lightly hold down the bobbin with your right hand, and then guide the end of the thread around the tab of the needle plate with your left hand.

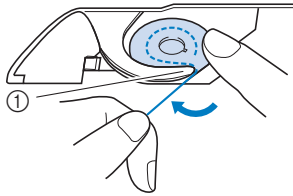

① Tab

- 7** While lightly holding down the bobbin with your right hand, guide the thread through the slit in the needle plate and lightly pull it with your left hand.

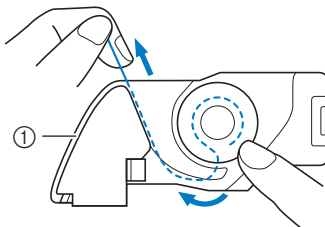

① Slit

Memo

- By pulling the thread as shown in step **7**, the thread will enter the tension spring of the bobbin case to apply the appropriate tension to the bobbin thread during sewing.

- 8** While lightly holding down the bobbin with your right hand, continue guiding the thread through the slit with your left hand. Then, cut the thread with the cutter.

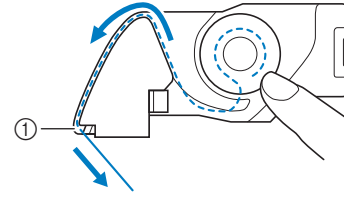

① Cutter

→ The cutter cuts the thread.

- 9** Insert the tab in the lower-left corner of the bobbin cover (1), and then lightly press down on the right side to close the cover (2).

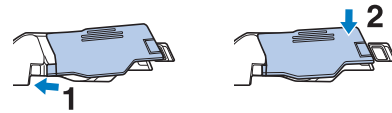

- 10** Touch  to unlock all keys and buttons.

Memo

- You can begin sewing without pulling up the bobbin thread. If you wish to pull up the bobbin thread before starting to sew, pull up the thread according to the procedure in “Pulling Up the Bobbin Thread” on page 46.

Pulling Up the Bobbin Thread

There may be some sewing applications where you want to pull up the bobbin thread; for example, when making gathers, darts, or doing free motion quilting or embroidery.

Memo

- You can pull up the bobbin thread after threading the upper thread ("UPPER THREADING" on page 47).

1 Follow steps **1** to **4** in "Setting the Bobbin" on page 44 for installing the bobbin into the bobbin case.

2 Guide the bobbin thread through the groove, following the arrow in the illustration.

- * Do not cut the thread with the cutter.
- * Do not replace the bobbin cover.

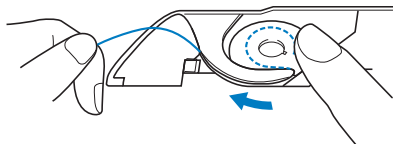

3 Touch  to unlock all keys and buttons.

4 While holding the upper thread, press the "Needle Position" button to lower the needle.

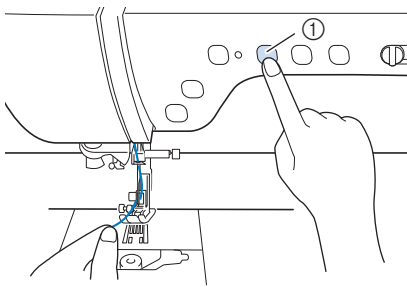

① "Needle Position" button

5 Press the "Needle Position" button to raise the needle.

6 Gently pull the upper thread. A loop of the bobbin thread will come out of the hole in the needle plate.

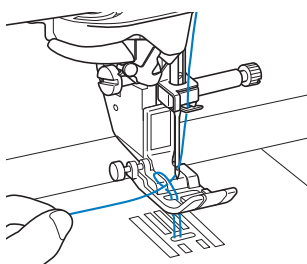

7 Pull up the bobbin thread, pass it under the presser foot and pull it about 10 cm (approx. 3-4 inches) toward the back of the machine, making it even with the upper thread.

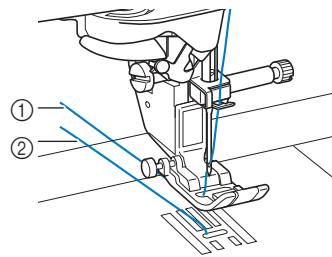

① Upper thread
② Bobbin thread

8 Replace the bobbin cover.

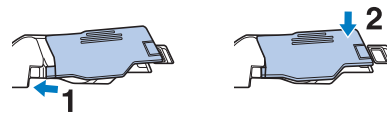

UPPER THREADING

Upper Threading

⚠ CAUTION

- Be sure to thread the machine properly. Improper threading can cause the thread to tangle and break the needle, leading to injury.

IMPORTANT

- Never use a thread weight of 20 or lower. It may cause the machine to malfunction. Use the needle and the thread in the correct combination. For details on the correct combination of needles and threads, refer to "Fabric/Thread/Needle Combinations" on page 56.

📖 Memo

- The automatic threading function can be used with home sewing machine needle sizes 75/11 through 100/16.
- When threads such as transparent nylon monofilament or specialty threads are used, it is not recommended to use the needle threader.
- The automatic threading function cannot be used with the twin needle.

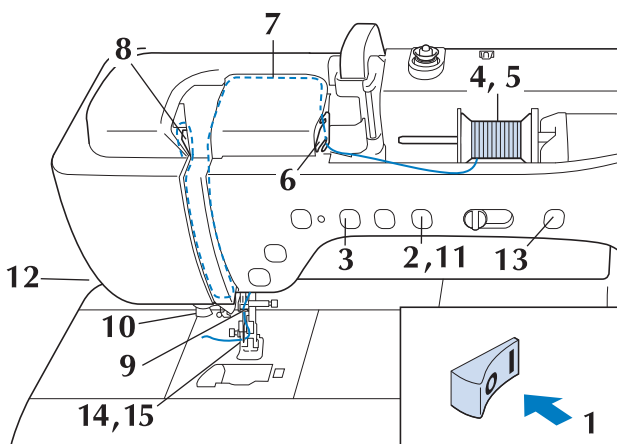

- 1 Turn the main power to ON.

- 2 Press the "Presser Foot Lifter" button to raise the presser foot.

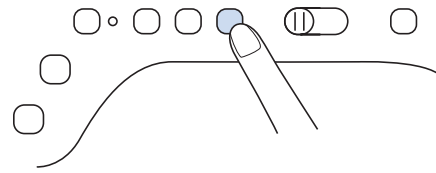

→ The upper thread shutter opens so the machine can be threaded.

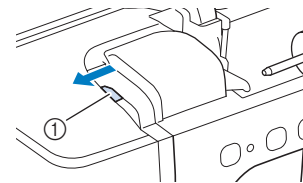

① Upper thread shutter

- 3 Press the "Needle Position" button to raise the needle.

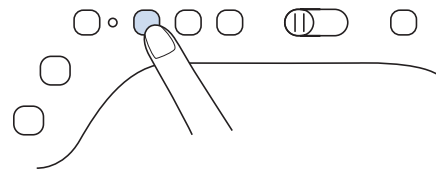

IMPORTANT

- Be sure to raise the needle before using the automatic needle threader. Otherwise, the needle may not thread correctly and the needle threader may be damaged.

- 4 Pivot the spool pin so that it angles upward. Set the thread spool on the spool pin so that the thread unwinds from the front of the spool.

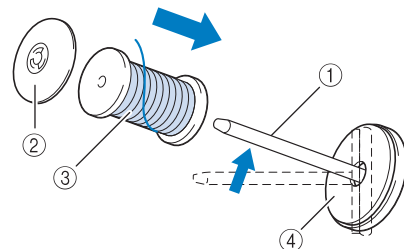

- ① Spool pin
- ② Spool cap
- ③ Thread spool
- ④ Spool felt

- 5 Push the spool cap onto the spool pin as far as possible, then return the spool pin to its original position.

CAUTION

- Choose a spool cap that best fits the size of spool being used. For more information regarding the choice of spool caps for your thread choice, refer to "Note" on page 41.

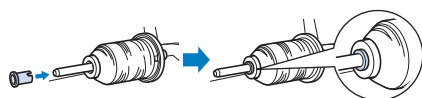

If the spool or the spool cap is not positioned correctly, the thread may become tangled around the spool pin, possibly causing the needle to break, resulting in injuries.

- 6 While holding the thread with both hands, pull the thread up from under the thread guide plate.

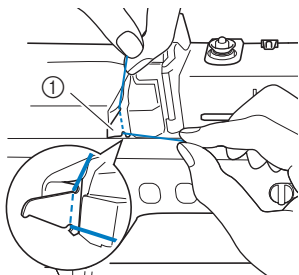

① Thread guide plate

- 7 While holding the thread in your right hand, pass the thread through the thread guide in the direction indicated.

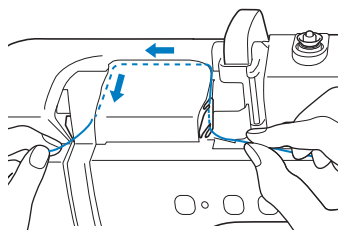

- 8 Guide the thread down, up, then down through the groove, as shown in the illustration.

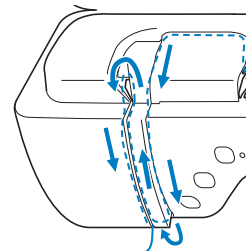

Memo

- Look in the upper groove area to check if the thread catches on the thread take-up lever visible inside the upper groove area.

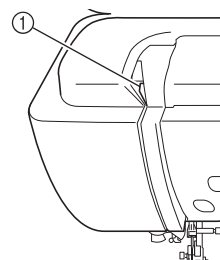

① Look in the upper groove area

- 9 Pass the thread through the needle bar thread guide (marked "6") by holding the thread with both hands and guiding it as shown in the illustration.

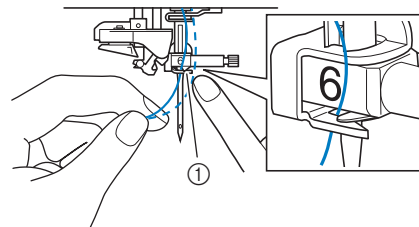

① Needle bar thread guide

- 10 Pass the thread through the thread guide disks (marked "7"). Make sure that the thread passes through the groove in the thread guide.

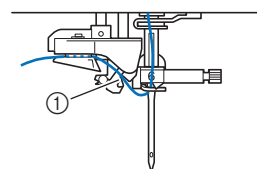

① Groove in thread guide

- 11** Press the “Presser Foot Lifter” button to lower presser foot.

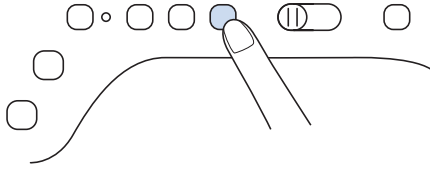

- 12** Pull the thread up through the thread cutter to cut the thread, as shown in the illustration.

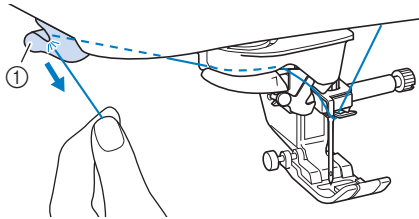

① Thread cutter

Note

- When using thread that quickly winds off the spool, such as metallic thread, it may be difficult to thread the needle if the thread is cut.

Therefore, instead of using the thread cutter, pull out about 8 cm (approx. 3 inches) of thread after passing it through the thread guide disks (marked “7”).

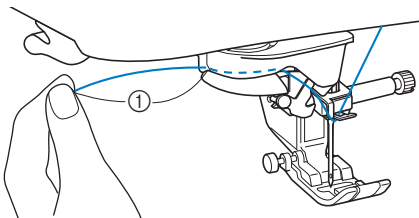

① 8 cm (approx. 3 inches) or more

- 13** Press the “Automatic Threading” button to have the machine automatically thread the needle.

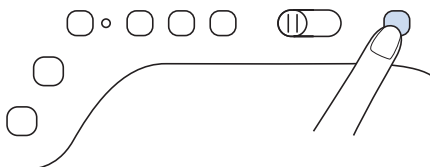

→ The thread passes through the eye of the needle.

Memo

- When the “Automatic Threading” button is pressed, the presser foot will be automatically lowered. After threading is finished, the presser foot moves back to the position before the “Automatic Threading” button was pressed.

- 14** Carefully pull the end of the thread that was passed through the eye of the needle.

- * If a loop was formed when the thread passed through the eye of the needle, carefully pull the loop of thread through the eye to the back of the needle.

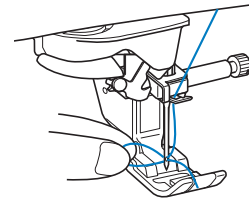

- 15** Pull out about 10 cm (approx. 4 inches) of the thread, and then pass it under the presser foot toward the rear of the machine.

- Raise the presser foot lever if the presser foot is lowered.

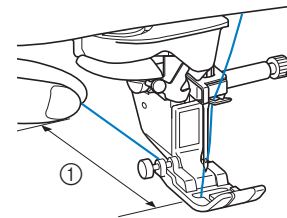

① About 10 cm (approx. 4 inches)

Memo

- If the needle could not be threaded or the thread was not passed through the needle bar thread guides, perform the procedure again starting from step 3.

Note

- Some needles cannot be threaded with the needle threader. In this case, instead of using the needle threader after passing the thread through the needle bar thread guide (marked “6”), manually pass the thread through the eye of the needle from the front.

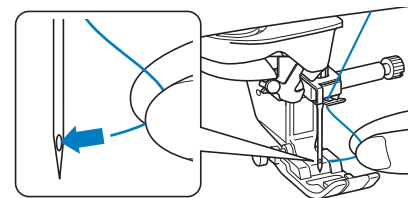

Using the Twin Needle Mode

The twin needle can only be used for stitch patterns that show  after being selected. Before you select a stitch pattern, make sure the stitch can be sewn in the twin needle mode (refer to the "STITCH SETTING CHART" on page 198).

CAUTION

- When using the twin needle, it is recommended to use presser foot "J". Otherwise, the needle may break and cause injury.
- Before changing the needle or threading the machine, be sure to touch  on the LCD Screen to lock all keys and buttons, otherwise injuries may occur if the "Start/Stop" button or any other button is pressed and the machine starts sewing.

IMPORTANT

- Twin needle (size 2/11) is recommended for this machine. Contact your authorized Brother dealer for replacement needles.

Note

- When the twin needle is used, bunched stitches may occur depending on the types of fabric and thread that are used. Use advanced monogramming foot "N+" or attach stabilizer material.

- 1 Touch  to lock all keys and buttons and then install the twin needle ("CHANGING THE NEEDLE" on page 54).

* If the message [OK to automatically lower the presser foot?] appears on the LCD screen, touch

to continue.

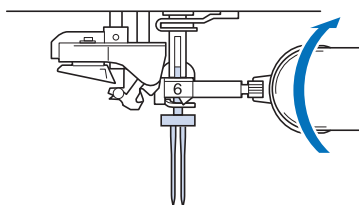

- 2 Thread the machine for the first needle according to the procedure for threading a single needle (the steps 1 to 8 of "Upper Threading" on page 47).

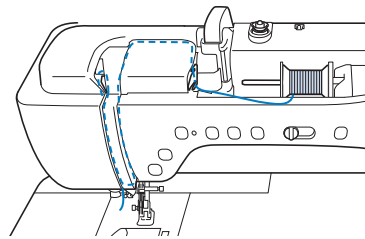

- 3 Pass the thread through the needle bar thread guide on the needle bar, then thread the needle on the left side manually.

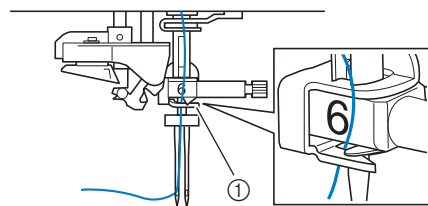

① Needle bar thread guide

IMPORTANT

- The "Automatic Threading" button cannot be used. Manually thread the twin needle from front to back. Using the "Automatic Threading" button may result in damage to the machine.

- 4 Pull up the supplemental spool pin and set it in the up position.

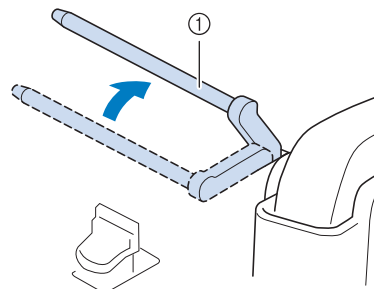

① Supplemental spool pin

5 Place the additional spool of thread on the supplemental spool pin, so that the thread unwinds from the front. Push the spool cap onto the spool pin as far as possible to secure the thread spool.

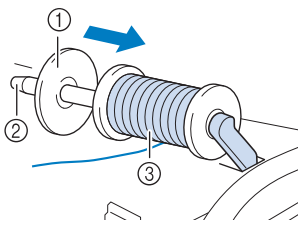

- ① Spool cap
- ② Spool pin
- ③ Thread spool

6 Hold the thread from the spool with both hands, and place the thread in the thread guide.

* Do not place the thread in the pretension disks.

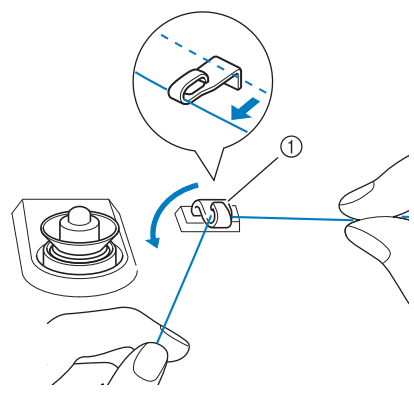

- ① Thread guide

7 Thread the machine according to the steps 6 to 8 of "Upper Threading" on page 47.

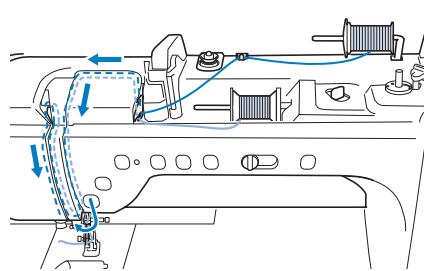

8 Continue threading; however, do not pass the thread in the needle bar thread guide "6" on the needle bar. Thread the needle on the right side manually.

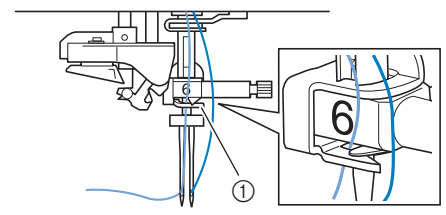



- ① Needle bar thread guide

9 Touch  to unlock all keys and buttons.

10 Select a stitch pattern.

- * Refer to "Sewing a Stitch" on page 62 for selecting the stitch.
 - * Refer to the "STITCH SETTING CHART" on page 198 for stitch patterns that can use a twin needle.
- The selected stitch is displayed.

11 Touch , and then touch  to select the twin needle mode.

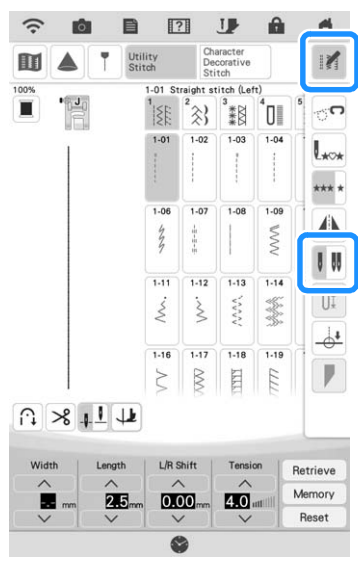

→ Twin needle mode is set.

Memo

- If the  key is light gray after selecting the stitch, the selected stitch cannot be sewn in the twin needle mode.

⚠ CAUTION

- Be sure to set the twin needle mode when using the twin needle. Using the twin needle while the machine is in single needle mode could cause the needle to break and cause injury.

12 Start sewing.

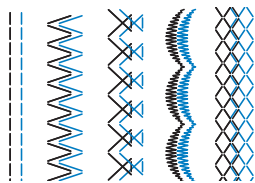

Memo

- To change direction when sewing with the twin needle, raise the needle from the fabric, raise the presser foot lever, and then turn the fabric.

Using the Spool Stand

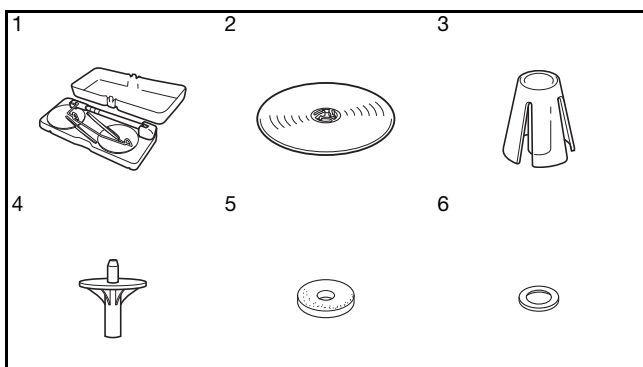

No.	Part Name
1	Spool stand
2	Spool cap (XL) × 2
3	Spool holder × 2
4	Spool cap base × 2
5	Spool felt × 2
6	Ring × 4

* No.2 to No.6 are included in a plastic bag.

Memo

- Refer to page 16 to assemble the spool stand.
- Refer to page 44 to wind the bobbin when using the spool stand.

About the Thread Spool and Spool Cap

- Be sure to use a spool cap that is slightly larger than the spool. If the spool cap that is used is smaller or much larger than the spool, the thread may catch and sewing performance may suffer.

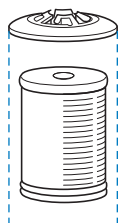

- When using thread on a thin spool, place the included spool felt on the spool pin, place the thread spool on the spool pin so that the center of the spool is aligned with the hole at the center of the spool felt, and then insert the spool cap onto the spool pin.

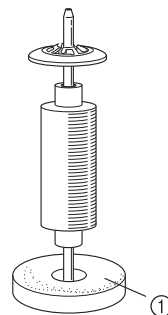

① Spool felt

- When using thread on a cone spool, use the spool holder. When using cone shaped thread spool with other than cotton thread, it is not necessary to use spool caps.

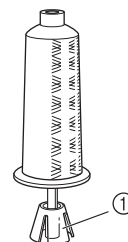

① Spool holder

- Depending on the size of spool or the amount of thread remaining, choose the appropriate sized spool cap (large or medium). Spool cap (small) cannot be used with the spool cap base.

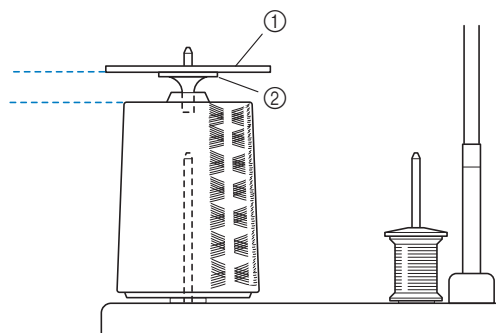

① Spool cap
② Spool cap base

Thread the machine using the spool stand

- 1 Attach the spool stand to the machine. (page 16)

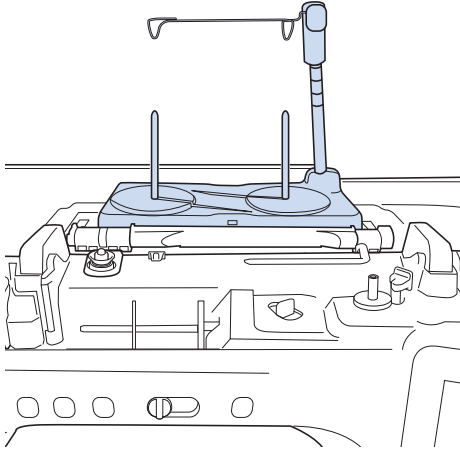

- 2 Place the spool of thread on the spool pin so that the thread feeds off the spool clockwise. Firmly insert the spool cap onto the spool pin.

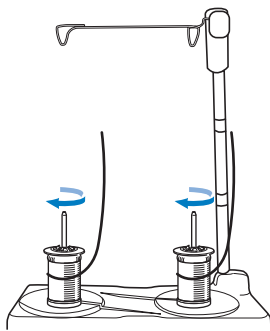

⚠ CAUTION

- Make sure that the spools do not touch each other, otherwise the thread will not feed off smoothly, the needle may break and cause injury. In addition, make sure that the spools do not touch the telescopic thread guide at the center.

💡 Note

- When using 2 spools of thread, make sure that both spools are feeding in the same direction.
- Make sure that the thread is not caught under the spool.

- 3 Pull the thread off the spool. Pass the thread from the back to the front through the thread guides at the top.

When using thread that quickly feeds off the spool, such as metallic thread, use the enclosed ring to prevent the thread from becoming entangled.

Threading sequence: Pull the thread from the spool, place the thread through the ring from the bottom up (1), into the thread guide (2) and through the ring from the top down (3). When using the ring, do not use the spool cap base.

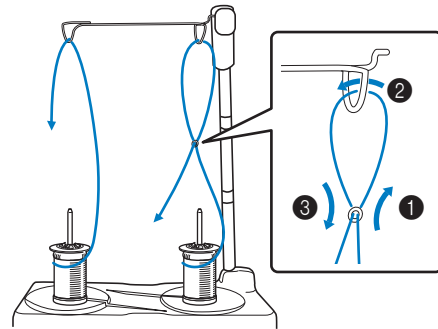

💡 Note

- Guide the thread so that it does not become entangled with the other thread.
- After feeding the thread as instructed, wind any excess thread back onto the spool, otherwise the excess thread will become tangled.

- 4 Pass the thread through the machine's thread guide from the right to the left.

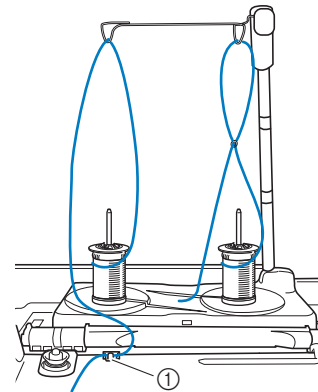



① Thread guide

- 5 Thread the machine according to the steps 6 to 15 of "Upper Threading" on page 47.

CHANGING THE NEEDLE

⚠ CAUTION

- Always touch  on the screen to lock all keys and buttons before changing the needle.
- If  is not pressed and the “Start/Stop” button or another operation button is pressed accidentally, the machine will start and injury may result.
- Use only home sewing machine needles made for home use. Other needles may break and may cause injury.
- Never sew with a bent needle. This may cause injury.

💡 Note

- To check the needle correctly, place the flat side of the needle on a flat surface. Check the needle from the top and the sides. Throw away any bent needles.

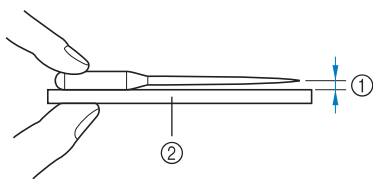

- ① Parallel space
- ② Level surface (bobbin cover, glass, etc.)

- The machine needles are consumables. Replace the needle in cases such as those described below.
 - If an unusual sound is produced when the needle enters the fabric. (The tip of the needle may be broken or dull.)
 - If stitches are skipped. (The needle may be bent.)
 - Generally, after completing one project, such as a piece of clothing.

- 1 Press the “Needle Position” button to raise the needle.

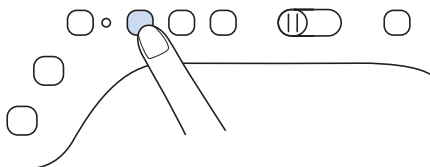

- 2 Touch  to lock all keys and buttons.

* If the message [OK to automatically lower the presser foot?] appears on the LCD screen, touch

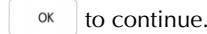

💡 Note

- Before replacing the needle, cover the hole in the needle plate with fabric or paper to prevent the needle from falling into the machine.

- 3 Follow the steps on page 57 to remove the presser foot.

- 4 Use the screwdriver to turn the needle clamp screw toward the front of the machine and loosen the screw. Remove the needle.

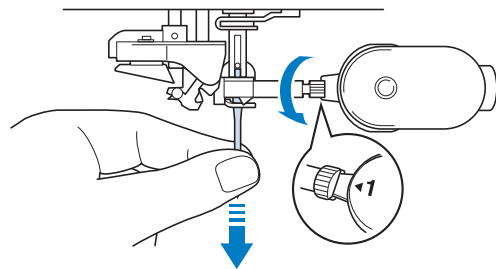

- 5 With the flat side of the needle facing the back, insert the new needle all the way to the top of the needle stopper (viewing window) in the needle clamp. Use a screwdriver to securely tighten the needle clamp screw.

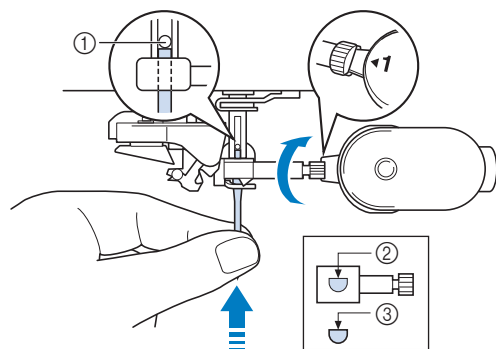

- ① Needle stopper
- ② Hole for setting the needle
- ③ Flat side of needle

CAUTION

- Be sure to push in the needle until it touches the stopper, and securely tighten the needle clamp screw with a screwdriver. If the needle is not completely inserted or the needle clamp screw is loose, the needle may break and cause injury.

- 6 Follow the steps on page 57 to attach the presser foot.
- 7 Touch  to unlock all keys and buttons.

Memo

- The automatic threading function can be used with home sewing machine needle sizes 75/11 through 100/16.
- When threads such as transparent nylon monofilament or speciality threads are used, it is not recommended to use the needle threader.

Fabric/Thread/Needle Combinations

- **Needles that can be used with this machine: Home sewing machine needles (size 65/9 - 100/16)**
* The larger the number, the larger the needle. As the numbers decrease, the needles get finer.
- **Thread that can be used with this machine: 30 - 90 weight**
* Never use thread of 20 weight or lower. It may cause machine to malfunction.
* The smaller the number, the heavier the thread. As the numbers increase, the thread gets finer.
- **The machine needle and thread that should be used depends on the type and thickness of the fabric. Refer to the following table when choosing the thread and needle appropriate for the fabric that you wish to sew.**
 - The combinations shown in the table provide a general guideline. Be sure to sew trial stitches on the actual number of layers and type of fabric to be used in your project.
 - The machine needles are consumables. For safety and best results, we recommend replacing the needle regularly. For details on when to replace the needle, refer to "CHANGING THE NEEDLE" on page 54.
- **In principle, use a fine needle and thread with lightweight fabrics, and a larger needle and heavier thread with heavyweight fabrics.**
- **Select a stitch appropriate for the fabric, and then adjust the stitch length. When sewing lightweight fabrics, make the stitch length finer (shorter). When sewing heavyweight fabrics, make the stitch length coarser (longer). (page 73)**
When sewing stretch fabrics, refer to "Sewing Stretch Fabrics" on page 71.

Fabric Type/Application		Thread		Size of needle	Stitch length mm (inch)
		Type	Weight		
Lightweight fabrics	Lawn, georgette, challis, organdy, crepe, chiffon, voile, gauze, tulle, lining, etc.	Polyester thread	60 - 90	65/9 - 75/11	Fine stitches 1.8-2.5 (1/16-3/32)
		Cotton thread, Silk thread	50 - 80		
Medium weight fabrics	Broadcloth, taffeta, gabardine, flannel, seersucker, double gauze, linen, terry cloth, waffle weave, sheeting, poplin, cotton twill, satin, quilting cotton, etc.	Polyester thread	60 - 90	75/11 - 90/14	Regular stitches 2.0-3.0 (1/16-1/8)
		Cotton thread, Silk thread	50 - 60		
Heavyweight fabrics	Denim (12 ounces or more), canvas, etc.	Polyester thread, Cotton thread	30	100/16	Coarse stitches 2.5-4.0 (3/32-3/16)
		Polyester thread	60	90/14 - 100/16	
	Cotton thread, Silk thread	30 - 50			
Stretch fabrics (knit fabrics, etc.)	Jersey, tricot, T-shirt fabric, fleece, interlock, etc.	Polyester thread, Cotton thread, Silk thread	50	Ball point needle 75/11 - 90/14	Setting appropriate for the fabric thickness
For top-stitching		Polyester thread, Cotton thread	30	90/14 - 100/16	Setting appropriate for the fabric thickness
			50 - 60	75/11 - 90/14	

■ Transparent Nylon thread

Use a home sewing machine topstitching needle, regardless of the fabric or thread.

■ Sewing Character Stitch Patterns and Decorative Stitch Patterns (Needles and Threads)

When sewing lightweight, medium weight or stretch fabrics, use a ball point needle (gold colored) 90/14. When sewing heavyweight fabrics, use a home sewing machine needle 90/14. In addition, #50 to #60 thread should be used.

■ Embroidery Needles



Use a 75/11 home sewing machine needle for embroidery. When embroidering patterns with short stitches, such as small letters, we recommend using a ball point needle for embroidery.

⚠ CAUTION

- The appropriate fabric, thread and needle combinations are shown in the preceding table. If the combination of the fabric, thread and needle is not correct, particularly when sewing heavy fabrics (such as denim) with thin needles (such as 65/9 to 75/11), the needle may break and cause injury. In addition, the stitching may be uneven or puckered or there may be skipped stitches.

CHANGING THE PRESSER FOOT

⚠ CAUTION

- Always touch  on the screen to lock all keys and buttons before changing the presser foot. If  is not touched and the “Start/Stop” button or another button is pressed, the machine will start and may cause injury.
- Always use the correct presser foot for the selected stitch pattern. If the wrong presser foot is used, the needle may strike the presser foot and break, and may cause injury.
- Make sure that the presser foot is installed in the correct direction, otherwise the needle may strike the presser foot, breaking the needle and causing injuries.

IMPORTANT

- Use presser feet made for this machine.

Removing the Presser Foot

- 1 Press the “Needle Position” button to raise the needle.

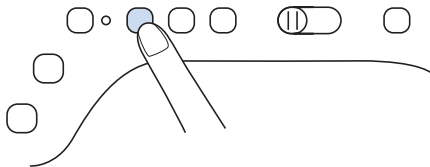

- 2 Touch  to lock all keys and buttons.

* If the message [OK to automatically lower the presser foot?] appears on the LCD screen, touch

to continue.

- 3 Raise the presser foot lever.

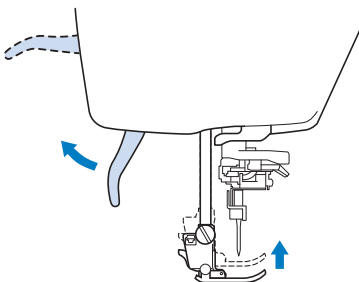

- 4 Press the black button on the presser foot holder and remove the presser foot.

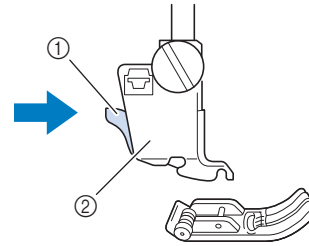

- ① Black button
- ② Presser foot holder

Attaching the Presser Foot

- 1 Place the new presser foot under the holder, aligning the foot pin with the notch in the holder. Lower the presser foot lever so that the presser foot pin snaps into the notch in the holder.

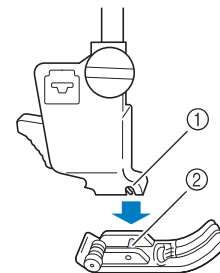

- ① Notch
- ② Pin

- 2 Raise the presser foot lever to check that the presser foot is securely attached.

- 3 Touch  to unlock all keys and buttons.

Attaching the Presser Foot with the Included Adapter

Some presser feet require using the included adapter and small screw, for example, the echo quilting foot “E” and so on.



■ Attaching the Included Adapter and Small Screw

- 1 Follow the steps in “Removing the Presser Foot” on page 57.
- 2 Loosen the screw of the presser foot holder to remove the presser foot holder.

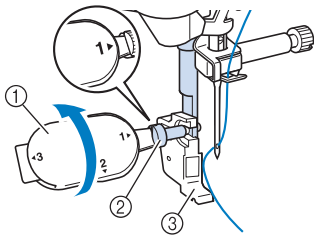

- ① Multi- purpose screwdriver
- ② Presser foot holder screw
- ③ Presser foot holder

- 3 Remove the screw of the presser foot completely from the presser foot shaft.

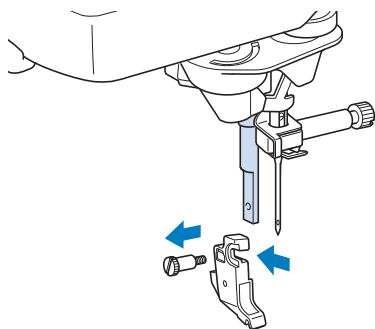

- 4 Set the adapter on the presser foot bar, aligning the flat side of the adapter opening with the flat side of the presser foot bar. Align the screw holes in the adapter and presser foot bar, and then securely tighten the screw with the screwdriver.

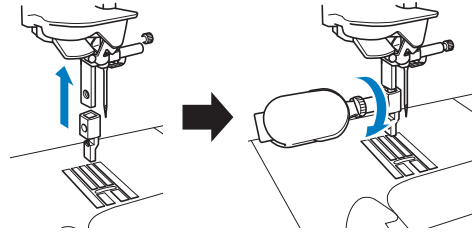

- 5 Turn the included small screw 2 or 3 times with your hand.

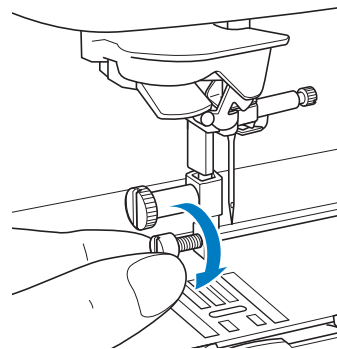

Using the Compact Dual Feed Foot

The compact dual feed foot enables you to have best fabric control when sewing difficult fabrics that slip easily, such as quilted fabrics or fabrics that tend to stick to the bottom of a presser foot, such as vinyl, leather or synthetic leather.

Note

- When sewing with the compact dual feed foot, sew at medium to low speeds.

Memo

- When selecting stitches to be used with the compact dual feed foot, only the stitches that can be used will be activated on the display.
- When sewing fabric that easily sticks together, a more attractive finish can be achieved by basting the beginning of sewing.

■ Attaching the Compact Dual Feed Foot

1 Follow the steps in “Removing the Presser Foot” on page 57.

2 Loosen the screw of the presser foot holder to remove the presser foot holder.

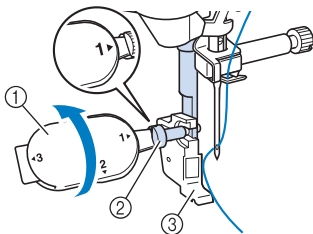

- ① Multi- purpose screwdriver
- ② Presser foot holder screw
- ③ Presser foot holder

3 Position the compact dual feed foot to the presser foot bar by aligning the notch of the compact dual feed foot to the large screw.

Side view

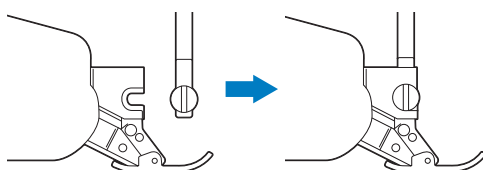

4 Hold the compact dual feed foot in place with your right hand, then using the included multi-purpose screwdriver, securely tighten the large screw.

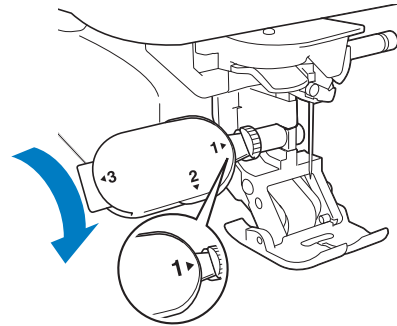

⚠ CAUTION

- Use the included screwdriver to firmly tighten the screw. If the screw is loose, the needle may strike the presser foot and possibly cause injury.

5 Plug the connector of the compact dual feed foot into the jack on the back of your machine.

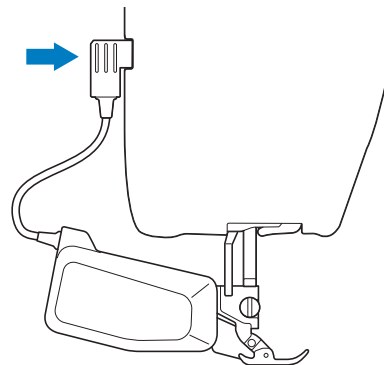

6 Touch  to unlock all keys and buttons.

→ All keys and operation buttons are unlocked, and the previous screen is displayed.

- 7 Place the fabric under the compact dual feed foot with the needle at the starting point of the stitching.
- 8 Be sure that the feed position lever is pushed down and the compact dual feed foot is ready to sew.

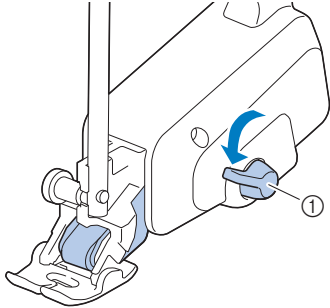

① Feed position lever

Note

- Do not operate the lever while sewing.

Memo

- When the feed position lever is up, dual feed function is not effective. When the feed position lever is down, the black roller belt on the compact dual feed is engaged.

Attaching/Detaching Toe

Attach the toe by aligning the pins with the notches and snap it into place.

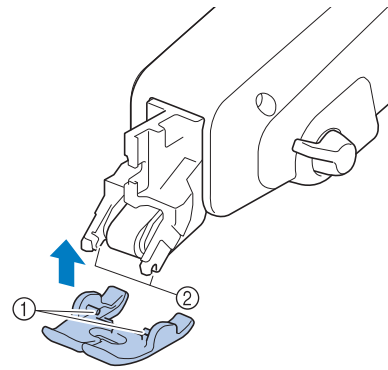

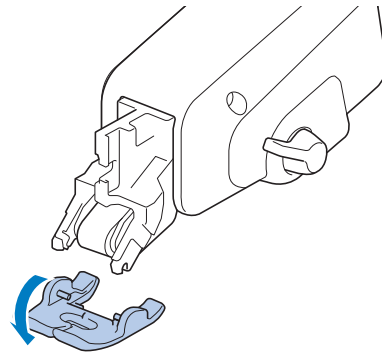

- ① Pins
- ② Notches

If you push down on the front and back part of the compact dual feed foot, the toe of the compact dual feed foot will snap off.



Adjusting the Amount of Fabric Feeding by the Compact Dual Feed Foot

The dual feed mechanism pulls the top fabric according to the set stitch length. With troublesome fabrics, fine tune the set length, by changing [Dual Feed Feed Adjustment] in the settings screen.

- 1 Touch .
 - The settings screen appears.
- 2 Touch .
 - The Sewing settings screen appears.
- 3 Display page 2 of the Sewing settings screen.

4 Touch the number to select the feeding of the top fabric.

- * Select [00] for sewing in most cases.
- * If the feed amount for the top fabric is too little, causing the fabric to be longer than the bottom fabric, touch a higher number to increase the feed amount for the top fabric.
- * If the feed amount for the top fabric is too much, causing the fabric to be shorter than the bottom fabric, touch a lower number to decrease the feed amount for the top fabric.

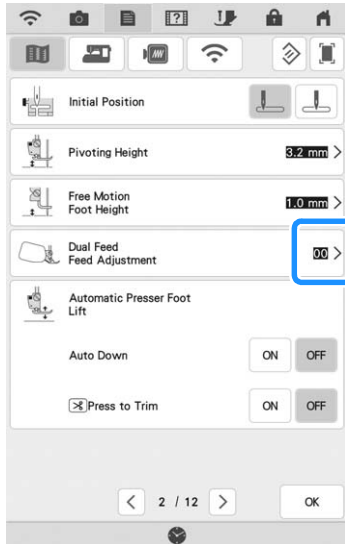

5 Touch to return to the original screen.

SEWING

⚠ CAUTION

- To avoid injury, pay special attention to the needle while the machine is in operation. Keep your hands away from moving parts while the machine is in operation.
- Do not stretch or pull the fabric during sewing. Doing so may lead to injury.
- Do not use bent or broken needles. Doing so may lead to injury.
- Do not attempt to sew over basting pins or other objects during sewing. Otherwise, the needle may break and cause injury.

IMPORTANT

- If stitches become bunched, lengthen the stitch length setting before continuing sewing. Otherwise, the needle may bend or break.

Sewing a Stitch

- 1 Turn the main power to ON and touch  to display the utility stitches, and press the "Needle Position" button to raise the needle.
- 2 Select the category, and then touch the key of the stitch you want to sew.

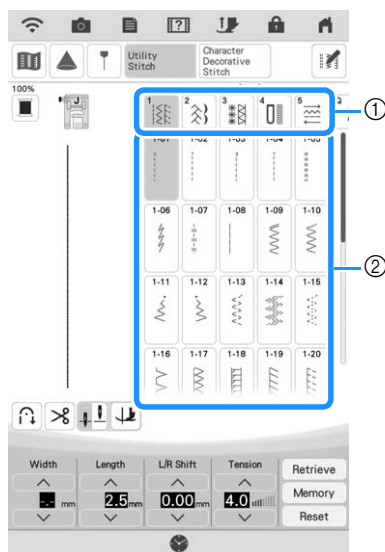

- ① Category
 - ② Key of the stitch
- The symbol of the correct presser foot will be displayed in the upper left corner of the LCD screen.

- 3 Install the presser foot ("CHANGING THE PRESSER FOOT" on page 57).

⚠ CAUTION

- Always use the correct presser foot. If the wrong presser foot is used, the needle may strike the presser foot and break, possibly resulting in injury. Refer to "STITCH SETTING CHART" on page 198 for presser foot recommendations.

- 4 Set the fabric under the presser foot. Hold the fabric and thread in your left hand, and press the "Needle Position" button to set the needle in the sewing start position.

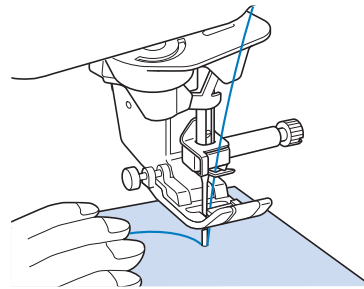

- 5 Lower the presser foot.
 - * You do not have to pull up the bobbin thread.
- 6 Adjust the sewing speed with the speed control slide.

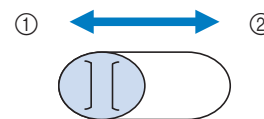

- ① Slow
- ② Fast

7 Press the "Start/Stop" button to start sewing.

- * Guide the fabric lightly by hand.

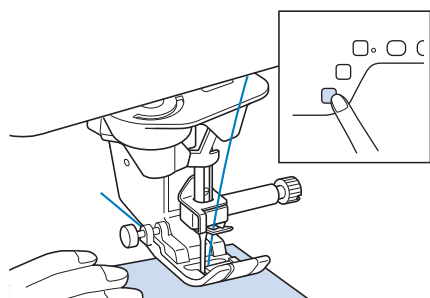

Memo

- When the foot controller is being used, you cannot start sewing by pressing the "Start/Stop" button.

8 Press the "Start/Stop" button again to stop sewing.

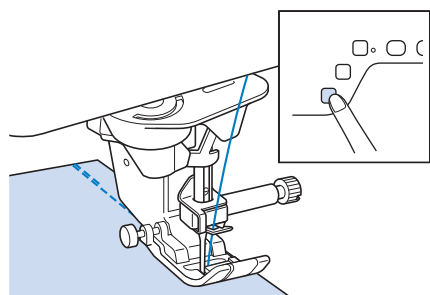

9 Press the "Thread Cutter" button to trim the upper and lower threads.

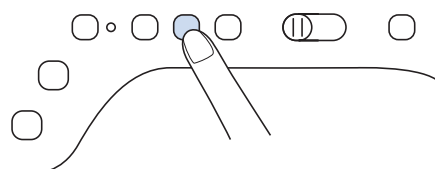

IMPORTANT

- Do not press the "Thread Cutter" button after the threads have been cut. Doing so could tangle the thread or damage the machine.
- Do not press the "Thread Cutter" button when there is no fabric set in the machine or during machine operation. The thread may tangle, possibly resulting in damage.

Note

- When cutting thread such as nylon monofilament thread, or other decorative threads, use the thread cutter on the side of the machine.

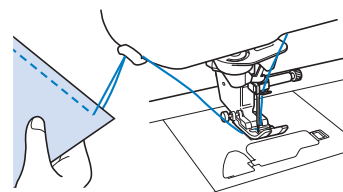

10 When the needle has stopped moving, raise the presser foot and remove the fabric.

Using Advanced Multi-Function Foot Controller

With the advanced multi-function foot controller, various sewing machine operations in addition to starting/stopping sewing, such as thread cutting and reverse stitching, can be specified to be performed.

! WARNING

- The advanced multi-function foot controller contains small parts. Keep the product out of the reach of children to prevent accidental ingestion of small parts.

Note

- (For U.S.A. only) Foot controller: Model X
This foot controller can be used on the machine with product code 882-W33. The product code is mentioned on the machine rating plate.

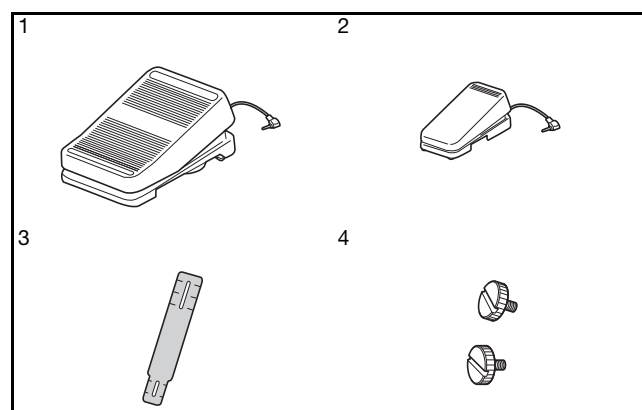

No.	Part Name
1	Main foot controller
2	Side pedal
3	Mounting plate
4	Mounting screw × 2

- 1** Align the smaller end of the mounting plate with the guide on the bottom of the side pedal, and then gently fasten them together with the mounting screw. Align the larger end of the mounting plate with the guide on the bottom of the main foot controller, and then gently fasten them together with the mounting screw.

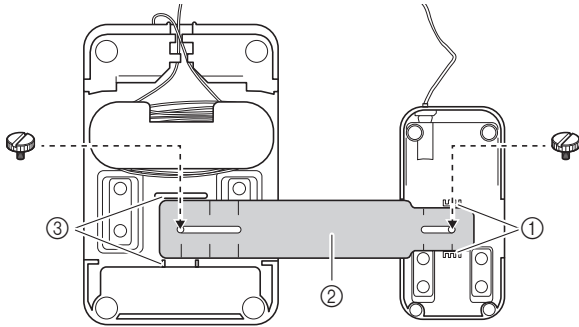

- ① Guide on side pedal
- ② Mounting plate
- ③ Guide on main foot controller

Memo

- The side pedal can be mounted on either the left or right side of the main foot controller.
- The main foot controller and side pedal can also be used without installing the mounting plate.

- 2** Adjust the spacing between the main foot controller and side pedal.

* Use the markings on the mounting plate as a convenient guide to adjust the spacing.

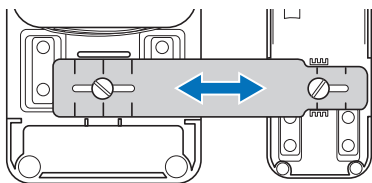

- 3** Firmly tighten the mounting screws to secure the main foot controller and side pedal.

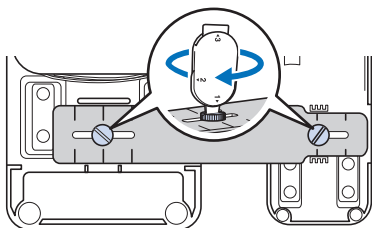

Memo

- To readjust the spacing between the main foot controller and side pedal, slightly loosen the mounting screws, and then adjust the positions of the main foot controller and side pedal.

- 4** Insert the plug for the side pedal into the jack on the main foot controller.

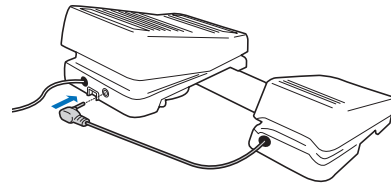

- 5** Insert the plug for the main foot controller into the foot controller jack on the right side of the machine.

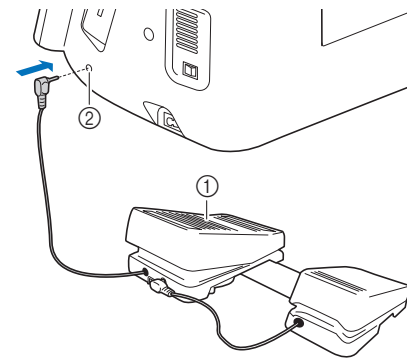

- ① Main foot controller
- ② Foot controller jack

Memo

- The length of the cord for the main foot controller can be adjusted. (page 65)

- 6** Turn on the machine. And then touch  and display page 3 of the settings screen.

Memo

- Before specifying the functions, connect the multi-function foot controller to the machine. The settings screen is activated the first time that the machine detects the multi-function foot controller.

7 Select the functions to be performed by the multi-function foot controller.

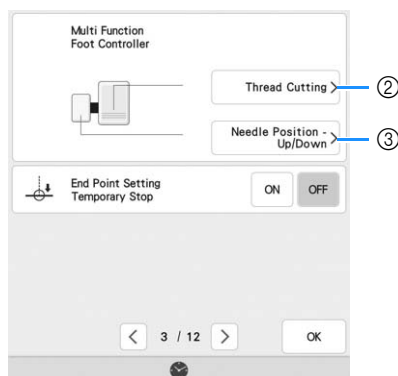
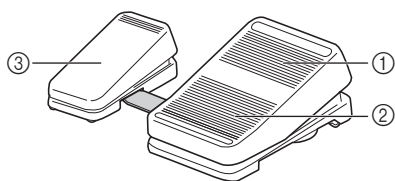

	Controller	Functions that can be specified
①	Main foot controller	Start/Stop
②	Heel switch	Select any of the following: <ul style="list-style-type: none"> • [Thread Cutting] • [Needle Position - Up/Down]
③	Side pedal	<ul style="list-style-type: none"> • [Single Stitch] • [Reverse Stitch] (Reinforcement Stitch) * • [Presser Foot Up/Down] • [No Setting]

* If you set the "Reverse Stitch" function on the heel switch, machine operates the same as pressing the "Reverse Button" on the machine.

* Reinforcement stitching may be applied depending on the selected stitch pattern. For the details, refer to "Automatic Reinforcement Stitching" on page 66.

Memo

- If you set [Reverse Stitch] on the side pedal, you can create a darning stitch effect using zigzag stitches. With both feet, keep pressing the main foot controller, and repeat pressing and releasing the side pedal to sew forward and reverse in turn. Machine will reverse at the speed you press the main foot controller.

8 Touch .

9 Sew trial stitches and confirm that the settings are as desired.

Pressing down on the main foot controller increases the sewing speed; releasing the pressure on the main foot controller decreases the sewing speed.

Release the main foot controller or side pedal to stop sewing.

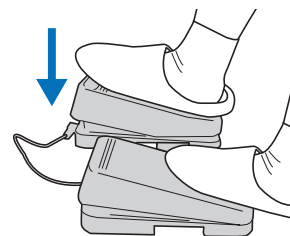

Memo

- The speed that is set using the sewing speed controller will be the main foot controller's maximum sewing speed.
- When the multi-function foot controller is connected, the "Start/Stop" button cannot be used to start sewing.

Adjusting the Length of the Cord for the Main Foot Controller

1 Unwind the cord for the main foot controller.

2 Guide the cord between the tabs.

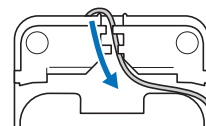

3 Wind the cord until it is the desired length.

- * The cord can be wound either clockwise or counterclockwise.

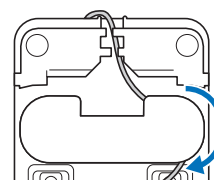

4 Pass the cord between the tabs.

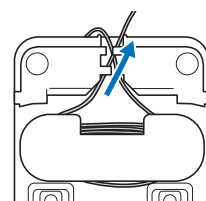

Note

- In order to avoid stepping on the cord with the main foot controller, pass the cord between the tabs.

Memo

- When storing the cord, pass it between the tabs, and then insert the plug into the jack on the main foot controller.

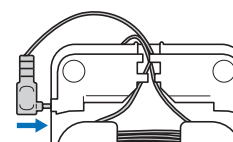

Sewing Reverse/Reinforcement Stitches

Reverse/reinforcement stitches are generally necessary at the beginning and end of sewing. You can use the “Reverse Stitch” button to sew reverse/reinforcement stitches. When you keep pressing “Reinforcement Stitch” button, the machine will sew reinforcement stitch at that point 3 to 5 stitches, and then stop. (page 13)

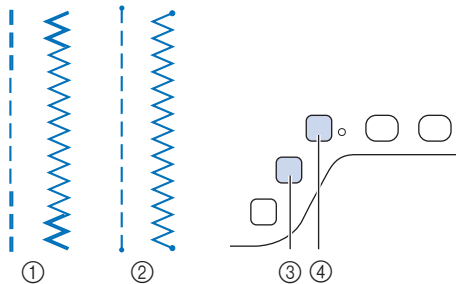

- ① Reverse stitch
- ② Reinforcement stitch
- ③ “Reverse Stitch” button
- ④ “Reinforcement Stitch” button

The operation performed when the button is pressed differs depending on the selected stitch pattern. (Refer to the table in “The Operation Performed when the “Reverse Stitch” or “Reinforcement Stitch” is Pressed” on page 67.)

Memo

- When you press the “Reinforcement Stitch” button while sewing character/decorative stitch pattern, you can end sewing with a full stitch instead of at a mid-point.
- The green light on the right of the “Reinforcement Stitch” button lights up while the machine is sewing a full motif, and it automatically turns off when the sewing is stopped.

Automatic Reinforcement Stitching

After selecting a stitch motif, turn on the automatic reinforcement stitching function before sewing, and the machine will automatically sew reinforcement stitches (or reverse stitches, depending on the stitch motif) at the beginning and end of sewing.

- 1 Select a stitch pattern.
- 2 Touch to set the automatic reinforcement stitching function.

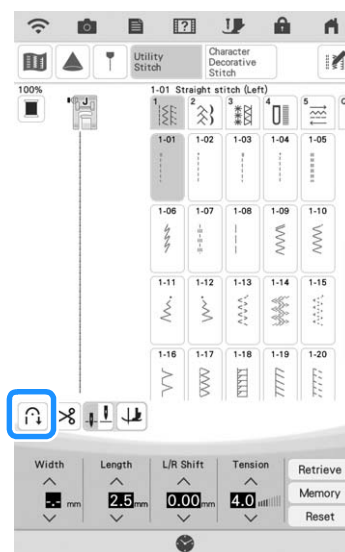

→ The key will display as .

- 3 Set the needle into the fabric, and then press the “Start/Stop” button.

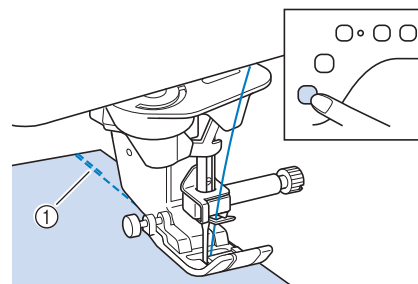

- ① Reverse stitches (or reinforcement stitches)
- The machine will automatically sew reverse stitches (or reinforcement stitches) and then continue sewing.

Memo

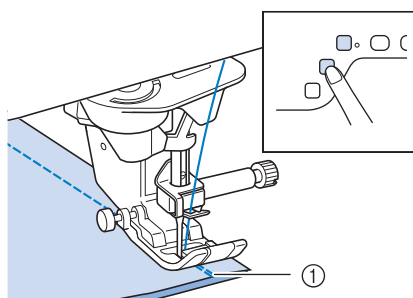

- Pressing the “Start/Stop” button while the machine is sewing pauses or restarts sewing.

- 4 When the end of stitching has been reached, press the "Reverse Stitch" button or the "Reinforcement Stitch" button.









- ① Reverse stitches (or reinforcement stitches)
→ The machine will sew reverse stitches (or reinforcement stitches) and stop.











Memo

- To turn off the automatic reinforcement stitching function, touch  again, so it appears as .

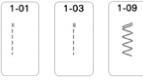
■ The Operation Performed when the "Reverse Stitch" or "Reinforcement Stitch" is Pressed

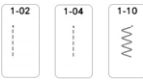
The operation performed when the button is pressed differs depending on the selected stitch pattern. Refer to the following table for details on the operation that is performed when the button is pressed.

	"Reverse Stitch" button 	"Reinforcement Stitch" button 
Automatic reverse/reinforcement stitching function is not active.		
Utility Stitch 1-01 1-03 1-09 	Machine sews reverse stitches while holding the "Reverse Stitch" button.	Machine sews 3 – 5 reinforcement stitches while holding the "Reinforcement Stitch" button.
Utility Stitch 1-02 1-04 1-10 (Stitch patterns has a dot mark "•" at the top of the key) 	Machine sews reverse stitches while holding the "Reverse Stitch" button.*	Machine sews 3 – 5 reinforcement stitches while holding the "Reinforcement Stitch" button.
Utility Stitch Other than straight/zigzag stitch patterns 	Machine sews 3 – 5 reinforcement stitches while holding the "Reverse Stitch" button.	Machine sews 3 – 5 reinforcement stitches while holding the "Reinforcement Stitch" button.
Character Decorative Stitch 	Machine sews 3 – 5 reinforcement stitches while holding the "Reverse Stitch" button.	Machine sews 3 – 5 reinforcement stitches while holding the "Reinforcement Stitch" button. At the end of sewing, when the "Reinforcement Stitch" button is pressed, the "Reinforcement Stitch" button lights up, machine completes the stitch pattern, stops sewing, then sews reinforcement stitches.

	“Reverse Stitch” button 	“Reinforcement Stitch” button 
Automatic reverse/reinforcement stitching function is active.		
 +  1-01 1-03 1-09 	At the beginning of sewing, reverse stitches are sewn automatically when “Start/Stop” button is pressed. At the end of sewing, reverse stitches are sewn when “Reverse Stitch” button is pressed.	At the beginning of sewing, reverse stitches are sewn automatically when “Start/Stop” button is pressed. At the end of sewing, reinforcement stitches are sewn when “Reinforcement Stitch” button is pressed.
 +  1-02 1-04 1-10  (Stitch patterns has a dot mark “.” at the top of the key)	At the beginning of sewing, reinforcement stitches are sewn automatically when “Start/Stop” button is pressed. At the end of sewing, reverse stitches are sewn when “Reverse Stitch” button is pressed.*	At the beginning of sewing, reinforcement stitches are sewn automatically when “Start/Stop” button is pressed. At the end of sewing, reinforcement stitches are sewn when “Reinforcement Stitch” button is pressed.
 +  Other than straight/zigzag stitch patterns	At the beginning of sewing, reinforcement stitches are sewn automatically when “Start/Stop” button is pressed. At the end of sewing, reinforcement stitches are sewn when “Reverse Stitch” button is pressed.	At the beginning of sewing, reinforcement stitches are sewn automatically when “Start/Stop” button is pressed. At the end of sewing, reinforcement stitches are sewn when “Reinforcement Stitch” button is pressed.
 + 	At the beginning of sewing, reinforcement stitches are sewn automatically when “Start/Stop” button is pressed. At the end of sewing, reinforcement stitches are sewn when “Reverse Stitch” button is pressed.	At the beginning of sewing, reinforcement stitches are sewn automatically when “Start/Stop” button is pressed. At the end of sewing, when the “Reinforcement Stitch” button is pressed, the “Reinforcement Stitch” button lights up, machine completes the stitch pattern, stops sewing, then sews reinforcement stitches.

* If [Reinforcement Priority] of the settings screen is set to [ON] (page 21), reinforcement stitches are sewn instead of reverse stitches.

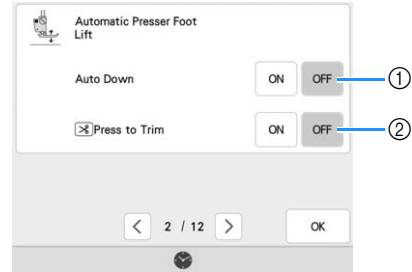

Automatic Presser Foot Lowering Function and Thread Cutting Function

By setting the machine to automatically raise and lower the presser foot, sewing operations can be performed more smoothly.



No.	Key Name	Explanation
①	[Auto Down]	When [Auto Down] in the machine settings screen is set to [ON], pressing the “Start/Stop” button or depressing the foot controller automatically lowers the presser foot (if it is raised) before starting to sew.
②	[Press to Trim]	When [Press to Trim] in the machine settings screen is set to [ON], pressing the “Thread Cutter” button automatically lowers the presser foot (if it is raised) before cutting the thread. The presser foot will be raised after the thread is cut.

Automatic Presser Foot Raising Function

When the needle position is set to , auto up key appears instead of pivot key. When the auto up key is set to , the presser foot and needle are raised automatically if the machine is stopped.

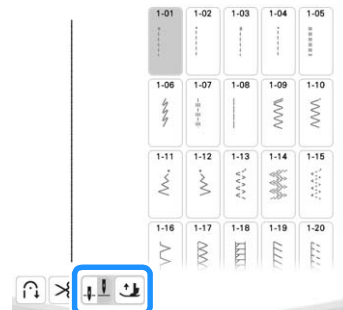

Sewing Curves

Sew slowly while keeping the seam parallel with the fabric edge as you guide the fabric around the curve.

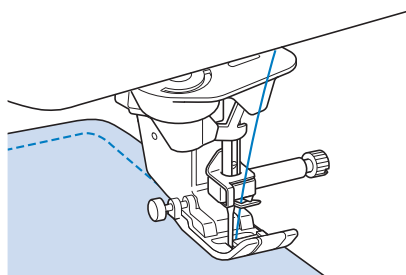

Changing Sewing Direction

Stop the machine. Leave the needle in the fabric, and press the “Presser Foot Lifter” button to raise the presser foot. Using the needle as a pivot, turn the fabric so that you can sew in the new direction. Press the “Presser Foot Lifter” button to lower the presser foot and start sewing.

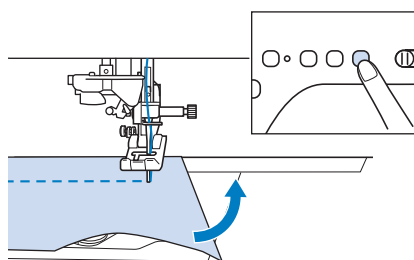

The pivot setting is useful when changing the sewing direction. When the machine is stopped at the corner of the fabric, the machine stops with the needle in the fabric and the presser foot is automatically raised so the fabric can easily be rotated (“Pivoting” on page 76).

■ Sewing a Seam Allowance of 0.5 cm or Less

Baste the corner before sewing, and then, after changing the sewing direction at the corner, pull the basting thread toward the back while sewing.

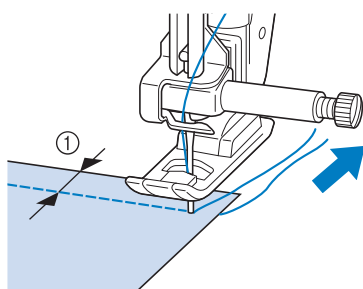

① 5 mm (approx. 3/16 inch)

Sewing Heavyweight Fabrics

If the thickness of a seam causes the presser foot to rest at an angle, help guide the fabric by hand and sew on the downward slope.

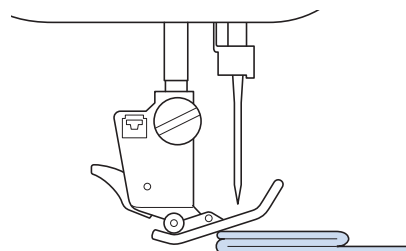

⚠ CAUTION

- If fabric more than 6 mm (1/4 inch) thick is sewn or if the fabric is pushed with too much force, the needle may break and cause injury.

📝 Memo

- Thicker fabrics require a larger needle. (page 56)

■ If the Fabric Does Not Fit Under the Presser Foot

If the presser foot is in the up position, and you are sewing heavyweight or multiple layers of fabric which do not fit easily under the presser foot, use the presser foot lever to raise the presser foot to its highest position. The fabric will now fit under the presser foot.

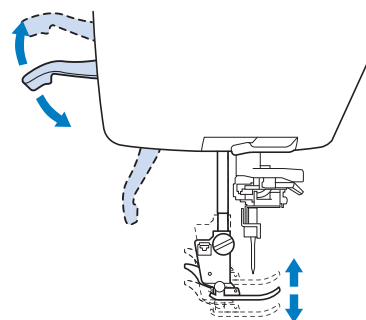

📝 Memo

- You cannot use the presser foot lever after the presser foot has been raised using the “Presser Foot Lifter” button.

■ If the Fabric Does Not Feed

When sewing thick fabric such as denim or quilting layers, the fabric may not feed at the start of sewing if the presser foot is not level, as shown below. In this case, use the presser foot locking pin (black button on the left side) of zigzag foot "J" so that the presser foot remains level while sewing, allowing the fabric to be fed smoothly.

If the presser foot misalignment is too large, place thick paper or fabric (with the same thickness as the fabric being sewn) under the heel of the presser foot to be able to start sewing smoothly.

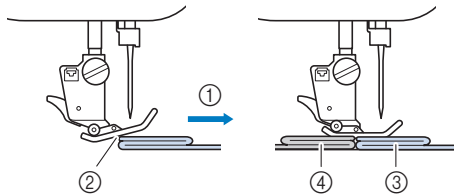

- ① Sewing direction
- ② Misalignment
- ③ Fabric being sewn
- ④ Fabric or thick paper

1 Raise the presser foot.

2 While keeping the black button on the left side of presser foot "J" pressed in, press the "Presser Foot Lifter" button to lower the presser foot.

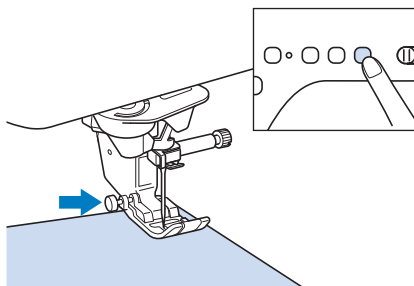

3 Release the black button.

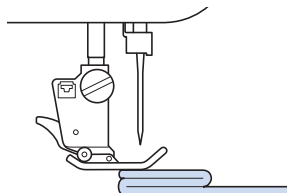

→ The presser foot remains level, enabling the fabric to be fed.

📖 Memo

- Once the trouble spot has been passed, the foot will return to its normal position.
- When [Automatic Fabric Sensor System] (Automatic Presser Foot Pressure) in the machine settings screen is set to [ON], the thickness of the fabric is automatically detected by the internal sensor, so the fabric can be fed smoothly for best sewing results. (page 78)

Sewing Hook-and-Loop Fastener Tape

⚠ CAUTION

- If non-adhesive hook-and-loop fastener tape is sewn with a fine needle (65/9-75/11), the needle may break and cause injury.

IMPORTANT

- Adhesive backed hook-and-loop fastener tape is not designed for sewing. When glue adheres to the needle or the bobbin hook race, it may cause malfunction.

💡 Note

- Before starting to sew, baste the fabric and hook-and-loop fastener tape together.

Make sure that the needle passes through the hook-and-loop fastener tape by rotating the handwheel and lowering the needle into the hook-and-loop fastener tape before sewing. Sew the edge of the hook-and-loop fastener tape at a slow speed.

If the needle does not pass through the hook-and-loop fastener tape, replace the needle size with the needle for thick fabrics. (page 56)

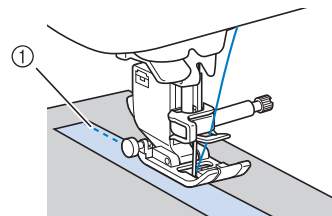

① Edge of the hook-and-loop fastener tape

Sewing Lightweight Fabrics

Place thin paper or tear away embroidery stabilizer under thin fabrics to make sewing easier. Gently tear off the paper or the stabilizer after sewing.

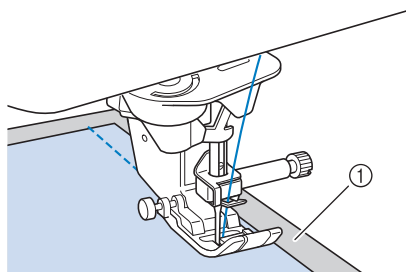

① Thin paper

Sewing Stretch Fabrics

First, baste together the pieces of fabric, and then sew without stretching the fabric. In addition, a better result can be achieved by using thread for knits or a stretch stitch.

Memo

- For best results when sewing stretch fabrics, decrease the pressure of the presser foot (“Using the Machine Setting Mode Key” on page 20).

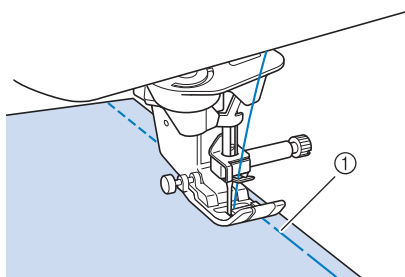

① Basting stitching

Sewing Leathers or Vinyl Fabrics

When sewing fabrics that may stick to the presser foot, such as leather or vinyl fabrics, replace the presser foot with the compact dual feed foot. (page 59)

If the leather or vinyl fabric sticks to the flat bed attachment, sew with copy paper or tracing paper placed on top of the flat bed attachment so the fabric moves smoothly.

If the paper is positioned so that it does not cover the needle plate, the paper will not be sewn together with the fabric.

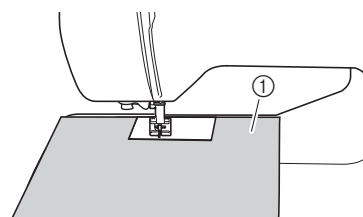

① Copy paper or tracing paper

Sewing Cylindrical Pieces

Removing the flat bed attachment allows for free-arm sewing, making it easier to sew cylindrical pieces such as sleeve cuffs and pant legs.

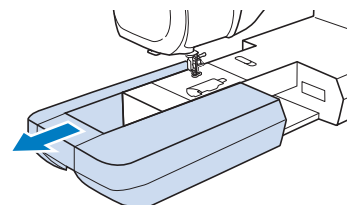

STITCH SETTINGS

When you select a stitch, your machine automatically selects the appropriate stitch width, stitch length, and upper thread tension. However, if needed, you can change any of the individual settings.

 **Memo**

- Settings for some stitches cannot be changed (refer to “STITCH SETTING CHART” on page 198).
- If you turn off the machine or select another stitch without saving stitch setting changes (“Saving Your Stitch Settings” on page 96), the stitch settings will return to their default settings.

Setting the Stitch Width

Follow the steps below when you want to change the stitch pattern width.



 **Memo**

- For an alternate method of changing the stitch width using the speed controller, refer to page 112.

Example:

Touch  to narrow the stitch pattern width.

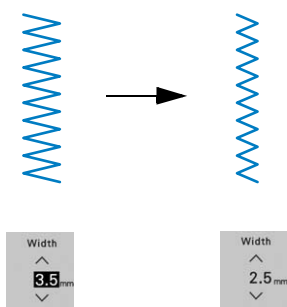

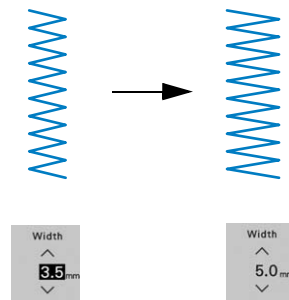

→ The value in the display gets smaller.

Touch  to widen the stitch pattern width.

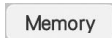

→ The value in the display gets bigger.

 **Memo**

- Touch  to save the stitch settings.
- Touch  to check changes made to the stitch.
- Touch  to return the stitch width to the original setting.

 **Note**

- After adjusting the stitch width, slowly rotate the handwheel toward you (counterclockwise) and check that the needle does not touch the presser foot.

Setting the Stitch Length

Follow the steps below when you want to change the stitch pattern length.

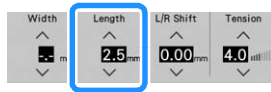

Example:

Touch to shorten the stitch length.

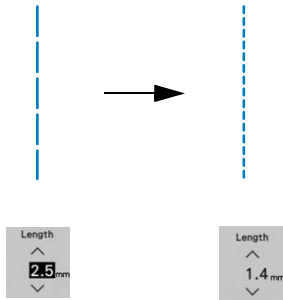

→ The value in the display gets smaller.

Touch to lengthen the stitch length.

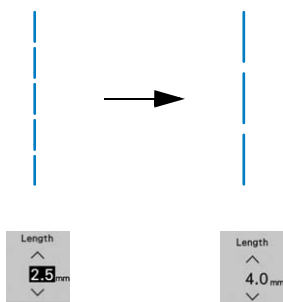

→ The value in the display gets bigger.

Memo

- Touch to save the stitch settings.
- Touch to check changes made to the stitch.
- Touch to return the stitch length to the original setting.

IMPORTANT

- If the stitches get bunched together, lengthen the stitch length and continue sewing. Do not continue sewing without lengthening the stitch length. Otherwise, the needle may bend or break.

Setting the [L/R Shift]

Follow the steps below when you want to change the placement of the stitch pattern by moving it left and right.

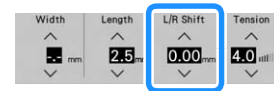

Example:

Touch to shift the stitch pattern to the left.

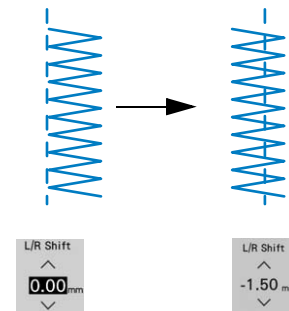

→ The value in the display appears with a minus sign.

Touch to shift the stitch pattern to the right.

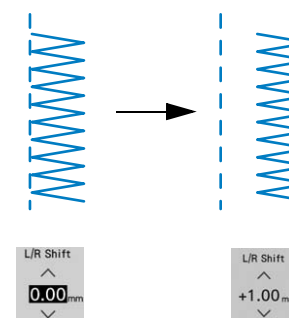

→ The value in the display appears with a plus sign.

Memo

- Touch to save the stitch settings.
- Touch to check changes made to the stitch.
- Touch to return to the original setting.
- For an alternate method of setting the [L/R Shift] using the speed controller, refer to page 99.

Note

- After adjusting the [L/R Shift], slowly rotate the handwheel toward you (counterclockwise) and check that the needle does not touch the presser foot.

Setting the Thread Tension

You may need to change the thread tension, depending on the fabric and thread being used. Follow the steps below to make any necessary changes.



Proper Thread Tension

The upper thread and the bobbin thread should cross near the center of the fabric. Only the upper thread should be visible from the right side of the fabric, and only the bobbin thread should be visible from the wrong side of the fabric.

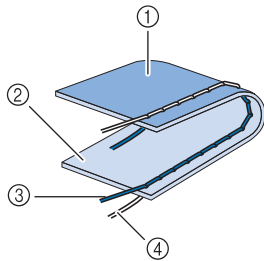

- ① Wrong side
- ② Surface
- ③ Upper thread
- ④ Bobbin thread

Memo

- Many decorative stitches and satin stitches are designed so that the upper thread wraps to the back slightly for a more attractive finish.

Upper Thread is Too Tight

If the bobbin thread is visible from the right side of the fabric, the upper thread is too tight.

Note

- If the bobbin thread was incorrectly threaded, the upper thread may be too tight. In this case, refer to “Setting the Bobbin” on page 44 and rethread the bobbin thread.

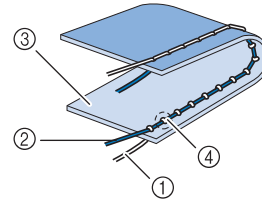

- ① Bobbin thread
- ② Upper thread
- ③ Surface
- ④ Locks appear on surface of fabric

Touch , to loosen the upper thread.

Upper Thread is Too Loose

If the upper thread is visible from the wrong side of the fabric, the upper thread is too loose.

Note

- If the upper thread was incorrectly threaded, the upper thread may be too loose. In this case, refer to “Upper Threading” on page 47 and rethread the upper thread.

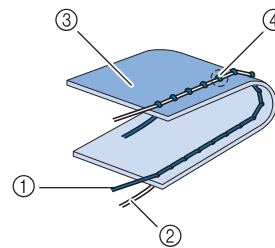

- ① Upper thread
- ② Bobbin thread
- ③ Wrong side
- ④ Locks appear on wrong side of fabric

Touch , to tighten the upper thread.

Memo

- Touch  to return the thread tension to the original setting.

USEFUL FUNCTIONS

2

Sewing Basics



Automatic Thread Cutting

After selecting a stitch pattern, turn on the automatic thread cutting function before sewing, and the machine will automatically sew reinforcement stitches (or reverse stitches, depending on the stitch pattern) at the beginning and end of sewing, and trim the threads at the end of sewing. This function is useful when sewing buttonholes and bar tacks.

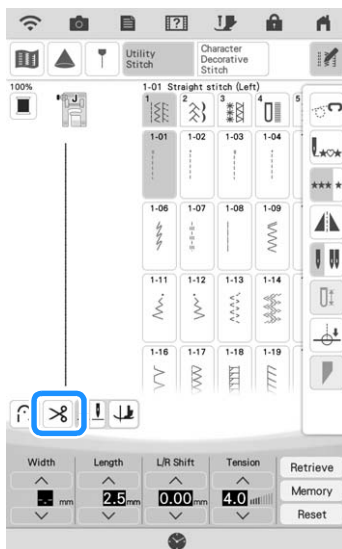

1 Select a stitch pattern.

2 Touch  to set the automatic thread cutting function.



→ The keys will display as  , and the machine is set for automatic thread cutting function and automatic reverse/reinforcement stitching.

Memo

- To turn off the automatic thread cutting function, Touch  again, so it appears as .

3 Set the needle into the fabric and start sewing.

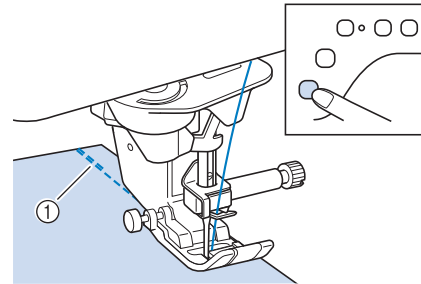

- ① Reverse stitches (or reinforcement stitches)
→ The machine will automatically sew reverse stitches (or reinforcement stitches) and then continue sewing.

Memo

- If you press the “Start/Stop” button to pause sewing, press the same button again to continue. The beginning reverse/reinforcement stitches will not be sewn again.

4 Once you have reached the end of the stitching, press “Reverse Stitch” button or “Reinforcement Stitch” button once.

If stitching, such as buttonholes and bar tacking, that includes reinforcement stitching has been selected, this operation is unnecessary.

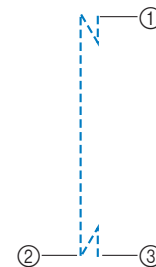

- ① The point where the “Start/Stop” button was pressed.
② The point where the “Reverse Stitch” button or the “Reinforcement Stitch” button was pressed.
③ The thread is cut here.

Memo

- The automatic thread cutting function will not be performed if the “Start/Stop” button is pressed while sewing. Press the “Reverse Stitch” button or the “Reinforcement Stitch” button at the end of the stitching.

Pivoting

If the pivot function is selected, the machine stops with the needle lowered (in the fabric) and the presser foot is automatically raised to an appropriate height when the "Start/Stop" button is pressed. When the "Start/Stop" button is pressed again, the presser foot is automatically lowered and sewing continues. This function is useful for stopping the machine to rotate the fabric.

CAUTION

- When the pivot setting is selected, the machine starts when the "Start/Stop" button is pressed or the foot controller is pressed down even if the presser foot has been raised. Be sure to keep your hands and other items away from the needle, otherwise injuries may occur.

Memo

- When the pivot setting is selected, the height of the presser foot when sewing is stopped can be changed according to the type of fabric being sewn. Touch  to display [Pivoting Height] of the settings screen. Touch the number to select the height. To raise the presser foot further, increase the setting. (Normally, 3.2 mm is set.)

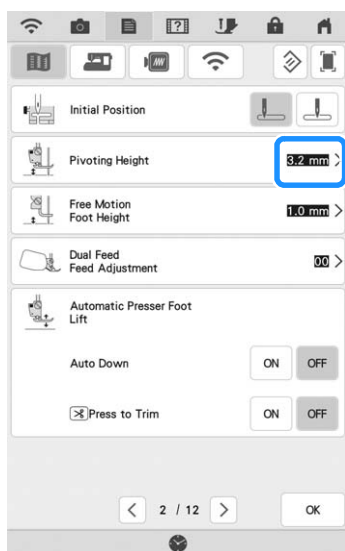

- Select a stitch.

- Touch  to select the pivot setting.

- To use the pivot function, the needle position should be set to .

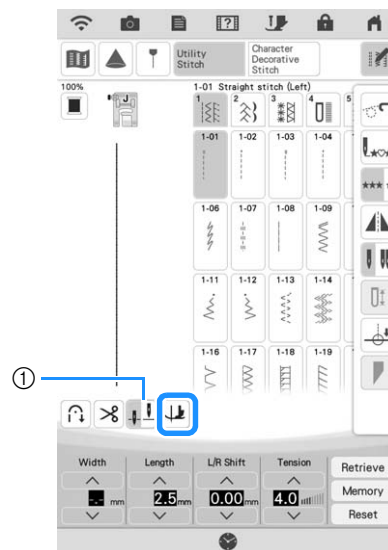

- Needle position setting key

→ The key appears as .

Memo

- If  appears as light gray when the stitch pattern was selected, the pivot function cannot be used.
- If the pivot function is selected, [Presser Foot Height] in the settings screen is not available and the setting cannot be changed.

- Place the fabric under the presser foot with the needle at the starting point of the stitching, and then press the "Start/Stop" button. The machine will begin sewing.

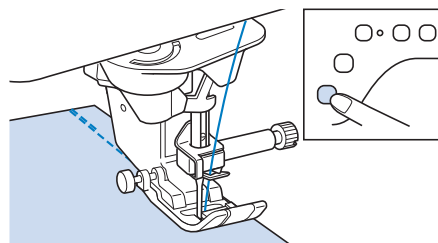

- Press the "Start/Stop" button to stop the machine at the point where the sewing direction changes.

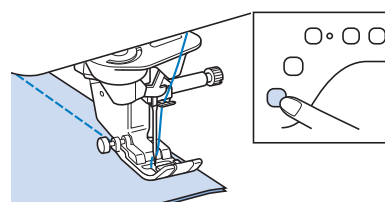

→ The machine stops with the needle in the fabric, and the presser foot is raised.

- 5** Rotate the fabric, and then press the “Start/Stop” button.

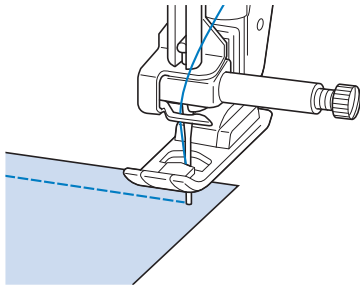

→ The presser foot is automatically lowered, and sewing continues.

Using the Knee Lifter

Using the knee lifter, you can raise and lower the presser foot with your knee, leaving both hands free to handle the fabric.

- 1** Change the operating position of the knee lifter handle before inserting into the machine.

Slide up the knee lifter handle slightly and rotate it while releasing pressure so handle will click into position.

* The knee lifter can be adjusted to three different angles.

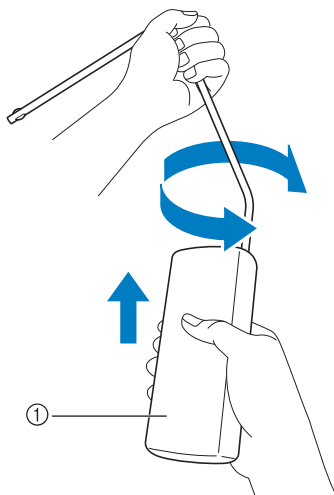

① Knee lifter handle

→ Rotate knee lifter handle till it clicks into the selected position that is most comfortable for you.

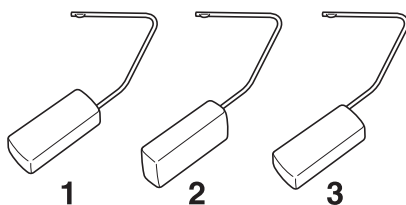

- 2** Align the tabs on the knee lifter with the notches in the knee lifter slot on the front of the machine. Insert the knee lifter bar as far as possible.

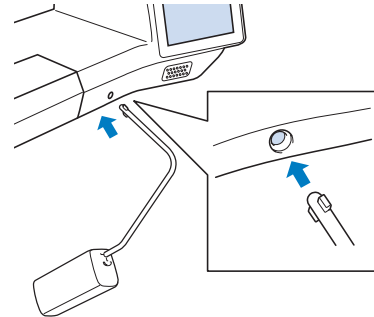

IMPORTANT

- Only change position of the knee lifter handle when knee lifter is not on the machine, otherwise the knee lifter may damage the mounting slot on front of the machine.

Memo

- If the knee lifter bar is not pushed into the mounting slot as far as possible, it may come out during use.

- 3** Use your knee to move the knee lifter bar to the right in order to raise the presser foot. To lower the presser foot, use your knee to move the knee lifter bar slightly toward the right, then release it.

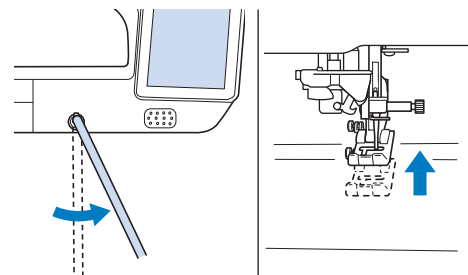

Note

- Be sure to keep your knee away from the knee lifter during sewing.

Automatic Fabric Sensor System (Automatic Presser Foot Pressure)

The thickness of the fabric is automatically detected and the presser foot pressure is automatically adjusted with an internal sensor while sewing, to insure that your fabric is fed smoothly. The fabric sensor system works continuously while sewing. This function is useful for sewing over thick seams (page 69), or quilting (page 110).

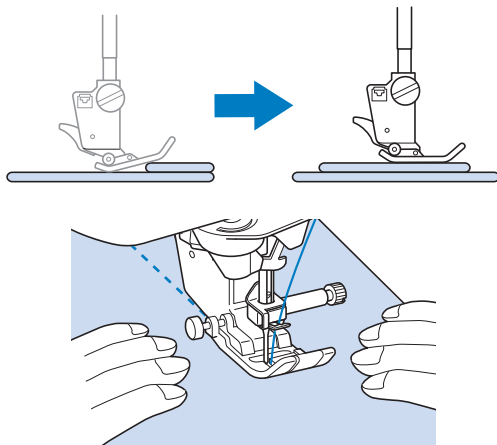

1 Touch .
→ The settings screen appears.

2 Set [Automatic Fabric Sensor System] to [ON].

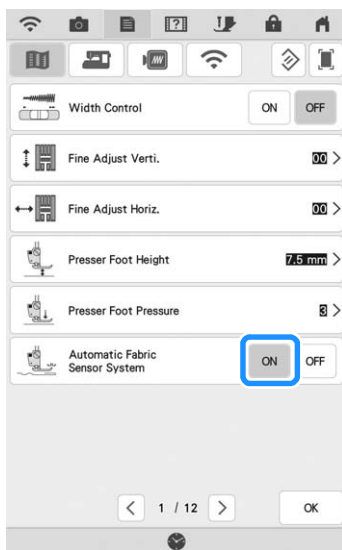

3 Touch to return to the original screen.

Needle Position - Stitch Placement

When the [Needle Position - Stitch Placement] is [ON], the needle will be partially lowered for precise stitch placement and then completely lowered when you press the “Needle Position” button. Each press of the “Needle Position” button changes the needle to the next position. When the [Needle Position - Stitch Placement] is [OFF], each press of the “Needle Position” button simply raises and then lowers the needle.

[Needle Position - Stitch Placement] is [ON]

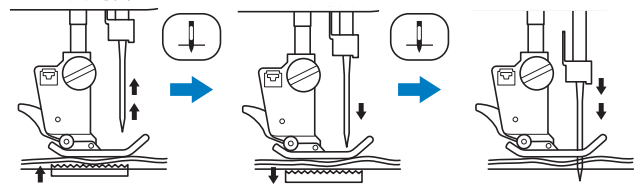

* When the needle is nearly lowered by pressing the “Needle Position” button, the feed dogs are lowered. At this time, the fabric can be shifted to finely adjust the needle drop position.

[Needle Position - Stitch Placement] is [OFF]

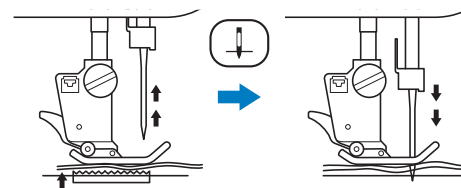

1 Touch .

2 Set [Needle Position - Stitch Placement] to [ON] or [OFF].

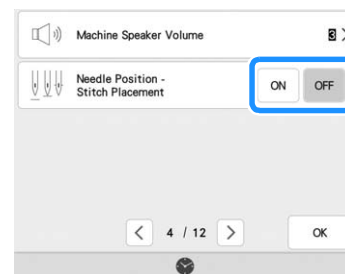

3 Touch to return to the original screen.

Checking the Needle Location in the Screen

You can check the stitch image with actual fabric image on the screen.

1 Select a stitch.

2 Touch .

→ An image of the selected stitch and the actual fabric image are displayed.

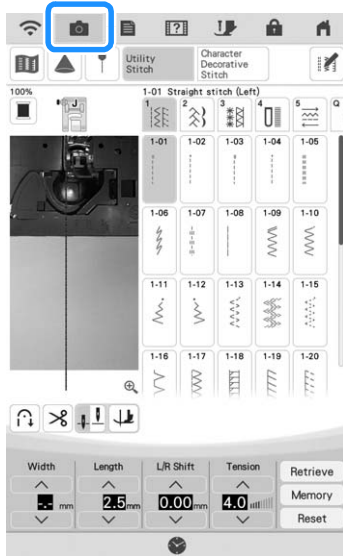

* Touch  to change the thread color displayed on the screen. You can select from four different colors.

3 Touch on the fabric image or  on the screen.

→ The camera view window appears.

* Touch  again to turn off the camera view.

Using the Camera View Window

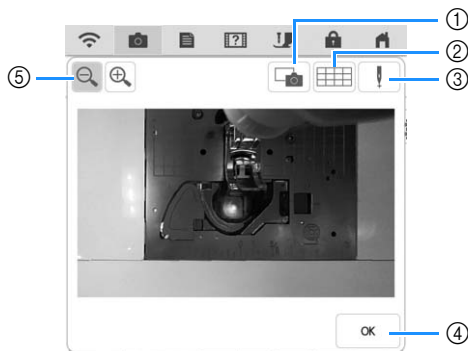

① Touch this key to save a camera image to the USB media.
Insert the USB media to the machine to save a camera image (page 24).

② Touch this key to display a grid.

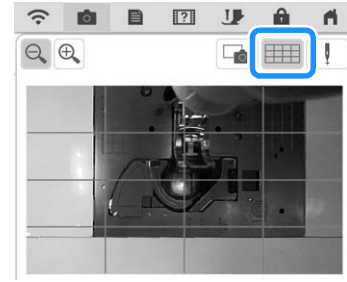

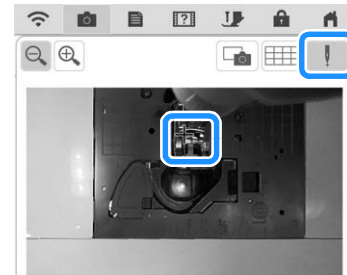

③ Lower the presser foot, and then touch . The needle drop position appears in the screen as “+”.



* When moving the fabric, raise the presser foot, and then lower it again afterwards.

④ Touch this key to close the screen.

⑤ Touch  to enlarge the image in the screen.
Touch  again to return the image to its original display size.

Memo

- The camera view window disappears when you start sewing.
- The needle drop position indicated in the screen may differ from the actual position. In that case, performing the camera needle position setting procedure may resolve the problem. Refer to “Needle Calibration Using the Built-in Camera” on page 26.

USING THE PROJECTOR

Convenient Sewing Features by Using the Projector

Operations that can use the projector

- Setting the guideline as a reference for your sewing position (page 84)
- Projecting the stitch pattern (page 82)
- Selecting a stitch pattern (page 83)
- Editing the selected stitch pattern (page 83)
- Displaying the needle drop point (when embroidering)
- Displaying the edited embroidery pattern (when embroidering)
- Specifying the Sewing End Point (page 86)

⚠ WARNING

- Do not stare directly at the projector light. Otherwise, blindness may result.

About the Dual Purpose Stylus

The included dual purpose stylus has two points. Use the soft point to operate the screen and the hard point to operate the projector.

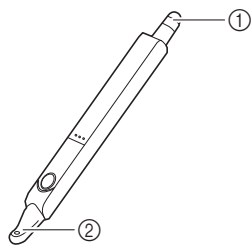

- ① Soft point for operating the screen
- ② Hard point for operating the projector

Installing a Battery in the Dual Purpose Stylus

A battery for the dual purpose stylus is not included with your machine. Use a new AAA alkaline battery (LR03).

Note

- Do not disassemble or modify the dual purpose stylus.
- Do not use metallic objects, such as tweezers or a metallic pen, when changing the battery.

IMPORTANT

- Remove the battery if you do not intend to use the dual purpose stylus for an extended period of time.

- 1 Slide the lid with your finger to remove it.

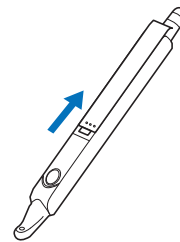

- 2 Install a new AAA alkaline battery (LR03) in the dual purpose stylus with the negative end (-) pointing up.

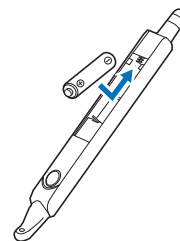

- 3 Close the lid.

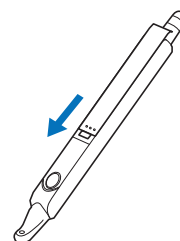

Operating the Projector with the Dual Purpose Stylus

Press the button to light the hard point of the dual purpose stylus. After the built-in camera detects the light, you can operate the projector with the dual purpose stylus.

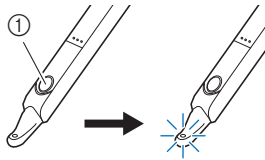

① Button

Note

- Do not put your hand, fabric or any object between the built-in camera and the light-emitting part of the dual purpose stylus, otherwise the built-in camera cannot detect the light from the dual purpose stylus.

Using the Dual Purpose Stylus Holder

Attach the dual purpose stylus holder to keep the dual purpose stylus with the machine. The right side of the holder can be used to hold the dual purpose stylus.



Dual purpose stylus holder

- 1** Firmly insert the dual purpose stylus holder into the hole.

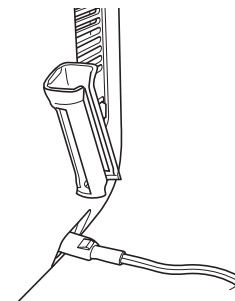
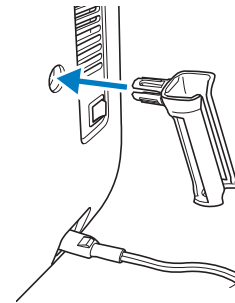

- 2** With the flat part of the dual purpose stylus facing to the machine, insert it into the dual purpose stylus holder.

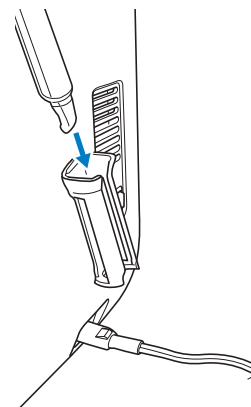

PROJECTOR FUNCTIONS (UTILITY STITCHES AND CHARACTER/DECORATIVE STITCHES)

Projection Area of Projector

When the machine is sewing utility stitches or character/decorative stitches, the projection area of the projector is as shown below.

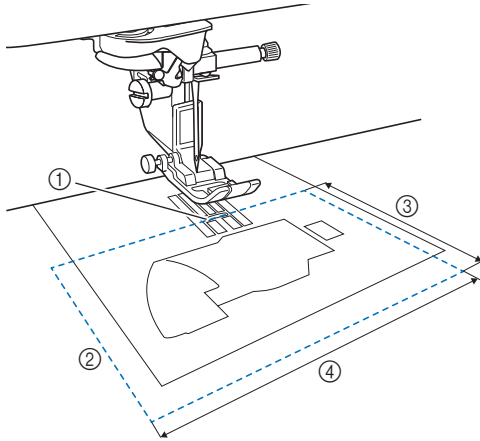

- ① Needle drop point
- ② Projection area
- ③ 7.6 cm (3 inches)
- ④ 12.7 cm (5 inches)

Projecting the Stitch Pattern with the Projector

Using the projector, the selected stitch pattern can be projected onto the fabric.

1 Select a stitch pattern.

2 Touch .

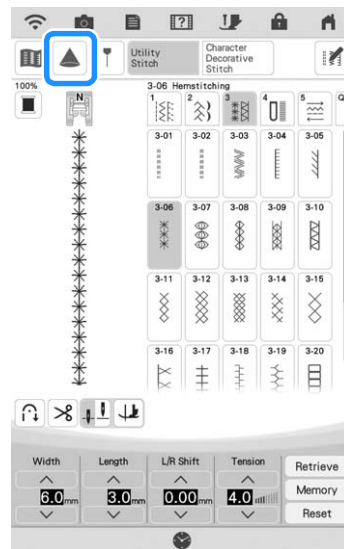

→ The selected stitch pattern and the adjustment keys are projected onto the fabric.

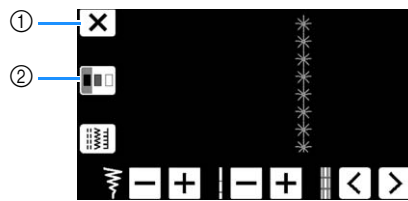

- ① Press with the dual purpose stylus to stop projection.
- ② Each press with the dual purpose stylus changes the [Background Color] setting.

Memo

- The setting can also be changed with [Background Color] in the machine settings screen.



Selecting a Stitch Pattern with the Dual Purpose Stylus



- 1 When the stitch pattern is projected onto the fabric, press  with the dual purpose stylus.



→ A stitch pattern can be selected.

Memo

- A stitch pattern cannot be selected from the LCD while a stitch pattern is being projected by the projector. In order to select a stitch pattern from the LCD, touch  in the screen.

- 2 Press  with the dual purpose stylus until the desired stitch pattern is displayed, and then press .

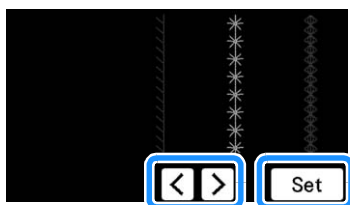

Editing a Stitch Pattern Selected with the Dual Purpose Stylus

The stitch width, stitch length and [L/R Shift] can be changed for the stitch pattern projected by the projector.

- 1 Use the dual purpose stylus to adjust the stitch width, stitch length and sewing position.

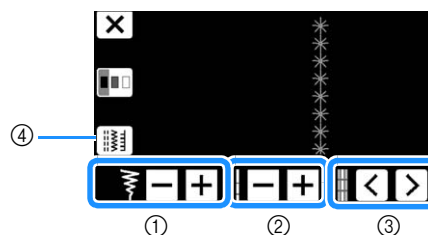

- ① Stitch width setting
- ② Stitch length setting
- ③ [L/R Shift] setting
- ④ Press to select a different stitch pattern.

→ The specified settings are applied to the projected stitch pattern.

Memo

- When the stitch selection screen appears again in the LCD, the settings change to those specified with the dual purpose stylus.

Projecting the Guidelines with the Projector

With the guideline function, sewing can easily be done by following the lines and marks projected onto the fabric.

1 Touch .

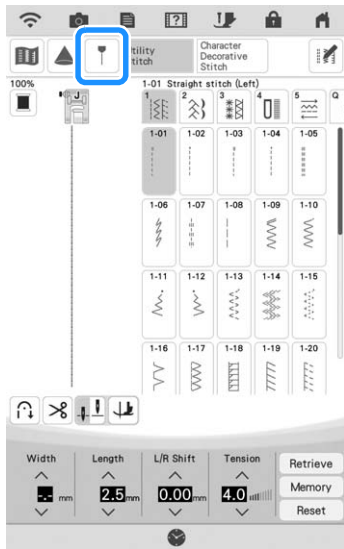

→ The guideline settings screen appears.

2 Specify the guideline settings.
Main guideline

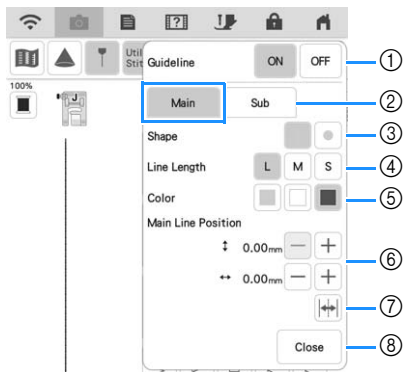

- ① If the guidelines will not be used, select [OFF].
- ② Select the guideline whose settings are to be specified.
- ③ Select a line or a point as the shape of the guideline marker.
- ④ Select the length of the main guideline.
- ⑤ Select the color of the main guideline.
- ⑥ Specify the position of the main guideline.
- ⑦ Touch to flip the main guideline position on the center needle position.
- ⑧ Touch to finish specifying the guideline settings.

Sub guideline 

A straight-line guideline is displayed.

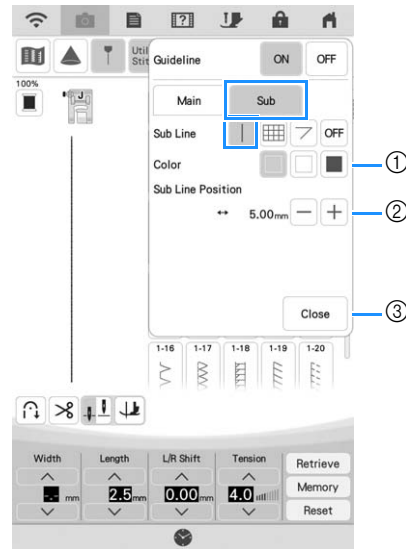

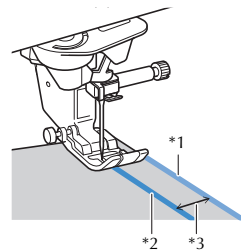

- ① Select the color of the sub guideline.
- ② Specify the sub guideline position (distance from the main guideline).



- *1 Sub guideline
- *2 Main guideline
- *3 Distance specified with [Sub Line Position]

Memo

- When  or  is selected, the position of the sub guideline is based on the position of the main guideline. In order to move the two guidelines without changing the spacing between the main guideline and the sub guideline, change the position of the main guideline.
- ③ Touch to finish specifying the guideline settings.

Sub guideline

A grid guideline is displayed.

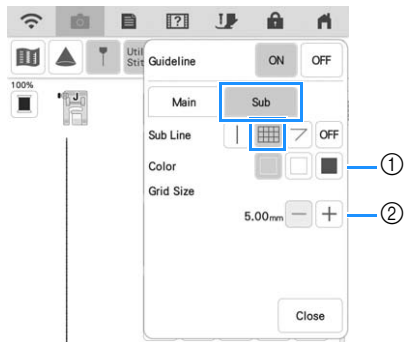

- ① Select the color of the sub guideline.
- ② Specify the grid size of the sub guideline.

Sub guideline

Guidelines for sewing angled quilt pieces are displayed.

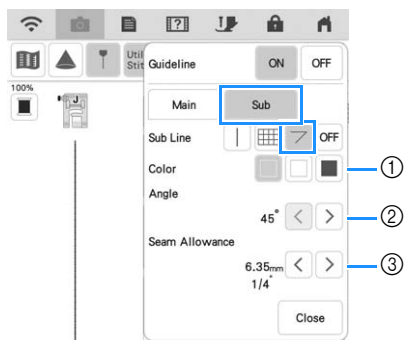

- ① Select the color of the sub guideline.
- ② Specify the angle of the sub guideline.
- ③ Specify the seam allowance of the sub guideline.

Sewing quilt pieces together with their right sides together (when the starting point of sewing is at the intersection of seam lines)

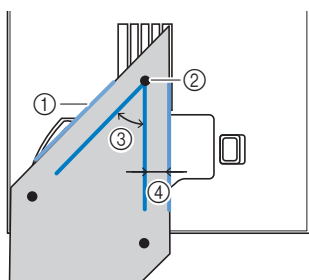

- ① Align the sub guideline with the edge of the quilt piece.
- ② Start sewing from the intersection with the main guideline.
- ③ Angle specified with [Angle]
- ④ Distance specified with [Seam allowance]

■ Piecing Using Guidelines

- 1 Select stitch Q-01 ([Piecing stitch (Middle)]), and then touch .
- 2 Make sure that the guideline position for [Main] aligns with the stitch pattern displayed in the screen.

Memo

- If [Initial Position] in the Sewing settings screen is set to , set [Main Line Position] to 3.50 mm in order to align the guideline with the middle needle position of the stitch pattern.

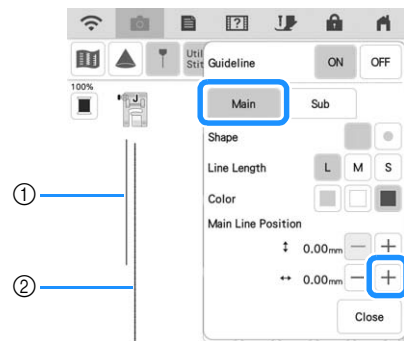

- ① Main guideline
- ② Stitch pattern

- 3 Set [Sub Line Position] of [Sub] to 6.35 mm (1/4 inch).

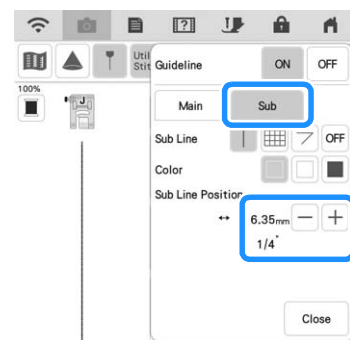

- 4 Align the edge of the fabric with the sub guideline and sew 6.35 mm (1/4 inch) seams.

Specifying the Sewing End Point



Note

- Using the same material and stitch pattern as your project, sew trial stitches to check the result. The machine's sewing end point may become misaligned in the following cases:
 - The end point sticker is loose.
 - The fabric was not sewn straight.
 - The fabric was pushed too hard during feeding.
 - Fabrics difficult to sew, such as heavyweight, quilted, stretchy, or thin fabrics, were used.

1 Select a stitch.

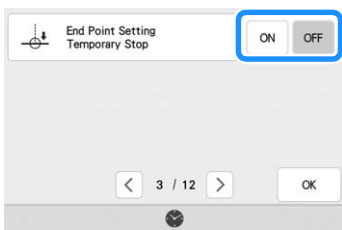
2 Touch , make sure that [Temporary Stop] in the machine settings screen is set to [OFF], and then touch .



3 Touch  to set [Guideline] to [ON]. Set the [Main] line horizontal position according to the selected stitch pattern. And then touch .

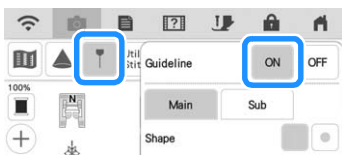

Memo

- If  is selected for [Sub], a grid will be displayed.

4 Touch .



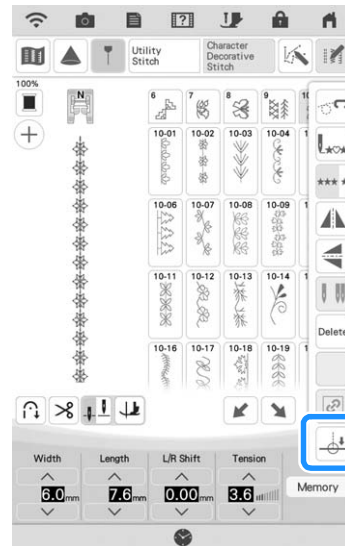

5 Touch .





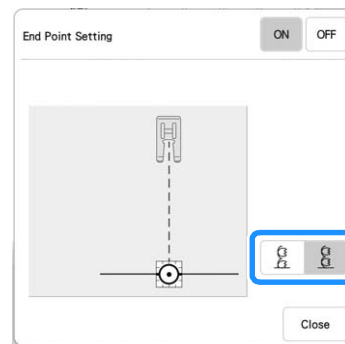

Memo

- If  appears in light gray and is not available, the sewing end point cannot be specified with the selected stitch pattern. Select a different stitch pattern.
- Automatic reinforcement stitching function and automatic thread cutting function cannot be used when using this function.

6 Touch   to select whether or not sewing is ended with a complete stitch pattern. If necessary, touch  after making your selection.



	The length of the stitch pattern is adjusted so that sewing will stop at the specified end point with a complete stitch pattern. If this key appears in light gray and is not available, this function cannot be used. This adjustment may cause the stitch pattern to be sewn slightly stretched vertically.	
	The end of stitching is not adjusted. When the end point is reached, sewing stops immediately, even if the stitch pattern is not complete.	

Memo

- If [End Point Setting] is set to [ON], the stitch pattern cannot be projected by the projector.
- To cancel [End Point Setting], set [End Point Setting] to [OFF], and then touch .

7 With a chalk pencil, mark the fabric with lines for sewing the stitch pattern and for the end of stitching.

8 Affix an end point sticker, avoiding the sewing area. Attach the end point sticker within 4 cm (approx. 1-1/2 inches) to the left or right of the chalkline where the end point for sewing has been drawn.

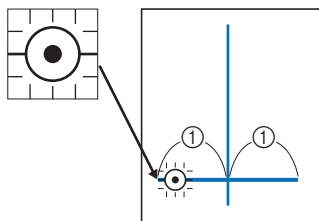

① 4 cm (Approx. 1-1/2 inches)

Memo

- If the end point sticker can be affixed to either left or right of the sewing position, we recommend affixing it to the left side.
- We recommend affixing the end point sticker as close as possible to the sewing position.
- If you cannot affix an end point sticker avoiding the sewing area, refer to “Temporary Stop Setting” on page 87.
- The horizontal guideline at the needle indicates the distance from the stitching line where the end point sticker can be affixed.

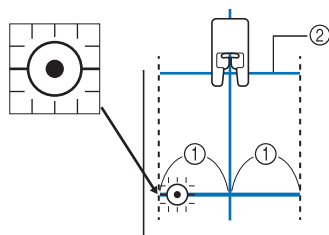

① 4 cm (Approx. 1-1/2 inches)

② Guideline

9 Place the fabric in the machine, and then lower the presser foot.

Note

- Before sewing, make sure that the end point sticker has not become detached. In addition, make sure that the end point sticker is not covered with your hand. Otherwise, the machine cannot detect the end point sticker.

10 Press the "Start/Stop" button to start sewing. When the foot controller is plugged in, press down on the foot controller. Gently guide the fabric to sew the stitching straight.

Note

- While making sure that the guidelines align with the lines drawn with the chalk pencil, sew the stitching straight, not at an angle.
- Do not forcefully feed the fabric. Otherwise, sewing may not stop correctly.

→ The machine stops at the specified end point automatically.

Memo

- If the stitch pattern could not be adjusted when  was set in step 6, the following message appears. Cancel [End Point Setting], and then select a different stitch or change the length of the stitch.

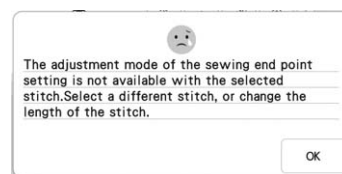



11 Peel off the end point sticker.

Temporary Stop Setting

If you cannot affix an end point sticker that avoids the sewing area, you can adjust the machine settings to temporarily stop sewing to allow the sticker to be removed as you approach the end point sticker.

1 Select a stitch.

2 Touch , set [Temporary Stop] in the machine settings screen to [ON], and then touch .



3 Perform steps 3 through 6 in “Specifying the Sewing End Point” on page 86.

- 4** With a chalk pencil, mark the fabric with lines for sewing the stitch pattern and for the end of stitching, and then affix an end point sticker.

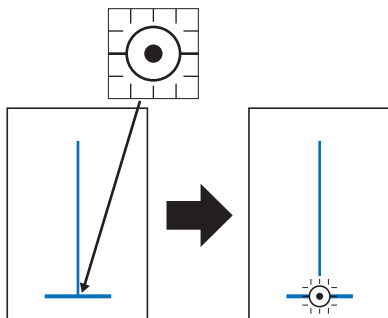

- 5** Perform steps **9** and **10** in “Specifying the Sewing End Point” on page 86.

→ When the needle approaches the mark, the machine stops, and the following message appears.

- 6** Peel off the end point sticker, and then touch .



- 7** Press the “Start/Stop” button again. When the foot controller is plugged in, press down on the foot controller.

→ The machine finishes sewing the stitch pattern, then stops.



Chapter **3**









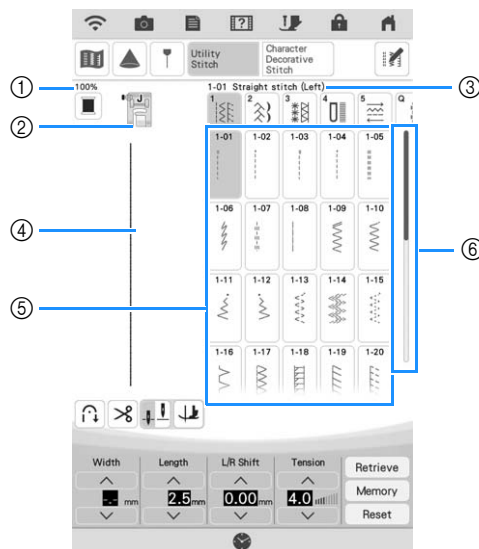



Utility Stitches

SELECTING UTILITY STITCHES

Utility Stitch LCD Screen

Touch a key with your finger to select the stitch pattern, to select a machine function, or to select an operation indicated on the key.



No.	Display	Key Name	Explanation	Page
①	100%	Stitch pattern display size	Shows the approximate size of the stitch pattern selected.	-
②		Presser foot display	Shows the presser foot code. Attach the presser foot indicated in this display before sewing. * Advanced monogramming foot "N+" is displayed as "N" on the screen.	57
③	1-01 Straight stitch (Left)	Selected stitch display	Shows the name and code number of the selected stitch.	94
④		Stitch preview	Shows a preview of the selected stitch. When shown at 100%, the stitch appears in the screen at nearly its actual size. Touch  to display the stitch preview and the camera view together to check how the stitch will be sewn on the actual fabric.	79, 94
⑤		Stitch selection screen	Touch the key for the stitch pattern you want to sew. Use         to change to different stitch groups.	93, 94
⑥		Scroll bar	Slide the scroll bar to move the pages of stitch selection screen.	-









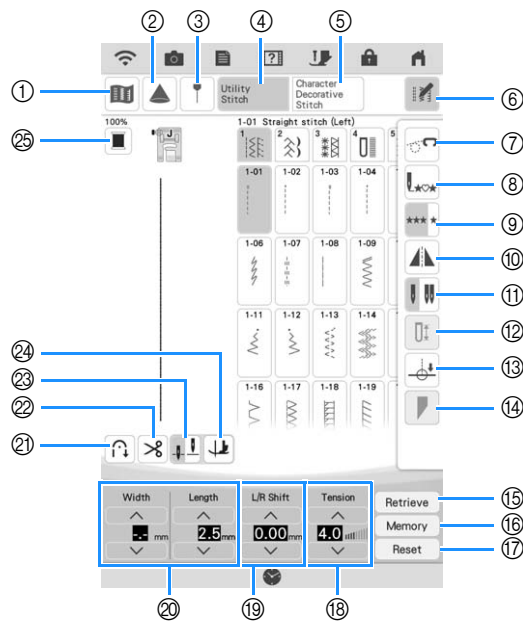







* All key functions of the LCD are explained in the "Key Functions" table on the following page.





















Key Functions

Memo

- Editing function keys are found after touching .



No.	Display	Key Name	Explanation	Page
①		Image key	Touch this key to display an enlarged image of the selected stitch pattern.	95
②		Projector key	Touch this key to use projector functions.	82
③		Guideline marker key	Touch this key to display or set the guideline marker for the sewing line. The guideline marker makes quilt piecing or aligning stitching on the fabric edge easier.	84
④		Utility stitch key	Touch this key to select a straight stitch, zigzag stitch, buttonhole, blind hem stitch, or other stitches commonly used in garment construction.	94
⑤		Character/Decorative stitch key	Touch this key to select character or decorative stitch patterns.	146
⑥		Edit key	Touch this key to display editing function keys on the screen.	-
⑦		Free motion mode key	Touch this key to enter free motion sewing mode. The presser foot is raised to an appropriate height and the feed dog is lowered for free motion quilting.	112
⑧		Back to beginning key	When sewing is stopped, touch this key to return to the beginning of the stitch.	95
⑨		Single/Repeat sewing key	Touch this key to choose single stitches or continuous stitches.	95
⑩		Mirror image key	Touch this key to create a mirror image of the selected stitch pattern. If the key display is light gray, a mirror image of the selected stitch pattern cannot be sewn.	94
⑪		Needle mode selection key (single/double)	Touch this key to select twin needle sewing mode. The sewing mode changes between single needle mode and twin needle mode each time you touch the key. If the key display is light gray, the selected stitch pattern cannot be sewn in the twin needle mode.	50
⑫		Slit length key	Touch this key to manually set the buttonhole length when a buttonhole stitch is selected.	132
⑬		End point setting key	Touch this key to specify the sewing end point.	86
⑭		Stitch tapering key	Touch this key to change the start and end angles of the stitch pattern.	142
⑮		Retrieve key	Touch this key to retrieve a saved stitch pattern.	96
⑯		Manual memory key	Change the stitch pattern settings (stitch width and stitch length, thread tension, etc.), then save them by touching this key.	96

No.	Display	Key Name	Explanation	Page
17		Reset key	Touch this key to return the selected stitch pattern saved settings to the default settings.	72-74
18		Thread tension key	Shows the automatic thread tension setting of the currently selected stitch pattern. You can use  and  to change the thread tension settings.	74
19		[L/R Shift] key	Touch  to shift the stitch pattern to the right or touch  to shift the stitch pattern to the left. This feature is not available for all stitch patterns. Only those applicable will be shifted. The machine default setting is highlighted.	73
20		Stitch width and stitch length key	Shows the zigzag width and stitch length settings of the currently selected stitch pattern. You can use  and  to adjust the zigzag width and stitch length settings.	72, 73
21		Automatic reinforcement stitch key	Touch this key to use the automatic reinforcement stitching (reverse stitching) setting. If you select this setting before sewing, the machine will automatically sew reinforcement stitches at the beginning and end of sewing (depending on the stitch pattern, the machine may sew reverse stitches).	66
22		Automatic thread cutting key	Touch this key to set the automatic thread cutting function. Set the automatic thread cutting function before sewing to have the machine automatically sew reinforcement stitches at the beginning and end of sewing (depending on the stitch pattern, the machine may sew reverse stitches) and trim the threads after sewing.	75
23		Needle position setting key	Touch this key to select the needle stop position to be up or down. You can also check the needle mode setting (single or twin).  Single needle/down position  Single needle/up position  Twin needle/down position  Twin needle/up position	50, 76
24		Pivot key / Auto Up key	The pivot key appears when the needle position setting key is set to  . Touch this key to select the pivot function. When the pivot function is selected, stopping the machine lowers the needle and slightly raises the presser foot automatically. In addition, when sewing is restarted, the presser foot is automatically lowered. The auto up key appears when the needle position setting key is set to  . Touch the auto up key to raise the presser foot when the machine is stopped.	68, 76
25		Thread color change key	Touch this key to change the thread color displayed on the screen.	95

Stitch Selection Screens

Straight/Overcasting

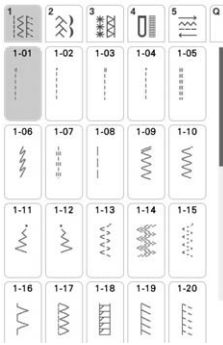

Decorative Stitches

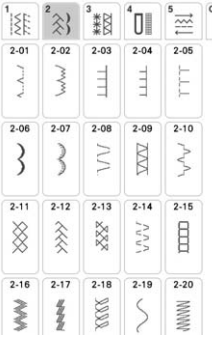

Heirloom Stitches

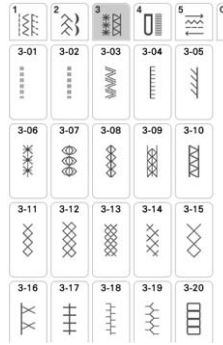

Buttonholes/Bar tacks

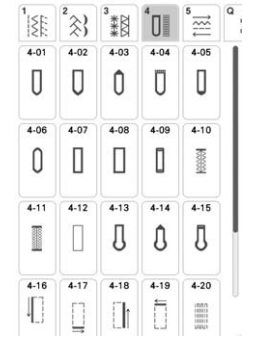

Multi-directional Sewing

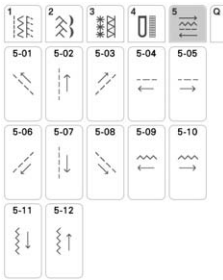

Quilting Stitches

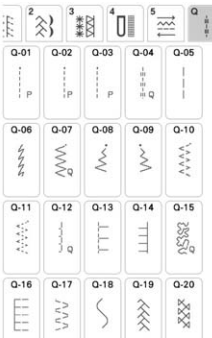

Other Stitches

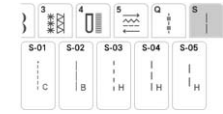

Stitch Tapering

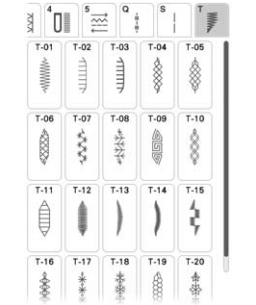

Selecting a Stitch

- 1 Turn the main power to ON and touch  to display the utility stitches.

→ Either [1-01 Straight stitch (Left)] or [1-03 Straight stitch (Middle)] is selected, depending on the setting selected in the settings screen.

- 2 Select the category of the stitch pattern you want to sew.

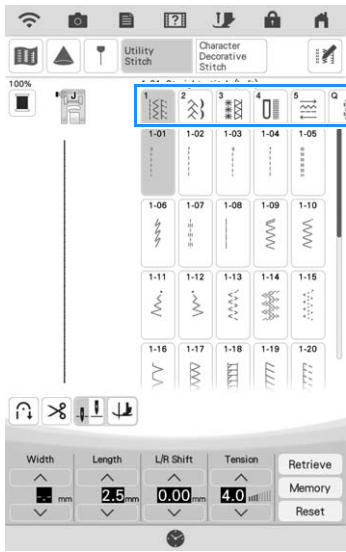

 **Memo**

- Swipe the key of a category sideways to display hidden categories.

- 3 Touch the key of the stitch you want to sew.

 **Memo**



- For details on each stitch, refer to “STITCH SETTING CHART” on page 198.

Using the Mirror Image Key

Depending on the type of utility stitch you select, you may be able to sew a horizontal mirror image of the stitch.

 **Memo**

- If  is light gray after you select a stitch, you cannot create a horizontal mirror image of the selected stitch due to the type of stitch or type of presser foot recommended (this is true of buttonholes, multi-directional sewing, and others).



Touch  then  to create a horizontal mirror image of the selected stitch.

The key will display as .



■ Returning to the Beginning of the Stitch Pattern



Even if you stopped stitching while sewing, you can return to the beginning of the stitch pattern. This function is useful after trial sewing or when the stitching is sewn incorrectly.

Touch  then  before start sewing to return to the beginning of the stitch.

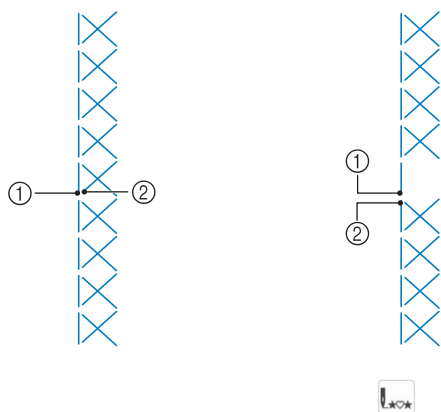
- ① Stop stitching
- ② Re-start stitching



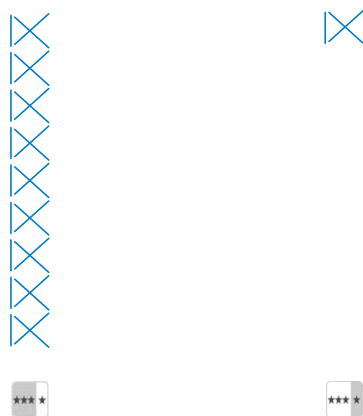

■ Sewing Continuous/Single Stitch Sewing

Touch  then  to select continuous sewing or single stitch sewing.



■ Using the Image Key

You can display an image of the selected stitch. You can check and change the colors of the image of the screen.

- 1 Touch .
 - An image of the selected stitch is displayed.
- 2 Touch  to change the thread color of the stitch on the screen.

* Touch  to display an enlarged image of the stitch.

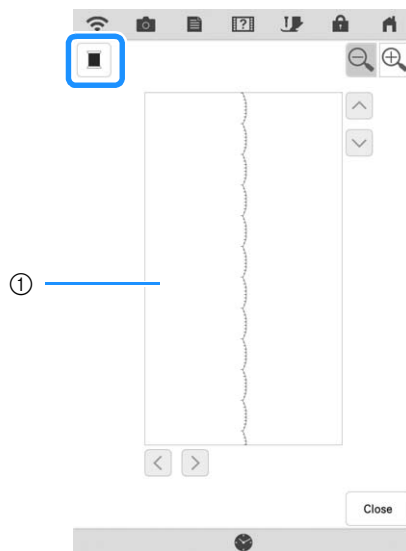

① Stitch screen

Memo

- The color changes every time you touch .
- Touch arrow keys to view any part of the image that extends out of the viewable display area.

- 3 Touch  to go back to the original screen.

Saving Your Stitch Settings

Mirror image, twin needle, stitch width, stitch length, L/R Shift and thread tension settings can be saved for each stitch pattern. Five sets of settings can be saved for a single stitch.

■ Saving Settings

- 1 Select a stitch. (Example: )
- 2 Specify your preferred settings.

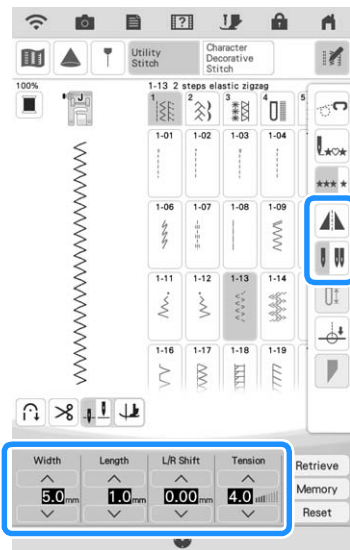

- 3 Touch **Memory**.

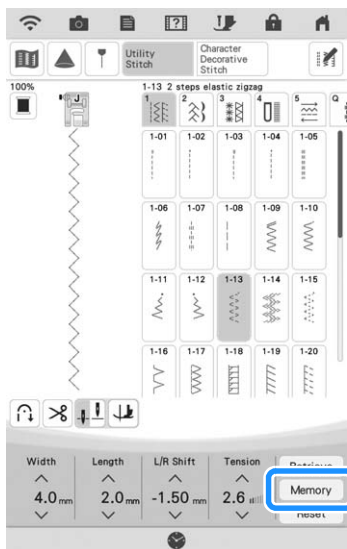

→ The settings are saved and the original screen automatically appears.

📖 Memo

- Touch **Reset** and then **Memory** to return the selected stitch pattern saved settings to the default settings.
- If you try to save settings when there are already 5 sets of settings saved for a stitch, delete a setting referring to “Retrieving Saved Settings” on page 96.

■ Retrieving Saved Settings

- 1 Select a stitch.
- 2 Touch **Retrieve**.
- 3 Touch the numbered key of the settings to be retrieved and then touch **Retrieve**.

* Touch **OK** to return to the original screen without retrieving settings.

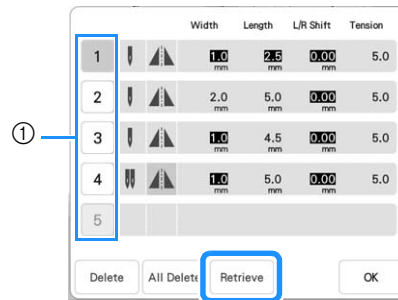

- ① Numbered keys









→ The selected settings are retrieved, and the original screen automatically appears.

📖 Memo

- To save new settings when there are already 5 sets of settings saved for a stitch, touch **Retrieve**. Touch the numbered key of the setting to be deleted. Touch **Delete** and then **OK**. Touch **OK** and then **Memory**. The new setting will be saved in place of the recently deleted setting.
- You can delete all the saved settings by touching **All Delete**.

SEWING THE STITCHES

Straight Stitches

Stitch	Stitch name	Presser foot
1-01	Straight stitch (Left)	
1-02	Straight stitch (Left)	
1-03	Straight stitch (Middle)	
1-04	Straight stitch (Middle)	
1-05	Triple stretch stitch	
1-06	Stem stitch	
1-07	Decorative stitch	
1-08	Basting stitch	

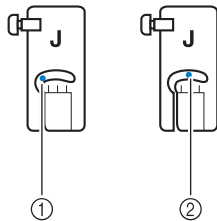

- ① Left needle position
② Middle needle position

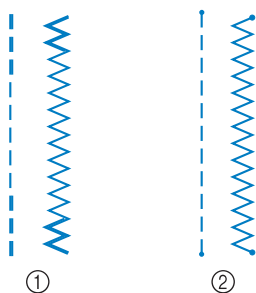

- ① Reverse stitch
② Reinforcement stitch

Memo

- For details on reverse/reinforcement stitches, refer to “Automatic Reinforcement Stitching” on page 66.

1 Select a stitch.

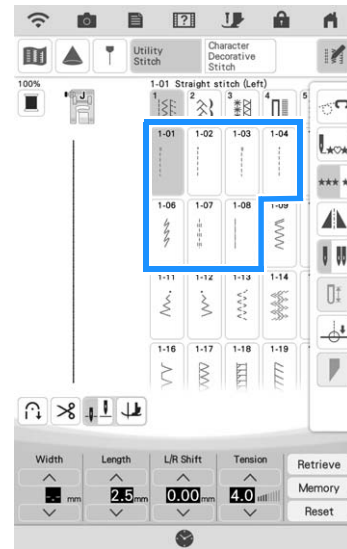

2 Attach presser foot “J”.

- * Attach advanced monogramming foot “N+” when you select  (1-07) for optimal performance on some fabrics.

3 Hold the thread tail and fabric with your left hand, and press the “Needle Position” button with your right hand to insert the needle into the fabric.

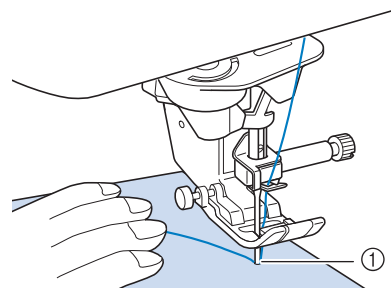

- ① Sewing start position

- 4** Lower the presser foot. Sew 3 to 5 stitches and hold the “Reverse Stitch” button or hold the “Reinforcement Stitch” button to sew 3-4 stitches.

→ The machine sews reverse stitches or reinforcement stitches.

- 5** Press the “Start/Stop” button to sew forward.

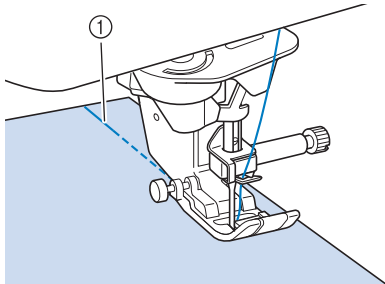

① Reverse stitches or reinforcement stitches

→ The machine will begin sewing slowly.

⚠ CAUTION

- Be sure the needle does not strike a basting pin, or any other objects, during sewing. The thread could tangle or the needle could break, causing injury.

- 6** When sewing is completed, hold the “Reverse Stitch” button or the “Reinforcement Stitch” button to sew 3-4 reverse stitches or reinforcement stitches at the end of the seam.

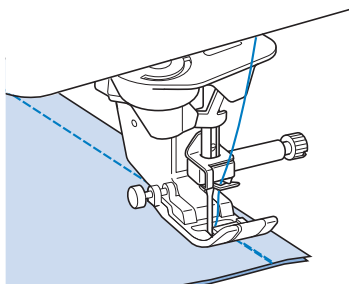

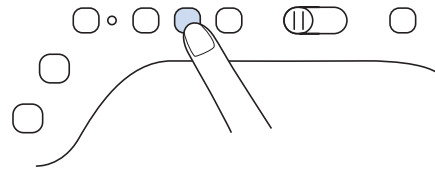

- 7** After sewing, press the “Thread Cutter” button to trim the threads.



📌 Memo

- When the automatic thread cutting and automatic reinforcement stitch keys on the screen are selected, reverse stitches or reinforcement stitches will be sewn automatically at the beginning of sewing when the “Start/Stop” button is pressed. Press the “Reverse Stitch” button or the “Reinforcement Stitch” button to sew reverse stitches or reinforcement stitches and to trim the thread automatically at the end of sewing.

■ Changing the Needle Position (Left or Middle Needle Position Stitches Only)

When you select left or middle needle position stitches, you can use  and  in the [L/R Shift] display to change the position of the needle. Match the distance from the right edge of the presser foot to the needle with the L/R Shift, then align the edge of the presser foot with the edge of the fabric during sewing for an attractive finish.

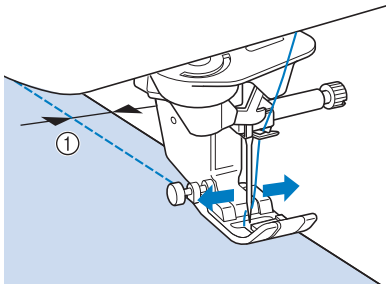

① L/R Shift

Example: Left/Middle needle position stitches

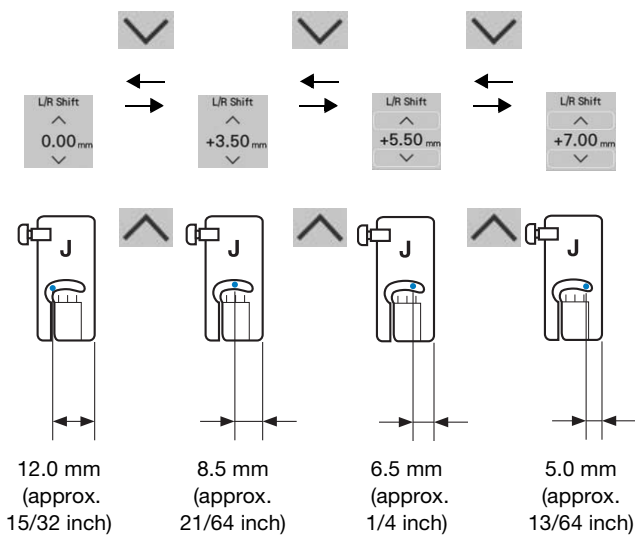

Memo

- Stitch Q-01 will not permit using the L/R Shift function.
- When [Width Control] in the Sewing settings screen is set to [ON], the needle position of a straight stitch can be changed with the sewing speed controller ([L/R Shift]).

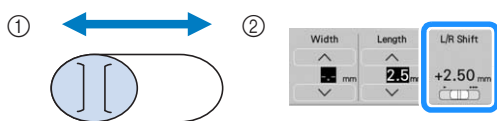

- ① Shift the stitch pattern to the left.
- ② Shift the stitch pattern to the right.

■ Aligning the Fabric with a Mark on the Needle Plate or Bobbin Cover (with Mark)

While sewing, align the edge of the fabric with the 16 mm (approx. 5/8 inch) mark on the needle plate or bobbin cover (with mark) depending on the needle position (left or middle (center) needle position stitches only).

For stitches with a left needle position (L/R Shift: 0.00 mm)

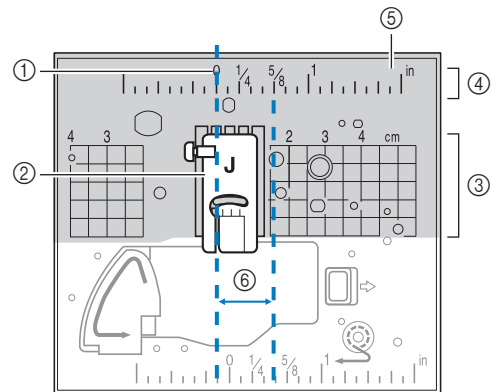

- ① Seam
- ② Presser foot
- ③ Centimeters
- ④ Inches
- ⑤ Needle plate
- ⑥ 16 mm (5/8 inch)

For stitches with a middle (center) needle position (L/R Shift: 3.50 mm)

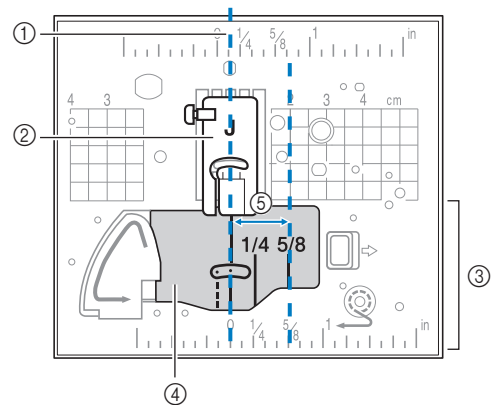

- ① Seam
- ② Presser foot
- ③ Inches
- ④ Bobbin cover (with mark)
- ⑤ 16 mm (5/8 inch)

■ Using the Straight Stitch Needle Plate and the Straight Stitch Foot

The straight stitch needle plate and the straight stitch foot can only be used for straight stitches (middle needle position stitches). Use the straight stitch needle plate and the straight stitch foot when sewing thin fabrics or when sewing small pieces which tend to sink into the hole of the regular needle plate during sewing. The straight stitch foot is perfect to reduce puckering on lightweight fabrics. The small opening on the foot provides support for the fabric as the needle travels through the fabric.

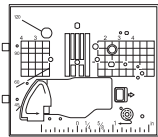
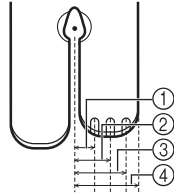

- ① 2.25 mm (1/8 inch)
- ② 4.25 mm (3/16 inch)
- ③ 6.25 mm (1/4 inch)
- ④ 8.5 mm (5/16 inch)

⚠ CAUTION

- Always use the straight stitch foot in combination with the straight stitch needle plate. Otherwise, the needle may break and cause injury.

- 1 Press the "Needle Position" button to raise the needle, raise the presser foot and turn the main power to OFF. And then unplug the machine.
- 2 Remove the needle and the presser foot (page 54, page 57).
- 3 Remove the flat bed attachment or the embroidery unit if either are attached.
- 4 Slide the needle plate lever toward you.

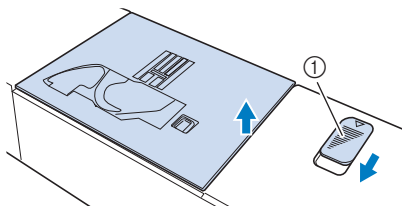

- ① Slide toward you.
- The needle plate opens.

- 5 Slide out the regular needle plate with your right hand to remove it.

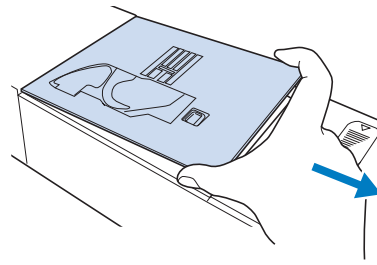

- 6 Insert the tabs on the straight stitch needle plate into the notches in the machine.

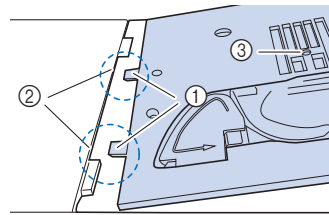

- ① Tabs
- ② Notches
- ③ Round hole

- 7 Press down on the right side of the straight stitch needle plate to secure it.

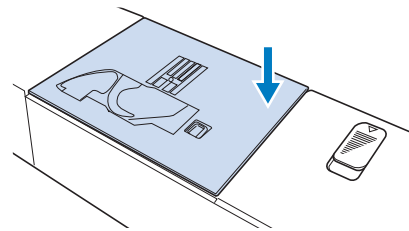

- 8 If necessary, attach the flat bed attachment.
- 9 Insert needle and attach the straight stitch foot. (page 54, page 57)

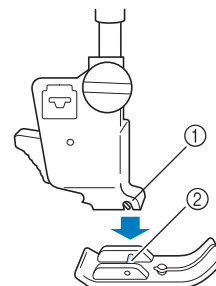

- ① Notch
- ② Pin

10 Select any of the straight stitches.**Memo**

- Selecting unavailable stitches will cause an error message to be displayed.
- When the straight stitch needle plate is on the machine, the needle will automatically move to the middle position.

Note

- Slowly rotate the handwheel toward you (counterclockwise) before sewing and make sure that the needle is not contacting the straight stitch foot and straight stitch needle plate.

11 Start sewing.

- * After sewing, make sure to turn off the machine and to remove the straight stitch needle plate and the straight stitch foot. Reinstall the regular needle plate and the presser foot "J".

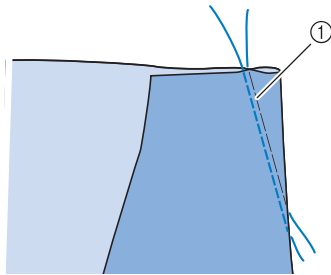
Dart Seam**1** Select  and attach presser foot "J".**2** Sew a reverse stitch at the beginning of the dart and then sew from the wide end to the other end without stretching the fabric.

① Basting

3 Cut the thread at the end leaving 50 mm (approx. 2 inches), and then tie both ends together.

- * Do not sew a reverse stitch at the end.

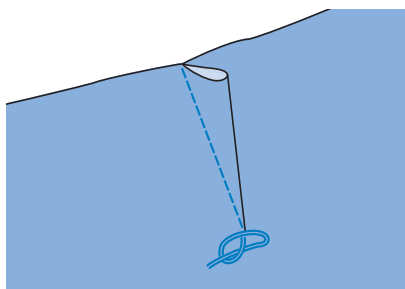
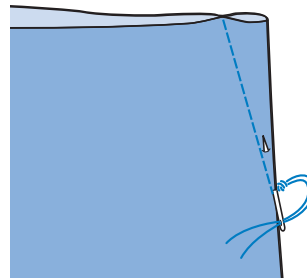
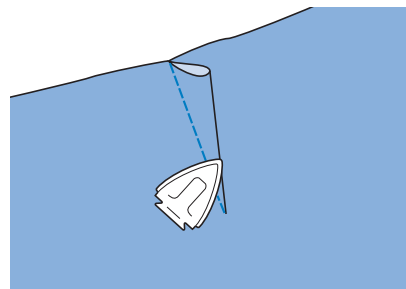
**4** Insert the ends of the thread into the dart with a hand sewing needle.**5** Iron the dart to one side so that it is flat.

Gathering

Use on waists of skirts, sleeves of shirts, etc.

- 1 Select a straight stitch and attach presser foot "J".

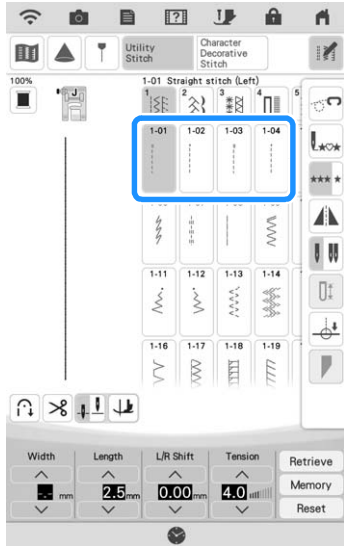

- 2 Set the stitch length to 4.0 mm (approx. 5/32 inch) and the thread tension to approximately 2.0 (weaker tension).
- 3 Pull the bobbin and upper threads out by 50 mm (approx. 2 inches). (page 46)

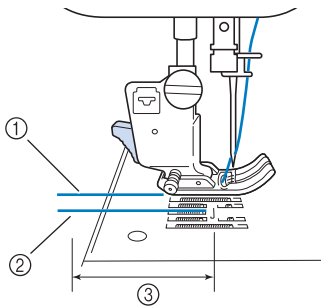

- ① Upper thread
- ② Bobbin thread
- ③ About 5 cm (approx. 2 inches)

- 4 Sew two rows of straight stitches parallel to the seam line, then trim excess thread leaving 50 mm (approx. 2 inches).

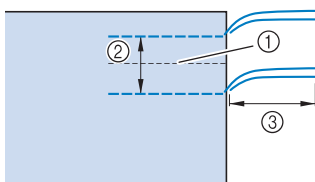

- ① Seam line
- ② 10 to 15 mm (approx. 3/8 inch to 9/16 inch)
- ③ About 50 mm (approx. 2 inches)

- 5 Pull the bobbin threads to obtain the desired amount of gather, then tie the threads.

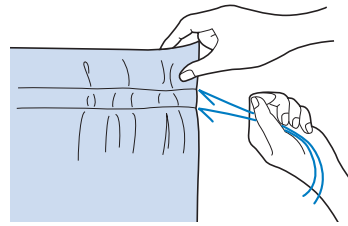

- 6 Smooth the gathers by ironing them.

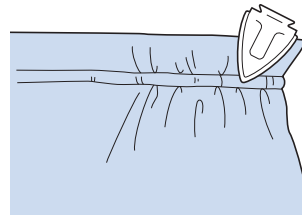

- 7 Sew on the seam line and remove the basting stitch.

Flat Fell Seam

Use for reinforcing seams and finishing edges neatly.

- 1 Select  and attach presser foot "J".
- 2 Sew the seam line, then cut half of the seam allowance from the side on which the flat fell seam will lie.

* When the automatic thread cutting and automatic reinforcement stitching are preset, reverse stitches will be sewn automatically at the beginning of sewing. Press the "Reinforcement Stitch" button to sew a reinforcement stitch and trim the thread automatically at the end of sewing.

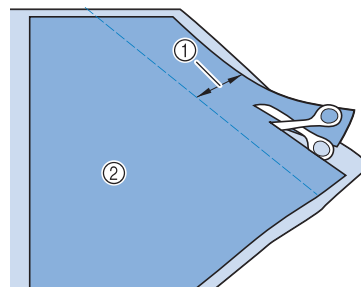

- ① About 12 mm (approx. 1/2 inch)
- ② Wrong side

3 Spread the fabric out along the seam.

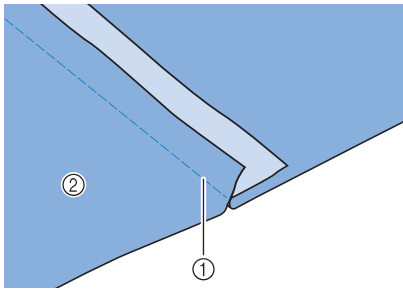

- ① Seam
- ② Wrong side

4 Lay both seam allowances on the side of the shorter seam (cut seam) and iron them.

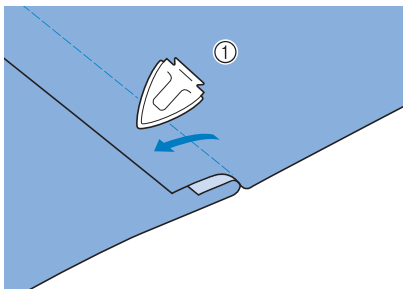

- ① Wrong side

5 Fold the longer seam allowance around the shorter one, and sew the edge of the fold.

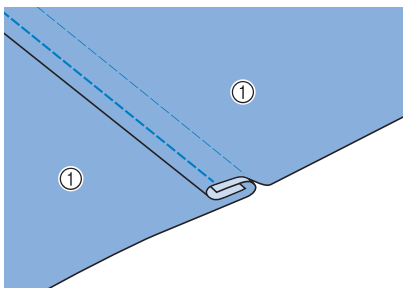

- ① Wrong side
- Finished flat fell seam

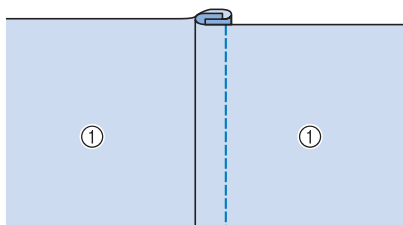

- ① Surface

Pintuck

1 Mark along the folds on the wrong side of the fabric.

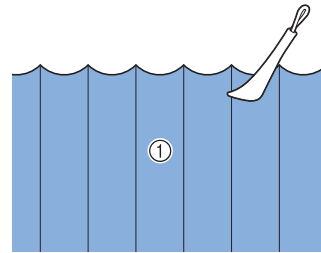

- ① Wrong side

2 Turn the fabric and iron the folded parts only.

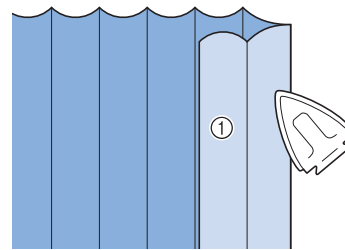

- ① Surface

3 Select and attach presser foot "1".

4 Sew a straight stitch along the fold.

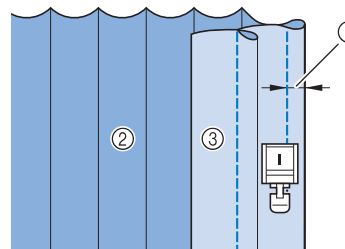

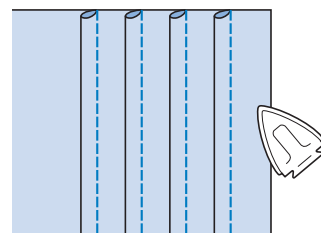

- ① Width for pintuck
- ② Wrong side
- ③ Surface

5 Iron the folds in the same direction.



Zigzag Stitches

Zigzag stitches are useful for overcasting, appliqué, patchwork, and many other applications.

Stitch	Stitch name	Presser foot
1-09	Zigzag stitch	
1-10	Zigzag stitch	
1-11	Zigzag stitch (Right)	
1-12	Zigzag stitch (Left)	

- 1 Select a stitch.
- 2 Attach presser foot "J".

Overcasting (Using a Zigzag Stitch)

Sew the overcasting along the edge of the fabric while positioning the right-hand side needle drop point just outside the edge of the fabric.

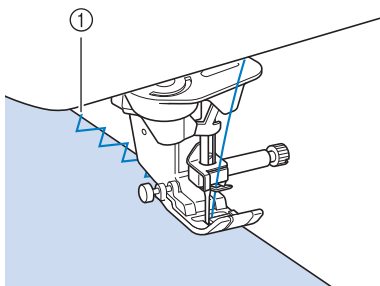

① Needle drop position

Appliqué (Using a Zigzag Stitch)

Attach the appliqué material using a temporary spray adhesive or basting, and then sew it.

- * Sew a zigzag stitch while positioning the right-hand side needle drop point just outside the edge of the fabric.

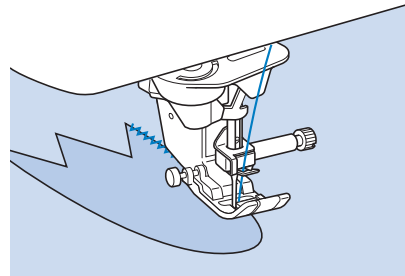

Memo

- Sewing with tear-away stabilizer under the base fabric will provide the best results.

Patchwork (for Crazy Quilting)

Turn back the desired width of fabric and position it over the lower fabric, then sew so that the stitch bridges both pieces of fabric.

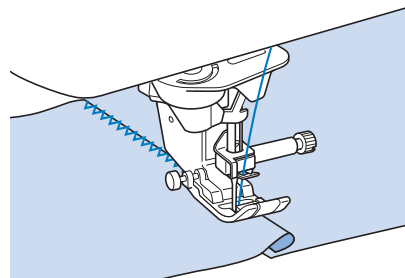

Sewing Curves (Using a Zigzag Stitch)

Shorten the stitch length setting to obtain a fine stitch. Sew slowly, keeping the seams parallel with the fabric edge as you guide the fabric around the curve.

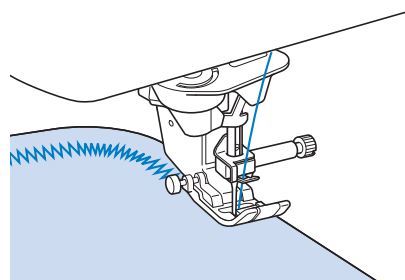

■ Cord Guide Bobbin Cover (Using a Zigzag Stitch)

- 1 Remove the bobbin cover from the machine. (page 44)
- 2 Thread the gimp thread through the hole in the cord guide bobbin cover from bottom to top. Position the thread in the notch at the back of the cord guide bobbin cover.

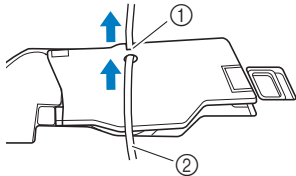

- ① Notch
② Gimp thread

- 3 Snap the cord guide bobbin cover into place, making sure that the gimp thread can be fed freely.

* Make sure there are no restrictions when feeding the thread.

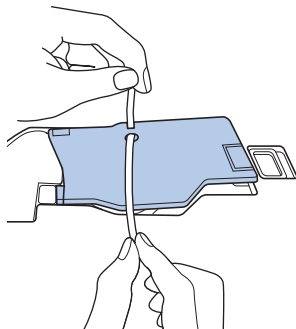

- 4 Set the zigzag width from 2.0-2.5 mm (approx. 1/16 - 3/32 inch).
- 5 Attach advanced monogramming foot "N+".
- 6 Position the fabric right side up on top of the cord and place the cord to the rear of the machine under the presser foot.

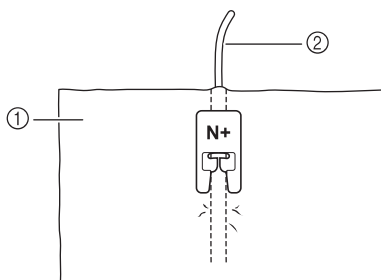

- ① Fabric (right side)
② Gimp thread

- 7 Lower the presser foot and start sewing to make a decorative finish.

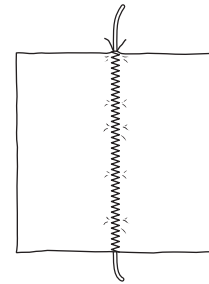

Elastic Zigzag Stitches

Use elastic zigzag stitches for tape attaching, overcasting, darning, or a wide variety of other uses.

Stitch	Stitch name	Presser foot
1-13	2 steps elastic zigzag	
1-14	2 steps elastic zigzag	
1-15	3 steps elastic zigzag	

- 1 Select a stitch.
- 2 Attach presser foot "J".

■ Tape Attaching

While stretching the tape flat, sew it to the fabric.

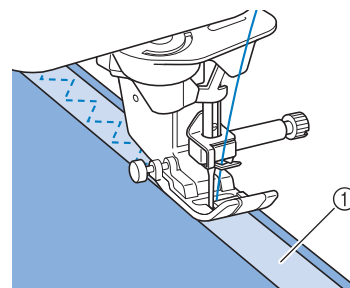

- ① Tape

Overcasting

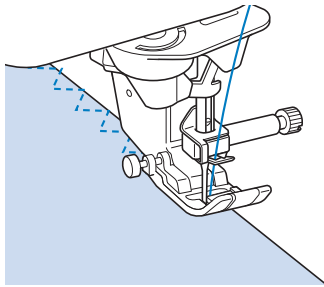

Use this stitch to sew overcasting on the edge of stretch fabrics. Sew the overcasting along the edge of the fabric while positioning the right-hand side needle drop point just outside the edge of the fabric.



Overcasting

Use for the edge of seams in skirts or trousers, and the edge of all cuttings.

Overcasting Using Presser Foot "G"

Stitch	Stitch name	Presser foot
1-16	Overcasting stitch	
1-17	Overcasting stitch	
1-18	Overcasting stitch	

1 Select a stitch and attach presser foot "G".

CAUTION

- When using overcasting foot "G", be sure to select a stitch that can be used with overcasting foot "G". If you sew with the incorrect stitch, the needle may strike the presser foot and break, and may cause injury.

2 Lower the presser foot so that the presser foot guide is set flush against the edge of the fabric.

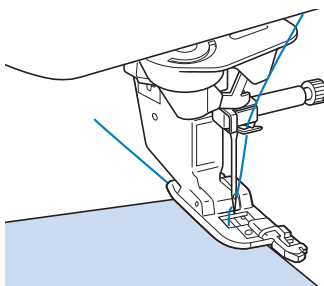

3 Rotate the handwheel toward you (counterclockwise). Check that the needle does not touch the presser foot.

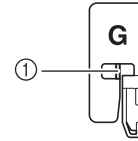

① The needle should not touch the center bar

4 Sew along the presser foot guide.

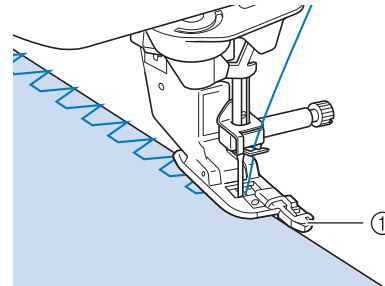

① Guide

5 Press the "Start/Stop" button to stop sewing when you are finished, and raise the presser foot and needle to remove the fabric by pulling it back.

IMPORTANT



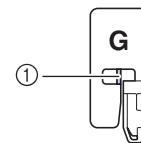



- Pull the fabric to the back of the machine after finished sewing. By pulling the fabric to the front or side, the center bar of the presser foot "G" may break.



① Center bar

- If thread is tangled on the presser foot, remove the entangled thread, and then raise the presser foot lever to remove the presser foot. If the presser foot is raised while entangled with thread, the presser foot may be damaged.

Overcasting Using Presser Foot “J”

Stitch	Stitch name	Presser foot
1-19	Overcasting stitch	
1-20	Overcasting stitch	
1-21	Overcasting stitch	
1-22	Overcasting stitch	
1-23	Single diamond overcast	
1-24	Single diamond overcast	

- 1 Select a stitch and attach presser foot “J”.
- 2 Sew with the needle dropping slightly off the edge of the fabric.

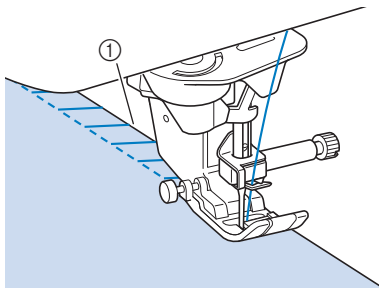

① Needle drop position

Note







































- Fine adjustment of the stitching on the fabric can be done with [L/R Shift]. Before sewing your project, be sure to sew trial stitches using the same conditions as in the actual project.



























































Quilting









































You can make beautiful quilts quickly and easily with this machine. When making a quilt, you will find it convenient to use the knee lifter and foot controller to free your hands for other tasks (“Using Advanced Multi-Function Foot Controller” on page 63 and /or “Using the Knee Lifter” on page 77).

The 40 quilting stitches Q-01 through Q-40, stitches S-03 through S-05 and the utility stitches with “P” or “Q” indicated on their key are useful for quilting.

The “P” or “Q” at the bottom of the key display indicates that these stitches are intended for (“Q”) quilting and (“P”) piecing.

Stitch	Stitch name	Presser foot	
			
Q-01 P	Piecing stitch (Middle)		
Q-02 P	Piecing stitch (Right)		
Q-03 P	Piecing stitch (Left)		
Q-04 Q	Hand-look quilting (Middle)		
Q-05	Basting stitch		
Q-06	Stem stitch		
Q-07 Q	Quilting appliqué zigzag stitch		
Q-08	Zigzag stitch (Right)		
Q-09	Zigzag stitch (Left)		
Q-10	2 steps elastic zigzag		
Q-11	3 steps elastic zigzag		
Q-12 Q	Quilting appliqué stitch		
Q-13	Shell tuck edge		
Q-14	Blanket stitch		
Q-15	Quilting stippling		
Q-16	Overcasting stitch		
Q-17	Tape attaching		
Q-18	Serpentine stitch		

Stitch	Stitch name	Presser foot	
			
	Feather stitch		
	Fagoting cross stitch		
	Couching stitch		
	Patchwork double overlock stitch		
	Smocking stitch		
	Rick-rack stitch		
	Decorative stitch		
	Decorative stitch		
	Hemstitching		
	Hemstitching		
	Single diamond overcast		
	Overcasting stitch		
	Appliqué stitch		
	Blanket stitch		
	Decorative stitch		
	Decorative stitch		
	Decorative stitch		
	Decorative stitch		
	Decorative stitch		

Stitch	Stitch name	Presser foot	
			
	Decorative stitch		
	Decorative stitch		
	Decorative stitch		
	Piecing stitch (Right)		
	Piecing stitch (Middle)		
	Piecing stitch (Left)		
	Hand-look quilting		
	Quilting appliqué zigzag stitch		
	Quilting appliqué stitch		
	Quilting stippling		
	Hand-look quilting		
	Hand-look quilting		
	Hand-look quilting		

 **Memo**

- When a stitch pattern in the quilting stitches category (only quilting stitches marked with “Q”) is selected, a finer stitch width or L/R Shift can be set than that available with stitch patterns in other categories.

■ Piecing

Sewing two pieces of fabric together is called piecing. When cutting pieces for quilt blocks, make sure the seam allowance is 6.5 mm (approx. 1/4 inch).

1 Select  or  and attach presser foot “J”.

2 Align the edge of the fabric with the edge of the presser foot, and start sewing.

- * To sew a 6.5 mm (approx. 1/4 inch) seam allowance along the right edge of the presser foot with  selected, the L/R Shift should be set to 5.50 mm (approx. 7/32 inch).

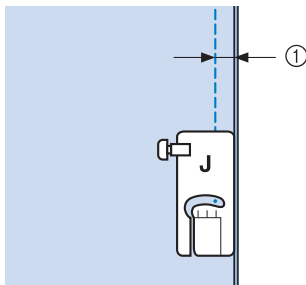

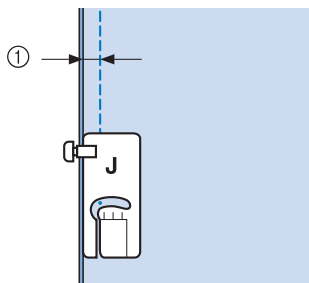

① 6.5 mm (approx. 1/4 inch)

- * To sew a 6.5 mm (approx. 1/4 inch) seam allowance along the left edge of the presser foot with  selected, the L/R Shift should be set to 1.50 mm (approx. 1/32 inch).



① 6.5 mm (approx. 1/4 inch)

- * To change the needle position, use  or  in the [L/R Shift] display.



Memo

- You can sew piecing by referring to the guideline marker. For details, refer to “Projecting the Guidelines with the Projector” on page 84.

■ Piecing Using the 1/4" Piecing Foot with Guide

This piecing foot can sew an accurate 1/4-inch or 1/8-inch seam allowance. It can be used for piecing together a quilt or for topstitching.

1 Select  , and then attach the 1/4" piecing foot with guide.

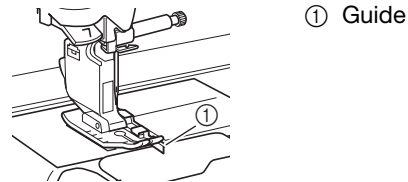

① Guide

2 Use the guide and marks on the presser foot to sew accurate seam allowances.

Piecing a 1/4 inch seam allowance

Keep the edge of the fabrics against the guide as you sew.

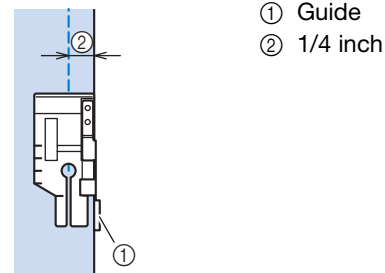

① Guide
② 1/4 inch

Memo

- For accurate fabric placement, refer to “Aligning the Fabric with a Mark on the Needle Plate or Bobbin Cover (with Mark)” on page 99.

Creating an accurate seam allowance

Use the mark on the foot to begin, end, or pivot 1/4 inch from edge of fabric.

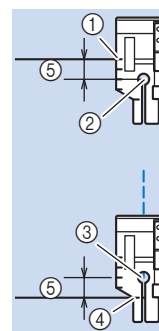

① Align this mark with edge of fabric to begin.
② Beginning of stitching
③ End of stitching
④ Opposite edge of fabric to end or pivot
⑤ 1/4 inch

Memo

- For details on pivoting, refer to “Pivoting” on page 76.

Topstitching quilting, 1/8 inch

Sew with the edge of the fabric or seam aligned with the left side of the presser foot's front section.

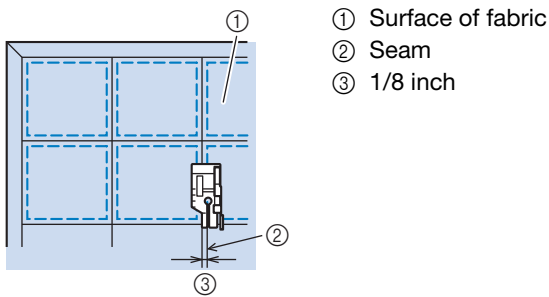

■ Quilting

Sewing the quilt top, batting, and backing together is called quilting. You can sew the quilt with the compact dual feed foot to keep the quilt top, batting, and backing from sliding. The compact dual feed foot has a motorized belt that moves together with the feed dogs in the needle plate during sewing. For straight line quilting, use the compact dual feed foot and the straight stitch needle plate. Always select a straight stitch (middle needle position) when using the straight stitch needle plate.

1 Select .

2 Attach the compact dual feed foot. (page 59)

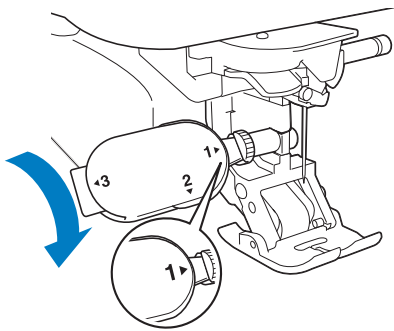

3 Place one hand on each side of the presser foot to hold the fabric secure while sewing.

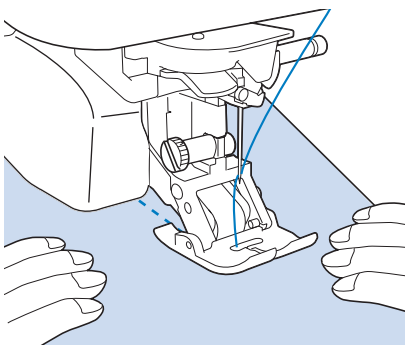

Memo

- Sew at slow to medium speed.
- Always check to be sure that your quilting surface is securely basted before beginning to sew.

■ Appliqué

1 Trace the pattern onto the appliqué fabric and then cut around it, leaving a 3 to 5 mm (approx. 1/8 to 3/16 inch) seam allowance.

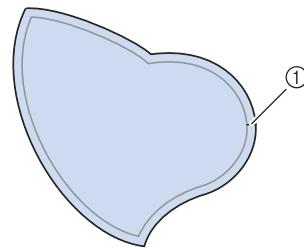

① Seam allowance: 3 to 5 mm (approx. 1/8 to 3/16 inch)

2 Place a piece of stabilizer cut to the finished size of the appliqué design onto the fabric, and then fold over the seam margin using an iron. Clip curves when necessary.

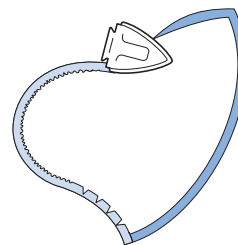

3 Turn the appliqué over, and attach the stabilizer with basting pins or a basting stitch.

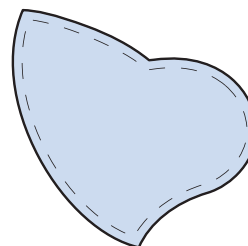

4 Select and attach presser foot "J".

- 5 Use the quilting appliqué stitch to attach the appliqué. Sew around the edge while dropping the needle as close to the edge as possible.

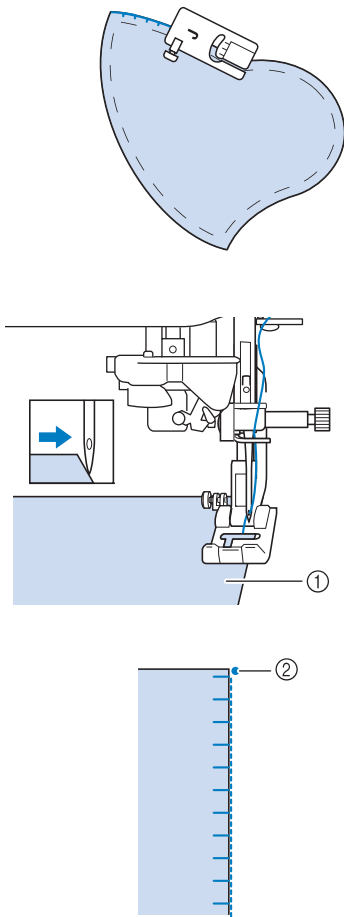

- 1 Appliqué
- 2 Needle drop position

CAUTION

- Be careful that the needle does not strike a basting pin during sewing. Striking a pin can cause the needle to break, resulting in injury.

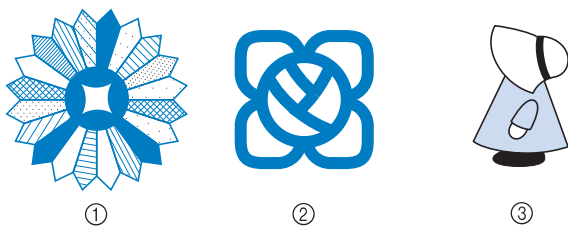

You can use the appliqué technique to attach appliqué designs like the three pictured below.



- 1 Dresden plate
- 2 Stained glass
- 3 Sunbonnet sue

Quilting with Satin Stitches

For better fabric control, use the foot controller to sew with satin stitches. Set the speed control slide to control the stitch width to make subtle changes in the stitch width during sewing.

- 1 Attach the foot controller. (page 64)
- 2 Select  and attach presser foot "J".
- 3 Touch  in the length display to shorten the stitch length.

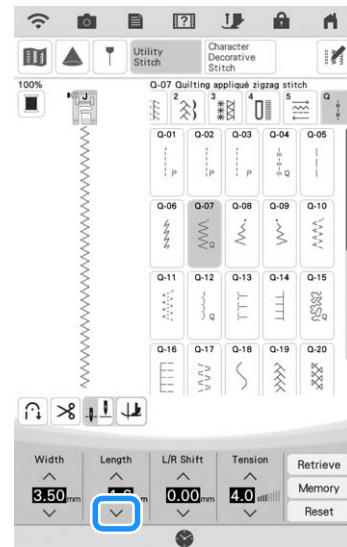

Memo

- The setting will vary according to the kind of fabric and the thickness of the thread, but a length of 0.3 to 0.5 mm (approx. 1/64 to 1/32 inch) is best for satin stitches.

- 4 Touch  to use the speed control slide to control the stitch width.
- 5 Set the [Width Control] to [ON].

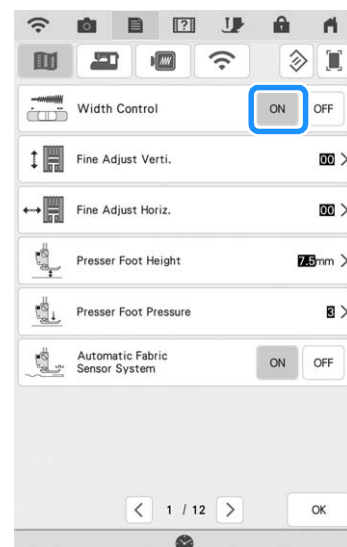

6 Touch .

→ The screen appears as shown below.



7 Start sewing.

* You can adjust the stitch width during sewing by moving the sewing speed controller. Slide the lever to the left, and the stitch width becomes narrower. Slide it to the right, the stitch width becomes wider. The size of the width changes equally on both sides of the middle needle position.

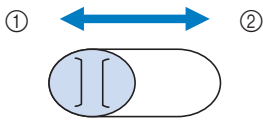

- ① narrower
- ② wider

Example: Changing the width

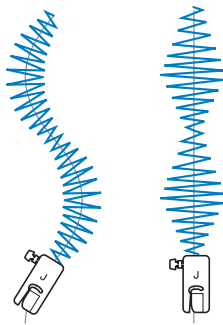

8 When you are finished sewing, set the [Width Control] back to [OFF].

Free Motion Quilting

With free motion quilting, the feed dogs can be lowered by touching then , so that the fabric can be moved freely in any direction. For free motion quilting, use free motion quilting foot "C" or free motion open toe quilting foot "O" depending on the stitch that is selected, and set the machine to free motion sewing mode. In this mode, the presser foot is raised to the necessary height for free motion sewing. We recommend attaching the foot controller and sewing at a consistent speed. You can adjust the sewing speed with the speed control slide on the machine.

CAUTION

- With free motion quilting, control the feeding speed of the fabric to match the sewing speed. If the fabric is moved faster than the sewing speed, the needle may break and cause injury.

Memo

- When starting to sew, the internal sensor detects the thickness of the fabric, and the quilting foot is raised to the height specified in the machine settings screen. Touch to display [Free Motion Foot Height] of the settings screen. Touch the number to select the height that the quilting foot is raised above the fabric. Increase the setting, for example, when sewing very stretchy fabric, so that it is easier to sew.

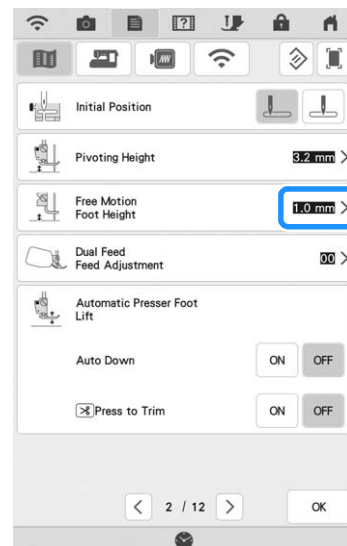

- In order to sew with a balanced tension, it may be necessary to adjust the upper thread tension. Test with a sample piece of fabric that is similar to your chosen fabric.
- Do not be discouraged with your initial results. The technique requires practice.

Using free motion Quilting Foot “C”

Use the free motion quilting foot “C” with straight stitch needle plate for free motion sewing.



Free motion quilting foot “C”

⚠ CAUTION

- When using free motion quilting foot “C”, be sure to use the straight stitch needle plate and sew with the needle in middle (center) needle position. If the needle is moved to any position other than the middle (center) needle position, the needle may break, which may result in injuries.

- 1 Attach the straight stitch needle plate. (page 100)

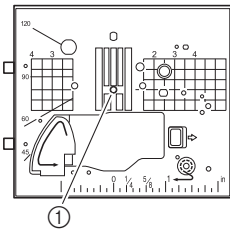

① Round hole

⚠ CAUTION

- The machine must be turned off and unplugged when switching the needle plate.

- 2 Select or .

- 3 Touch then to set the machine to free motion sewing mode.

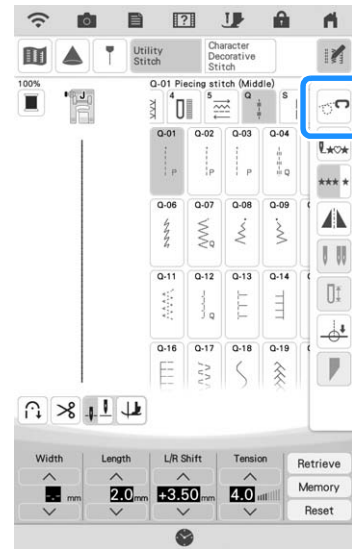

→ The key appears as , the presser foot is raised to the necessary height, and then the feed dogs are lowered for free motion sewing.

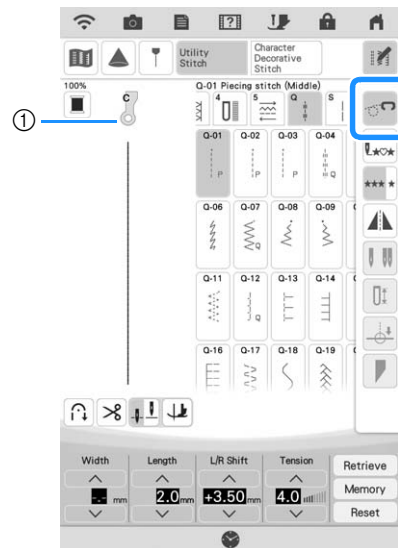

- ① Free motion quilting foot “C”
- When stitch Q-01 or 1-31 is selected, free motion quilting foot “C” is indicated in the upper-left corner of the screen.

- 4 Remove the presser foot holder. (page 58)

- 5** Attach free motion quilting foot “C” at the front with the presser foot holder screw aligned with the notch in the quilting foot.

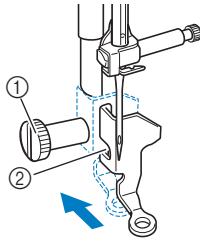

- ① Presser foot holder screw
- ② Notch

Note

- Make sure that the quilting foot is attached properly and not slanted.

- 6** Hold the quilting foot in place with your right hand, and tighten the presser foot holder screw using the multi-purpose screwdriver with your left hand.

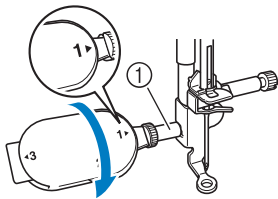

- ① Presser foot holder screw

CAUTION

- Be sure to securely tighten the screw with the included multi-purpose screwdriver. Otherwise, the needle may touch the quilting foot, causing it to break and causing injury.

- 7** Use both hands to stretch the fabric taut, and then move the fabric at a consistent pace in order to sew uniform stitches roughly 2.0-2.5 mm (approx. 1/16 - 3/32 inch) in length.

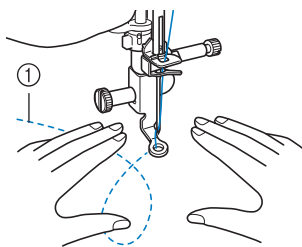

- ① Stitch

- 8** Touch  to cancel the free motion sewing mode.

→ Rotate the handwheel toward you (counterclockwise) to raise the feed dogs.

- 9** After sewing, make sure to remove the straight stitch needle plate and presser foot “C”, and reinstall the regular needle plate.

Memo

- Free motion open toe quilting foot “O” can also be used with the straight stitch needle plate. We recommend using free motion open toe quilting foot “O” with free motion sewing of fabrics of uneven thicknesses.

Using free motion Open Toe Quilting Foot “O”

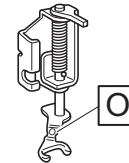

The free motion open toe quilting foot “O” is used for free motion quilting with zigzag or decorative stitches or for free motion quilting of straight lines on fabric with an uneven thickness. Various stitches can be sewn using free motion open toe quilting foot “O”. For details on the stitches that can be used, refer to “STITCH SETTING CHART” on page 198.



Free motion open toe quilting foot “O”

Memo

- The standard needle plate must be used if zigzag or decorative stitch patterns are selected.

- 1** Touch  then  to set the machine to free motion sewing mode.

→ The key appears as , the presser foot is raised to the necessary height, and then the feed dogs are lowered for free motion sewing.

- 2** Select a stitch.

Memo

- When stitch Q-01 or 1-31 is selected, free motion quilting foot “C” is indicated in the upper-left corner of the screen. When the other stitches are selected, free motion open toe quilting foot “O” is indicated in the screen.

- 3** Remove the presser foot holder. (page 58)

- 4** Attach free motion open toe quilting foot "O" by positioning the pin of the quilting foot above the needle clamp screw and aligning the lower-left of the quilting foot and the presser bar.

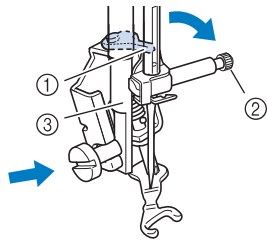

- ① Pin
- ② Needle clamp screw
- ③ Presser bar

Note

- Make sure that the quilting foot is not slanted.

- 5** Hold the quilting foot in place with your right hand, and tighten the presser foot holder screw using the multi-purpose screwdriver with your left hand.

- * Use the multi-purpose screw driver setting the position to "1". (page 15)

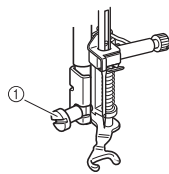

- ① Presser foot holder screw

CAUTION

- Be sure to securely tighten the screw with the included multi-purpose screwdriver. Otherwise, the needle may touch the quilting foot, causing it to break and causing injury.

- 6** Use both hands to stretch the fabric taut, and then move the fabric at a consistent pace in order to sew uniform stitches roughly 2.0-2.5 mm (approx. 1/16 - 3/32 inch) in length.

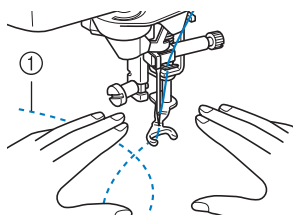

- ① Stitch

- 7** Touch  to cancel the free motion sewing mode.

- Rotate the handwheel toward you (counterclockwise) to raise the feed dogs.

■ Echo Quilting Using the Free Motion Echo Quilting Foot "E"

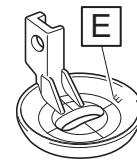

Sewing quilting lines at equal distances around a motif is called echo quilting. The quilting lines, which appear as ripples echoing away from the motif, are the distinguishing characteristic of this quilting style. Use the free motion echo quilting foot "E" for echo quilting. Using the measurement on the presser foot as a guide, sew around the motif at a fixed interval. We recommend attaching the foot controller and sewing at a consistent speed.

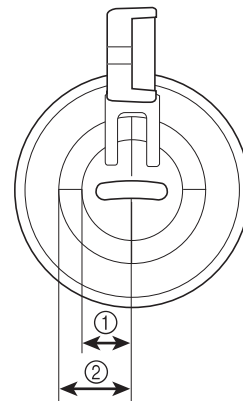

Free motion echo quilting foot "E" measurement



- ① 6.4 mm (approx. 1/4 inch)
- ② 9.5 mm (approx. 3/8 inch)

- 1** Select  .
- 2** Touch  then  to set the machine to free motion sewing mode.

- The key appears as  , the presser foot is raised to the necessary height, then the feed dogs are lowered for free motion sewing.

- 3** Follow the steps on page 57 to remove the presser foot.
- 4** Remove the presser foot holder and then attach the adapter. (page 58)

5 Position the free motion echo quilting foot “E” on the left side of the presser bar with the holes in the quilting foot and presser bar aligned.

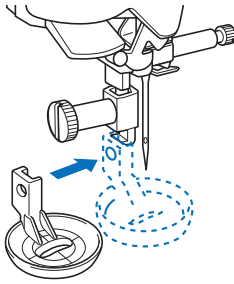

6 Tighten the screw with the included screwdriver (large).

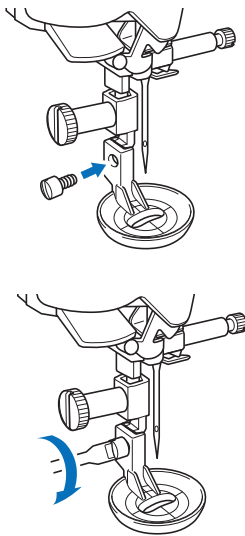

⚠ CAUTION

- Be sure to securely tighten the screws with the included screwdriver (large). Otherwise, the needle may touch the quilting foot, causing it to break and causing injury.

7 Using the measurement on the quilting foot as a guide, sew around the motif.

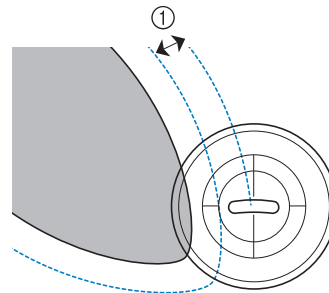
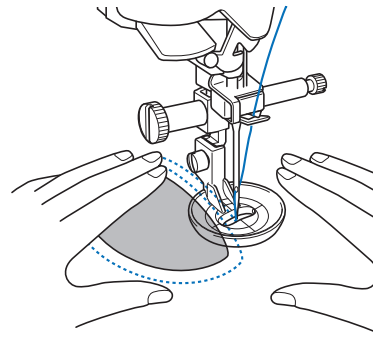

① 6.4 mm (approx. 1/4 inch)
Finished project

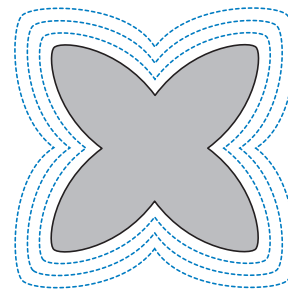

8 Touch  to cancel the free motion sewing mode.

→ Rotate the handwheel toward you (counterclockwise) to raise the feed dogs.

Hand-Look Quilting

Sew hand-look quilting stitch patterns using the threads recommended below:

Upper thread: Use transparent nylon thread or lightweight thread that matches the color of the fabric for this thread to appear invisible.

Bobbin thread: Use a color that contrasts with the fabric for the stitch pattern to stand out.



1-33 Q	Q-04 Q	S-03 H	S-04 H	S-05 H
-----------	-----------	-----------	-----------	-----------

Memo

- For most fabrics and threads, using a 90/14 needle will result in a clean finish.
- To bring up more of the bobbin thread, increase the thread tension.
- S-03, S-04, S-05 are made up of several short stitches.

Blind Hem Stitches

Secure the bottoms of skirts and pants with a blind hem. Two stitches are available for blind hem stitching.

Stitch	Stitch name	Presser foot
2-01	Blind hem stitch	
2-02	Blind hem stitch stretch	

Memo

- When the size of cylindrical pieces is too small to slide onto the arm or the length is too short, the fabric will not feed and desired results may not be achieved.

1 Turn the skirt or pants wrong side out.

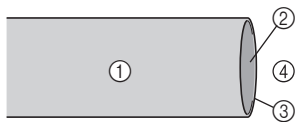

- ① Wrong side of fabric
- ② Right side of fabric
- ③ Edge of fabric
- ④ Bottom side

2 Fold the fabric along the desired edge of the hem, and press.

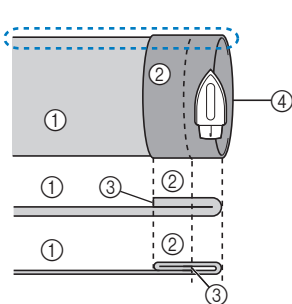

- ① Wrong side of fabric
- ② Right side of fabric
- ③ Edge of fabric
- ④ Desired edge of hem

<Seen from the side>

3 Use a chalk pencil to mark on the fabric about 5 mm (3/16 inch) from the edge of the fabric, and then baste it.

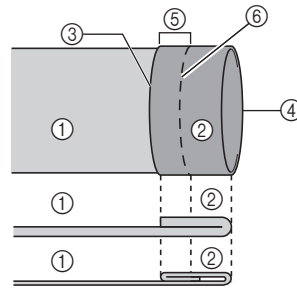

- ① Wrong side of fabric
- ② Right side of fabric
- ③ Edge of fabric
- ④ Desired edge of hem
- ⑤ 5 mm (3/16 inch)
- ⑥ Basting

<Seen from the side>

4 Fold back the fabric inside along the basting.

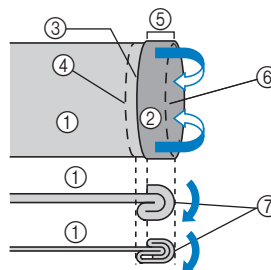

- ① Wrong side of fabric
- ② Right side of fabric
- ③ Edge of fabric
- ④ Desired edge of hem
- ⑤ 5 mm (3/16 inch)
- ⑥ Basting
- ⑦ Basting point

<Seen from the side>

5 Unfold the edge of fabric, and position the fabric with the wrong side facing up.

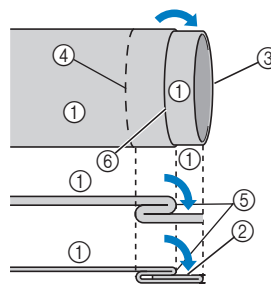

- ① Wrong side of fabric
- ② Right side of fabric
- ③ Edge of fabric
- ④ Desired edge of hem
- ⑤ Basting point
- ⑥ Basting

<Seen from the side>

6 Attach blind stitch foot "R".

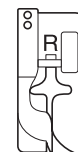

7 Select 2-01 or 2-02.

8 Remove the flat bed attachment to use the free-arm.

- 9** Slide the item that you wish to sew onto the free arm and make sure that the fabric feeds correctly.

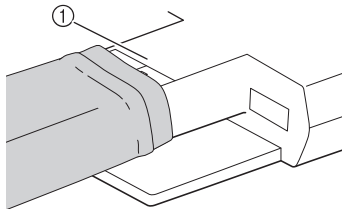

① Free arm

- 10** Position the fabric with the edge of the folded hem against the guide of the presser foot, and then lower the presser foot lever.

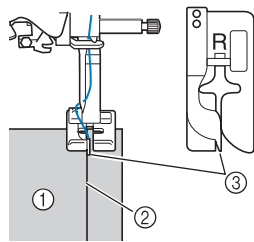

① Wrong side of fabric
② Fold of hem
③ Guide

- 11** Adjust the stitch width until the needle slightly catches the fold of the hem.

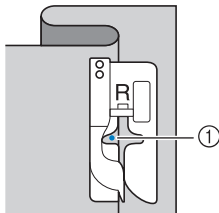

① Needle drop point

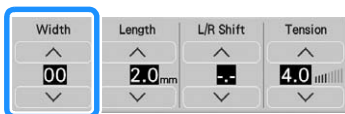

When you change the needle drop point, raise the needle, and then change the stitch width. (The stitch width setting is in neither millimeters nor inches.)

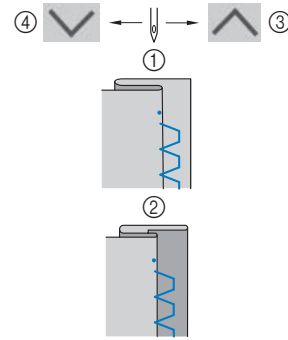

- ① Thick fabric
② Normal fabric
③ Touch to move the needle drop point to the right, if the needle catches too much of the fold.
④ Touch to move the needle drop point to the left, if the needle does not catch the fold.

Memo

- Blind hem stitches cannot be sewn if the left needle drop point does not catch the fold. If the needle catches too much of the fold, the fabric cannot be unfolded and the seam appearing on the right side of the fabric will be very large, leaving an unattractive finish.

- 12** Sew with the fold of the hem against the presser foot guide.

* We recommend to stitch reinforcement stitches at the beginning and end of the hem.

- 13** Press the “Start/Stop” button to stop sewing when you are finished, and raise the presser foot and needle to pull the fabric under the presser foot towards the back of the machine.

IMPORTANT

- Be sure to pull the fabric towards the back of the machine after sewing. If you pull the fabric toward side or forward, the presser foot may be damaged.

- 14** Remove the basting stitching and reverse the fabric.

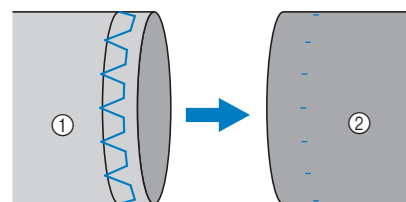

① Wrong side of fabric
② Right side of fabric

Appliqué

- 1 Use a temporary spray adhesive, fabric glue or a basting stitch to attach the appliqué to the fabric.

* This will keep the fabric from moving during sewing.

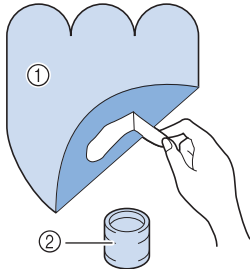

- 1 Appliqué
- 2 Fabric glue

- 2 Select  or .

* Adjust the stitch length and width to correspond to the appliqué shape, size, and quality of material. (page 72)

Memo

- For details on each stitch, refer to “STITCH SETTING CHART” on page 198.

- 3 Attach presser foot “J”. Check that the needle drops slightly off the edge of the appliqué, then start sewing.

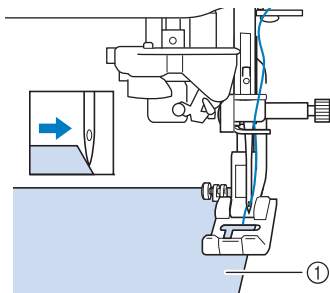

- 1 Appliqué material

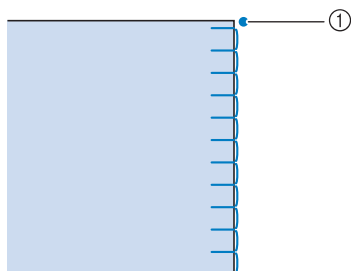

- 1 Needle drop position

■ Appliqué Sharp Curves

Stop the machine with the needle in the fabric outside the appliqué. Raise the presser foot and turn the fabric a little bit at a time while sewing for an attractive finish to the seam.

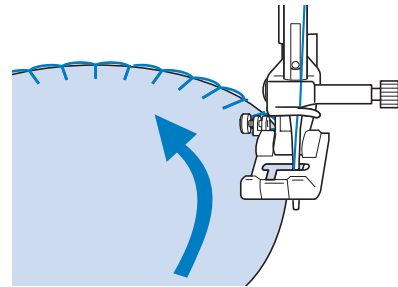

■ Appliqué Corners

Stop the machine with the needle in the right position of the outside (or inside) corner of the appliqué. Raise the presser foot and pivot the fabric to align the fabric edge. Lower the presser foot and continue stitching.

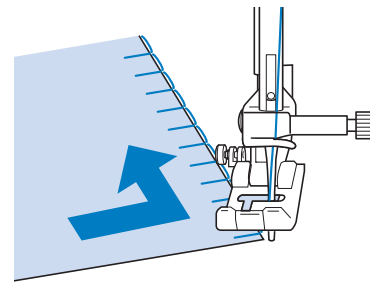

Memo

- Sewing with tear-away stabilizer under the base fabric will provide the best results.

Shelltuck Stitches

Shelltuck stitches give an attractive appearance of shells along the curve of a collar. This stitch pattern can be used for edging the neckline or sleeves of dresses and blouses.

1 Select .

 **Memo**

- For details on each stitch, refer to “STITCH SETTING CHART” on page 198.

2 Increase the upper thread tension for an attractive scallop finish to the shelltuck stitches. (page 74)

 **Memo**

- If the upper thread tension is too weak, the shelltuck stitches will not scallop.

3 To make rows of shell tuck stitches, fold the fabric in half along the bias.

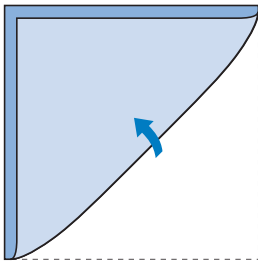

 **Memo**

- Use a thin fabric.

4 Attach presser foot “J”. Set the needle drop point slightly off the edge of the fabric, and start sewing.

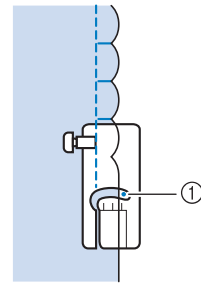
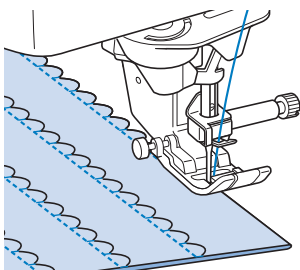

① Needle drop position

5 Unfold the fabric, and iron the tucks to one side.

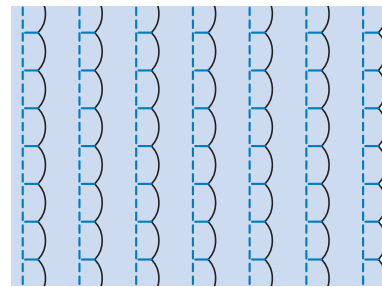

 **Memo**

- To make shell tucks at the edge of a collar or neckline, follow the stitch pattern’s instructions and then use this stitch to make a decorative finish on the collar or neckline.

Scallop Stitches

This wave-shaped satin stitch is called the scallop stitch. Use this stitch to decorate the edges of blouse collars and handkerchiefs or use it as a hem accent.

 **Memo**

- For best results, apply starch and iron the fabric before sewing.

1 Select .

 **Memo**

- For details on each stitch, refer to “STITCH SETTING CHART” on page 198.

- 2** Attach advanced monogramming foot “N+”. Sew scallop stitches along the edge of the fabric.

* Do not sew directly on the edge of the fabric.

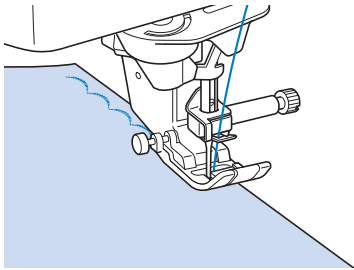

- 3** Trim along the seam, making sure not to cut the stitches.

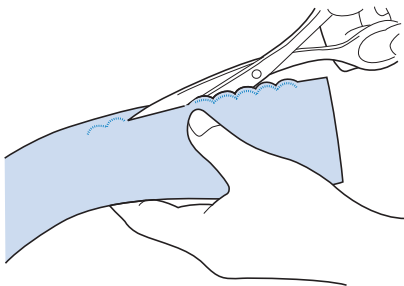

Memo

- Use a seam sealant to secure the edges of the scallop stitches.

Crazy Quilting

For a decorative look called “Crazy Quilting”, the following stitches can be sewn on top of a pressed seam allowance.

- 1** Select a straight stitch and attach presser foot “J”.
- 2** With the right sides facing each other, sew two pieces of fabric together, and then press open the seam allowance.

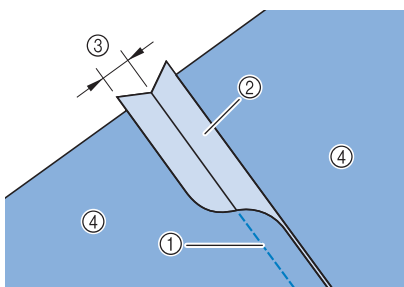

- ① Straight stitch
- ② Seam margins
- ③ 6.5 mm (approx. 1/4 inch)
- ④ Wrong side

- 3** Select a stitch for top stitching.

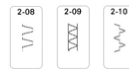

- 4** Place the fabric right side up in the machine, and center the presser foot over the seam when sewing.

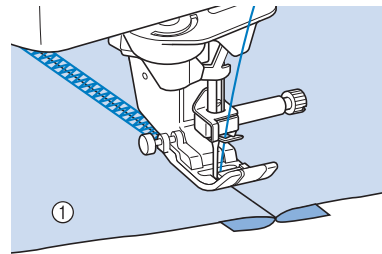

① Right side of fabric

Smocking Stitches

Use smocking stitches for decorative sewing on clothes, etc.

- 1** Select a straight stitch and attach presser foot “J”.
- 2** Set the stitch length to 4.0 mm (approx. 5/32 inch) and loosen the upper thread tension to approximately 2.0 (“Setting the Stitch Length” on page 73 and “Setting the Thread Tension” on page 74).
- 3** Pull the bobbin and upper threads out by 50 mm (approx. 2 inches).
- 4** Sew the seams, leaving approximately 10 mm (approx. 3/8 inch) between the seams, then trim excess thread, leaving 50 mm (approx. 2 inches).

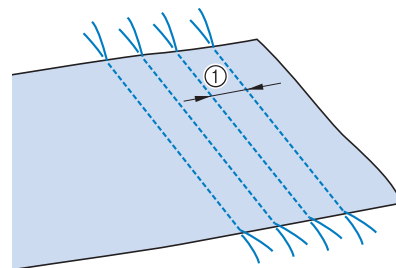

① Approximately 10 mm (approx. 3/8 inch)

- 5** Pull the bobbin threads to obtain the desired amount of gather, and then smooth the gathers by ironing them.

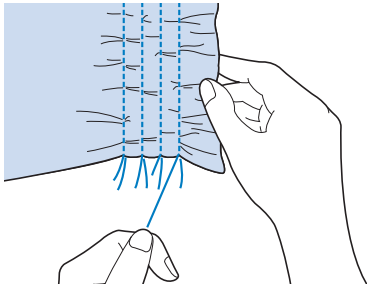

- 6** Select  or .

Memo

- For details on each stitch, refer to “STITCH SETTING CHART” on page 198.

- 7** Sew the spaces between the straight seams.

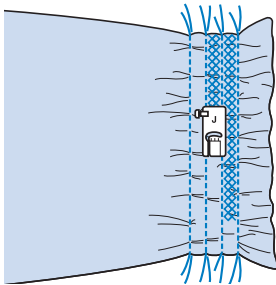

- 8** Pull out the straight stitch threads.

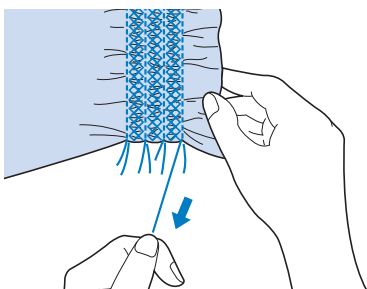

Fagoting

When there is a space between two fabrics with thread sewn over the space to join the fabrics together, it is called fagoting. Use this stitch when sewing blouses or children’s clothes.

- 1** Baste two pieces of fabric onto thin paper, leaving a space of 4 mm (approx. 3/16 inch) between the fabrics.

* If you draw a line down the middle of the thin paper or water soluble stabilizer, sewing is easier.

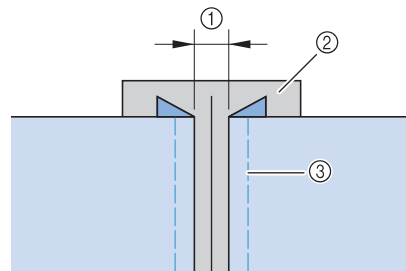

- ① 4.0 mm (approx. 3/16 inch)
- ② Paper
- ③ Basting stitches

- 2** Select  or .

Memo

- For details on each stitch, refer to “STITCH SETTING CHART” on page 198.

- 3** Attach presser foot “J”. Align the center of the presser foot with the middle of the space between the fabrics and begin sewing.

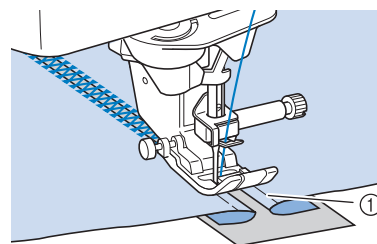

- ① Basting stitches

Memo



- Use a thick thread.

- 4** When sewing is finished, gently tear the paper away.

Tape or Elastic Attaching

- 1 Select a straight stitch and attach presser foot "J".
- 2 Set the stitch length to 4.0 mm (approx. 3/16 inch), and loosen the upper thread tension to 2.0 ("Setting the Stitch Length" on page 73 and "Setting the Thread Tension" on page 74).

Memo

- Be sure that neither automatic reinforcement  nor automatic thread cutting  is selected.

- 3 Sew two rows of straight stitches on the right side of the fabric, then pull the bobbin thread to create the necessary gather.

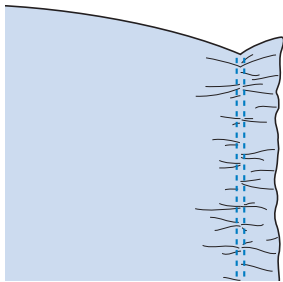

Memo

- Before sewing the straight stitch, rotate the handwheel toward you (counterclockwise) and pull up the bobbin thread. Holding the top and bobbin thread, pull a length of thread out from the rear of the machine. (Be sure that the presser foot is raised.)

- 4 Place the tape over the gather, and hold it in place with basting pins.

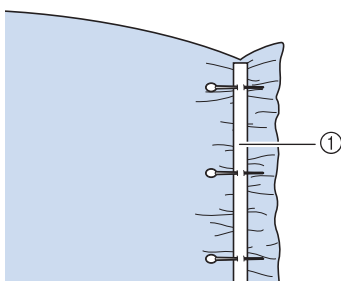

① Tape

- 5 Select  or .

Memo

- For details on each stitch, refer to "STITCH SETTING CHART" on page 198.

- 6 Sew over the tape (or elastic).

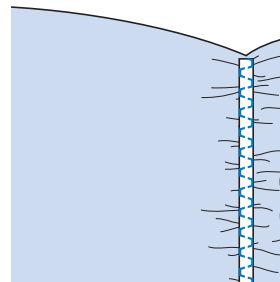
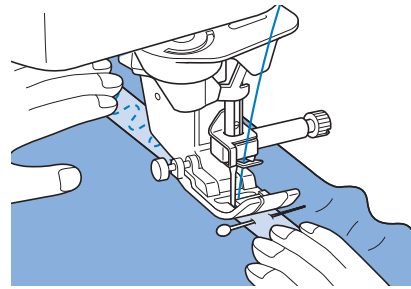

CAUTION

- Be sure the needle does not strike a basting pin, or any other objects, during sewing. The thread could tangle or the needle could break, causing injury.

- 7 Pull out the straight stitch threads.

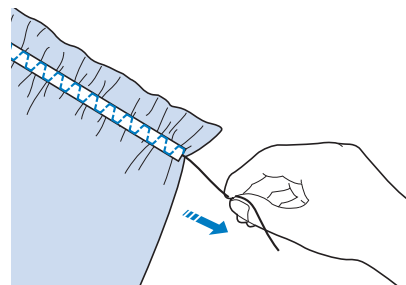

Heirloom

■ Hemstitching (Drawn Work (1))

1 Pull out several threads from one area on a piece of fabric to open the area.

* Pull out 5 or 6 threads to leave a 3 mm (approx. 1/8 inch) area open.

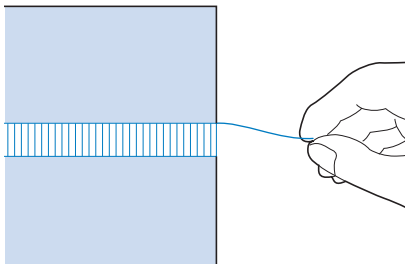

Memo

- Loosely woven fabrics work best for this.

2 Select .

Memo

- For details on each stitch, refer to "STITCH SETTING CHART" on page 198.

3 Attach advanced monogramming foot "N+". With the right side of the fabric facing up, sew one edge of the open area.

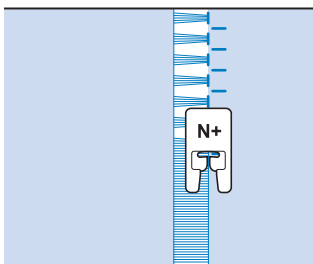

4 Touch  to create a mirror image of the stitch.

5 Match beginning needle drop points on the opposite edge of the open area to keep the stitching symmetrical.

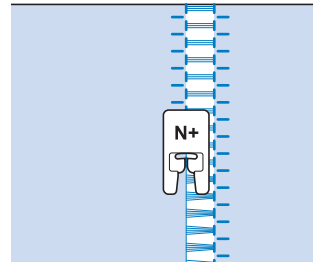

■ Hemstitching (Drawn Work (2))

1 Pull out several threads from both sides of the 4 mm (approx. 3/16 inch) area which are not yet open.

* Pull out four threads, leave five threads, and then pull out four threads. The width of five threads is approximately 4 mm (approx. 3/16 inch) or less.

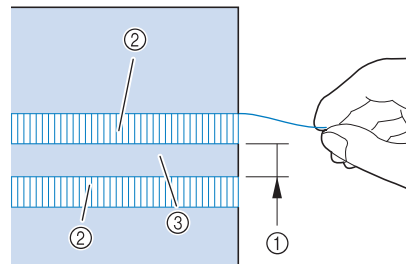

- ① Approx. 4 mm (approx. 3/16 inch) or less
- ② Four threads (pull out)
- ③ Five threads (leave)

2 Select .

Memo

- For details on each stitch, refer to "STITCH SETTING CHART" on page 198.

3 Sew the decorative stitch in the center of the five threads created above.

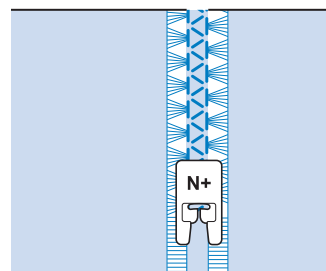

Basting

- 1 Select  and attach presser foot "J".
- 2 If desired, keep pressing the "Reverse Stitch" button or the "Reinforcement Stitch" button to sew 4 stitches of reinforcement stitches, then press "Start/Stop" button to continue sewing.

Memo

- If the basting threads fall out of the fabric, pull up the bobbin thread before sewing, and then pull the upper thread and bobbin thread under the presser foot toward the back of the machine. Hold the upper thread and bobbin thread when beginning to sew, and when finished sewing, cut the threads leaving an excess amount of thread. Finally, hold the upper thread and bobbin thread at the beginning of the stitching while arranging the fabric.
- When you use the basting stitch for gathering, do not use a reinforcement stitch at the beginning; you should lift the presser foot, rotate the handwheel toward you (counterclockwise), pull up the bobbin thread and pull a length of top and bobbin thread out from the rear of the machine.
- Stitching will be sewn with a length of 5 mm (approx. 3/16 inch).

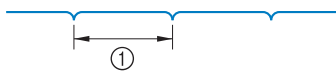

① 5 mm (approx. 3/16 inch)

- 3 Sew while keeping the fabric straight.

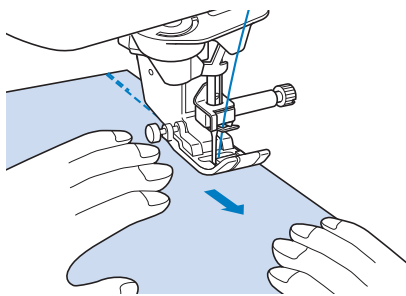

- 4 If desired, end the basting with reinforcement stitches.

Free-Motion Basting

When the feed dogs are lowered, basting can be sewn while freely moving the fabric.

- 1 Select .

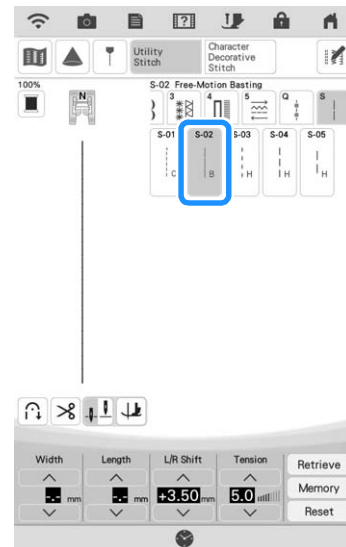

→ The presser foot is raised to the height necessary for free-motion sewing, and the feed dogs are lowered.

- 2 If desired, keep pressing the "Reverse Stitch" button or the "Reinforcement Stitch" button to sew 4 stitches of reinforcement stitches.

- 3 Press the "Start/Stop" button to start sewing.

Sew while moving the fabric when the needle is raised.

Memo

- If the side pedal of the multi-function foot controller is set to [Single Stitch], basting can be sewn by using the side pedal to sew each single stitch. For details on specifying settings for the multi-function foot controller, refer to "Using Advanced Multi-Function Foot Controller" on page 63.
- The green light on the right of the "Reinforcement Stitch" button lights up while reinforcement stitching.
- The sewing speed is limited up to 100 spm.

- 4 If desired, end the basting with reinforcement stitches.

Zigzag Couching

You can easily sew decorative effects using yarn.

⚠ CAUTION

- When using yarn, we recommend selecting yarn of weight 4 (MEDIUM (4)). Medium yarn is often referred to as worsted weight, 20 knitted stitches per 10cm, or 9-11 wraps per inch. The diameter of the yarn is approximately 2-3 mm (1/12-1/8 inch). If the yarn is extremely thin or thick, has an unusual shape (flat or furry), or more than 2 yarns, the best finishing results may not be achieved, or injuries or damage may result.

💡 Note

- Sew test stitches on the fabric before sewing on your project.
- We recommend using a stabilizer material when sewing stretch fabrics, lightweight fabrics, fabrics with a coarse weave, or fabrics which are prone to fabric shrinkage.

■ Prepare for Zigzag Couching

1 Attach the spool stand to the machine.

At this time, do not raise the telescopic thread guide shaft.

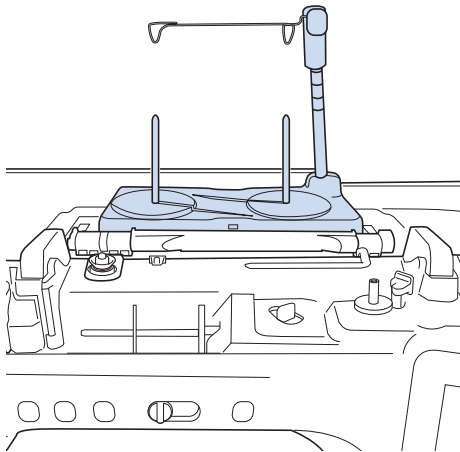

* Refer to "Assembling the Spool Stand" on page 16.

2 Insert the yarn guide for zigzag couching into the slot on the top left of the machine.

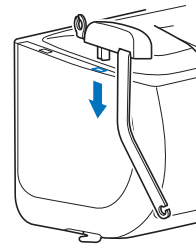

💡 Note

- There are two yarn guides: one for sewing couching and one for embroidery couching. Check the shape of the part, and then install the appropriate guide.

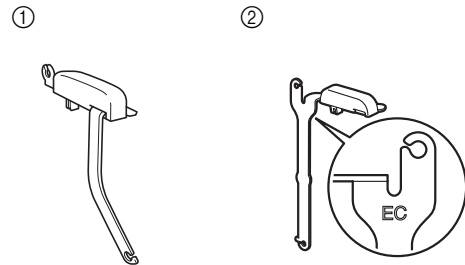

- ① Yarn guide for sewing couching
- ② Yarn guide for embroidery couching

3 Touch to lock all keys and buttons, and then raise the presser foot lever.

4 Attach the compact dual feed foot to the machine without attaching the couching dual feed foot.

* Refer to "Attaching the Compact Dual Feed Foot" on page 59.

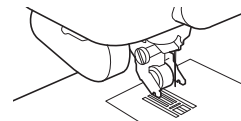

- 5** Pass the yarn through the telescopic thread guide and the yarn guide (①) to (②).

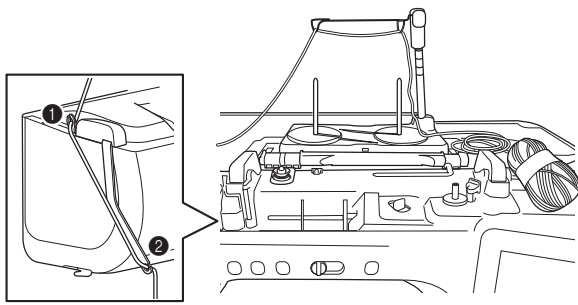

Note

- Make sure that the yarn does not become entangled as you work.

- 6** Thread the yarn through the couching dual feed foot.

Pass the yarn through the loop in the yarn threader, and then pass the threader from top to bottom through the hole on the couching dual feed foot.

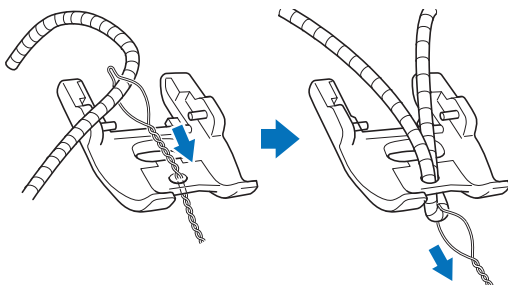

- 7** Attach the couching dual feed foot shown below to the compact dual feed foot.

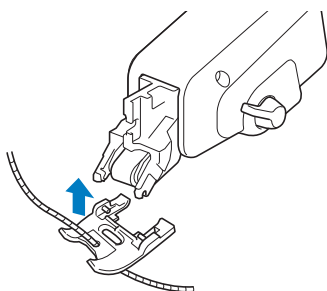

- 8** Pull out the yarn for about 10 cm (4 inches) to the back of the machine.

- 9** Touch  to unlock all keys and buttons.

- 10** Thread the machine with the upper thread.

Note

- Do not use the spool stand for upper thread. Otherwise thread may tangle with yarn.

■ Sewing Zigzag Couching

- 1** Select  (Stitch Pattern 1-10).

- 2** Measure the width of the yarn and set the stitch width according to the width of the yarn.

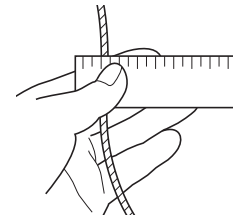

Note

- Make sure that there is enough width to wrap over the yarn.
- You can adjust the stitch width while checking the camera view. Refer to “Checking the Needle Location in the Screen” on page 79.

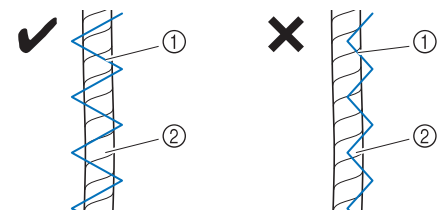

- ① Zigzag stitch
② Yarn

- 3** Rotate the handwheel to set the needle in the sewing start position. Start sewing on the right side of the yarn.

- 4** Make sure that the yarn passes straight through the channel in the back of the couching dual feed foot, and then lower the presser foot.

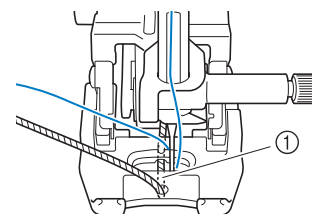

- ① Channel

Note

- Pull off an appropriate amount of yarn from the ball or skein so the yarn does not become taut.

5 Set the sewing speed to a medium speed.

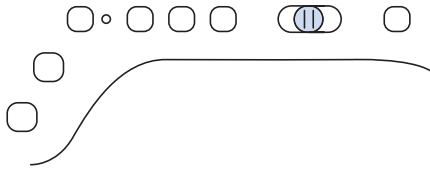

6 Press “Start/Stop” button to start sewing.

* While lightly holding down the fabric with both hands, adjust the sewing direction.

Memo

- The multi-function foot controller can also be very useful for sharp angle sewing when set to single stitch sewing. Refer to “Using Advanced Multi-Function Foot Controller” on page 63.
- Pivoting is also useful when rotating fabric with both hands.
- When guideline marker is set to on, it is easy to sew zigzag couching straight.

One-Step Buttonholes

















With one-step buttonholes, you can make buttonholes appropriate to the size of your button.

IMPORTANT

- When attaching and removing buttonhole foot “A+”, do not apply excessive force to the presser foot, otherwise it may be damaged. In addition, be careful not to hit the needle when attaching and removing buttonhole foot “A+”.

Note

- Before attaching the presser foot, check that there is enough thread in the bobbin.
- When the presser foot is attached, the compartment of the flat bed attachment cannot be opened. Be sure to first remove any necessary accessories.
- Sew trial stitches on fabric that is the same as that used in your project, referring to “Fabric/Thread/Needle Combinations” on page 56.
- The built-in camera detects the position of buttonhole foot “A+”. Do not touch the camera. (Refer to “NAMES OF MACHINE PARTS AND THEIR FUNCTIONS” on page 12.)
- Do not peel the “A+” sticker off buttonhole foot “A+” or cover the sticker with the upper thread, etc., otherwise the camera cannot detect the presser foot or buttonholes cannot be sewn.

Stitch	Stitch name	Presser foot
4-01 	Narrow rounded buttonhole	
4-02 	Wide round ended buttonhole	
4-03 	Tapered round ended buttonhole	
4-04 	Round ended buttonhole	
4-05 	Round ended buttonhole	
4-06 	Round double ended buttonhole	
4-07 	Narrow squared buttonhole	
4-08 	Wide squared buttonhole	

Stitch	Stitch name	Presser foot
4-09	Squared buttonhole	A+
4-10	Stretch buttonhole	A+
4-11	Heirloom buttonhole	A+
4-12	Bound buttonhole	A+
4-13	Keyhole buttonhole	A+
4-14	Tapered keyhole buttonhole	A+
4-15	Keyhole buttonhole	A+

One-step buttonholes are sewn from the front of the presser foot to the back, as shown below.

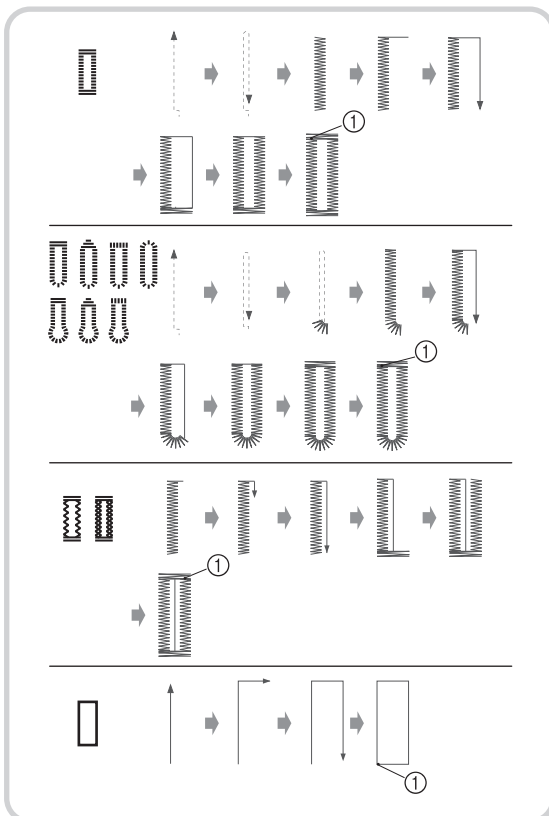

① Reinforcement stitching

1 Select a buttonhole stitch, and attach buttonhole foot "A+".

Position the upper thread under the presser foot by guiding thread through the hole in the presser foot before attaching the buttonhole foot "A+".

Memo

- If the fabric does not feed correctly, such as when sewing stretchy fabrics, install the buttonhole foot stabilizer. (page 132)

2 Mark the position and length of the buttonhole on the fabric.

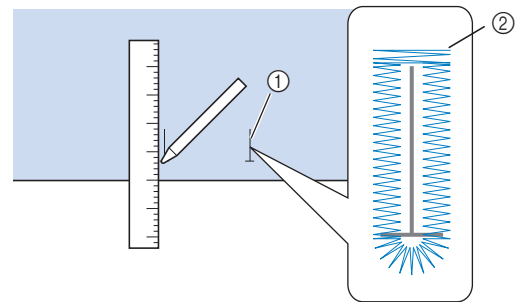

- ① Marks on fabric
- ② Buttonhole sewing

Memo

- The maximum buttonhole length is about 47 mm (approx. 1-3/4 inches) (diameter + thickness of the button).

3 Pull out the button holder plate on the presser foot, and insert the button that will be put through the buttonhole. Then tighten the button holder plate around the button.

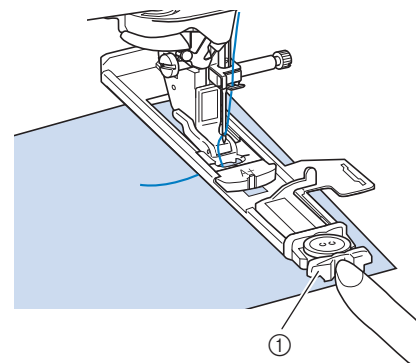

- ① Button holder plate

Memo

- The size of the buttonhole is determined by the size of the button in the button holder plate.

4 Align the presser foot with the mark on the fabric, and lower the presser foot.

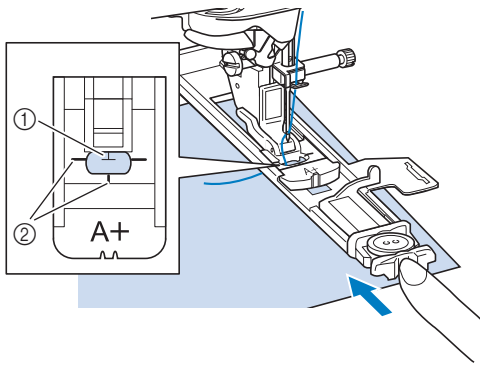

- ① Mark on the fabric
- ② Marks on the presser foot

Note

- Slide the outside frame of the buttonhole foot backward as far as possible as shown in the illustration, making sure that there is no gap behind the part of the foot marked “A+”. If the buttonhole foot is not slid back as far as possible, the buttonhole will not be sewn at the correct size.

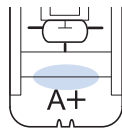

5 Gently hold the end of the upper thread, and then start sewing.

- * Feed the fabric carefully by hand while the buttonhole is sewn.

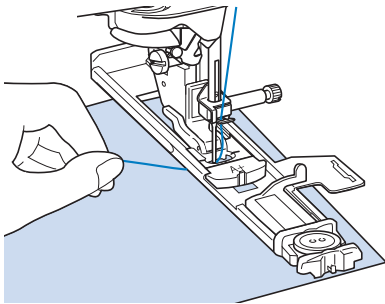

→ Once sewing is completed, the machine automatically sews reinforcement stitches, and then stops.

6 Press the “Thread Cutter” button once. Raise the presser foot, and then remove the fabric.

Memo

- When using the thread cutter on the left side of the machine or scissors to cut the threads, press the “Needle Position” button to raise the needle, raise the presser foot, and then pull out the fabric before cutting the threads.

7 Insert a pin along the inside of one of the bar tacks, and then insert the seam ripper into the center of the buttonhole and cut towards the pin.

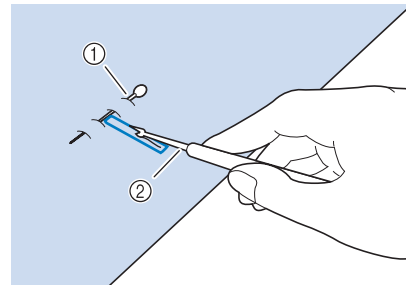

- ① Basting pin
- ② Seam ripper

CAUTION

- When using the seam ripper to open the buttonhole, do not put your hand or finger in the path of the ripper. The ripper may slip and cause injury.

Memo

- For keyhole buttonholes, use the eyelet punch to make a hole in the rounded end of the buttonhole. Then insert a pin along the inside of one of the bar tacks, insert a seam ripper into the hole made with the eyelet punch, and cut towards the pin.

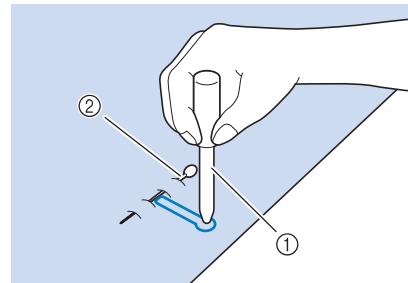



- ① Eyelet punch
- ② Basting pin

■ Sewing Stretch Fabrics

Note

- Attach stabilizer material to the back of stretch fabrics to prevent them from stretching.

When sewing on stretch fabric with  or , sew the buttonhole stitches over a gimp thread.

- 1 Hook the gimp thread onto the back of presser foot "A+". Insert the ends into the grooves at the front of the presser foot, and then temporarily tie them there.

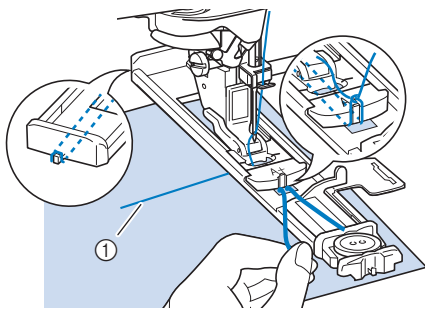

① Upper thread

- 2 Lower the presser foot and start sewing.

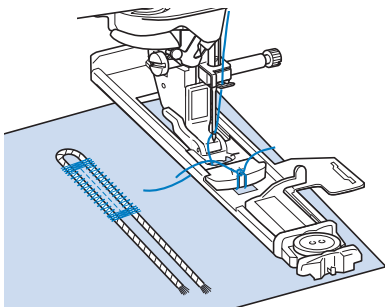

Memo

- Adjust the stitch width to the thickness of the gimp thread.

- 3 Once sewing is completed, gently pull the gimp thread to remove any slack, and trim off any excess.

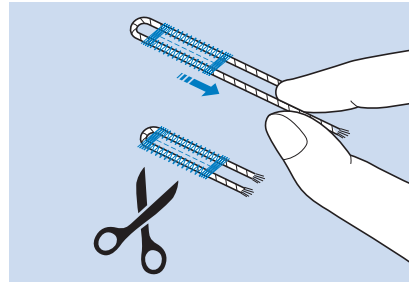

Memo

- After using the seam ripper to cut open the threads over the buttonhole, trim off the threads.

■ Odd Shaped Buttons/Buttons that Do Not Fit into the Button Holder Plate

Add the button diameter and thickness together, and then set the button holder plate at the calculated value.

The distance between the long markings on the presser foot scale is 5 mm (3/16 inch).

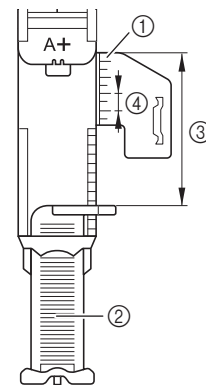

- ① Presser foot scale
- ② Button holder plate
- ③ Completed measurement of diameter + thickness
- ④ 5 mm (approx. 3/16 inch)

Example: For a button with a diameter of 15 mm (about 9/16 inch) and thickness of 10 mm (about 3/8 inch), align the scale with 25 mm (about 1 inch)

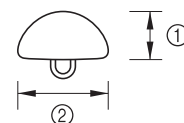

- ① 10 mm (approx. 3/8 inch)
- ② 15 mm (approx. 9/16 inch)

Memo

- The calculated value can also be set in the screen instead of setting the button holder plate.

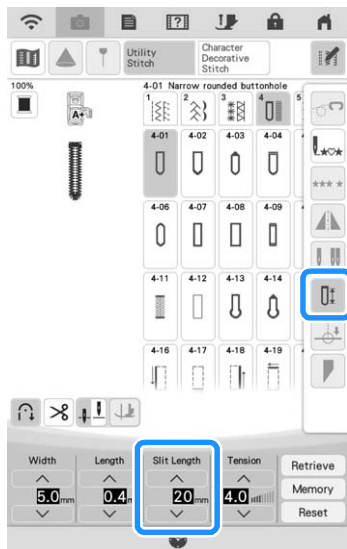

■ Sewing Thick Fabrics

Place a piece of folded fabric or cardboard beside the fabric being sewn to level the buttonhole foot and allow for easier and even feeding.

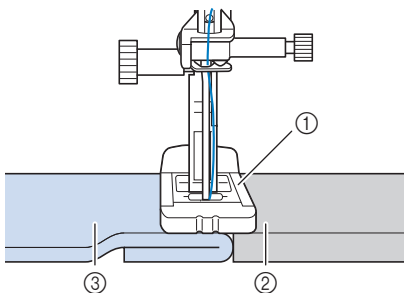

- ① Presser foot
- ② Thick paper
- ③ Fabric

■ Fabric Cannot Be Correctly Fed

If the fabric does not feed (for example, because it is too thick), first increase the stitch length setting. If the fabric still does not feed correctly, such as when sewing thick fabrics or stretch fabrics, install the buttonhole foot stabilizer, and then feed the fabric between the buttonhole foot stabilizer and buttonhole foot "A+". Attach the buttonhole foot stabilizer to buttonhole foot "A+" before attaching buttonhole foot "A+" to the presser foot holder.

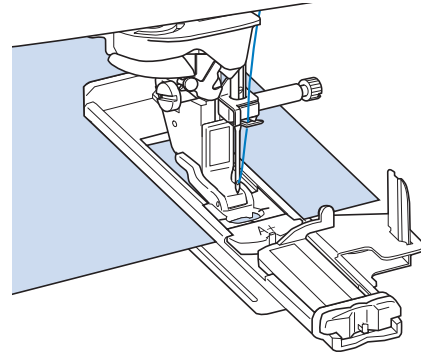









Four-Step Buttonholes

You can sew 4-step buttonholes using the following 4 stitches together. You can sew any desired length for the buttonhole when using 4-step buttonholes. 4-step buttonholes are a good option when attaching oversize buttons.

Note

- When changing the stitch settings, make sure that all stitch settings are changed to match.

Stitch	Stitch name	Presser foot
	4 steps buttonhole 1	
	4 steps buttonhole 2	
	4 steps buttonhole 3	
	4 steps buttonhole 4	

Four-step buttonholes are sewn as shown below.

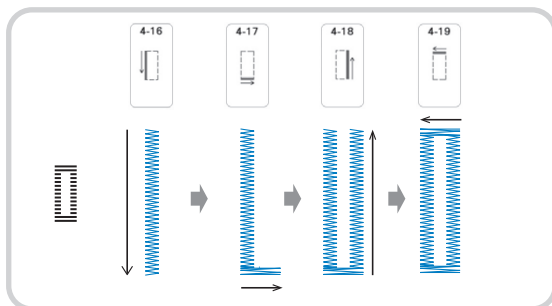

- Mark the position and length of the buttonhole on the fabric.

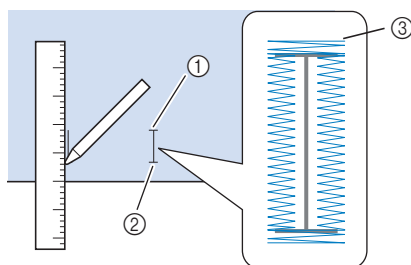



- Starting point
- End point
- Buttonhole sewing

- Attach advanced monogramming foot "N+", and select stitch  to sew the left side of the buttonhole.

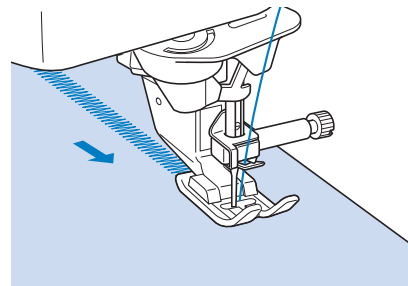
- Press the "Start/Stop" button to start sewing.
- Sew the desired length for the buttonhole and press the "Start/Stop" button again.



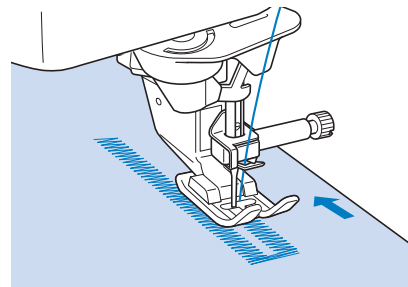

- Select stitch  to sew the bar tack and press the "Start/Stop" button.
 - The machine will automatically stop after sewing the bar tack.
- Select stitch  to sew the right side of the buttonhole, and press the "Start/Stop" button to begin sewing.



- Sew the right side of the buttonhole and press the "Start/Stop" button again.
 - * Sew the right side of the buttonhole the same length as the left.
- Select stitch  to sew the bar tack and then press the "Start/Stop" button.
 - The machine will automatically sew off the bar tack tie and stop when the bar tack is complete.
- Raise the presser foot and remove the fabric.
- Refer to page 130 to open the buttonhole.

Darning

Use darning stitches for mending and other applications.

Stitch	Stitch name	Presser foot
4-20	Darning	
4-21	Darning	

Darning is performed by sewing from the front of the presser foot to the back as shown below.

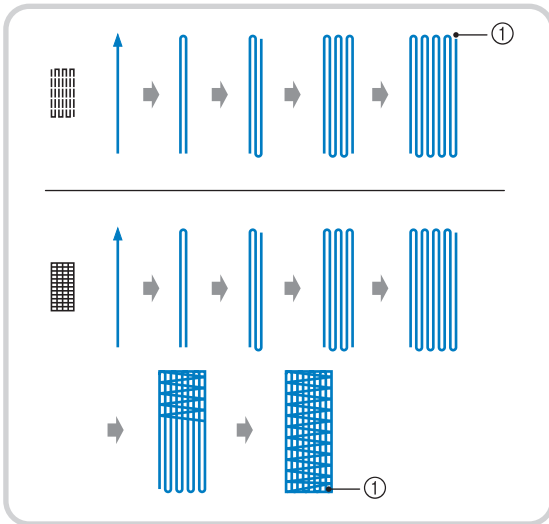

① Reinforcement stitches

1 Select a stitch, and attach buttonhole foot "A+".

Position the upper thread under the presser foot by guiding thread through the hole in the presser foot before attaching the buttonhole foot "A+".

2 Set the scale to the desired length of the darning.

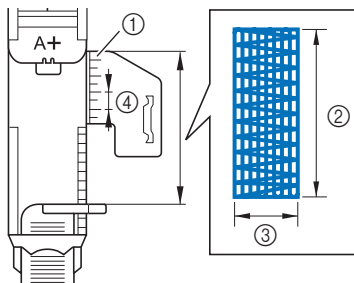

- ① Presser foot scale
- ② Completed length measurement
- ③ Width 7 mm (approx. 1/4 inch)
- ④ 5 mm (approx. 3/16 inch)

3 Check that the needle drops at the desired position and lower the presser foot, making sure the upper thread passes underneath the buttonhole foot.

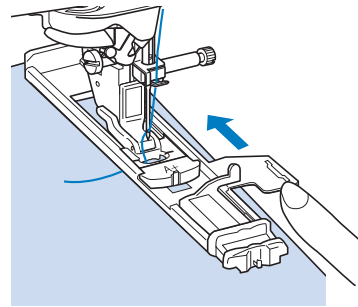

Note

- Pass the thread underneath the presser foot.
- Set the presser foot so that there is no gap behind the section marked with an "A+" (the shaded area in the illustration below). If there is a gap, the size of the darning will not be correct.

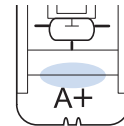

4 Gently hold the end of the upper thread, and then press the "Start/Stop" button to start the machine.

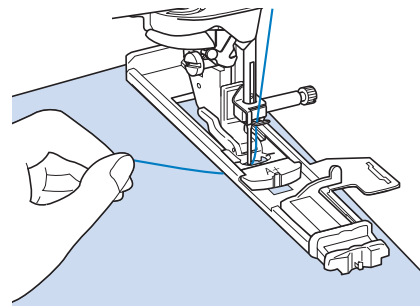

→ Once sewing is completed, the machine automatically sews reinforcement stitches, and then stops.

Bar Tacks

Use bar tacks to reinforce areas that will be subject to strain, such as pocket corners.

Stitch	Stitch name	Presser foot
4-22	Bar tack	A+

1 Select .

2 Attach buttonhole foot "A+" and set the scale to the length of the bar tack you wish to sew.

Position the upper thread under the presser foot by guiding thread through the hole in the presser foot before attaching the buttonhole foot "A+".

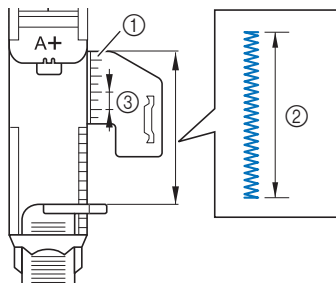

- ① Presser foot scale
- ② Completed length measurement
- ③ 5 mm (approx. 3/16 inch)

3 Set the fabric so that the pocket moves toward you during sewing.

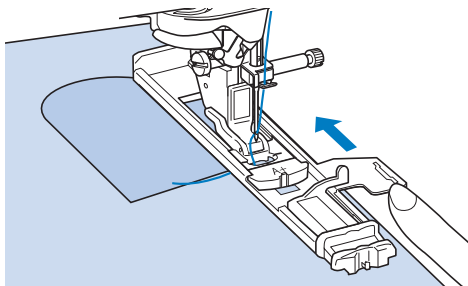

Note

- Pass the thread underneath the presser foot.
- Slide the outside frame of the buttonhole foot backward as far as possible as shown in the illustration, making sure that there is no gap behind the part of the foot marked "A+". If the buttonhole foot is not slid back as far as possible, the bar tack will not be sewn to the correct size.

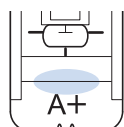

4 Check the first needle drop point and lower the presser foot.

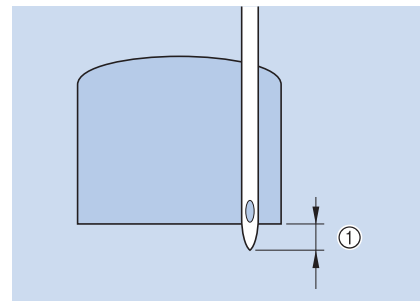

- ① 2 mm (approx. 1/16 inch)

5 Gently hold the end of the upper thread and begin sewing.

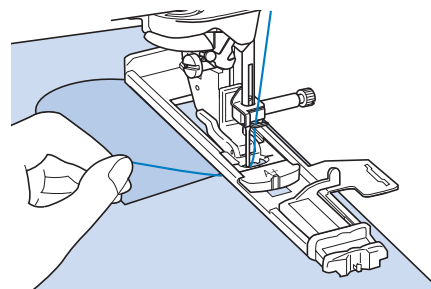



- When sewing is completed, the machine will sew reinforcement stitches and stop automatically.

3

Utility Stitches

Button Sewing

Buttons with 2 or 4 holes can be attached, using the machine.

Stitch	Stitch name	Presser foot
	Button sewing	

Note

- Do not use the automatic thread cutting function when sewing buttons. Otherwise, you will lose the thread ends.

1 Select .

→ The feed dogs are lowered automatically.

2 Raise the presser foot.

3 Attach button fitting foot “M”, slide the button along the metal plate and into the presser foot, and lower the presser foot.

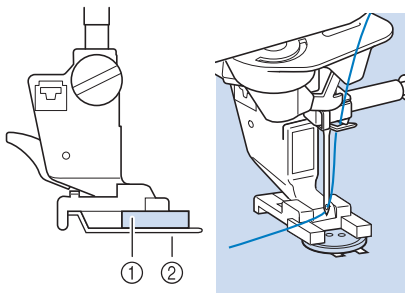

- ① Button
- ② Metal plate

4 Rotate the handwheel toward you (counterclockwise) to check that the needle goes into each hole correctly.

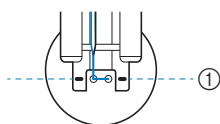

- ① Align the holes of the button with the marks on button fitting foot “M”.

* If the needle does not reach the holes on the left side, adjust the stitch width.

5 Gently hold the end of the upper thread and start sewing.

→ The machine stops automatically when sewing is finished.

IMPORTANT

- Make sure the needle does not strike the button during sewing.

* To attach the button more securely, repeat the process.

6 From the wrong side of the fabric, pull the end of the bobbin thread to pull the upper thread through to the wrong side of the fabric. Tie the two thread ends together then cut the threads.

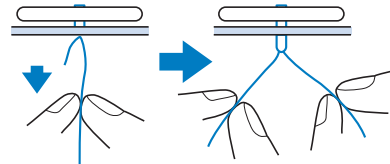

7 After the button is attached, select another stitch and rotate the handwheel toward you (counterclockwise) to raise the feed dogs.

■ Attaching 4-Hole Buttons

Sew the two holes closest to you. Then raise the presser foot and move the fabric so that the needle goes into the next two holes, and sew them in the same way.

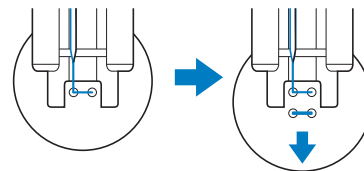

■ Attaching a Shank to the Button

- 1 Pull the shank lever toward you before sewing.

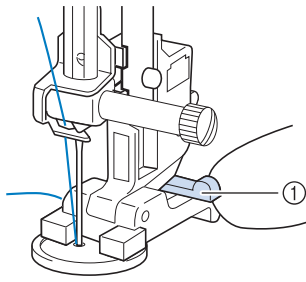

① Shank lever

- 2 After sewing is finished, cut the upper thread with plenty of excess, wind it around the thread between the button and the fabric, and then tie it to the upper thread from the beginning of the stitching.

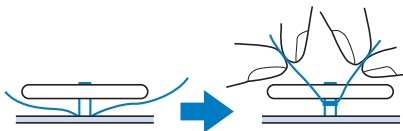

- 3 Tie the ends of the bobbin thread from the beginning and end of sewing together on the wrong side of the fabric.

Note

- When sewing is completed, be sure to select another stitch and rotate the handwheel toward you (counterclockwise) to raise the feed dogs.

- 4 Cut off any excess thread.

Eyelet

Use this stitch for making belt holes and other similar applications.

Stitch	Stitch name	Presser foot
4-24	Eyelet	
4-25	Star eyelet	

- 1 Select or .

- 2 Use in either the stitch width display or the stitch length display to choose the size of the eyelet.

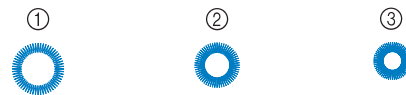

- ① Large 7 mm (approx. 9/32 inch)
- ② Medium 6 mm (approx. 15/64 inch)
- ③ Small 5 mm (approx. 13/64 inch)

Memo

- Only one size is available for .

- 3 Attach advanced monogramming foot “N+”, then rotate the handwheel toward you (counterclockwise) to check the needle drop position.

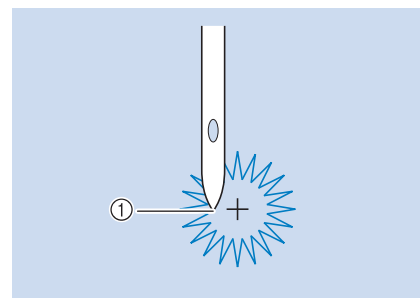

- ① Needle drop position

- 4 Lower the presser foot and start sewing.

→ When sewing is finished, the machine sews reinforcement stitches and stops automatically.

Note

- If the stitch pattern comes out poorly, make adjustments to “SEWING STITCH PATTERNS” on page 150.

- 5 Use the eyelet punch to make a hole in the center of the stitching.

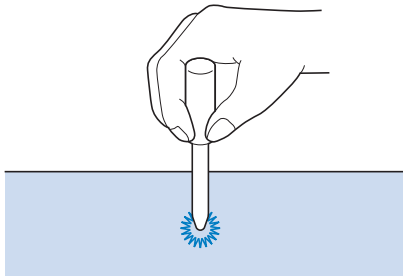

Multi-directional Sewing (Straight Stitch and Zigzag Stitch)

Use these stitch patterns to attach patches or emblems to pant legs, shirt sleeves, etc.

- 1 Remove the flat bed attachment to use the free-arm.

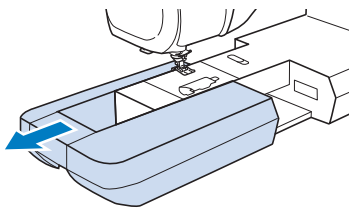

Memo

- Insert the tubular piece of fabric onto the free-arm, and then sew in the order shown in the illustration.

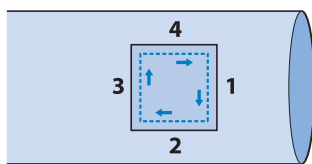

- 2 Select  and attach advanced monogramming foot "N+".

Memo

- For details on each stitch, refer to "STITCH SETTING CHART" on page 198.

- 3 Set the needle in the fabric at the sewing start point, and sew seam "1" as shown.

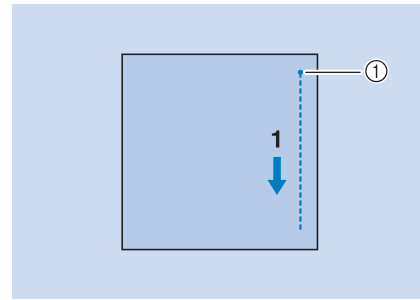

- ① Start Point

- 4 Select  and sew seam "2" as shown.

- * The fabric will move sideways, guide the fabric by hand to keep sewing straight.

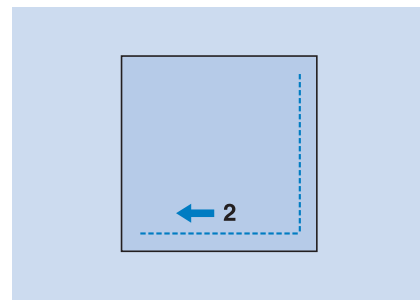

- 5 Select  and sew seam "3" as shown.

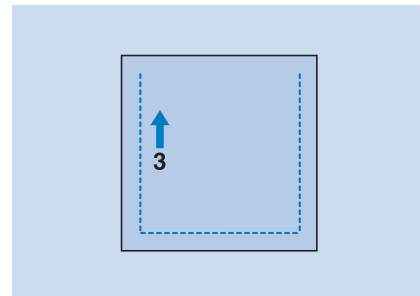

→ The fabric feeds forward while stitching backward.

- 6 Select  and sew seam "4" as shown.

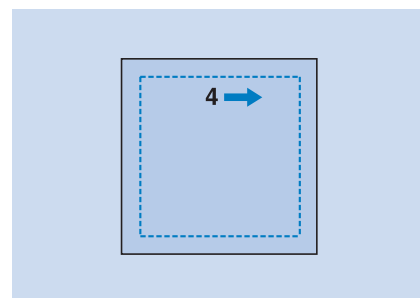

→ The seam will be connected to the starting point of seam 1.

Zipper Insertion

■ Centered Zipper

Use for bags and other such applications.

1 Select .

Memo

- For details on each stitch, refer to “STITCH SETTING CHART” on page 198.

Note

- Make sure you sew using the middle needle position.

2 Attach presser foot “J” and sew straight stitches up to the zipper opening. Change to a basting stitch (page 125) and sew to the top of the fabric.

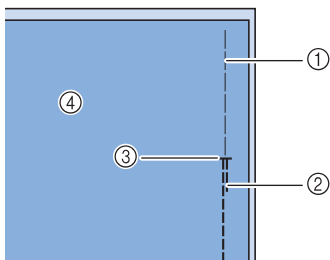

- ① Basting stitches
- ② Reverse stitches
- ③ End of zipper opening
- ④ Wrong side

3 Press the seam allowance open and attach the zipper with a basting stitch in the middle of each side of the zipper tape.

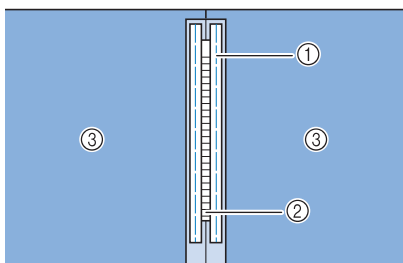

- ① Basting stitches
- ② Zipper
- ③ Wrong side

4 Remove presser foot “J”. Align the right side of the pin in zipper foot “I” with the presser foot holder, and attach the zipper foot.

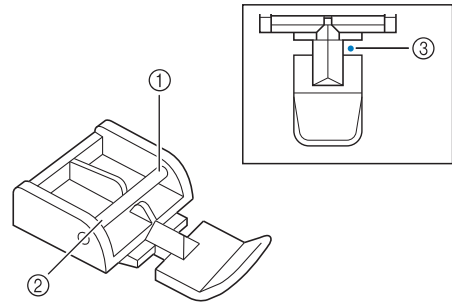

- ① Right
- ② Left
- ③ Needle drop position

Note

- When using zipper foot “I”, make sure the straight stitch, middle needle position is selected. Rotate the handwheel toward you (counterclockwise) to make sure the needle does not strike the presser foot.

5 Topstitch 7 to 10 mm (approx. 1/4 to 3/8 inch) from the seamed edge of the fabric, then remove the basting.

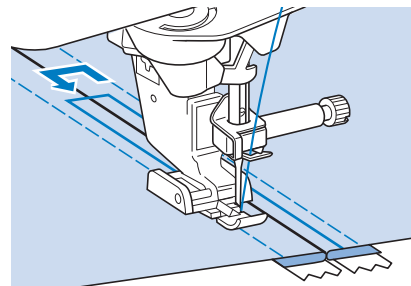

CAUTION

- Make sure the needle does not strike the zipper during sewing. If the needle strikes the zipper, the needle may break, leading to injury.

■ Inserting a Side Zipper

Use for side zippers in skirts or dresses.

- 1** Select .

Note

- Make sure you sew using the middle needle position.

- 2** Attach presser foot “J” and sew straight stitches up to the zipper opening. Change to a basting stitch and sew to the top of the fabric.

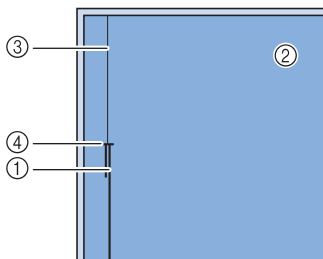

- ① Reverse stitches
- ② Wrong side of fabric
- ③ Basting stitches
- ④ End of zipper opening

- 3** Press the seam allowance open and align the folded hem along the teeth of the zipper, while maintaining 3 mm (approx. 1/8 inch) of sewing space.

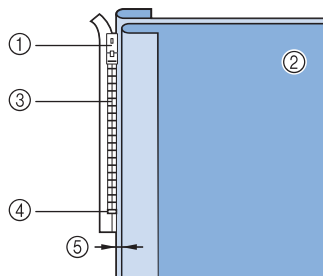

- ① Zipper pull tab
- ② Wrong side of fabric
- ③ Zipper teeth
- ④ End of zipper opening
- ⑤ 3 mm (approx. 1/8 inch)

- 4** Remove presser foot “J”.

- 5** Align the right side of the pin in zipper foot “I” with the presser foot holder, and attach the presser foot.

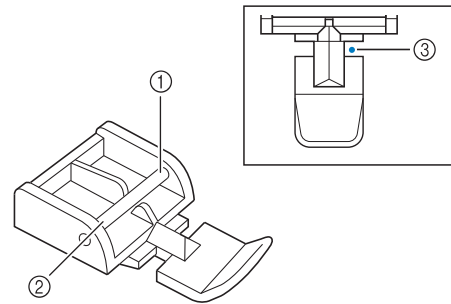

- ① Right
- ② Left
- ③ Needle drop position

Note

- When using zipper foot “I”, make sure the straight stitch, middle needle position is selected. Rotate the handwheel toward you (counterclockwise) to make sure the needle does not strike the presser foot.

- 6** Set the presser foot in the 3 mm (approx. 1/8 inch) margin.

- 7** Starting from the end of the zipper opening, sew to a point about 50 mm (approx. 2 inches) from the edge of the fabric, then stop the machine.

- 8** Pull down the zipper slider, then continue sewing to the edge of the fabric.

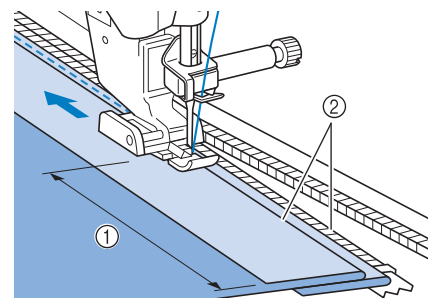

- ① 50 mm (approx. 2 inches)
- ② 3 mm (approx. 1/8 inch)

⚠ CAUTION

- Make sure the needle does not strike the zipper during sewing. If the needle strikes the zipper, the needle may break, leading to injury.

- 9** Close the zipper, turn the fabric over, and sew a basting stitch.

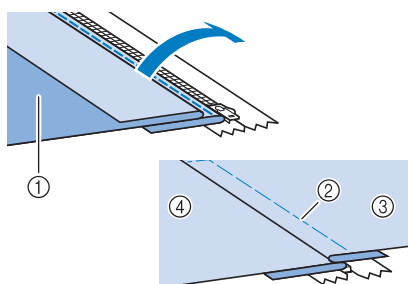

- ① Front of the skirt (wrong side of fabric)
- ② Basting stitches
- ③ Front of the skirt (right side of fabric)
- ④ Back of the skirt (right side of fabric)

- 10** Remove the presser foot, and reattach it so that the left side of the pin is attached to the presser foot holder.

- * When sewing the left side of the zipper, the needle should drop on the right side of the presser foot. When sewing the right side of the zipper, the needle should drop on the left side of the presser foot.

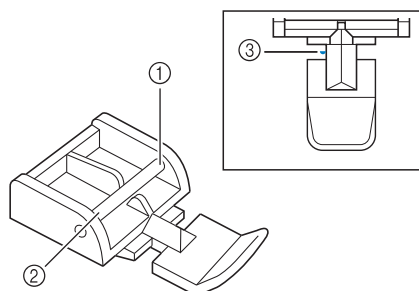

- ① Right
- ② Left
- ③ Needle drop position

- 11** Set the fabric so that the left edge of the presser foot touches the edge of the zipper teeth.

- 12** Sew reverse stitches at the end of the zipper, then continue sewing.

- 13** Stop sewing about 50 mm (approx. 2 inches) from the edge of the fabric, leave the needle in the fabric, and remove the basting stitches.

- 14** Open the zipper and sew the rest of the seam.

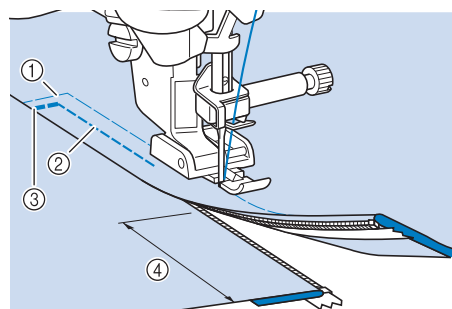

- ① Basting stitches
- ② 7 to 10 mm (approx. 1/4 inch to 3/8 inch)
- ③ Reverse stitches
- ④ 50 mm (approx. 2 inches)

Changing the Start and End Angles of the Stitch Pattern (Stitch Tapering Function)

The angles of the start and end of stitch patterns can be changed. This is useful when sewing projects with sharply defined angles or decorative stitching, attaching appliqués, etc.

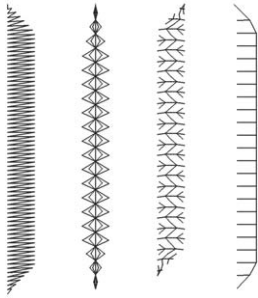

Use the method for finishing sewing the stitch pattern, according to your needs.

- Method 1: Begin Changing the Angle at the End of Sewing by Pressing the “Reverse Stitch” Button (page 142)
- Method 2: Sewing a Specified Number of Stitch Patterns (page 143)
- Method 3: Specifying the Sewing End Point with an End Point Sticker (page 144)

Note

- Using the same material and stitch pattern as your project, sew trial stitches to check the result. If necessary, attach a stabilizer material.
- If reinforcement stitches at the beginning and end of sewing are needed, use “Reinforcement Stitch” button. “Reverse Stitch” button cannot be used for reinforcement stitching when stitch tapering function is on.

Method 1: Begin Changing the Angle at the End of Sewing by Pressing the “Reverse Stitch” Button

1 Touch , then , and then select a stitch pattern for stitch tapering.

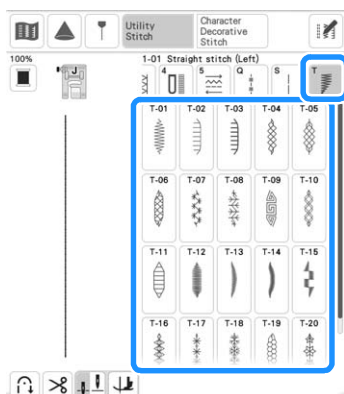

2 If necessary, change the stitch width and stitch length.

3 Touch , and then touch .

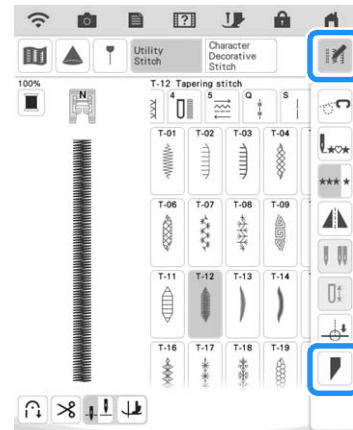

4 Touch , select the angle settings for the start and end of sewing, and then touch .

OK

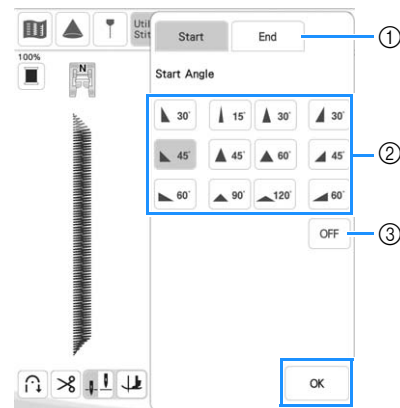

- ① Select the start or end of sewing.
- ② Select an angle.
- ③ Specify that the angle does not change.

- 5 Select the method for finishing sewing. For this example, since the angle at the end of sewing will begin changing when the "Reverse Stitch" button is pressed, select .

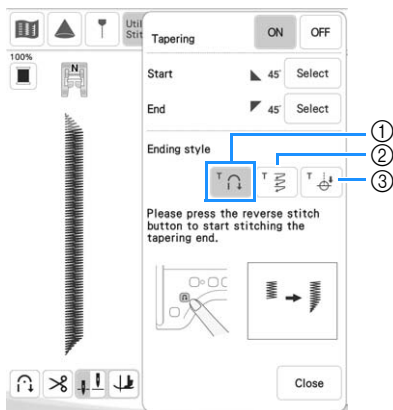

- 1 Press the "Reverse Stitch" button for the angle at the end of sewing to start changing; the machine stops when sewing is finished.
- 2 The machine stops when the specified number of stitch patterns have been sewn. The number of patterns that are specified includes the number of patterns used to change the angle. (page 143)
- 3 The machine stops at the position where the end point sticker is affixed. (page 144)

- 6 If necessary, use a chalk pencil to draw a line at the location to be sewn.
- 7 Start sewing.
- 8 After sewing the desired length, press the "Reverse Stitch" button.

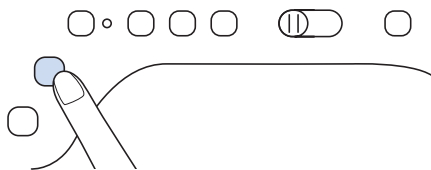

→ When the "Reverse Stitch" button is pressed, the angle at the end of sewing begins to change, and the machine stops when sewing is finished.

Memo

- If you stop sewing at the point where end tapering should begin (either by pressing the "Start/Stop" button or by lifting your foot from the foot controller), press the "Reverse Stitch" button and resume sewing by either pressing the "Start/Stop" button or pressing on the foot controller. End tapering will begin as soon as sewing resumes.

- 9 When finished sewing, set [Tapering] to [OFF], and then touch .

Method 2: Sewing a Specified Number of Stitch Patterns

With this method, the number of stitch patterns (including those used to change the angle) are specified. This allows stitch patterns of the same length to be repeatedly sewn.

- 1 Refer to steps 1 through 4 of "Method 1: Begin Changing the Angle at the End of Sewing by Pressing the "Reverse Stitch" Button" on page 142 to select the angle settings for the start and end of sewing.
- 2 Touch , and then specify the number of stitch patterns (including those used to change the angle).

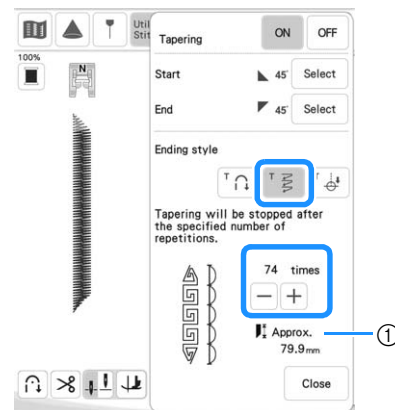

- 1 Approximate length of the stitch pattern



Memo

- The number of stitch patterns used to change the angle depends on the pattern and angle. Perform trial sewing to check the result.

- 3 Start sewing.

→ The machine stops automatically when sewing is finished.

Memo

- To sew stitching in a square, select  for the start of sewing and  for the end of sewing, and then continue sewing the same stitch pattern, rotating the fabric 90° after sewing each line of stitching. The pivot setting is useful when changing the sewing direction. (page 76)

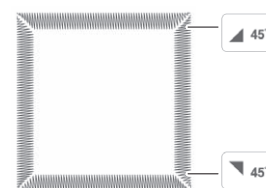

Method 3: Specifying the Sewing End Point with an End Point Sticker

Note

- For details on the procedure as well as precautions, refer to “Specifying the Sewing End Point” on page 86.

- With a chalk pencil, mark the fabric with lines for sewing the stitch pattern and for the end of stitching.
- Affix an end point sticker, avoiding the sewing area. Attach the end point sticker within 4 cm (approx. 1-1/2 inches) to the left or right of the chalkline where the end point for sewing has been drawn.

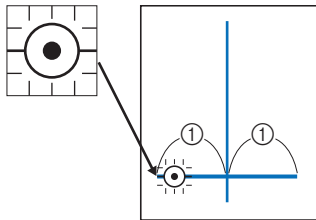

① 4 cm (Approx. 1-1/2 inches)

Memo

- If you cannot affix an end point sticker avoiding the sewing area, refer to “Temporary Stop Setting” on page 87.



- Refer to steps ① through ④ of “Method 1: Begin Changing the Angle at the End of Sewing by Pressing the “Reverse Stitch” Button” on page 142 to select the angle settings for the start and end of sewing.
- Touch .

- * If the key appears in light gray, this function cannot be used with the selected stitch length.

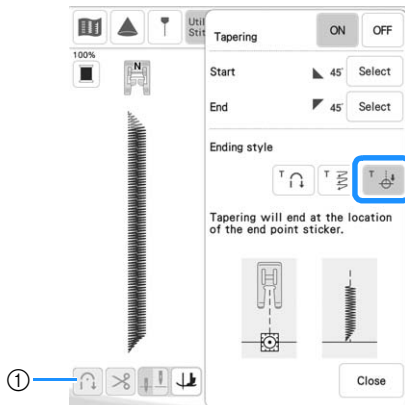

- Automatic reinforcement stitching function and automatic thread cutting function are not available.

- Start sewing.

→ The machine stops automatically when sewing is finished.

- Peel off the end point sticker.

Saving Settings

Specified angles for start and end, finish tapering method, and stitch settings can be saved in machine's memory.

- After setting the tapering function, touch .

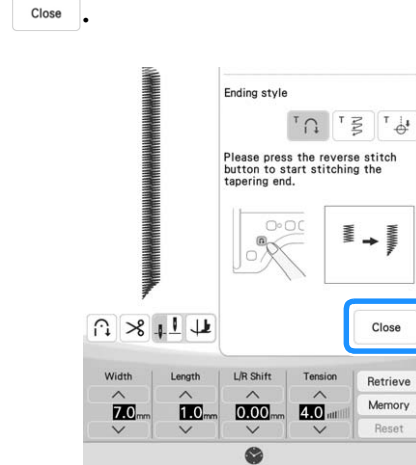

- Touch .

Retrieving Saved Settings

- Touch to retrieve the saved setting after selecting pattern.
- Touch the numbered key of the settings to be retrieved and then touch .

- * The settings cannot be retrieved if stitch tapering function is set to [ON].

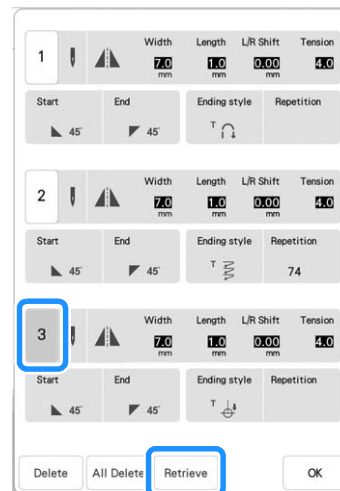

Memo

- For more information on saving and recalling settings, refer to “Saving Your Stitch Settings” on page 96.











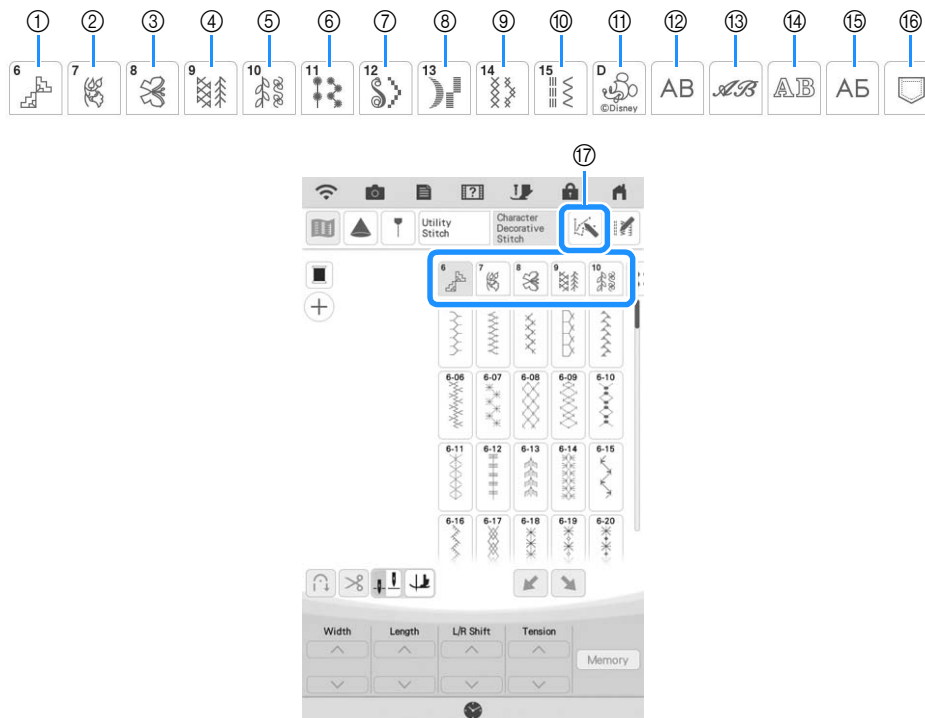





Chapter **4**

Character/Decorative Stitches

SELECTING STITCH PATTERNS

Touch , then  to display the screen below.



No.	Display	Category Name
①		Wide and Various
②		Wide Botanical
③		Wide Motifs and Messages
④		Narrow and Various
⑤		Narrow Botanical
⑥		Candlewicking
⑦		Large Satin
⑧		Satin
⑨		Cross Stitches
⑩		Combinable Utility
⑪		Disney
⑫		Alphabet Characters (Gothic Font)
⑬		Alphabet Characters (Handwriting Font)
⑭		Alphabet Characters (Outline)
⑮		Cyrillic font
⑯		Pocket (page 164)
⑰		Touch this key to create your own stitches with the “MY CUSTOM STITCH” function. (page 170)

Stitch Selection Screens

Wide and Various

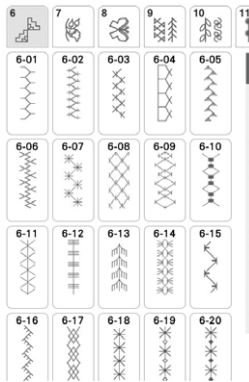

Wide Botanical

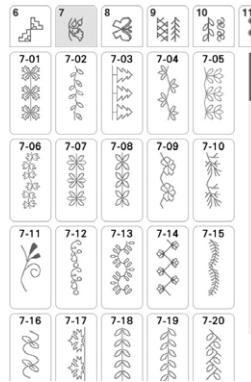

Wide Motifs and Messages



Narrow and Various

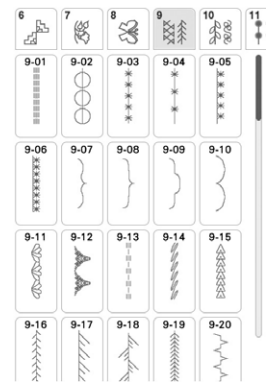

Narrow Botanical

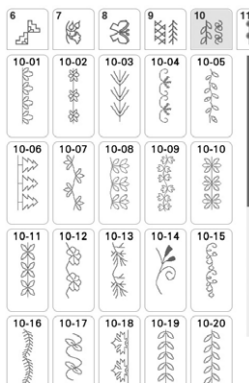

Candlewicking

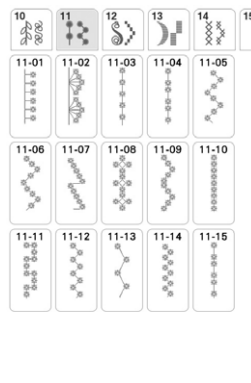

Large Satin

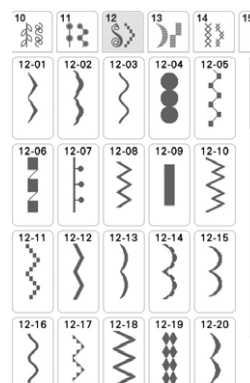

Satin

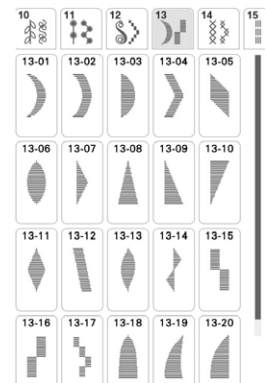

Cross Stitches

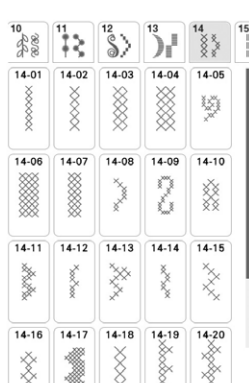

Combinable Utility

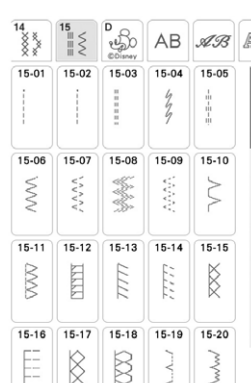

Disney

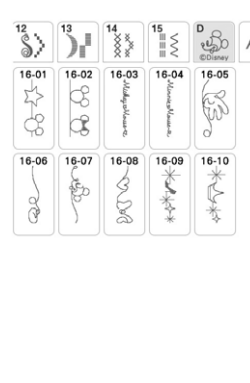

Alphabet Characters (Gothic Font)



Alphabet Characters (Handwriting Font)



Alphabet Characters (Outline)



Cyrillic Font

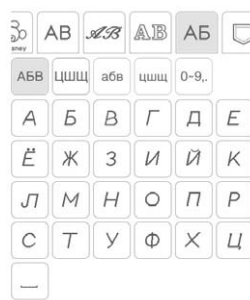

Character/Decorative Stitches

Selecting Decorative Stitch Patterns

- 1 Select the category of the stitch pattern you want to sew.
- 2 Touch the key of the stitch pattern you want to sew.

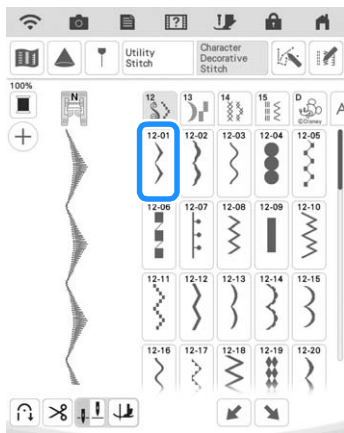

→ The selected stitch pattern is displayed.

Selecting Character Stitch Patterns

Entering characters from the groups shown below, for example [Blue Sky].

- 1 Touch **AB**, **ABC**, **AB** or **AB** to select a font.



- 2 Touch to change the selection screens.

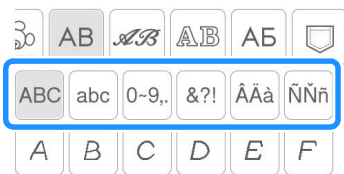

- 3 Touch **ABC** and then enter [B].
- 4 Touch **abc** and then enter [lue].

- 5 Touch **—** to enter a space.

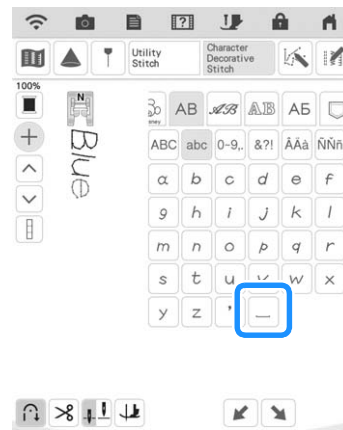



- 6 Touch **ABC** again and enter [S].

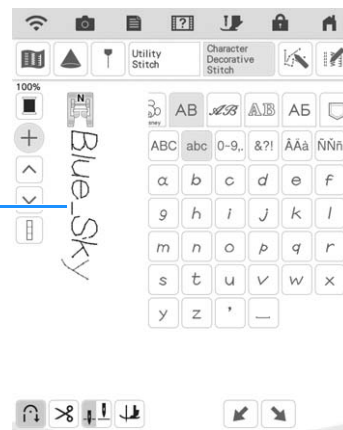
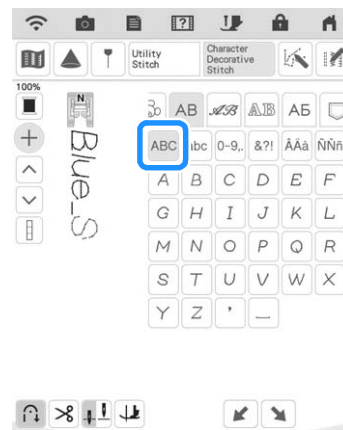

- 7 Touch **abc** and then enter [ky].



- ① Jump stitch
- * Remove the jump stitches after sewing.
- * To continue entering characters in a different font, select the other font, and then repeat the procedure from step 1.

■ Deleting Characters





- 1 Touch , and then touch  to delete the last character.

- * To delete other characters, touch  or  to select the desired character before touching .





- 2 Select the correct character.

■ Adding Characters

- 1 Touch  so that screen displays .
- 2 Touch  or  to select the character in front of the character where you want to add characters.
- 3 Select the character you want to add.

■ Adjusting the Character Spacing

The space between the characters can be adjusted.



- 1 Touch , and then touch .



→ The character spacing window appears.

- 2 Touch   to adjust character spacing.



- * Touch  to increase the character spacing and touch  to decrease the character spacing.

Memo

- Changing character spacing by this method, pertains to all characters. Spacing changes are valid not only while entering characters but also before and after the entering of characters.

SEWING STITCH PATTERNS

Sewing Attractive Finishes

To achieve attractive results when sewing character/decorative stitches, check the table below for the proper fabric/needle/thread combinations.

Note

- Other factors, such as fabric thickness, stabilizer material, etc., also have an effect on the stitch, so you should always sew a few trial stitches before beginning your project.
- When sewing satin stitch patterns, there may be shrinking or bunching of stitches, so be sure to attach a stabilizer material.
- Guide the fabric with your hand to keep the fabric feeding straight and even during sewing.

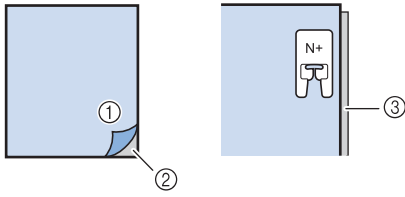
Fabric	<p>When sewing on stretch fabrics, lightweight fabrics, or fabrics with coarse weaves, attach stabilizer on the wrong side of the fabric. If you do not wish to do so, place the fabric on a thin paper such as tracing paper.</p>  <p>① Fabric ② Stabilizer ③ Thin paper</p>
Thread	#50 - #60
Needle	<p>With lightweight, regular, or stretch fabrics: the Ball point needle (golden colored)</p> <p>With heavyweight fabrics: home sewing machine needle 90/14</p>
Presser foot	<p>Advanced monogramming foot "N+".</p> <p>Using another presser foot may give inferior results.</p>

Basic Sewing

- 1 Select a stitch pattern.
- 2 Attach advanced monogramming foot "N+".
- 3 Place the fabric under the presser foot, pull the upper thread out to the side, and then lower the presser foot.

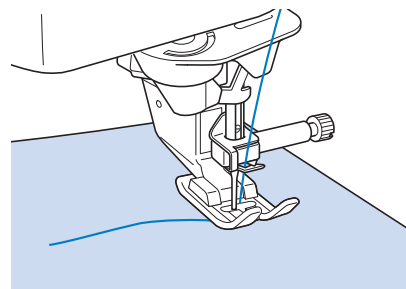

- 4 Press the "Start/Stop" button to start sewing.

* Begin stitching by holding the "Reverse Stitch" or "Reinforcement Stitch" button to sew 3-4 stitches.

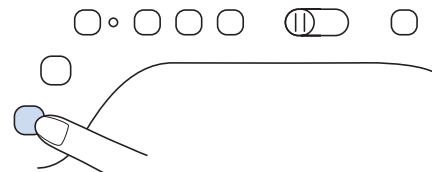

IMPORTANT

- When sewing 7 mm satin stitch patterns and the stitches are bunched, lengthen the stitch length. If you continue sewing when the stitches are bunched, the needle may bend or break ("Setting the Stitch Length" on page 73).

Memo

- If the fabric is pulled or pushed during sewing, the stitch pattern may not turn out correctly. Also, depending on the stitch pattern, there may be movement to the left and right as well as front and back. Guide the fabric with your hand to keep the fabric feeding straight and even during sewing.

- 5 Press the “Start/Stop” button to stop sewing.
- 6 Keep pressing the “Reverse Stitch” button or the “Reinforcement Stitch” button to sew 4 stitches of reinforcement stitches.

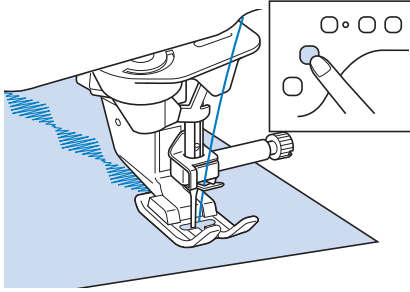

Memo

- When sewing character stitches, the machine automatically sews reinforcement stitches at the beginning and end of each character.

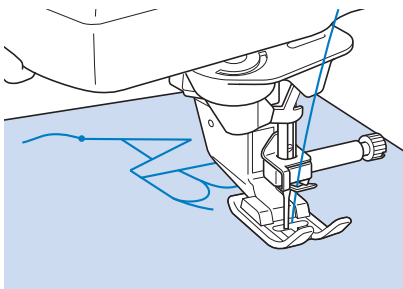

- After sewing is finished, use a seam ripper to trim any excess thread (jump stitches).

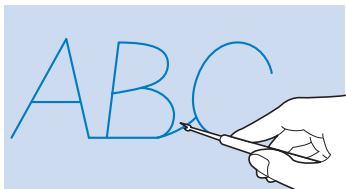

Making Adjustments

Your stitch pattern may sometimes turn out poorly, depending on the type or thickness of fabric, the stabilizer material used, sewing speed, etc. If your sewing does not turn out well, sew trial stitches using the same conditions as the real sewing, and adjust the stitch pattern as explained below. If the stitch pattern does not turn out well even

after making adjustments based on the  stitch pattern, make adjustments for each stitch pattern individually.

- 1 Touch  and select .

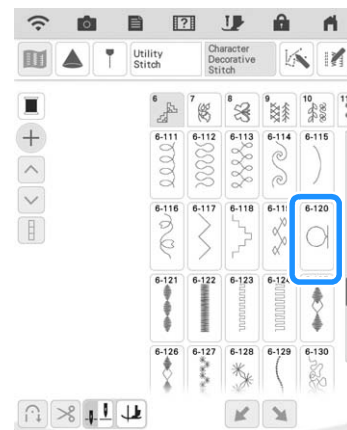

- 2 Attach advanced monogramming foot “N+” and sew the stitch pattern.

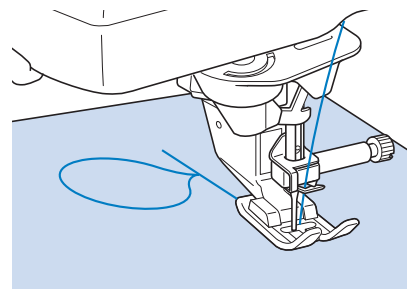

- 3 Compare the finished stitch pattern to the illustration of the correct stitch pattern below.

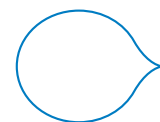

- 4** Touch , and then adjust the stitch pattern with the [Fine Adjust Verti.] or [Fine Adjust Horiz.] displays.

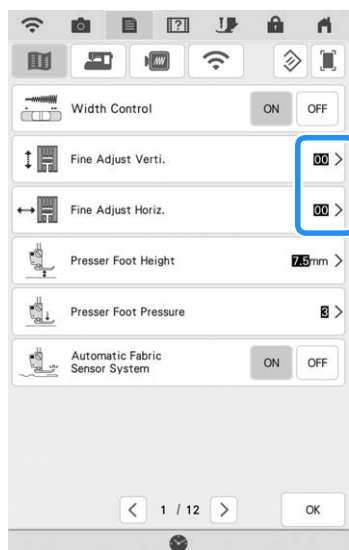

- * If the stitch pattern is bunched:
Touch to increase the number in the [Fine Adjust Verti.] display.
→ The stitch pattern will lengthen.



- * If the stitch pattern has gaps:
Touch to decrease the number in the [Fine Adjust Verti.] display.
→ The stitch pattern will shorten.

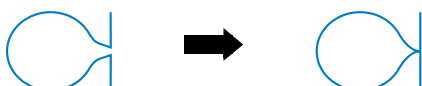

- * If the stitch pattern is skewed to the left:
Touch to increase the number in the [Fine Adjust Horiz.] display.
→ The stitch pattern will slide to the right.

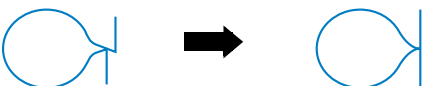

- * If the stitch pattern is skewed to the right:
Touch to decrease the number in the [Fine Adjust Horiz.] display.
→ The stitch pattern will slide to the left.



- 5** Sew the stitch pattern again.

- * If the stitch pattern still comes out poorly, make adjustments again. Adjust until the stitch pattern comes out correctly.

Memo

- You can sew with the setting screen on the display.

- 6** Touch  to return to the original screen.

EDITING STITCH PATTERNS









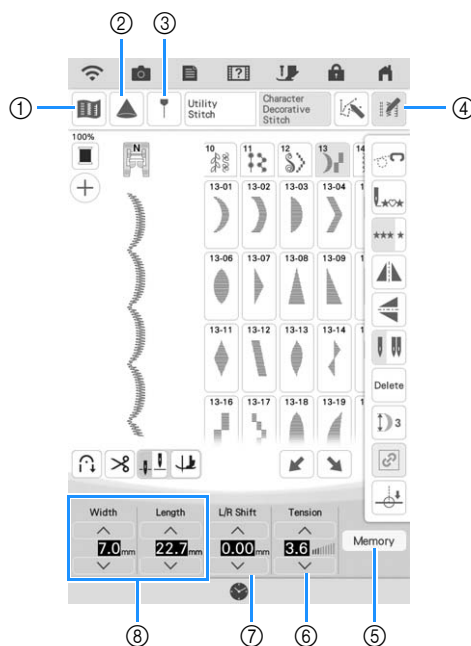



Key Functions

You can create just the finish you want using the editing functions. Make stitch patterns larger or smaller, make mirror images, etc.

 **Memo**

- Some editing functions cannot be used with certain stitch patterns. Only the functions for the displayed keys are available when a stitch pattern is selected.



No.	Display	Key Name	Explanation	Page
①		Image key	Touch this key to display an enlarged image of the selected stitch pattern.	95
②		Projector key	Touch this key to use projector functions.	82
③		Guideline marker key	Touch this key to display or set the guideline marker for the sewing line. The guideline marker makes quilt piecing or aligning stitching on the fabric edge easier.	84
④		Stitch pattern editing key	Touch this key to display editing function keys on the screen.	155
⑤		Memory key	Use this key to save stitch pattern combinations or stitches with modified/customized settings.	163
⑥		Thread tension key	Shows the automatic thread tension setting of the currently selected stitch pattern. You can use  and  to change the thread tension settings.	74
⑦		[L/R Shift] key	Touch  to shift the stitch pattern to the right or touch  to shift the stitch pattern to the left. This feature is not available on all stitch patterns. Only those applicable will be shifted. The machine default setting is highlighted.	73
⑧		Stitch width and stitch length key	Shows the stitch width and stitch pattern length of the selected stitch pattern. The machine default settings are highlighted.	72, 73

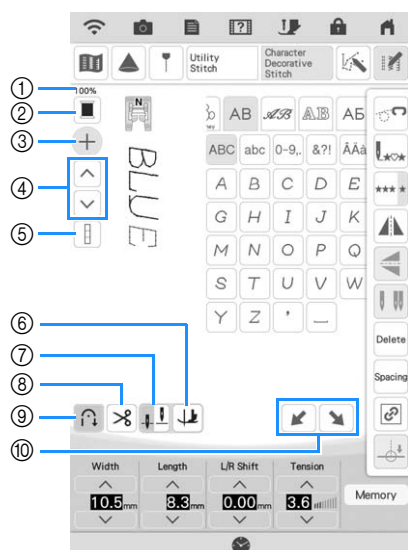

No.	Display	Key Name	Explanation	Page
①	100%	Stitch pattern display size	Show the approximate size of the stitch pattern selected.	—
②		Thread color change key	Touch this key to change the thread color displayed on the screen.	95
③	+	Add stitch pattern key	Touch this key to add a new stitch pattern.	149
④	↑ ↓	Stitch pattern selection key	Touch this key to select the stitch pattern for editing.	149
⑤		Select all on/off key	Touch this key to switch between selecting only the last stitch pattern entered or all combined stitch patterns.	156
⑥		Pivot key / Auto Up key	<p>The pivot key appears when the needle position setting key is set to . Touch this key to select the pivot function. When the pivot function is selected, stopping the machine lowers the needle and slightly raises the presser foot automatically. In addition, when sewing is restarted, the presser foot is automatically lowered.</p> <p>The auto up key appears when the needle position setting key is set to . Touch the auto up key to raise the presser foot when the machine is stopped.</p>	68, 76
⑦		Needle position setting key	<p>Touch this key to select the needle stop position to be up or down. You can also check the needle mode setting (single or twin).</p> <ul style="list-style-type: none"> Single needle/down position Single needle/up position Twin needle/down position Twin needle/up position 	50, 76
⑧		Automatic thread cutting key	Touch this key to set the automatic thread cutting function. Set the automatic thread cutting function before sewing to have the machine automatically sew reinforcement stitches at the beginning and end of sewing (depending on the stitch pattern, the machine may sew reverse stitches) and trim the threads after sewing.	75
⑨		Automatic reinforcement stitch key	Touch this key to use the automatic reinforcement stitching (reverse stitching) setting. If you select this setting before sewing, the machine will automatically sew reinforcement stitches at the beginning and end of sewing (depending on the stitch pattern, the machine may sew reverse stitches).	66
⑩		Step effect key	Touch this key to make step stitch patterns.	161

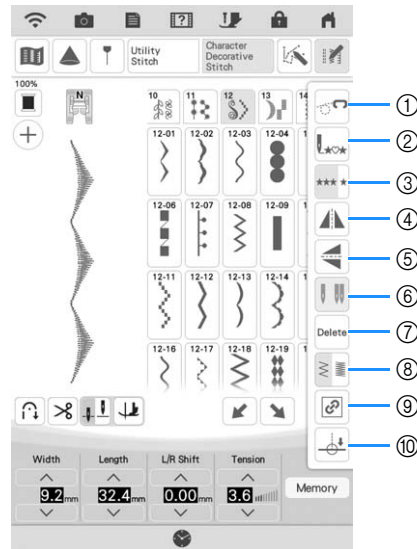

Memo

- Editing function keys are found after touching .



No.	Display	Key Name	Explanation	Page
①		Free motion mode key	Touch this key to enter free motion sewing mode. The feed dog is lowered and presser foot is raised to a height appropriate for free motion quilting.	112
②		Back to beginning key	When sewing is stopped, touch this key to return to the beginning of the stitch pattern.	95
③		Single/Repeat sewing key	Touch this key to choose single stitches or continuous stitches.	156
④		Horizontal mirror image key	After selecting the stitch pattern, use this key to create a horizontal mirror image of the stitch pattern.	156
⑤		Vertical mirror image key	After selecting the stitch pattern, use this key to create a vertical mirror image of the stitch pattern.	156
⑥		Needle mode selection key (single/double)	Touch this key to select twin needle sewing mode. The sewing mode changes between single needle mode and twin needle mode each time you touch the key. If the key display is light gray, the selected stitch pattern cannot be sewn in the twin needle mode.	50
⑦		Delete key	When you make a mistake selecting a stitch pattern, use this key to delete the mistake. When you make a mistake in combining stitch patterns, use this key to delete stitch patterns.	149
⑧	One of the following three keys will appear, depending on the selected stitch pattern.			
		Thread density key	After selecting the stitch pattern, use this key to change the thread density of the stitch pattern.	157
		Elongation key	When 7mm satin stitch patterns are selected, touch this key to choose from 5 automatic length settings, without changing the stitch zigzag width or stitch length settings.	156
		Character spacing key	Touch this key to change the spacing of character stitch patterns.	149
⑨		Maintain aspect ratio key	Touch this key to maintain the aspect ratio when enlarging or reducing the stitch pattern.	156
⑩		End point setting key	Touch this key to specify the sewing end point.	86

Changing the Size

Select a stitch pattern, then touch  or  to change the stitch width and stitch pattern length.

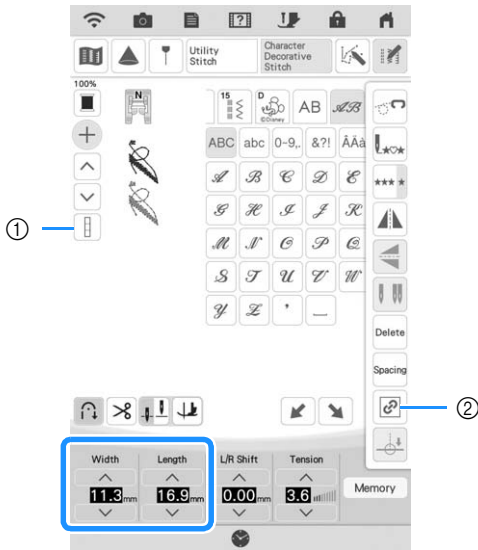



① When the select all on/off key appears as , the size of all stitch patterns can be changed.



② When the maintain aspect ratio key appears as , the stitch pattern size can be changed while maintaining the aspect ratio.



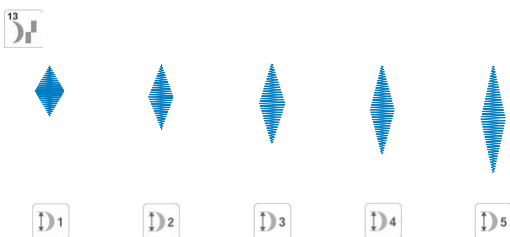

Changing the Length (for 7mm Satin Stitch Patterns Only)

When 7mm satin stitch patterns are selected, touch , and then touch  to choose from 5 automatic length settings, without changing the stitch zigzag width or stitch length settings.





Creating a Vertical Mirror Image

To create a vertical mirror image, select a stitch pattern, touch , and then touch .





Creating a Horizontal Mirror Image

To create a horizontal mirror image, select a stitch pattern, touch , and then touch .



Sewing a Stitch Pattern Continuously

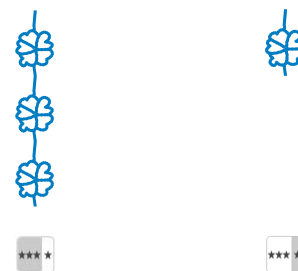

Touch , and then touch  to select continuous sewing or single stitch sewing.



Memo



- To finish a complete motif while sewing the stitch pattern continuously, you can touch the  key while sewing. The machine will automatically stop when the motif is finished.

Changing Thread Density (for Large Satin Only)

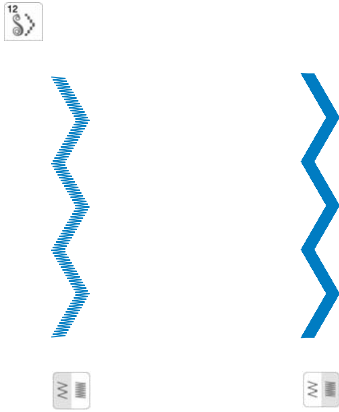
After selecting a satin stitch pattern, touch , and then touch  to select your preferred thread density.



IMPORTANT

- If the stitches bunch when thread density is changed to , return the thread density to . If you continue sewing when the stitches are bunched, the needle may bend or break.

Memo

- When the select all on/off key appears as , the thread density of all stitch patterns can be changed.

COMBINING STITCH PATTERNS

You can combine many varieties of stitch patterns, such as character stitches, cross stitches, satin stitches, or stitches you design with MY CUSTOM STITCH function (see chapter 5 for information about MY CUSTOM STITCH). You can also combine stitch patterns of different sizes, mirror image stitch patterns, and others.

Combining Various Stitch Patterns

Example:



1 Select  and then touch .

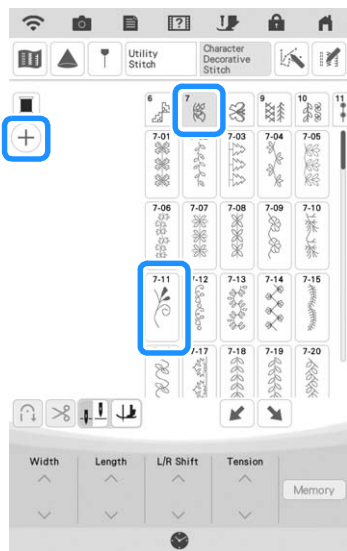

2 Select .

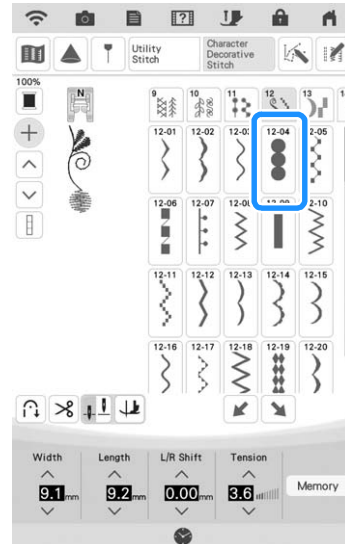

3 Touch , then touch  so that it displays  to sew the stitch pattern continuously.

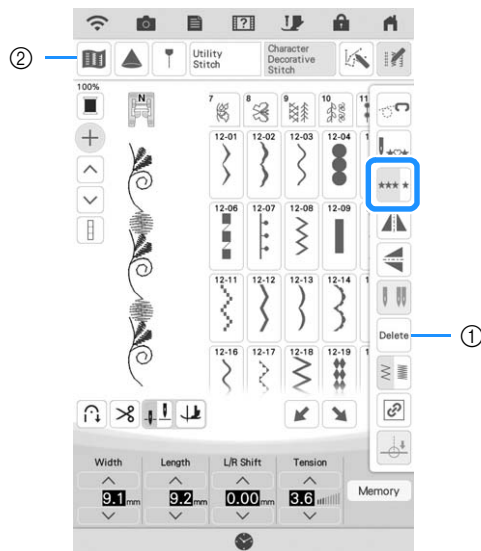







- ① Touch  to delete the last stitch pattern entered. To delete other stitch pattern, touch  or  to select the desired stitch pattern before touching .
- ② Touch this key to view an image of the entire combined stitch pattern.

Combining Large and Small Stitch Patterns

Example:







- 1 Select .
- 2 Touch  so that it displays .
- 3 Select  again, and then touch  or  in the width or length settings to change the size.



→ The size of the stitch pattern changes.

Memo

- To change the size of the stitch pattern while maintaining the aspect ratio, touch  then . If this key appears in light gray, this function cannot be used with the selected stitch patterns.

- 4 Touch , and then touch  so that it displays  to sew the stitch pattern continuously.







→ The entered stitch pattern is repeated.

Combining Horizontal Mirror Image Stitch Patterns

Example:





- 1 Select .
- 2 Touch .

- 3 Select  again, touch , and then touch .



→ The stitch pattern is flipped along a vertical axis.

- 4 Touch  so that it displays  to sew the stitch pattern continuously.



→ The entered stitch pattern is repeated.

Combining Stitch Patterns of Different Length

Example:





- 1 Select , touch , then touch  once.

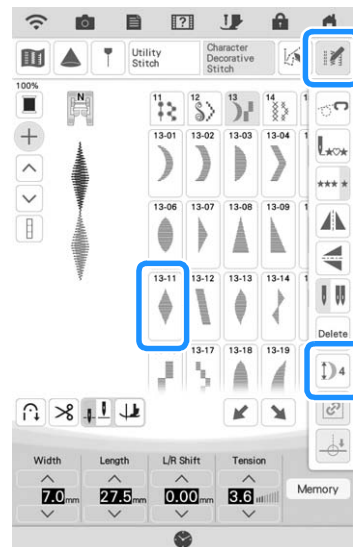

→ The length of the image is set to .

- 2 Touch .

- 3 Select  again, touch , and then touch  3 times.



→ The length of the image is set to .

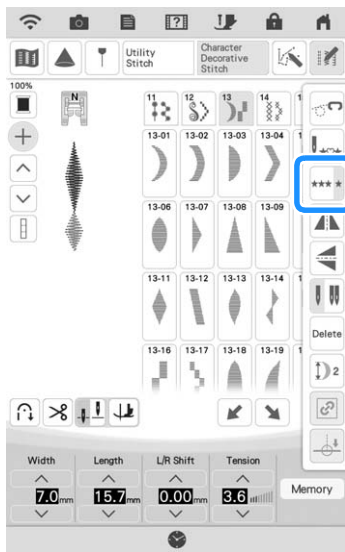

- 4 Touch , and then touch  so that it displays  to sew the stitch pattern continuously.



→ The entered stitch pattern is repeated.

Making Step Stitch Patterns

You can use the   keys to create a step effect, also called step stitch patterns.

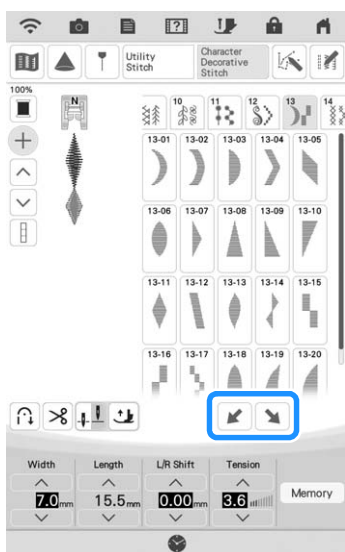

- * Touch  to move the stitch pattern a distance equal to half of the stitch pattern's size to the left.
- * Touch  to move the stitch pattern a distance equal to half of the stitch pattern's size to the right.



Example:



- 1 Select .

- 2 Touch , and then touch .



→ The next stitch pattern will move to the right.

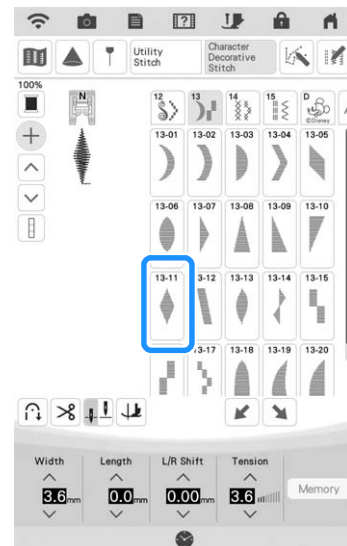

- 3 Select  again.



4 Touch .



→ The next stitch pattern will move to the left.

5 Touch , and then touch .

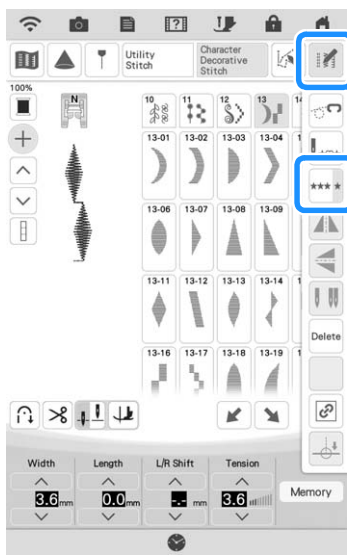

→ The entered stitch pattern is repeated.

More Examples

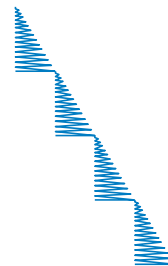
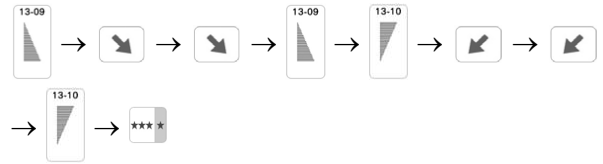
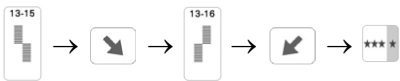

USING THE MEMORY FUNCTION

Memo

- For more information about the memory function, refer to “SPECIFICATIONS” on page 194.

Saving Stitch Patterns

You can save often-used stitch patterns in the machine’s memory or USB media.

Note

- Do not turn the main power to OFF while the [Saving...] screen is displayed. You will lose the stitch pattern you are saving.

1 Touch **Memory**.



2 When saving the stitch pattern in a USB media, insert the USB media into the USB port on the machine.

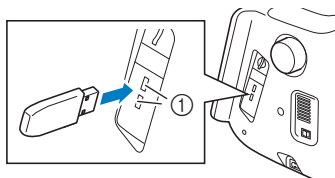

① USB ports

3 Touch the desired destination to start saving.

- * Touch **Cancel** to return to the original screen without saving.

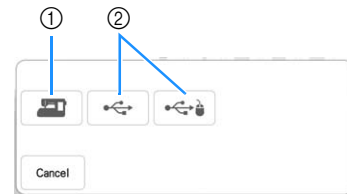

- ① Save to the machine’s memory.
- ② Save to the USB media. The stitch pattern is saved in a folder labeled [bPocket].

■ If the Memory Is Full

If the following screen appears while you are trying to save a stitch pattern, the memory is too full to hold the currently selected stitch pattern. To save the stitch pattern in the machine’s memory, you have to delete a previously saved stitch pattern.

Touch **OK**, and then refer to “Retrieving Stitch Patterns” on page 164 and “Managing Saved File” on page 165.

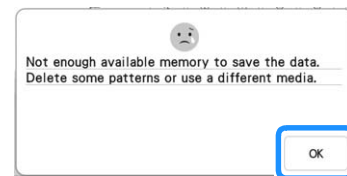

4

Character/Decorative Stitches

Retrieving Stitch Patterns

Retrieve stitch patterns saved in the machine's memory or USB media.

- 1 When retrieving stitch patterns from a USB media, insert the USB media into the USB port on the machine.

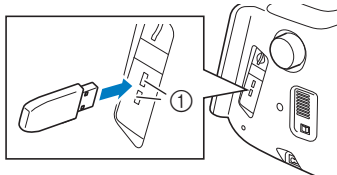

① USB port

- 2 Touch .

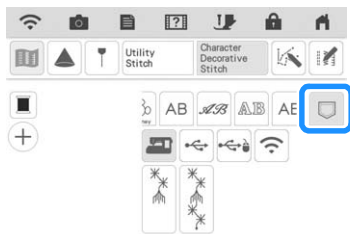

- 3 Touch the desired source.
In this case, touch .

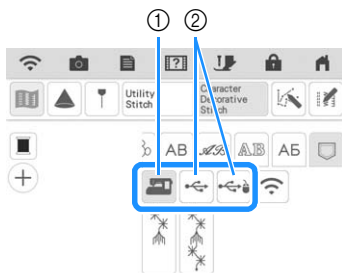

① Retrieve from the machine's memory.
② Retrieve from a USB media.

Memo

- Touch  when there is a subfolder in USB media.

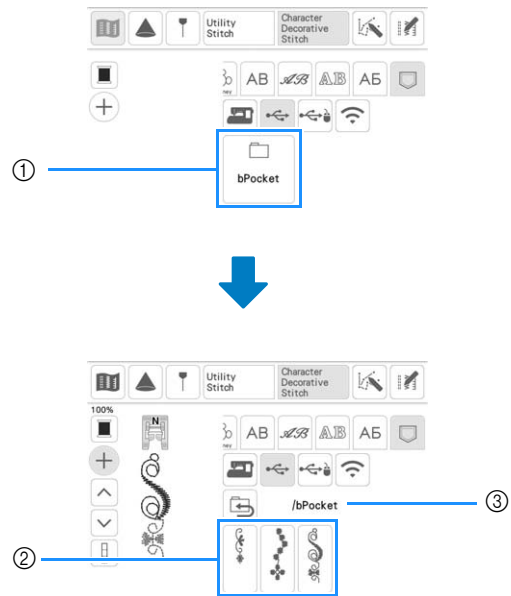

① Folder name
② Stitch patterns in a folder.
③ Path

* Touch  to return to the previous folder.

- 4 Touch the key of the stitch pattern you want to retrieve.

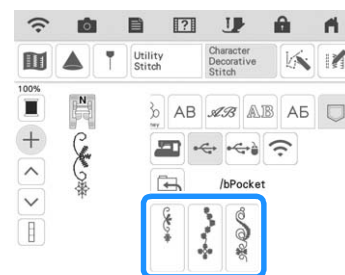

Memo

- Refer to "Managing Saved File" on page 165 for instructions on how to delete saved files or save to machine's memory from USB media.

Managing Saved File





You can delete the saved file or save to machine's memory from USB media.

- 1 Touch , and touch the stitch pattern you want to manage.



- 2 Choose the command.



	Touch to select all displayed stitch patterns.
	Touch to deselect all selected stitch patterns.
	Touch to delete the selected stitch patterns.
	Touch to save the selected stitch patterns in the machine's memory.

Transferring Stitch Patterns to the Machine (PE-DESIGN to this machine)

For detailed procedures, refer to PE-DESIGN manual (Version 11 or higher).

- 1 In the stitch pattern selection screen, touch , and then touch .

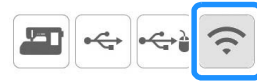

→ The stitch patterns transferred from the application appear.



Chapter **5**

MY CUSTOM STITCH

DESIGNING A STITCH

By using the MY CUSTOM STITCH function, you can register stitches you have created yourself. You can also sew designs combining MY CUSTOM STITCH creations with built-in characters. (page 158)

Memo

- Stitches that you create with MY CUSTOM STITCH can be a maximum of 7 mm (approx. 9/32 inch) wide and 37 mm (approx. 1-1/3 inches) long.
- Stitches can be designed more easily with MY CUSTOM STITCH if you first draw the stitch on the included grid sheet.

1 Draw the stitch design on the grid sheet.

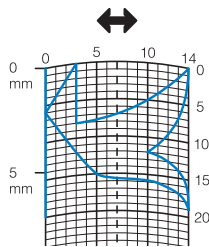

Memo

- Simplify the design so that it can be sewn as a continuous line. For a more attractive stitch, close the design by intersecting lines.

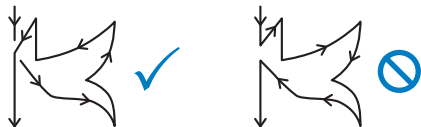

If the design is to be repeated and linked, the start point and end point of the design should be at the same height.



2 Decide the spacing of the stitch.

- * By adjusting the spacing of a stitch, you can create various stitch patterns with one stitch.

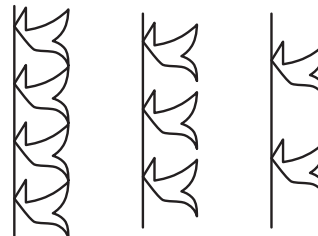
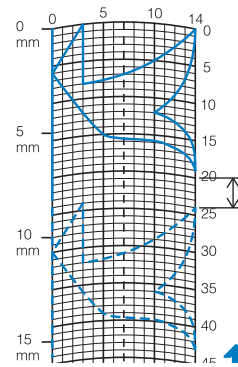

3 Place points where the stitch pattern intersects with the grid, and connect all the points with a line.

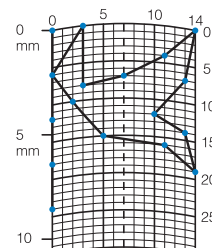



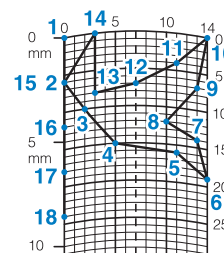



4 Determine the x and y coordinates of each of the marked points.

















Memo







- This will determine the stitch design that will be sewn.

Examples of Custom Stitches

	Stitch	1	2	3	4	5	6	7	8	9	10	11	12	13	14	15
		0	12	18	22	23	21	17	14	12	9	6	3	1	3	6
		0	0	3	6	10	13	14	13	11	13	14	13	10	6	3
	Stitch	16	17	18	19	20	21	22	23	24	25	26	27	28	29	30
		12	41	43	40	41	38	35	32	30	32	35	41	45	47	44
		0	0	4	7	11	13	14	13	10	6	3	0	0	4	7
	Stitch	31	32	33	34	35	36	37	38	39	40	41	42	43	44	45
	45	47	50	54	56	55	51	45	70							
	11	13	14	13	10	6	3	0	0							

	Stitch	1	2	3	4	5	6	7	8	9	10	11	12	13	14	15
		0	30	32	32	32	33	35	35	37	35	32	30	30	29	26
		0	0	1	7	10	12	11	8	12	14	14	11	5	3	8
	Stitch	16	17	18	19	20	21	22	23	24	25	26	27	28	29	30
		24	18	13	12	13	10	12	8	12	7	12	6	10	5	10
		10	13	14	14	12	11	10	9	8	6	6	3	2	0	2
	Stitch	31	32	33	34	35	36	37	38	39	40	41	42	43	44	45
	16	19	23	22	17	22	23	19	42							
	1	0	0	6	10	6	0	0	0							



	Stitch	1	2	3	4	5	6	7	8	9	10	11	12	13	14	15
		0	3	5	8	12	17	20	24	27	29	31	32	30	27	24
		0	5	8	11	13	14	14	13	12	11	9	6	3	1	0
	Stitch	16	17	18	19	20	21	22	23	24	25	26	27	28	29	30
		21	18	16	15	15	16	18	21	25	28	33	37	41	43	44
		0	1	3	5	8	10	12	13	14	14	13	11	8	5	0
	Stitch	31	32	33	34	35	36	37	38	39	40	41	42	43	44	45
																
																





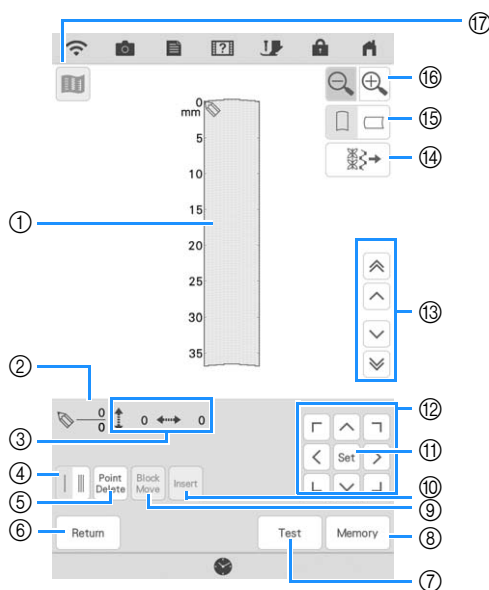











	Stitch	1	2	3	4	5	6	7	8	9	10	11	12	13	14	15
		0	5	4	5	8	7	8	11	11	11	16	11	7	4	0
		7	7	3	7	7	0	7	7	3	7	7	3	0	3	7
	Stitch	16	17	18	19	20	21	22	23	24	25	26	27	28	29	30
		4	7	11	16	21	20	21	24	23	24	27	27	27	32	27
		11	14	11	7	7	11	7	7	14	7	7	11	7	7	11
	Stitch	31	32	33	34	35	36	37	38	39	40	41	42	43	44	45
	23	20	16	20	23	27	32									
	14	11	7	3	0	3	7									

ENTERING STITCH DATA

Key Functions



- ① This area displays the stitch being created.
- ② Displays the number of the present set point over the total number of points in the stitch.
- ③ Displays the y-coordinate of  over the x-coordinate of .



No.	Display	Key Name	Explanation	Page
④		Single/triple stitching key	Touch this key to select whether one or three stitches will be sewn between two points.	171
⑤		Point delete key	Touch this key to delete a selected point.	172
⑥		Return key	Touch this key to exit the entering stitch data screen.	—
⑦		Test key	Touch this key to sew a test of the stitch.	172, 175
⑧		MY CUSTOM STITCH memory key	Touch this key to store the stitch being created.	175
⑨		Block move key	Touch this key to group points together and move them together.	173
⑩		Insert key	Touch this key to insert new points on the stitch design.	173
⑪		Set key	Touch this key to set a point on the stitch design.	171-173
⑫		Arrow keys	Use these keys to move  over the display area.	171-174
⑬		Point-to-point key	Use these keys to move  from point to point on the stitch, or to the first or last point entered on the stitch.	172-173
⑭		Stitch edit key	Touch this key to edit the utility stitches in the machine.	174
⑮		Grid direction key	Touch this key to change the direction of the grid sheet.	171
⑯		Enlarger key	Touch this key to see an enlarged version of the stitch being created.	171
⑰		Image key	Touch this key to view an image of the stitch.	172

1 Touch  and then **Character Decorative Stitch**.

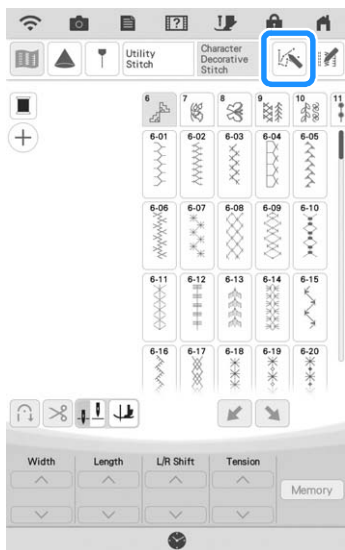
2 Touch .



3 Use  to move  to the coordinates of the first point on the grid.

- * Touch  to change the direction of the grid.
- * Touch  to enlarge the image of the stitch being created.

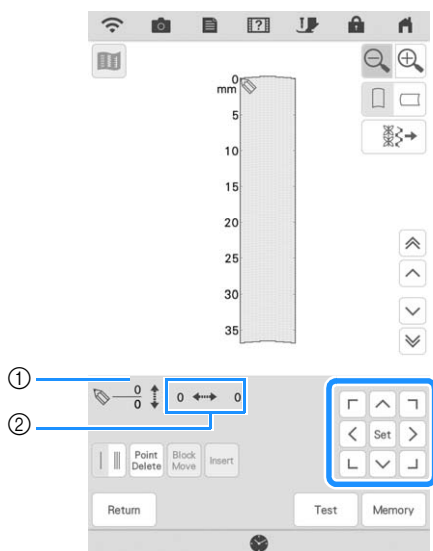

- ① Currently selected point/Total number of points
- ② Coordinates of 

4 Touch **Set** to add the point indicated by .

- * To insert coordinates with the dual purpose stylus or fine tipped stylus pen, move the tip of the pen to a desired point. Once you release the pen from the screen a point will be entered into the graph at those coordinates. The number of the currently selected points along with the total number of points will be displayed.

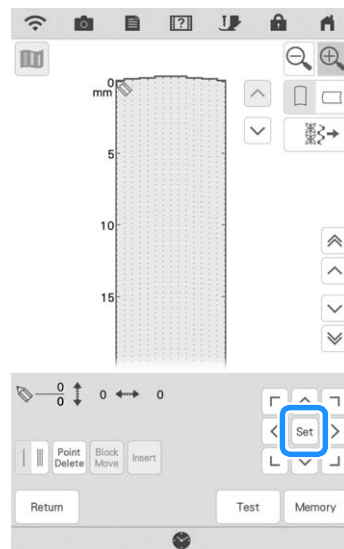

5 Select whether one stitch or three stitches will be sewn between the first two points.

- * To sew triple stitches, touch the key so that it appears as .



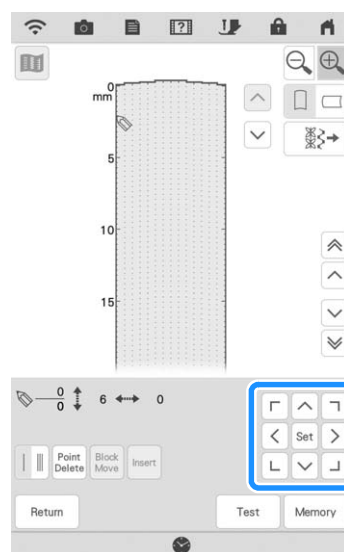

6 Use  to move  to the second point and touch **Set**.



5

MY CUSTOM STITCH

7 Repeat the steps above for each point that you have drawn on the grid sheet until the stitch design is drawn on the screen as a continuous line.

- * Touch  to delete a selected point entered.
- * Touch  to sew a test-run of the stitch.
- * Touch  to return to the original screen.
- * Touch  to view an image of the stitch.

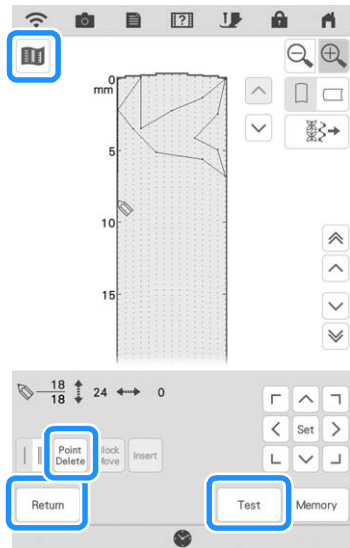

 **Memo**

- If you have entered points that are too close together, the fabric may not feed properly. Edit the stitch data to leave a larger space between points.
- If the stitch design is to be repeated and linked, make sure that linking stitches are added so that the stitch designs will not overlap.

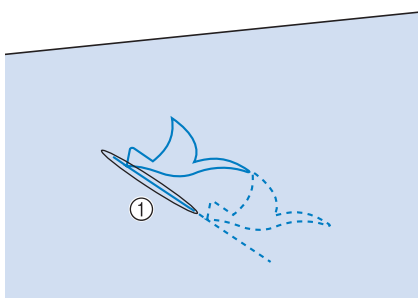





① Linking stitches

- You can touch on the grid to set the point, or you can also use stylus or arrows on the screen.

■ Moving a Point

1 Touch  or  to move  to the point that you want to move.

- * To move  to the first point, touch .
- * To move  to the last point, touch .

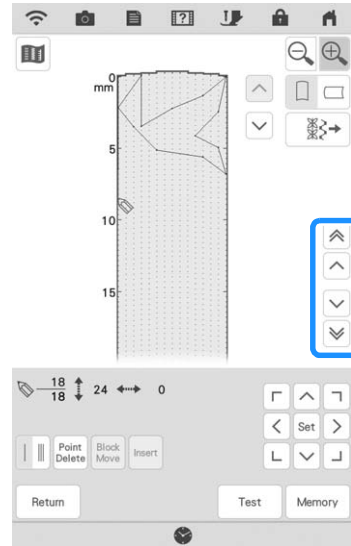

2 Use  to move the point.

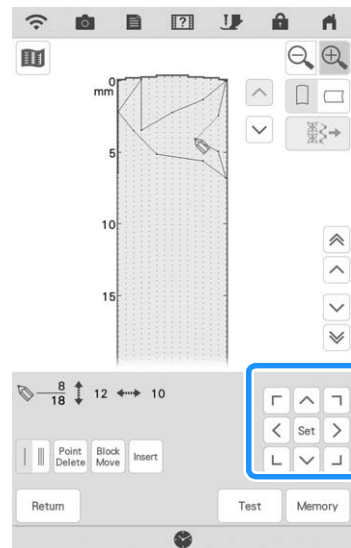

- * You can also move  by using the dual purpose stylus or fine tipped stylus pen.

■ Moving Part or All of the Design

1 Touch **Block Move**.

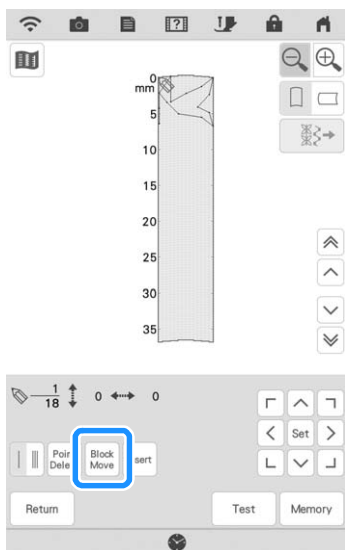

→ The selected point and all points that were entered after it are selected.

2 Touch **^** or **v** to move the section.

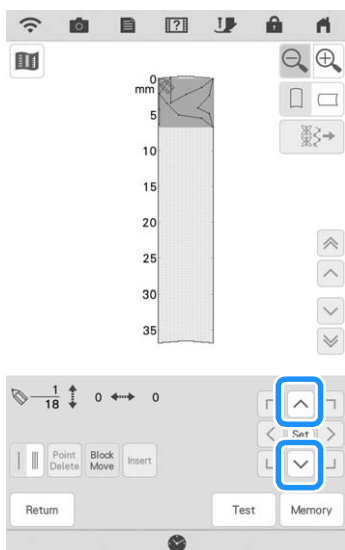

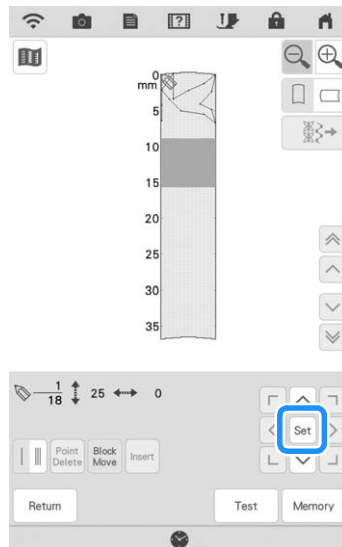

3 Touch **Set**.



→ The section will be moved.

■ Inserting New Points

1 Touch **^** or **v** to move  to a place on the design where you want to add a new point.

- * To move  to the first point, touch **^**.
- * To move  to the last point, touch **v**.

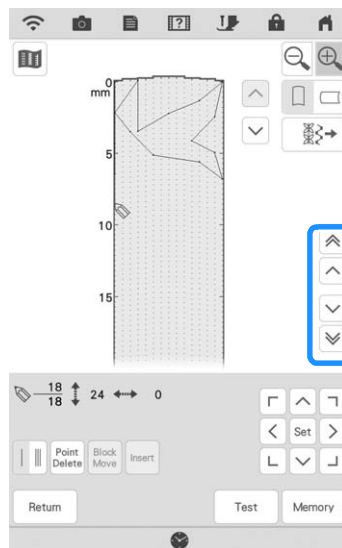

2 Touch **Insert**.

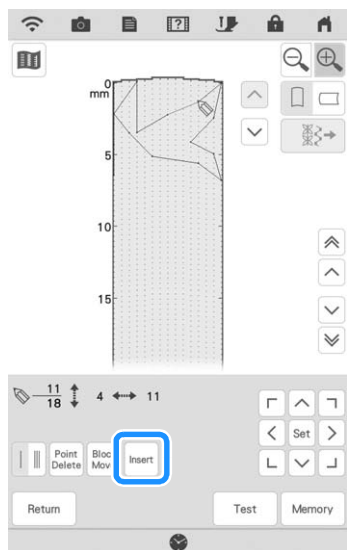

→ A new point is entered and  moves to it.

3 Use  to move the point.

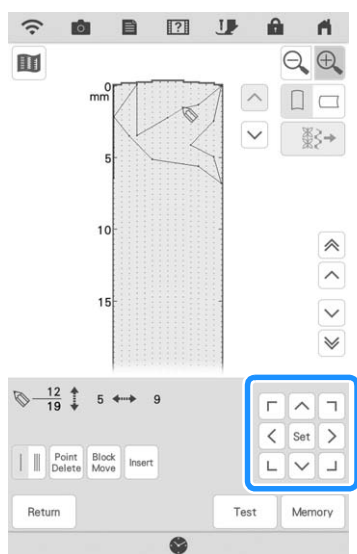

* You can also move  by using the dual purpose stylus or fine tipped stylus pen.

Editing Stitch Stored in the Machine

1 Touch .

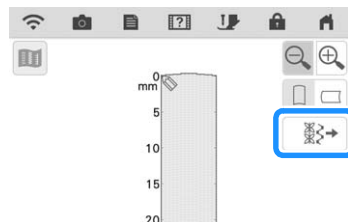

2 Select the stitch category and stitch that you want to edit.

* Scroll to display the other stitches.

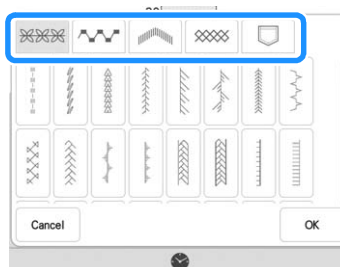

→ Selected stitch is displayed in the grid.

3 Touch **OK**.

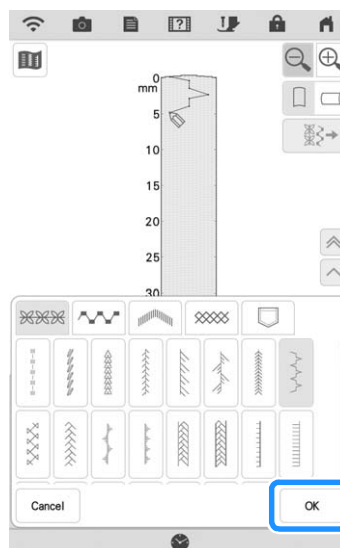

→ Edit the stitch as you like.

USING STORED CUSTOM STITCHES

Storing Custom Stitches in Your List

Stitch patterns created using the MY CUSTOM STITCH function can be stored for later use.

1 Touch **Memory**.

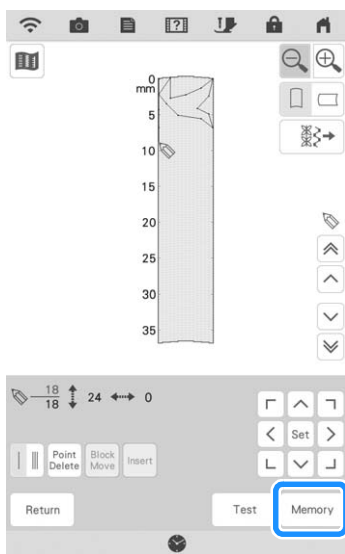

2 Touch the desired icon to memory.



Note

- When saving file to USB, be sure to insert USB media into the USB port.

Before storing a stitch, touch **Test** to sew a test-run of the stitch.

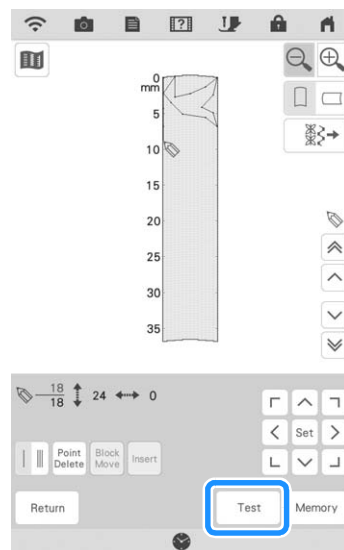

Memo

- Storing a stitch pattern takes a few seconds.
- For details on retrieving a stored stitch pattern, refer to page 176.

Note

- Do not turn off the machine while the [Saving...] message is displayed, otherwise the stitch pattern data being saved may be lost.

■ If the Memory Is Full

If the following screen appears while you are trying to save a stitch pattern, the memory is too full to hold the currently selected stitch pattern. To save the stitch pattern in the machine's memory, you have to delete a previously saved stitch pattern.

Touch **OK**, and then refer to "Retrieving Stitch Patterns" on page 164 and "Managing Saved File" on page 165.

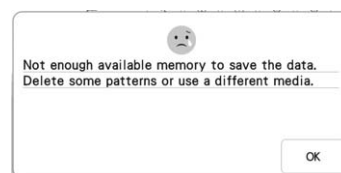

Retrieving Stored Stitches

1 Touch .

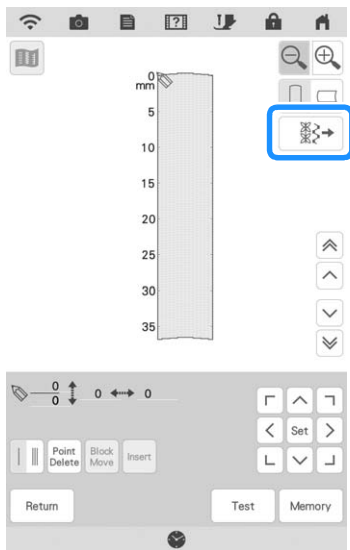

 **Memo**

- You can also retrieve the stitches by the procedure to retrieve the Decorative/Character stitches. Refer to page 164.

2 Touch .

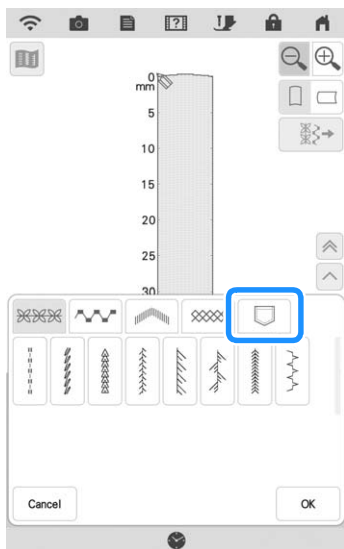

3 Choose ,  or  to retrieve.

* Touch to return to the previous screen without retrieving.

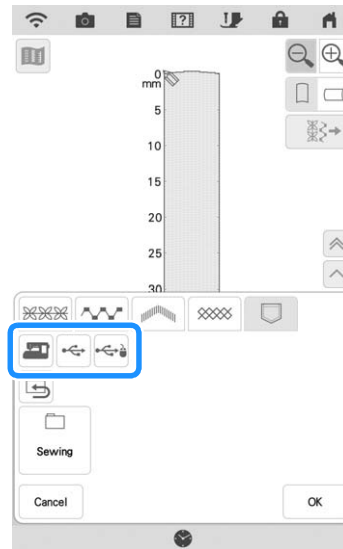

4 Select the stitch pattern you want to retrieve and touch .

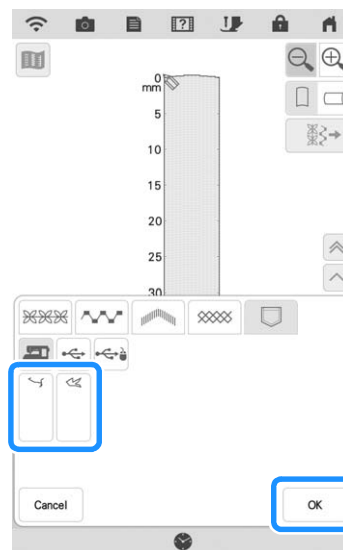



Chapter **6**
Appendix



CARE AND MAINTENANCE

⚠ CAUTION

- Be sure to unplug the machine before cleaning it. Otherwise, injury may result.

Restrictions on Oiling

In order to prevent damaging this machine, it must not be oiled by the user. This machine was manufactured with the necessary amount of oil applied to ensure correct operation, making periodic oiling unnecessary.

If problems occur, such as difficulty turning the handwheel or an unusual noise, immediately stop using the machine, and contact your authorized Brother dealer or the nearest Brother authorized service center.

Precautions on Storing the Machine

Do not store the machine in any of the locations described below, otherwise damage to the machine may result, for example, rust caused by condensation.

- * Exposed to extremely high temperatures
- * Exposed to extremely low temperatures
- * Exposed to extreme temperature changes
- * Exposed to high humidity or steam
- * Near a flame, heater or air conditioner
- * Outdoors or exposed to direct sunlight
- * Exposed to extremely dusty or oily environments

Note

- In order to extend the life of this machine, periodically turn it on and use it. Storing this machine for an extended period of time without using it may reduce its efficiency.

Cleaning the LCD Screen

If the surface of the LCD is dirty, lightly wipe it with a soft dry cloth.

Memo

- Occasionally, condensation may form on the LCD screen or it may become fogged up; however, this is not a malfunction. After a while, the cloudiness will disappear.

Cleaning the Machine Casing

When wiping dirt off the machine, firmly wring a soft cloth soaked in (lukewarm) water. After cleaning the machine, dry it with a soft, dry cloth.

Cleaning the Race

- 1 Press the "Needle Position" button to raise the needle.
- 2 Turn the main power to OFF, and then unplug the machine.
- 3 Remove the needle and the presser foot. (page 54, page 57)
- 4 Remove the flat bed attachment or the embroidery unit if either is attached.
- 5 Slide the needle plate lever toward you.

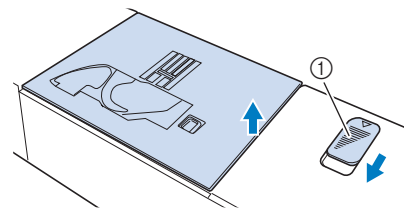

- ① Slide toward you.
→ The needle plate opens.

- 6 Slide out the needle plate with your right hand to remove it.

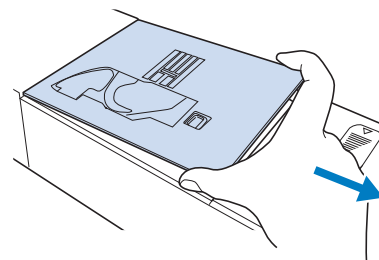

- 7 Grasp the bobbin case, and then gently lift out.

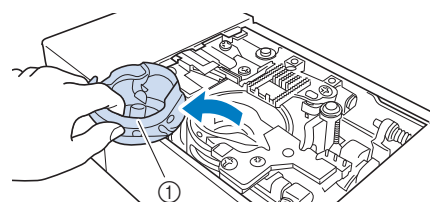

- ① Bobbin case

- 8** Use the cleaning brush or a vacuum cleaner to remove any lint and dust from the race and bobbin thread sensor and the surrounding area.

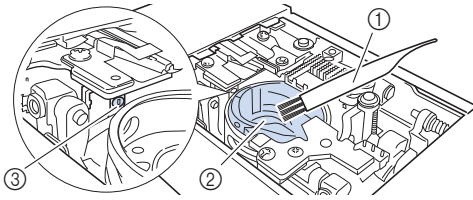

- ① Cleaning brush
- ② Race
- ③ Bobbin thread sensor

IMPORTANT

- Do not apply oil to the bobbin case.

Memo

- If lint or dust collects on the bobbin thread sensor, the sensor may not operate correctly.

- 9** Insert the bobbin case so that the ▲ mark on the bobbin case aligns with the ● mark on the machine.

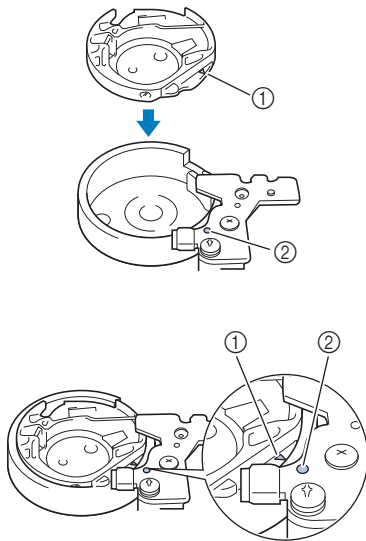

- * Align the ▲ and ● marks.

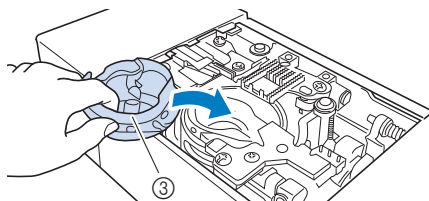

- ① ▲ mark on the bobbin case
- ② ● mark on the machine
- ③ Bobbin case

- * Make sure that the indicated points are aligned before installing the bobbin case.

CAUTION

- Never use a bobbin case that is scratched or has a burr on it. Otherwise the upper thread may become tangled, and the needle may break and cause injury. For a new bobbin case, contact your nearest Brother authorized service center.
- Make sure that you fit the bobbin case properly, otherwise the needle may break and cause injury.

- 10** Insert the tabs on the needle plate into the notches in the machine.

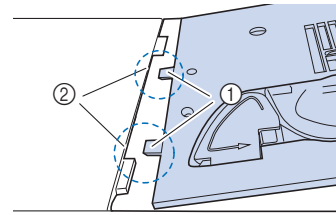

- ① Tabs
- ② Notches

- 11** Press down on the right side of the needle plate to secure it.

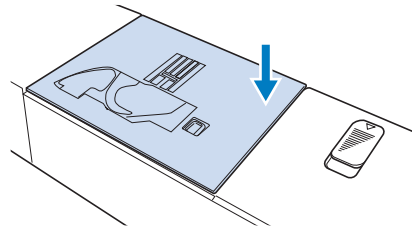

Cleaning the Cutter in the Bobbin Case Area

The cutter below the needle plate should be cleaned. If dust or lint accumulate on the cutter, it will be difficult to cut the thread when the “Thread Cutter” button is pressed or the automatic thread cutting function is used. Clean the cutter when the thread is not easily cut.

- 1 Follow steps 1 through 7 in “Cleaning the Race” to remove the needle plate.
- 2 Use the cleaning brush or a vacuum cleaner to remove any lint and dust from the cutter in the bobbin case area.

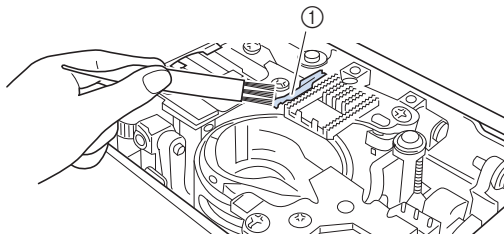

① Cutter

⚠ CAUTION

- Do not touch the cutter, otherwise injuries may result.

- 3 Attach the needle plate.

About the Maintenance Message



Once this message appears, it is recommended to take your machine to an authorized Brother dealer or the nearest Brother authorized service center for a regular maintenance check. Although this message will disappear and the machine will continue to function once you touch , the message will display several more times until the appropriate maintenance is performed.

Please take the time to arrange for the maintenance your machine requires once this message appears. Such steps will help to ensure you receive continued, uninterrupted hours of machine operation for the future.

TROUBLESHOOTING

If the machine stops operating correctly, check the following possible problems before requesting service. You can solve most problems by yourself. If you need additional help, the Brother Support website offers the latest FAQs and troubleshooting tips. Visit us at "<https://s.brother.com/cpdab/>".

If the problem persists, contact your authorized Brother dealer or the nearest Brother authorized service center.

Frequent Troubleshooting Topics

Detailed causes and remedies for common troubleshooting topics are described below. Be sure to refer to this before contacting your authorized Brother dealer.

■ Upper Thread Is Too Tight	page 181
■ Tangled Thread on Wrong Side of Fabric	page 182
■ Incorrect Thread Tension	page 183
■ Fabric Is Caught in the Machine and Cannot be Removed	page 184
■ If the Thread Becomes Tangled Under the Bobbin Winder Seat	page 185

Upper Thread Is Too Tight

■ Symptom

- * The upper thread appears as a single continuous line.
- * The lower thread is visible from the upper side of the fabric. (Refer to the illustration below.)
- * The upper thread has tightened up, and comes out when pulled.
- * The upper thread has tightened up, and wrinkles appear in the fabric.
- * The upper thread tension is tight, and the results do not change even after the thread tension is adjusted.

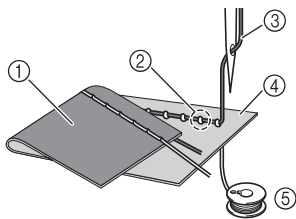

- ① Lower side of fabric
- ② Lower thread visible from upper side of fabric
- ③ Upper thread
- ④ Upper side of fabric
- ⑤ Lower thread

■ Cause

Incorrect lower threading

If the lower thread is incorrectly threaded, instead of the appropriate tension being applied to the lower thread, it is pulled through the fabric when the upper thread is pulled up. For this reason, the thread is visible from the upper side of the fabric.

■ Remedy

Correctly install the lower thread. (page 44)

Tangled Thread on Wrong Side of Fabric

■ Symptom

- * The thread becomes tangled on the lower side of the fabric.

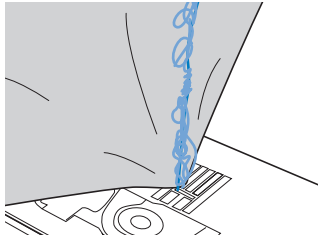

- * After starting sewing, a rattling noise is made and sewing cannot continue.
- * Looking under the fabric, there is tangled thread in the bobbin case.

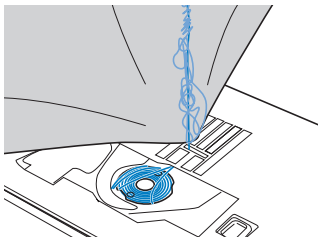

■ Cause

Incorrect upper threading

If the upper thread is incorrectly threaded, the upper thread passed through the fabric cannot be firmly pulled up and the upper thread becomes tangled in the bobbin case, causing a rattling noise.

■ Remedy

Remove the tangled thread, and then correct the upper threading.

- 1 Remove the tangled thread. If it cannot be removed, cut the thread with scissors.**

- * Refer to "Cleaning the Race" on page 178.

- 2 Remove the upper thread from the machine.**

- 3 Correct the upper threading by following the instructions in "UPPER THREADING" on page 47.**

- * If the bobbin was removed from the bobbin case, refer to "Setting the Bobbin" on page 44 to correctly install the bobbin.

Incorrect Thread Tension

■ Symptoms

- Symptom 1: The lower thread is visible from the upper side of the fabric.
- Symptom 2: The upper thread appears as a straight line on the upper side of the fabric.
- Symptom 3: The upper thread is visible from the lower side of the fabric.
- Symptom 4: The lower thread appears as a straight line on the lower side of the fabric.
- Symptom 5: The stitching on the lower side of the fabric is loose or has slack.

□ Symptom 1

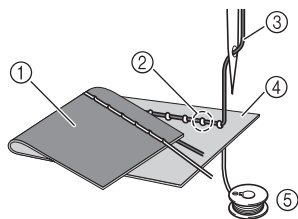

□ Symptom 3

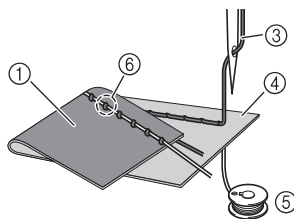

- ① Lower side of fabric
- ② Lower thread visible on upper side of fabric
- ③ Upper thread
- ④ Upper side of fabric
- ⑤ Lower thread
- ⑥ Upper thread visible from lower side of fabric

■ Cause/Remedy

□ Cause 1

The machine is not correctly threaded.

<With symptoms 1 and 2 described above>

The lower threading is incorrect.

Return the upper thread tension to the standard setting, and then refer to “Setting the Bobbin” on page 44 to correct lower threading.

<With symptoms 3 through 5 described above>

The upper threading is incorrect.

Return the upper thread tension to the standard setting, and then refer to “UPPER THREADING” on page 47 to correct the upper threading.

□ Cause 2

A needle and thread appropriate for the fabric are not being used.

The machine needle that should be used depends on the type of fabric sewn and the thread thickness.

If a needle and thread appropriate for the fabric are not being used, the thread tension will not be adjusted correctly, causing wrinkles in the fabric or skipped stitches.

- * Refer to “Fabric/Thread/Needle Combinations” on page 56 to check that a needle and thread appropriate for the fabric are being used.

□ Cause 3

An appropriate upper tension is not selected.

Adjust the upper thread tension to select an appropriate thread tension.

The appropriate thread tension differs according to the type of fabric and thread being used.

- * Adjust the thread tension while test sewing on a piece of scrap fabric that is the same as that used in your project.

💡 Note

- If the upper threading and lower threading are incorrect, the thread tension cannot be adjusted correctly, even by adjusting the upper thread tension. Check the upper threading and lower threading first, and then adjust the thread tension.

- * When the lower thread is visible on the upper side of the fabric, set the upper thread tension to a lower number. (Loosen the thread tension.)
- * When the upper thread is visible on the lower side of the fabric, set the upper thread tension to a higher number. (Tighten the thread tension.)



Fabric Is Caught in the Machine and Cannot be Removed

If the fabric is caught in the machine and cannot be removed, the thread may have become tangled under the needle plate. Follow the procedure described below to remove the fabric from the machine. If the operation could not be completed according to the procedure, instead of attempting to complete it forcefully, contact your authorized Brother dealer or the nearest Brother authorized service center.

■ Removing the Fabric from the Machine

- 1** Immediately stop the machine.
- 2** Turn the main power to OFF, and then unplug the machine.
- 3** Remove the needle.
If the needle is lowered into the fabric, turn the handwheel away from you (clockwise) to raise the needle out of the fabric, and then remove the needle.
* Refer to "CHANGING THE NEEDLE" on page 54.
- 4** Remove the presser foot.
If the thread is entangled on the presser foot, remove the entangled thread, and then raise the presser foot lever to remove the presser foot. Otherwise, the presser foot may be damaged.
* Refer to "CHANGING THE PRESSER FOOT" on page 57.
- 5** Lift up the fabric and cut the threads below it.
If the fabric can be removed, remove it. Continue with the following steps to clean the race.
- 6** Remove the needle plate and bobbin case.
If threads remain in the bobbin case, remove them.
* Refer to "Cleaning the Race" on page 178.
- 7** Remove any threads in the race and around the feed dogs.
* Refer to step **8** on page 179.

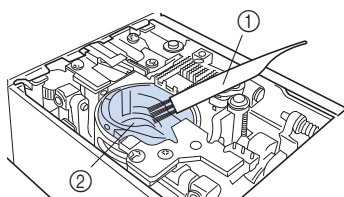

- ① Cleaning brush
- ② Race

- 8** Insert the bobbin case and then attach the needle plate.

* Refer to steps **9** through **11** on page 179.

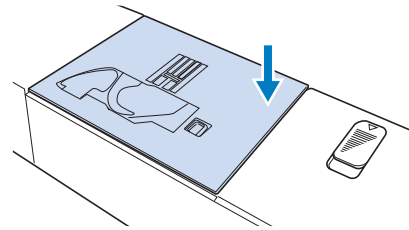

- 9** Check the condition of the needle, and then install it.

If the needle is in a poor condition, for example, if it is bent, be sure to install a new needle.

* Refer to "CHANGING THE NEEDLE" on page 54.

■ Checking Machine Operations

If the needle plate has been removed, check machine operations to confirm that installation has been completed correctly.

- 1** Turn on the machine.

→ The needle moves to the left and right.

💡 Note

- If an error occurs, the machine may be malfunctioning; therefore, contact your authorized Brother dealer or the nearest Brother authorized service center.

- 2** Select Straight stitch (Middle).

* Refer to the "STITCH SETTING CHART" on page 198.

💡 Note

- Do not yet install the presser foot and thread.

- 3** Slowly turn the handwheel toward you (counterclockwise), and look from all sides to check that the needle falls at the center of the hole in the needle plate.

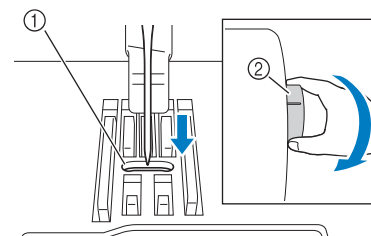

- ① Hole in the needle plate
- ② Handwheel

If the needle or feed dogs contact the needle plate, the machine may be malfunctioning; therefore, contact your authorized Brother dealer or the nearest Brother authorized service center.

4 Turn off the machine, and then install the bobbin and presser foot.

Never use a scratched or damaged presser foot. Otherwise, the needle may break, or sewing performance may suffer.

- * Refer to “Setting the Bobbin” on page 44 and “CHANGING THE PRESSER FOOT” on page 57.

5 Correctly thread the machine.

- * For details on the machine, refer to “UPPER THREADING” on page 47.

Note

- The thread may have become tangled as a result of incorrect upper threading. Make sure that the machine is correctly threaded.

6 Perform trial sewing with normal fabric.

Note

- Remember when sewing thin fabrics, select a center stitch that is shorter in length and use the straight stitch needle plate for straight sewing stitches. A lightweight paper stabilizer can also be placed on the underside of the fabric.

If the Thread Becomes Tangled Under the Bobbin Winder Seat

If the bobbin winding starts when the thread is not passed through the pretension disk correctly, the thread may become tangled beneath the bobbin winder seat.

Wind off the thread according to the following procedure.

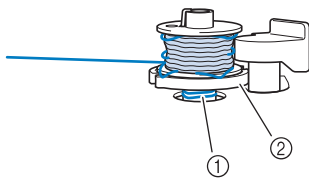

- ① Thread
- ② Bobbin winder seat

CAUTION

- Do not remove the bobbin winder seat even if the thread becomes tangled under the bobbin winder seat. The cutter in the bobbin winder seat may cause injury.

1 Touch **Stop** once to stop the bobbin winding.

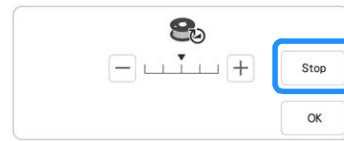

2 Cut the thread with scissors near the pretension disk.

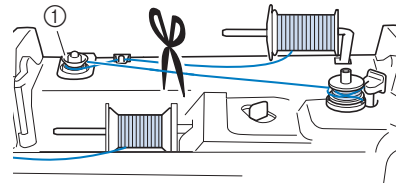

- ① Pretension disk



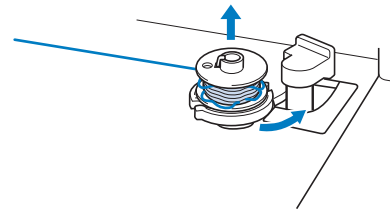

3 Push the bobbin winder switch to the right, and then remove the bobbin from the shaft and cut the thread leading to the bobbin in order to be able to completely remove the bobbin from shaft.

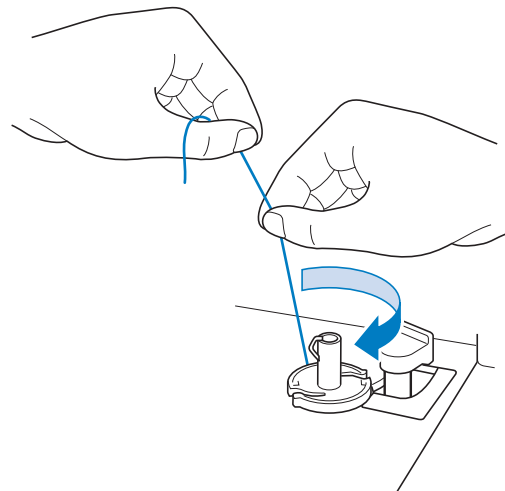





4 Hold the thread end with your left hand, and wind off the thread clockwise from under the bobbin winder seat with your right hand as shown below.



List of Symptoms

If you have a minor problem with your machine, check the following solutions. If the solutions suggested do not correct the problem, contact your authorized Brother dealer. Touch  →  →  for advice about minor sewing problems during sewing. Touch  at any time to return to the original screen.

■ Getting Ready

Problem	Cause	Solution	Page
Cannot thread the needle.	Needle is not in the correct position.	Press the “Needle Position” button to raise the needle.	13
	Needle is installed incorrectly.	Reinstall the needle correctly.	54
	Needle is turned, bent or the point is dull.	Replace the needle.	54
	Upper threading is incorrect.	Check the steps for threading the machine and rethread the machine.	47
	The needle threader hook is bent and does not pass through the eye of the needle.	Contact your authorized Brother dealer.	—
	The needle threader lever cannot be moved or returned to its original position.	Contact your authorized Brother dealer.	—
	A size 65/9 needle is being used.	The needle is incompatible with the needle threader. Manually pass the thread through the eye of the needle.	49
Cannot lower the presser foot with the presser foot lever.	Presser foot was raised using the “Presser Foot Lifter” button.	Press the “Presser Foot Lifter” button to lower the presser foot.	13
Bobbin thread does not wind neatly on the bobbin.	The thread is not passed through the bobbin winding thread guide correctly.	Correctly pass the thread through the bobbin winding thread guide.	40
	Bobbin spins slowly.	Touch  in the bobbin winding window to increase the bobbin winding speed.	42
	The thread that was pulled out was not wound onto the bobbin correctly.	Wind the thread that was pulled off around the bobbin 5 or 6 times clockwise.	41
	The empty bobbin was not set on the pin properly.	Set the empty bobbin on the pin and slowly turn the bobbin until you hear it click in place.	40
While winding the bobbin, the bobbin thread was wound below the bobbin winder seat.	You did not wind the bobbin thread properly when you initially wound the bobbin, or the bobbin thread was not properly set in the guides.	After removing the thread wound below the bobbin winder seat, wind the bobbin correctly. Follow the drawn images on the top of the machine for guidance when threading the machine for bobbin winding.	40, 185
The bobbin thread cannot be pulled up.	Needle is turned, bent or the point is dull.	Replace the needle.	54
	Bobbin is set incorrectly.	Reset the bobbin thread correctly.	44
Machine does not operate.	All keys and buttons have been locked by  .	Touch  to unlock all keys and buttons.	51, 57
Nothing appears in the LCD.	Main power switch is not turned on.	Turn the main power to ON.	17
	The plug of the power cord is not inserted into an electrical outlet.	Insert the plug of the power cord into an electrical outlet.	17
The LCD screen does not look very clear.	The brightness of the screen is not adjusted.	Adjust the [Screen Display Brightness] in the settings screen.	21
Nothing happens, even if the LCD display is touched.	The screen has been locked.	Touch either of the following keys to unlock the screen.  	—
The LCD screen is fogged up.	Condensation has formed on the LCD screen.	After a while, the cloudiness will disappear.	—
The dual purpose stylus cannot be operated.	The dual purpose stylus is dirty.	Clean the light-emitting part of the dual purpose stylus.	—
	The battery is dead.	Replace the battery with a new one.	80

■ While Sewing

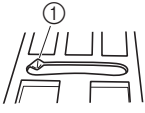
Problem	Cause	Solution	Page
Machine does not operate.	“Start/Stop” button was not pressed.	Press the “Start/Stop” button.	13
	There is no stitch pattern selected.	Select a stitch pattern.	94, 146
	Presser foot is not lowered.	Lower the presser foot.	13
	“Start/Stop” button was pressed with the foot controller attached.	Remove the foot controller, or use the foot controller to operate the machine.	64
	The “Start/Stop” button was pressed while the machine is set for the sewing speed controller to control the zigzag stitch width.	Use the foot controller instead of the “Start/Stop” button to operate the machine, or set the [Width Control] to [OFF] in the settings screen.	20, 64
Needle breaks.	Needle is installed incorrectly.	Reinstall the needle correctly.	54
	Needle clamp screw is not tightened.	Tighten the needle clamp screw.	54
	Needle is turned or bent.	Replace the needle.	54
	Using improper needle or thread for the selected fabric.	Check the “Fabric/Thread/Needle Combinations” chart.	56
	Wrong presser foot was used.	Use the recommended presser foot.	198
	Upper thread tension is too tight.	Adjust the thread tension.	74
	Fabric is pulled during sewing.	Do not pull the fabric during sewing.	—
	Spool cap is set incorrectly.	Check the method for attaching the spool cap, then reattach the spool cap.	47
	There are scratches around the opening in the needle plate. * There is a notch on the left side of the opening in the needle plate. This is not a scratch.	Replace the needle plate, or consult your authorized Brother dealer.	178
	 ① Notch		
	There are scratches around the opening in the presser foot.	Replace the presser foot, or consult your authorized Brother dealer.	57
	There are scratches on the bobbin case.	Replace the bobbin case, or consult your authorized Brother dealer.	178
	Needle is defective.	Replace the needle.	54
	A bobbin designed specifically for this machine is not used.	Use a bobbin designed specifically for this machine.	40
	Upper threading is incorrect.	Check the steps for threading the machine and rethread the machine.	47
	Bobbin is set incorrectly.	Reset the bobbin thread correctly.	44
	Presser foot is attached incorrectly.	Attach the presser foot correctly.	57
	Screw of the presser foot holder is loose.	Securely tighten the screw of the presser foot.	58, 114
	Fabric is too thick.	Use fabric that the needle can pierce when the handwheel is turned.	69
	Fabric is fed forcefully when sewing thick fabric or thick seams.	Allow the fabric to be fed without being forcefully pushed.	56, 69
Stitch length is too short.	Adjust the stitch length.	73	
Bobbin thread is incorrectly wound.	Use a correctly wound bobbin.	40	

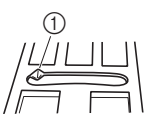
Problem	Cause	Solution	Page
Upper thread breaks.	Machine is not threaded correctly (used the wrong spool cap, spool cap is loose, the thread did not catch the needle bar threader, etc.).	Rethread the machine correctly.	47
	Knotted or tangled thread is being used.	Remove any knots or tangles.	—
	The selected needle is not appropriate for the thread being used.	Select a needle that is appropriate for the type of thread being used.	56
	Upper thread tension is too tight.	Adjust the thread tension.	74
	Thread is twisted.	Use scissors, etc., to cut the twisted thread and remove it from the race, etc.	—
	Needle is turned, bent or the point is dull.	Replace the needle.	54
	Needle is installed incorrectly.	Reinstall the needle correctly.	54
	There are scratches around the opening of the needle plate. * There is a notch on the left side of the opening in the needle plate. This is not a scratch.	Replace the needle plate, or consult your authorized Brother dealer.	178
	 ① Notch		
	There are scratches around the opening in the presser foot.	Replace the presser foot, or consult your authorized Brother dealer.	57
	There are scratches on the bobbin case.	Replace the bobbin case, or consult your authorized Brother dealer.	178
	Using improper needle or thread for the selected fabric.	Check the “Fabric/Thread/Needle Combinations” chart.	56
	While sewing, the thread became knotted or tangled.	Rethread upper and lower thread.	44, 47
A bobbin designed specifically for this machine is not used.	Use a bobbin designed specifically for this machine.	40	
The thread is tangled on the wrong side of the fabric.	Upper threading is incorrect.	Check the steps for threading the machine and rethread the machine. Be sure that the presser foot is in the raised position when threading the machine so that the upper thread sets properly in the upper tension.	47
	Using improper needle or thread for the selected fabric.	Check the “Fabric/Thread/Needle Combinations” chart.	56
The upper thread is too tight.	The bobbin thread is incorrectly installed.	Correctly install the bobbin thread.	44
Bobbin thread breaks.	Bobbin is set incorrectly.	Reset the bobbin thread correctly.	44
	Bobbin thread is incorrectly wound.	Use a correctly wound bobbin.	40
	There are scratches on the bobbin or it doesn't rotate properly.	Replace the bobbin.	44
	Thread is twisted.	Use scissors, etc. to cut the twisted thread and remove it from the race, etc.	—
	A bobbin designed specifically for this machine is not used.	Use a bobbin designed specifically for this machine.	40
Fabric puckers.	There is a mistake in the upper or bobbin threading.	Check the steps for threading the machine and rethread it correctly.	44, 47
	Spool cap is set incorrectly.	Check the method for attaching the spool cap, then reattach the spool cap.	47
	Using improper needle or thread for the selected fabric.	Check the “Fabric/Thread/Needle Combinations” chart.	56
	Needle is turned, bent or the point is dull.	Replace the needle.	54
	Stitches are too long when sewing thin fabrics.	Shorten the stitch length.	73
	Thread tension is set incorrectly.	Adjust the thread tension.	74
	Wrong presser foot.	Use the correct presser foot.	198

Problem	Cause	Solution	Page
The stitch is not sewn correctly.	The presser foot that is used is not appropriate for the type of stitch that you wish to sew.	Attach the presser foot that is appropriate for the type of stitch that you wish to sew.	198
	The thread tension is incorrect.	Adjust the tension of the upper thread.	74
	The thread is tangled, for example, in the bobbin case.	Remove the tangled thread. If the thread is tangled in the bobbin case, clean the race.	178
Skipped stitches	Machine is threaded incorrectly.	Check the steps for threading the machine and rethread it correctly.	47
	Using improper needle or thread for the selected fabric.	Check the "Fabric/Thread/Needle Combinations" chart.	56
	Needle is turned, bent or the point is dull.	Replace the needle.	54
	Needle is installed incorrectly.	Reinstall the needle correctly.	54
	Needle is defective.	Replace the needle.	54
	Dust or lint has collected under the needle plate.	Remove the dust or lint with the brush.	178
	Thin or stretch fabrics are being sewn.	Sew with one sheet of thin paper under the fabric.	71
No stitching	Needle is turned, bent or the point is dull.	Replace the needle.	54
	Bobbin is set incorrectly.	Reset the bobbin thread correctly.	44
	Upper threading is incorrect.	Check the steps for threading the machine and rethread the machine.	47
High-pitched sound while sewing	Dust or lint is caught in the feed dogs.	Remove the dust or lint.	178
	Pieces of thread are caught in the race.	Clean the race.	178
	Upper threading is incorrect.	Check the steps for threading the machine and rethread the machine.	47
	A bobbin designed specifically for this machine is not used.	Use a bobbin designed specifically for this machine.	40
	There are needle holes or friction scratches in the bobbin case.	Replace the bobbin case, or consult your authorized Brother dealer.	178
Fabric does not feed through the machine.	Feed dogs are set in the down position.	Touch  , and then turn the handwheel to raise the feed dogs.	112
	Stitches are too close together.	Lengthen the stitch length setting.	73
	Wrong presser foot was used.	Use the correct presser foot.	198
	Needle is turned, bent or the point is dull.	Replace the needle.	54
	Thread is entangled.	Cut the entangled thread and remove it from the race.	—
	Zigzag foot "J" is slanted on a thick seam at the beginning of stitching.	Use the presser foot locking pin (black button on the left side) on zigzag foot "J" to keep the presser foot level while sewing.	70
The fabric feeds in the opposite direction.	The feed mechanism is damaged.	Contact your authorized Brother dealer.	—
The needle contacts the needle plate.	The needle clamp screw is loose.	Firmly tighten the needle clamp screw. If the needle is bent or blunt, replace it with a new one.	54
	Needle is turned, bent or the point is dull.	Replace the needle.	54
Fabric being sewn with the machine cannot be removed.	Thread is tangled below the needle plate.	Lift up the fabric and cut the threads below it, and clean the race.	182
A broken needle has fallen into the machine.	—	Turn off the machine, and then remove the needle plate. If the needle that fell into the machine can be seen, use tweezers to remove it. After removing the needle, return the needle plate to its original position. Before turning on the machine, slowly turn the handwheel toward you to check that it turns smoothly. If the handwheel does not turn smoothly or the needle that fell into the machine cannot be removed, consult your authorized Brother dealer.	—
The handwheel feels sluggish when it is turned.	Thread is tangled in the bobbin case.	Remove the tangled thread from the bobbin case. Re-install the bobbin case so it is correctly positioned.	178, 182

Problem	Cause	Solution	Page
The built-in camera cannot detect the buttonhole foot.	The buttonhole foot is dirty.	Clean the area of the buttonhole foot to be detected.	128
	Mark "A+" or the three dots on the presser foot are shaded or hidden under fabric or your hands.	Make sure that nothing obstructs the detection of mark "A+" or the three dots.	128

■ After Sewing

Problem	Cause	Solution	Page
Thread tension is incorrect.	Upper threading is incorrect.	Check the steps for threading the machine and rethread the machine.	47
	Bobbin is set incorrectly.	Reset the bobbin. (If needle plate was removed, reinstall needle plate.)	44
	Using improper needle or thread for the selected fabric.	Check the "Fabric/Thread/Needle Combinations" chart.	56
	Presser foot holder is not attached correctly.	Reattach the presser foot holder correctly.	—
	Thread tension is set incorrectly.	Adjust the thread tension.	74
	Bobbin thread is incorrectly wound.	Use a correctly wound bobbin.	44
	Needle is turned, bent or the point is dull.	Replace the needle.	54
	A bobbin designed specifically for this machine is not used.	Use a bobbin designed specifically for this machine.	40
Character or decorative stitch patterns are misaligned.	Stitch pattern adjustment settings were set incorrectly.	Revise the stitch pattern adjustment settings.	151
Stitch pattern does not turn out.	Wrong presser foot was used.	Attach the correct presser foot.	198
	Did not use a stabilizer material on thin fabrics or stretch fabrics.	Attach a stabilizer material.	150
	Thread tension is set incorrectly.	Adjust the thread tension.	74
	Fabric was pulled, pushed or fed at an angle while it was being sewn.	Sew while guiding the fabric with your hands so that the fabric is fed in a straight line.	62
	The thread is tangled, for example, in the bobbin case.	Remove the tangled thread. If the thread is tangled in the bobbin case, clean the race.	178

ERROR MESSAGES

If the operation procedure is incorrect, the machine does not start. An alarm sounds and an error message is displayed on the LCD. If an error message displays, follow the instructions in the message.

Below is an explanation of error messages. Refer to these when necessary (if you touch or do the operation correctly while the error message is displayed, the message disappears).

	Error messages	Cause/solution													
1	Attach buttonhole foot "A+". The built-in camera detects buttonhole foot "A+" by the mark "A+" and the three dots.	This message appears when start sewing buttonhole stitches without attaching buttonhole foot "A+".													
2	Data volume is too large for this pattern.	This message is displayed when the stitch patterns you are editing take up too much memory, or if you are editing too many stitch patterns for the memory. Reducing the total number of stitch patterns may resolve the issue.													
3	Failed to save file.	This message is displayed when no more images can be saved on the USB media. In this case, delete a file from the USB media or use different USB media. (page 24, page 79)													
4	Lower the presser foot lever.	This message is displayed when the "Presser Foot Lifter" button is pressed while the presser foot lever is raised and the needle is lowered.													
5	Preventive maintenance is recommended.	This message is displayed when the machine needs to be maintained. (page 180)													
6	The "Start/Stop" button does not operate with the foot controller attached. Remove the foot controller.	This message is displayed when the "Start/Stop" button is pressed to sew utility stitches or character/decorative stitches while the foot controller is connected.													
7	The authentication and encryption methods used by the selected wireless LAN access point/router are not supported by your machine.	<p>The authentication/encryption methods used by the selected wireless access point/router are not supported by your machine.</p> <p>For infrastructure mode, change the authentication and encryption methods of the wireless access point/router. Your machine supports the following authentication methods:</p> <table border="1"> <thead> <tr> <th>Authentication method</th> <th>Encryption method</th> </tr> </thead> <tbody> <tr> <td rowspan="2">WPA-Personal</td> <td>TKIP</td> </tr> <tr> <td>AES</td> </tr> <tr> <td rowspan="2">WPA2-Personal</td> <td>TKIP</td> </tr> <tr> <td>AES</td> </tr> <tr> <td rowspan="2">Open</td> <td>WEP</td> </tr> <tr> <td>None (without encryption)</td> </tr> <tr> <td>Shared key</td> <td>WEP</td> </tr> </tbody> </table> <p>If your problem is not solved, the SSID or network settings you entered may be incorrect. Reconfirm the wireless network settings. (page 35) Refer to "How Can I Find the Wireless Security Information (SSID and Network Key)" on page 193.</p>	Authentication method	Encryption method	WPA-Personal	TKIP	AES	WPA2-Personal	TKIP	AES	Open	WEP	None (without encryption)	Shared key	WEP
Authentication method	Encryption method														
WPA-Personal	TKIP														
	AES														
WPA2-Personal	TKIP														
	AES														
Open	WEP														
	None (without encryption)														
Shared key	WEP														
8	The bobbin thread is almost empty.	This message is displayed when the bobbin thread is running out. Although a few stitches can be sewn when the "Start/Stop" button is pressed, replace with a wound bobbin immediately.													
9	The bobbin winder safety device has activated. Is the thread tangled?	This message is displayed when the bobbin is being wound, and the motor locks because the thread is tangled, etc.													
10	The pockets are full.	This message is displayed when no more settings for utility stitches can be saved. In this case, erase settings that have previously been saved in order to save the new settings. (page 96)													
11	The safety device has been activated. Is the thread tangled? Is the needle bent?	This message is displayed when the motor locks due to tangled thread or for other reasons related to thread delivery.													
12	The SSID and Network Key are incorrect.	The security information (SSID/network key (password)) is incorrect. Reconfirm the SSID and security information (network key (password)). (page 35) Refer to "How Can I Find the Wireless Security Information (SSID and Network Key)" on page 193.													

	Error messages	Cause/solution
13	The wireless LAN access point/router cannot be detected.	<p>The wireless access point/router cannot be detected.</p> <ol style="list-style-type: none"> Check the following 4 points. <ul style="list-style-type: none"> Make sure that the wireless access point/router is powered on. Move your machine to an area where no items can obstruct the wireless network signal, such as metal doors or walls, or closer to the wireless access point/router. Temporarily place your machine within about 1 m (3.3 feet) from the wireless access point when you are configuring the wireless settings. If your wireless access point/router is using MAC address filtering, confirm the MAC address of this machine is allowed in the filter. If you manually entered the SSID and security information (SSID/ authentication method/encryption method/network key (password)), the information may be incorrect. Reconfirm the SSID and security information and re-enter the correct information as necessary. (page 35) Refer to “How Can I Find the Wireless Security Information (SSID and Network Key)” on page 193.
14	The wireless security information (Authentication method, Encryption method, Network Key) is incorrect.	<p>The wireless security information (authentication method/encryption method/ network key (password)) is incorrect.</p> <p>Refer to the table for the [The authentication and encryption methods used by the selected wireless LAN access point/router are not supported by your machine.] error message, and reconfirm the wireless security information (authentication method/encryption method/network key (password)). (page 35)</p> <p>Refer to “How Can I Find the Wireless Security Information (SSID and Network Key)” on page 193.</p>
15	The wireless setting is not activated.	<p>The wireless network setting is not activated.</p> <p>Activate the wireless network. (page 34)</p>
16	This file cannot be used.	<p>This message appears if the file format is incompatible with this machine. Check the list of compatible file formats. (page 194)</p>
17	This file exceeds the data capacity and cannot be used. Use a suitable size file.	<p>This message is displayed when the file size exceeds the data capacity of the machine. Confirm the file size and format. (page 194)</p>
18	This USB media cannot be used.	<p>This message is displayed when you try to use incompatible media. For a list of compatible USB media, visit “ https://s.brother/cpdab/ ”.</p>
19	Turn off the machine before attaching or removing the needle plate.	<p>This message is displayed when you try to sew with a stitch other than a middle needle position stitch while the straight stitch needle plate is installed. This message is displayed when the needle plate is removed with the machine on or when the machine is turned on and embroidery mode is selected.</p>
20	USB media error	<p>This message is displayed when an error occurs with the USB media. For a list of compatible USB media, visit “ https://s.brother/cpdab/ ”.</p>
21	When the speed controller is set to control the zigzag stitch width, the “Start/Stop” button does not operate.	<p>This message is displayed when the speed control slide is set to control the stitch width, and the “Start/ Stop” button is pressed. Set [Width Control] to [OFF] in the settings screen to use the “Start/Stop” button (page 20), or use the foot controller to operate the machine (page 111).</p>

How Can I Find the Wireless Security Information (SSID and Network Key)

1. You should see the documentation provided with your wireless access point/router.
2. The default SSID (wireless network name) could be the manufacturer's name or the model name.
3. If you do not know the security information, please consult the router manufacturer, your system administrator, or Internet provider.
4. Some SSIDs and network keys (passwords) are case (upper case and lower case) sensitive. Please properly record your information.

- * The network key may also be described as the password, security key or encryption Key.
- * If the wireless access point/router is not broadcasting the SSID, the SSID will not automatically be detected. You will have to manually enter the SSID.

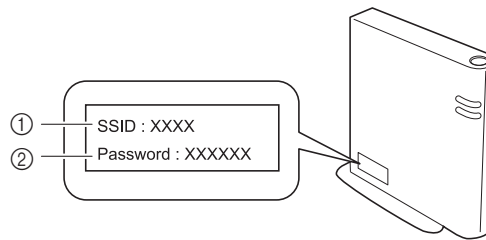

- ① SSID
- ② Network key (password)

SPECIFICATIONS

Item	Specification		
Dimensions of machine	Approx. 690 mm (W) × 322 mm (D) × 349 mm (H) (approx. 27-11/64 inches (W) × 12-43/64 inches (D) × 13-47/64 inches (H))		
Weight of machine	Approx. 19.6 kg (approx. 43.2 lb)		
Dimensions of machine with embroidery unit attached	Approx. 973 mm (W) × 576 mm (D) × 349 mm (H) (approx. 38-5/16 inches (W) × 22-43/64 inches (D) × 13-47/64 inches (H))		
Weight of machine with embroidery unit attached	Approx. 24.4 kg (approx. 53.7 lb)		
Sewing speed	70 to 1050 stitches per minute		
Maximum embroidery speed	1050 stitches per minute		
Compatible interface	Wireless LAN ^{*1}		
Memory	Stitch patterns	1 MB	
	Embroidery patterns	10 MB	
	My Design Center	100 MB	
Data types	Stitch patterns ^{*2}	.pmp, .pmv, .pmx, .pmu	
	Embroidery patterns ^{*3}	.pes .phc .phx .dst .pen	
	Data that can be loaded when using My Design Center	.jpg (up to 4 MB), .png (up to 4 MB), .bmp (up to 6 MB)	
Number of decorative stitch pattern combinations	Up to 70		
Embroidery pattern size	Maximum of 408 mm (H) × 272 mm (W) (approx.16 inches (H) × 10-5/8 inches (W))		
Types of USB Devices/ Media that can be used ^{*4}	Stitch patterns, Embroidery patterns	Data can be saved to or recalled from USB media. Use media that meets the following specifications. <ul style="list-style-type: none"> • USB Flash drive (USB Flash memory) Embroidery data can be recalled only. <ul style="list-style-type: none"> • USB external CD/DVD drives 	
Condition of the [Eco Mode] and [Shutoff Support Mode]	[Eco Mode]	Available time	OFF, 10 - 120 (minute)
		"Start/Stop" button	Green flashing
		Suspended function	Machine light, Screen display
		After recovering	The machine starts from the previous operation.
	[Shutoff Support Mode]	Available time	OFF, 1 - 12 (hour)
		"Start/Stop" button	Green slow flashing
		Suspended function	All functions
		After recovering	An error message appears. You need to turn off and on the machine to restart.
Compatible image files of the Screen Saver Image	Format	.jpg	
	File size	Max. 2 MB for each image	
	File dimension	800 × 1280 pixels or less (If the width is more than 800 pixels, the image imported will be reduced to a width of 800 pixels.)	
	Number allowed	5 or less	
Videos that can be played	MP4 file format	Video - H.264/MPEG-4 AVC, Audio – AAC	
	Size	450 (H) × 800 (W)	
	Maximum file size	1 GB	

^{*1} The wireless network connection complies with IEEE 802.11b/g/n standards and uses the 2.4 GHz frequency.

A wireless network cannot be set up with WPA/WPA2 Enterprise.

Use Design Database Transfer or PE-DESIGN version 11 or later to transfer data from your computer to the machine. For the operating systems compatible with the software, visit our website "<https://s.brother/cndka/>".

^{*2} ".pmv", ".pmu" or ".pmx" stitch data files can be retrieved; however, when the machine is used to save the file, it is saved as a ".pmp" stitch data file. Using data other than what was created using this machine or the machine which create ".pmp", ".pmv", ".pmx" or ".pmu" data file, may cause the machine to malfunction.

^{*3} Using data other than that saved using our data design systems or this machine may cause this machine to malfunction. When the machine is used to save a file with any extension, it is saved as a .phx data file. Since Tajima (.dst) data does not contain specific thread color information, it is displayed with our default thread color sequence. Check the preview and change the thread colors as desired.

^{*4} Some USB media may not be usable with this machine. Please visit our website "<https://s.brother/cpdab/>" for more details.

* Please be aware that some specifications may change without notice.

 **Note**

- We recommend using the 26 letters of the alphabet (uppercase and lowercase), the numbers 0 through 9, “-”, and “_” for the name of the file/folder.

IMPORTANT

- **When using embroidery data other than our original patterns, the thread may break or the needle may bend or break when embroidering with a stitch density that is too fine or when embroidering three or more overlapping stitches. In that case, use one of our original data design systems to edit the embroidery data.**

UPDATING YOUR MACHINE'S SOFTWARE

You can update your machine's software using the following two procedures.

Update Procedure Using USB Media

When an update program is available on "<https://s.brother/cpdab/>", please download the files following the instructions on the website and steps below.

Note

- Use a USB media with a capacity from 4 GB to 32 GB when updating the machine. Check that no data other than the update file is saved on the USB media being used before starting to update.
- Some USB media may not be usable with this machine. Please visit our website "<https://s.brother/cpdab/>" for more details.

1 While pressing the "Automatic Threading" button, turn the main power to ON.

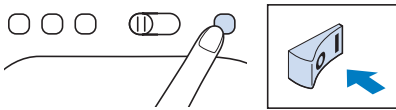

→ The following screen will appear on the LCD.

2 Touch or .

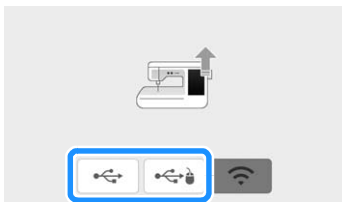

3 Insert the USB media into the USB port corresponding to the key touched in step 2. USB port on the machine. The media device should only contain the update file.

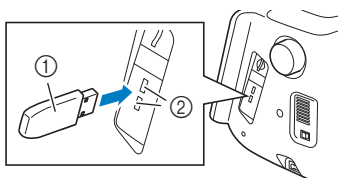

- ① USB media
- ② USB port

4 Touch to update the machine.

* Do not turn off the machine during the update.

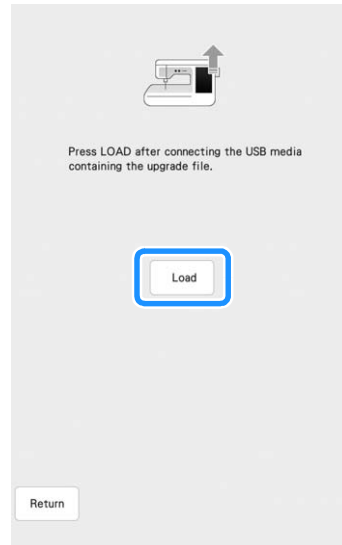

→ When updating is finished, the completion message appears.

5 Remove the USB media, and turn the machine off and on again.

Update Procedure Using Wireless LAN Connection

If the machine is connected to a wireless network with a strong, reliable connection, update files can be downloaded directly to the machine using this network.

For details on the wireless LAN connection, refer to page 34.

Memo

- The machine periodically checks if there is a new update file on the server. When there is a new update file, the wireless LAN key is displayed as .



1 Display page 12 of the settings screen.

2 Touch .

- * The machine starts to download the update file, if there is a new update file on server.

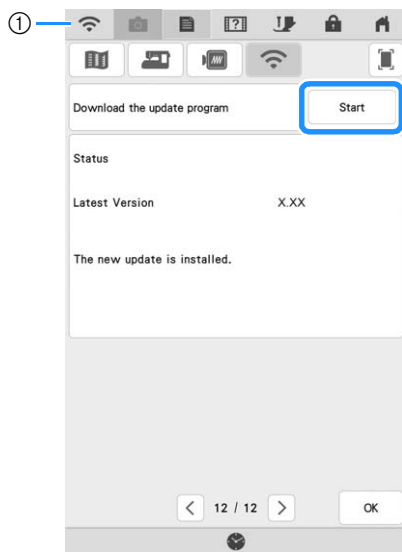

- ① When the wireless LAN key appears as , touching causes the machine to check if there is a new update file. If there is a new file, downloading begins.

Note

- Do not turn off the machine during the download.
- Touch to pause the download. To restart, touch .

3 When downloading is finished, turn off the machine, then hold down the “Automatic Threading” button while turning on the machine.

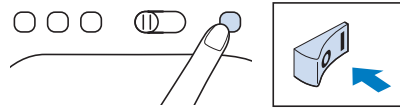

4 Touch .

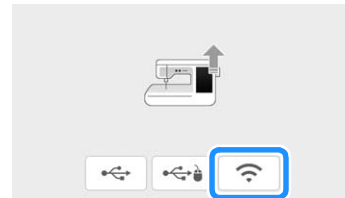

5 Touch to update the machine.

- * Do not turn off the machine during the update.

Memo

- If there are changes or additions to functions, manuals available on the machine may be updated.

STITCH SETTING CHART









































The following chart shows information for each utility stitch concerning applications, stitch lengths, stitch widths, and whether or not the twin needle mode can be used.

















































 **Note**

















































- For details on automatic reverse/reinforcement stitching for each stitch, refer to “Automatic Reinforcement Stitching” on page 66.

 **Memo**





















































- Advanced monogramming foot “N+” is displayed as “N” on the screen.











































Stitch	Stitch name	Presser foot		Applications	Stitch width [mm (inch)]		Stitch length [mm (inch)]		Twin needle
					Auto.	Manual	Auto.	Manual	
	Straight stitch (Left)			General sewing, gather, pintuck, etc.	—	—	2.5 (3/32)	0.2 - 5.0 (1/64 - 13/64)	OK (J)
	Straight stitch (Left)			General sewing, gather, pintuck, etc.	—	—	2.5 (3/32)	0.2 - 5.0 (1/64 - 13/64)	OK (J)
	Straight stitch (Middle)			General sewing, gather, pintuck, etc.	—	—	2.5 (3/32)	0.2 - 5.0 (1/64 - 13/64)	OK (J)
	Straight stitch (Middle)			General sewing, gather, pintuck, etc.	—	—	2.5 (3/32)	0.2 - 5.0 (1/64 - 13/64)	OK (J)
	Triple stretch stitch			General sewing for reinforcement and decorative topstitching	—	—	2.5 (3/32)	0.4 - 5.0 (1/64 - 13/64)	OK (J)
	Stem stitch			Reinforced stitching, sewing and decorative applications	1.0 (3/64)	0.0 - 7.0 (0 - 9/32)	2.5 (3/32)	0.4 - 5.0 (1/64 - 13/64)	OK (J)
	Decorative stitch			Decorative stitching, top stitching	—	—	2.5 (3/32)	0.4 - 5.0 (1/64 - 13/64)	OK (J)
	Basting stitch			Basting	—	—	5.0 (13/64)	5.0 (13/64)	NO
	Zigzag stitch			For overcasting, mending.	3.5 (9/64)	0.0 - 7.0 (0 - 9/32)	1.4 (1/16)	0.0 - 5.0 (0 - 13/64)	OK (J)
	Zigzag stitch			For overcasting, mending.	3.5 (9/64)	0.0 - 7.0 (0 - 9/32)	1.4 (1/16)	0.0 - 5.0 (0 - 13/64)	OK (J)
	Zigzag stitch (Right)			Start from right needle position, zigzag sew at left.	3.5 (9/64)	2.5 - 5.0 (3/32 - 13/64)	1.4 (1/16)	0.3 - 5.0 (1/64 - 13/64)	OK (J)
	Zigzag stitch (Left)			Start from left needle position, zigzag sew at right.	3.5 (9/64)	2.5 - 5.0 (3/32 - 13/64)	1.4 (1/16)	0.3 - 5.0 (1/64 - 13/64)	OK (J)
	2 steps elastic zigzag			Overcasting (medium weight and stretch fabrics), tape and elastic	5.0 (13/64)	0.0 - 7.0 (0 - 9/32)	1.0 (3/64)	0.2 - 5.0 (1/64 - 13/64)	OK (J)



Stitch	Stitch name	Presser foot		Applications	Stitch width [mm (inch)]		Stitch length [mm (inch)]		Twin needle
					Auto.	Manual	Auto.	Manual	
	2 steps elastic zigzag			Overcasting (medium weight and stretch fabrics), tape and elastic	5.0 (13/64)	0.0 - 7.0 (0 - 9/32)	1.0 (3/64)	0.2 - 5.0 (1/64 - 13/64)	OK (J)
	3 steps elastic zigzag			Overcasting (medium, heavyweight and stretch fabrics), tape and elastic	5.0 (13/64)	0.0 - 7.0 (0 - 9/32)	1.0 (3/64)	0.2 - 5.0 (1/64 - 13/64)	OK (J)
	Overcasting stitch			Reinforcing of light and medium weight fabrics	3.5 (9/64)	2.5 - 5.0 (3/32 - 13/64)	2.0 (5/64)	0.4 - 5.0 (1/64 - 13/64)	NO
	Overcasting stitch			Reinforcing of heavyweight fabric	5.0 (13/64)	2.5 - 5.0 (3/32 - 13/64)	2.5 (3/32)	0.4 - 5.0 (1/64 - 13/64)	NO
	Overcasting stitch			Reinforcing of medium, heavyweight and easily friable fabrics or decorative stitching.	5.0 (13/64)	3.5 - 5.0 (9/64 - 13/64)	2.5 (3/32)	0.4 - 5.0 (1/64 - 13/64)	NO
	Overcasting stitch			Reinforced seaming of stretch fabric	5.0 (13/64)	0.0 - 7.0 (0 - 9/32)	2.5 (3/32)	0.4 - 5.0 (1/64 - 13/64)	OK (J)
	Overcasting stitch			Reinforcing of medium stretch fabric and heavyweight fabric, decorative stitching	5.0 (13/64)	0.0 - 7.0 (0 - 9/32)	2.5 (3/32)	0.4 - 5.0 (1/64 - 13/64)	OK (J)
	Overcasting stitch			Reinforcement of stretch fabric or decorative stitching	4.0 (5/32)	0.0 - 7.0 (0 - 9/32)	4.0 (5/32)	0.4 - 5.0 (1/64 - 13/64)	OK (J)
	Overcasting stitch			Stretch knit seam	5.0 (13/64)	0.0 - 7.0 (0 - 9/32)	4.0 (5/32)	0.4 - 5.0 (1/64 - 13/64)	NO
	Single diamond overcast			Reinforcement and seaming stretch fabric	6.0 (15/64)	0.0 - 7.0 (0 - 9/32)	3.0 (1/8)	0.4 - 5.0 (1/64 - 13/64)	OK (J)
	Single diamond overcast			Reinforcement of stretch fabric	6.0 (15/64)	0.0 - 7.0 (0 - 9/32)	1.8 (1/16)	0.4 - 5.0 (1/64 - 13/64)	OK (J)
	With side cutter			Straight stitch while cutting fabrics	—	—	2.5 (3/32)	0.2 - 5.0 (1/64 - 13/64)	NO
	With side cutter			Zigzag stitch while cutting fabrics	3.5 (9/64)	3.5 - 5.0 (9/64 - 13/64)	1.4 (1/16)	0.0 - 5.0 (0 - 13/64)	NO
	With side cutter			Overcasting stitch while cutting fabrics	3.5 (9/64)	3.5 - 5.0 (9/64 - 13/64)	2.0 (5/64)	0.4 - 5.0 (1/64 - 13/64)	NO
	With side cutter			Overcasting stitch while cutting fabrics	5.0 (13/64)	3.5 - 5.0 (9/64 - 13/64)	2.5 (3/32)	0.4 - 5.0 (1/64 - 13/64)	NO
	With side cutter			Overcasting stitch while cutting fabrics	5.0 (13/64)	3.5 - 5.0 (9/64 - 13/64)	2.5 (3/32)	0.4 - 5.0 (1/64 - 13/64)	NO
	Piecing stitch (Right)			Piecework/patchwork 6.5 mm (approx. 1/4 inch) right seam allowance	—	—	2.0 (5/64)	0.2 - 5.0 (1/64 - 13/64)	NO
	Piecing stitch (Middle)			Piecework/patchwork * Be sure to use the straight stitch needle plate when using free motion quilting foot "C".	—	—	2.0 (5/64)	0.2 - 5.0 (1/64 - 13/64)	NO

























































Stitch	Stitch name	Presser foot		Applications	Stitch width [mm (inch)]		Stitch length [mm (inch)]		Twin needle
					Auto.	Manual	Auto.	Manual	
	Piecing stitch (Left)			Piecework/patchwork 6.5 mm (approx. 1/4 inch) left seam allowance	—	—	2.0 (5/64)	0.2 - 5.0 (1/64 - 13/64)	NO
	Hand-look quilting			Quilting stitch made to look like hand quilting stitch	—	—	2.5 (3/32)	0.4 - 5.0 (1/64 - 13/64)	NO
	Quilting appliqué zigzag stitch			Zigzag stitch for quilting and sewing on appliqué quilt pieces	3.5 (9/64)	0.0 - 7.0 (0 - 9/32)	1.4 (1/16)	0.0 - 5.0 (0 - 13/64)	NO
	Quilting appliqué stitch			Quilting stitch for invisible appliqué or attaching binding	1.5 (1/16)	0.0 - 7.0 (0 - 9/32)	1.8 (1/16)	0.4 - 5.0 (1/64 - 13/64)	NO
	Quilting stippling			Background quilting	7.0 (9/32)	0.0 - 7.0 (0 - 9/32)	1.6 (1/16)	0.4 - 5.0 (1/64 - 13/64)	NO
	Blind hem stitch			Hemming woven fabrics * The stitch width setting is in neither millimeters nor inches.	00	3← - →3	2.0 (5/64)	0.4 - 5.0 (1/64 - 13/64)	NO
	Blind hem stitch stretch			Hemming stretch fabric * The stitch width setting is in neither millimeters nor inches.	00	3← - →3	2.0 (5/64)	0.4 - 5.0 (1/64 - 13/64)	NO
	Blanket stitch			Appliqués, decorative blanket stitch	3.5 (9/64)	0.0 - 7.0 (0 - 9/32)	2.5 (3/32)	0.4 - 5.0 (1/64 - 13/64)	OK (J)
	Blanket stitch			Appliqués, decorative blanket stitch	2.5 (3/32)	0.0 - 7.0 (0 - 9/32)	2.5 (3/32)	0.4 - 5.0 (1/64 - 13/64)	OK (J)
	Shell tuck edge			Shell tuck edge finish on fabrics	4.0 (5/32)	0.0 - 7.0 (0 - 9/32)	2.5 (3/32)	0.2 - 5.0 (1/64 - 13/64)	OK (J)
	Satin scallop stitch			Decorating collar of blouse, edge of handkerchief	5.0 (13/64)	0.0 - 7.0 (0 - 9/32)	0.5 (1/64)	0.1 - 5.0 (1/64 - 13/64)	OK (J)
	Scallop stitch			Decorating collar of blouse, edge of handkerchief	7.0 (9/32)	0.0 - 7.0 (0 - 9/32)	1.4 (1/16)	0.4 - 5.0 (1/64 - 13/64)	NO
	Patchwork join stitch			Patchwork stitches, decorative stitching	4.0 (5/32)	0.0 - 7.0 (0 - 9/32)	1.2 (1/16)	0.2 - 5.0 (1/64 - 13/64)	OK (J)
	Patchwork double overlock stitch			Patchwork stitches, decorative stitching	5.0 (13/64)	0.0 - 7.0 (0 - 9/32)	2.5 (3/32)	0.4 - 5.0 (1/64 - 13/64)	OK (J)
	Couching stitch			Decorative stitching, attaching cord and couching	5.0 (13/64)	0.0 - 7.0 (0 - 9/32)	1.2 (1/16)	0.2 - 5.0 (1/64 - 13/64)	OK (J)
	Smocking stitch			Smocking, decorative stitching	5.0 (13/64)	0.0 - 7.0 (0 - 9/32)	1.6 (1/16)	0.4 - 5.0 (1/64 - 13/64)	OK (J)
	Feather stitch			Fagoting, decorative stitching	5.0 (13/64)	0.0 - 7.0 (0 - 9/32)	2.5 (3/32)	0.4 - 5.0 (1/64 - 13/64)	OK (J)
	Fagoting cross stitch			Fagoting, bridging and decorative stitching	5.0 (13/64)	0.0 - 7.0 (0 - 9/32)	2.5 (3/32)	0.4 - 5.0 (1/64 - 13/64)	OK (J)



























































Stitch	Stitch name	Presser foot		Applications	Stitch width [mm (inch)]		Stitch length [mm (inch)]		Twin needle
					Auto.	Manual	Auto.	Manual	
	Tape attaching			Attaching tape to seam in stretch fabric	4.0 (5/32)	0.0 - 7.0 (0 - 9/32)	1.0 (3/64)	0.2 - 5.0 (1/64 - 13/64)	OK (J)
	Ladder stitch			Decorative stitching	4.0 (5/32)	0.0 - 7.0 (0 - 9/32)	3.0 (1/8)	0.4 - 5.0 (1/64 - 13/64)	NO
	Rick-rack stitch			Decorative top stitching	4.0 (5/32)	0.0 - 7.0 (0 - 9/32)	2.5 (3/32)	0.4 - 5.0 (1/64 - 13/64)	OK (J)
	Decorative stitch			Decorative stitching	1.0 (3/64)	0.0 - 7.0 (0 - 9/32)	2.5 (3/32)	0.4 - 5.0 (1/64 - 13/64)	OK (J)
	Decorative stitch			Decorative stitching	5.5 (7/32)	0.0 - 7.0 (0 - 9/32)	1.6 (1/16)	0.4 - 5.0 (1/64 - 13/64)	OK (J)
	Serpentine stitch			Decorative stitching and attaching elastic	5.0 (13/64)	0.0 - 7.0 (0 - 9/32)	1.0 (3/64)	0.2 - 5.0 (1/64 - 13/64)	OK (J)
	Decorative stitch			Decorative stitching and appliqué	6.0 (15/64)	0.0 - 7.0 (0 - 9/32)	1.0 (3/64)	0.2 - 5.0 (1/64 - 13/64)	OK (J)
	Decorative stippling stitch			Decorative stitching	7.0 (9/32)	0.0 - 7.0 (0 - 9/32)	1.6 (1/16)	0.4 - 5.0 (1/64 - 13/64)	NO
	Hemstitching			Decorative hems, triple straight at left	—	—	2.5 (3/32)	0.4 - 5.0 (1/64 - 13/64)	OK (J)
	Hemstitching			Decorative hems, triple straight at center	—	—	2.5 (3/32)	0.4 - 5.0 (1/64 - 13/64)	OK (J)
	Hemstitching zigzag			Decorative hems, top stitching	6.0 (15/64)	0.0 - 7.0 (0 - 9/32)	3.0 (1/8)	0.4 - 5.0 (1/64 - 13/64)	OK (J)
	Hemstitching			Decorative hems, lace attaching pin stitch	3.5 (9/64)	0.0 - 7.0 (0 - 9/32)	2.5 (3/32)	0.4 - 5.0 (1/64 - 13/64)	NO
	Hemstitching			Decorative hems	3.0 (1/8)	0.0 - 7.0 (0 - 9/32)	3.5 (9/64)	0.4 - 5.0 (1/64 - 13/64)	NO
	Hemstitching			Decorative hems daisy stitch	6.0 (15/64)	0.0 - 7.0 (0 - 9/32)	3.0 (1/8)	0.4 - 5.0 (1/64 - 13/64)	NO
	Hemstitching			Heirloom, decorative hems	5.0 (13/64)	0.0 - 7.0 (0 - 9/32)	3.5 (9/64)	0.4 - 5.0 (1/64 - 13/64)	NO
	Hemstitching			Heirloom, decorative hems	5.0 (13/64)	0.0 - 7.0 (0 - 9/32)	3.5 (9/64)	0.4 - 5.0 (1/64 - 13/64)	NO
	Hemstitching			Heirloom, decorative hems	5.0 (13/64)	0.0 - 7.0 (0 - 9/32)	3.5 (9/64)	0.4 - 5.0 (1/64 - 13/64)	OK (J)
	Hemstitching			Heirloom, decorative hems	5.0 (13/64)	0.0 - 7.0 (0 - 9/32)	4.0 (5/32)	0.4 - 5.0 (1/64 - 13/64)	OK (J)
	Hemstitching			Heirloom, decorative hems	4.0 (5/32)	0.0 - 7.0 (0 - 9/32)	2.5 (3/32)	0.4 - 5.0 (1/64 - 13/64)	OK (J)

























































Stitch	Stitch name	Presser foot		Applications	Stitch width [mm (inch)]		Stitch length [mm (inch)]		Twin needle
					Auto.	Manual	Auto.	Manual	
	Honeycomb stitch			Heirloom, decorative hems	5.0 (13/64)	0.0 - 7.0 (0 - 9/32)	2.5 (3/32)	0.4 - 5.0 (1/64 - 13/64)	OK (J)
	Honeycomb stitch			Heirloom, decorative hems	6.0 (15/64)	0.0 - 7.0 (0 - 9/32)	3.5 (9/64)	0.4 - 5.0 (1/64 - 13/64)	OK (J)
	Hemstitching			Heirloom, decorative hems	6.0 (15/64)	0.0 - 7.0 (0 - 9/32)	1.6 (1/16)	0.4 - 5.0 (1/64 - 13/64)	OK (J)
	Hemstitching			Heirloom, decorative hems	6.0 (15/64)	0.0 - 7.0 (0 - 9/32)	3.0 (1/8)	0.4 - 5.0 (1/64 - 13/64)	NO
	Hemstitching			Heirloom, decorative hems	6.0 (15/64)	0.0 - 7.0 (0 - 9/32)	4.0 (5/32)	0.4 - 5.0 (1/64 - 13/64)	OK (J)
	Hemstitching			Heirloom, decorative hems	4.0 (5/32)	0.0 - 7.0 (0 - 9/32)	2.5 (3/32)	0.4 - 5.0 (1/64 - 13/64)	NO
	Hemstitching			Heirloom, decorative hems	5.0 (13/64)	0.0 - 7.0 (0 - 9/32)	2.0 (5/64)	0.4 - 5.0 (1/64 - 13/64)	OK (J)
	Hemstitching			Decorative hems and bridging stitch	6.0 (15/64)	0.0 - 7.0 (0 - 9/32)	2.0 (5/64)	0.4 - 5.0 (1/64 - 13/64)	OK (J)
	Hemstitching			Decorative hems. Fagoting, attaching ribbon	5.0 (13/64)	0.0 - 7.0 (0 - 9/32)	3.0 (1/8)	0.4 - 5.0 (1/64 - 13/64)	OK (J)
	Hemstitching			Decorative hems, smocking	6.0 (15/64)	0.0 - 7.0 (0 - 9/32)	1.6 (1/16)	0.4 - 5.0 (1/64 - 13/64)	NO
	Hemstitching			Decorative hems, smocking	5.0 (13/64)	0.0 - 7.0 (0 - 9/32)	1.6 (1/16)	0.4 - 5.0 (1/16 - 13/64)	NO
	Hemstitching			Decorative hems, smocking	5.0 (13/64)	0.0 - 7.0 (0 - 9/32)	1.6 (1/16)	0.4 - 5.0 (1/64 - 13/64)	NO
	Hemstitching			Decorative hems	5.0 (13/64)	0.0 - 7.0 (0 - 9/32)	1.6 (1/16)	0.4 - 5.0 (1/64 - 13/64)	NO
	Ladder stitch			Decorative hems. Fagoting, attaching ribbon	7.0 (9/32)	0.0 - 7.0 (0 - 9/32)	1.6 (1/16)	0.4 - 2.5 (1/64 - 3/32)	NO
	Narrow rounded buttonhole			Buttonhole on light to medium weight fabrics	5.0 (13/64)	3.0 - 6.5 (1/8 - 1/4)	0.4 (1/64)	0.2 - 1.0 (1/64 - 3/64)	NO
	Wide round ended buttonhole			Buttonholes with extra space for larger buttons	5.5 (7/32)	3.5 - 6.5 (9/64 - 1/4)	0.4 (1/64)	0.2 - 1.0 (1/64 - 3/64)	NO
	Tapered round ended buttonhole			Reinforced waist tapered buttonholes	5.0 (13/64)	3.0 - 6.5 (1/8 - 1/4)	0.4 (1/64)	0.2 - 1.0 (1/64 - 3/64)	NO
	Round ended buttonhole			Buttonholes with vertical bar tack in heavyweight fabrics	5.0 (13/64)	3.0 - 6.5 (1/8 - 1/4)	0.4 (1/64)	0.2 - 1.0 (1/64 - 3/64)	NO





















Stitch	Stitch name	Presser foot		Applications	Stitch width [mm (inch)]		Stitch length [mm (inch)]		Twin needle
					Auto.	Manual	Auto.	Manual	
	Round ended buttonhole			Buttonholes with bar tack	5.0 (13/64)	3.0 - 6.5 (1/8 - 1/4)	0.4 (1/64)	0.2 - 1.0 (1/64 - 3/64)	NO
	Round double ended buttonhole			Buttonholes for fine, medium to heavyweight fabrics	5.0 (13/64)	3.0 - 6.5 (1/8 - 1/4)	0.4 (1/64)	0.2 - 1.0 (1/64 - 3/64)	NO
	Narrow squared buttonhole			Buttonholes for light to medium weight fabrics	5.0 (13/64)	3.0 - 6.5 (1/8 - 1/4)	0.4 (1/64)	0.2 - 1.0 (1/64 - 3/64)	NO
	Wide squared buttonhole			Buttonholes with extra space for larger decorative buttons	5.5 (7/32)	3.5 - 6.5 (9/64 - 1/4)	0.4 (1/64)	0.2 - 1.0 (1/64 - 3/64)	NO
	Squared buttonhole			Heavy-duty buttonholes with vertical bar tacks	5.0 (13/64)	3.0 - 6.5 (1/8 - 1/4)	0.4 (1/64)	0.2 - 1.0 (1/64 - 3/64)	NO
	Stretch buttonhole			Buttonholes for stretch or woven fabrics	6.0 (15/64)	3.0 - 6.5 (1/8 - 1/4)	1.0 (3/64)	0.5 - 2.0 (1/64 - 5/64)	NO
	Heirloom buttonhole			Buttonholes for heirloom and stretch fabrics	6.0 (15/64)	3.0 - 6.5 (1/8 - 1/4)	1.5 (1/16)	1.0 - 3.0 (3/64 - 1/8)	NO
	Bound buttonhole			The first step in making bound buttonholes	5.0 (13/64)	0.0 - 6.5 (0 - 1/4)	2.0 (5/64)	0.2 - 4.0 (1/64 - 5/32)	NO
	Keyhole buttonhole			Buttonholes in heavyweight or thick fabrics for larger flat buttons	7.0 (9/32)	3.0 - 7.0 (1/8 - 9/32)	0.5 (1/64)	0.3 - 1.0 (1/64 - 3/64)	NO
	Tapered keyhole buttonhole			Buttonholes in medium to heavy weight fabrics for larger flat buttons	7.0 (9/32)	3.0 - 7.0 (1/8 - 9/32)	0.5 (1/64)	0.3 - 1.0 (1/64 - 3/64)	NO
	Keyhole buttonhole			Buttonholes with vertical bar tack for reinforcement in heavyweight or thick fabrics	7.0 (9/32)	3.0 - 7.0 (1/8 - 9/32)	0.5 (1/64)	0.3 - 1.0 (1/64 - 3/64)	NO
	4 steps buttonhole 1			Left side of 4 step buttonhole	5.0 (13/64)	1.5 - 7.0 (1/16 - 9/32)	0.4 (1/64)	0.2 - 1.0 (1/64 - 3/64)	NO
	4 steps buttonhole 2			Bar tack of 4 step buttonhole	5.0 (13/64)	1.5 - 7.0 (1/16 - 9/32)	0.4 (1/64)	0.2 - 1.0 (1/64 - 3/64)	NO
	4 steps buttonhole 3			Right side of 4 step buttonhole	5.0 (13/64)	1.5 - 7.0 (1/16 - 9/32)	0.4 (1/64)	0.2 - 1.0 (1/64 - 3/64)	NO
	4 steps buttonhole 4			Bar tack of 4 step buttonhole	5.0 (13/64)	1.5 - 7.0 (1/16 - 9/32)	0.4 (1/64)	0.2 - 1.0 (1/64 - 3/64)	NO
	Darning			Darning of medium weight fabric	7.0 (9/32)	2.5 - 7.0 (3/32 - 9/32)	2.0 (5/64)	0.4 - 2.5 (1/64 - 3/32)	NO
	Darning			Darning of heavyweight fabric	7.0 (9/32)	2.5 - 7.0 (3/32 - 9/32)	2.0 (5/64)	0.4 - 2.5 (1/64 - 3/32)	NO
	Bar tack			Reinforcement at opening of pocket, etc.	2.0 (5/64)	1.0 - 3.0 (3/64 - 1/8)	0.4 (1/64)	0.3 - 1.0 (1/64 - 3/64)	NO

Stitch	Stitch name	Presser foot		Applications	Stitch width [mm (inch)]		Stitch length [mm (inch)]		Twin needle
					Auto.	Manual	Auto.	Manual	
	Button sewing			Attaching buttons	3.5 (9/64)	2.5 - 4.5 (3/32 - 11/64)	—	—	NO
	Eyelet			For making eyelets, holes on belts, etc.	7.0 (9/32)	7.0 6.0 5.0 (9/32 15/64 13/64)	7.0 (9/32)	7.0 6.0 5.0 (9/32 15/64 13/64)	NO
	Star eyelet			For making star-shaped eyelets on holes.	—	—	—	—	NO
	Diagonally left up (Straight)			For attaching appliqué on tubular pieces of fabric and mitering corners	—	—	—	—	NO
	Reverse (Straight)			For attaching appliqué on tubular pieces of fabric and mitering corners	—	—	—	—	NO
	Diagonally right up (Straight)			For attaching appliqué on tubular pieces of fabric and mitering corners	—	—	—	—	NO
	Sideways to left (Straight)			For attaching appliqué on tubular pieces of fabric	—	—	—	—	NO
	Sideways to right (Straight)			For attaching appliqué on tubular pieces of fabric	—	—	—	—	NO
	Diagonally left down (Straight)			For attaching appliqué on tubular pieces of fabric and mitering corners	—	—	—	—	NO
	Forward (Straight)			For attaching appliqué on tubular pieces of fabric and mitering corners	—	—	—	—	NO
	Diagonally right down (Straight)			For attaching appliqué on tubular pieces of fabric and mitering corners	—	—	—	—	NO
	Sideways to left (Zigzag)			For attaching appliqué on tubular pieces of fabric	—	—	—	—	NO
	Sideways to right (Zigzag)			For attaching appliqué on tubular pieces of fabric	—	—	—	—	NO
	Forward (Zigzag)			For attaching appliqué on tubular pieces of fabric and mitering corners	—	—	—	—	NO
	Reverse (Zigzag)			For attaching appliqué on tubular pieces of fabric and mitering corners	—	—	—	—	NO
	Piecing stitch (Middle)			Piecingwork/patchwork	—	—	2.0 (5/64)	0.2 - 5.0 (1/64 - 13/64)	NO
	Piecing stitch (Right)			Piecingwork/patchwork 6.5 mm (approx. 1/4 inch) right seam allowance	—	—	2.0 (5/64)	0.2 - 5.0 (1/64 - 13/64)	NO
	Piecing stitch (Left)			Piecingwork/patchwork 6.5 mm (approx. 1/4 inch) left seam allowance	—	—	2.0 (5/64)	0.2 - 5.0 (1/64 - 13/64)	NO

Stitch	Stitch name	Presser foot		Applications	Stitch width [mm (inch)]		Stitch length [mm (inch)]		Twin needle
					Auto.	Manual	Auto.	Manual	
	Hand-look quilting			Quilting stitch made to look like hand quilting stitch	—	—	2.5 (3/32)	0.4 - 5.0 (1/64 - 13/64)	NO
	Basting stitch			Basting	—	—	5.0 (13/64)	5.0 (13/64)	NO
	Stem stitch			Reinforced stitching, sewing and decorative applications	1.00 (3/64)	0.00 - 7.00 (0 - 9/32)	2.5 (3/32)	0.4 - 5.0 (1/64 - 13/64)	NO
	Quilting appliqué zigzag stitch			Zigzag stitch for quilting and sewing on appliqué quilt pieces	3.50 (9/64)	0.00 - 7.00 (0 - 9/32)	1.6 (1/16)	0.0 - 5.0 (0 - 13/64)	NO
	Zigzag stitch (Right)			Start from right needle position, zigzag sew at left	3.50 (9/64)	2.50 - 5.00 (3/32 - 13/64)	1.6 (1/16)	0.3 - 5.0 (1/64 - 13/64)	NO
	Zigzag stitch (Left)			Start from left needle position, zigzag sew at right	3.50 (9/64)	2.50 - 5.00 (3/32 - 13/64)	1.6 (1/16)	0.3 - 5.0 (1/64 - 13/64)	NO
	2 steps elastic zigzag			Overcasting (medium weight and stretch fabrics), tape and elastic	5.00 (13/64)	0.00 - 7.00 (0 - 9/32)	1.0 (3/64)	0.2 - 5.0 (1/64 - 13/64)	NO
	3 steps elastic zigzag			Overcasting (medium, heavyweight and stretch fabrics), tape and elastic	5.00 (13/64)	0.00 - 7.00 (0 - 9/32)	1.0 (3/64)	0.2 - 5.0 (1/64 - 13/64)	NO
	Quilting appliqué stitch			Quilting stitch for invisible appliqué or attaching binding	2.00 (5/64)	0.00 - 7.00 (0 - 9/32)	2.0 (5/64)	0.4 - 5.0 (1/64 - 13/64)	NO
	Shell tuck edge			Shell tuck edge finish on fabrics	4.00 (5/32)	0.00 - 7.00 (0 - 9/32)	2.5 (3/32)	0.2 - 5.0 (1/64 - 13/64)	NO
	Blanket stitch			Appliqués, decorative blanket stitch	3.50 (9/64)	0.00 - 7.00 (0 - 9/32)	2.5 (3/32)	0.4 - 5.0 (1/64 - 13/64)	NO
	Quilting stippling			Background quilting	7.00 (9/32)	0.00 - 7.00 (0 - 9/32)	1.6 (1/16)	0.4 - 5.0 (1/64 - 13/64)	NO
	Overcasting stitch			Stretch knit seam	5.00 (13/64)	0.00 - 7.00 (0 - 9/32)	4.0 (5/32)	0.4 - 5.0 (1/64 - 13/64)	NO
	Tape attaching			Attaching tape to seam in stretch fabric	5.50 (7/32)	0.00 - 7.00 (0 - 9/32)	1.4 (1/16)	0.2 - 5.0 (1/64 - 13/64)	NO
	Serpentine stitch			Decorative stitching and attaching elastic	5.00 (13/64)	0.00 - 7.00 (0 - 9/32)	2.0 (5/64)	0.2 - 5.0 (1/64 - 13/64)	NO
	Feather stitch			Fagoting, decorative stitching	5.00 (13/64)	0.00 - 7.00 (0 - 9/32)	2.5 (3/32)	0.4 - 5.0 (1/64 - 13/64)	NO
	Fagoting cross stitch			Fagoting, bridging and decorative stitching	5.00 (13/64)	0.00 - 7.00 (0 - 9/32)	2.5 (3/32)	0.4 - 5.0 (1/64 - 13/64)	NO
	Couching stitch			Decorative stitching, attaching cord and couching	5.00 (13/64)	0.00 - 7.00 (0 - 9/32)	1.2 (1/16)	0.2 - 5.0 (1/64 - 13/64)	NO

Stitch	Stitch name	Presser foot		Applications	Stitch width [mm (inch)]		Stitch length [mm (inch)]		Twin needle
					Auto.	Manual	Auto.	Manual	
	Patchwork double overlock stitch			Patchwork stitches, decorative stitching	5.00 (13/64)	0.00 - 7.00 (0 - 9/32)	2.5 (3/32)	0.4 - 5.0 (1/64 - 13/64)	NO
	Smocking stitch			Smocking, decorative stitching	5.00 (13/64)	0.00 - 7.00 (0 - 9/32)	1.6 (1/16)	0.4 - 5.0 (1/64 - 13/64)	NO
	Rick-rack stitch			Decorative top stitching	4.00 (5/32)	0.00 - 7.00 (0 - 9/32)	2.5 (3/32)	0.4 - 5.0 (1/64 - 13/64)	NO
	Decorative stitch			Decorative stitching and appliqué	6.00 (15/64)	0.00 - 7.00 (0 - 9/32)	1.0 (3/64)	0.2 - 5.0 (1/64 - 13/64)	NO
	Decorative stitch			Decorative stitching	5.50 (7/32)	0.00 - 7.00 (0 - 9/32)	1.6 (1/16)	0.4 - 5.0 (1/64 - 13/64)	NO
	Hemstitching			Heirloom, decorative hems	5.00 (13/64)	0.00 - 7.00 (0 - 9/32)	2.0 (5/64)	0.4 - 5.0 (1/64 - 13/64)	NO
	Hemstitching			Decorative hems and bridging stitch	6.00 (15/64)	0.00 - 7.00 (0 - 9/32)	2.0 (5/64)	0.4 - 5.0 (1/64 - 13/64)	NO
	Single diamond overcast			Reinforcement and seaming stretch fabric	6.00 (15/64)	0.00 - 7.00 (0 - 9/32)	3.0 (1/8)	0.4 - 5.0 (1/64 - 13/64)	NO
	Overcasting stitch			Reinforcement of stretch fabric or decorative stitching	4.00 (5/32)	0.00 - 7.00 (0 - 9/32)	4.0 (5/32)	0.4 - 5.0 (1/64 - 13/64)	NO
	Appliqué stitch			Appliqués, decorative stitch	3.0 (1/8)	0.0 - 7.0 (0 - 9/32)	2.0 (5/64)	0.4 - 5.0 (1/64 - 13/64)	NO
	Blanket stitch			Appliques, decorative blanket stitch	4.0 (5/32)	0.0 - 7.0 (0 - 9/32)	2.5 (3/32)	0.4 - 5.0 (1/64 - 13/64)	OK (J)
	Decorative stitch			Decorative stitching	7.0 (9/32)	0.0 - 7.0 (0 - 9/32)	2.5 (3/32)	0.4 - 5.0 (1/64 - 13/64)	NO
	Decorative stitch			Decorative stitching	7.0 (9/32)	0.0 - 7.0 (0 - 9/32)	2.5 (3/32)	0.4 - 5.0 (1/64 - 13/64)	NO
	Decorative stitch			Decorative stitching	7.0 (9/32)	0.0 - 7.0 (0 - 9/32)	2.5 (3/32)	0.4 - 5.0 (1/64 - 13/64)	NO
	Decorative stitch			Decorative stitching	7.0 (9/32)	0.0 - 7.0 (0 - 9/32)	2.5 (3/32)	0.4 - 5.0 (1/64 - 13/64)	NO
	Decorative stitch			Decorative stitching	7.0 (9/32)	0.0 - 7.0 (0 - 9/32)	2.5 (3/32)	0.4 - 5.0 (1/64 - 13/64)	NO
	Decorative stitch			Decorative stitching	7.0 (9/32)	0.0 - 7.0 (0 - 9/32)	2.5 (3/32)	0.4 - 5.0 (1/64 - 13/64)	NO
	Decorative stitch			Decorative stitching	7.0 (9/32)	0.0 - 7.0 (0 - 9/32)	2.5 (3/32)	0.4 - 5.0 (1/64 - 13/64)	OK (J)
	Decorative stitch			Decorative stitching	7.0 (9/32)	0.0 - 7.0 (0 - 9/32)	0.4 (1/64)	0.1 - 5.0 (1/64 - 13/64)	OK (J)

Stitch	Stitch name	Presser foot		Applications	Stitch width [mm (inch)]		Stitch length [mm (inch)]		Twin needle
					Auto.	Manual	Auto.	Manual	
	Free motion couching stitch			Free motion couching stitch	—	—	—	—	NO
	Free-Motion Basting			Free motion basting stitch	—	—	—	—	NO
	Hand-look quilting			Quilting stitch made to look like hand quilting stitch	—	—	—	—	NO
	Hand-look quilting			Quilting stitch made to look like hand quilting stitch	—	—	—	—	NO
	Hand-look quilting			Quilting stitch made to look like hand quilting stitch	—	—	—	—	NO
	Tapering stitch			Stitch pattern can be tapered at the beginning or at the end of sewing.	7.0 (9/32)	2.5 - 7.0 (3/32 - 9/32)	1.0 (3/64)	0.1 - 5.0 (1/64 - 13/64)	NO
	Tapering stitch			Stitch pattern can be tapered at the beginning or at the end of sewing.	5.0 (13/64)	2.5 - 7.0 (3/32 - 9/32)	2.5 (3/32)	1.4 - 5.0 (1/16 - 13/64)	NO
	Tapering stitch			Stitch pattern can be tapered at the beginning or at the end of sewing.	5.0 (13/64)	2.5 - 7.0 (3/32 - 9/32)	2.5 (3/32)	1.4 - 4.0 (1/16 - 5/32)	NO
	Tapering stitch			Stitch pattern can be tapered at the beginning or at the end of sewing.	7.0 (9/32)	2.5 - 7.0 (3/32 - 9/32)	2.0 (5/64)	1.0 - 4.0 (3/64 - 5/32)	NO
	Tapering stitch			Stitch pattern can be tapered at the beginning or at the end of sewing.	7.0 (9/32)	2.5 - 7.0 (3/32 - 9/32)	3.5 (9/64)	2.5 - 4.0 (3/32 - 5/32)	NO
	Tapering stitch			Stitch pattern can be tapered at the beginning or at the end of sewing.	7.0 (9/32)	2.5 - 7.0 (3/32 - 9/32)	3.0 (1/8)	2.0 - 5.0 (5/64 - 13/64)	NO
	Tapering stitch			Stitch pattern can be tapered at the beginning or at the end of sewing.	7.0 (9/32)	3.0 - 7.0 (1/8 - 9/32)	3.0 (1/8)	2.5 - 5.0 (3/32 - 13/64)	NO
	Tapering stitch			Stitch pattern can be tapered at the beginning or at the end of sewing.	7.0 (9/32)	3.0 - 7.0 (1/8 - 9/32)	2.5 (3/32)	2.5 - 4.0 (3/32 - 5/32)	NO
	Tapering stitch			Stitch pattern can be tapered at the beginning or at the end of sewing.	7.0 (9/32)	2.5 - 7.0 (3/32 - 9/32)	2.5 (3/32)	1.4 - 4.0 (1/16 - 5/32)	NO
	Tapering stitch			Stitch pattern can be tapered at the beginning or at the end of sewing.	7.0 (9/32)	3.0 - 7.0 (1/8 - 9/32)	2.5 (3/32)	2.0 - 4.0 (5/64 - 5/32)	NO
	Tapering stitch			Stitch pattern can be tapered at the beginning or at the end of sewing.	7.0 (9/32)	4.0 - 7.0 (5/32 - 9/32)	3.0 (1/8)	2.5 - 4.0 (3/32 - 5/32)	NO
	Tapering stitch			Stitch pattern can be tapered at the beginning or at the end of sewing.	7.0 (9/32)	2.5 - 7.0 (3/32 - 9/32)	1.0 (3/64)	0.4 - 5.0 (1/64 - 13/64)	NO
	Tapering stitch			Stitch pattern can be tapered at the beginning or at the end of sewing.	6.0 (15/64)	4.0 - 7.0 (5/32 - 9/32)	0.3 (1/64)	0.2 - 2.0 (1/64 - 5/64)	NO
	Tapering stitch			Stitch pattern can be tapered at the beginning or at the end of sewing.	6.0 (15/64)	4.0 - 7.0 (5/32 - 9/32)	0.3 (1/64)	0.2 - 2.0 (1/64 - 5/64)	NO

Stitch	Stitch name	Presser foot		Applications	Stitch width [mm (inch)]		Stitch length [mm (inch)]		Twin needle
					Auto.	Manual	Auto.	Manual	
	Tapering stitch			Stitch pattern can be tapered at the beginning or at the end of sewing.	7.0 (9/32)	3.5 - 7.0 (9/64 - 9/32)	0.3 (1/64)	0.1 - 2.0 (1/64 - 5/64)	NO
	Tapering stitch			Stitch pattern can be tapered at the beginning or at the end of sewing.	7.0 (9/32)	4.0 - 7.0 (5/32 - 9/32)	3.5 (9/64)	2.5 - 4.0 (3/32 - 5/32)	NO
	Tapering stitch			Stitch pattern can be tapered at the beginning or at the end of sewing.	7.0 (9/32)	4.0 - 7.0 (5/32 - 9/32)	2.5 (3/32)	2.0 - 4.0 (5/64 - 5/32)	NO
	Tapering stitch			Stitch pattern can be tapered at the beginning or at the end of sewing.	7.0 (9/32)	4.5 - 7.0 (11/64 - 9/32)	2.5 (3/32)	2.0 - 4.0 (5/64 - 5/32)	NO
	Tapering stitch			Stitch pattern can be tapered at the beginning or at the end of sewing.	7.0 (9/32)	2.5 - 7.0 (3/32 - 9/32)	2.5 (3/32)	1.6 - 4.0 (1/16 - 5/32)	NO
	Tapering stitch			Stitch pattern can be tapered at the beginning or at the end of sewing.	7.0 (9/32)	4.0 - 7.0 (5/32 - 9/32)	2.5 (3/32)	2.0 - 4.0 (5/64 - 5/32)	NO

INDEX

A

Accessories	
included accessories	14
Accessory case	14
Accessory compartment	14
Advanced multi-function foot controller	63
Air vent	12
Alphabet characters	
character/decorative stitches	148
Appliqué	119
quilting	110
using a zigzag stitch	104
Arrow keys	171
Automatic fabric sensor system	78
Automatic reinforcement stitching	66
Automatic thread cutting key	75
Automatic threading button	13, 47

B

Ball point needle	56
Basting	125
Blind hem stitches	117
Block move key	173
Bobbin	
pulling up the bobbin thread	46
setting	44
winding	40
Bobbin case	
cleaning	178
Bobbin clip	14
Bobbin cover	13, 44
Bobbin winder	12
Bobbin winding switch	42
Built-in camera	79, 81
Button sewing	136
4 hole buttons	136
shank	137
Buttonholes	
four-step	133
odd-shaped/buttons that do not fit the button holder plate	131
one-step	128

C

Character/Decorative stitches	
adjustments	151
combining	158
editing	153
key functions	153
retrieving	164
saving	163
selecting	146
sewing	150
stitch selection screens	147
Cleaning	
LCD screen	178
machine casing	178
race	178
Clock	18
Combining stitch patterns	
character/decorative stitches	158
Compact dual feed foot	59, 110
Cord guide bobbin cover	105
Crazy quilting	104
Cylindrical pieces	71

D

Darning	134
Dart seam	101
Denim	56, 70
Dual purpose stylus	80, 171
Dual purpose stylus holder	81

E

Echo quilting	115
Eco mode	25
Editing	
character/decorative stitches	153
MY CUSTOM STITCH	170
Elastic zigzag stitches	105
Elongation key	156
Embroidery unit	13
carriage	13
End point setting	86
Enlarger key	171
Error messages	191
Eyelet	137

F

Fabrics	
fabric/thread/needle combinations	56
sewing heavyweight fabrics	69
sewing lightweight fabrics	71
sewing stretch fabrics	71, 131
Fagoting	122
Feed dogs	13, 112
Fine tipped stylus pen	15
Flat bed attachment	12
Flat fell seam	102
Free motion quilting	
free motion echo quilting foot "E"	115
free motion open toe quilting foot "O"	114
free motion quilting foot "C"	113
Free motion sewing mode	112

G

Gathering	102
Grid direction key	171

H

Handle	12
Hand-look quilting	116
Handwheel	12
Heirloom	124
Hemstitching	
drawn work	124
Home page screen	19

I

Image key	95, 172
Innov-eye Technology (for U.S.A. only)	79
Insert key	174

K

Key functions	
character/decorative stitches	153
MY CUSTOM STITCH	170
utility stitches	91
Knee lifter	12, 77

L

L/R Shift	73
LCD screen	12, 19
cleaning	178
light	21
Leather	71
Lower threading	
pulling up the bobbin thread	46
setting the bobbin	44
winding the bobbin	40

M

Machine help key	28
Machine operation mode key	186
Main power switch	12, 17
Memory	163
Metallic thread	41, 49
Mirror image key	94, 156
MPEG-4 (MP4) videos	32
Multi-directional sewing	138
Multi-purpose screwdriver	15
Muvit (for U.S.A. only)	59
MY CUSTOM STITCH	
designing	168
entering data	170
key functions	170
retrieving	176
saving	175
storing in your list	175

N

Needle	
changing the needle	54
changing the needle position	99
checking the needle location	79
fabric/thread/needle combinations	56
twin needle	50
Needle bar thread guides	13, 50
Needle calibration	26
Needle clamp screw	13
Needle mode selection key	50
Needle plate	13
Needle position	78, 99
Needle position button	13

O

Operation buttons	12, 13
Overcasting	104, 106

P

Patchwork	104
Piecing	109
1/4" piecing foot with guide	109
Pintuck	103
Pivoting	76
Point delete key	172
Power cord	17
Power cord receptacle	12
Presser foot	
attaching	57
pressure	78
removing	57
types	198
Presser foot holder	13, 57
Presser foot holder screw	13
Presser foot lever	12, 69
Presser foot lifter button	13
Presser foot/Needle exchange key	50, 54, 57
Pretension disk	12, 41, 44
Projector	80, 82

Q

Quilting	107
free motion	112
with satin stitches	111

R

Race	178
Reinforcement stitch	66
Reinforcement stitch button	13, 66
Retrieving	
MY CUSTOM STITCH designs	176
stitch settings	96
USB media	164
utility stitches	96
Reverse stitch button	13, 66
Reverse/Reinforcement stitches	66

S

Satin stitches	111, 157
Saving	
character/decorative stitches	163
machine's memory	163
MY CUSTOM STITCH designs	175
stitch settings	96
utility stitches	96
Scallop stitches	120
Screen saver	25
SD card	
usable	163
Set key	171
Settings	
automatic thread cutting	75
embroidery settings	23
general settings	21
machine setting mode key	20
sewing settings	20
stitch length	73
stitch width	72
thread tension	74
Sewing speed controller (speed control slide)	12, 13, 62
Sewing type selection key	30
Shelltuck stitches	120
Shutoff support mode	25
Side cutter	199
Single/Repeat sewing key	156
Single/Triple stitching key	171
Size selection key	156
Smocking stitches	121
Speaker	21
Specifications	194
Speed	13
Spool cap	12
Spool net	41
Spool pin	12
Spool stand	44, 52
Start/Stop button	13
Step stitch patterns	161
Stitch setting chart	198
Stitch tapering function	142
StitchVision Technology (for U.S.A. only)	80
Straight stitch foot	100
Straight stitch needle plate	100
Straight stitches	97
Stretch fabrics	71
Supplemental spool pin	12, 40, 50

T

Tape attaching	105
Tape or elastic attaching	123
Test key	172, 175
Thick fabrics	69

Thin fabrics	71
Thread	
fabric/thread/needle combinations	56
thread tension	74
Thread cutter	12, 63
Thread cutter button	13
Thread density key	157
Thread guide	12, 41, 43, 51
Thread guide plate	12, 43, 47
Top cover	12
Top stitching	121
Transparent nylon thread	56
Troubleshooting	181
Tutorial video	31
Twin needle	50

U

Up Close Viewer (for U.S.A. only)	79
Updating	196
Upper threading	
twin needle mode	50
using the "Automatic Threading" button	47
USB media	
recalling	164
USB mouse	37
USB port connector	
for media	12
Utility stitches	
key functions	91
retrieving	96
saving	96
selecting	90
sewing type selection key	30
stitch pattern explanation key	32
stitch selection screens	93
stitch setting chart	198

V

Vinyl fabrics	71
---------------------	----

W

Wireless network connection	34
-----------------------------------	----

Z

Zigzag stitches	104
Zipper insertion	
centered	139
side	140





My Stitch Monitor is a mobile app that monitors the operating conditions of your machine.

Visit the Google Play™ or App Store to download.



Google Play™



App Store



My Design Snap is a mobile app that transfers an image from the smart device to the machine to create a design in My Design Center.

Visit the Google Play™ or App Store to download.



Google Play™



App Store



Design Database Transfer is a dedicated Windows application for wirelessly transferring embroidery data from a computer to the machine. This application can also be used to view and manage embroidery data.

Visit us at <https://s.brother/cadka/> to download the application.

Various optional accessories are available to be purchased separately.

Visit our website <https://s.brother/codka/>.



Please visit us at <https://s.brother/cpdab/> where you can get product support and answers to frequently asked questions (FAQs).



Be sure to install the latest software.

A variety of functional improvements are being performed in the latest version.



Brother SupportCenter is a mobile app that provides the support information for your Brother product.

Visit the Google Play™ or App Store to download.



Google Play™



App Store

This machine is approved for use in the country of purchase only. Local Brother companies or their dealers will only support machines purchased in their own countries.