

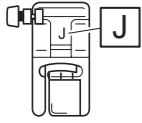

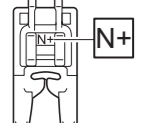

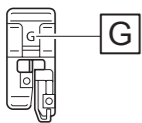

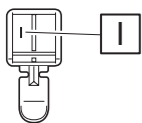

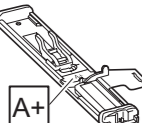
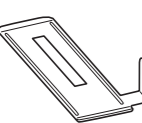
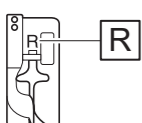
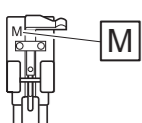
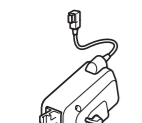
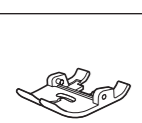
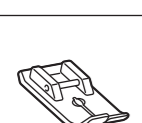
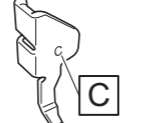

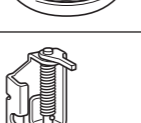
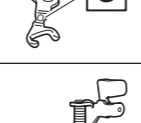

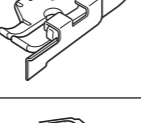
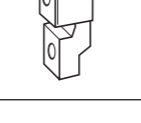
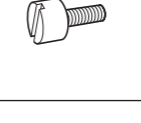
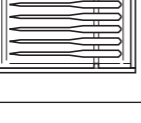
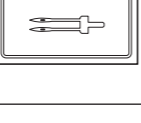



Included Accessories



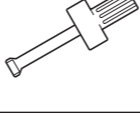

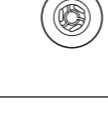
We recommend that you keep this document nearby for future reference.

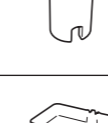

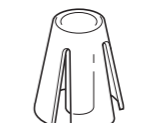
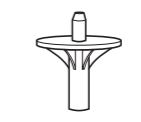
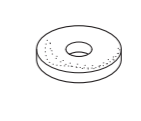
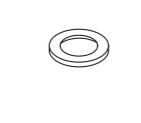
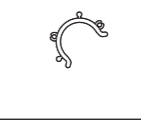
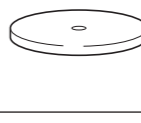
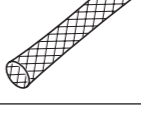

Thank you for purchasing this machine.
The following accessories are included with this product.

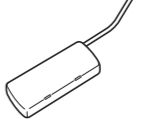
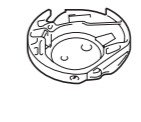



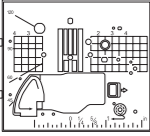
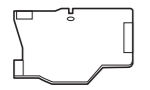
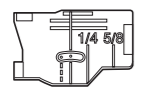
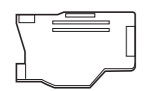
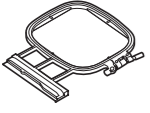
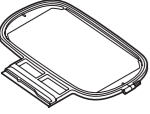

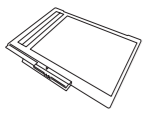
	Part Name
1. 	Zigzag foot "J" (on machine)
2. 	Advanced monogramming foot "N+"
3. 	Overcasting foot "G"
4. 	Zipper foot "I"
5. 	Buttonhole foot "A+"
6. 	Buttonhole foot stabilizer
7. 	Blind stitch foot "R"
8. 	Button fitting foot "M"
9. 	Compact dual feed foot
10. 	Regular dual feed foot (on compact dual feed foot)
11. 	Straight stitch foot

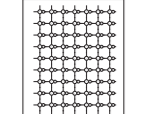

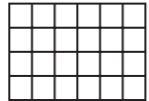

	Part Name
12. 	Free motion quilting foot "C"
13. 	Free motion echo quilting foot "E" *Attach the included adapter to use this product.
14. 	Free motion open toe quilting foot "O"
15. 	Embroidery foot "W"
16. 	1/4" piecing foot with guide
17. 	Adapter
18. 	Screw (small)
19. 	Needle set 75/11 2 needles 90/14 2 needles 90/14 2 needles: Ball point needle (gold colored)
20. 	Twin needle 2/11 needle
21. 	Ball point needle set 75/11 2 needles: Ball point needle for embroidery HAX130EBBR

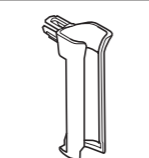
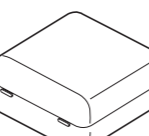
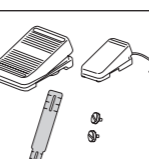
	Part Name
22. 	Bobbin × 10 (One bobbin is on machine.)
23. 	Seam ripper
24. 	Scissors
25. 	Cleaning brush
26. 	Eyelet punch
27. 	Screwdriver (small)
28. 	Screwdriver (large)
29. 	Multi-purpose screwdriver
30. 	Spool cap (small)
31. 	Spool cap (medium) × 2 (One spool cap is on machine.)
32. 	Spool cap (large)
33. 	Thread spool insert (mini king thread spool)
34. 	Spool stand

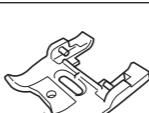
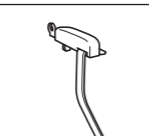
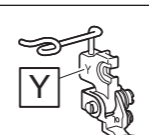
	Part Name
35. 	Spool cap (XL) × 2
36. 	Spool holder × 2
37. 	Spool cap base × 2
38. 	Spool felt × 2
39. 	Ring × 4
40. 	Bobbin clip × 10
41. 	Spool felt (on machine)
42. 	Spool net × 2
43. 	Embroidery needle plate cover
44. 	Knee lifter
45. 	Alternate bobbin case (no color on the screw)
46. 	Standard bobbin case (green marking on the screw) (on machine)

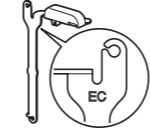
	Part Name
47.	 Straight stitch needle plate
48.	 Cord guide bobbin cover (with single hole)
49.	 Bobbin cover (with mark) (on straight stitch needle plate)
50.	 Bobbin cover (on machine)
51.	 Embroidery frame (medium) H 100 mm × W 100 mm (H 4 inches × W 4 inches)
52.	 Embroidery frame (large) H 180 mm × W 130 mm (H 7 inches × W 5 inches)
53.	 Embroidery frame H 272 mm × W 272 mm (H 10-5/8 inches × W 10-5/8 inches)
54.	 Embroidery frame (LL) H 408 mm × W 272 mm (H 16 inches × W 10-5/8 inches)
55.	 Scanning frame
56.	 Magnet × 6
57.	 Embroidery bobbin thread
58.	 Embroidery positioning sticker sheets × 2

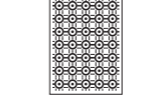
	Part Name
59.	 White calibration stickers (solid)
60.	 Stabilizer material
61.	 Grid sheet set
62.	 Chalk pencil
63.	 Dual purpose stylus
64.	 Dual purpose stylus holder
65.	 Accessory case
66.	 Advanced multi-function foot controller - Main foot controller - Side pedal - Mounting plate - Mounting screw × 2
67.	 Bobbin center pin and instruction sheet
68.	 Couching dual feed foot
69.	 Yarn guide for sewing couching
70.	 Embroidery couching foot "Y"

	Part Name
71.	 Yarn guide for embroidery couching
72.	 Yarn threader
73.	 End point stickers (4 sheets, 243 stickers per sheet)
74.	 Fine tipped stylus pen

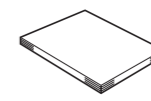
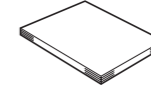
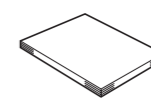
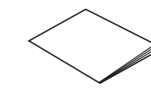
	Part Name
75.	 Operation Manual (Sewing)
76.	 Operation Manual (Embroidery)
77.	 Embroidery Design Guide
78.	 DISNEY DESIGN GUIDE

 **Note**

- The screw for the presser foot holder is available through your authorized Brother dealer.

Optional Accessories

Various optional accessories are available to be purchased separately. Please visit our website for more details. To obtain optional accessories or parts, contact your nearest authorized Brother dealer.



<https://s.brother/codka/>