

# brother

**Embroidery Design Guide**

**Guide till broderimönster**

**Broderidesign oversigt**

**Průručka k navrhování  
výšivek**

**Hímzésminta-útmutató**

**Przewodnik  
projektowania haftów**

**Catalog cu modele  
de broderii**



## Note

- Please read Terms of Use for various Embroidery Patterns in Operation Manual before using.
- Embroidery time and size of each design in this guide may differ from the information on the machine display. Please use for reference purpose only.

## OBS

- Läs användarvillkoren för olika brodermönster i bruksanvisningen innan du påbörjar användningen.
- Broderitid och storlek på varje design i denna guide kan skilja sig från informationen på maskinens display. Använd endast som referensändamål.

## Bemærk

- Læs Betingelser for brug for forskellige broderimønstre i brugsanvisningen før brug.
- BrodeBroderitiden og størrelsen af de enkelte mønstre i denne guide kan variere fra oplysningerne i maskinens display. Disse oplysninger er kun vejledende.

## Poznámka

- Před použitím se prosím seznámte s podmínkami používání pro jednotlivé vzory vyšívání v uživatelské příručce.
- Doba vyšívání a velikost jednotlivých návrhů v tomto průvodci se může lišit od informací na displeji stroje. Používejte pouze pro orientaci.

## Megjegyzés

- Kérjük, használat előtt olvassa el a különböző hímzésminták felhasználói feltételeit a használati utasításban.
- Az útmutatóban megjelenő hímzési idők és mintaméretek eltérhetnek a gép kijelzőjén megjelenő információktól. Csak referenciaként használja.

## INFORMACJA

- Przed przystąpieniem do użytku zapoznaj się z warunkami korzystania dotyczącymi różnych wzorów haftu w instrukcji obsługi.
- Czas wykonania i rozmiar poszczególnych wzorów w niniejszej instrukcji może się różnić od informacji na wyświetlaczu maszyny. Dane te mają charakter jedynie poglądowy.

## Notă

- Înainte de utilizare, vă rugăm să citiți condițiile de utilizare ale diferitelor modele de broderie din Manualul de utilizare.
- Timpul de coasere și dimensiunea de brodere a fiecărui model din acest ghid pot să difere față de informațiile afișate pe ecranul mașinii. Vă rugăm să folosiți aceste informații numai în scop informativ.

## Contents

- 2 Summary of Embroidery Patterns
- 15 Embroidery Patterns Color Change Table
- 44 Examples of Combinations
- 46 Create 3D embroidery
- 47 Font Name Chart

## Indholdsfortegnelse

- 2 Oversigt over broderimønstre
- 15 Oversigt over de indbyggede broderimønstre med farver
- 44 Eksempler på kombinationer
- 46 Lav 3D-broderi
- 47 Skema over skrifttypenavne

## Tartalomjegyzék

- 2 A hímzésminták összefoglalása
- 15 A hímzésminták színcsere-táblázata
- 44 Kombinálási példák
- 46 3D hímzés létrehozása
- 47 Betűtípus-névtáblázat

## Cuprins

- 2 Sumarul modelelor de broderie
- 15 Tabel de modificare a culorilor modelului de broderie
- 44 Exemple de combinații
- 46 Creare broderie 3D
- 47 Diagrama cu numele fonturilor

## Innehåll

- 2 Översikt över broderimönster
- 15 Broderimönster färgändringstabell
- 44 Exempel på kombinationer
- 46 Skapa 3D-broderi
- 47 Tabell över namn på teckensnitt

## Obsah

- 2 Shrnutí vyšívacích vzorů
- 15 Tabulka s variantami barev vyšívacích vzorů
- 44 Příklady kombinací
- 46 Tvorba 3D výšivky
- 47 Tabulka s názvy písem

## Spis treści

- 2 Podsumowanie wzorców haftów
- 15 Tabela zmiany kolorów wzorów haftów
- 44 Przykłady połączeń
- 46 Tworzenie haftu 3D
- 47 Tabela nazw czcionek

Summary of Embroidery Patterns  
 Oversigt over broderimønstre  
 A hímzsminták összefoglalása  
 Sumarul modelelor de broderie

Översikt över broderimönster  
 Shrnutí vyšívacích vzorů  
 Podsumowanie wzorców haftów

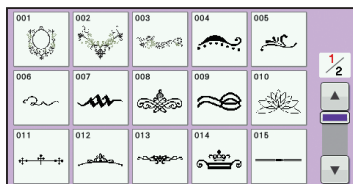
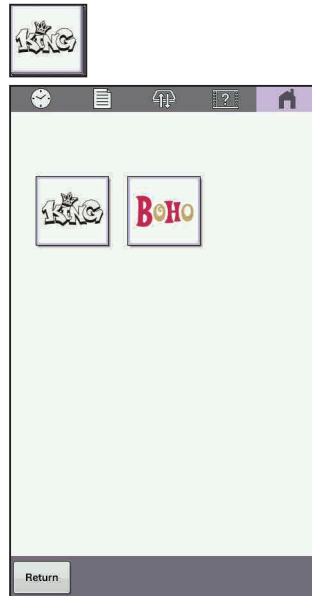
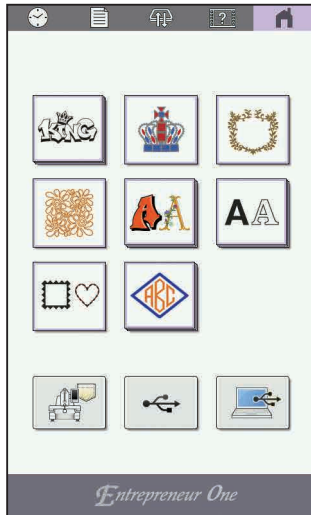



001	A	002	B	003	C	004	D	005	E
006	F	007	G	008	H	009	I	010	J
011	K	012	L	013	M	014	N	015	O

016	P	017	Q	018	R	019	S	020	T
021	U	022	V	023	W	024	X	025	Y
026	Z								



001	0	002	1	003	2	004	3	005	4
006	5	007	6	008	7	009	8	010	9



001	A	002	B	003	C	004	D	005	E
006	F	007	G	008	H	009	I	010	J
011	K	012	L	013	M	014	N	015	O

016	P	017	Q	018	R	019	S	020	T
021	U	022	V	023	W	024	X	025	Y
026	Z								



001	A	002	B	003	C	004	D	005	E
006	F	007	G	008	H	009	I	010	J
011	K	012	L	013	M	014	N	015	O

016	P	017	Q	018	R	019	S	020	T
021	U	022	V	023	W	024	X	025	Y
026	Z	A	B	C	D				

031	E	032	F	033	G	034	H	035	I
036	J	037	K	038	L	039	M	040	N
041	O	042	P	043	Q	044	R	045	S

046	T	047	U	048	V	049	W	050	X
051	Y	052	Z	053		054		055	
056		057		058		059		060	

061		062		063		064			



001	A	002	B	003	C	004	D	005	E
006	F	007	G	008	H	009	I	010	J
011	K	012	L	013	M	014	N	015	O

016	P	017	Q	018	R	019	S	020	T
021	U	022	V	023	W	024	X	025	Y
026	Z								



001	A	002	B	003	C	004	D	005	E
006	F	007	G	008	H	009	I	010	J
011	K	012	L	013	M	014	N	015	O

016	P	017	Q	018	R	019	S	020	T
021	U	022	V	023	W	024	X	025	Y
026	Z								

AB

001	A	B	C	D	E
006	F	G	H	I	J
011	K	L	M	N	O

016	P	Q	R	S	T
021	U	V	W	X	Y
026	Z	0	1	2	3

031	4	5	6	7	8
036	9				

AA

001	A	B	Γ	Δ	E
006	Z	H	Θ	I	K
011	Λ	M	N	Ξ	O

016	Π	P	Σ	T	Υ
021	Φ	X	Ψ	Ω	

AA

00	<i>ABC</i>				
01	ABC	ABC	ABC		
04	ABC	ABC	ABC		
07	ABC	ABC	ABC		
10	ABC	ABC	ABC		
13	ABC	ABC	ABC		

16	ABC	ABC	ABC
19	ABC	ABC	ABC
22	ABC	ABC	ABC
25	ABCD	ABCD	ABCD
28	ABCD	ABCD	ABCD
30	ABV	ABV	

T01	ABC
-----	-----

00 *ABC*

ABC	abc	0-9,.	&?!	ÄÄä	ÑÑñ
A	B	C	D	E	F
G	H	I	J	K	L
M	N	O	P	Q	R
S	T	U	V	W	X
Y	Z				

ABC	abc	0-9,.	&?!	ÄÄä	ÑÑñ
a	b	c	d	e	f
g	h	i	j	k	l
m	n	o	p	q	r
s	t	u	v	w	x
y	z				

ABC	abc	0-9,.	&?!	ÄÄä	ÑÑñ
0	1	2	3	4	5
6	7	8	9	#	%
\$	€	¥	-	+	x
÷	=	*	.	,	

ABC	abc	0-9,.	&?!	ÄÄä	ÑÑñ
g	p	/	@	<	>
/	/	/	\	~	:
@	TM	"	"	"	'

ABC	abc	0-9,.	&?!	ÄÄä	ÑÑñ
A	A	A	A	à	á
â	ä	æ	ç	ç	Đ
È	É	è	é	ê	ë
í	ï	ì	í	î	ï

ABC	abc	0-9,.	&?!	ÄÄä	ÑÑñ
N	N	n	Ö	Ö	ø
Ó	ó	ô	õ	ö	œ
í	Û	Ü	ù	ú	ü
š	š	š			

01 ABC

ABC	abc	0-9,.	&?!	ÄÄä	ÑÑñ
A	B	C	D	E	F
G	H	I	J	K	L
M	N	O	P	Q	R
S	T	U	V	W	X
Y	Z				

ABC	abc	0-9,.	&?!	ÄÄä	ÑÑñ
a	b	c	d	e	f
g	h	i	j	k	l
m	n	o	p	q	r
s	t	u	v	w	x
y	z				

ABC	abc	0-9,.	&?!	ÄÄä	ÑÑñ
0	1	2	3	4	5
6	7	8	9	#	%
\$	€	¥	-	+	x
÷	=	*	.	,	

ABC	abc	0-9,.	&?!	ÄÄä	ÑÑñ
&	?	!	@	<	>
(	)	[	]	/	\
~	:	;	©	®	™
"	"	"	'	'	'

ABC	abc	0-9,.	&?!	ÄÄä	ÑÑñ
Â	Ã	Ä	Æ	à	á
â	ã	ä	æ	ç	ç
Đ	È	É	è	é	ê
ë	í	ï	ì	í	î
ï	ì	í	î	ï	ì

ABC	abc	0-9,.	&?!	ÄÄä	ÑÑñ
Ñ	Ñ	ñ	Ô	Õ	ø
Ó	ó	ô	õ	ö	œ
í	Û	Ü	ù	ú	ü
š	š	š			

Summary of Embroidery Patterns  
 Oversigt over broderimønstre  
 A hímzsminták összefoglalása  
 Sumarul modelelor de broderie

Översikt över broderimönster  
 Shrnutí vyšivacích vzorů  
 Podsumowanie wzorców haftów

02  
 ABC

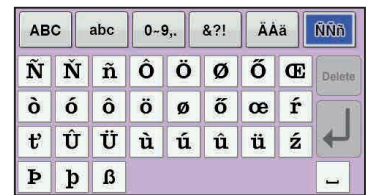
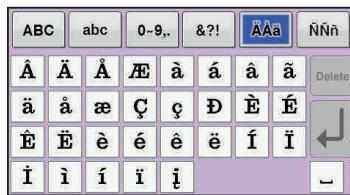
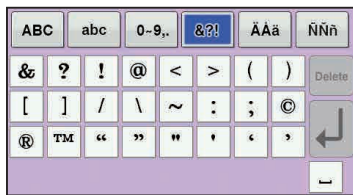
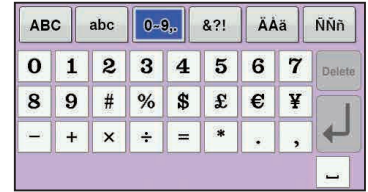
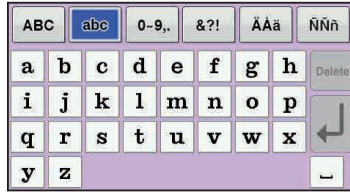
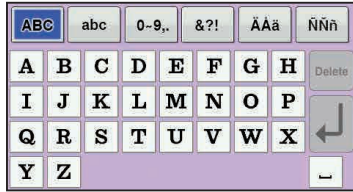

03  
 ABC

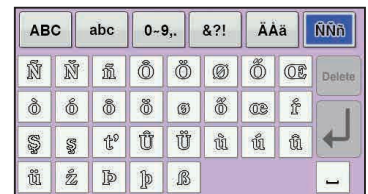
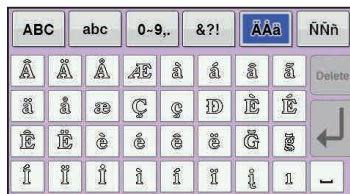
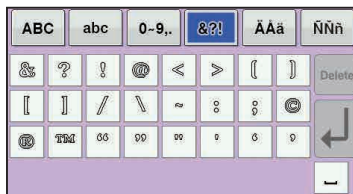
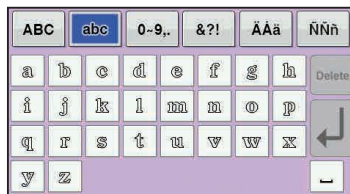
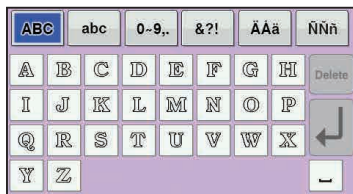

04  
 ABC

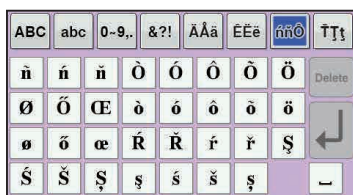
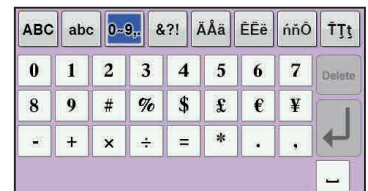
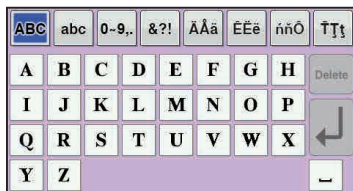

05  
 ABC

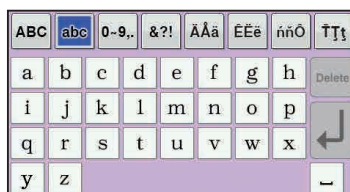
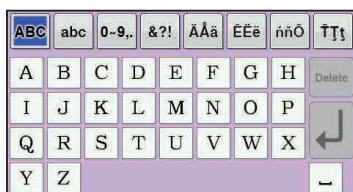

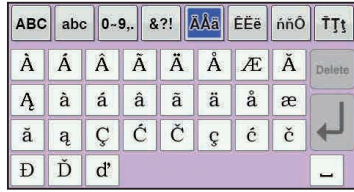
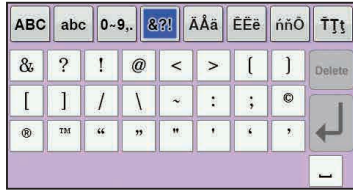

06 ABC

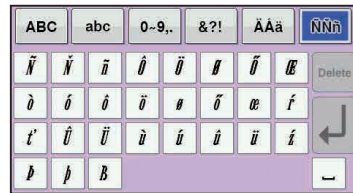
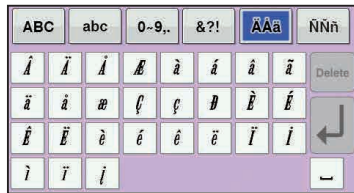
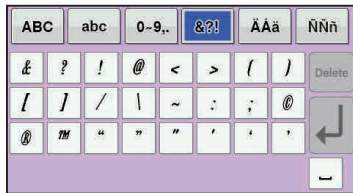
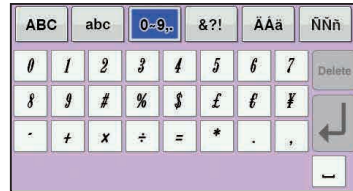
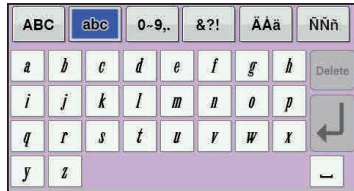
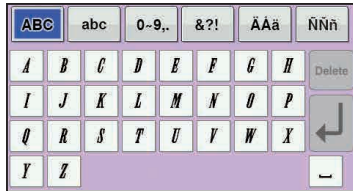

07 ABC

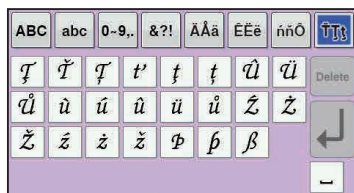
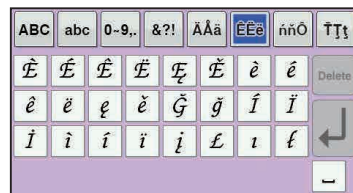
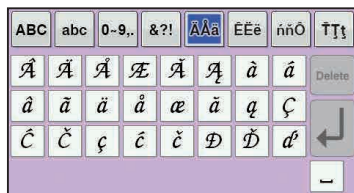
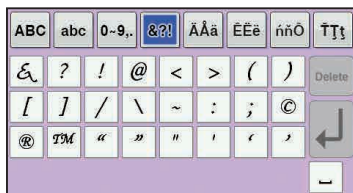
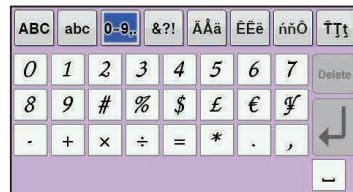
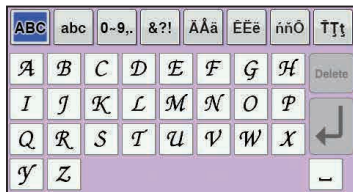

08 ABC

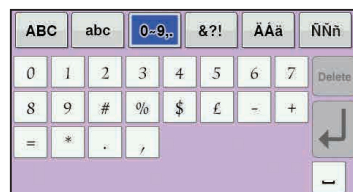
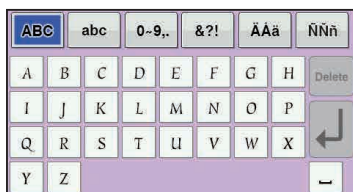



Summary of Embroidery Patterns  
 Oversigt over broderimønstre  
 A hímzsminták összefoglalása  
 Sumarul modelelor de broderie

Översikt över broderimönster  
 Shrnutí vyšivacích vzorů  
 Podsumowanie wzorców haftów

09

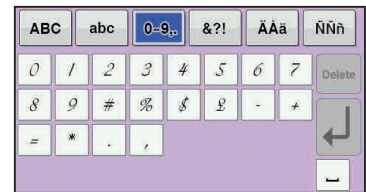
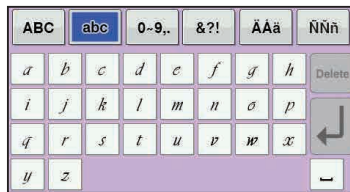
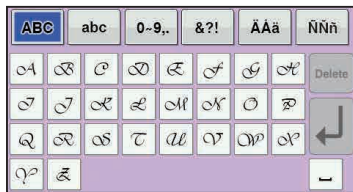
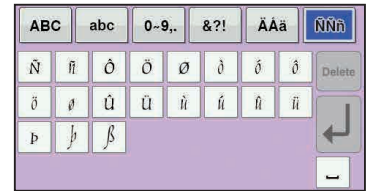
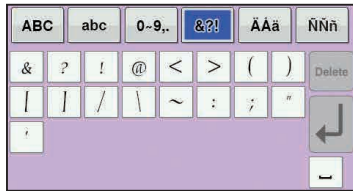

10

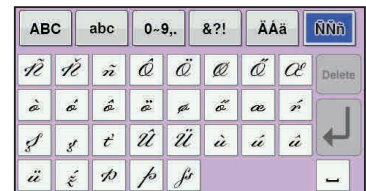
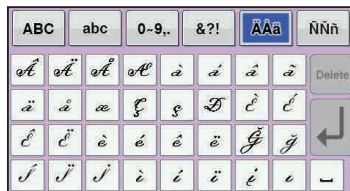
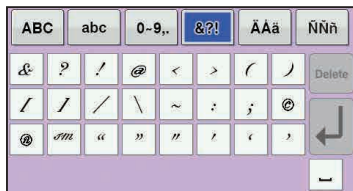
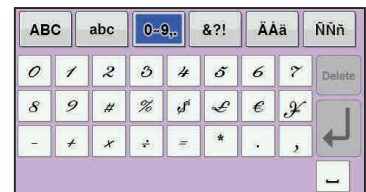
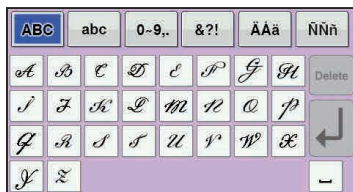
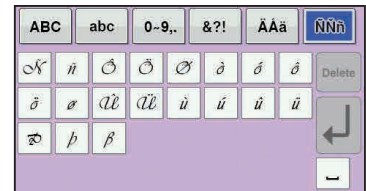
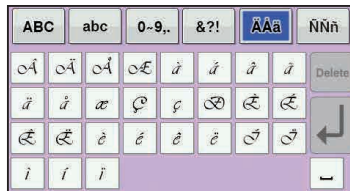
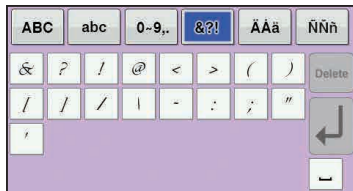

11

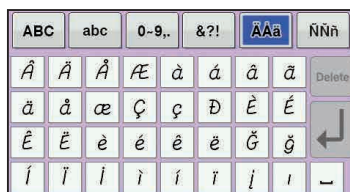
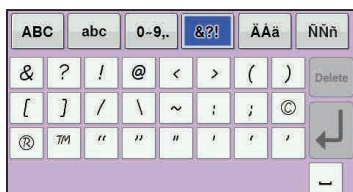
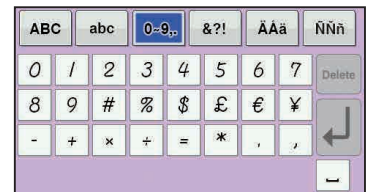
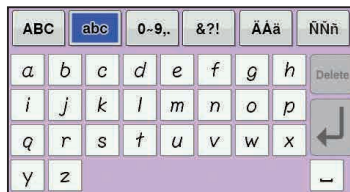
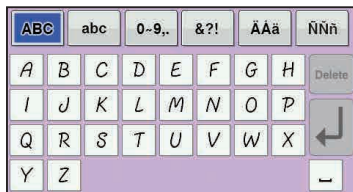

12

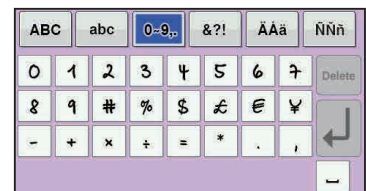
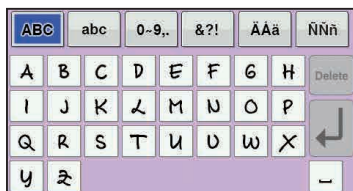

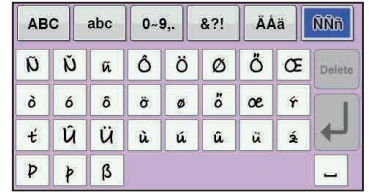
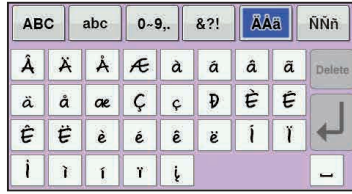
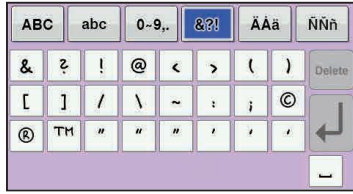

13 ABC

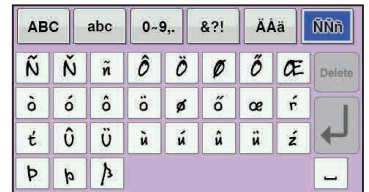
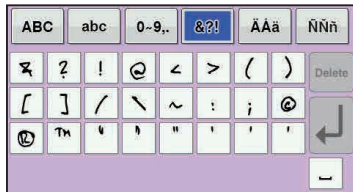
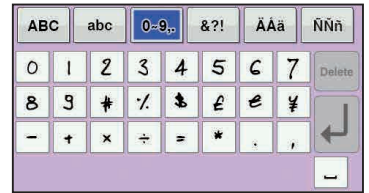
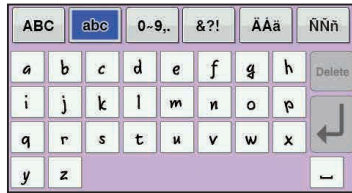
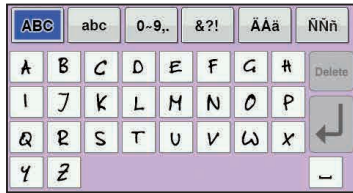

14 ABC

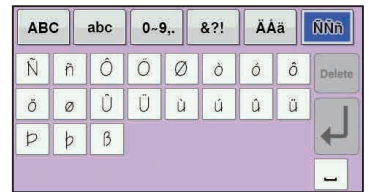
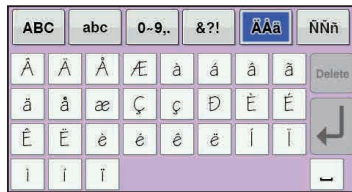
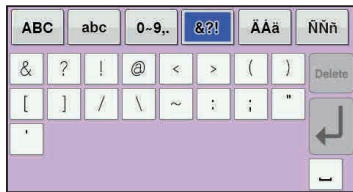
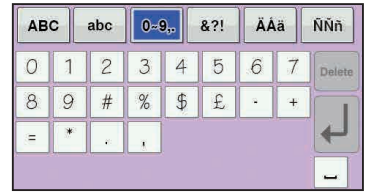
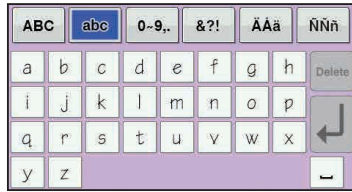
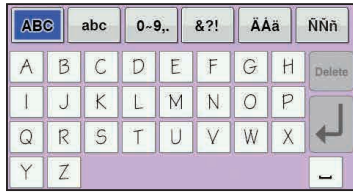

15 ABC

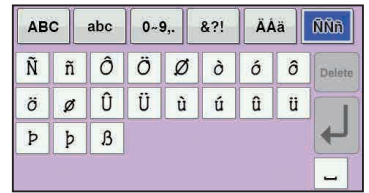
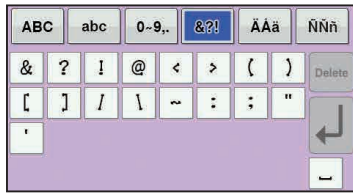
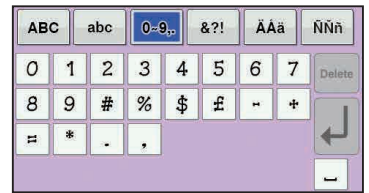
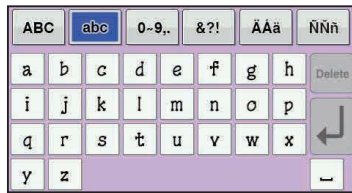
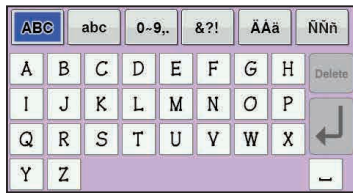

16 ABC

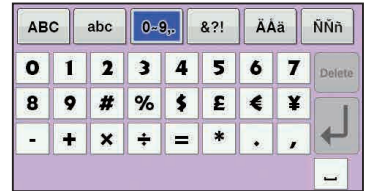
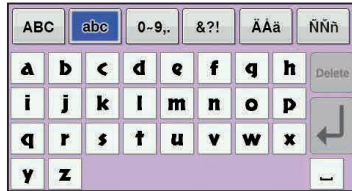
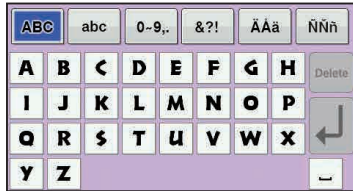

Summary of Embroidery Patterns  
 Oversigt over broderimønstre  
 A hímzsminták összefoglalása  
 Sumarul modelelor de broderie

Översikt över broderimönster  
 Shrnutí vyšivacích vzorů  
 Podsumowanie wzorców haftów

17  
**ABC**

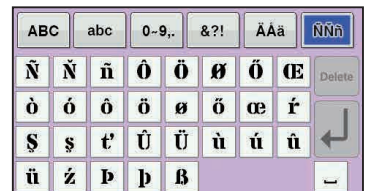
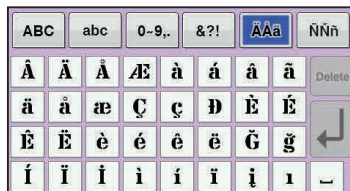
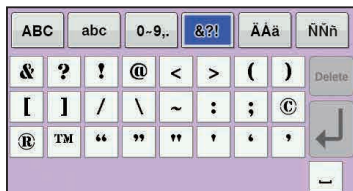
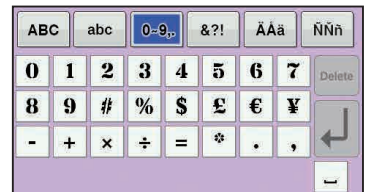
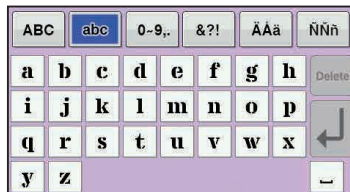
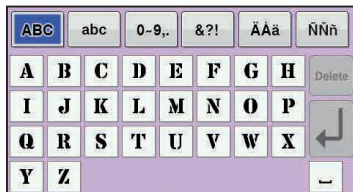
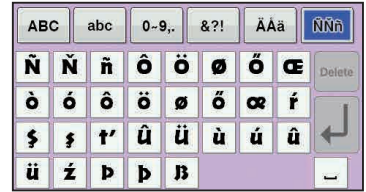
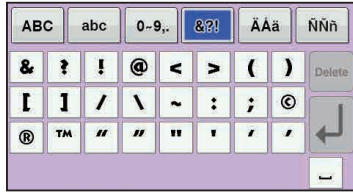

18  
**ABC**

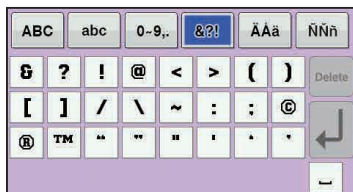
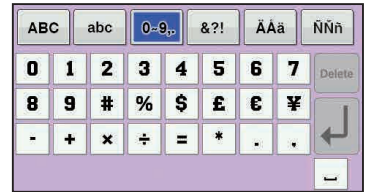
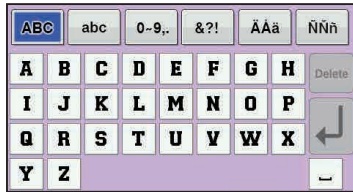

19  
**ABC**

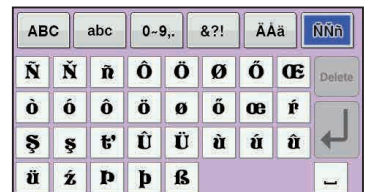
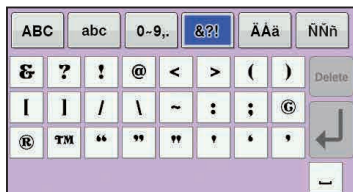
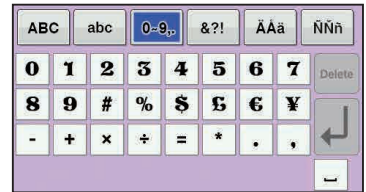
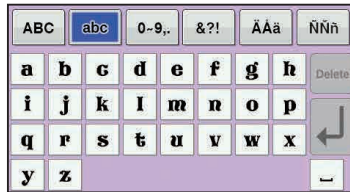
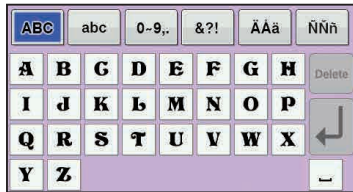

20 ABC

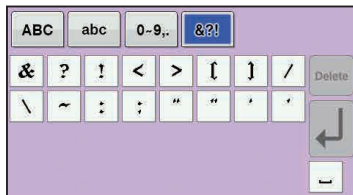
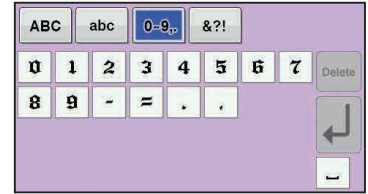
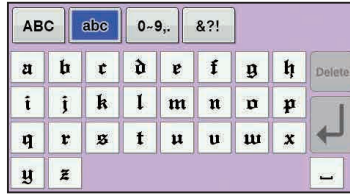
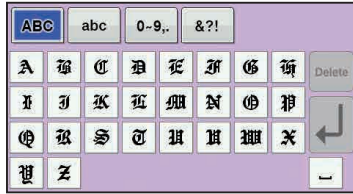

21 ABC

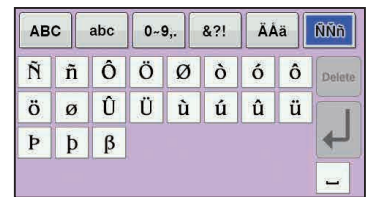
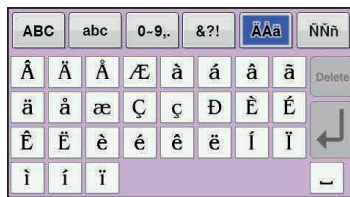
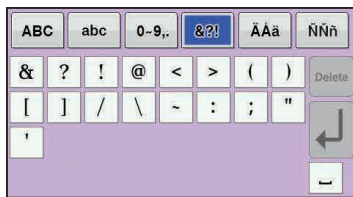
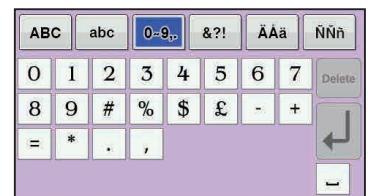
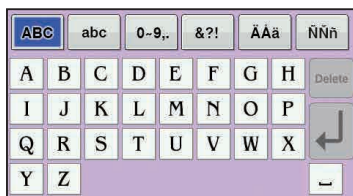

22 ABC

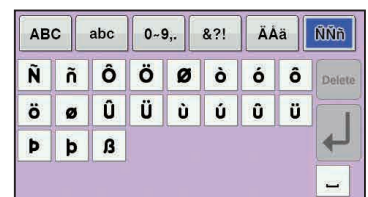
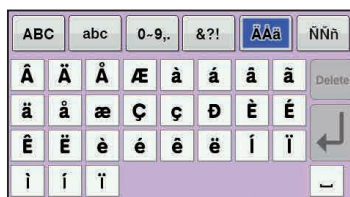
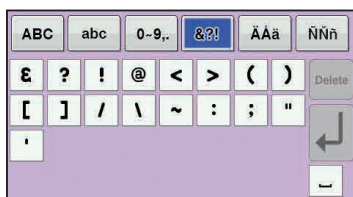
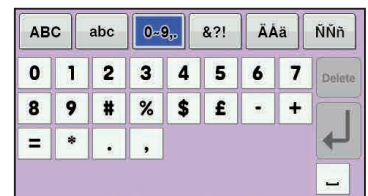
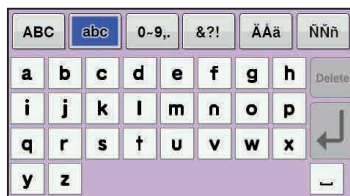
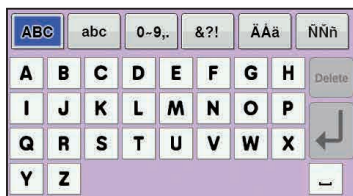

23 ABC

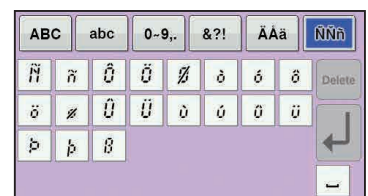
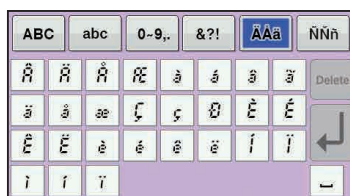
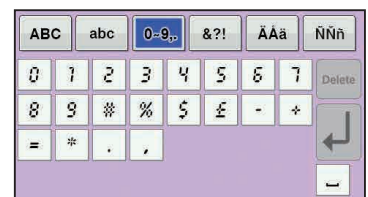

Summary of Embroidery Patterns  
 Oversigt over broderimønstre  
 A hímzsminták összefoglalása  
 Sumarul modelelor de broderie

Översikt över broderimönster  
 Shrnutí vyšivacích vzorů  
 Podsumowanie wzorców haftów

24  
**ABCD**

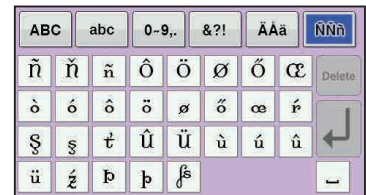
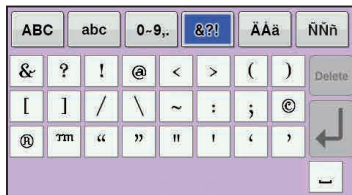
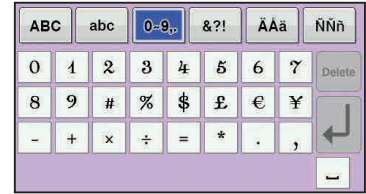
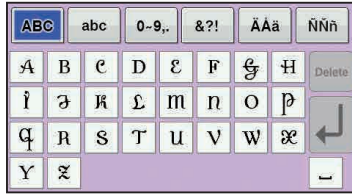

25  
**ABCD**

Small font  
 Liten font  
 Lille skrifttype  
 Malé písmo  
 Kis betűtípus  
 Mała czcionka  
 Font mic

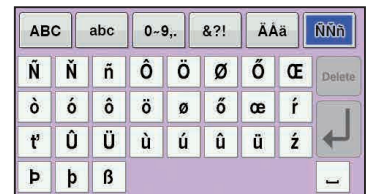
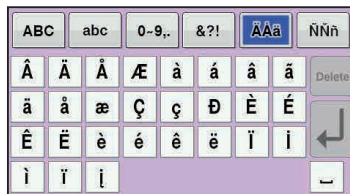
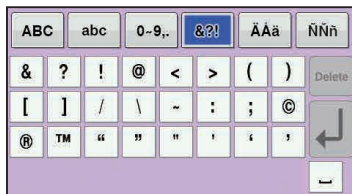
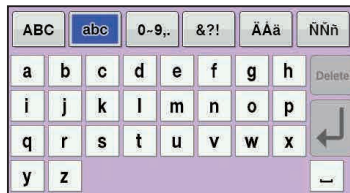
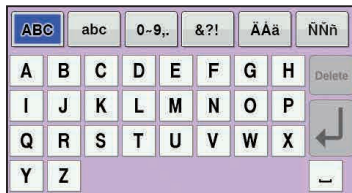

26  
**ABCD**

Small font  
 Liten font  
 Lille skrifttype  
 Malé písmo  
 Kis betűtípus  
 Mała czcionka  
 Font mic

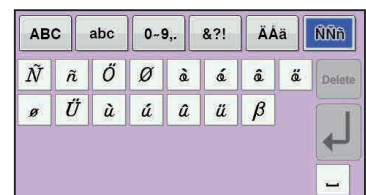
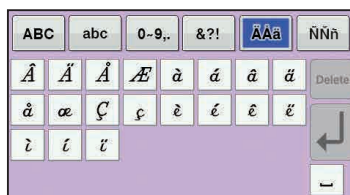
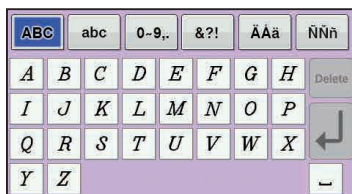

27  
**ABCD**

Small font  
 Liten font  
 Lille skrifttype  
 Malé písmo  
 Kis betűtípus  
 Mała czcionka  
 Font mic

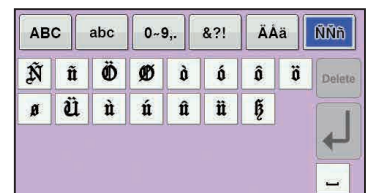
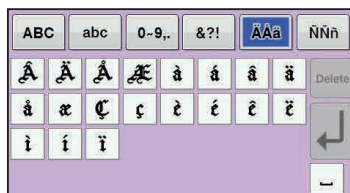
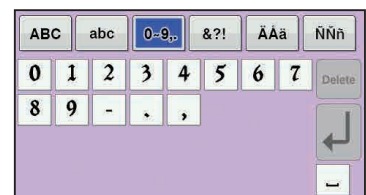
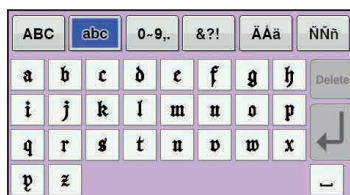
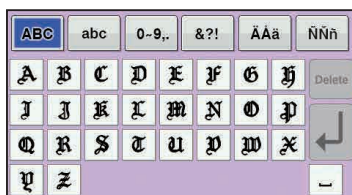

28  

Small font  
 Liten font  
 Lille skrifttype  
 Malé písmo  
 Kis betűtípus  
 Mała czcionka  
 Font mic

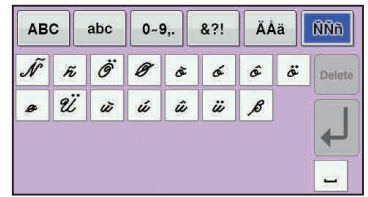
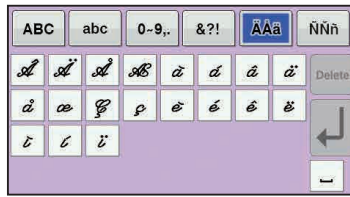
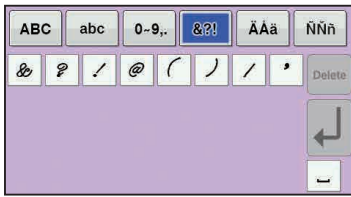
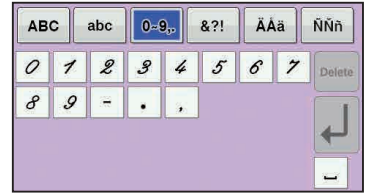
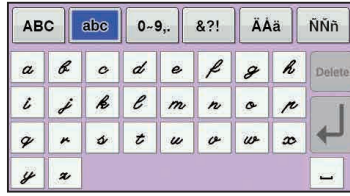
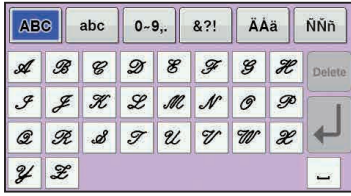

29  

Small font  
 Liten font  
 Lille skrifttype  
 Malé písmo  
 Kis betűtípus  
 Mała czcionka  
 Font mic

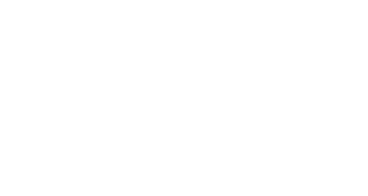
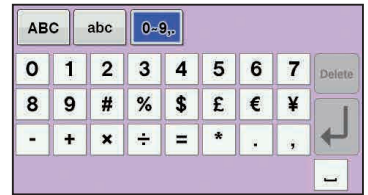
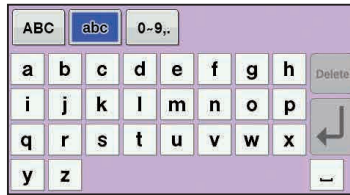
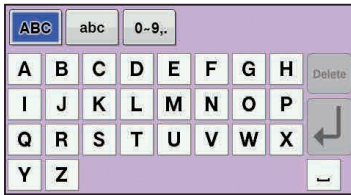

31  

Small font  
 Liten font  
 Lille skrifttype  
 Malé písmo  
 Kis betűtípus  
 Mała czcionka  
 Font mic

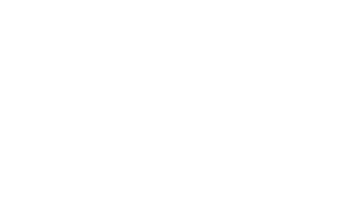

T01  

Small font  
 Liten font  
 Lille skrifttype  
 Malé písmo  
 Kis betűtípus  
 Mała czcionka  
 Font mic

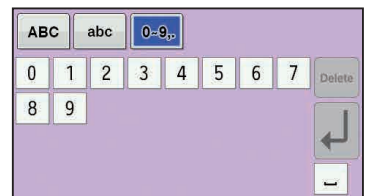
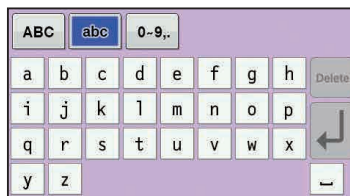
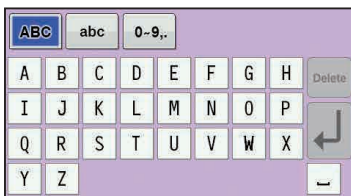

Summary of Embroidery Patterns  
 Oversigt over broderimønstre  
 A hímzsminták összefoglalása  
 Sumarul modelelor de broderie

Översikt över broderimönster  
 Shrnutí vyšivacích vzorů  
 Podsumowanie wzorców haftów

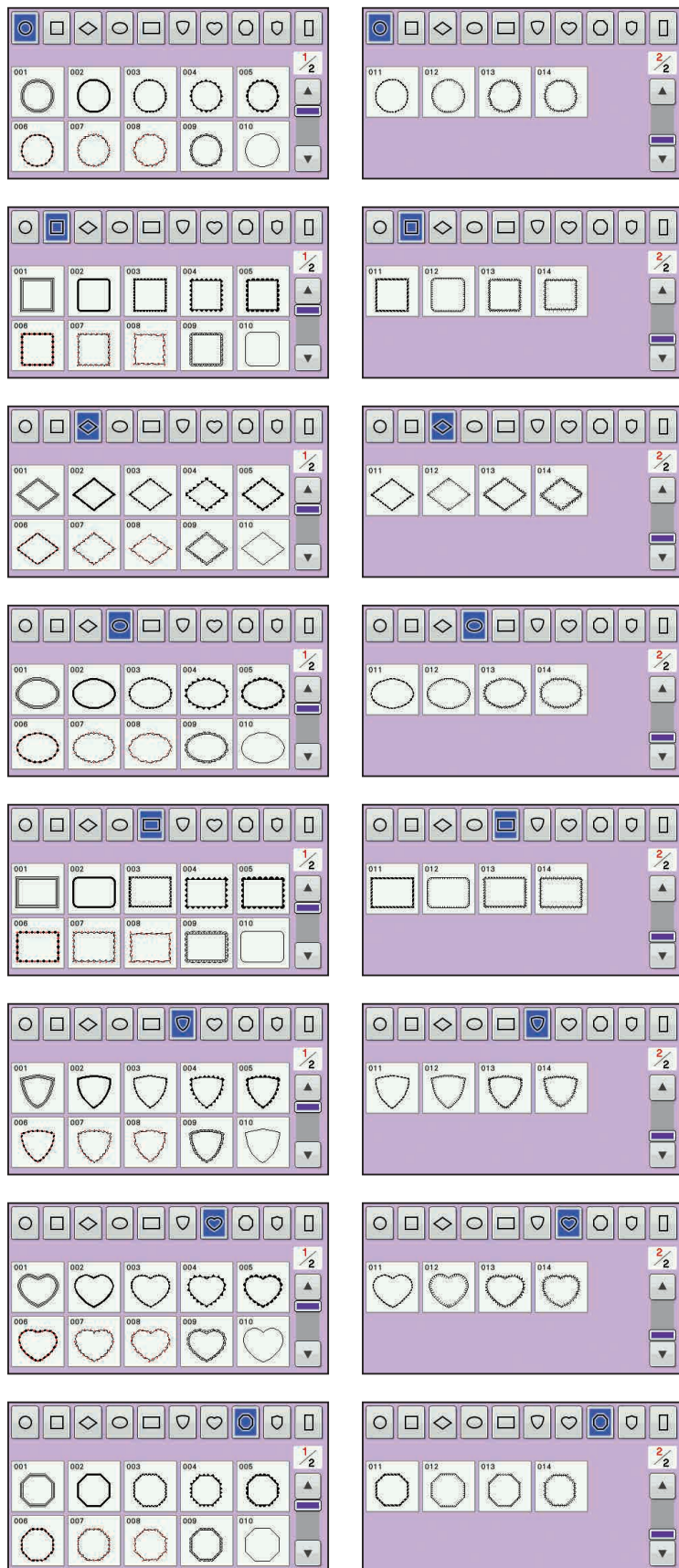

Summary of Embroidery Patterns  
 Oversigt over broderimønstre  
 A hímzsminták összefoglalása  
 Sumarul modelelor de broderie

Översikt över broderimönster  
 Shrutí vyšívacích vzorů  
 Podsumowanie wzorców haftów

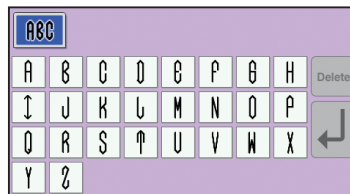
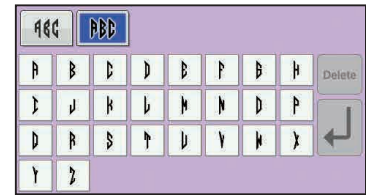
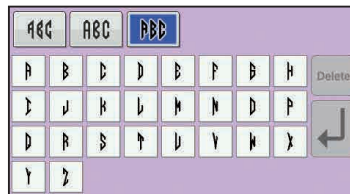
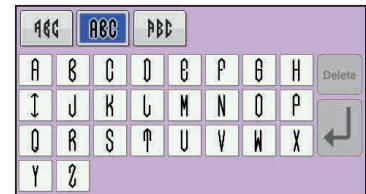
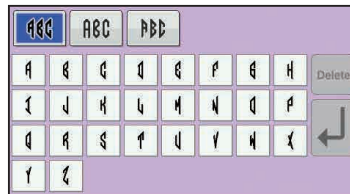
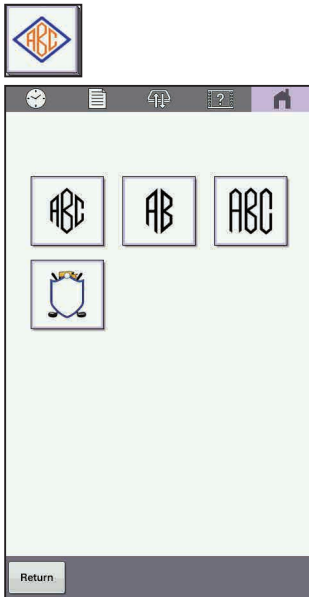
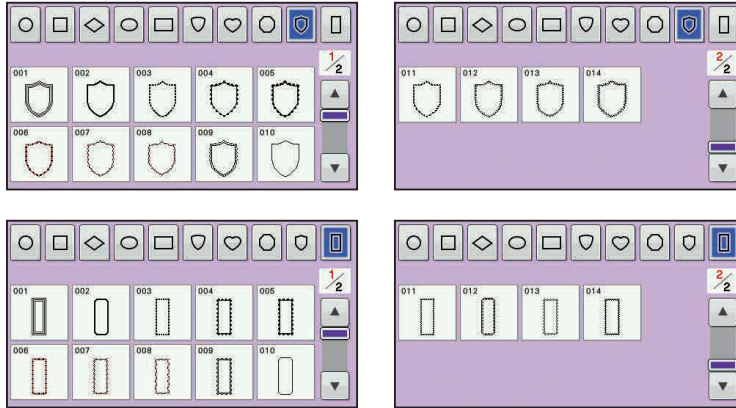



# Embroidery Patterns Color Change Table

## Oversigt over de indbyggede broderimønstre med farver

### A hímzésminták színcsere-táblázata

#### Tabel de modificare a culorilor modelului de broderie

# Broderimønster färgändringstabell

## Tabulka s variantami barev vyšivacích vzorů

### Tabela zmiany kolorów wzorów haftów

Embroidery time and size of each design in this guide may differ from the information on the machine display. Please use for reference purpose only. The color numbers in this guide are for the Embroidery thread brand unless otherwise noted.

● Patterns marked with ● have been rotated. Check your design placement prior to embroidering.

Broderitiden og størrelsen af de enkelte mønstre i denne guide kan variere fra oplysningerne i maskinens display. Disse oplysninger er kun vejledende. Farvenumrene i denne guide gælder broderitrådmærket, medmindre andet er angivet.

● Mønstre markeret med ● er blevet drejet. Kontroller designets placering før brodering.

Az útmutatóban megjelenő hímzési idő és mintaméretnek eltérhetnek a gép kijelzőjén megjelenő információktól. Csak referenciaként használja. Az útmutatóban szereplő színszámok a hímzőfonal- márkára vonatkoznak, ha más jelzés nem található.

● A ● szimbólummal megjelölt minták el vannak forgatva. Hímzés előtt ellenőrizze a minta elhelyezését.

Timpul de coasere și dimensiunea de brodat a fiecărui model din acest ghid pot să difere față de informațiile afișate pe ecranul mașinii. Vă rugăm să folosiți aceste informații numai în scop informativ.

Numerele culorilor din acest ghid sunt pentru marca de fire de broderie dacă nu se specifică altceva.

● Modelele marcate cu ● au fost rotite. Verificați amplasarea modelului înainte de brodat.

Broderitid och storlek på varje design i denna guide kan skilja sig från informationen på maskinens display. Använd endast som referensändamål. Färgnumrering i den här guiden är för märket Trådbroderi om inget annat anges.

● Mönster markerade med ● har roterats. Kontrollera designens placering innan du broderar.

Doba vyšívání a velikost jednotlivých návrhů v tomto průvodci se může lišit od informací na displeji stroje. Používejte pouze pro orientaci. Čísla barev v této příručce platí pro značku vyšivací nitě, pokud není uvedeno jinak.

● Vzory označené puntíkem ● byly otočeny. Před zahájením vyšívání zkontrolujte umístění designu.

Czas wykonania i rozmiar poszczególnych wzorów w niniejszej instrukcji może się różnić od informacji na wyświetlaczu maszyny. Dane te mają charakter jedynie poglądowy.

Numerary kolorów w niniejszej instrukcji zgodnie są z marką nici do haftowania, chyba że podano inaczej.

● Wzory oznaczone symbolem ● zostały obrócone. Przed rozpoczęciem haftowania sprawdź ułożenie projektu.

- ❖ "Featured" design patterns
- ❖ "Udvalgte" designmønstre
- ❖ „Kiemelt” tervezési minták
- ❖ Modele de broderie promovate

- ❖ "Utvalda" designmønstre
- ❖ „Vybrané” vzory návrhů
- ❖ Wzory haftu „Wyróżnione”



**No.1**



Order to embroider  
Ordningsføljd vid brodering  
Rækkefølge for broderi  
Příkaz k vyšívání  
Hímzési sorrend  
Zamów do wyhaftowania  
Ordinea de brodat

<b>21 min</b>	
1	□ (001)
2	■ (900)
↕ 70.4 mm	
↔ 125.9 mm	

Embroidery thread color  
Brodertrådens färg  
Trådfarve for broderi  
Barva vyšivací nitě  
Hímzőcérna színe  
Kolor nici haftu  
Culoarea firului folosit la brodat

Time required for embroidering  
Tidsåtgång för broderiet  
Tidsforbrug for broderi  
Požadovaný čas pro vyšívání  
Hímzéshez szükséges idő  
Czas wymagany do wykonania haftu  
Durata necesară pentru efectuarea broderiei

Embroidery thread color number  
Brodertrådens färgnummer  
Trådfarvenummer for broderi  
Číslo barvy vyšivací nitě  
Hímzőcérna színkódja  
Numer koloru nici haftu  
Numărul culorii firului folosit la brodat

Embroidery size  
Broderiets storlek  
Broderistørrelse  
Velikost vyšivky  
Hímzésméret  
Rozmiar haftu  
Dimensiunea broderiei

**No.2**



<b>17 min</b>	
1	■ (208)
2	■ (900)
↕ 107.8 mm	
↔ 87.0 mm	



● No.3

95 min	
1	(399)
2	(001)
3	(214)
4	(900)
5	(214)
↓ 193.4 mm	
↔ 238.5 mm	

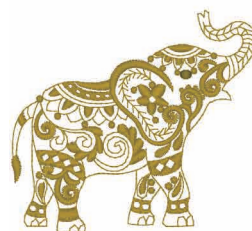

No.6

7 min	
1	(328)
2	(330)
↓ 85.5 mm	
↔ 94.8 mm	



No.7

14 min	
1	(900)
↓ 84.8 mm	
↔ 131.1 mm	



● No.4

108 min	
1	(704)
2	(005)
3	(900)
4	(704)
5	(005)
6	(900)
7	(005)
8	(704)
9	(005)
10	(704)
11	(005)
12	(900)
13	(005)
↓ 195.0 mm	
↔ 264.5 mm	



No.8

31 min	
1	(085)
↓ 152.0 mm	
↔ 185.1 mm	



● No.5

15 min	
1	(613)
2	(086)
3	(070)
4	(613)
5	(070)
6	(534)
↓ 162.0 mm	
↔ 255.3 mm	



● No.9

113 min			
1	(307)	17	(507)
2	(900)	18	(085)
3	(307)	19	(807)
4	(807)	20	(085)
5	(513)	21	(807)
6	(507)	22	(085)
7	(513)	23	(307)
8	(507)	24	(807)
9	(513)	25	(513)
10	(507)	26	(507)
11	(807)	27	(807)
12	(513)	28	(507)
13	(507)	29	(513)
14	(513)	30	(085)
15	(507)	31	(807)
16	(513)	32	(085)
↓ 183.2 mm ↔ 277.5 mm			



**No.1** **7 min**

**BoHo**

1	(800)
2	(348)
↓	50.0 mm
↔	91.9 mm

**No.2** **10 min**

**GROOVY**

1	(513)
2	(085)
3	(348)
4	(620)
↓	43.3 mm
↔	148.2 mm

**No.3** **15 min**

**GOOD VIBES**

1	(534)
2	(030)
3	(208)
↓	98.8 mm
↔	109.7 mm

**No.4** **30 min**

1	(542)
2	(085)
3	(812)
4	(620)
5	(030)
↓	194.6 mm
↔	276.9 mm

**No.5** **6 min**

1	(542)
2	(812)
3	(030)
↓	147.2 mm
↔	44.2 mm

- ✂ Embroidery patterns
- ✂ Broderimønstre
- ✂ Hímzéminták
- ✂ Modele de broderie

- ✂ Broderimönster
- ✂ Vzory vyšívání
- ✂ Wzory haftu



**No.1** **4 min**

1	(107)
2	(007)
3	(005)
4	(007)
5	(107)
↓	40.1 mm
↔	41.3 mm

**No.3** **1 min**

1	(612)
2	(515)
3	(534)
4	(620)
↓	28.2 mm
↔	27.4 mm

**No.5** **2 min**

1	(509)
2	(515)
↓	26.3 mm
↔	26.6 mm

**No.2** **2 min**

1	(812)
2	(205)
↓	32.1 mm
↔	30.2 mm

**No.4** **1 min**



1	(079)
2	(001)
3	(058)
↓	19.1 mm
↔	29.3 mm

**No.6** **1 min**

1	(399)
2	(348)
↓	31.2 mm
↔	21.1 mm

**No.7**

**1 min**

1  (328)  
 2  (214)  
 ↓ 37.6 mm  
 ⇔ 15.3 mm



**No.12**







**7 min**

1  (005)  
 ↓ 68.2 mm  
 ⇔ 53.8 mm



**No.17**

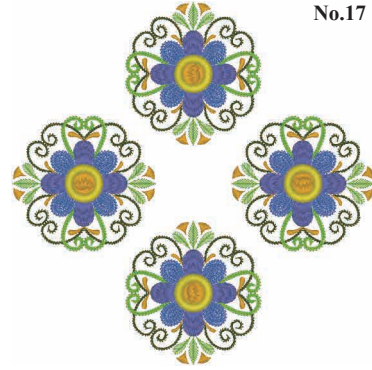

**39 min**

1  (517)  
 2  (214)  
 3  (513)  
 4  (070)  
 5  (607)  
 6  (214)  
 7  (206)  
 ↓ 192.5 mm  
 ⇔ 192.5 mm



**No.8**

**1 min**

1  (001)  
 2  (509)  
 3  (058)  
 ↓ 29.9 mm  
 ⇔ 23.8 mm



**No.13**



**2 min**

1  (214)  
 ↓ 39.3 mm  
 ⇔ 38.4 mm



**No.9**

**1 min**

1  (900)  
 2  (800)  
 3  (900)  
 ↓ 15.0 mm  
 ⇔ 16.1 mm



**No.14**















**6 min**

1  (214)  
 ↓ 68.5 mm  
 ⇔ 69.5 mm



**No.18**





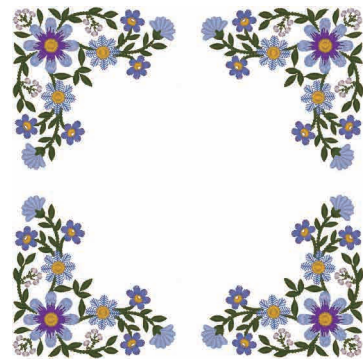



**36 min**

1  (399)  
 2  (517)  
 3  (607)  
 4  (070)  
 5  (804)  
 6  (613)  
 7  (214)  
 8  (399)  
 9  (517)  
 10  (607)  
 11  (070)  
 12  (804)  
 13  (613)  
 14  (214)  
 ↓ 185.9 mm  
 ⇔ 185.9 mm



**No.10**





**2 min**

1  (348)  
 2  (001)  
 3  (517)  
 4  (515)  
 5  (323)  
 6  (058)  
 7  (214)  
 8  (208)  
 ↓ 30.8 mm  
 ⇔ 27.6 mm



**No.15**







**4 min**

1  (348)  
 2  (399)  
 3  (085)  
 4  (124)  
 ↓ 41.4 mm  
 ⇔ 49.3 mm



**No.19**

**29 min**

1  (513)  
 2  (085)  
 3  (807)  
 4  (507)  
 5  (209)  
 6  (206)  
 7  (807)  
 ↓ 177.3 mm  
 ⇔ 177.4 mm

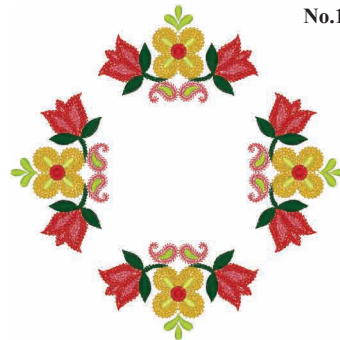

**No.11**





**2 min**

1  (001)  
 2  (515)  
 3  (800)  
 4  (214)  
 5  (001)  
 ↓ 31.0 mm  
 ⇔ 30.9 mm



**No.16**

**13 min**

1  (348)  
 2  (124)  
 3  (085)  
 4  (399)  
 ↓ 88.1 mm  
 ⇔ 157.9 mm



**Embroidery Patterns Color Change Table**  
**Översigt över de indbyggde broderimönstre med färver**  
**A hímzésminták színcsere-táblázata**  
**Tabel de modificare a culorilor modelului de broderie**

**Broderimönster färgändringstabell**  
**Tabulka s variantami barev vyšivacích vzorů**  
**Tabela zmiany kolorów wzorów haftów**



**No.20** **41 min**

1	(613)
2	(001)
3	(086)
4	(542)
5	(613)
6	(001)
7	(086)
8	(542)
9	(613)
10	(001)
11	(086)
12	(542)
13	(613)
14	(001)
15	(086)
16	(542)

↓ 194.0 mm  
 ⇔ 194.0 mm

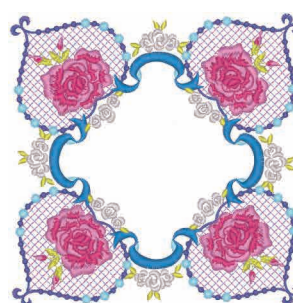

**No.23** **37 min**

1	(804)
2	(810)
3	(607)
4	(017)
5	(019)
6	(085)
7	(086)
8	(027)
9	(124)

↓ 156.0 mm  
 ⇔ 155.1 mm

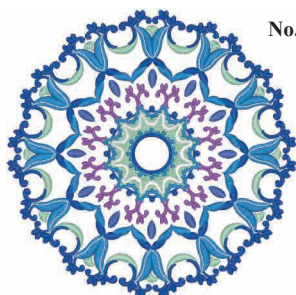

**No.21** **36 min**

1	(612)	7	(542)
2	(405)	8	(405)
3	(542)	9	(019)
4	(001)	10	(001)
5	(019)	11	(070)
6	(405)		

↓ 153.0 mm ⇔ 153.5 mm



**No.24** **23 min**

1	(107)
2	(086)

↓ 148.2 mm  
 ⇔ 195.4 mm



**No.22**



**No.25** **22 min**

1	(405)
2	(420)

↓ 148.2 mm  
 ⇔ 195.4 mm

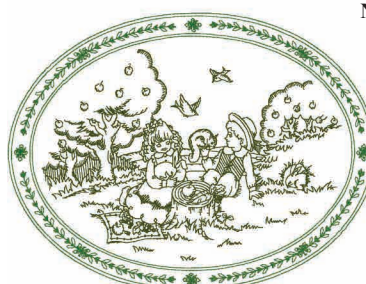

**No.26** **22 min**

1	(517)
2	(515)

↓ 148.2 mm  
 ⇔ 195.4 mm

**51 min**

1	(515)	15	(019)	29	(010)	43	(208)	57	(513)
2	(027)	16	(208)	30	(323)	44	(843)	58	(534)
3	(513)	17	(843)	31	(513)	45	(010)	59	(707)
4	(058)	18	(010)	32	(534)	46	(810)	60	(208)
5	(208)	19	(810)	33	(019)	47	(010)	61	(513)
6	(070)	20	(010)	34	(208)	48	(323)	62	(515)
7	(019)	21	(323)	35	(843)	49	(070)	63	(027)
8	(209)	22	(513)	36	(010)	50	(208)	64	(513)
9	(208)	23	(534)	37	(810)	51	(001)	65	(058)
10	(800)	24	(019)	38	(010)	52	(058)	66	(208)
11	(405)	25	(208)	39	(323)	53	(010)	67	(070)
12	(058)	26	(843)	40	(513)	54	(070)	68	(019)
13	(513)	27	(010)	41	(534)	55	(058)		
14	(534)	28	(810)	42	(019)	56	(620)		

↓ 195.8 mm ⇔ 195.8 mm



**No.27** **22 min**

1	(007)
2	(405)

↓ 148.2 mm  
 ⇔ 195.4 mm

**No.28**



**56 min**

1	(208)	12	(307)
2	(323)	13	(126)
3	(126)	14	(333)
4	(058)	15	(208)
5	(800)	16	(126)
6	(107)	17	(001)
7	(058)	18	(800)
8	(001)	19	(058)
9	(126)	20	(107)
10	(399)	21	(399)
11	(107)	22	(058)

↓ 194.3 mm ↔ 145.2 mm

**No.31**



**10 min**

1	(399)
2	(001)

↓ 85.5 mm  
↔ 56.0 mm

**No.32**



**4 min**

1	(328)
---	-------

↓ 74.1 mm  
↔ 54.1 mm

**No.29**



**42 min**

1	(208)
2	(900)
3	(620)
4	(339)
5	(900)

↓ 182.7 mm  
↔ 194.7 mm

**No.33**



**3 min**

1	(328)
2	(348)

↓ 42.4 mm  
↔ 40.1 mm

**No.30**



**51 min**

1	(420)
2	(515)
3	(206)
4	(420)
5	(007)
6	(800)
7	(515)
8	(206)
9	(007)
10	(005)
11	(420)
12	(800)

↓ 192.2 mm  
↔ 184.1 mm

**No.34**



**11 min**

1	(209)	6	(339)
2	(206)	7	(323)
3	(209)	8	(001)
4	(900)	9	(843)
5	(206)	10	(900)

↓ 55.2 mm ↔ 118.9 mm

**Embroidery Patterns Color Change Table**  
**Oversigt over de indbyggede broderimønstre med farver**  
**A hímzésminták színcsere-táblázata**  
**Tabel de modificare a culorilor modelului de broderie**

**Broderimönster färgändringstabell**  
**Tabulka s variantami barev vyšivacích vzorů**  
**Tabela zmiany kolorów wzorów haftów**

- ❖ **Decoration/Hallmark patterns**
- ❖ **Dekorations-/stempelmønstre**
- ❖ **Díszítés-/címerminták**
- ❖ **Decorative/Modele Hallmark**

- ❖ **Utformningar på dekoration/ornament**
- ❖ **Vzory dekorací/znaků**
- ❖ **Wzorce dekoracji/oznaczeń**



**No.1** **12 min**

1	■ (707)
2	■ (817)
3	■ (707)

↓ 195.6 mm  
↔ 160.0 mm

**No.7** **1 min**

1	■ (900)
---	---------

↓ 18.9 mm  
↔ 62.7 mm

**No.15** **2 min**

1	■ (900)
---	---------

↓ 8.1 mm  
↔ 182.8 mm

**No.8** **6 min**

1	■ (900)
---	---------

↓ 62.4 mm  
↔ 123.6 mm

**No.9** **1 min**

1	■ (900)
---	---------

↓ 23.8 mm  
↔ 58.5 mm

**No.16** **19 min**

1	■ (399)
2	■ (804)

↓ 186.8 mm  
↔ 160.1 mm

**No.2** **4 min**

1	■ (817)
2	■ (707)

↓ 81.8 mm  
↔ 111.8 mm

**No.10** **1 min**

1	■ (900)
---	---------

↓ 40.6 mm  
↔ 74.9 mm

**No.3** **3 min**

1	■ (707)
2	■ (817)

↓ 39.4 mm  
↔ 136.7 mm

**No.11** **1 min**

1	■ (900)
---	---------

↓ 15.2 mm  
↔ 62.9 mm

**No.17** **12 min**

1	■ (399)
2	■ (804)

↓ 84.6 mm  
↔ 143.0 mm

**No.4** **2 min**

1	■ (900)
---	---------

↓ 25.0 mm  
↔ 69.8 mm

**No.12** **3 min**

1	■ (900)
---	---------

↓ 37.8 mm  
↔ 125.4 mm

**No.5** **2 min**

1	■ (900)
---	---------

↓ 40.5 mm  
↔ 90.3 mm

**No.13** **3 min**

1	■ (900)
---	---------

↓ 24.7 mm  
↔ 129.1 mm

**No.18** **10 min**

1	■ (399)
2	■ (804)

↓ 48.4 mm  
↔ 188.5 mm

**No.6** **1 min**

1	■ (900)
---	---------

↓ 24.4 mm  
↔ 95.7 mm

**No.14** **3 min**

1	■ (900)
---	---------

↓ 32.5 mm  
↔ 75.0 mm



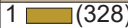

No.19

<b>19 min</b>	
1	 (328)
↓	173.7 mm
↔	194.4 mm



No.24

<b>2 min</b>	
1	 (328)
↓	47.9 mm
↔	51.4 mm



No.25

<b>1 min</b>	
1	 (869)
↓	26.0 mm
↔	57.0 mm



No.20

<b>14 min</b>	
1	 (328)
↓	137.6 mm
↔	147.2 mm



No.26

<b>2 min</b>	
1	 (007)
↓	16.8 mm
↔	92.6 mm



No.21

<b>25 min</b>	
1	 (704)
↓	154.3 mm
↔	186.5 mm







No.27

<b>1 min</b>	
1	 (005)
↓	20.7 mm
↔	33.7 mm



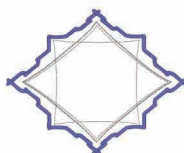

No.22

<b>7 min</b>	
1	 (900)
2	 (085)
3	 (086)
4	 (807)
↓	47.9 mm
↔	161.3 mm



No.23

<b>4 min</b>	
1	 (005)
2	 (817)
3	 (607)
↓	77.3 mm
↔	95.1 mm



- ❖ Quilt patterns
- ❖ Quiltemønstre
- ❖ Steppelőminták
- ❖ Modele matlasate

- ❖ Quiltningmønster
- ❖ Vzory prošívání
- ❖ Wzorce pikowane

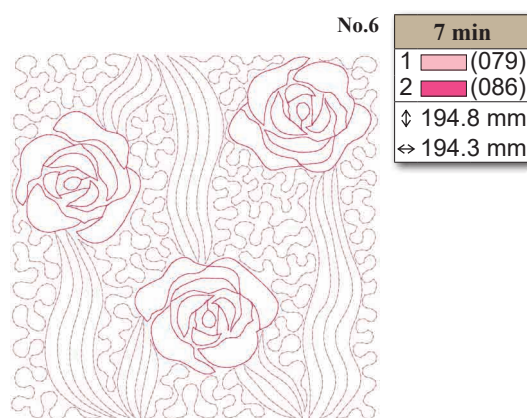
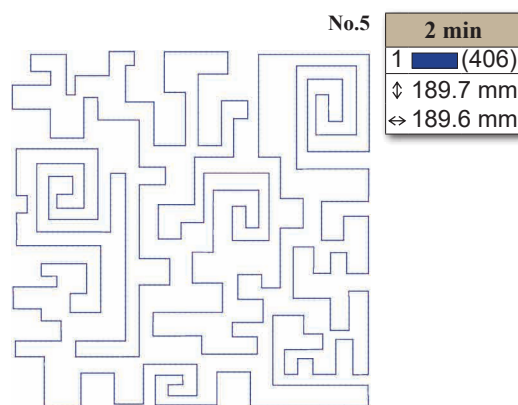
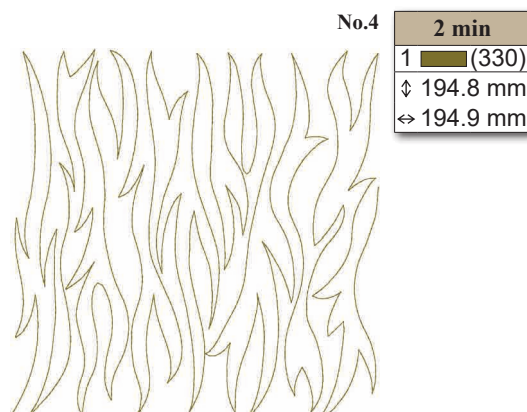
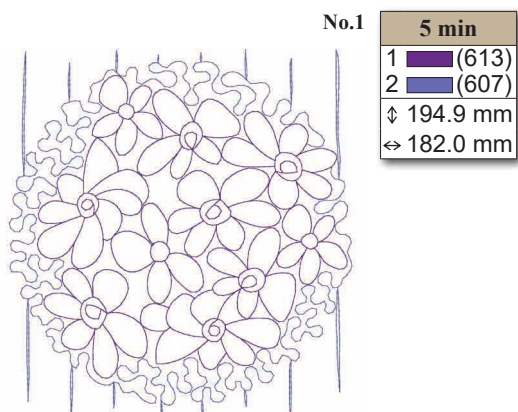

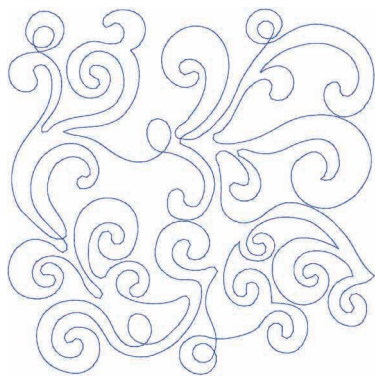

No.7

<b>2 min</b>	
1	■ (420)
↓	194.3 mm
↔	194.6 mm

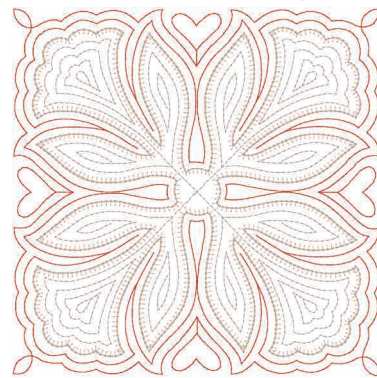

No.11

<b>11 min</b>	
1	---× (800)
2	---× (800)
3	---× (800)
4	■ (399)
5	■ (800)
↓	195.0 mm
↔	195.1 mm

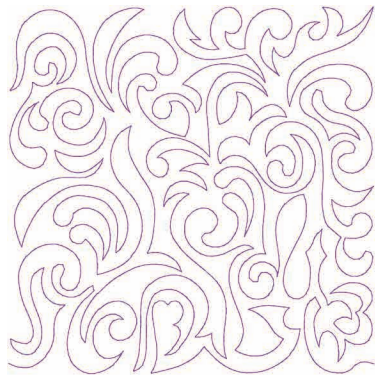

No.8

<b>3 min</b>	
1	■ (620)
↓	194.8 mm
↔	195.0 mm

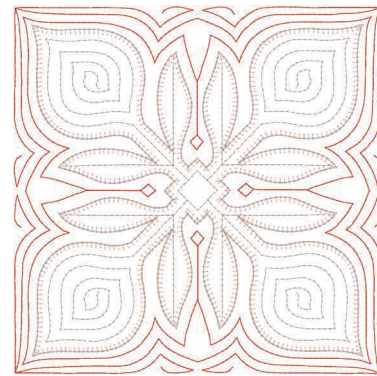

No.12

<b>10 min</b>	
1	---× (800)
2	---× (800)
3	---× (800)
4	■ (399)
5	■ (800)
↓	195.0 mm
↔	195.0 mm

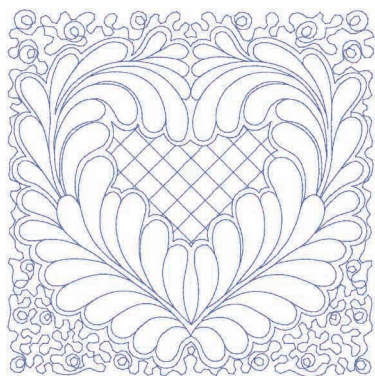

No.9

<b>6 min</b>	
1	■ (070)
↓	195.2 mm
↔	194.5 mm



No.13

<b>1 min</b>	
1	■ (005)
↓	60.5 mm
↔	147.9 mm

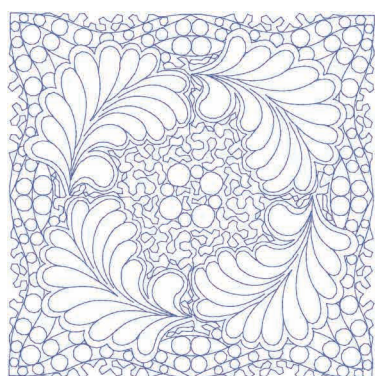

No.10

<b>8 min</b>	
1	■ (070)
↓	194.8 mm
↔	194.9 mm



No.14

<b>1 min</b>	
1	■ (328)
↓	73.8 mm
↔	155.8 mm



No.15

<b>1 min</b>	
1	■ (800)
↓	27.4 mm
↔	110.7 mm



No.16

<b>1 min</b>	
1	■ (817)
↓	63.1 mm
↔	149.9 mm

**Embroidery Patterns Color Change Table**  
**Oversigt over de indbyggede broderimønstre med farver**  
**A hímzésminták színcsere-táblázata**  
**Tabel de modificare a culorilor modelului de broderie**

**Broderimønster färgändringstabelle**  
**Tabulka s variantami barev vyšivacích vzorů**  
**Tabela zmiany kolorów wzorów haftów**

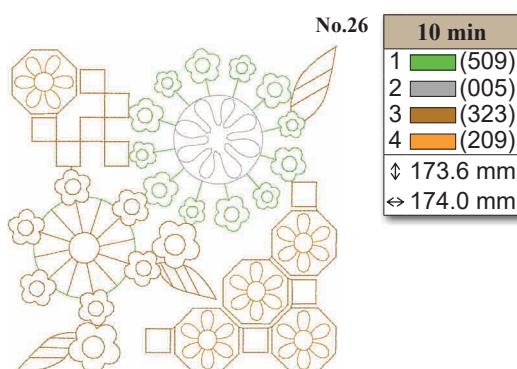
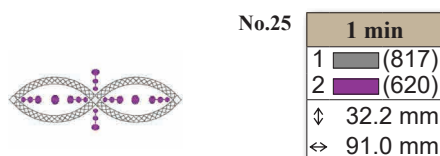
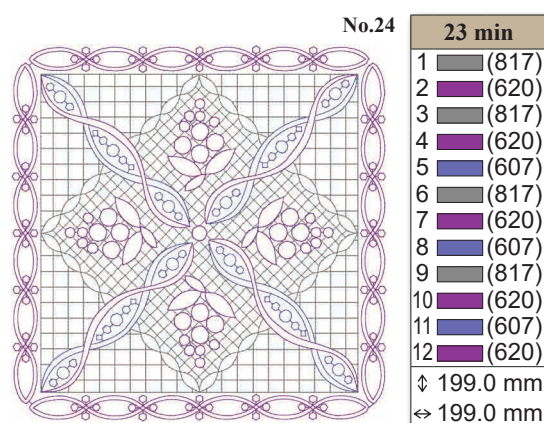
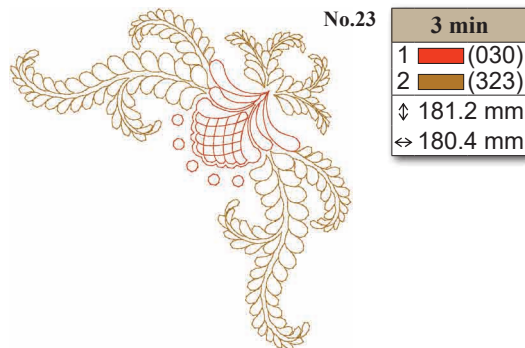
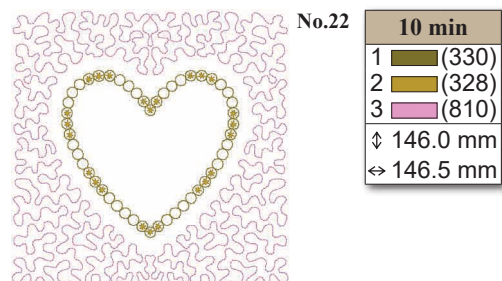
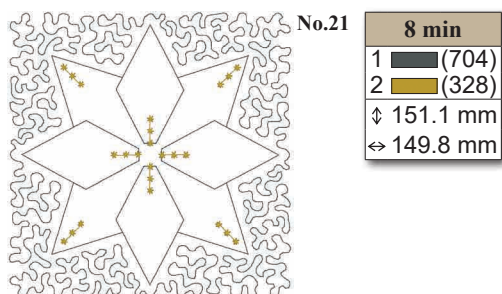
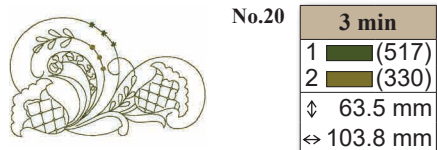
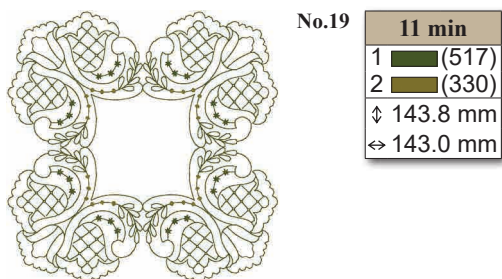
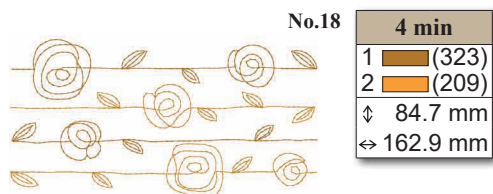
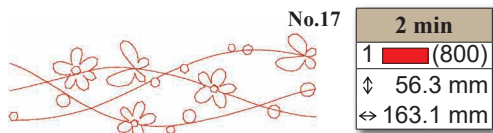

- ♥ Refer to the operation manual for the embroidery machine for details on how to embroider appliqués.
- ♥ Information om hur du broderar applikationer finns i brodermaskinens bruksanvisning.
- ♥ Se i brugsanvisningen til brodermaskinen for at få oplysninger om, hvordan man broderer applikationer.
- ♥ Podrobnosti o vyšívání aplikací najdete v uživatelské příručce vyšivacího stroje.
- ♥ A rátétes hímzéssel kapcsolatos részletekért tekintse meg a hímzőgép használati útmutatóját.
- ♥ Szczegółowe informacje na temat haftowania aplikacji można znaleźć w instrukcji obsługi hafciarki.
- ♥ Consultați manualul de utilizare al mașinii de brodat pentru detalii despre brodarea aplicațiilor.



**No.27**

<b>2 min</b>	
1	■ (323)
2	■ (509)
↓	180.9 mm
↔	45.3 mm

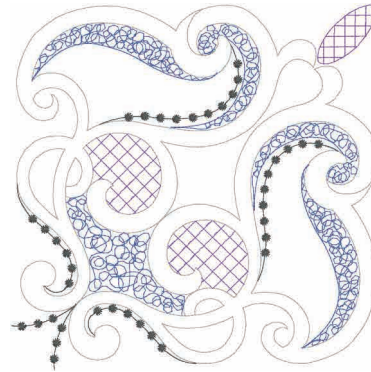

**No.32**

<b>12 min</b>	
1	■ (005)
2	■ (070)
3	■ (704)
4	■ (612)
↓	194.2 mm
↔	194.2 mm

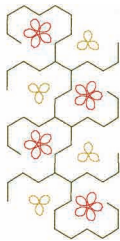

**No.28**

<b>3 min</b>	
1	■ (517)
2	■ (208)
3	■ (800)
↓	123.9 mm
↔	59.4 mm

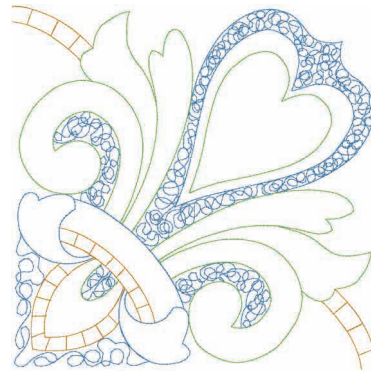

**No.33**

<b>13 min</b>	
1	■ (019)
2	■ (509)
3	■ (209)
4	■ (019)
5	■ (509)
↓	193.2 mm
↔	193.6 mm



**No.29**

<b>3 min</b>	
1	■ (214)
2	■ (330)
↓	95.3 mm
↔	83.5 mm

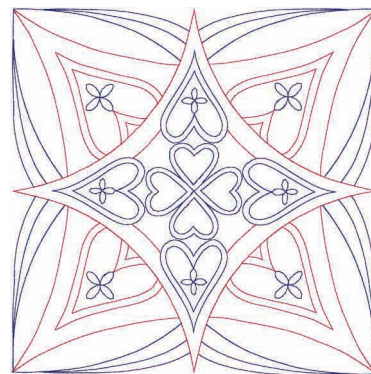

**No.34**

<b>7 min</b>	
1	■ (107)
2	■ (007)
3	■ (107)
↓	194.4 mm
↔	193.6 mm



**No.30**

<b>2 min</b>	
1	■ (330)
↓	44.2 mm
↔	162.8 mm



**No.31**

<b>11 min</b>	
1	■ (107)
2	■ (005)
3	■ (415)
4	■ (214)
↓	188.7 mm
↔	191.2 mm

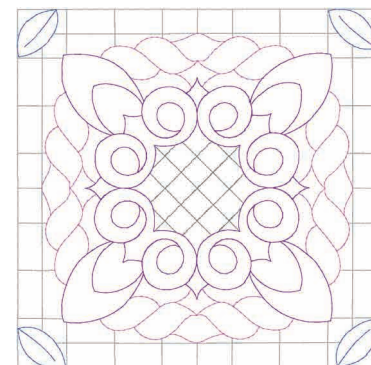

**No.35**

<b>13 min</b>	
1	■ (817)
2	■ (005)
3	■ (810)
4	■ (620)
5	■ (070)
↓	191.2 mm
↔	191.2 mm

Embroidery Patterns Color Change Table  
 Oversigt over de indbyggede broderimønstre med farver  
 A hímzésminták színcsere-táblázata  
 Tabel de modificare a culorilor modelului de broderie

Broderimönster färgändringstabell  
 Tabulka s variantami barev vyšivacích vzorů  
 Tabela zmiany kolorów wzorów haftów

- ✂ Alphabet
- ✂ Alfabet
- ✂ Alfabet
- ✂ Ábécé
- ✂ Alfabet
- ✂ Alfabet
- ✂ Abeceda
- ✂ Alfabet



**No.1** **9 min**



1	■ (030)
2	■ (900)
3	□ (001)
↓	68.3 mm
↔	60.2 mm

**No.7** **9 min**



1	■ (019)
2	■ (900)
3	□ (001)
↓	62.5 mm
↔	54.3 mm

**No.13** **11 min**



1	■ (612)
2	■ (900)
3	□ (001)
↓	63.5 mm
↔	68.4 mm

**No.2** **9 min**



1	■ (030)
2	■ (900)
3	□ (001)
↓	64.7 mm
↔	57.1 mm

**No.8** **8 min**



1	■ (019)
2	■ (900)
3	□ (001)
↓	64.6 mm
↔	55.9 mm

**No.14** **11 min**



1	■ (612)
2	■ (900)
3	□ (001)
↓	68.7 mm
↔	63.2 mm

**No.3** **10 min**



1	■ (030)
2	■ (900)
3	□ (001)
↓	61.3 mm
↔	55.0 mm

**No.9** **7 min**



1	■ (019)
2	■ (900)
3	□ (001)
↓	75.7 mm
↔	41.8 mm

**No.15** **7 min**



1	■ (612)
2	■ (900)
3	□ (001)
↓	69.1 mm
↔	44.5 mm

**No.4** **8 min**



1	■ (030)
2	■ (900)
3	□ (001)
↓	64.3 mm
↔	60.3 mm

**No.10** **7 min**



1	■ (019)
2	■ (900)
3	□ (001)
↓	66.2 mm
↔	48.3 mm

**No.16** **8 min**



1	■ (612)
2	■ (900)
3	□ (001)
↓	64.0 mm
↔	57.6 mm

**No.5** **9 min**



1	■ (030)
2	■ (900)
3	□ (001)
↓	68.4 mm
↔	55.1 mm

**No.11** **12 min**



1	■ (019)
2	■ (900)
3	□ (001)
↓	72.8 mm
↔	72.5 mm

**No.17** **9 min**



1	■ (509)
2	■ (900)
3	□ (001)
↓	63.7 mm
↔	53.8 mm

**No.6** **7 min**



1	■ (019)
2	■ (900)
3	□ (001)
↓	67.8 mm
↔	47.9 mm

**No.12** **7 min**



1	■ (612)
2	■ (900)
3	□ (001)
↓	71.0 mm
↔	47.8 mm

**No.18** **10 min**



1	■ (509)
2	■ (900)
3	□ (001)
↓	64.6 mm
↔	58.1 mm

**No.19** **8 min**



1	█ (509)
2	█ (900)
3	□ (001)
↓	64.6 mm
↔	50.2 mm

**No.22** **9 min**



1	█ (509)
2	█ (900)
3	□ (001)
↓	71.1 mm
↔	60.7 mm

**No.25** **9 min**



1	█ (817)
2	█ (900)
3	□ (001)
↓	67.9 mm
↔	50.7 mm

**No.20** **7 min**



1	█ (509)
2	█ (900)
3	□ (001)
↓	62.9 mm
↔	52.5 mm

**No.23** **12 min**



1	█ (817)
2	█ (900)
3	□ (001)
↓	66.9 mm
↔	74.9 mm

**No.26** **10 min**



1	█ (817)
2	█ (900)
3	□ (001)
↓	67.8 mm
↔	63.8 mm

**No.21** **9 min**



1	█ (509)
2	█ (900)
3	□ (001)
↓	64.8 mm
↔	50.1 mm

**No.24** **10 min**



1	█ (817)
2	█ (900)
3	□ (001)
↓	74.9 mm
↔	67.9 mm



**No.1** **9 min**



1	█ (399)
2	█ (019)
3	█ (900)
4	□ (001)
↓	71.5 mm
↔	55.1 mm

**No.5** **7 min**



1	█ (405)
2	█ (900)
3	□ (001)
↓	73.8 mm
↔	54.8 mm

**No.9** **7 min**



1	█ (019)
2	█ (900)
3	□ (001)
↓	74.6 mm
↔	43.9 mm

**No.2** **6 min**



1	█ (208)
2	█ (900)
3	□ (001)
↓	72.5 mm
↔	40.8 mm

**No.6** **8 min**



1	█ (612)
2	█ (900)
3	□ (001)
↓	70.8 mm
↔	52.3 mm

**No.10** **6 min**



1	█ (800)
2	█ (900)
3	□ (001)
↓	72.7 mm
↔	47.6 mm

**No.3** **7 min**



1	█ (509)
2	█ (900)
3	□ (001)
↓	70.6 mm
↔	52.4 mm

**No.7** **7 min**



1	█ (126)
2	█ (900)
3	□ (001)
↓	72.2 mm
↔	56.4 mm

**No.4** **8 min**



1	█ (005)
2	█ (900)
3	□ (001)
↓	67.7 mm
↔	51.4 mm

**No.8** **6 min**



1	█ (205)
2	█ (900)
3	□ (001)
↓	69.5 mm
↔	58.4 mm

Embroidery Patterns Color Change Table  
 Oversigt over de indbyggede broderimønstre med farver  
 A hímzésminták színcsere-táblázata  
 Tabel de modificare a culorilor modelului de broderie

Broderimönster färgändringstabell  
 Tabulka s variantami barev vyšivacích vzorů  
 Tabela zmiany kolorów wzorów haftów

- Vintage
- Klasické znaky
- Clasice

- Klassiskt
- Régies

- Vintage
- Klasyczne



<p>No.1 <b>17 min</b>                  1  (323)                  ↓ 148.0 mm                  ⇔ 129.6 mm</p>	<p>No.6 <b>16 min</b>                  1  (323)                  ↓ 149.3 mm                  ⇔ 107.4 mm</p>	<p>No.11 <b>21 min</b>                  1  (323)                  ↓ 149.4 mm                  ⇔ 125.1 mm</p>
<p>No.2 <b>18 min</b>                  1  (323)                  ↓ 149.9 mm                  ⇔ 110.9 mm</p>	<p>No.7 <b>18 min</b>                  1  (323)                  ↓ 150.4 mm                  ⇔ 111.7 mm</p>	<p>No.12 <b>13 min</b>                  1  (323)                  ↓ 149.2 mm                  ⇔ 107.1 mm</p>
<p>No.3 <b>14 min</b>                  1  (323)                  ↓ 152.9 mm                  ⇔ 102.3 mm</p>	<p>No.8 <b>21 min</b>                  1  (323)                  ↓ 149.1 mm                  ⇔ 125.6 mm</p>	<p>No.13 <b>28 min</b>                  1  (323)                  ↓ 149.2 mm                  ⇔ 150.1 mm</p>
<p>No.4 <b>18 min</b>                  1  (323)                  ↓ 149.3 mm                  ⇔ 111.7 mm</p>	<p>No.9 <b>10 min</b>                  1  (323)                  ↓ 149.1 mm                  ⇔ 58.0 mm</p>	<p>No.14 <b>21 min</b>                  1  (323)                  ↓ 149.7 mm                  ⇔ 131.1 mm</p>
<p>No.5 <b>19 min</b>                  1  (323)                  ↓ 149.1 mm                  ⇔ 109.7 mm</p>	<p>No.10 <b>11 min</b>                  1  (323)                  ↓ 148.8 mm                  ⇔ 93.9 mm</p>	<p>No.15 <b>19 min</b>                  1  (323)                  ↓ 151.7 mm                  ⇔ 107.1 mm</p>

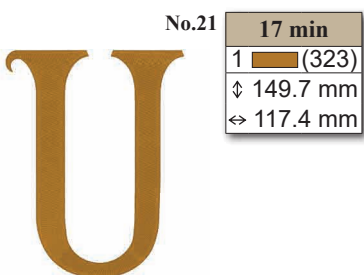
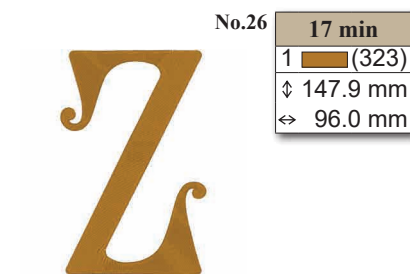
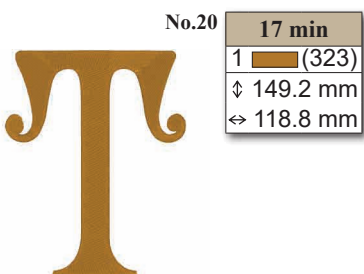
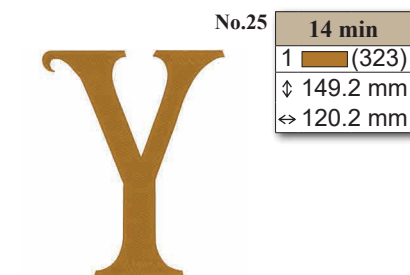
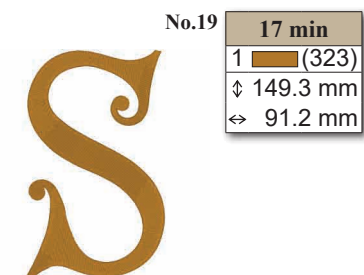
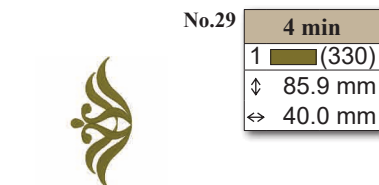
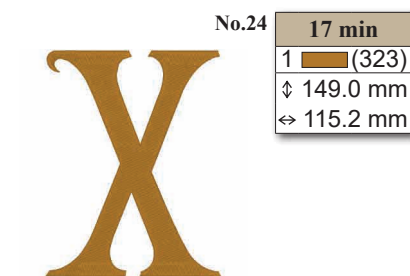
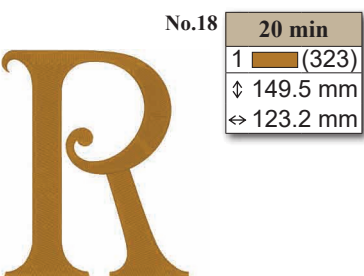
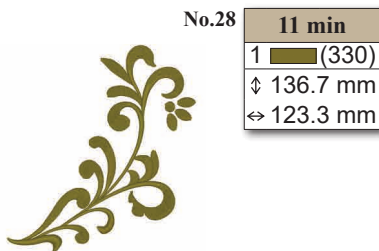
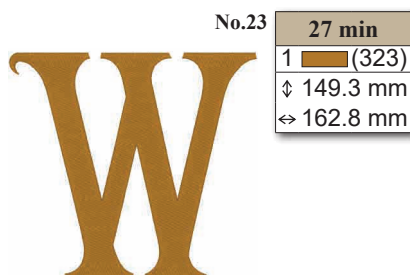
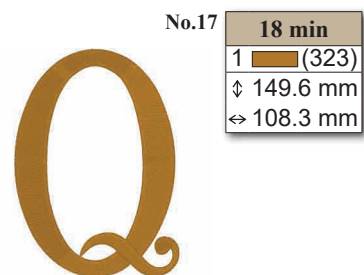
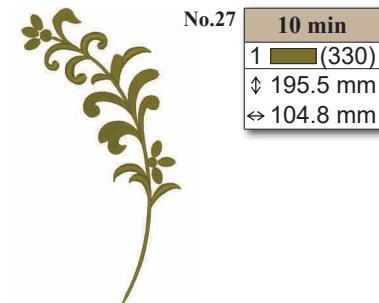
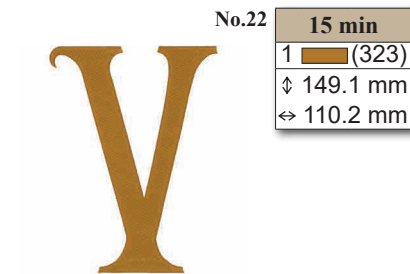
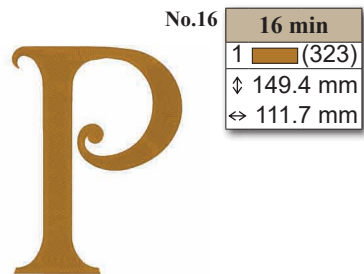













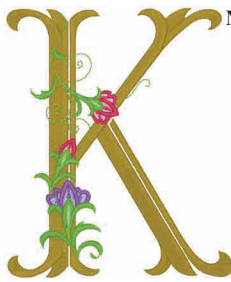



**Embroidery Patterns Color Change Table**  
**Oversigt over de indbyggede broderimønstre med farver**  
**A hímzésminták színcsere-táblázata**  
**Tabel de modificare a culorilor modelului de broderie**

**Broderimönster färgändringstabell**  
**Tabulka s variantami barev vyšivacích vzorů**  
**Tabela zmiany kolorów wzorów haftów**

- Floral
- Kvetinové
- Florale
- Blommor
- Virágmotívumos
- Blomster
- Kwiaty



 <p><b>No.1</b></p> <table border="1" style="width: 100%; border-collapse: collapse;"> <tr><th colspan="2">17 min</th></tr> <tr><td>1</td><td>(328)</td></tr> <tr><td>2</td><td>(804)</td></tr> <tr><td>3</td><td>(612)</td></tr> <tr><td>4</td><td>(079)</td></tr> <tr><td>5</td><td>(807)</td></tr> <tr><td>6</td><td>(513)</td></tr> <tr><td>7</td><td>(502)</td></tr> <tr><td colspan="2">↓ 145.1 mm</td></tr> <tr><td colspan="2">↔ 125.7 mm</td></tr> </table>	17 min		1	(328)	2	(804)	3	(612)	4	(079)	5	(807)	6	(513)	7	(502)	↓ 145.1 mm		↔ 125.7 mm		 <p><b>No.6</b></p> <table border="1" style="width: 100%; border-collapse: collapse;"> <tr><th colspan="2">16 min</th></tr> <tr><td>1</td><td>(328)</td></tr> <tr><td>2</td><td>(804)</td></tr> <tr><td>3</td><td>(612)</td></tr> <tr><td>4</td><td>(079)</td></tr> <tr><td>5</td><td>(807)</td></tr> <tr><td>6</td><td>(513)</td></tr> <tr><td>7</td><td>(502)</td></tr> <tr><td colspan="2">↓ 142.8 mm</td></tr> <tr><td colspan="2">↔ 101.8 mm</td></tr> </table>	16 min		1	(328)	2	(804)	3	(612)	4	(079)	5	(807)	6	(513)	7	(502)	↓ 142.8 mm		↔ 101.8 mm		 <p><b>No.11</b></p> <table border="1" style="width: 100%; border-collapse: collapse;"> <tr><th colspan="2">20 min</th></tr> <tr><td>1</td><td>(328)</td></tr> <tr><td>2</td><td>(804)</td></tr> <tr><td>3</td><td>(612)</td></tr> <tr><td>4</td><td>(079)</td></tr> <tr><td>5</td><td>(807)</td></tr> <tr><td>6</td><td>(513)</td></tr> <tr><td>7</td><td>(502)</td></tr> <tr><td colspan="2">↓ 142.0 mm</td></tr> <tr><td colspan="2">↔ 119.6 mm</td></tr> </table>	20 min		1	(328)	2	(804)	3	(612)	4	(079)	5	(807)	6	(513)	7	(502)	↓ 142.0 mm		↔ 119.6 mm	
17 min																																																														
1	(328)																																																													
2	(804)																																																													
3	(612)																																																													
4	(079)																																																													
5	(807)																																																													
6	(513)																																																													
7	(502)																																																													
↓ 145.1 mm																																																														
↔ 125.7 mm																																																														
16 min																																																														
1	(328)																																																													
2	(804)																																																													
3	(612)																																																													
4	(079)																																																													
5	(807)																																																													
6	(513)																																																													
7	(502)																																																													
↓ 142.8 mm																																																														
↔ 101.8 mm																																																														
20 min																																																														
1	(328)																																																													
2	(804)																																																													
3	(612)																																																													
4	(079)																																																													
5	(807)																																																													
6	(513)																																																													
7	(502)																																																													
↓ 142.0 mm																																																														
↔ 119.6 mm																																																														
 <p><b>No.2</b></p> <table border="1" style="width: 100%; border-collapse: collapse;"> <tr><th colspan="2">20 min</th></tr> <tr><td>1</td><td>(328)</td></tr> <tr><td>2</td><td>(804)</td></tr> <tr><td>3</td><td>(612)</td></tr> <tr><td>4</td><td>(079)</td></tr> <tr><td>5</td><td>(807)</td></tr> <tr><td>6</td><td>(513)</td></tr> <tr><td>7</td><td>(502)</td></tr> <tr><td colspan="2">↓ 140.9 mm</td></tr> <tr><td colspan="2">↔ 108.1 mm</td></tr> </table>	20 min		1	(328)	2	(804)	3	(612)	4	(079)	5	(807)	6	(513)	7	(502)	↓ 140.9 mm		↔ 108.1 mm		 <p><b>No.7</b></p> <table border="1" style="width: 100%; border-collapse: collapse;"> <tr><th colspan="2">19 min</th></tr> <tr><td>1</td><td>(328)</td></tr> <tr><td>2</td><td>(804)</td></tr> <tr><td>3</td><td>(612)</td></tr> <tr><td>4</td><td>(079)</td></tr> <tr><td>5</td><td>(807)</td></tr> <tr><td>6</td><td>(513)</td></tr> <tr><td>7</td><td>(502)</td></tr> <tr><td colspan="2">↓ 141.6 mm</td></tr> <tr><td colspan="2">↔ 117.3 mm</td></tr> </table>	19 min		1	(328)	2	(804)	3	(612)	4	(079)	5	(807)	6	(513)	7	(502)	↓ 141.6 mm		↔ 117.3 mm		 <p><b>No.12</b></p> <table border="1" style="width: 100%; border-collapse: collapse;"> <tr><th colspan="2">15 min</th></tr> <tr><td>1</td><td>(328)</td></tr> <tr><td>2</td><td>(804)</td></tr> <tr><td>3</td><td>(612)</td></tr> <tr><td>4</td><td>(079)</td></tr> <tr><td>5</td><td>(807)</td></tr> <tr><td>6</td><td>(513)</td></tr> <tr><td>7</td><td>(502)</td></tr> <tr><td colspan="2">↓ 144.9 mm</td></tr> <tr><td colspan="2">↔ 107.0 mm</td></tr> </table>	15 min		1	(328)	2	(804)	3	(612)	4	(079)	5	(807)	6	(513)	7	(502)	↓ 144.9 mm		↔ 107.0 mm	
20 min																																																														
1	(328)																																																													
2	(804)																																																													
3	(612)																																																													
4	(079)																																																													
5	(807)																																																													
6	(513)																																																													
7	(502)																																																													
↓ 140.9 mm																																																														
↔ 108.1 mm																																																														
19 min																																																														
1	(328)																																																													
2	(804)																																																													
3	(612)																																																													
4	(079)																																																													
5	(807)																																																													
6	(513)																																																													
7	(502)																																																													
↓ 141.6 mm																																																														
↔ 117.3 mm																																																														
15 min																																																														
1	(328)																																																													
2	(804)																																																													
3	(612)																																																													
4	(079)																																																													
5	(807)																																																													
6	(513)																																																													
7	(502)																																																													
↓ 144.9 mm																																																														
↔ 107.0 mm																																																														
 <p><b>No.3</b></p> <table border="1" style="width: 100%; border-collapse: collapse;"> <tr><th colspan="2">17 min</th></tr> <tr><td>1</td><td>(328)</td></tr> <tr><td>2</td><td>(804)</td></tr> <tr><td>3</td><td>(612)</td></tr> <tr><td>4</td><td>(079)</td></tr> <tr><td>5</td><td>(807)</td></tr> <tr><td>6</td><td>(513)</td></tr> <tr><td>7</td><td>(502)</td></tr> <tr><td colspan="2">↓ 141.8 mm</td></tr> <tr><td colspan="2">↔ 114.5 mm</td></tr> </table>	17 min		1	(328)	2	(804)	3	(612)	4	(079)	5	(807)	6	(513)	7	(502)	↓ 141.8 mm		↔ 114.5 mm		 <p><b>No.8</b></p> <table border="1" style="width: 100%; border-collapse: collapse;"> <tr><th colspan="2">22 min</th></tr> <tr><td>1</td><td>(328)</td></tr> <tr><td>2</td><td>(804)</td></tr> <tr><td>3</td><td>(612)</td></tr> <tr><td>4</td><td>(079)</td></tr> <tr><td>5</td><td>(807)</td></tr> <tr><td>6</td><td>(513)</td></tr> <tr><td>7</td><td>(502)</td></tr> <tr><td colspan="2">↓ 141.7 mm</td></tr> <tr><td colspan="2">↔ 121.6 mm</td></tr> </table>	22 min		1	(328)	2	(804)	3	(612)	4	(079)	5	(807)	6	(513)	7	(502)	↓ 141.7 mm		↔ 121.6 mm		 <p><b>No.13</b></p> <table border="1" style="width: 100%; border-collapse: collapse;"> <tr><th colspan="2">23 min</th></tr> <tr><td>1</td><td>(328)</td></tr> <tr><td>2</td><td>(804)</td></tr> <tr><td>3</td><td>(612)</td></tr> <tr><td>4</td><td>(079)</td></tr> <tr><td>5</td><td>(807)</td></tr> <tr><td>6</td><td>(513)</td></tr> <tr><td>7</td><td>(502)</td></tr> <tr><td colspan="2">↓ 146.5 mm</td></tr> <tr><td colspan="2">↔ 124.6 mm</td></tr> </table>	23 min		1	(328)	2	(804)	3	(612)	4	(079)	5	(807)	6	(513)	7	(502)	↓ 146.5 mm		↔ 124.6 mm	
17 min																																																														
1	(328)																																																													
2	(804)																																																													
3	(612)																																																													
4	(079)																																																													
5	(807)																																																													
6	(513)																																																													
7	(502)																																																													
↓ 141.8 mm																																																														
↔ 114.5 mm																																																														
22 min																																																														
1	(328)																																																													
2	(804)																																																													
3	(612)																																																													
4	(079)																																																													
5	(807)																																																													
6	(513)																																																													
7	(502)																																																													
↓ 141.7 mm																																																														
↔ 121.6 mm																																																														
23 min																																																														
1	(328)																																																													
2	(804)																																																													
3	(612)																																																													
4	(079)																																																													
5	(807)																																																													
6	(513)																																																													
7	(502)																																																													
↓ 146.5 mm																																																														
↔ 124.6 mm																																																														
 <p><b>No.4</b></p> <table border="1" style="width: 100%; border-collapse: collapse;"> <tr><th colspan="2">19 min</th></tr> <tr><td>1</td><td>(328)</td></tr> <tr><td>2</td><td>(804)</td></tr> <tr><td>3</td><td>(612)</td></tr> <tr><td>4</td><td>(079)</td></tr> <tr><td>5</td><td>(807)</td></tr> <tr><td>6</td><td>(513)</td></tr> <tr><td>7</td><td>(502)</td></tr> <tr><td colspan="2">↓ 141.2 mm</td></tr> <tr><td colspan="2">↔ 108.3 mm</td></tr> </table>	19 min		1	(328)	2	(804)	3	(612)	4	(079)	5	(807)	6	(513)	7	(502)	↓ 141.2 mm		↔ 108.3 mm		 <p><b>No.9</b></p> <table border="1" style="width: 100%; border-collapse: collapse;"> <tr><th colspan="2">14 min</th></tr> <tr><td>1</td><td>(328)</td></tr> <tr><td>2</td><td>(804)</td></tr> <tr><td>3</td><td>(612)</td></tr> <tr><td>4</td><td>(079)</td></tr> <tr><td>5</td><td>(807)</td></tr> <tr><td>6</td><td>(513)</td></tr> <tr><td>7</td><td>(502)</td></tr> <tr><td colspan="2">↓ 145.8 mm</td></tr> <tr><td colspan="2">↔ 49.7 mm</td></tr> </table>	14 min		1	(328)	2	(804)	3	(612)	4	(079)	5	(807)	6	(513)	7	(502)	↓ 145.8 mm		↔ 49.7 mm		 <p><b>No.14</b></p> <table border="1" style="width: 100%; border-collapse: collapse;"> <tr><th colspan="2">20 min</th></tr> <tr><td>1</td><td>(328)</td></tr> <tr><td>2</td><td>(804)</td></tr> <tr><td>3</td><td>(612)</td></tr> <tr><td>4</td><td>(079)</td></tr> <tr><td>5</td><td>(807)</td></tr> <tr><td>6</td><td>(513)</td></tr> <tr><td>7</td><td>(502)</td></tr> <tr><td colspan="2">↓ 147.0 mm</td></tr> <tr><td colspan="2">↔ 116.8 mm</td></tr> </table>	20 min		1	(328)	2	(804)	3	(612)	4	(079)	5	(807)	6	(513)	7	(502)	↓ 147.0 mm		↔ 116.8 mm	
19 min																																																														
1	(328)																																																													
2	(804)																																																													
3	(612)																																																													
4	(079)																																																													
5	(807)																																																													
6	(513)																																																													
7	(502)																																																													
↓ 141.2 mm																																																														
↔ 108.3 mm																																																														
14 min																																																														
1	(328)																																																													
2	(804)																																																													
3	(612)																																																													
4	(079)																																																													
5	(807)																																																													
6	(513)																																																													
7	(502)																																																													
↓ 145.8 mm																																																														
↔ 49.7 mm																																																														
20 min																																																														
1	(328)																																																													
2	(804)																																																													
3	(612)																																																													
4	(079)																																																													
5	(807)																																																													
6	(513)																																																													
7	(502)																																																													
↓ 147.0 mm																																																														
↔ 116.8 mm																																																														
 <p><b>No.5</b></p> <table border="1" style="width: 100%; border-collapse: collapse;"> <tr><th colspan="2">18 min</th></tr> <tr><td>1</td><td>(328)</td></tr> <tr><td>2</td><td>(804)</td></tr> <tr><td>3</td><td>(612)</td></tr> <tr><td>4</td><td>(079)</td></tr> <tr><td>5</td><td>(807)</td></tr> <tr><td>6</td><td>(513)</td></tr> <tr><td>7</td><td>(502)</td></tr> <tr><td colspan="2">↓ 144.3 mm</td></tr> <tr><td colspan="2">↔ 102.5 mm</td></tr> </table>	18 min		1	(328)	2	(804)	3	(612)	4	(079)	5	(807)	6	(513)	7	(502)	↓ 144.3 mm		↔ 102.5 mm		 <p><b>No.10</b></p> <table border="1" style="width: 100%; border-collapse: collapse;"> <tr><th colspan="2">15 min</th></tr> <tr><td>1</td><td>(328)</td></tr> <tr><td>2</td><td>(804)</td></tr> <tr><td>3</td><td>(612)</td></tr> <tr><td>4</td><td>(079)</td></tr> <tr><td>5</td><td>(807)</td></tr> <tr><td>6</td><td>(513)</td></tr> <tr><td>7</td><td>(502)</td></tr> <tr><td colspan="2">↓ 144.5 mm</td></tr> <tr><td colspan="2">↔ 82.3 mm</td></tr> </table>	15 min		1	(328)	2	(804)	3	(612)	4	(079)	5	(807)	6	(513)	7	(502)	↓ 144.5 mm		↔ 82.3 mm		 <p><b>No.15</b></p> <table border="1" style="width: 100%; border-collapse: collapse;"> <tr><th colspan="2">19 min</th></tr> <tr><td>1</td><td>(328)</td></tr> <tr><td>2</td><td>(804)</td></tr> <tr><td>3</td><td>(612)</td></tr> <tr><td>4</td><td>(079)</td></tr> <tr><td>5</td><td>(807)</td></tr> <tr><td>6</td><td>(513)</td></tr> <tr><td>7</td><td>(502)</td></tr> <tr><td colspan="2">↓ 146.3 mm</td></tr> <tr><td colspan="2">↔ 115.3 mm</td></tr> </table>	19 min		1	(328)	2	(804)	3	(612)	4	(079)	5	(807)	6	(513)	7	(502)	↓ 146.3 mm		↔ 115.3 mm	
18 min																																																														
1	(328)																																																													
2	(804)																																																													
3	(612)																																																													
4	(079)																																																													
5	(807)																																																													
6	(513)																																																													
7	(502)																																																													
↓ 144.3 mm																																																														
↔ 102.5 mm																																																														
15 min																																																														
1	(328)																																																													
2	(804)																																																													
3	(612)																																																													
4	(079)																																																													
5	(807)																																																													
6	(513)																																																													
7	(502)																																																													
↓ 144.5 mm																																																														
↔ 82.3 mm																																																														
19 min																																																														
1	(328)																																																													
2	(804)																																																													
3	(612)																																																													
4	(079)																																																													
5	(807)																																																													
6	(513)																																																													
7	(502)																																																													
↓ 146.3 mm																																																														
↔ 115.3 mm																																																														

**No.16** 17 min



1	(328)
2	(804)
3	(612)
4	(079)
5	(807)
6	(513)
7	(502)

↓ 143.4 mm  
↔ 99.6 mm

**No.20** 18 min



1	(328)
2	(804)
3	(612)
4	(079)
5	(807)
6	(513)
7	(502)

↓ 144.5 mm  
↔ 118.4 mm

**No.24** 19 min



1	(328)
2	(804)
3	(612)
4	(079)
5	(807)
6	(513)
7	(502)

↓ 142.3 mm  
↔ 115.9 mm

**No.17** 20 min



1	(328)
2	(804)
3	(612)
4	(079)
5	(807)
6	(513)
7	(502)

↓ 142.7 mm  
↔ 118.2 mm

**No.21** 18 min



1	(328)
2	(804)
3	(612)
4	(079)
5	(807)
6	(513)
7	(502)

↓ 144.6 mm  
↔ 118.5 mm

**No.25** 17 min



1	(328)
2	(804)
3	(612)
4	(079)
5	(807)
6	(513)
7	(502)

↓ 142.8 mm  
↔ 116.3 mm

**No.18** 21 min



1	(328)
2	(804)
3	(612)
4	(079)
5	(807)
6	(513)
7	(502)

↓ 143.4 mm  
↔ 112.5 mm

**No.22** 17 min



1	(328)
2	(804)
3	(612)
4	(079)
5	(807)
6	(513)
7	(502)

↓ 145.5 mm  
↔ 121.5 mm

**No.26** 19 min



1	(328)
2	(804)
3	(612)
4	(079)
5	(807)
6	(513)
7	(502)

↓ 142.8 mm  
↔ 92.9 mm

**No.19** 21 min



1	(328)
2	(804)
3	(612)
4	(079)
5	(807)
6	(513)
7	(502)

↓ 144.1 mm  
↔ 99.4 mm

**No.23** 23 min



1	(328)
2	(804)
3	(612)
4	(079)
5	(807)
6	(513)
7	(502)

↓ 146.2 mm  
↔ 124.8 mm

◆Example ◆Exempel ◆Eksempel ◆VPřiklad  
◆Példa ◆Przykład ◆Exemplu

**No.27** 3 min



1	(328)
2	(079)
3	(807)
4	(513)
5	(502)

↓ 51.9 mm  
↔ 45.9 mm

**No.29** 3 min



1	(328)
2	(079)
3	(807)
4	(513)
5	(502)

↓ 52.2 mm  
↔ 41.1 mm

**No.31** 3 min



1	(328)
2	(079)
3	(807)
4	(513)
5	(502)

↓ 53.1 mm  
↔ 37.3 mm

**No.28** 3 min



1	(328)
2	(079)
3	(807)
4	(513)
5	(502)

↓ 51.7 mm  
↔ 39.6 mm

**No.30** 3 min



1	(328)
2	(079)
3	(807)
4	(513)
5	(502)

↓ 51.9 mm  
↔ 39.3 mm

**No.32** 3 min



1	(328)
2	(079)
3	(807)
4	(513)
5	(502)

↓ 52.1 mm  
↔ 36.6 mm

**No.32** 3 min



1	(328)
2	(079)
3	(807)
4	(513)
5	(502)

↓ 52.1 mm  
↔ 36.6 mm

**Embroidery Patterns Color Change Table**  
**Oversigt over de indbyggede broderimønstre med farver**  
**A hímzésminták színcsere-táblázata**  
**Tabel de modificare a culorilor modelului de broderie**

**Broderimönster färgändringstabell**  
**Tabulka s variantami barev vyšivacích vzorů**  
**Tabela zmiany kolorów wzorów haftów**

**No.33**

3 min	
1	(328)
2	(079)
3	(807)
4	(513)
5	(502)
↓ 51.9 mm	
↔ 42.7 mm	

**No.38**

3 min	
1	(328)
2	(079)
3	(807)
4	(513)
5	(502)
↓ 52.5 mm	
↔ 38.9 mm	

**No.43**

3 min	
1	(328)
2	(079)
3	(807)
4	(513)
5	(502)
↓ 52.6 mm	
↔ 43.3 mm	

**No.48**

3 min	
1	(328)
2	(079)
3	(807)
4	(513)
5	(502)
↓ 52.8 mm	
↔ 43.9 mm	

**No.34**

4 min	
1	(328)
2	(079)
3	(807)
4	(513)
5	(502)
↓ 52.2 mm	
↔ 44.3 mm	

**No.39**

5 min	
1	(328)
2	(079)
3	(807)
4	(513)
5	(502)
↓ 53.3 mm	
↔ 46.4 mm	

**No.44**

4 min	
1	(328)
2	(079)
3	(807)
4	(513)
5	(502)
↓ 52.3 mm	
↔ 40.7 mm	

**No.49**

4 min	
1	(328)
2	(079)
3	(807)
4	(513)
5	(502)
↓ 53.3 mm	
↔ 46.5 mm	

**No.35**

3 min	
1	(328)
2	(079)
3	(807)
4	(513)
5	(502)
↓ 53.9 mm	
↔ 23.8 mm	

**No.40**

4 min	
1	(328)
2	(079)
3	(807)
4	(513)
5	(502)
↓ 52.9 mm	
↔ 43.1 mm	

**No.45**

3 min	
1	(328)
2	(079)
3	(807)
4	(513)
5	(502)
↓ 52.6 mm	
↔ 35.0 mm	

**No.50**

3 min	
1	(328)
2	(079)
3	(807)
4	(513)
5	(502)
↓ 51.7 mm	
↔ 42.0 mm	

**No.36**

3 min	
1	(328)
2	(079)
3	(807)
4	(513)
5	(502)
↓ 52.6 mm	
↔ 30.1 mm	

**No.41**

3 min	
1	(328)
2	(079)
3	(807)
4	(513)
5	(502)
↓ 52.8 mm	
↔ 42.6 mm	

**No.46**

3 min	
1	(328)
2	(079)
3	(807)
4	(513)
5	(502)
↓ 53.0 mm	
↔ 42.0 mm	

**No.51**

3 min	
1	(328)
2	(079)
3	(807)
4	(513)
5	(502)
↓ 53.8 mm	
↔ 42.2 mm	

**No.37**

4 min	
1	(328)
2	(079)
3	(807)
4	(513)
5	(502)
↓ 52.4 mm	
↔ 43.4 mm	

**No.42**

3 min	
1	(328)
2	(079)
3	(807)
4	(513)
5	(502)
↓ 52.1 mm	
↔ 36.9 mm	

**No.47**

3 min	
1	(328)
2	(079)
3	(807)
4	(513)
5	(502)
↓ 52.5 mm	
↔ 42.8 mm	

**No.52**

3 min	
1	(328)
2	(079)
3	(807)
4	(513)
5	(502)
↓ 52.4 mm	
↔ 33.4 mm	

**No.53**

2 min	
1	(804)
2	(612)
3	(079)
4	(807)
5	(513)
6	(502)
↓ 34.4 mm	
↔ 22.7 mm	

**No.55**

3 min					
1	(804)	3	(079)	5	(513)
2	(612)	4	(807)	6	(502)
↓ 39.3 mm ↔ 75.4 mm					

**No.57**

6 min											
1	(804)	7	(804)	13	(079)						
2	(612)	8	(612)	14	(807)						
3	(079)	9	(079)	15	(513)						
4	(807)	10	(807)	16	(502)						
5	(513)	11	(513)								
6	(502)	12	(502)								
↓ 27.9 mm ↔ 121.9 mm											

**No.54**

2 min	
1	(079)
2	(807)
3	(513)
4	(502)
↓ 39.8 mm	
↔ 25.6 mm	

**No.56**

6 min											
1	(804)	5	(513)	9	(079)						
2	(612)	6	(502)	10	(807)						
3	(079)	7	(804)	11	(513)						
4	(807)	8	(612)	12	(502)						
↓ 23.4 mm ↔ 123.7 mm											



No. 58

11 min		
1 (079)	7 (513)	13 (079)
2 (807)	8 (502)	14 (807)
3 (513)	9 (079)	15 (513)
4 (502)	10 (807)	16 (502)
5 (079)	11 (513)	
6 (807)	12 (502)	
↓ 103.6 mm ↔ 94.9 mm		



No.60

4 min	
1 (513)	2 (807)
3 (513)	4 (807)
↓ 106.7 mm ↔ 93.4 mm	



No.63

1 min
1 (513)
↓ 147.2 mm ↔ 61.8 mm



No.61

3 min	
1 (513)	2 (807)
3 (513)	4 (807)
↓ 42.6 mm ↔ 142.0 mm	



No.64



No.59

20 min		
1 (079)	17 (513)	33 (804)
2 (807)	18 (502)	34 (612)
3 (804)	19 (079)	35 (513)
4 (612)	20 (807)	36 (502)
5 (513)	21 (804)	37 (079)
6 (502)	22 (612)	38 (807)
7 (079)	23 (513)	39 (804)
8 (807)	24 (502)	40 (612)
9 (804)	25 (079)	41 (513)
10 (612)	26 (807)	42 (502)
11 (513)	27 (804)	43 (079)
12 (502)	28 (612)	44 (807)
13 (079)	29 (513)	45 (804)
14 (807)	30 (502)	46 (612)
15 (804)	31 (079)	47 (513)
16 (612)	32 (807)	48 (502)
↓ 195.4 mm ↔ 157.3 mm		



No.62

11 min		
1 (513)	4 (807)	7 (513)
2 (807)	5 (513)	8 (807)
3 (513)	6 (807)	
↓ 195.4 mm ↔ 158.5 mm		

7 min	
1 (804)	13 (804)
2 (612)	14 (612)
3 (079)	15 (079)
4 (807)	16 (807)
5 (513)	17 (513)
6 (502)	18 (502)
7 (804)	19 (804)
8 (612)	20 (612)
9 (079)	21 (079)
10 (807)	22 (807)
11 (513)	23 (513)
12 (502)	24 (502)
↓ 73.3 mm ↔ 72.8 mm	

**Embroidery Patterns Color Change Table**  
**Oversigt over de indbyggede broderimønstre med farver**  
**A hímzésminták színcsere-táblázata**  
**Tabel de modificare a culorilor modelului de broderie**

**Broderimönster färgändringstabell**  
**Tabulka s variantami barev vyšivacích vzorů**  
**Tabela zmiany kolorów wzorów haftów**

- Line
- Linie
- Linie

- Linje
- Vonalas

- Linje
- Linia



No.1

L: 13 min S: 9 min	
1	■ (005)
2	■ (807)
↓ 125.1 mm	
L:	↔ 103.3 mm
↓ 95.9 mm	
S:	↔ 79.1 mm



No.4

L: 14 min S: 10 min	
1	■ (005)
2	■ (807)
↓ 124.8 mm	
L:	↔ 95.8 mm
↓ 95.8 mm	
S:	↔ 73.8 mm



No.7

L: 12 min S: 8 min	
1	■ (005)
2	■ (807)
↓ 125.0 mm	
L:	↔ 87.6 mm
↓ 95.8 mm	
S:	↔ 67.2 mm



No.2

L: 13 min S: 9 min	
1	■ (005)
2	■ (807)
↓ 124.8 mm	
L:	↔ 86.6 mm
↓ 95.7 mm	
S:	↔ 66.4 mm



No.5

L: 14 min S: 10 min	
1	■ (005)
2	■ (807)
↓ 124.8 mm	
L:	↔ 87.8 mm
↓ 95.8 mm	
S:	↔ 67.4 mm



No.8

L: 15 min S: 10 min	
1	■ (005)
2	■ (807)
↓ 125.0 mm	
L:	↔ 89.8 mm
↓ 95.7 mm	
S:	↔ 68.8 mm



No.3

L: 11 min S: 8 min	
1	■ (005)
2	■ (807)
↓ 124.8 mm	
L:	↔ 85.6 mm
↓ 95.8 mm	
S:	↔ 65.8 mm



No.6

L: 13 min S: 9 min	
1	■ (005)
2	■ (807)
↓ 124.8 mm	
L:	↔ 80.6 mm
↓ 95.8 mm	
S:	↔ 61.8 mm



No.9

L: 7 min S: 5 min	
1	■ (005)
2	■ (807)
↓ 124.9 mm	
L:	↔ 66.0 mm
↓ 95.8 mm	
S:	↔ 50.6 mm



No.10

L: 9 min	
S: 6 min	
1	█ (005)
2	█ (807)
↓	124.9 mm
L: ←	75.4 mm
↓	95.8 mm
S: ←	57.8 mm



No.13

L: 18 min	
S: 13 min	
1	█ (005)
2	█ (807)
↓	125.0 mm
L: ←	117.6 mm
↓	95.8 mm
S: ←	90.4 mm



No.16

L: 13 min	
S: 9 min	
1	█ (005)
2	█ (807)
↓	125.0 mm
L: ←	82.6 mm
↓	95.8 mm
S: ←	63.2 mm



No.11

L: 13 min	
S: 9 min	
1	█ (005)
2	█ (807)
↓	125.0 mm
L: ←	95.6 mm
↓	95.8 mm
S: ←	73.4 mm



No.14

L: 15 min	
S: 10 min	
1	█ (005)
2	█ (807)
↓	124.8 mm
L: ←	96.0 mm
↓	95.8 mm
S: ←	73.6 mm



No.17

L: 15 min	
S: 10 min	
1	█ (005)
2	█ (807)
↓	124.8 mm
L: ←	160.4 mm
↓	96.0 mm
S: ←	123.2 mm



No.12

L: 12 min	
S: 9 min	
1	█ (005)
2	█ (807)
↓	124.9 mm
L: ←	88.1 mm
↓	95.8 mm
S: ←	67.6 mm



No.15

L: 13 min	
S: 9 min	
1	█ (005)
2	█ (807)
↓	124.6 mm
L: ←	96.8 mm
↓	95.8 mm
S: ←	74.4 mm

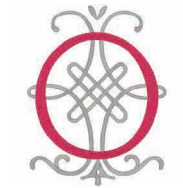

No.18

L: 11 min	
S: 7 min	
1	█ (005)
2	█ (807)
↓	124.8 mm
L: ←	79.6 mm
↓	95.8 mm
S: ←	61.2 mm



**Embroidery Patterns Color Change Table**  
**Oversigt over de indbyggede broderimønstre med farver**  
**A hímzésminták színcsere-táblázata**  
**Tabel de modificare a culorilor modelului de broderie**

**Broderimönster färgändringstabell**  
**Tabulka s variantami barev vyšivacích vzorů**  
**Tabela zmiany kolorów wzorów haftów**

No.19

<b>L: 12 min</b>	
<b>S: 8 min</b>	
1	█ (005)
2	█ (807)
↓ 125.0 mm	
L:	↔ 77.2 mm
↓ 95.8 mm	
S:	↔ 59.1 mm

No.22

<b>L: 13 min</b>	
<b>S: 9 min</b>	
1	█ (005)
2	█ (807)
↓ 124.5 mm	
L:	↔ 103.8 mm
↓ 95.8 mm	
S:	↔ 80.0 mm

No.25

<b>L: 13 min</b>	
<b>S: 8 min</b>	
1	█ (005)
2	█ (807)
↓ 124.8 mm	
L:	↔ 95.6 mm
↓ 95.8 mm	
S:	↔ 73.4 mm

No.20

<b>L: 10 min</b>	
<b>S: 7 min</b>	
1	█ (005)
2	█ (807)
↓ 124.8 mm	
L:	↔ 82.8 mm
↓ 95.8 mm	
S:	↔ 63.6 mm

No.23

<b>L: 15 min</b>	
<b>S: 10 min</b>	
1	█ (005)
2	█ (807)
↓ 124.8 mm	
L:	↔ 124.8 mm
↓ 95.8 mm	
S:	↔ 96.0 mm

No.26

<b>L: 13 min</b>	
<b>S: 9 min</b>	
1	█ (005)
2	█ (807)
↓ 124.4 mm	
L:	↔ 106.3 mm
↓ 95.8 mm	
S:	↔ 81.8 mm

No.21

<b>L: 15 min</b>	
<b>S: 10 min</b>	
1	█ (005)
2	█ (807)
↓ 124.8 mm	
L:	↔ 125.8 mm
↓ 95.8 mm	
S:	↔ 96.6 mm

No.24

<b>L: 15 min</b>	
<b>S: 10 min</b>	
1	█ (005)
2	█ (807)
↓ 124.8 mm	
L:	↔ 123.8 mm
↓ 95.8 mm	
S:	↔ 94.8 mm































Patterns No.1 - No.26, are designed by Hang to Dry.  
 Utformningarna 1 - 26 är skapade av Hang to Dry.  
 Mønstre nr. 1-26 er lavet af Hang to Dry.  
 Vzory č. 1 - č. 26 byly navrženy společností Hang to Dry.  
 Az 1 ... 26 mintákat a Hang to Dry tervezte.  
 Wzorce od nr 1 do nr 26 zostały zaprojektowane przez Hang to Dry.  
 Modelele nr.1 - nr.26 sunt create de Hang to Dry.

- Vine
- Vinná réva
- Viřá de vie

- Vin
- Indás

- Vinranke
- Pnączka



<p><b>No.1</b></p>  <p><b>4 min</b></p> <table border="1"> <tr><td>1</td><td>(620)</td></tr> <tr><td>2</td><td>(612)</td></tr> </table> <p>↓ 54.3 mm ↔ 82.8 mm</p>	1	(620)	2	(612)	<p><b>No.9</b></p>  <p><b>3 min</b></p> <table border="1"> <tr><td>1</td><td>(620)</td></tr> <tr><td>2</td><td>(612)</td></tr> </table> <p>↓ 55.0 mm ↔ 68.3 mm</p>	1	(620)	2	(612)	<p><b>No.17</b></p>  <p><b>3 min</b></p> <table border="1"> <tr><td>1</td><td>(620)</td></tr> <tr><td>2</td><td>(612)</td></tr> </table> <p>↓ 54.9 mm ↔ 83.5 mm</p>	1	(620)	2	(612)	<p><b>No.25</b></p>  <p><b>3 min</b></p> <table border="1"> <tr><td>1</td><td>(620)</td></tr> <tr><td>2</td><td>(612)</td></tr> </table> <p>↓ 53.1 mm ↔ 65.9 mm</p>	1	(620)	2	(612)
1	(620)																		
2	(612)																		
1	(620)																		
2	(612)																		
1	(620)																		
2	(612)																		
1	(620)																		
2	(612)																		
<p><b>No.2</b></p>  <p><b>3 min</b></p> <table border="1"> <tr><td>1</td><td>(620)</td></tr> <tr><td>2</td><td>(612)</td></tr> </table> <p>↓ 54.4 mm ↔ 72.6 mm</p>	1	(620)	2	(612)	<p><b>No.10</b></p>  <p><b>3 min</b></p> <table border="1"> <tr><td>1</td><td>(620)</td></tr> <tr><td>2</td><td>(612)</td></tr> </table> <p>↓ 54.3 mm ↔ 71.0 mm</p>	1	(620)	2	(612)	<p><b>No.18</b></p>  <p><b>4 min</b></p> <table border="1"> <tr><td>1</td><td>(620)</td></tr> <tr><td>2</td><td>(612)</td></tr> </table> <p>↓ 54.7 mm ↔ 81.5 mm</p>	1	(620)	2	(612)	<p><b>No.26</b></p>  <p><b>3 min</b></p> <table border="1"> <tr><td>1</td><td>(620)</td></tr> <tr><td>2</td><td>(612)</td></tr> </table> <p>↓ 55.9 mm ↔ 70.0 mm</p>	1	(620)	2	(612)
1	(620)																		
2	(612)																		
1	(620)																		
2	(612)																		
1	(620)																		
2	(612)																		
1	(620)																		
2	(612)																		
<p><b>No.3</b></p>  <p><b>3 min</b></p> <table border="1"> <tr><td>1</td><td>(620)</td></tr> <tr><td>2</td><td>(612)</td></tr> </table> <p>↓ 53.9 mm ↔ 73.3 mm</p>	1	(620)	2	(612)	<p><b>No.11</b></p>  <p><b>3 min</b></p> <table border="1"> <tr><td>1</td><td>(620)</td></tr> <tr><td>2</td><td>(612)</td></tr> </table> <p>↓ 55.2 mm ↔ 85.3 mm</p>	1	(620)	2	(612)	<p><b>No.19</b></p>  <p><b>3 min</b></p> <table border="1"> <tr><td>1</td><td>(620)</td></tr> <tr><td>2</td><td>(612)</td></tr> </table> <p>↓ 54.5 mm ↔ 73.8 mm</p>	1	(620)	2	(612)	<p><b>No.27</b></p>  <p><b>3 min</b></p> <table border="1"> <tr><td>1</td><td>(620)</td></tr> <tr><td>2</td><td>(612)</td></tr> </table> <p>↓ 57.4 mm ↔ 57.7 mm</p>	1	(620)	2	(612)
1	(620)																		
2	(612)																		
1	(620)																		
2	(612)																		
1	(620)																		
2	(612)																		
1	(620)																		
2	(612)																		
<p><b>No.4</b></p>  <p><b>4 min</b></p> <table border="1"> <tr><td>1</td><td>(620)</td></tr> <tr><td>2</td><td>(612)</td></tr> </table> <p>↓ 54.6 mm ↔ 80.0 mm</p>	1	(620)	2	(612)	<p><b>No.12</b></p>  <p><b>3 min</b></p> <table border="1"> <tr><td>1</td><td>(620)</td></tr> <tr><td>2</td><td>(612)</td></tr> </table> <p>↓ 53.9 mm ↔ 75.0 mm</p>	1	(620)	2	(612)	<p><b>No.20</b></p>  <p><b>3 min</b></p> <table border="1"> <tr><td>1</td><td>(620)</td></tr> <tr><td>2</td><td>(612)</td></tr> </table> <p>↓ 54.2 mm ↔ 73.2 mm</p>	1	(620)	2	(612)	<p><b>No.28</b></p>  <p><b>3 min</b></p> <table border="1"> <tr><td>1</td><td>(620)</td><td>2</td><td>(612)</td></tr> </table> <p>↓ 31.5 mm ↔ 119.2 mm</p>	1	(620)	2	(612)
1	(620)																		
2	(612)																		
1	(620)																		
2	(612)																		
1	(620)																		
2	(612)																		
1	(620)	2	(612)																
<p><b>No.5</b></p>  <p><b>3 min</b></p> <table border="1"> <tr><td>1</td><td>(620)</td></tr> <tr><td>2</td><td>(612)</td></tr> </table> <p>↓ 55.0 mm ↔ 65.3 mm</p>	1	(620)	2	(612)	<p><b>No.13</b></p>  <p><b>4 min</b></p> <table border="1"> <tr><td>1</td><td>(620)</td></tr> <tr><td>2</td><td>(612)</td></tr> </table> <p>↓ 54.1 mm ↔ 85.0 mm</p>	1	(620)	2	(612)	<p><b>No.21</b></p>  <p><b>3 min</b></p> <table border="1"> <tr><td>1</td><td>(620)</td></tr> <tr><td>2</td><td>(612)</td></tr> </table> <p>↓ 53.6 mm ↔ 78.3 mm</p>	1	(620)	2	(612)	<p><b>No.29</b></p>  <p><b>2 min</b></p> <table border="1"> <tr><td>1</td><td>(620)</td><td>2</td><td>(612)</td></tr> </table> <p>↓ 13.4 mm ↔ 195.4 mm</p>	1	(620)	2	(612)
1	(620)																		
2	(612)																		
1	(620)																		
2	(612)																		
1	(620)																		
2	(612)																		
1	(620)	2	(612)																
<p><b>No.6</b></p>  <p><b>3 min</b></p> <table border="1"> <tr><td>1</td><td>(620)</td></tr> <tr><td>2</td><td>(612)</td></tr> </table> <p>↓ 54.0 mm ↔ 78.8 mm</p>	1	(620)	2	(612)	<p><b>No.14</b></p>  <p><b>3 min</b></p> <table border="1"> <tr><td>1</td><td>(620)</td></tr> <tr><td>2</td><td>(612)</td></tr> </table> <p>↓ 54.6 mm ↔ 84.8 mm</p>	1	(620)	2	(612)	<p><b>No.22</b></p>  <p><b>3 min</b></p> <table border="1"> <tr><td>1</td><td>(620)</td></tr> <tr><td>2</td><td>(612)</td></tr> </table> <p>↓ 53.1 mm ↔ 70.9 mm</p>	1	(620)	2	(612)					
1	(620)																		
2	(612)																		
1	(620)																		
2	(612)																		
1	(620)																		
2	(612)																		
<p><b>No.7</b></p>  <p><b>3 min</b></p> <table border="1"> <tr><td>1</td><td>(620)</td></tr> <tr><td>2</td><td>(612)</td></tr> </table> <p>↓ 54.6 mm ↔ 70.4 mm</p>	1	(620)	2	(612)	<p><b>No.15</b></p>  <p><b>3 min</b></p> <table border="1"> <tr><td>1</td><td>(620)</td></tr> <tr><td>2</td><td>(612)</td></tr> </table> <p>↓ 53.9 mm ↔ 78.7 mm</p>	1	(620)	2	(612)	<p><b>No.23</b></p>  <p><b>4 min</b></p> <table border="1"> <tr><td>1</td><td>(620)</td></tr> <tr><td>2</td><td>(612)</td></tr> </table> <p>↓ 53.4 mm ↔ 82.6 mm</p>	1	(620)	2	(612)	<p><b>No.1</b></p>  <p><b>4 min</b></p> <table border="1"> <tr><td>1</td><td>(620)</td></tr> <tr><td>2</td><td>(612)</td></tr> </table> <p>↓ 54.3 mm ↔ 82.8 mm</p>	1	(620)	2	(612)
1	(620)																		
2	(612)																		
1	(620)																		
2	(612)																		
1	(620)																		
2	(612)																		
1	(620)																		
2	(612)																		
<p><b>No.8</b></p>  <p><b>4 min</b></p> <table border="1"> <tr><td>1</td><td>(620)</td></tr> <tr><td>2</td><td>(612)</td></tr> </table> <p>↓ 54.3 mm ↔ 83.3 mm</p>	1	(620)	2	(612)	<p><b>No.16</b></p>  <p><b>3 min</b></p> <table border="1"> <tr><td>1</td><td>(620)</td></tr> <tr><td>2</td><td>(612)</td></tr> </table> <p>↓ 54.7 mm ↔ 67.2 mm</p>	1	(620)	2	(612)	<p><b>No.24</b></p>  <p><b>3 min</b></p> <table border="1"> <tr><td>1</td><td>(620)</td></tr> <tr><td>2</td><td>(612)</td></tr> </table> <p>↓ 53.2 mm ↔ 83.4 mm</p>	1	(620)	2	(612)					
1	(620)																		
2	(612)																		
1	(620)																		
2	(612)																		
1	(620)																		
2	(612)																		



**Embroidery Patterns Color Change Table**  
**Oversigt over de indbyggede broderimønstre med farver**  
**A hímzésminták színcsere-táblázata**  
**Tabel de modificare a culorilor modelului de broderie**

**Broderimønster färgändringstabell**  
**Tabulka s variantami barev vyšivacích vzorů**  
**Tabela zmiany kolorów wzorów haftów**

- Appliqué alphabet
- Ozdoby s abecedou
- Aplicație alfabet

- Applikationsalfabet
- Hímzett ábécé

- Applikation, alfabet
- Alfabet zdobiony



\* Approximate size/Ungefärlig storlek/Omtrentlig størrelse/Přibližná velikost/  
 Hozzávetőleges méret/Przybliżony rozmiar/Dimensiune aproximativă

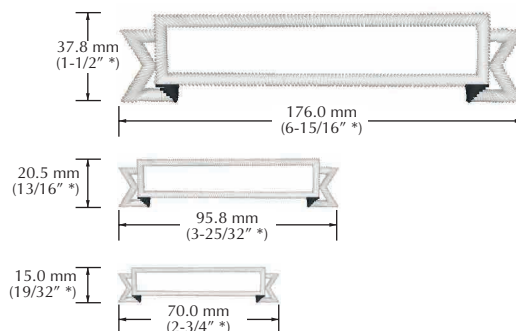
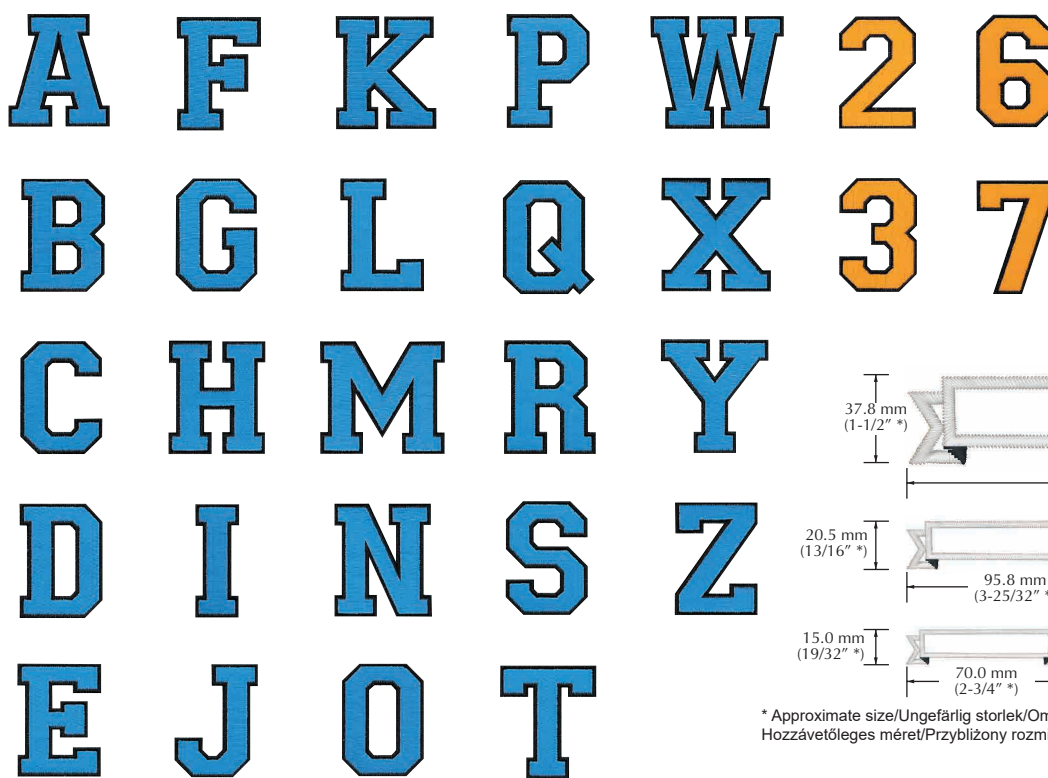

\* Approximate size/Ungefärlig storlek/Omtrentlig størrelse/Přibližná velikost/  
 Hozzávetőleges méret/Przybliżony rozmiar/Dimensiune aproximativă

- Refer to the operation manual for the embroidery machine for details on how to embroider appliqués.
- Information om hur du broderar applikationer finns i brodermaskinens bruksanvisning.
- Se i brugsanvisningen til broderimaskinen for at få oplysninger om, hvordan man broderer applikationer.
- Podrobnosti o vyšívání aplikací najdete v uživatelské příručce vyšivacího stroje.
- A rátétes hímzéssel kapcsolatos részletekért tekintse meg a hímzőgép használati útmutatóját.
- Szczegółowe informacje na temat haftowania aplikacji można znaleźć w instrukcji obsługi hafciarki.
- Consultați manualul de utilizare al mașinii de brodat pentru detalii despre brodarea aplicațiilor.

- Appliqué Greek alphabet
- Ozdoby s řeckou abecedou
- Aplicație alfabet grec

- Grekiskt applikationsalfabet
- Hímzett görög ábécé

- Applikation, græsk alfabet
- Grecki alfabet zdobiony



<p><b>No.1</b></p> <p><b>3 min</b></p> <p>1 ----×(420) 2 ----(420) 3 ----(509) 4 ----(509)</p> <p>↓ 77.8 mm ↔ 80.4 mm</p>	<p><b>No.7</b></p> <p><b>5 min</b></p> <p>1 ----×(420) 2 ----(420) 3 ----(509) 4 ----(509)</p> <p>↓ 75.9 mm ↔ 78.5 mm</p>	<p><b>No.13</b></p> <p><b>4 min</b></p> <p>1 ----×(420) 2 ----(420) 3 ----(509) 4 ----(509)</p> <p>↓ 78.3 mm ↔ 78.4 mm</p>	<p><b>No.19</b></p> <p><b>3 min</b></p> <p>1 ----×(420) 2 ----(420) 3 ----(509) 4 ----(509)</p> <p>↓ 76.1 mm ↔ 68.0 mm</p>
<p><b>No.2</b></p> <p><b>4 min</b></p> <p>1 ----×(420) 2 ----(420) 3 ----(509) 4 ----(509)</p> <p>↓ 76.0 mm ↔ 70.7 mm</p>	<p><b>No.8</b></p> <p><b>5 min</b></p> <p>1 ----×(420) 2 ----(420) 3 ----(509) 4 ----(509)</p> <p>↓ 80.2 mm ↔ 73.9 mm</p>	<p><b>No.14</b></p> <p><b>5 min</b></p> <p>1 ----×(420) 2 ----(420) 3 ----(509) 4 ----(509)</p> <p>↓ 76.1 mm ↔ 68.5 mm</p>	<p><b>No.20</b></p> <p><b>3 min</b></p> <p>1 ----×(420) 2 ----(420) 3 ----(509) 4 ----(509)</p> <p>↓ 75.9 mm ↔ 79.1 mm</p>
<p><b>No.3</b></p> <p><b>3 min</b></p> <p>1 ----×(420) 2 ----(420) 3 ----(509) 4 ----(509)</p> <p>↓ 76.0 mm ↔ 68.2 mm</p>	<p><b>No.9</b></p> <p><b>2 min</b></p> <p>1 ----×(420) 2 ----(420) 3 ----(509) 4 ----(509)</p> <p>↓ 76.0 mm ↔ 38.1 mm</p>	<p><b>No.15</b></p> <p><b>3 min</b></p> <p>1 ----×(420) 2 ----(420) 3 ----(509) 4 ----(509)</p> <p>↓ 80.3 mm ↔ 73.9 mm</p>	<p><b>No.21</b></p> <p><b>5 min</b></p> <p>1 ----×(420) 2 ----(420) 3 ----(509) 4 ----(509)</p> <p>↓ 75.9 mm ↔ 78.0 mm</p>
<p><b>No.4</b></p> <p><b>3 min</b></p> <p>1 ----×(420) 2 ----(420) 3 ----(509) 4 ----(509)</p> <p>↓ 77.7 mm ↔ 70.0 mm</p>	<p><b>No.10</b></p> <p><b>4 min</b></p> <p>1 ----×(420) 2 ----(420) 3 ----(509) 4 ----(509)</p> <p>↓ 76.1 mm ↔ 80.5 mm</p>	<p><b>No.16</b></p> <p><b>4 min</b></p> <p>1 ----×(420) 2 ----(420) 3 ----(509) 4 ----(509)</p> <p>↓ 75.9 mm ↔ 82.6 mm</p>	<p><b>No.22</b></p> <p><b>4 min</b></p> <p>1 ----×(420) 2 ----(420) 3 ----(509) 4 ----(509)</p> <p>↓ 76.0 mm ↔ 80.8 mm</p>
<p><b>No.5</b></p> <p><b>4 min</b></p> <p>1 ----×(420) 2 ----(420) 3 ----(509) 4 ----(509)</p> <p>↓ 76.1 mm ↔ 69.8 mm</p>	<p><b>No.11</b></p> <p><b>3 min</b></p> <p>1 ----×(420) 2 ----(420) 3 ----(509) 4 ----(509)</p> <p>↓ 78.0 mm ↔ 76.0 mm</p>	<p><b>No.17</b></p> <p><b>3 min</b></p> <p>1 ----×(420) 2 ----(420) 3 ----(509) 4 ----(509)</p> <p>↓ 76.0 mm ↔ 62.0 mm</p>	<p><b>No.23</b></p> <p><b>4 min</b></p> <p>1 ----×(420) 2 ----(420) 3 ----(509) 4 ----(509)</p> <p>↓ 76.0 mm ↔ 86.7 mm</p>
<p><b>No.6</b></p> <p><b>3 min</b></p> <p>1 ----×(420) 2 ----(420) 3 ----(509) 4 ----(509)</p> <p>↓ 76.0 mm ↔ 67.4 mm</p>	<p><b>No.12</b></p> <p><b>5 min</b></p> <p>1 ----×(420) 2 ----(420) 3 ----(509) 4 ----(509)</p> <p>↓ 76.0 mm ↔ 95.3 mm</p>	<p><b>No.18</b></p> <p><b>4 min</b></p> <p>1 ----×(420) 2 ----(420) 3 ----(509) 4 ----(509)</p> <p>↓ 76.0 mm ↔ 69.0 mm</p>	<p><b>No.24</b></p> <p><b>5 min</b></p> <p>1 ----×(420) 2 ----(420) 3 ----(509) 4 ----(509)</p> <p>↓ 78.0 mm ↔ 74.1 mm</p>

- Refer to the operation manual for the embroidery machine for details on how to embroider appliqués.
- Information om hur du broderar applikationer finns i broderymaskinens bruksanvisning.
- Se i brugsanvisningen til broderimaskinen for at få oplysninger om, hvordan man broderer applikationer.
- Podrobnosti o vyšívání aplikací najdete v uživatelské příručce vyšívacího stroje.
- A rátétes hímzéssel kapcsolatos részletekért tekintse meg a hímzőgép használati útmutatóját.
- Szczegółowe informacje na temat haftowania aplikacji można znaleźć w instrukcji obsługi hałciarki.
- Consultați manualul de utilizare al mașinii de brodat pentru detalii despre brodarea aplicațiilor.

- ❖ Monograms
- ❖ Monogrammer
- ❖ Monogramok
- ❖ Monograme

- ❖ Monogram
- ❖ Monogramy
- ❖ Monogramy

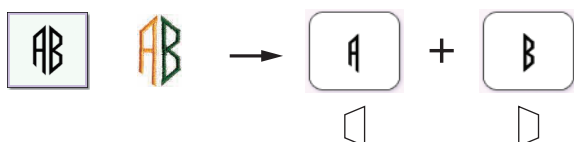
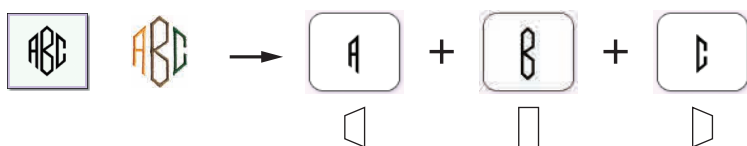

- Monogram Frames
- Rámecčky pro monogramy
- Modele cu monograme
- Monogramramar
- Monogram keretek
- Monogram-rammer
- Ramki do monogramów

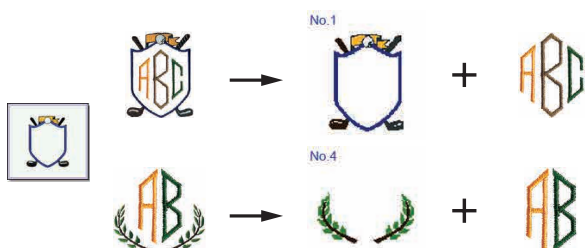

- ❖ Monogram Frames
- ❖ Monogram-rammer
- ❖ Monogram keretek
- ❖ Modele cu monograme

- ❖ Monogramramar
- ❖ Rámečky pro monogramy
- ❖ Ramki do monogramów



No.1

L:	5 min
M:	3 min
S:	2 min
1	(001)
2	(058)
3	(208)
4	(707)
5	(007)
∅	94.4 mm
L:	↔ 73.6 mm
∅	64.1 mm
M:	↔ 50.1 mm
∅	40.9 mm
S:	↔ 31.2 mm

No.4

L:	2 min
M:	1 min
S:	1 min
1	(515)
2	(058)
∅	48.4 mm
L:	↔ 92.5 mm
∅	31.2 mm
M:	↔ 59.5 mm
∅	19.1 mm
S:	↔ 36.4 mm

No.7

L:	2 min
M:	1 min
S:	1 min
1	(214)
2	(843)
∅	84.8 mm
L:	↔ 84.8 mm
∅	55.0 mm
M:	↔ 54.9 mm
∅	33.9 mm
S:	↔ 33.9 mm

No.2

L:	5 min
M:	3 min
S:	2 min
1	(001)
2	(513)
3	(208)
4	(007)
5	(900)
∅	90.1 mm
L:	↔ 81.6 mm
∅	60.2 mm
M:	↔ 54.9 mm
∅	38.8 mm
S:	↔ 36.1 mm

No.5

L:	1 min
M:	1 min
S:	1 min
1	(205)
2	(085)
3	(612)
4	(800)
∅	92.5 mm
L:	↔ 78.9 mm
∅	59.6 mm
M:	↔ 50.9 mm
∅	34.9 mm
S:	↔ 29.7 mm

No.8

L:	2 min
M:	1 min
S:	1 min
1	(507)
2	(800)
∅	94.9 mm
L:	↔ 94.4 mm
∅	63.6 mm
M:	↔ 63.9 mm
∅	39.9 mm
S:	↔ 40.2 mm

No.3

L:	3 min
M:	2 min
S:	1 min
1	(323)
∅	93.8 mm
L:	↔ 64.5 mm
∅	61.4 mm
M:	↔ 42.6 mm
∅	40.3 mm
S:	↔ 27.5 mm

No.6

L:	3 min
M:	1 min
S:	1 min
1	(328)
∅	77.5 mm
L:	↔ 78.2 mm
∅	50.0 mm
M:	↔ 50.4 mm
∅	29.7 mm
S:	↔ 29.9 mm

No.9

L:	3 min
M:	1 min
S:	1 min
1	(900)
2	(515)
3	(214)
∅	94.6 mm
L:	↔ 72.3 mm
∅	59.5 mm
M:	↔ 46.0 mm
∅	37.2 mm
S:	↔ 28.8 mm

**Embroidery Patterns Color Change Table**  
**Oversigt over de indbyggede broderimønstre med farver**  
**A hímzésminták színcsere-táblázata**  
**Tabel de modificare a culorilor modelului de broderie**

**Broderimönster färgändringstabell**  
**Tabulka s variantami barev vyšivacích vzorů**  
**Tabela zmiany kolorów wzorów haftów**

No.10

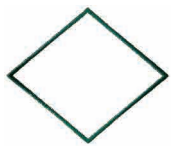

	L: 2 min	M: 1 min	S: 1 min
1	■ (534)		
	↓ 83.4 mm		
L:	↔ 98.7 mm		
	↓ 56.1 mm		
M:	↔ 66.8 mm		
	↓ 35.1 mm		
S:	↔ 41.8 mm		

No.12



	L: 1 min	M: 1 min	S: 1 min
1	■ (070)		
2	■ (612)		
	↓ 22.7 mm		
L:	↔ 90.0 mm		
	↓ 14.5 mm		
M:	↔ 57.4 mm		
	↓ 8.9 mm		
S:	↔ 34.6 mm		

No.14



	L: 1 min	M: 1 min	S: 1 min
1	■ (800)		
	↓ 24.4 mm		
L:	↔ 88.1 mm		
	↓ 15.1 mm		
M:	↔ 56.7 mm		
	↓ 8.4 mm		
S:	↔ 38.9 mm		

No.11



	L: 1 min	M: 1 min	S: 1 min
1	■ (620)		
	↓ 25.2 mm		
L:	↔ 89.4 mm		
	↓ 16.8 mm		
M:	↔ 57.4 mm		
	↓ 9.1 mm		
S:	↔ 34.0 mm		

No.13



	L: 1 min	M: 1 min	S: 1 min
1	■ (208)		
	↓ 28.3 mm		
L:	↔ 91.4 mm		
	↓ 18.4 mm		
M:	↔ 59.0 mm		
	↓ 11.4 mm		
S:	↔ 36.1 mm		

No.15



	L: 2 min	M: 1 min	S: 1 min
1	■ (214)		
2	■ (058)		
	↓ 24.3 mm		
L:	↔ 54.4 mm		
	↓ 15.5 mm		
M:	↔ 34.7 mm		
	↓ 9.3 mm		
S:	↔ 20.8 mm		

# Examples of Combinations Eksempler på kombinationer Kombinálási példák Exemple de combinații

# Exempel på kombinationer Příklady kombinací Przykłady połączeń

- Embroidery patterns on these pages are illustration images, which may be different from the patterns in your machine.
- Broderimønstrene på disse sider er illustrationsbilleder, som kan være forskellige fra mønstrene i din maskine.
- Az oldalakon látható hímzsminták csak illusztrációk, s különbözhetnek az Ön gépében található mintáktól.
- Modelele de broderie din aceste pagini sunt imagini ilustrate care pot fi diferite de modelele din mașina dumneavoastră.
- Broderimönstren på dessa sidor är illustrationer som kan skilja sig från mönstren i din maskin.
- Vyšivací vzory na těchto stranách jsou ilustrované obrázky, které se mohou lišit od vzorů ve vašem stroji.
- Wzory haftu przedstawione na tych stronach są ilustracjami i mogą różnić się od wzorów zapisanych w hafciarce.



No.3 +



No.4 +

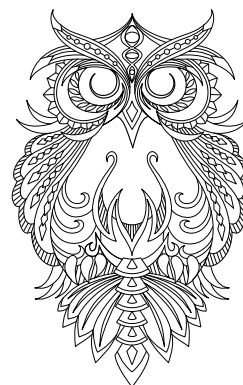

No.5 = (900)



No.3 + No.5 × 2



No.16 × 2 + No.17 × 2



No.8 + No.9 × 2



No.3 × 2

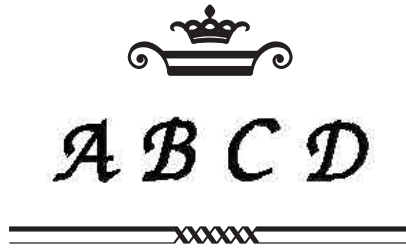
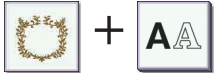

No.14 + No.15



No.12 × 2

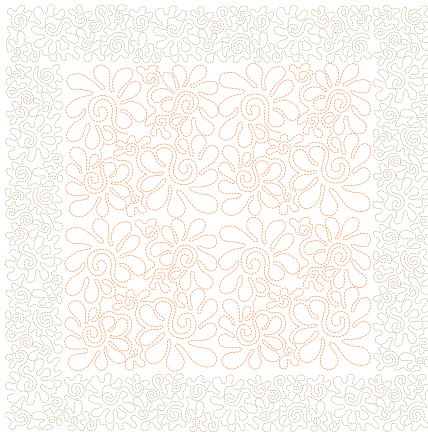

No.2 × 4 + No.14 × 12

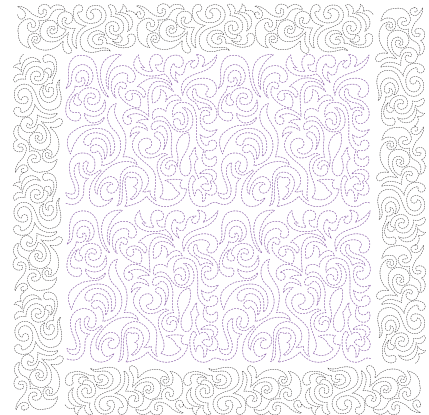

No.8 × 4 + No.16 × 12

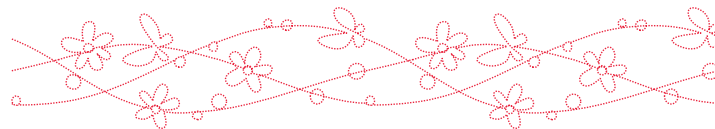

No.17 × 2



No.2 + No.27 × 2



No.6 + No.10 + No.19



No.2 + No.28 × 2

# Create 3D embroidery Lav 3D-broderi 3D hímzés létrehozása Creare broderie 3D

# Skapa 3D-broderi Tvorba 3D výšivky Tworzenie haftu 3D

You can make 3D embroidery by using urethane foam for embroidery. Refer to the operation manual for the embroidery machine for details on how to embroider 3D font.

Du kan lave 3D-broderier ved at bruge mossgummi til broderi. Se brugsanvisningen til broderimaskinen for at få oplysninger om brodering af 3D-skriftyper.

3D hímzést készíthet hímzéshez való uretánhab felhasználásával. A 3D betűtípus hímzéssel kapcsolatos részletekért olvassa el a hímzőgép használati utasítását.

Puteți realiza broderii 3D utilizând spumă uretanică pentru brodat. Consultați manualul de utilizare al mașinii de brodat pentru detalii despre brodarea fonturilor 3D.

Du kan skapa 3D-broderier genom att använda mossgummi för broderi. Information om hur du broderar 3D-font finns i brodermaskinens bruksanvisning.

3D výšivku můžete vytvářet pomocí polyuretanové pěny pro vyšívání. Podrobnosti o vyšívání 3D fontu najdete v uživatelské příručce vyšívacího stroje.

Haft 3D możesz wykonać dzięki użyciu pianki poliuretanowej do haftowania. Aby uzyskać informacje na temat haftowania czcionek 3D, zapoznaj się z instrukcją obsługi hafciarki.

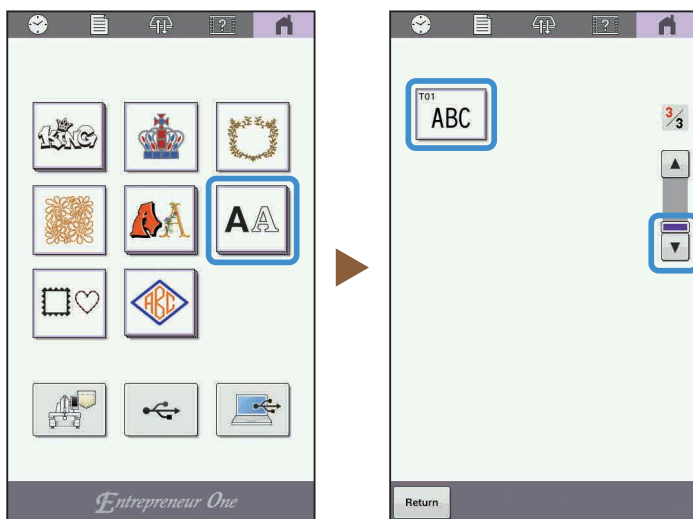

Instruction Video  
Instruktionsvideo  
Instruktionsvideo  
Instruktážní video  
Oktatóvideó  
Film instruktażowy  
Instrucțiuni video



<https://s.brother/cvcab/>

- \* We recommend that flat brim cap frame (sold separately) be used for embroidering caps. Visit our website <https://s.brother/cocab/>.
- \* Vi rekommenderar att ramen för keps med platt skärm (säljs separat) används vid brodering av kepsar. Besök vår webbplats <https://s.brother/cocab/>.
- \* Vi anbefaler, at der vælges en kasketramme med flad skygge (sælges separat) til brodering på kasketter. Besøg vores websted <https://s.brother/cocab/>.
- \* K vyšívání čepic doporučujeme používat rámeček na plochou krepku (v prodeji samostatně). Navštivte naše webové stránky <https://s.brother/cocab/>.
- \* A sapkák hímzéséhez javasoljuk a (külön megvásárolható) lapos simléderes sapkákhoz használható keret használatát. Látogasson el weboldalunkra <https://s.brother/cocab/>.
- \* Do haftowania na czapkach zalecamy użycie płaskiej ramki do mocowania czapek z daszkiem (do nabycia osobno). Odwiedź naszą witrynę internetową <https://s.brother/cocab/>.
- \* Vă recomandăm să utilizați gherghelul pentru șepci cu boruri plate (vândut separat) la brodarea șepcilor. Vizitați site-ul nostru web <https://s.brother/cocab/>.



Font Name Chart  
 Skema over skrifttypenavne  
 Betűtípus-névtáblázat  
 Diagrama cu numele fonturilor

Tabell över namn på teckensnitt  
 Tabulka s názvy písem  
 Tabela nazw czcionek

1		Künstlerschreibschrift
2		Block 01
3		Serif 01
4		Brussels Demi Outline
5		Tennessee ExtraBold
6		Brussels Light
7		Serif 02
8		Calgary MediumItalic
9		Maryland
10		Vermont
11		Dalliance Script
12		Sicilia Light Italic (Sicilia)
13		Luedickital
14		Toms Handwritten
15		Bergen
16		Tirol
17		Istanbul
18		San Diego

19		Los Angeles
20		Saipan
21		Gothic 01
22		Bayern Book
23		Florida Medium
24		Lillehammer
25		Dalliance Roman
26		Helsinki Nallow S*
27		Riesa S*
28		Germany S*
29		Script 01 SR*
30		Block 01*
31		Utah Bold Cyrillic
32		PC Tennessee Bold Cyrillic
33		Letter Gothic Bold

- \*Small font
- \*Liten font
- \*Lille skrifttype
- \*Malé písmo
- \*Kis betűtípus
- \*Mała czcionka
- \*Font mic





English  
Swedish  
Danish  
Czech  
Hungarian  
Polish  
Romanian  
882-T52



D02P4D-001