

©Copyright 2010 BROTHER INDUSTRIES, LTD.

ESC/P commands

Version 1.20

Model Name Specifications Study: TD-4000/4100N

<Written By> Brother Industries, Ltd.

Machine Model: TD-4000/TD-4100N

IMPORTANT - PLEASE READ CAREFULLY

This documentation ("Documentation") gives you information that will assist you in controlling your Machine Model.

You may use the Documentation only if you first agree to the following conditions.

If you do not agree to the following conditions, you may not use the Documentation.

Condition of Use

You may use and reproduce the Documentation to the extent necessary for your own use of your Machine Model ("Purpose"). Unless expressly permitted in the Documentation, you may not;

- (i) copy or reproduce the Documentation for any purpose other than the Purpose,
- (ii) modify, translate or adapt the Documentation, and/or redistribution to any third party,
- (iii) rent or lease the Documentation to any third party, or,
- (iv) remove or alter any copyright notices or proprietary rights legends included within the Documentation.

No Warranty

- a. Any updates, upgrades or alteration of the Documentation or Machine Model will be performed at the sole discretion of Brother. Brother may not respond to any request or inquiry about the Documentation.
- b. THIS DOCUMENTATION IS PROVIDED TO YOU "AS IS" WITHOUT WARRANTY OF ANY KIND, WHETHER EXPRESS OR IMPLIED, INCLUDING, BUT NOT LIMITED TO, THE IMPLIED WARRANTY OF FITNESS FOR A PARTICULAR PURPOSE. BROTHER DOES NOT REPRESENT OR WARRANT THAT THIS DOCUMENTATION IS FREE FROM ERRORS OR DEFECTS.
- c. IN NO EVENT SHALL BROTHER BE LIABLE FOR ANY DIRECT, INDIRECT, PUNITIVE, INCIDENTAL, SPECIAL, CONSEQUENTIAL DAMAGES OR ANY DAMAGES WHATSOEVER, ARISING OUT OF THE USE, INABILITY TO USE, OR THE RESULTS OF USE OF THE DOCUMENTATION OR ANY SOFTWARE PROGRAM OR APPLICATION YOU DEVELOPED IN ACCORDANCE WITH THE DOCUMENTATION.

[Contents]

Control Code List	7
Print area.....	10
Characters	12
Print position.....	15
Line feed amount.....	17
Document creation flow	18
Control command details	20
• Character/style selection commands	20
ESC R Select international character set	20
ESC q Select character style	21
ESC k Select font	22
ESC t Select character code table	22
• Text printing commands	23
ESC 4 Apply italic style	23
ESC 5 Cancel italic style	23
ESC E Apply bold style	24
ESC F Cancel bold style	24
ESC G Apply double-strike printing	25
ESC H Cancel double-strike printing	25
ESC P Specify pica pitch.....	26
ESC M Specify elite pitch	27
ESC g Specify micron pitch	28
ESC p Specify proportional characters	29
ESC W Specify double width characters.....	30
SO Specify auto-cancelling enlarged characters.....	31
ESC SO Specify auto-cancelling enlarged characters	31
SI Specify reduced characters	32
ESC SI Specify reduced characters	32
DC2 Cancel reduced characters	32
DC 4 Cancel auto-cancelling double-width characters.....	33
ESC – Applies/cancels underlining	34
ESC ! Global formatting	36
ESC SP Specify character spacing	37
ESC X Specify character size.....	38

- **Line feed commands**..... 39
 - ESC 0 Specify line feed of 1/8 inch 39
 - ESC 2 Specify line feed of 1/6 inch 39
 - ESC 3 Specify minimum line feed 39
 - ESC A Specify line feed of n/60 inch..... 40
- **Horizontal direction movement commands** 41
 - ESC l Specify left margin 41
 - ESC Q Specify right margin 44
 - CR Carriage return 46
 - ESC D Specify horizontal tab position 47
 - HT Apply horizontal tab 48
 - ESC \$ Specify absolute horizontal position 49
 - ESC \ Specify relative horizontal position 49
 - ESC a Specify alignment 50
- **Vertical movement commands** 51
 - LF Line feed 51
 - FF Page feed..... 51
 - ESC J Forward paper feed 52
 - ESC B Specify vertical tab position 53
 - VT Apply vertical tab 54
 - ESC (V Specify absolute vertical position..... 55
 - ESC (v Specify relative vertical position..... 56
- **Paper formatting** 57
 - ESC (c Specify page format 57
 - ESC (C Specify page length..... 58
- **Printer control commands** 59
 - ESC @ Initialize 59
- **Graphics commands** 60
 - ESC * Select bit image..... 60
 - ESC K 8-dot standard-density bit image 65
 - ESC L 8-dot double-density bit image..... 67
 - ESC Y 8-dot double-speed double-density bit image 68
 - ESC Z 8-dot quadruple-density bit image..... 68
- **Advanced commands**..... 69
 - ESC i B Bar code 69
 - ESC i Q 2D Bar code QR codes..... 73
 - ESC i P QR code version setting 76

ESC i V 2D bar code PDF417	77
ESC i D 2D bar code DataMatrix control.....	80
ESC i M 2D bar code MaxiCode control.....	83
ESC i F Print downloaded data.....	85
ESC i a Switch command mode.....	89
ESC i S Request printer status	90
ESC i L Select landscape orientation.....	92
ESC i C Specify cutting.....	93
ESC iXQ2 Select default character style	94
ESC iXQ1 Retrieve default character style	95
ESC iXk2 Select default font.....	96
ESC iXk1 Retrieve default font.....	97
ESC iXX2 Specify default character size	98
ESC iXX1 Retrieve default character size	99
ESC iX32 Specify default line feed.....	100
ESC iX31 Retrieve default line feed.....	101
ESC iXA2 Select default alignment	102
ESC iXA1 Retrieve default alignment	103
ESC iX(2 Specify default page length	104
ESC iX(1 Retrieve default page length	105
ESC iXL2 Select default landscape orientation.....	106
ESC iXL1 Retrieve default landscape orientation.....	107
ESC iXj2 Select default international character set	108
ESC iXj1 Retrieve default international character set	109
ESC iXm2 Select default character code table	110
ESC iXm1 Retrieve default character code table	111
• Character codes.....	112
Standard character code table for ESC/P codes.....	112
Eastern European character code table (Windows-1250)	113
Western European character code table (Windows 1252)	114
International character set.....	115

Introduction

This material provides the necessary information for directly controlling TD-4000/4100N. This information is provided assuming that the user has full understanding of the operating system being used and basic mastery of RS-232C, USB or Ethernet in a developer's environment.

We accept no responsibility for any problems caused by programs that you develop using the information provided in this material, affecting software, data or hardware, including the TD-4000/4100N, and any problems resulting directly or indirectly from them. Use this material only if you accept these terms.

This material shall not be reproduced, in part or in full, without prior approval. In addition, this material shall not be used as evidence in a lawsuit or dispute in a way that is unfavorable towards our company.

These ESC/P commands have been adapted specifically for this company.

Control Code List

Character/style selection

ESC R	1B 52	Select international character set
ESC q	1B 71	Select character style
ESC k	1B 6B	Select font
ESC t	1B 74	Select character code table

Text printing

ESC 4	1B 34	Apply italic style
ESC 5	1B 35	Cancel italic style
ESC E	1B 45	Apply bold style
ESC F	1B 46	Cancel bold style
ESC G	1B 47	Apply double-strike printing
ESC H	1B 48	Cancel double-strike
ESC P	1B 50	Specify pica pitch (10 cpi)
ESC M	1B 4D	Specify elite pitch (12 cpi)
ESC g	1B 67	Specify micron pitch
ESC p	1B 70	Specify proportional characters
ESC W	1B 57	Specify double-width characters
SO	0E	Specify auto-cancelling enlarged characters
ESC SO	1B 0E	Specify auto-cancelling enlarged characters
SI	0F	Specify reduced characters
ESC SI	1B 0F	Specify reduced characters
DC2	12	Cancel reduced characters
DC4	14	Cancel auto-cancelling double-width characters
ESC -	1B 2D	Apply/cancel underlining
ESC !	1B 21	Global formatting
ESC SP	1B 20	Specify character spacing
ESC X	1B 58	Specify character size

Line feeds

ESC 0	1B 30	Specify line feed of 1/8 inch
ESC 2	1B 32	Specify line feed of 1/6 inch
ESC 3	1B 33	Specify minimum line feed.
ESC A	1B 41	Specify line feed of n/60 inch

Horizontal direction movement

ESC I	1B 6C	Specify left margin.
ESC Q	1B 51	Specify right margin.
CR	0D	Carriage return
ESC D	1B 44	Specify horizontal tab position
HT	09	Apply horizontal tab
ESC \$	1B 24	Specify absolute horizontal position
ESC \	1B 5C	Specify relative horizontal position
ESC a	1B 61	Specify alignment

Vertical movement

LF	0A	Line feed
FF	0C	Page feed
ESC J	1B 4A	Forward paper feed
ESC B	1B 42	Specify vertical tab position
VT	0B	Apply vertical tab
ESC (V	1B 28 56	Specify absolute vertical position.
ESC (v	1B 28 76	Specify relative vertical position.

Paper formatting

ESC (c	1B 28 63	Specify page format.
ESC (C	1B 28 43	Specify page length

Printer control

ESC @	1B 40	Defaults
-------	-------	----------

Graphic commands

ESC *	1B 2A	Select a bit image.
ESC K	1B 4B	8-dot single-density bit image
ESC L	1B 4C	8-dot double-density bit image
ESC Y	1B 59	8-dot double-speed double-density bit image
ESC Z	1B 5A	8-dot quadruple-density bit image

Advanced commands

ESC i B	1B 69 42	Bar code
ESC i Q	1B 69 51	2D bar code QR codes
ESC i P	1B 69 50	QR code version setting
ESC i V	1B 69 56	2D bar codes PDF417
ESC i D	1B 69 44	2D bar code data matrix
ESC i M	1B 69 4D	2D bar code MaxiCode
ESC i F	1B 69 46	Print downloaded data
ESC i a	1B 69 61	Switch command mode
ESC i S	1B 69 53	Request printer status
ESC i L	1B 69 4C	Select landscape orientation
ESC i C	1B 69 43	Specify cutting

Advanced static commands

ESC iXQ2	1B 69 58 51 32	Select default character style
ESC iXQ1	1B 69 58 51 31	Retrieve default character style
ESC iXk2	1B 69 58 6B 32	Select default font
ESC iXk1	1B 69 58 6B 31	Retrieve default font
ESC iXX2	1B 69 58 58 32	Specify default character size
ESC iXX1	1B 69 58 58 31	Retrieve default character size
ESC iX32	1B 69 58 33 32	Specify default line feed
ESC iX31	1B 69 58 33 31	Retrieve default line feed
ESC iXA2	1B 69 58 41 32	Select default alignment
ESC iXA1	1B 69 58 41 31	Retrieve default alignment
ESC iX(2	1B 69 58 28 32	Specify default page length
ESC iX(1	1B 69 58 28 31	Retrieve default page length
ESC iXL2	1B 69 58 4C 32	Select default landscape orientation
ESC iXL1	1B 69 58 4C 31	Retrieve default landscape orientation
ESC iXj2	1B 69 58 6A 32	Select default international character set
ESC iXj1	1B 69 58 6A 31	Retrieve default international character set
ESC iXm2	1B 69 58 6D 32	Select default character code table
ESC iXm1	1B 69 58 6D 31	Retrieve default character code table

Print area

The printing media are die-cut labels and continuous length label.

The area that can physically be printed on depends on the size and type of the print media.

<<Die-cut>>

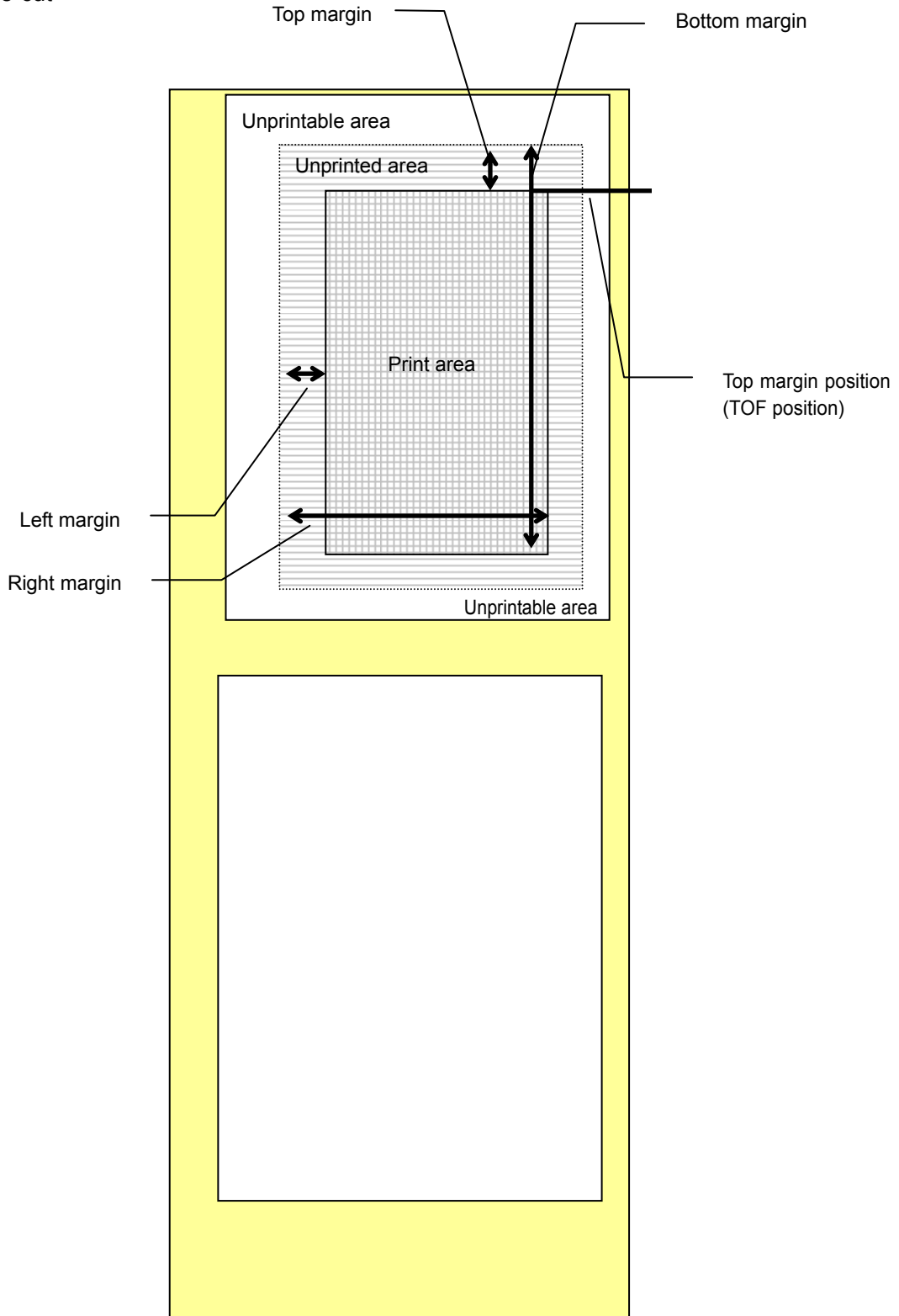

Below are the print areas for each media

Print area

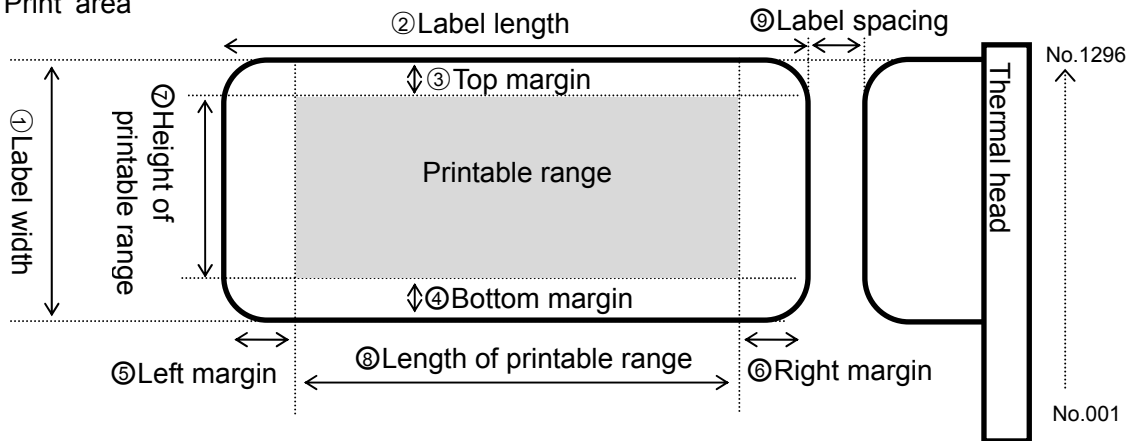

		Media ID.	①	②	③④	⑤⑥	⑦	⑧	⑨	Drive head No..
1	RD 51mm×26mm	01A6	50.8mm	25.6mm	1.5mm	3mm	47.8mm	19.6mm	3.0mm	677 ~ 1240
2	RD 76mm×26mm	01A5	76.2mm	25.6mm	1.5mm	3mm	73.2mm	19.6mm	3.0mm	377 ~ 1240
3	RD 102mm×50mm	01A3	101.6mm	49.9mm	1.5mm	3mm	98.6mm	43.9mm	3.0mm	77 ~ 1240
4	RD 102mm×152mm	01A4	101.6mm	152.4mm	1.5mm	3mm	98.6mm	146.4mm	6.3mm	77 ~ 1240
5	RD 102mm	019F	101.6mm	-	1.5mm	3mm	98.6mm	-	-	77 ~ 1240

The maximum length of continuous length label is 1 meter.

Characters

This system uses single-byte character codes and is installed with five bit-map fonts (Brougham, Letter Gothic bold, Brussels, Helsinki, and San Diego), and 3 out-line fonts (Letter Gothic, Brussels and Helsinki).

Fixed pitch or proportional pitch (PS pitch) can be specified for any of the fonts.

However, there are fonts that are better with a fixed pitch and fonts that are better with a proportional pitch (PS pitch).

Fixed pitch fonts are: Brougham, Letter Gothic and Letter Gothic Bold.

Proportional pitch fonts are: Brussels, Helsinki, and San Diego.

Each bit-map font has three sizes: 24 dots, 32 dots, and 48 dots.

Each out-line font has 22 sizes: 33 dots-400 dots.

Character sizes

Each font is available in full size, reduced size (half width), double width, double height and half width, double height, and quadruple size.

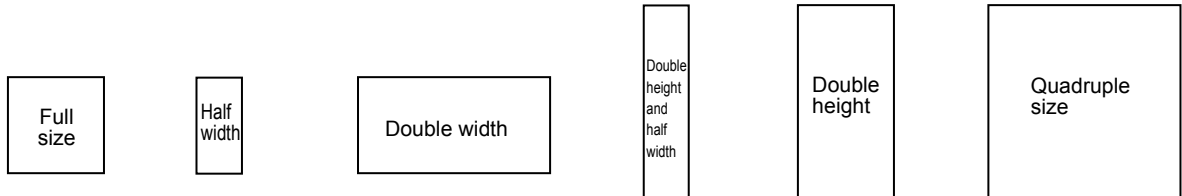

The actual character size is slightly smaller than the nominal size (the parameter value received with the size command). (This varies depending on the font.)

Nominal (dots)	24	32	48
Height (dots)	21	28	44
Width (dots)	11	16	26

The above example is for Brougham (full size, no character styles applied)

The line-drawing characters (J L | - | + T T T , etc.) and shaded characters have the Brougham font applied regardless of the specified font and pitch setting (proportional or fixed).

Pitch

Pitch refers to the spacing between neighboring characters.

When characters are arranged with a fixed pitch, they will be evenly spaced.

If characters extend over several lines, they will align in straight rows.

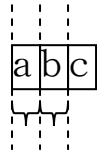

Fixed spacing

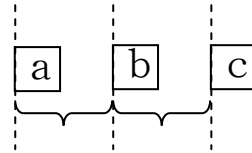

Fixed spacing

When characters are arranged with a proportional pitch, the spacing will vary depending on the character.

(For example, "W" is wide but "I" is narrow.)

As a result, the excess space between characters is eliminated and the text appears more compact.

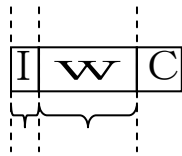

Variable spacing

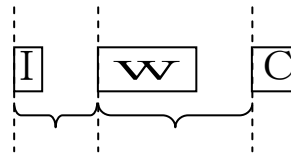

Variable spacing

If a fixed pitch is applied to a font that is better with a proportional pitch, all characters are given the same width as the widest character in the font.

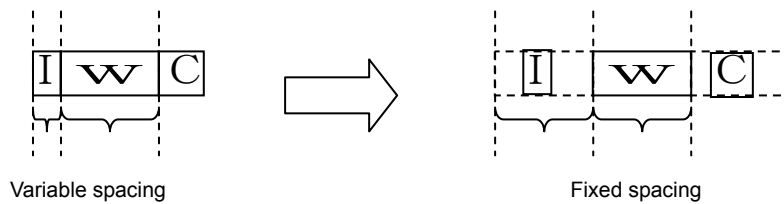

Variable spacing

Fixed spacing

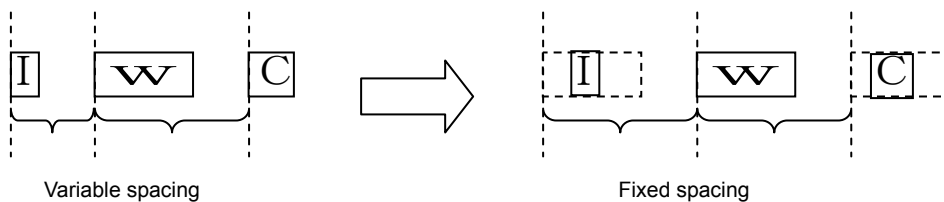

Variable spacing

Fixed spacing

This makes it possible to evenly space the characters of a proportional-pitch font without having to change the font.

If a proportional pitch is applied to a font that is better with a fixed pitch, all characters are given the same width, appearing the same as with a fixed pitch.

Print position

The print position is the standard position for printing characters, bitmaps, and bar codes. There is a horizontal print position and vertical print position, which are the reference points for vertical position movement and horizontal position movement.

Characters are arranged with their top edges aligned with the print position. The baseline of each character is the bottom edge of the character, regardless of size, font, etc.

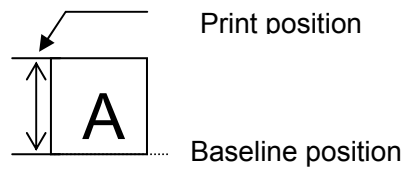

All characters on a single line are printed at baseline positions that are the same for each character.

When characters of different heights are mixed together, they are aligned with the baseline of the tallest character on the line.

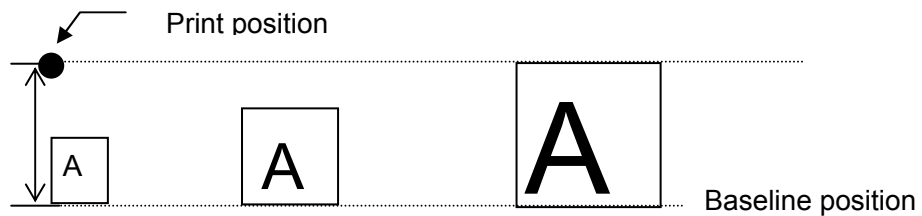

Underlines are drawn 4 dots below the baseline position.

Bitmaps, bar codes, downloaded images

These types of image data are treated in the same way as characters and are printed with the bottom edge of the image aligned with the baseline.

Same line

- Characters and images are considered to be on the same line, even if tabs are inserted.
- Horizontal movement to the right between characters or images is regarded as being on the same line, however horizontal movement to the left is regarded as being on separate lines if wrapping occurs.

Line feed amount

The amount of line feed is the amount of vertical movement from the print position of one line to the print position of the next line.

HHHHHHHHHHHHHHH
HHHHHHHHHHHHHHH
HHHHHHHHHHHHHHH

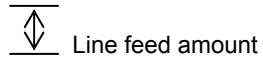

The line feed amount is set with ESC 0, ESC 2, ESC A, and ESC 3.

- Within the same line of text, the tallest character is determined and the baseline is moved so that the top edge of that character is at the vertical print position.
- The tallest character on that line becomes the line height.
- If there is underlining, 4 dots are added to the line height.
- If the line height is greater than the set line feed amount, the line height is used as the actual line feed amount.

In this way, even if the set for line feed amount is small, the upper and lower lines will not overlap.

Document creation flow

Below is an explanation of the flow for creating documents.

A Switch command mode (ESC i a) Initialize (ESC @)

```
graph TD; A["A Switch command mode (ESC i a) Initialize (ESC @)"] --> B["B Format Settings"]; B --> C["C Print Operations"];
```

B Format Settings

1. Select landscape orientation (ESC i L)
2. Specify page length (ESC (C)
3. Specify print area
 - Specify page format (ESC (c)
 - Left/right margins (ESC I, ESC Q)
4. Specify line feed amount (ESC 0, ESC 2, ESC 3, ESC A)
5. Specify tab positions
 - Specify horizontal tab position (ESC D)
 - Specify vertical tab position (ESC B)

C Print Operations

1. Specify print position
 - Specify vertical position (ESC (v, ESC (V, VT, ESC J)
 - Specify horizontal position (ESC \$, ESC \, HT, ESC a)
2. Transfer print data (one line)
 - Transfer necessary text operation codes (see D), bit images, bar codes, and downloaded data (see E).
3. End of line, feed paper (CR, LF)
4. Repeat 1–3 above.
5. End of page, specify cutting (ESC i C), feed page (FF)
6. Repeat 1–6 above.
7. End of document

D Text operations

1. Specify character set
 - Select font (ESC k)
 - Select character code (ESC t)
 - Select international character set (ESC R)
 - Specify character size (ESC X)
 - Character spacing (ESC P, ESC M, ESC g, ESC SP)
2. Character style (ESC 4, ESC 5, ESC E, ESC F, ESC G,
ESC H, ESC W, SO, ESC SO, SI, ESC SI
DC2, DC4, ESC -, ESC !)
3. Character code

Repeat 1–3 above as necessary.

E Bit image (ESC *, ESC K, ESC L, ESC Y, ESC Z)

Bar code (ESC i B)

2D bar code (ESC i Q, ESC i V, ESC i D, ESC i M)

Downloaded data (ESC i F)

Downloaded image data must first be downloaded and saved on the main unit.

Control command details

Character/style selection commands

ESC R Select international character set
--

[ASCII] ESC R n

[Decimal] 27 82 n

[Hexadecimal] 1B 52 n

[Parameters] 0 ≤ n ≤ 13,64

[Description]

- Selects the international character set and changes some of the character codes in the code table according to the value of n.

n=0: U.S.A.

n=1: France

n=2: Germany

n=3: U.K.

n=4: Denmark

n=5: Sweden

n=6: Italy

n=7: Spain

n=8: Japan

n=9: Norway

n=10: Denmark II

n=11: Spain II

n=12: Latin America

n=13: South Korea

n=64: Legal

- The following 12 codes are changed.
23h,24h,40h,5Bh,5Ch,5Dh,
5Eh, 60h, 7Bh, 7Ch, 7Dh, 7Eh

- The default setting is n = 0 (U.S.A.)

[Example]

Code

5Ch ESC R 08h 5Ch FF

Print result

\ ¥

ESC q Select character style

[ASCII] ESC q n

[Decimal] 27 113 n

[Hexadecimal] 1B 71 n

[Parameters] 0 ≤ n ≤ 3

[Description]

- Selects the character style.
 - n=0: Cancel (normal characters)
 - n=1: Outline
 - n=2: Shadow
 - n=3: Shadow and outline

[Example]

Code

ABC ESC q 02h ABC ESC q 00h ABC FF

Print result

ABCABCABC

ESC k Select font

[ASCII] ESC k n

[Decimal] 27 107 n

[Hexadecimal] 1B 6B n

[Parameters] $0 \leq n \leq 4, 9 \leq n \leq 11$

[Description]

- Selects the font.

 <Bit-map fonts>

 n=0 ...Brougham (fixed pitch)

 n=1 ...Letter Gothic bold (fixed pitch)

 n=2 ...Brussels (proportional pitch)

 n=3 ...Helsinki (proportional pitch)

 n=4 ...San Diego (proportional pitch)

 <Out-line fonts>

 n=9 ...Letter Gothic(fixed pitch)

 n=10...Brussels(proportional pitch)

 n=11 ... Helsinki(proportional pitch)

- The default value is n=0 Brougham (fixed pitch).
- In case font is changed from bit-map fonts to out-line fonts, character size is changed to default setting(42dots).
- In case font is changed from out-line fonts to bit-map fonts, character size is changed to default setting(32dots).

ESC t Select character code table

[ASCII] ESC t n

[Decimal] 27 116 n

[Hexadecimal] 1B 74 n

[Parameters] n=0,1,2

[Description]

- From the three built-in character code tables, selects the character code table used.
- n=0: Standard character code table
- n=1: Eastern European character code table
- n=2: Western European character code table
- n=3: (Spare)
- The default setting is n = 0.

Text printing commands

ESC 4 Apply italic style

[ASCII] ESC 4

[Decimal] 27 52

[Hexadecimal] 1B 34

[Parameters] None

[Description]

- Applies italic character style.
- This command is valid anywhere in a text line.

ESC 5 Cancel italic style

[ASCII] ESC 5

[Decimal] 27 53

[Hexadecimal] 1B 35

[Parameter] None

[Description]

- Cancels italic character style.
- This command is valid anywhere in a text line.

[Example]

Code

ABC ESC 4 DEF ESC 5 GHI FF

Print result

*ABCDEF*GHI

ESC E Apply bold style

[ASCII] ESC E

[Decimal] 27 69

[Hexadecimal] 1B 45

[Parameters] None

[Description]

- Prints subsequent print data bold.
- This command is valid anywhere in a text line.

ESC F Cancel bold style

[ASCII] ESC F

[Decimal] 27 70

[Hexadecimal] 1B 46

[Parameters] None

[Description]

- Cancels the bold style.
- This command is valid anywhere in a text line.

[Example]

Code

ABC ESC E DEF ESC F GHI FF

Print result

ABC**DE**FGHI

ESC G Apply double-strike printing

[ASCII] ESC G

[Decimal] 27 71

[Hexadecimal] 1B 47

[Parameters] None

[Description]

- Prints subsequent print data bold.
- This command is valid anywhere in a text line.

ESC H Cancel double-strike printing

[ASCII] ESC H

[Decimal] 27 72

[Hexadecimal] 1B 48

[Parameters] None

[Description]

- Cancels bold style.
- This command is valid anywhere in a text line.

[Example]

Code

ABC ESC G DEF ESC H GHI FF

Print result

ABC**DE**FGHI

ESC P Specify pica pitch

[ASCII] ESC P
 [Decimal] 27 80
 [Hexadecimal] 1B 50
 [Parameters] None

[Description]

- Prints subsequent data with pica pitch (10 characters/inch).
- The character spacing is 30 dots (=300 dots/10 characters).
- If the character width is 30 dots or less, the character spacing is set to 30 minus the character width.
- If the character width exceeds 30 dots, the character spacing is set to the character width. (The space between characters is 0 dot.)

In this case, the pitch does not exactly equal the pica pitch.

- With double-width characters, the character spacing is doubled (60 dots).
- With half-width characters, the character spacing is cut in half (15 dots).
- When the character spacing is changed with ESC SP, the setting is updated.
- This command is invalid when proportional pitch is selected.
- In out-line fonts, the space between character is 0 dot.

Setting (dots)		Full width			Double width			Half width		
		24	32	48	24	32	48	24	32	48
Width (dots)	Brougham	11	16	26	22	32	52	6	8	13
	Letter Gothic bold	10	14	22	20	28	44	5	7	11
	Brussels	25	35	56	50	70	112	13	18	28
	Helsinki	21	28	44	42	56	88	11	14	22
	San Diego	24	35	57	48	70	114	12	18	29

The above table refers to characters with a fixed pitch. (Applying styles may increase the size.)

[Example] For a 24-dot font at full width

Full width

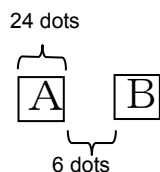

Double width

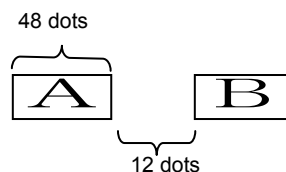

ESC M Specify elite pitch

[ASCII] ESC M

[Decimal] 27 77

[Hexadecimal] 1B 4D

[Parameters] None

[Description]

- Prints subsequent data with elite pitch (12 characters/inch).
- Character width is 25 dots (=300 dots/12 characters).
- If the character width is 25 dots or less, the character spacing is set to 25 minus the character width.
- If the character width exceeds 25 dots, character spacing is set to character width. (Character spacing is 0 dot.)

In this case, the pitch does not exactly equal the pica pitch.

- With double-width characters, the character spacing is doubled (50 dots).
- With half-width characters, the character spacing is reduced to 13 dots.
- When the character spacing is changed with ESC SP, the setting is updated.
- This command is invalid when proportional pitch is selected.
- In out-line fonts, the space between character is 0 dot.

[Example] For a 24-dot font at full width

Full width

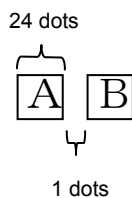

Double width

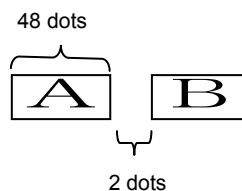

ESC g Specify micron pitch

[ASCII] ESC g

[Decimal] 27 103

[Hexadecimal] 1B 67

[Parameters] None

[Description]

- Prints subsequent data with micron pitch (15 characters/inch).
- Character spacing is 20 dots (=300dots/15 characters).
- If the character width is 20 dots or less, character spacing is set to 20 minus the character width.
- If the character width exceeds 20 dots, character spacing is set to character width. (The character spacing is 0 dot.)

In this case, the pitch does not exactly equal the micron pitch.

- With double-width characters, the character spacing is doubled (40 dots).
- With half-width characters, the character spacing is reduced to 10 dots.
- When the character spacing is changed with ESC SP, the setting is updated.
- This command is invalid when proportional pitch is selected.
- In out-line fonts, the space between character is 0 dot.

[Example] For an 11-dot font at full width

Full width

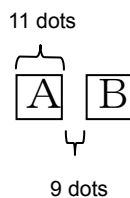

Double width

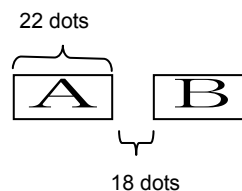

ESC p Specify proportional characters

[ASCII] ESC p n

[Decimal] 27 112 n

[Hexadecimal] 1B 70 n

[Parameters] n=0,1,48("0"),49("1")

[Description]

- Specifies proportional characters.
- n=1 or 49("1") applies proportional characters.
- n=0 or 48("0") cancels proportional characters.

- When proportional characters are specified, the character spacing set with ESC SP is retained as is.

ESC W Specify double width characters

[ASCII] ESC W n

[Decimal] 27 87 n

[Hexadecimal] 1B 57 n

[Parameters] n=0,1 or 48("0"),49("1")

[Description]

- Specifies double-width characters.
- n = 1 or 49("1") specifies double-width characters.
- n = 0 or 48("0") cancels double-width characters.
- Double-width characters specified with this code is not cancelled with the DC4 or FS DC4 code or line feed.
- Canceling double width characters mode will also cancel half width mode.

[Example]

Code

ABC ESC W 1 ABC ESC W 0 ABC FF

Print result

ABC**ABC**ABC

SO Specify auto-cancelling enlarged characters

[ASCII] SO

[Decimal] 14

[Hexadecimal] 0E

[Parameters] None

[Description]

- Prints subsequent data at double width.
- This mode is cancelled with DC4, LF, VT, FF, or an automatic line feed.
- This mode is cancelled with ESC \$ or ESC \.
- This mode can also be cancelled with ESC W+0.

ESC SO Specify auto-cancelling enlarged characters

[ASCII] ESC SO

[Decimal] 27 14

[Hexadecimal] 1B 0E

[Parameters] None

[Description]

- Same as SO

[Example]

Code

ABC ESC SO ABCDEFGHIJK...XYZ FF

Print result

ABC**ABCDEFGHIJK**... (Automatic line feed)

XYZ

SI Specify reduced characters

[ASCII] SI
[Decimal] 15
[Hexadecimal] 0F
[Parameters] None
[Description]

- Prints subsequent data at half width.

ESC SI Specify reduced characters

[ASCII] ESC SI
[Decimal] 27 15
[Hexadecimal] 1B 0F
[Parameters] None
[Description]

- Same as SI

DC2 Cancel reduced characters

[ASCII] DC2
[Decimal] 18
[Hexadecimal] 12
[Parameters] None
[Description]

- Cancels reduced characters specified with SI.

DC 4 Cancel auto-cancelling double-width characters

[ASCII] DC4

[Decimal] 20

[Hexadecimal] 14

[Parameters] None

[Description]

- Cancels double-width characters specified with ESC SO or SO.
- Does not cancel a setting made with ESC W.

[Example]

Code

ABC ESC SO ABCDEF DC4 GHIJK FF

Print result

ABC**ABCDEF**GHIJK

ESC – Applies/cancels underlining

[ASCII] ESC - n

[Decimal] 27 45 n

[Hexadecimal] 1B 2D n

[Parameters] n=0,1,2,3,4 or 48("0"),49("1"),50("2"),51("3"),52("4")

[Description]

Applies or cancels underlining.

- . n = 4 or 52("4") applies 4-dot-wide underlining.
- . n = 3 or 51("3") applies 3-dot-wide underlining.
- . n = 2 or 50("2") applies 2-dot-wide underlining.
- . n = 1 or 49("1") applies 1-dot-wide underlining.
- . n = 0 or 48("0") cancels underlining.
- . This command is valid anywhere in a text line.
- . Underlining printed by this code forms a continuous underline.
 - Spaces between characters and words are also underlined.
 - Areas defined by specifying an absolute horizontal position (ESC \$) or relative horizontal position (ESC \) are not underlined.
 - 4/300 inch (4 dots) is added to the line feed amount for lines that include underlined characters.
 - With 1-dot-wide underlining, the underline is positioned as follows:
 - 2/300 inch (2 dots) below the characters
 - With 2-dot-wide underlining, the underline is positioned as follows:
 - Between 2/300 inch (2 dots)
 - and 3/300 inch (3 dots) below the characters
 - With 3-dot-wide underlining, the underline is positioned as follows:
 - Between 1/300 inch (1 dot)
 - and 3/300 inch (3 dots) below the characters
 - With 4-dot-wide underlining, the underline is positioned as follows:
 - Between 1/300 inch (1 dot)
 - and 4/300 inch (4 dots) below the characters

ABCDE ABCDE ABCDE
(1-dot width) (3-dot width)

[Example]

Code

ABC ESC - 1 ABC ESC - 0 ABC FF

Print result

ABCABCABC

ESC ! Global formatting

[ASCII] ESC ! n

[Decimal] 27 33 n

[Hexadecimal] 1B 21 n

[Parameters] 0 ≤ n ≤ 255

[Description]

- Specifies a combination of print modes.
- Specifies modes depending on the bit value of n.
- When the ESC ! code is used, a combination of multiple print modes can be specified at one time.
- The priority order is: Bit 5 > Bit 2
- Bit 0 is available only if Bit 1 is 0.
- Selected character styles are canceled, and the characters return to the normal style.
- Canceling double width characters mode will also cancel half width mode.

Bit	7	6	5	4	3	2	1	0
1	Underline	Italics	Double width	Double height	Bold	Reduced	Proportional	12 cpi
0	Cancel	Cancel	Cancel	Cancel	Cancel	Cancel	Cancel	10 cpi

[Example] Specifying underlining and double-width characters at the same time.

Code

ABC ESC ! A0h ABC ESC ! 00h ABC FF

Print result

ABCABCABC

ESC SP Specify character spacing

[ASCII] ESC SP n

[Decimal] 27 32 n

[Hexadecimal] 1B 20 n

[Parameters] $0 \leq n \leq 127$

[Description]

- Specifies the character spacing.
- n indicates the number of dots.
- The default setting is 0 dot.
- With double-width characters, the character spacing is doubled, with half-width characters, it is halved.

ESC X Specify character size

[ASCII] ESC X m nL nH

[Decimal] 27 88 m nL nH

[Hexadecimal] 1B 58 m nL nH

[Parameters] Character width : The value of m is irrelevant.
 character size:

 <Bit-map fonts> nL = 24, 32, 48 dots

 Available only when nH=0

 <Out-line fonts>

 nL=33, 38, 42, 46, 50, 58, 67, 75,

 nL=83, 92, 100, 117, 133, 150,

 nL=167, 200 233

 nH =0

 nL=11, 44, 77, 111, 144

 Available only when nH = 1

[Description]

- This command is used only to change the size.
- Outline must not be specified.
- Character width cannot be set.
- The character size is set to $n = nL + nH * 256$ dots.
- Width and height are the same.
- In case of bit-map fonts, only $n = 24, 32,$ and 48 are available. In case of out-line fonts, only $n = 33, 38, 42, 46, 50, 58, 67, 75, 83, 92, 100, 117, 133, 150, 167, 200, 233, 267, 300, 333, 367, 400$ are available.
- The commands for specifying enlarged characters, reduced characters, character spacing (SO, ESC W, ESC !, ESC SP) remain available.

[Example] ABC in 24-dot font and DEF in 48-dot font

Code

ESC X 00h 18h 00h ABC

ESC X 00h 30h 00h DEF FF

Print result

ABCDEF

Line feed commands

ESC 0 Specify line feed of 1/8 inch

[ASCII] ESC 0

[Decimal] 27 48

[Hexadecimal] 1B 30

[Parameters] None

[Description]

- . Specifies a line feed of 1/8 inch (about 0.32 cm).
- . Specifies a line feed of 38/300 inch (= 38 dots).

ESC 2 Specify line feed of 1/6 inch

[ASCII] ESC 2

[Decimal] 27 50

[Hexadecimal] 1B 32

[Parameters] None

[Description]

- . Specifies a line feed of 1/6 inch (about 0.42 cm).
- . Specifies a line feed of 50/300 inch (= 50 dots).

ESC 3 Specify minimum line feed

[ASCII] ESC 3 n

[Decimal] 27 51 n

[Hexadecimal] 1B 33 n

[Parameters] $0 \leq n \leq 255$

[Description]

- . Specifies a line feed of $n/300$ inch per line.
- . The line feed unit is 1 dot.

ESC A Specify line feed of n/60 inch

[ASCII] ESC A n

[Decimal] 27 65 n

[Hexadecimal] 1B 41 n

[Parameters] $0 \leq n \leq 255$

[Description]

- Specifies a line feed of n/60 inch.
- The line feed unit is 5 dots.

Horizontal direction movement commands

ESC I Specify left margin

[ASCII] ESC I n

[Decimal] 27 108 n

[Hexadecimal] 1B 6C n

[Parameters] $0 \leq n \leq 255$

$0 \leq \text{left margin} < \text{right margin}$

[Description]

- The left margin and the right margin use the left edge of the physically printable area as the reference.
- The space between the left edge of the physically printable area and the set number of columns is set as an unprinted area. The left margin position is the right edge of the specified column. (Character width * n)
- The setting is in the range $0 \leq (\text{character width} * n) \leq x$. Settings outside that range are ignored. However, x is a value dependent on the media.
- The area between the left edge (first column) to the nth column is specified as an unprinted area.
- The position of the left margin is the character width * n (at the time that the left margin is set) from the left edge.

The character width when specifying the margin includes the settings for specifying character spacing, character spacing for full-width characters or half-width characters. In addition, when pitches of 10 cpi (= 30 dots), 12 cpi (= 25 dots), or 15 cpi (= 20 dots), reduced characters, or double-width characters are specified, that character width is considered the unit.

However, increases in the character width due to character styles are not applied.

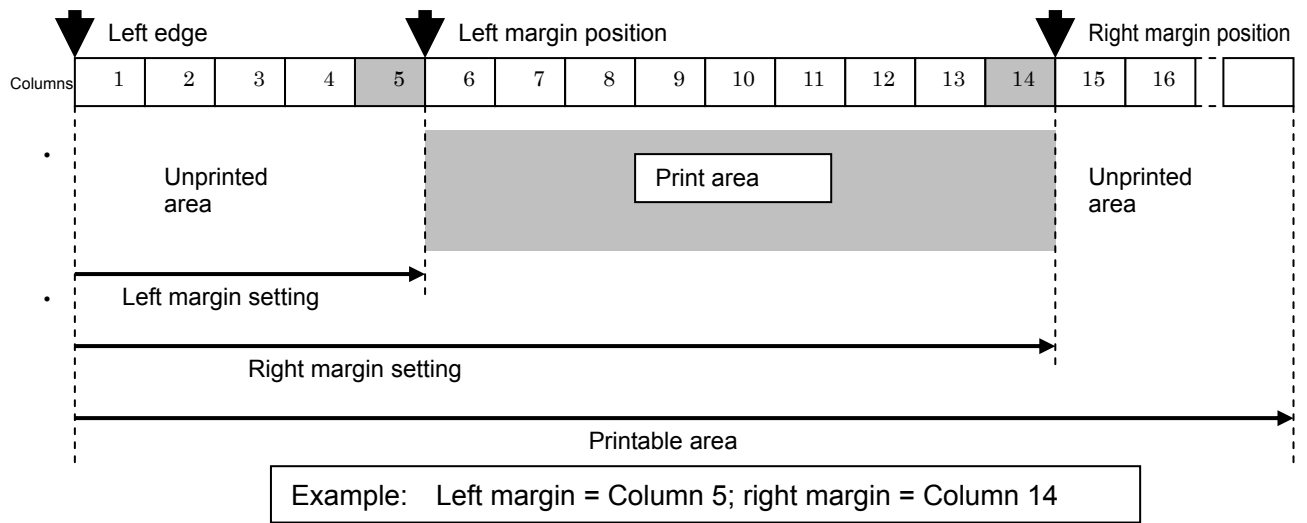

- The horizontal direction print position is moved to the left margin position.
- If the left margin setting is not at the beginning of the line, the left margin is set after a line feed.
The beginning of the line indicates the left margin position for left alignment; for right and center alignment, it means that no image or character is entered on the line.
- Even if the character width is changed after the left margin is set, the left margin position does not change.
- Any left margin setting that puts the left margin position to the right of the right margin position is ignored.
- When setting the left margin, set it at least one column (10 cpi = 30 dots) smaller than the right margin.
[(the character width * n at the setting) > (number of dots of right margin - 30 dots) --> the setting will be ignored.]
- If the difference between the right margin position and the left margin position is less than one character, that character is ignored.
- When proportional pitch is specified with the ESC p command, a character width of 10 cpi (= 30 dot) is applied.
- If the print media is continuous length label, the print direction is landscape, and the page length is not specified, commands specifying the left margin are ignored.

[Example] The left margin is set to Column 3.

Code

ABC CR ESC I 03h EFGHIJ FF

Print result

```

| ABC
|
|   EFGHIJ
|

```

ESC Q Specify right margin

[ASCII] ESC Q n

[Decimal] 27 81 n

[Hexadecimal] 1B 51 n

[Parameters] 1≤n≤255

Left margin < character width * n at time of setting ≤ printable area

[Description]

- The left margin and the right margin use the left edge of the physically printable area as the reference.
- The right margin position is the right edge of the set column. (Character width * n)
- The setting is in the range $0 \leq (\text{character width} * n) \leq x$. Settings outside that range are ignored. However, x is a value dependent on the media.
- Left margin ≤ print area < right margin
- The position of the right margin is the character width * n (at the time that the right margin is set) from the left edge.

The character width when specifying the margin includes the settings for specifying character spacing, character spacing for full-width characters or half-width characters. In addition, when pitches of 10 cpi (= 30 dots), 12 cpi (= 25 dots), or 15 cpi (= 20 dots), reduced characters, or double-width characters are specified, that character width is considered the unit.

However, increases in the character width due to character styles are not applied.

- The horizontal printing position is moved to the left margin position.
- If the right margin setting is not at the beginning of the line, the right margin is set after a line feed.

The beginning of the line indicates the left margin position for left alignment; for right and center alignment, it means that no image or character is entered on the line.

- Even if the character width is changed after the right margin is set, the right margin position does not change.
- Any right margin setting that puts the right margin position to the left of the left margin position is ignored.
- When setting the right margin, set it at least one column (10 cpi = 30 dots) greater than the left margin.

(If the character width * n at the time of setting < (left margin + 30 dots), the setting is ignored.)

- If the difference in the right margin position and the left margin position is less than one character, that character is ignored.

- When proportional pitch is specified with the ESC p command, a character width of 10 cpi (= 30 dot) is applied.
- If the print media is continuous length label, the print direction is landscape, and the page length is not specified, commands specifying the right margin are ignored.

CR Carriage return

[ASCII] CR

[Decimal] 13

[Hexadecimal] 0D

[Parameters] None

[Description]

- Finalizes the input of a line and waits for input of the next line.
- The next print position is the beginning of the next line.
- A line feed command immediately after the carriage return is ignored.
Specifying auto-cancelling double-width characters with SO or ESC SO is cancelled.
- Same processing as LF.

ESC D Specify horizontal tab position

[ASCII] ESC D [n] k NUL

[Decimal] 27 68 [n] k 0

[Hexadecimal] 1B 44 [n] k 00h

[Parameters] 1≤n≤255

0≤k≤32

[Description]

- The position of the horizontal tab is the character width * n (at the time that the horizontal tab is set) from the left margin.
- Enter n values in ascending order and end the setting with NUL.
- If an n value is smaller than the previous one, the tab setting is finished.
- Even if the character width is changed after the horizontal tab positions are set, those horizontal tab setting positions do not change.
- ESC D NUL deletes all horizontal tab positions.
- If the left margin is moved, the horizontal tab positions are moved along with it.
- Up to 32 horizontal tab positions can be set. However, horizontal tab positions beyond the right margin are invalid and only become valid when a change in the right margin setting or left margin setting moves the print area to those tab positions.
- The character width at the time that the horizontal tabs are set includes the command settings for specifying character spacing, full-width character spacing, or half-width character spacing. In addition, when the 10 cpi, 12 cpi, or 15 cpi pitch, reduced characters, or double-width characters are specified, that character width is considered the unit.
- When proportional pitch is specified with ESC p, horizontal tab positions are set at 10 cpi.
- When the unit is switched on, horizontal tab positions are set every 8 columns at 10 cpi. Even if the character width is changed before the horizontal tab positions are set, the horizontal tab positions do not change.

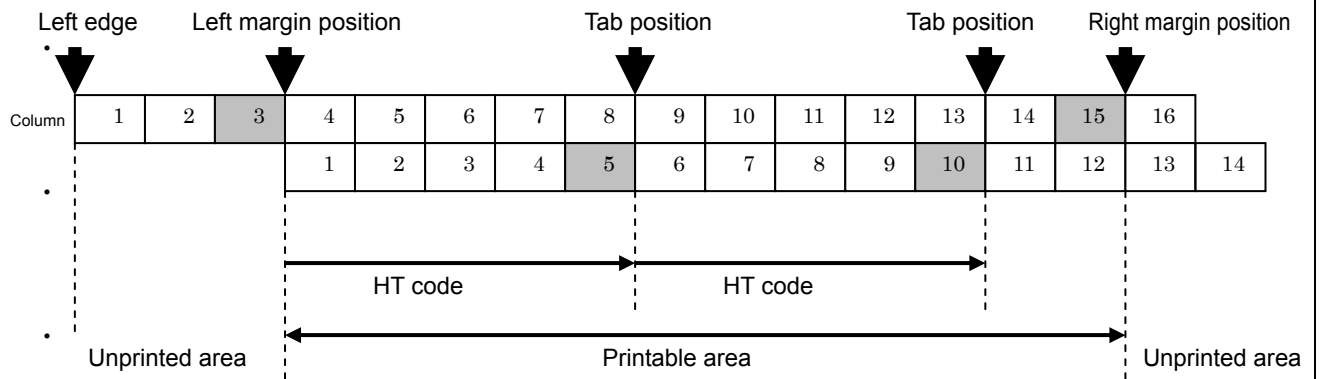

Example: After the left margin is set to Column 3 and the right margin to Column 15, horizontal tabs are set at Column 5 and Column 10, and an HT is performed.

HT Apply horizontal tab

[ASCII] HT

[Decimal] 9

[Hexadecimal] 09

[Parameters] None

[Description]

- Moves the horizontal print position to the nearest horizontal tab position to the right of the input position.
- If there is no horizontal tab position to the right of the input position or the next horizontal tab position is beyond the right margin, the HT command is ignored.
- When underlining is specified, no underline is applied between the current position and the next horizontal tab position.
- When the unit is switched on, horizontal tab positions are set every 8 columns at 10 cpi. Even if the character width is changed before the horizontal tab positions are set, the horizontal tab positions do not change.
- This command is available only with left alignment.

[Example] Specifying horizontal tabs at Column 4, Column 8, and Column 12, and applying a horizontal tab

Code

ESC D 04h 08h 0Ch 00h

123456789012 CR A HT B HT C HT D FF

Print result

```

123456789012
A B C D

```

ESC \$ Specify absolute horizontal position

[ASCII] ESC \$ n1 n2

[Decimal] 27 36 n1 n2

[Hexadecimal] 1B 24 n1 n2

[Parameters] 0≤n1≤255 ,0≤n2≤255

[Description]

- Specifies in dots the absolute print position for the next data.
- An absolute print position specifies the next print position as the number of dots from the left margin.
- n1 and n2 indicate the number of dots from the left margin. (Number of dots = n1 + 256*n2)
- The dot spacing is calculated as 1/300 inch.
- The maximum number of dots that can be specified with n1 and n2 depends on the media.
- This command is available only with left alignment.

ESC \ Specify relative horizontal position
--

[ASCII] ESC \ n1 n2

[Decimal] 27 92 n1 n2

[Hexadecimal] 1B 5C n1 n2

[Parameters] 0≤n1≤255,0≤n2≤255

[Description]

- Specifies in dots the horizontal print position as a relative position from the current position.
- A relative position specifies the next print position as the number of dots from the current position.
- n1 and n2 indicate the number of dots from the current position. (Number of dots = n1 + 256*n2)
- The dot spacing is calculated as 1/300 inch.
- Left margin position ≤ horizontal position after moving < right margin position
Horizontal position after moving = n1 + n2*256
- The specified value for moving to the left is expressed as the 2's complement. It is determined by the following equation.
 $n1 + n2 * 256 = 65536 - \text{distance of actual movement}$
- This command is available only with left alignment.

ESC a Specify alignment

[ASCII] ESC a n

[Decimal] 27 97 n

[Hexadecimal] 1B 61 n

[Parameters] 0≤n≤3 or "0"≤n≤"3"

[Description]

- The data is printed aligned as follows according to the value of n.

 n=0 or 48("0") specifies left alignment

 n=1 or 49("1") specifies center alignment

 n=2 or 50("2") specifies right alignment

 n=3 or 51("3") specifies nothing

- The default setting is n = 0.

- Data is aligned between the left and right margins with CR, LF, and FF code input and buffer printing.

- If the alignment setting is not at the beginning of the line, the alignment is set after a line feed.

The beginning of the line indicates the left margin position for left alignment;

for right and center alignment, it means that no image or character is entered on the line.

- HT, ESC \, ESC \$ are ignored when n = 1 or n = 2.

- If the print media is continuous length label, the print direction is landscape, and the page length is not set, commands specifying alignment are ignored.

Vertical movement commands

LF Line feed

[ASCII] LF

[Decimal] 10

[Hexadecimal] 0A

[Parameters] None

[Description]

- Feeds the paper by the amount set with the commands specifying the line feed amount (ESC 0, ESC 2, ESC 3, ESC A).
- The print position moves to the beginning of the next line.
- The default value is a 48-dot line feed.
- When a carriage return comes immediately after a line feed, the carriage return is ignored.
- Automatic cancellation of double-width characters with SO or ESC SO is cancelled.
- Same processing as CR

FF Page feed

[ASCII] FF

[Decimal] 12

[Hexadecimal] 0C

[Parameters] None

[Description]

- Starts the printing.
- Data line of the characters and commands entered before this command is cleared after printing.
- At this time, automatic cancellation of double-width characters specified with SO or ESC SO is cancelled.

ESC J Forward paper feed

[ASCII] ESC J n

[Decimal] 27 74 n

[Hexadecimal] 1B 4A n

[Parameters] $0 \leq n \leq 255$

[Description]

- Ends input for the current line and moves the vertical print position forward by $n/300$ inch (=1 dot).
- If the bottom margin setting is exceeded, printing starts.
- With left alignment, the print position for the next line is the end position of the current line. (The horizontal position does not move to the left margin.)
With right alignment and center alignment, the horizontal position moves to the beginning of the line.
- Automatic cancellation of double-width characters specified with SO or ESC SO is cancelled.

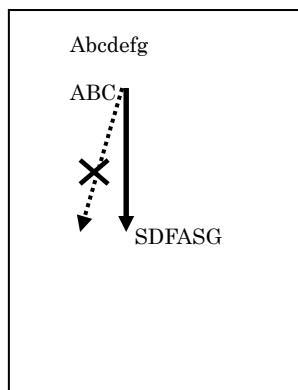

Left alignment

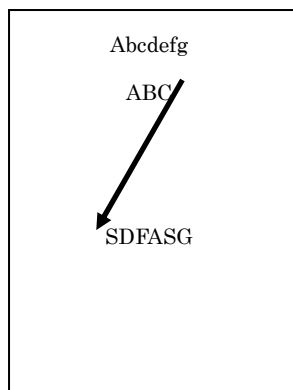

Center alignment

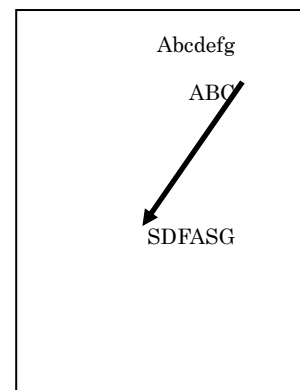

Right alignment

Example: Performing a forward paper feed after the second row

ESC B Specify vertical tab position

[ASCII] ESC B [n] _k NUL

[Decimal] 27 66 [n] _k 0

[Hexadecimal] 1B 42 [n] _k 00h

[Parameters] 1≤n≤255

 0≤k≤16

[Description]

- The position of the vertical tab is the line feed amount * n (at the time that the vertical tab is set) from the top margin.
- Enter n values in ascending order and end the setting with NUL.
- If an n value is smaller than the previous one, the tab setting is finished.
- Up to 16 vertical tabs can be set.
- To cancel all vertical tab positions, use ESC B NUL.
- Vertical tab positions can be set regardless of the setting of the bottom margin position. However, any vertical tab position outside the print area (beyond the bottom margin position) is invalid and only becomes valid when a change in the top or bottom margin position moves the print area to that vertical tab.
- Move to a vertical tab position with VT.
- When changing vertical tab positions, they must all be reset.
- If the top margin is moved, the vertical tab positions are also moved by the same amount.
- Even if the line feed amount is changed after the vertical tab positions are set, those vertical tab setting positions do not change.
- Performing a VT when no vertical tabs is set is equal to performing a CR.

VT Apply vertical tab

[ASCII] VT

[Decimal] 11

[Hexadecimal] 0B

[Parameters] None

[Description]

- Moves the print position to the nearest vertical tab position down from the input position.
- The next horizontal print position is the beginning of the line.
- If the next vertical tab position exceeds the bottom margin, or if there is no vertical tab position set below the current position, performing a VT is equal to performing an FF.

(Movement to the TOF position for the next page)

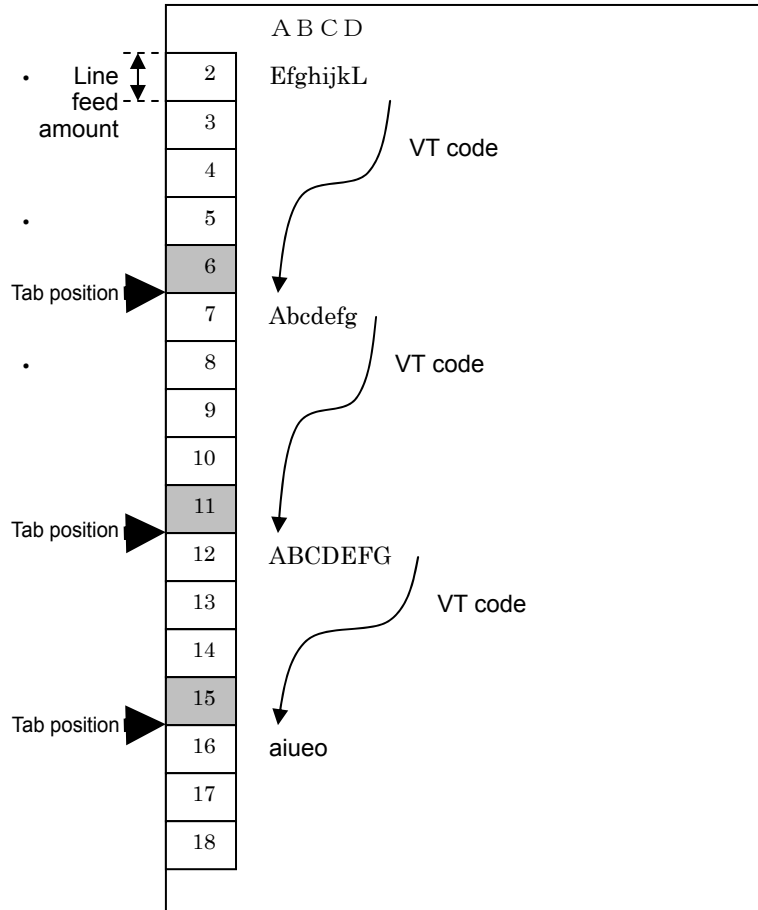

Example: Vertical tabs are set to Lines 6, 11, and 15, and data is entered while VT is performed

- In the default state and when all the vertical tab positions have been cancelled with ESC B NUL, performing a VT is equal to performing a CR.
- Automatic cancellation of double-width characters with SO or ESC SO is cancelled.

ESC (V Specify absolute vertical position

[ASCII] ESC (V nL nH mL mH

[Decimal] 27 40 86 nL nH mL mH

[Hexadecimal] 1B 28 56 nL nH mL mH

[Parameters] nL=2

 nH=0

 0≤mL≤255

 0≤mH≤127

[Description]

- Specifies the vertical print position as an absolute position from the top margin position.

$$\text{Vertical position} = \text{mL} + \text{mH} * 256 + \text{top margin}$$

- The absolute vertical position is measured from the top margin position at the time.
- If a position exceeding the bottom margin is specified, printing starts.
- There is no restriction on the amount of movement back (upward) from the current position.
- With left alignment, the print position for the next line is the end position of the current line. (The horizontal position does not move to the left margin.)

With right alignment and center alignment, the horizontal position moves to the beginning of the line.

- Automatic cancellation of double-width characters specified with SO or ESC SO is cancelled.

ESC (v Specify relative vertical position

[ASCII] ESC (v nL nH mL mH

[Decimal] 27 40 118 nL nH mL mH

[Hexadecimal] 1B 28 76 nL nH mL mH

[Parameters] nL=2

nH=0

0≤mL≤255

0≤mH≤127

-16384 ≤ (mL+mH * 256) ≤16383

[Description]

- Specifies the vertical print position as a relative position from the current position.

Vertical position after movement = mL + mH * 256 + current position

- When moving upwards, the specified value is expressed as a 2's complement. It is determined by the following equation.

$mL + mH * 256 = 65536 - \text{amount of actual movement}$

- Settings moving the print position above the top margin are ignored.
- If a position exceeding the bottom margin is specified, printing starts.
- With left alignment, the print position for the next line is the end position of the current line. (The horizontal position does not move to the left margin.)

With right alignment and center alignment, the horizontal position moves to the beginning of the line.

- Automatic cancellation of double-width characters with SO or ESC SO is cancelled.

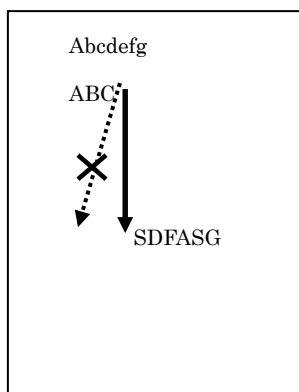

Left alignment

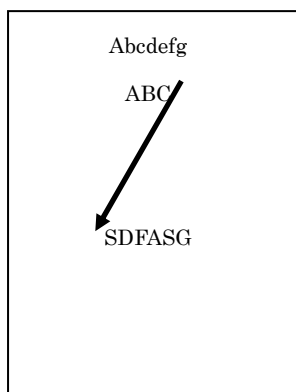

Center alignment

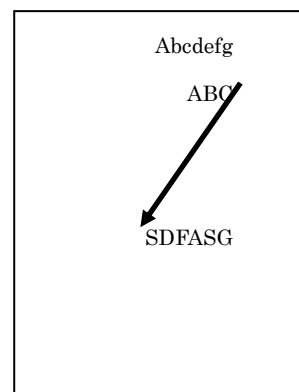

Right alignment

Example: Specifying a vertical position after the second row and moving to it

Paper formatting

ESC (c Specify page format

[ASCII] ESC (c nL nH tL tH BL BH

[Decimal] 27 40 99 nL nH tL tH BL BH

[Hexadecimal] 1B 28 63 nL nH tL tH BL BH

[Parameters] nL=4,nH=0

$(tL + tH * 256) < (BL + BH * 256)$

Top margin < bottom margin

[Description]

- Specifies settings for the top and bottom margins.
- The physically printable area depends on the media.

The top margin and the bottom margin are set in units of 1/300 inch (= 1 dot) using the top edge of the physically printable area as the reference.

(The left margin and the right margin use the left edge of the physically printable area as the reference.)

Top margin = $tL + tH * 256$

Bottom margin = $BL + BH * 256$

- The top margin position is the TOF in the vertical direction.
- All text content before this is cleared.
- The character baseline for the first line is 24/300 inch (24 dots) below the top margin.
- When this code is set, previously set top and bottom margins are deleted.
- The standard unit is not used.
- If the print media is continuous length label and, the print direction is landscape, and the page length is not set, commands specifying the page format are ignored.

ESC (C Specify page length

[ASCII] ESC (C nL nH mL mH

[Decimal] 27 40 67 nL nH mL mH

[Hexadecimal] 1B 28 43 nL nH mL mH

[Parameters] nL=2,nH=0

$$0 < (mL+mH * 256) < 12000$$

[Description]

- Specifies the page length.
 - The unit is 1/300 inch (= 1 dot).
- Page length = mL + mH * 256
- The current paper position is set as the TOF.
- The top and bottom margins are deleted with ESC (c.
- All text content before this is cleared.
- The standard unit is not used.
- This command is available only with continuous length label.

Inch, mm, and dot conversion table

inch	mm	Number of dots
0	0	0
1	25.4	300
2	50.8	600
3	76.2	900
4	101.6	1200
5	127.0	1500
6	152.4	1800
7	177.8	2100
8	203.2	2400
9	228.6	2700
10	254.0	3000
11	279.4	3300
12	304.8	3600
13	330.2	3900
14	355.6	4200
15	381.0	4500
16	406.4	4800
17	431.8	5100
18	457.2	5400
19	482.6	5700
20	508.0	6000

Printer control commands

ESC @ Initialize

[ASCII] ESC @

[Decimal] 27 64

[Hexadecimal] 1B 40

[Parameters] None

[Description]

- This returns all commands to their default values. (See the note below.)

Item	Default
Input buffer	Save
Text buffer	Clear
Print buffer	Clear
Top margin	0 dot
Bottom margin	Depends on media
Left margin	0 dot
Right margin	Depends on media
Line feed amount	48 dots
Horizontal tab positions	Horizontal tab every 8 characters (with 10-cpi character width)
Vertical tab positions	None
Character size	32 dots
Character spacing	0 dot
Proportional pitch	Off
International character set	USA
Character style	Off
Reduced	Off
Horizontal print position	Top margin position (TOF position)
Vertical print position	Left margin position
Landscape setting	Off
Page length setting	Off
Cut setting	Auto Cut (Manufacturer's default)
Font	Brougham

Graphics commands

ESC * Select bit image

[ASCII] ESC * m n1 n2 Data

[Decimal] 27 42 m n1 n2 Data

[Hexadecimal] 1B 2A m n1 n2 Data

[Parameters] m=0,1,2,3,4,6,32,33,38,39,40,71,72,73

0≤n1≤255, 0≤n2≤11

The image data is n1 + n2*256 bytes when m = 0,1,2,3,4,6;

(n1+n2*256)*3 bytes when m = 32,33,38,39,40

(n1+n2*256)*6 bytes when m = 71,72,73

[Description]

- Selects and outputs a bit image according to the value of m.
- n1 and n2 indicate the number of dot positions.
 - n1: the remainder from dividing the number of dot positions by 256.
 - n2: the quotient from dividing the number of dot positions by 256.

m	Horizontal dot density	Vertical dot density	Horizontal dot resolution	Vertical dot resolution
0	60DPI	60DPI	6/300 inch	6/300 inch
1	120DPI	60DPI	3/300 inch	6/300 inch
2	120DPI	60DPI	3/300 inch	6/300 inch
3	240DPI	60DPI	2/300 inch	6/300 inch
4	80DPI	60DPI	4/300 inch	6/300 inch
6	90DPI	60DPI	4/300 inch	6/300 inch
32	60DPI	180DPI	6/300 inch	2/300 inch
33	120DPI	180DPI	3/300 inch	2/300 inch
38	90DPI	180DPI	4/300 inch	2/300 inch
39	180DPI	180DPI	2/300 inch	2/300 inch
40	360DPI	180DPI	1/300 inch	2/300 inch
71	180DPI	360DPI	2/300 inch	1/300 inch
72	360DPI	360DPI	1/300 inch	1/300 inch
73	360DPI	360DPI	1/300 inch	1/300 inch

- Horizontally neighboring dots are not omitted.
- (Limitations) A maximum of 63 can be used with this command.

When m=0, 1, 2, 3, 4, 6

- n1 and n2 indicate the number of dot positions.
 - n1: the remainder from dividing the number of dot positions by 256
 - n2: the quotient from dividing the number of dot positions by 256

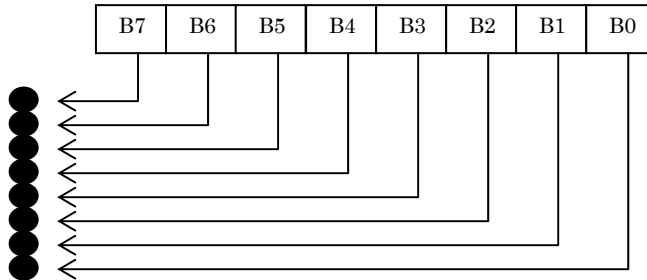

Relationship between the image data and the dots

- First, the data is lined up in one row as follows:

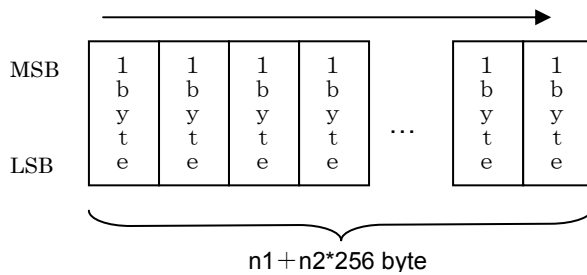

- One dot of the image data is enlarged as follows according to the value of m.

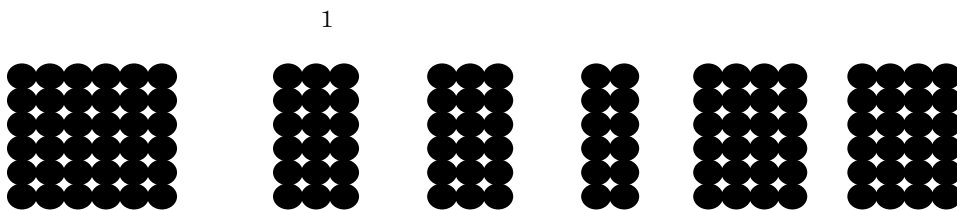

- As a result, the image is sized depending on the value of m as follows:

- m = 0 48 dots vertically x (n1 + n2 * 256) * 6 dots horizontally
- m = 1 48 dots vertically x (n1 + n2 * 256) * 3 dots horizontally
- m = 2 48 dots vertically x (n1 + n2 * 256) * 3 dots horizontally
- m = 3 48 dots vertically x (n1 + n2 * 256) * 2 dots horizontally
- m = 4 48 dots vertically x (n1 + n2 * 256) * 4 dots horizontally
- m = 6 48 dots vertically x (n1 + n2 * 256) * 4 dots horizontally

When $m = 32, 33, 38, 39, 40$

- $n1$ and $n2$ indicate the number of dot positions.
 - $n1$: the remainder from dividing the number of dot positions by 256
 - $n2$: the quotient from dividing the number of dot positions by 256

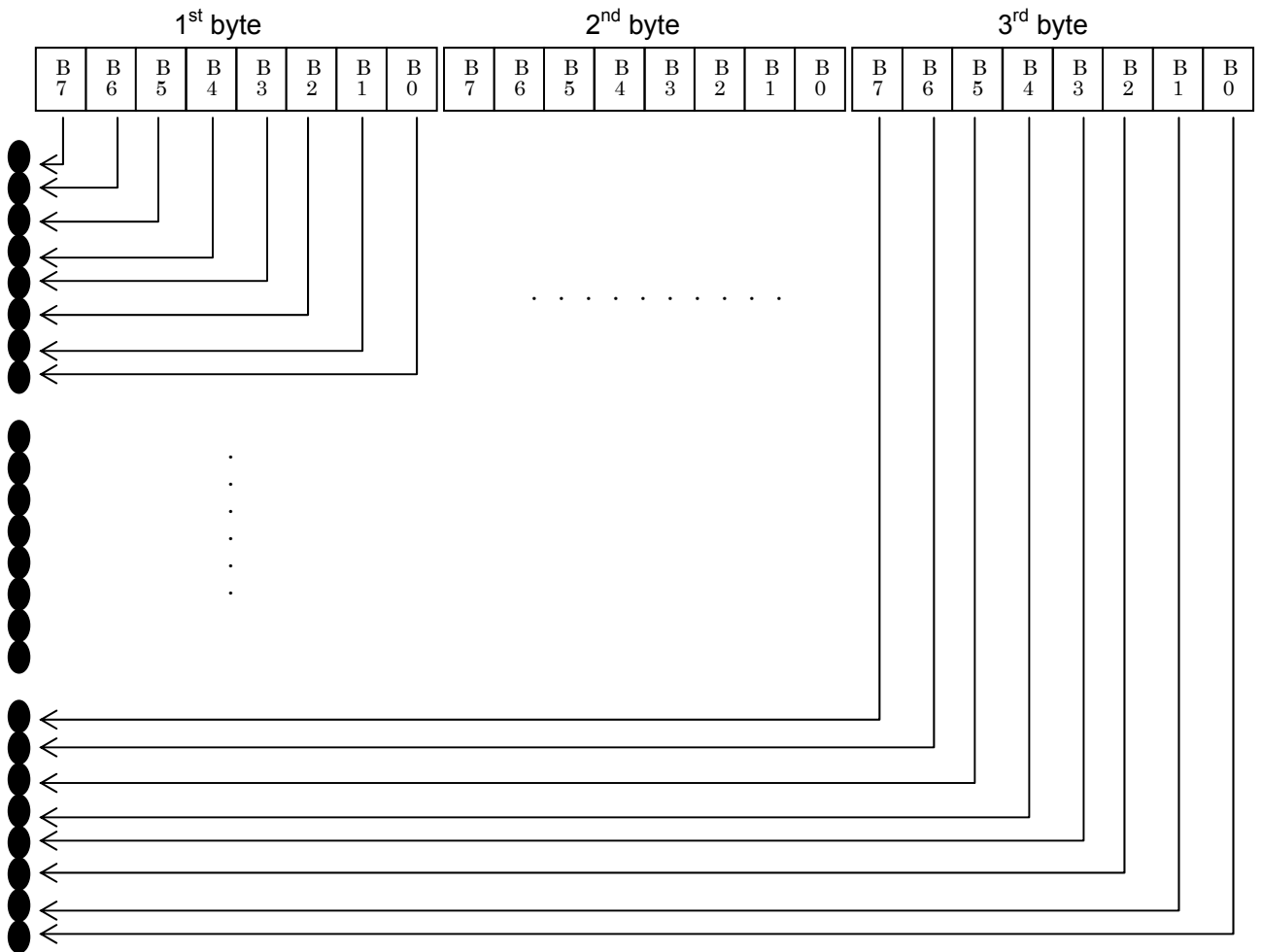

Relationship between the image data and the dots

- First, the data is lined up in three rows as follows:

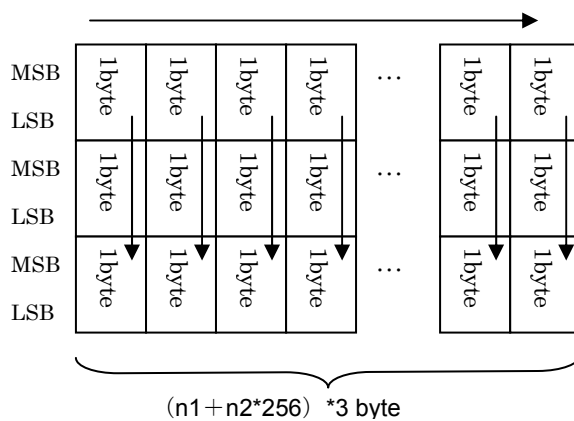

. One dot of the image data is enlarged as follows according to the value of m.

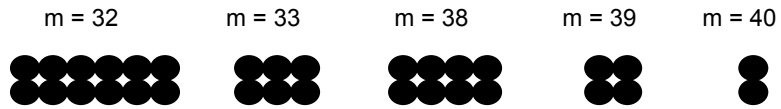

• As a result, the image is sized depending on the value of m as follows:

m = 32 48 dots vertically x $(n1 + n2 * 256) * 6$ dots horizontally

m = 33 48 dots vertically x $(n1 + n2 * 256) * 3$ dots horizontally

m = 38 48 dots vertically x $(n1 + n2 * 256) * 4$ dots horizontally

m = 39 48 dots vertically x $(n1 + n2 * 256) * 2$ dots horizontally

m = 40 48 dots vertically x $(n1 + n2 * 256) * 1$ dots horizontally

When m = 71, 72, 73

• n1 and n2 indicate the number of dot positions.

n1: the remainder from dividing the number of dot positions by 256

n2: the quotient from dividing the number of dot positions by 256

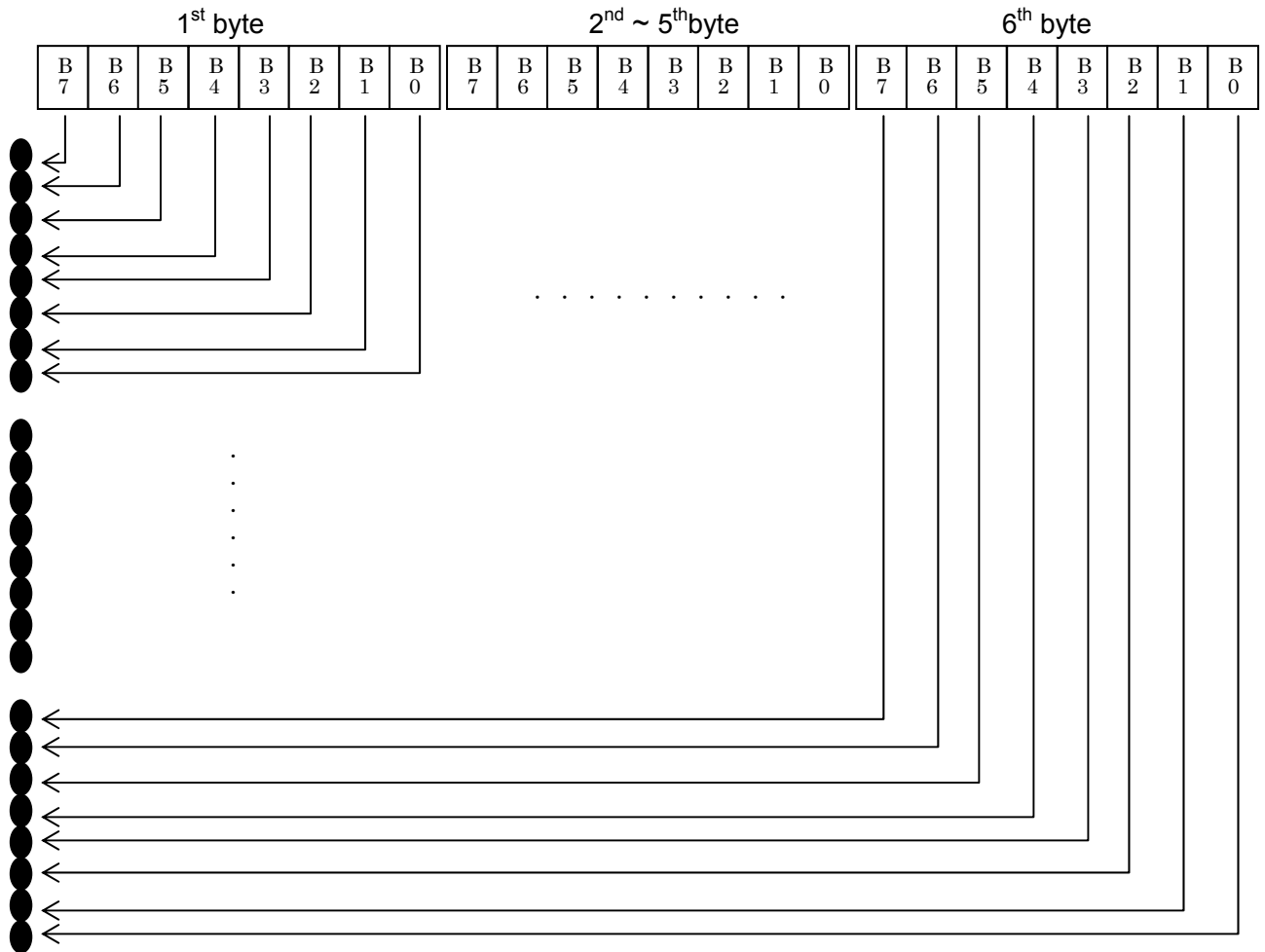

Relationship between the image data and the dots

- First, the data is lined up in three rows as follows:

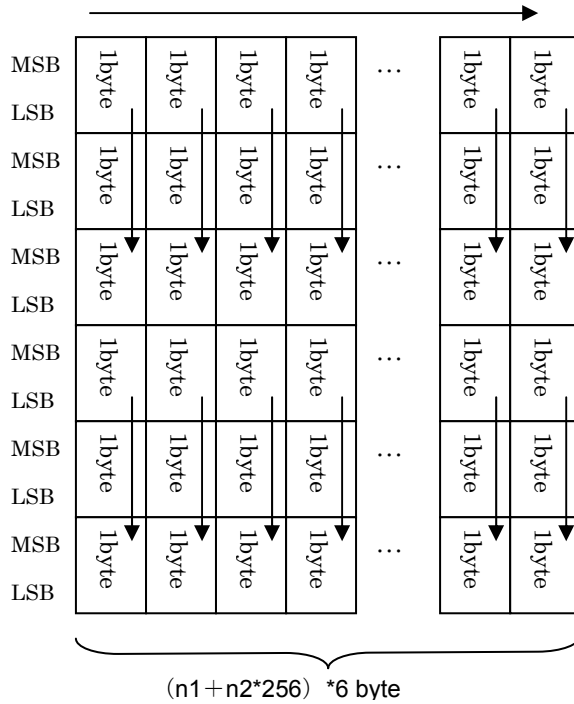

- . One dot of the image data is enlarged as follows according to the value of m.

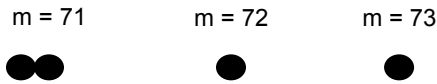

- As a result, the image is sized depending on the value of m as follows:

m = 71 48 dots vertically x (n1 + n2 * 256) * 2 dots horizontally

m = 72 48 dots vertically x (n1 + n2 * 256) * 1 dots horizontally

m = 73 48 dots vertically x (n1 + n2 * 256) * 1 dots horizontally

ESC K 8-dot standard-density bit image

[ASCII] ESC K n1 n2 Data

[Decimal] 27 75 n1 n2 Data

[Hexadecimal] 1B 4B n1 n2 Data

[Parameters] 0 ≤ n1 ≤ 255, 0 ≤ n2 ≤ 3

The data contains n1 + n2 * 256 byte image data.

[Description]

Specifies that an 8-dot standard-density bit image is printed with the number of dot positions indicated by n1 and n2.

- n1 and n2 indicate the number of dot positions.

- n1: the remainder from dividing the number of dot positions by 256
- n2: the quotient from dividing the number of dot positions by 256

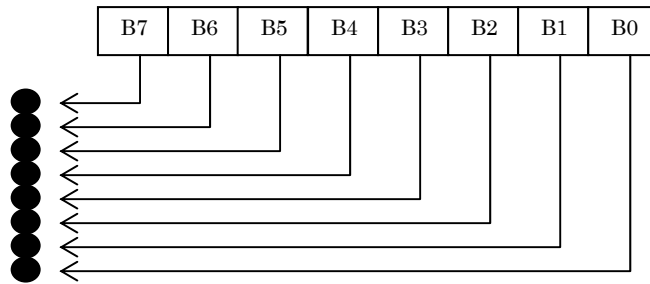

Relationship between the image data and the dots

- First, the data is lined up in one row as follows:

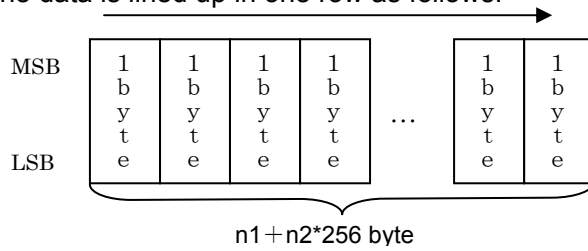

- One dot of image data is enlarged to 6 dots vertically by 6 dots horizontally.

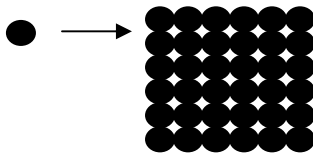

- As a result, the image is 48 dots vertically by $(n1 + n2 * 256) * 6$ dots horizontally.

ESC L 8-dot double-density bit image

[ASCII] ESC L n1 n2 Data

[Decimal] 27 76 n1 n2 Data

[Hexadecimal] 1B 4C n1 n2 Data

[Parameters] $0 \leq n1 \leq 255, 0 \leq n2 \leq 3$

The data contains $n1 + n2 * 256$ byte image data.

[Description]

Specifies that an 8-dot double-density bit image is printed with the number of dot positions indicated by n1 and n2.

- n1 and n2 are specified in the same way as for ESC K.
- First, the data is lined up in one row as follows:

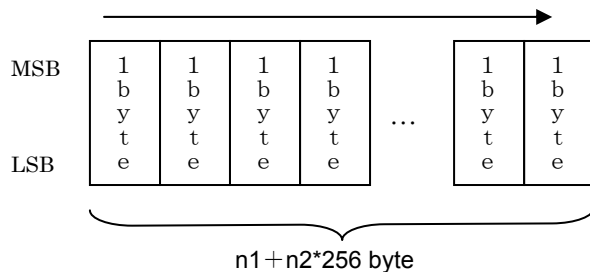

- One dot of image data is enlarged to 6 dots vertically by 3 dots horizontally.

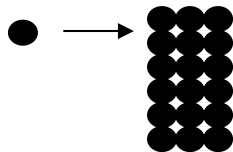

- As a result, the image is 48 dots vertically by $(n1 + n2 * 256) * 3$ dots horizontally.

ESC Y 8-dot double-speed double-density bit image

[ASCII] ESC Y n1 n2 Data
 [Decimal] 27 89 n1 n2 Data
 [Hexadecimal] 1B 59 n1 n2 Data
 [Parameters] 0≤n1≤255,0≤n2≤3

The data contains n1 + n2 * 256 byte image data.

[Description]

- Same as for an 8-dot double-density bit image. Horizontally neighboring dots are not omitted.

ESC Z 8-dot quadruple-density bit image

[ASCII] ESC Z n1 n2 Data
 [Decimal] 27 90 n1 n2 Data
 [Hexadecimal] 1B 5A n1 n2 Data
 [Parameters] 0≤n1≤255,0≤n2≤7

The data contains n1 + n2 * 256 byte image data.

[Description]

Specifies that an 8-dot double-density bit image is printed with the number of dot positions indicated by n1 and n2.

- n1 and n2 are specified in the same way as for ESC K.
- Horizontally neighboring dots are not omitted.
- First, the data is lined up in one row as follows:

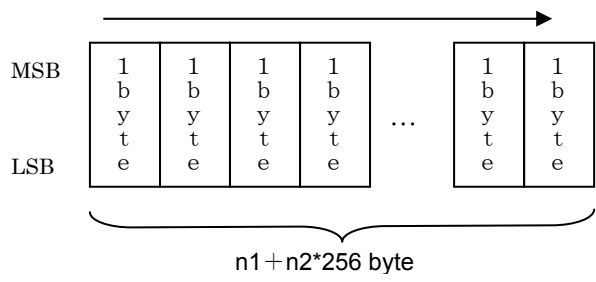

- One dot of image data is enlarged to 6 dots vertically by 2 dots horizontally.

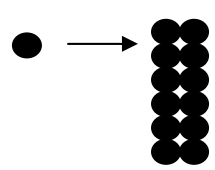

- As a result, the image is 48 dots vertically by (n1 + n2 * 256) * 2 dots horizontally.

Advanced commands

ESC i B Bar code

[ASCII] ESC i [Parameters] B or b [Bar code data] Backslash

[Decimal] 27 105 [Parameters] 66 or 98 [Bar code data] 92

[Hexadecimal] 1B 69 [Parameters] 42 or 62 [Bar code data] 5C

[Parameters]

1 [Parameters]: Bar code parameters

T or t (type)

t0 : CODE39

t1 : ITF(I-2/5)

t5 : EAN-8,EAN-13,UPC-A

t6 : UPC-E

t9 : CODABAR

ta : CODE128

tb : GS1-128(UCC/EAN-128)

tc : RSS symbols

s (style) Ignored

p (number of passes) Ignored

R or r (characters below bar code)

r0 : OFF

r1 : ON

u (units of measurement) Ignored

x (horizontal position) Ignored

y (vertical offset) Ignored

h (height)

h n1 n2

Height = $n1 + n2 * 256$ (dots)

$48 \leq \text{height} \leq 480$

If height < 48, height = 48

If height > 480, height = 480

However, this is as shown below with tc.

$131 \leq \text{height} \leq 1296$ (RSS-14 Standard)

$71 \leq \text{height} \leq 1296$ (RSS-14 Truncated)

$71 \leq \text{height} \leq 1296$ (RSS-14 Stacked)

$239 \leq \text{height} \leq 1296$ (RSS-14 Stacked Omni)

62 ≤ height ≤ 1296 (RSS Limited)

134 ≤ height ≤ 1296 (RSS Expanded)

If height < min., height = min.

If height > max., height = max.

(A bar code with a large number of stacked rows may be considered out of specifications and unreadable by the reader.)

w (width)

w0 : extra small

w1 : small

w2 : medium

w3 : large

E or e (parentheses deletion)

e0 : ON

e1 : OFF

o (RSS symbols model)

o0 : RSS-14 Standard

o1 : RSS-14 Truncated

o2 : RSS-14 Stacked

o3 : RSS-14 Stacked Omnidirectional

o4 : RSS Limited

o5 : RSS Expanded Standard

o6 : RSS Expanded Stacked

c (number of horizontal characters for RSS Expanded Stacked)

c No. of horizontal characters

This must be an even value where $2 \leq \text{no. of horizontal characters} \leq 20$.

z (ratio between thick and thin bars)

z0 : (3:1)

z1 : (2.5:1)

z2 : (2:1)

f (equalize bar lengths)

f0 : OFF

f1 : ON

*Notes:

- For parameter numerals 0–9, both 00H–09H and 30H–39H are recognized.
- The parameter types a, b and c are recognized even when uppercase.

- The parameter “parentheses deletion” is available only when GS1-128(UCC/EAN-128) is selected.
- The parameter “ratio between thick and thin bars” is available only when t0, t1 or t9 is selected.
- The parameter “equalize bar lengths” is available only when t5 or t6 is selected.
- When another type is selected, these parameters are ignored.
- When there is no type command or an invalid type command is specified, CODE39 is set.
- The number of bar code characters that can be entered for each type is as follows:

t0: 1–50 characters (* is not included)

t1: 1–64 characters

t5: 7 characters (for EAN-8)
12 characters (for EAN-13)
11 characters (for UPC-A)

t6: 6 characters

t9: 3–64 characters (Must begin and end with A, B, C, or D.)

ta: 1–64 characters

tb: 1–64 characters

tc: 3–15 characters (begins with “01”) (except with RSS Expanded)
1–64 numbers or 1–40 letters* (for RSS Expanded)

* ISO646 characters can be printed.
(numbers, letters, spaces, !, ", %, &, ', (,), *, +, ,, -, ., /, :, ;, <, =, >, ? and _)

2 B or b : Beginning of bar code data

3 [Bar code data]: Bar code data

? (Generate check digit)

Generates a check digit if there is “?” in the bar code data.

The position of “?” is irrelevant as long as “?” is within the bar code data.

With CODE128 and GS1-128(UCC/EAN-128), no check digit is generated.

If “?” is inserted, it is treated as bar code data.

4 Backslash: End of bar code data

[When the type is CODE39, ITF(I-2/5), EAN-8, EAN-13, UPC-A, UPC-E, CODABAR or RSS symbols]

ESC i [Parameter] B or b [Bar code data] \

[When the type is CODE128 or GS1-128(UCC/EAN-128)]

ESC i [Parameter] B or b [Bar code data] \ \ \

[Description]

- This specifies a bar code image.
- Any data exceeding the right margin is ignored.
- Since the check digit is generated automatically from the bar code data, the check digit is not sent as bar code data. Since the bar code data is also checked, the data would not be correctly recognized if the check digit data was present.
- With CODE39, ITF(I-2/5), CODABAR, CODE128, GS1-128(UCC/EAN-128) or RSS Expanded, the buffer length for the bar code image is about 22 cm. A bar code longer than 22 cm will not be printed.
- The characters that can be printed with CODE128 and GS1-128(UCC/EAN-128) are the 128 ASCII characters and the special codes FNC1, FNC2, FNC3 and FNC4.
- Codes assigned to the special codes
 - FNC1: 86H
 - FNC2: 81H
 - FNC3: 80H
 - FNC4: 84H
- The control codes and special codes appear as spaces when characters are printed below CODE128 and GS1-128(UCC/EAN-128) bar codes.
- Special code FNC1 can also be printed with RSS Expanded. This special code also appears as a space when characters are printed below the bar code.
- Code assigned to the special code
 - FNC1: 86H

ESC i Q 2D Bar code QR codes

[ASCII]	ESC	i	Q	or	q	Data
[Decimal]	27	105	81	or	113	Data
[Hexadecimal]	1B	69	51	or	71	Data

• Format

ESC	i	Q or q	[Parameters]	[Bar code data]	\ \ \
			1	2	3

① Parameters

Unlike with 1D bar codes, it is necessary to specify all parameters from the top down.

If a value other than those listed is entered for a parameter, that parameter is set to its default value.

1. Cell size [Decimal 1 byte] 3 [Decimal 1 byte] 4 [Decimal 1 byte] 5 [Decimal 1 byte] 6 [Decimal 1 byte] 8 [Decimal 1 byte] 10	Sets the dot size per cell side. Prints 3 dots per cell side. (default value) Prints 4 dots per cell side. Prints 5 dots per cell side. Prints 6 dots per cell side. Prints 8 dots per cell side. Prints 10 dots per cell side.	
2. Symbol type [Decimal 1 byte] 1 [Decimal 1 byte] 2 [Decimal 1 byte] 3	Model 1 Model 2 (default value) Micro QR	
3. Linkage setting [Decimal 1 byte] 0 [Decimal 1 byte] 1	Do not link. Link. (*1)	
4. Code number [Decimal 1 byte] 1–16	Shows the number of the QR code that is linked.	
5. Number of partitions [Decimal 1 byte] 2–16	Shows the total number of QR codes linked.	
6. Parity data [Hexadecimal 1 byte] 00-FF	The value of exclusively OR'ing all the print data (print data before partition) in bytes	
7. Error correction level [Decimal 1 byte] 1 [Decimal 1 byte] 2 [Decimal 1 byte] 3 [Decimal 1 byte] 4	High-density level L 7% Standard level M 15% (default value) High-reliability level Q 25% Ultra-high-reliability level H 30% (*2)	
8. Data input method [Decimal 1 byte] 0 [Decimal 1 byte] 1	Auto input (default value) Manual input Selects numbers, English alphanumeric characters, kanji, binaries.	

(*1) With Micro QR, the linkage setting is invalid, and the default setting is used.

(*2) With Micro QR, error correction level 4 is invalid, and the default setting is used.

<> Supplement What is the QR code linkage setting?

With QR codes, there are linkage settings.

A long character string can be partitioned into 2 to 16 partitions and printed.

With the ESC/P command, it is necessary to input only the number of partitions.

For example, if the print data is partitioned into 3 partitions, the bar code data is as follows:

ESC i Q or q [1st parameter] [1st set of bar code data] \ \ \

ESC i Q or q [2nd parameter] [2nd set of bar code data] \ \ \

ESC i Q or q [3rd parameter] [3rd set of bar code data] \ \ \

3. Linkage Setting: This determines whether or not the bar code data is partitioned with the linkage setting. When not partitioned, input 0.

When not partitioning, the values of 4 (code number), 5 (number of partitions), and 6 (parity data) are ignored; therefore, input 0 as a dummy value for these parameters.

4. Code number: The code number shows which number the ESC/P command for that QR code is.

For example, if there are four partitions, for the second ESC/P command, this is 2; for the fourth ESC/P command, this is 4.

5. Number of partitions: For the number of partitions, input the number of existing partitions.

6. Parity data is the value of exclusively OR'ing all the print data (print data before partition) in bytes. The same value is input here as for the partitioned QR code ESC/P command to show that these codes are linked.

What is exclusive OR'ing in bytes?

The data is exclusively OR'ed (XOR'ed) in bytes and in order.

For example, if the character string is put into hexadecimal, this gives 0x31, 0x32, 0x33, 0x34.

XOR of 0x31 and 0x32 0011 0001 ^= 0011 0010 Result: 0000 0011 (0x03)

XOR of 0x03 and 0x33 0000 0011 ^= 0011 0011 Result: 0011 0000 (0x30)

XOR of 0x30 and 0x34 0011 0000 ^= 0011 0100 Result: 0000 0100 (0x04)

Therefore, the parity is 0x04.

Note: If this parity value is incorrect, the correct QR code is not generated.

Summary

Printing the character string "123456789" with a cell size of 4 dots, Model 2, standard error correction level, and automatic data input

- No linkage

**ESC i Q 0x04 0x02 0x00 0x00 0x00 0x00 0x02 0x00 "123456789" \ \ **

· With linkage. [Three partitions] (The parity for the character string "123456789" is 0x31.)

**ESC i Q 0x04 0x02 0x01 0x01 0x03 0x31 0x02 0x00 "123" **

**ESC i Q 0x04 0x02 0x01 0x02 0x03 0x31 0x02 0x00 "456" **

**ESC i Q 0x04 0x02 0x01 0x03 0x03 0x31 0x02 0x00 "789" **

2 [Bar code data]: Bar code data

When manual input is selected in 8 (data input method of the parameters), the bar code data must be preceded with one of the following single-byte alphanumeric characters.

Number input N or n

Alphanumeric input A or a

Kanji input K or k

Binary input B or b + 4 digits of numbers

Specify numbers of binary character that is input the "4 digits numbers"

For example, if you input 12 characters, it should be;

B 0012 (0x30,0x30,0x31,0x32)

<Example>

1. Kanji

ESC i Q [other parameters] 1 K kanji input \\\

2. Alphanumeric input

ESC i Q [other parameters] 1 A012345678aBcDe \\\

3. Binary input

ESC i Q [other parameters] 1 B0005#### \\\

The number of bar code data items that can be input depends on the model type and the input type.

Model 1: 707 English alphanumeric characters, 1167 numbers, 486 binary bytes, 299 kanji

Model 2: 4296 English alphanumeric characters, 7089 numbers, 2953 binary bytes, 1817 kanji

Micro QR: 21 English alphanumeric characters, 35 numbers, 15 binary bytes, 9 kanji

Note: The numbers shown here is for high-density Level L 7% of Error correction level. If you specify them on more than standard level, the number may decrease. And, even if you specify them on high-density level, it may decrease because of the treatment of compression.

3 \\\: End of bar code

Three back slashes are necessary for end of 2D bar code.

ESC i P QR code version setting

[ASCII] ESC i P n

[Decimal] 27 105 80 n

[Hexadecimal] 1B 69 50 n

[Parameters] 0≤n≤40

[Description]

- The barcode size can be fixed.
- The default value is “0”.
- The available versions differ depending on the symbol type used.

If a setting other than those listed is specified, the setting returns to its default.

The following settings are available for each symbol type.

Model1 (0–14), Model2 (0–40), MicroQR (0–4)

8. Aspect value [Decimal 2 bytes] 1–1000	Inputs the aspect value. Actually, this is 0.01–10.0, but since the decimal point can not be entered, 100x the value is entered. The default value is 50. (Actual value of 0.5)	
---	--	--

*Notes:

- When the Symbol size X specification or the symbol size specification is input, Aspect value is ignored.
- When the Symbol size X specification or the symbol size specification is input, sometimes bar cord is not printed or unreadable barcode is printed.
- If both large cell size and high level error correction capacity is specified, it may not print because of over print buffer.

[With symbol type MicroPDF417]

- Since the error correction capacity is automatically determined from symbol size X specification, the settings for “Error correction capacity and type” and “Error correction capacity and value” are ignored.
- The aspect value setting is ignored.

The following table shows the values available for symbol size Y specification according to symbol size X specification. If an invalid setting is specified for symbol size Y specification, the default setting is specified.

Symbol size X specification	Symbol size Y specification												
AUTO	AUTO												
1	AUTO	11	14	17	20	24	28						
2	AUTO	8	11	14	17	20	23	26					
3	AUTO	6	8	10	12	15	20	26	32	38	44		
4	AUTO	4	6	8	10	12	15	20	26	32	38	44	

2 Bar code data

The numbers of bar code data items that can be input are as follows.

1850 alphanumeric characters, 2710 numbers, 1108 binary bytes

*Note: The numbers shown here is for high-density Level L 7% of Error correction level. If you specify them on more than standard level, the number may decrease. And, even if you Specify then on high-density level, it may decrease because of the treatment of compression.

[With symbol type MicroPDF417]

Maximum of 250 alphanumeric characters, maximum of 366 numbers, maximum of 150 bytes of binary data

However, the following table shows the maximum amount of information allowed according to symbol size X specification and symbol size Y specification.

X	Y	Maximum amount of information allowed		
		Alphanumeric characters	Numbers	Binary
1	11	6	8	3
1	14	12	17	7
1	17	18	26	10
1	20	22	32	13
1	24	30	44	18
1	28	38	55	22
2	8	14	20	8
2	11	24	35	14
2	14	36	52	21
2	17	46	67	27
2	20	56	82	33
2	23	64	93	38
2	26	72	105	43
3	6	10	14	6
3	8	18	26	10
3	10	26	38	15
3	12	34	49	20
3	15	46	67	27
3	20	66	96	39
3	26	90	132	54
3	32	114	167	68
3	38	138	202	82
3	44	162	237	97
4	4	14	20	8
4	6	22	32	13
4	8	34	49	20
4	10	46	67	27
4	12	58	85	34
4	15	76	111	45
4	20	106	155	63
4	26	142	208	85
4	32	178	261	106
4	38	214	313	128
4	44	250	366	150

3 \\\: End of bar codes

Three back slashes are necessary for end of 2D bar code.

ESC i D 2D bar code DataMatrix control

[ASCII] ESC I D or d data

[Decimal] 27 105 68 or 100 data

[Hexadecimal] 1B 69 44 or 64 data

• Format

ESC i D or d [Parameters] [Bar code data] \\

1 2 3

① Parameters

Unlike with 1D bar codes, it is necessary to specify all parameters from the top down.

If a value other than those listed is entered for a parameter, that parameter is set to its default value.

1. Cell size	Set the dot size per cell side.	
[Decimal 1 byte] 3	Prints 3 dots per cell side. (default value)	
[Decimal 1 byte] 4	Prints 4 dots per cell side.	
[Decimal 1 byte] 5	Prints 5 dots per cell side.	
[Decimal 1 byte] 6	Prints 6 dots per cell side.	
[Decimal 1 byte] 8	Prints 8 dots per cell side.	
[Decimal 1 byte] 10	Prints 10 dots per cell side.	
2. Symbol type		
[Decimal 1 byte] 0	ECC200 square (default value)	
[Decimal 1 byte] 1	ECC200 rectangular	
3. Vertical size		
[Decimal 1 byte] 0	• ECC200 square Vertical no. of cells: AUTO (default value)	
[Decimal 1 byte] 10	Vertical no. of cells: 10 cells	
[Decimal 1 byte] 12	Vertical no. of cells: 12 cells	
[Decimal 1 byte] 14	Vertical no. of cells: 14 cells	
[Decimal 1 byte] 16	Vertical no. of cells: 16 cells	
[Decimal 1 byte] 18	Vertical no. of cells: 18 cells	
[Decimal 1 byte] 20	Vertical no. of cells: 20 cells	
[Decimal 1 byte] 22	Vertical no. of cells: 22 cells	
[Decimal 1 byte] 24	Vertical no. of cells: 24 cells	
[Decimal 1 byte] 26	Vertical no. of cells: 26 cells	
[Decimal 1 byte] 32	Vertical no. of cells: 32 cells	
[Decimal 1 byte] 36	Vertical no. of cells: 36 cells	
[Decimal 1 byte] 40	Vertical no. of cells: 40 cells	
[Decimal 1 byte] 44	Vertical no. of cells: 44 cells	
[Decimal 1 byte] 48	Vertical no. of cells: 48 cells	
[Decimal 1 byte] 52	Vertical no. of cells: 52 cells	
[Decimal 1 byte] 64	Vertical no. of cells: 64 cells	
[Decimal 1 byte] 72	Vertical no. of cells: 72 cells	
[Decimal 1 byte] 80	Vertical no. of cells: 80 cells	
[Decimal 1 byte] 88	Vertical no. of cells: 88 cells	
[Decimal 1 byte] 96	Vertical no. of cells: 96 cells	

[Decimal 1 byte] 104 [Decimal 1 byte] 120 [Decimal 1 byte] 132 [Decimal 1 byte] 144	Vertical no. of cells: 104 cells Vertical no. of cells: 120 cells Vertical no. of cells: 132 cells Vertical no. of cells: 144 cells	
[Decimal 1 byte] 0 [Decimal 1 byte] 8 [Decimal 1 byte] 12 [Decimal 1 byte] 16	<ul style="list-style-type: none"> ECC200 rectangular Vertical no. of cells: AUTO (default value) Vertical no. of cells: 8 cells Vertical no. of cells: 12 cells Vertical no. of cells: 16 cells	
4. Horizontal size [Decimal 1 byte] x [Decimal 1 byte] 0 [Decimal 1 byte] 18 [Decimal 1 byte] 32 [Decimal 1 byte] 26 [Decimal 1 byte] 36 [Decimal 1 byte] 36 [Decimal 1 byte] 48	<ul style="list-style-type: none"> ECC200 square Horizontal no. of cells: Same value as vertical size (x) <ul style="list-style-type: none"> ECC200 rectangular 1 When the vertical size is "AUTO" Horizontal no. of cells: AUTO (default value) 2 When the vertical size is 8 cells Horizontal no. of cells: 18 cells Horizontal no. of cells: 32 cells 3 When the vertical size is 12 cells Horizontal no. of cells: 26 cells Horizontal no. of cells: 36 cells 4 When the vertical size is 16 cells Horizontal no. of cells: 36 cells Horizontal no. of cells: 48 cells	
5. Reserved [Decimal 1 byte]×5 0	5 bytes of dummy data (0) is sent.	

*Note:

If the vertical size is set to a value other than those listed for ECC200 square, the "AUTO" setting is selected. If the horizontal size is set to a value different from the vertical size, the setting is changed to the same value as the horizontal size.

If the vertical or horizontal size for ECC200 rectangular is set to a value other than those listed, the "AUTO" setting is selected.

② [Bar code data]: Bar code data

The maximum number of bar code data that can be entered is listed below.

2335 alphanumeric characters, 3116 numbers, 1556 bytes of binary data

***Note:**

The numbers of characters that can be entered (as listed above) are for the maximum vertical × horizontal cell settings (144 cells × 144 cells). The number of characters that can be entered may decrease, depending on the specified settings.

③ \\\: End of bar code

There must be three backslashes at the end of 2D bar codes.

Sample input

For data “12345” with symbol type ECC square at 40 × 40 with a 3-dot cell size, the command will be as shown below.

ESC iD 03h 00h 28h(40d) 28h 00h 00h 00h 00h 00h “12345” \\\

ESC i M 2D bar code MaxiCode control

[ASCII] ESC i M or m data
 [Decimal] 27 105 77 or 109 data
 [Hexadecimal] 1B 69 4D or 6D data

• Format

ESC i M or m [Parameters] \ [Bar code data] \\

 1 2 3 4

① Parameters

If a value other than those listed is entered for a parameter, that parameter is set to its default value.

1. Symbol type [Decimal 1 byte] 0 [Decimal 1 byte] 1 [Decimal 1 byte] 2	Standard (default value) Full EEC Structured carrier message	
2. Append mode [Decimal 1 byte] 0 [Decimal 1 byte] 1	Structured append (default value) Not appended	

② \

Separator between parameters and bar code data

③ Bar code data

The number of bar code data that can be entered is listed below.

Symbol type	Maximum amount of information allowed	
	Alphanumeric characters	Numbers
Standard	93	138
Full EEC	77	113
Structured carrier message	84	126

*Notes:

The numbers of characters that can be entered (as listed above) are for when using only the common character set (code set A in the MaxiCode specifications). The number of characters that can be entered may decrease, depending on the characters that are used.

When the symbol type is the structured carrier message, the service class, country code and postal code can be specified separately from the normal data. Specify each value,

separated by a backslash and comma (\,), immediately before the normal data.

`<postal_code>\,<country_code>\,<service_class>\,<normal_bar_code_data>`

When “\,” is not used three times, the data is written as shown in the following example.

Example `<data1>\,<data2>\,<normal_bar_code_data>`

⇒ Postal code = data1

⇒ Country code = data2

⇒ Service class = default value

If a value other than those listed is entered for a parameter, that parameter is set to its default value.

Postal code 9 or less numbers, or 6 or less alphanumeric characters	Ignored when not structured carrier message. Default value: 000000000
Country code 3 or less numbers	Ignored when not structured carrier message. Default value: 000
Service class 3 or less numbers	Ignored when not structured carrier message. Default value: 000

*Notes:

If the postal code is specified as alphanumeric characters, characters other than those listed below are invalid.

A~Z “ # \$ % & ‘ () * + , - . / 0~9 :

However, lowercase letters (a~z) are converted to the valid uppercase letters (A~Z).

④ \\: End of bar code

There must be three backslashes at the end of 2D bar codes.

ESC i F Print downloaded data

[ASCII] ESC i F P n

[Decimal] 27 105 70 80 n

[Hexadecimal] 1B 69 46 50 n

[Parameters]

n : file header index

$0 \leq n \leq 98$

[Description]

- Expands downloaded data in the print buffer as image data.
- Expands downloaded image data from the print position.
- If there is no image data, this command is ignored.

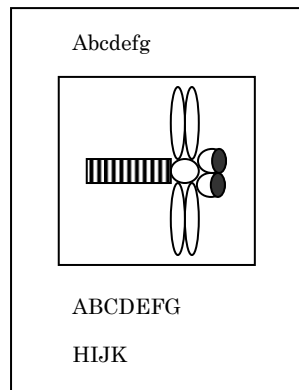
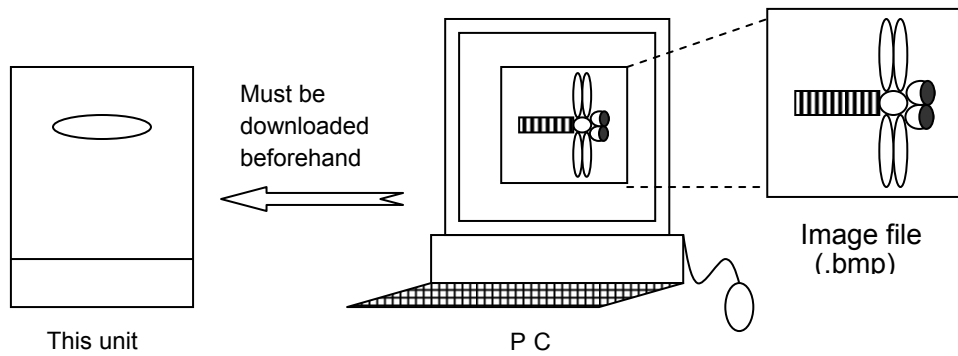

Example: Combination of text and downloaded image

- As with text, if the image data does not all fit on the current line, an automatic line feed is performed, and the data is placed at the beginning of the next line. At that time, the section exceeding the print area is deleted.

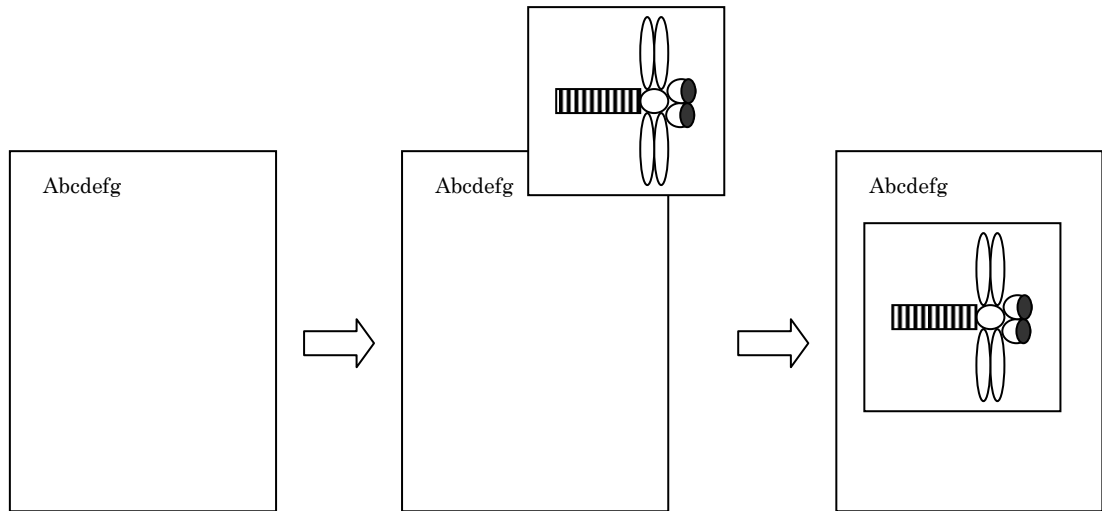

1. Enter text.

2. Enter downloaded image after an automatic line feed.

3. Since the image does not fit, it is pasted in after an automatic line feed.

Example: Normal size

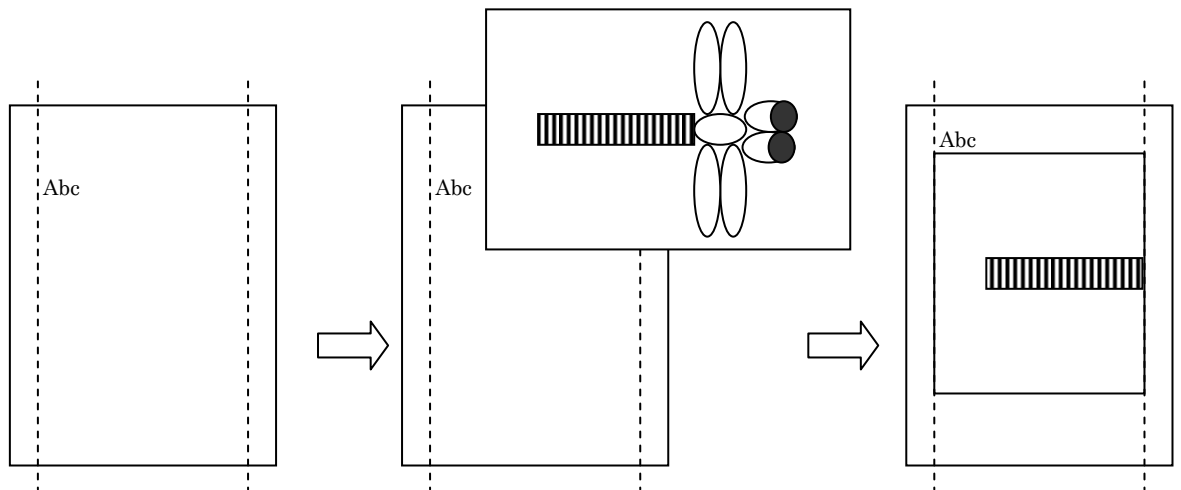

1. Enter text.

2. Enter downloaded image.

3. Since the image does not fit, it is pasted in after an automatic line feed and trimmed to fit between the left and right margins.

Example: Larger than distance between left and right margins

- If the result of pasting in the downloaded image exceeds the bottom margin position, it is pasted in after a page feed. However, if the downloaded image is larger than the entire area between the top and bottom margins, the entire image is ignored.

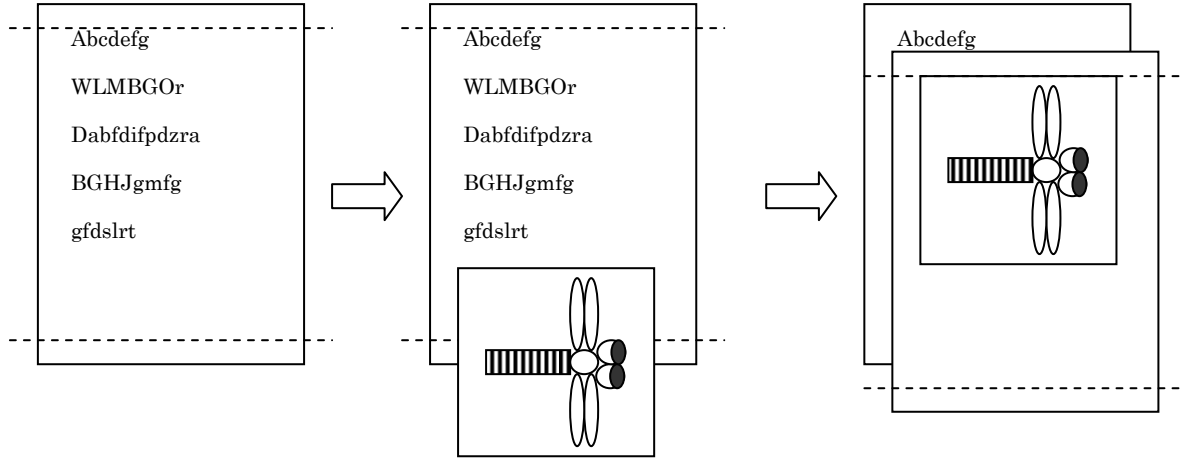

1. Enter text.

2. Enter downloaded image.

3. Since the image does not fit, it is pasted in after an automatic page feed.

Example: Data is smaller than the distance between the top and bottom margins

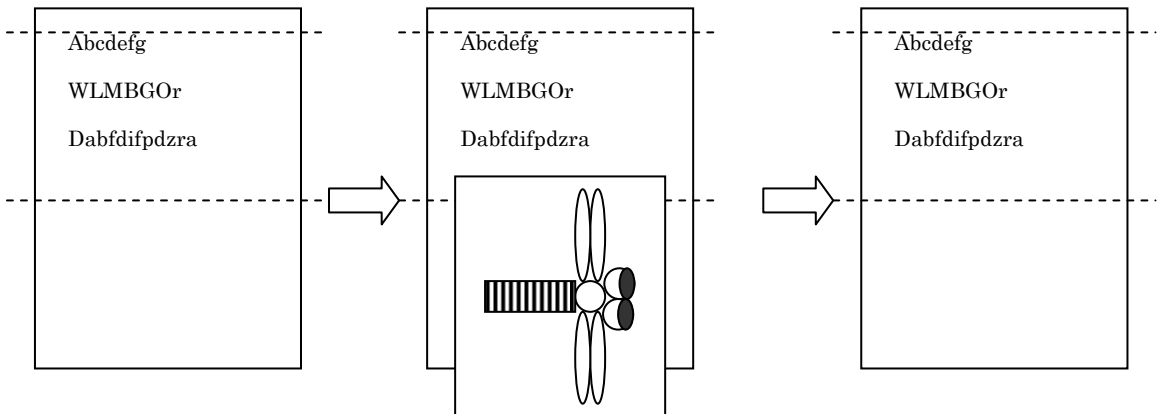

1. Enter text.

2. Enter downloaded image.

3. The entire image is ignored.

Example: Data is larger than the distance between top and bottom margins

- There are limits on the amount of image data that can be stored in the main unit. The size of the storage area is 2048 KB. However, bitmap data is not stored as is, but is converted into the main unit storage format by the transfer manager.
 - Image data larger than the media size is handled by deleting the portion of the image that does not fit into the size of the media.
- The portion of image data deleted depends on the media orientation.

Examples

Portrait (media: die-cut shipping)

Size of downloaded image	Print size	
1109 vertical x 696 horizontal	-> 1109 vertical x 696 horizontal	(No deletion)
696 vertical x 1109 horizontal	-> 696 vertical x 696 horizontal	(Part deleted)

*With downloaded image saved as 696 vertical
by 1109 horizontal*

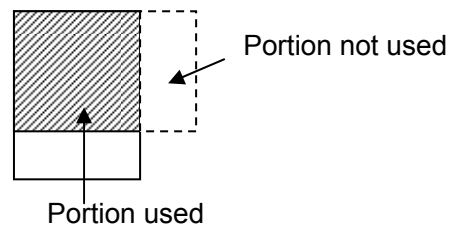

Landscape (media: die-cut shipping)

Size of downloaded image	Print size	
696 vertical x 1109 horizontal	-> 1109 vertical x 696 horizontal	(No deletion)
1109 vertical x 696 horizontal	-> 696 vertical x 696 horizontal	(Part deleted)

*With downloaded image saved as 1109 vertical by
696 horizontal*

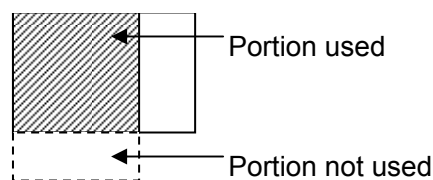

ESC i a Switch command mode

[ASCII] ESC i a n

[Decimal] 27 105 97 n

[Hexadecimal] 1B 69 61 n

[Parameters]

n : Command mode

0 or 48 = ESC/P standard mode

1 or 49 = Raster graphics

3 or 51 = P-touch Template mode

[Description]

- Sets the command mode to ESC/P, P-touch Template and PTCBP (raster graphics).
- These three modes can be switched dynamically.
- Since this is a dynamic command, after the unit is turned off and on again, the setting returns to the previously set value.

ESC i S Request printer status

[ASCII] ESC i S

[Decimal] 27 105 83

[Hexadecimal] 1B 69 53

[Parameters] None

[Description]

- Requests the printer status.

The printer status comprises 32 bytes.

Order	Offset	Size	Name	Value/Standard
1	0	1	Head mark	Fixed to 80H
2	1	1	Size	Fixed to 20H
3	2	1	Brother code	Fixed to "B" (42H)
4	3	1	Series code	Fixed to "5" (35H)
5	4	1	Model code	TD-4000: Fixed to "1" (31H) TD-4100N: Fixed to "2" (32H)
6	5	1	Country code	Fixed to "0" (30H)
7	6	1	Main unit information	Fixed to 00H
8	7	1	Reservation	Fixed to 00H
9	8	1	Error information 1	See below.
10	9	1	Error information 2	See below.
11	10	1	Media width	See Page 9 Print Area.
12	11	1	Media type	See below.
13	12	1	Number of colors	Fixed to 00H
14	13	1	Media length (upper byte)	See Page 9 Print Area.
15	14	1	Media sensor value	See Page 9 Print Area.
16	15	1	Mode	Fixed to 00H
17	16	1	Density	Fixed to 00H
18	17	1	Media length (lower byte)	See Page 9 Print Area.
19	18	1	Status type	See below.
20	19	1	Phase type	Fixed to 00H
21	20	1	Phase number (upper byte)	Fixed to 00H
22	21	1	Phase number (lower byte)	Fixed to 00H
23	22	1	Notification number	Not used
24	23	1	Expansion section (number of bytes)	Fixed to 00H
25	24	8	Reservation	Fixed to 00H

Error information 1

Flag	Mask	Meaning
Bit 0	0x01	No media error
Bit 1	0x02	Media end error
Bit 2	0x04	Cutter jam error
Bit 3	0x08	Not used
Bit 4	0x10	Main unit in use
Bit 5	0x20	Power Off
Bit 6	0x40	Not used
Bit 7	0x80	Fan motor error

Error information 2

Flag	Mask	Meaning
Bit 0	0x01	Media change error
Bit 1	0x02	Buffer full error
Bit 2	0x04	Communication error
Bit 3	0x08	Image generation error
Bit 4	0x10	Cover open error
Bit 5	0x20	Not used
Bit 6	0x40	Leading edge detection error
Bit 7	0x80	System error

Media type

Media type	Value	Remarks
Continuous length label	4AH	
Die-cut label	4BH	

Status type

Status type	Value
Reply to status request	00H
(Not used)	01H
Error generation	02H
(Not used)	03H - FFH

ESC i L Select landscape orientation

[ASCII] ESC i L n

[Decimal] 27 105 76 n

[Hexadecimal] 1B 69 4C n

[Parameters] n=0, 1 or 48, 49

[Description]

- Specifies and cancels the landscape orientation
- When n = 1 or 49 ("1"), the landscape orientation is specified.
- When n = 0 or 48 ("0"), the landscape orientation is cancelled.
- When this command is executed, all text is cleared.
- Set the paper orientation with this command before creating text.
- When the unit is turned on, landscape orientation is off.

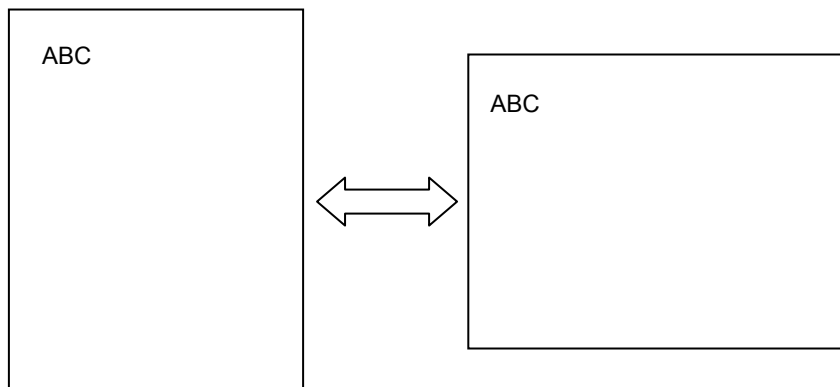

ESC i C Specify cutting

[ASCII] ESC i C n

[Decimal] 27 105 67 n

[Hexadecimal] 1B 69 43 n

[Parameters] n=0,1 or 48,49

[Description]

- Specifies the cutting after printing.
- When n = 1 or 49 ("1"), cutting is specified.
- When n = 0 or 48 ("0"), cutting is cancelled.
- The default auto cut setting can be changed with the P-touch Template Settings Tool (P-touch Template Settings.exe).
- The number of auto cut copies can be specified with the P-touch Template Settings Tool (P-touch Template Settings.exe).
- Manufacturer's default auto cut setting ON (auto cut)
- Manufacturer's default auto cut copies 1

ESC iXQ2 Select default character style

[ASCII]	ESC i X Q 2 n1 n2 n3
[Decimal]	27 105 88 81 50 n1 n2 n3
[Hexadecimal]	1B 69 58 51 32 n1 n2 n3
[Parameters]	n1:01h (Fixed) n2:00h (Fixed) 00h ≤ n3 ≤ 04h

[Description]

- Selects the default character style.
n3=00h: Cancel (normal characters) *Manufacturer's default
n3=01h: Bold
n3=02h: Outline
n3=03h: Shadow
n3=04h: Shadow and outline
- This command is a static command.

[Remarks]

- Invalid if n3 is a value other than 00h through 04h

ESC iXQ1 Retrieve default character style

[ASCII] ESC i X Q 1 n1 n2
[Decimal] 27 105 88 81 49 n1 n2
[Hexadecimal] 1B 69 58 51 31 n1 n2
[Parameters] n1:00h (Fixed)
 n2:00h (Fixed)

[Description]

- The default character style setting is returned as 3-byte data.

[1]:01h (Fixed)

[2]:00h (Fixed)

[3]:Setting

00h: Cancel (normal characters)

01h: Bold

02h: Outline

03h: Shadow

04h: Shadow and outline

- The retrieved value is a value specified by a static command.

ESC iXk2 Select default font

[ASCII] ESC i X k 2 n1 n2 n3
[Decimal] 27 105 88 107 50 n1 n2 n3
[Hexadecimal] 1B 69 58 6B 32 n1 n2 n3
[Parameters] n1:01h (Fixed)
 n2:00h (Fixed)
 00h≤ n3≤04h, 09h≤ n3≤0Bh

[Description]

- Selects the default font.
 - n3=00h: Brougham (bitmap) *Manufacturer's default
 - n3=01h: Letter Gothic Bold (bitmap)
 - n3=02h: Brussels (bitmap)
 - n3=03h: Helsinki (bitmap)
 - n3=04h: San Diego (bitmap)
 - n3=09h: Letter Gothic (outline)
 - n3=0Ah: Brussels (outline)
 - n3=0Bh: Helsinki (outline)
- This command is a static command.

[Remarks]

- Invalid if n3 is a value outside of the allowable range

ESC iXk1 Retrieve default font

[ASCII] ESC i X k 1 n1 n2
[Decimal] 27 105 88 107 49 n1 n2
[Hexadecimal] 1B 69 58 6B 31 n1 n2
[Parameters] n1:00h (Fixed)
 n2:00h (Fixed)

[Description]

- The default font setting is returned as 3-byte data.

[1]:01h (Fixed)

[2]:00h (Fixed)

[3]:Setting

00h: Brougham (bitmap)

01h: Letter Gothic Bold (bitmap)

02h: Brussels (bitmap)

03h: Helsinki (bitmap)

04h: San Diego (bitmap)

09h: Letter Gothic (outline)

0Ah: Brussels (outline)

0Bh: Helsinki (outline)

- The retrieved value is a value specified by a static command.

ESC iXX2 Specify default character size

[ASCII]	ESC	i	X	X	2	n1	n2	n3	n4
[Decimal]	27	105	88	88	50	n1	n2	n3	n4
[Hexadecimal]	1B	69	58	58	32	n1	n2	n3	n4
[Parameters]	n1:02h (Fixed)								
	n2:00h (Fixed)								
	00h≤ n3≤FFh								
	00h≤ n4≤01h								

[Description]

- Specifies the default character size.
n3+(n4*256): Default character size (dots)
- The following settings (dots) are valid.
24, 32, 33, 38, 42, 46, 48, 50, 58, 67, 75, 83, 92, 100, 117, 133, 150, 167, 200, 233, 267, 300, 333, 367, 400
*The manufacturer's default is 32.
- This command is a static command.

[Remarks]

- Invalid if the setting is a value outside of the allowable range

ESC iXX1 Retrieve default character size
--

[ASCII]	ESC i X X 1 n1 n2
[Decimal]	27 105 88 88 49 n1 n2
[Hexadecimal]	1B 69 58 58 31 n1 n2
[Parameters]	n1:00h (Fixed) n2:00h (Fixed)

[Description]

- The default character size setting is returned as 4-byte data.

[1]: 02h (Fixed)

[2]: 00h (Fixed)

[3, 4]: n3 n4 Settings

n3+(n4*256): Default character size (dots)

- The retrieved value is a value specified by a static command.

ESC iX32 Specify default line feed

[ASCII]	ESC i X 3 2 n1 n2 n3 n4
[Decimal]	27 105 88 51 50 n1 n2 n3 n4
[Hexadecimal]	1B 69 58 33 32 n1 n2 n3 n4
[Parameters]	n1:02h (Fixed) n2:00h (Fixed) 00h≤ n3≤FFh 00h≤ n4≤04h

[Description]

- Specifies the default line feed.
n3+(n4*256): Default line feed (dots) (0 through 1275)
*The manufacturer's default is 48.
- This command is a static command.

[Remarks]

- Invalid if the setting is a value outside of the allowable range

ESC iX31 Retrieve default line feed

[ASCII] ESC i X 3 1 n1 n2
[Decimal] 27 105 88 51 49 n1 n2
[Hexadecimal] 1B 69 58 33 31 n1 n2
[Parameters] n1:00h (Fixed)
 n2:00h (Fixed)

[Description]

- The default line feed setting is returned as 4-byte data.
 - [1]: 02h (Fixed)
 - [2]: 00h (Fixed)
 - [3, 4]: n3 n4 Settings
 - n3+(n4*256): Default line feed (dots)
- The retrieved value is a value specified by a static command.

ESC iXA2 Select default alignment

[ASCII] ESC i X A 2 n1 n2 n3
[Decimal] 27 105 88 65 50 n1 n2 n3
[Hexadecimal] 1B 69 58 41 32 n1 n2 n3
[Parameters] n1:01h (Fixed)
 n2:00h (Fixed)
 00h≤ n3≤02h

[Description]

- Selects the default alignment.
 n3=00h: Left alignment *Manufacturer's default
 n3=01h: Center alignment
 n3=02h: Right alignment
- This command is a static command.

[Remarks]

- Invalid if n3 is a value outside of the allowable range

ESC iXA1 Retrieve default alignment

[ASCII] ESC i X A 1 n1 n2
[Decimal] 27 105 88 65 49 n1 n2
[Hexadecimal] 1B 69 58 41 31 n1 n2
[Parameters] n1:00h (Fixed)
 n2:00h (Fixed)

[Description]

- The default alignment setting is returned as 3-byte data.
 [1]:01h (Fixed)
 [2]:00h (Fixed)
 [3]:Setting
 00h: Left alignment
 01h: Center alignment
 02h: Right alignment
- The retrieved value is a value specified by a static command.

ESC iX(2 Specify default page length

[ASCII]	ESC i X (2 n1 n2 n3 n4
[Decimal]	27 105 88 40 50 n1 n2 n3 n4
[Hexadecimal]	1B 69 58 28 32 n1 n2 n3 n4
[Parameters]	n1:02h (Fixed) n2:00h (Fixed) 00h≤ n3≤FFh 00h≤ n4≤2Eh

[Description]

- Specifies the default page length.
 - n3+(n4*256): Default page length (dots) (0, 229 through 11999)
 - *A default page length of 0 indicates the Auto setting.
 - *The manufacturer's default is 0.
- This command is a static command.

[Remarks]

- Invalid if the setting is a value outside of the allowable range

ESC iX(1 Retrieve default page length

[ASCII]	ESC i X (1 n1 n2
[Decimal]	27 105 88 40 49 n1 n2
[Hexadecimal]	1B 69 58 28 31 n1 n2
[Parameters]	n1:00h (Fixed) n2:00h (Fixed)

[Description]

- The default page length setting is returned as 4-byte data.

[1]: 02h (Fixed)

[2]: 00h (Fixed)

[3, 4]: n3 n4 Settings

n3+(n4*256): Default page length (dots)

*A default page length of 0 indicates the Auto setting.

- The retrieved value is a value specified by a static command.

ESC iXL2 Select default landscape orientation

[ASCII] ESC i X L 2 n1 n2 n3

[Decimal] 27 105 88 76 50 n1 n2 n3

[Hexadecimal] 1B 69 58 4C 32 n1 n2 n3

[Parameters] n1:01h (Fixed)

 n2:00h (Fixed)

 00h≤ n3≤01h

[Description]

- Selects the default landscape orientation setting.
n3=00h: Cancel landscape orientation *Manufacturer's default
n3=01h: Apply landscape orientation
- This command is a static command.

[Remarks]

- Invalid if n3 is a value outside of the allowable range

ESC iXL1 Retrieve default landscape orientation

[ASCII] ESC i X L 1 n1 n2
[Decimal] 27 105 88 76 49 n1 n2
[Hexadecimal] 1B 69 58 4C 31 n1 n2
[Parameters] n1:00h (Fixed)
 n2:00h (Fixed)

[Description]

- The default landscape orientation setting is returned as 3-byte data.

[1]:01h (Fixed)

[2]:00h (Fixed)

[3]:Setting

00h: Cancel landscape orientation

01h: Apply landscape orientation

- The retrieved value is a value specified by a static command.

ESC iXj2 Select default international character set

[ASCII] ESC i X j 2 n1 n2 n3
[Decimal] 27 105 88 106 50 n1 n2 n3
[Hexadecimal] 1B 69 58 6A 32 n1 n2 n3
[Parameters] n1:01h (Fixed)
 n2:00h (Fixed)
 00h≤ n3≤0Dh, 40h

[Description]

- Selects the default international character set.
n3=00h: U.S.A. *Manufacturer's default
n3=01h: France
n3=02h: Germany
n3=03h: U.K.
n3=04h: Denmark
n3=05h: Sweden
n3=06h: Italy
n3=07h: Spain
n3=08h: Japan
n3=09h: Norway
n3=0Ah: Denmark II
n3=0Bh: Spain II
n3=0Ch: Latin America
n3=0Dh: South Korea
n3=40h: Legal

- This command is a static command.

[Remarks]

- Invalid if n3 is a value outside of the allowable range

ESC iXj1 Retrieve default international character set

[ASCII] ESC i X j 1 n1 n2
[Decimal] 27 105 88 106 49 n1 n2
[Hexadecimal] 1B 69 58 6A 31 n1 n2
[Parameters] n1:00h (Fixed)
 n2:00h (Fixed)

[Description]

- The default international character set setting is returned as 3-byte data.

[1]:01h (Fixed)

[2]:00h (Fixed)

[3]:Setting

00h: U.S.A.

01h: France

02h: Germany

03h: U.K.

04h: Denmark

05h: Sweden

06h: Italy

07h: Spain

08h: Japan

09h: Norway

0Ah: Denmark II

0Bh: Spain II

0Ch: Latin America

0Dh: South Korea

40h: Legal

- The retrieved value is a value specified by a static command.

ESC iXm2 Select default character code table
--

[ASCII] ESC i X m 2 n1 n2 n3
[Decimal] 27 105 88 109 50 n1 n2 n3
[Hexadecimal] 1B 69 58 6D 32 n1 n2 n3
[Parameters] n1:01h (Fixed)
 n2:00h (Fixed)
 n3:00h, 01h, 02h

[Description]

- Selects the default character code table.
 n3=00h: Standard character code table *Manufacturer's default
 n3=01h: Eastern European character code table
 n3=02h: Western European character code table
- This command is a static command.

[Remarks]

- Invalid if n3 is a value outside of the allowable range

ESC iXm1 Retrieve default character code table
--

[ASCII] ESC i X m 1 n1 n2
[Decimal] 27 105 88 109 49 n1 n2
[Hexadecimal] 1B 69 58 6D 31 n1 n2
[Parameters] n1:00h (Fixed)
 n2:00h (Fixed)

[Description]

- The default character code table setting is returned as 3-byte data.

[1]:01h (Fixed)

[2]:00h (Fixed)

[3]:Setting

00h: Standard character code table

01h: Eastern European character code table

02h: Western European character code table

- The retrieved value is a value specified by a static command.

Character codes

Standard character code table for ESC/P codes

	0	1	2	3	4	5	6	7	8	9	A	B	C	D	E	F
0			SP	0	@	P	`	p	Ç	É	á	■	L	■	α	■
1			!	1	A	Q	a	q	ü	æ	í	■	⊥	■	β	±
2			”	2	B	R	b	r	é	Æ	ó	■	⊥	■	■	■
3			#	3	C	S	c	s	â	ô	ú		†	■	■	¾
4			\$	4	D	T	d	t	ä	ö	ñ	†	—	■	■	■
5			%	5	E	U	e	u	à	ò	Ñ	■	†	■	■	§
6			&	6	F	V	f	v	å	û	ª	■	■	■	μ	÷
7			,	7	G	W	g	w	ç	ù	º	■	■	■	■	■
8			(8	H	X	h	x	ê	ÿ	¿	©	ℒ	■	■	°
9)	9	I	Y	i	y	ë	Ö	®	¶	¶	⌋	■	.
A			*	:	J	Z	j	z	è	Ü	€	¶	¶	⌋	Ω	■
B			+	;	K	[k	{	ï	ç	½	¶	¶	✓	δ	■
C			,	<	L	\	l	;	î	£	¼	¶	¶	☑	■	³
D			-	=	M]	m	}	ì	¥	¡	TEL	=	■	ø	²
E			.	>	N	^	n	~	Ä	Pts	«	FAX	¶	■	■	■
F			/	?	O	_	o	DEL	Å	f	»	⌋	■	□	■	■

“■” indicates that a space is printed.

“■” indicates that the character will change if the international character set is switched.

Eastern European character code table (Windows-1250)

	0	1	2	3	4	5	6	7	8	9	A	B	C	D	E	F
0			SP	0	@	P	`	p	€	tˇ	■	°	Ř	Đ	ř	đ
1			!	1	A	Q	a	q	À	‘	ˇ	±	Á	Ń	á	ń
2			"	2	B	R	b	r	,	’	ˇ	„	Â	Ň	â	ň
3			#	3	C	S	c	s	˘	“	Ł	ł	Ǻ	Ó	ǻ	ó
4			\$	4	D	T	d	t	„	”	⊠	’	Ä	Ô	ä	ô
5			%	5	E	U	e	u	...	•	Ą	μ	Ł	Ŏ	í	ó
6			&	6	F	V	f	v	†	–		¶	Ć	Ö	ć	ö
7			’	7	G	W	g	w	‡	—	§	·	Ç	×	ç	÷
8			(8	H	X	h	x	ĭ	■	¨	‚	Č	Ř	č	ř
9)	9	I	Y	i	y	‰	™	©	ą	É	Ů	é	ů
A			*	:	J	Z	j	z	Š	š	Ş	ş	Ę	Ú	ę	ú
B			+	;	K	[k	{	<	>	«	»	Ě	Ů	ě	ů
C			,	<	L	\	l	;	Ś	ś	¬	Ł	Ě	Ü	ě	ü
D			–	=	M]	m	}	Ť	ť	–	“	Í	Ý	í	ý
E			.	>	N	^	n	~	Ž	ž	®	ł	Î	Ť	î	ț
F			/	?	O	_	o	DEL	Ž	ž	Ż	ż	Ď	ß	ď	·

“■” indicates that a space is printed.

“■” indicates that the character will change if the international character set is switched.

Western European character code table (Windows 1252)

	0	1	2	3	4	5	6	7	8	9	A	B	C	D	E	F
0			SP	0	@	P	`	p	€	■	■	°	À	Đ	à	ò
1			!	1	A	Q	a	q	~	'	i	±	Á	Ñ	á	ñ
2			”	2	B	R	b	r	,	'	ç	²	Â	Ò	â	ò
3			#	3	C	S	c	s	f	“	£	³	Ã	Ó	ã	ó
4			\$	4	D	T	d	t	„	”	¤	'	Ä	Ô	ä	ô
5			%	5	E	U	e	u	...	•	¥	μ	Å	Õ	å	õ
6			&	6	F	V	f	v	†	-		¶	Æ	Ö	æ	ö
7			'	7	G	W	g	w	‡	—	§	·	Ç	×	ç	÷
8			(8	H	X	h	x	^	~	¨	,	È	Ø	è	ø
9)	9	I	Y	i	y	‰	™	©	¹	É	Ù	é	ù
A			*	:	J	Z	j	z	Š	š	ª	º	Ê	Ú	ê	ú
B			+	;	K	[k	{	<	>	«	»	Ë	Û	ë	û
C			,	<	L	\	l	!	Œ	œ	¬	¼	Ì	Ü	ì	ü
D			-	=	M]	m	}	■	■	-	½	Í	Ý	í	ý
E			.	>	N	^	n	~	Ž	ž	®	¾	Î	Þ	î	þ
F			/	?	O	_	o	DEL	■	ÿ	—	¿	Ï	ß	ï	ÿ

“■” indicates that a space is printed.

“■” indicates that the character will change if the international character set is switched.

International character set

Compatible characters in each language when the international character set is switched

n		23	24	40	5B	5C	5D	5E	60	7B	7C	7D	7E
0	United States	#	\$	@	[\]	^	`	{		}	~
1	France	#	\$	à	°	ç	§	^	`	é	ù	è	¨
2	Germany	#	\$	§	Ä	Ö	Ü	^	`	ä	ö	ü	ß
3	Britain	£	\$	@	[\]	^	`	{		}	~
4	Denmark I	#	\$	@	Æ	Ø	Å	^	`	æ	ø	å	~
5	Sweden	#	¤	É	Ä	Ö	Å	Ü	é	ä	ö	å	ü
6	Italy	#	\$	@	°	\	é	^	ù	à	ò	è	ì
7	Spain I	Pt	\$	@	ı	Ñ	ı	^	`	¨	ñ	}	~
8	Japan	#	\$	@	[¥]	^	`	{		}	~
9	Norway	#	¤	É	Æ	Ø	Å	Ü	é	æ	ø	å	ü
10	Denmark II	#	\$	É	Æ	Ø	Å	Ü	é	æ	ø	å	ü
11	Spain II	#	\$	á	ı	Ñ	ı	é	`	í	ñ	ó	ú
12	Latin America	#	\$	á	ı	Ñ	ı	é	ü	í	ñ	ó	ú
13	Korea	#	\$	@	[₩]	^	`	{		}	~
64	Legal	#	\$	§	°	'	"	¶	`	©	®	†	™