

# brother

## Label Printer

TD-4000 / TD-4100N

### User's Guide

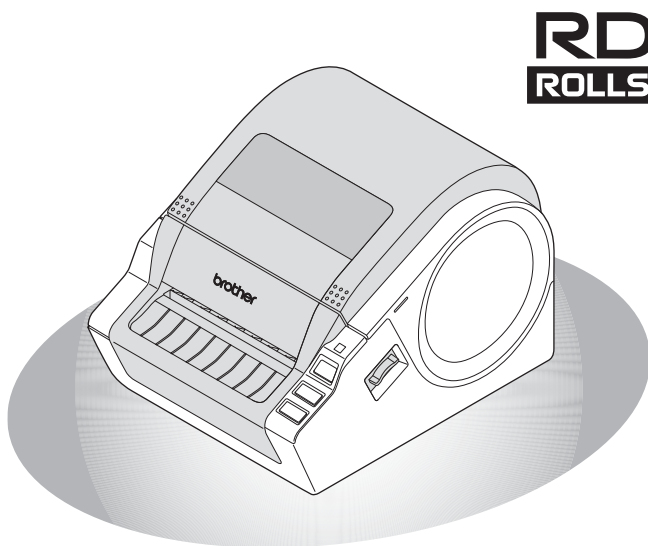

Be sure to read and understand this guide before using the machine. We recommend that you keep this guide nearby for future reference.

[www.brother.com](http://www.brother.com)

D013KK001

Introduction

STEP  
1

Getting started

STEP  
2

Installing the software

STEP  
3

Reference

Thank you for purchasing the Brother TD-4000/4100N.  
This guide briefly describes the steps to start using the Brother TD-4000/4100N.  
See the Software User's Guide and Network User's Guide for more details. Those manuals can be found in the Manuals folder of the included CD-ROM.

We strongly recommend that you read this guide carefully before using the Brother TD-4000/4100N, and then keep it nearby for future reference.

**We provide service & support for users who register their products on our website.  
We recommend that you take this opportunity to register with us by visiting us at:**

**Online Support Page**  
**[support.brother.com](http://support.brother.com)**

**NOTE:** It is also possible to access the above sites from the online user registration window of the included CD-ROM. We look forward to your registration.

**Declaration of Conformity**  
(Europe/Turkey only)

We, Brother Industries, Ltd.  
15-1, Naeshiro-cho, Mizuho-ku,  
Nagoya 467-8561 Japan

declare that this product is in conformity with the essential requirements of all relevant directives and regulations applied within the European Community.

The Declaration of Conformity (DoC) can be downloaded from our website. Visit [support.brother.com](http://support.brother.com) and:

- select "Europe"
- select your country
- select "Manuals"
- select your model
- select "Declaration of Conformity"
- click "Download"

Your Declaration will be downloaded as a PDF file.

# Contents

## **Introduction ..... 1**

- General Information ..... 1
- Safety Precautions ..... 2
  - General Precautions ..... 5

## **STEP 1 Getting started ..... 6**

- 1 Unpacking the TD-4000/4100N ..... 6
- 2 Parts Description ..... 7
- 3 LED Lamp ..... 8
- 4 Flow for Creating Labels ..... 9
- 5 Additional Functions ..... 10
  - ESC/P commands ..... 10
  - P-touch Transfer Express ..... 10
  - P-touch Template ..... 10
  - Distributed printing ..... 10
- 6 Connecting the Power Supply ..... 11
- 7 Setting the RD Roll ..... 12
- 8 Using Interface Cables ..... 14
  - Serial Cable ..... 14

## **STEP 2 Installing the software ..... 15**

- 1 Installing the Software for TD-4000 ..... 15
- 2 Installing the Software for TD-4100N ..... 17
- 3 Uninstalling Software and Printer Driver ..... 24
  - Uninstalling P-touch Editor ..... 24
  - Uninstalling the Printer Driver ..... 24
- 4 Printing the printer settings ..... 26
  - Printing the list of templates ..... 26

## **STEP 3 Reference ..... 27**

- 1 Maintenance ..... 27
- 2 Troubleshooting ..... 28
- 3 Main Specifications ..... 31
  - Accessories ..... 32

# General Information

## ■Compilation and Publication Notice

Under the supervision of Brother Industries Ltd., this guide has been compiled and published, covering the latest product's descriptions and specifications.

The contents of this guide and the specifications of this product are subject to change without notice.

If new versions of the TD-4000/4100N software become available, this manual may not reflect the updated features. Therefore, you may find that the software and the contents in this guide are different.

Brother reserves the right to make changes without notice in the specifications and materials contained herein and shall not be responsible for any damages (including consequential) caused by reliance on the materials presented, including but not limited to typographical and other errors relating to the publication.

The screen images in this guide may differ depending on your OS or printer.

© 2019 Brother Industries Ltd.

## ■Trademarks and Copyrights

Microsoft, Windows Vista, Windows Server and Windows are registered trademarks of Microsoft Corporation, in the United States and/or other countries.

QR Code is registered trademarks of DENSO WAVE INCORPORATED in JAPAN and other countries. QR Code Generating Program Copyright © 2008 DENSO WAVE INCORPORATED. BarStar Pro Encode Library (DataMatrix, MaxiCode, PDF417, RSS) Copyright © 2007 AINIX Corporation. All rights reserved.

The names of other software or products used in this document are trademarks or registered trademarks of the respective companies that developed them.

Each company whose software title is mentioned in this guide has a Software Licence Agreement specific to its proprietary programs.

Any trade names and product names of companies appearing on Brother products, related documents and any other materials are all trademarks or registered trademarks of those respective companies.

## ■Symbols Used in this Guide

The symbols used throughout this guide are as follows:

⚠ This symbol shows information or directions that should be followed. If ignored, the result may be injury, damage, or failed operations.

✍ This symbol shows information or directions that can help you better understand and use the machine more efficiently.

## ■Open Source Licensing Remarks

This product includes open-source software.

Please see Open Source Licensing Remarks and Copyright information on the supplied CD-ROM "X:\License.txt" (where X is your drive letter).



## Information for compliance with Commission Regulation 801/2013

	TD-4000	TD-4100N
Power consumption*	1.1 W	1.9 W







\* All network ports activated and connected

# Safety Precautions













Read and understand all of these instructions and save them for later reference. Follow all warnings and instructions marked on the product.

 <b>WARNING</b>	Tells you what to do to avoid accidents and the risk of injury.
 <b>CAUTION</b>	Tells you about procedures you must follow to avoid minor personal injury or damage to the printer.

The safety and precaution symbols in this guide are as follows:

	Action NOT allowed to do		DO NOT disassemble the product.
	DO NOT splash the product with or immerse the product in water.		DO NOT touch a given portion of the product.
	Mandatory action		Unplugging
	Alerts to the possibility of electrical shock		

## ■ To use the machine safely

 <b>WARNING</b>	
<b>Follow these guidelines to avoid fire, damage, electric shock, failure or the risk of injury.</b>	
<b>■ The Machine</b>	
<ul style="list-style-type: none"> <li> Unplug the power cord immediately and stop using the machine during an electrical storm. There may be a remote risk of electric shock from lightning.</li> <li> Do not touch any metal parts near the print head. The print head becomes very hot during use and remains very hot immediately after use. Do not touch it directly with your hands.</li> <li> Plastic bags are used in the packaging of your machine. To avoid danger of suffocation, keep these bags away from babies and children.</li> <li> Unplug the power cord immediately and stop using the machine if you notice any abnormal odour, heat, discoloration, deformation or anything unusual whilst the machine is in use or storage.</li> <li> Do not disassemble the machine. For inspection, adjustment and repair of the machine contact the retail outlet where the machine was purchased or your local authorized service center.</li> </ul>	<ul style="list-style-type: none"> <li> To prevent damage, do not drop or hit the machine.</li> <li> Do not hold and lift the machine by the RD Roll compartment cover. The cover could come off and the machine could fall and become damaged.</li> <li> Do not allow the machine to get wet in any way.</li> <li> The electrical outlet should be close to the machine and be easily accessible.</li> <li> Do not touch the cutter. Personal injury could result.</li> <li> Do not hold the machine with only one hand. The machine may slip out of your hand.</li> <li> Never disassemble the machine or allow it to get wet to avoid possible fire or electrical shock.</li> </ul>

## ! WARNING

- !** Do not use paint thinner, benzene, alcohol or any other organic solvents to clean the machine. Doing so may cause damage to the surface finish. Use a soft, dry cloth to clean the machine.
- !** Do not put any heavy objects or objects containing water on top of the machine.
- !** If water or any foreign object enters the machine, unplug the power cord and contact the retail outlet where the machine was purchased or your local authorized service center. If you continue to use the machine with water or a foreign object in the machine, the machine may be damaged or personal injury could result.

**Follow these guidelines to avoid fire, damage, electric shock, failure or the risk of injury.**

### ■ Power Cord

- ⊘** Use only the authorized power source (AC 220-240V) for the machine.
- ⊘** Do not use the power cord if it is damaged.
- !** Use only the power cord included with the machine.
- !** Make sure that the plug is fully inserted in the power outlet. Do not use an outlet that is loose.
- ⊘** Do not touch the power cord or power plug with wet hands.
- !** Always hold the power cord when unplugging the power cord from or plugging it into electrical outlet. Do not pull on the power cord. The wire in the electrical cord may become damaged.
- ⊘** Do not overload the electrical outlet sockets with too many appliances or plug the power cord into a damaged electrical outlet.
- ⊘** Do not cut, damage, alter or place heavy objects on the power cord.

## ! CAUTION

**Follow these guidelines to avoid minor personal injury and damage to the machine.**

### ■ The Machine

- !** Do not expose the machine to direct sunlight or near heaters or other hot appliances, in any area exposed to extremely high or low temperatures, high humidity or dusty areas. Doing so could cause the machine to malfunction.

### ■ Power Cord

- ⊘** If the machine will not be used for an extended period, remove the power cord from the electrical outlet.

### ■ Cutter

- ⊘** Do not touch the blade of the cutter.
- ⊘** Do not open the RD Roll compartment cover when the cutter is operating.

### ■ Installation/Storage

- !** Place the machine on a flat, stable surface such as a desk.
- ⊘** Do not place any heavy objects on top of the machine.

**⚠ CAUTION****■ RD Roll**

- ❗ Be careful not to drop the RD Roll.
- ❗ RD Rolls use thermal paper. Both the label and print will fade with sunlight and heat. Do not use RD Rolls for outdoor use that requires durability.
- ❗ Depending on the area, material, and environmental conditions, the label may unpeel or become irremovable, the colour of the label may change or be transferred to other objects. Before applying the label, check the environmental condition and the material. Test the label by affixing a small piece of it to an inconspicuous area of the intended surface.

## General Precautions

### ■ The Machine

- The machine is a precision machine. Do not drop or hit the machine.
- Do not lift the machine by the RD Roll compartment cover. The cover could come off and the machine could fall and become damaged.
- The machine may malfunction if left near a television, radio, etc. Do not use the machine near any machine that can cause electromagnetic interference.
- Do not insert any objects into or block the label output slot, USB port, Serial port or LAN port.
- Use only the interface cable (USB cable) included with the machine.
- Do not attempt to print labels while the RD Roll compartment cover is open.
- For information about your model's electrical rating, see the label attached to the base of the machine.

### ■ Power Cord

- This product must be installed near an electrical socket that is easily accessible. In case of emergencies, you must disconnect the power cord from the electrical socket to shut off power completely.

### ■ RD Roll

- Use only genuine Brother accessories and supplies (with  mark).
- If the label is attached to a wet, dirty, or oily surface, it may peel off easily. Before applying the label, clean the surface to which the label will be applied.
- RD Roll uses thermal paper so that ultraviolet rays, wind, and rain may cause the colour of the label to fade and the ends of the label to peel off.
- Do not expose the RD Rolls to direct sunlight, high temperatures, high humidity, or dust. Store in a cool, dark place. Use the RD Rolls soon after opening the package.
- Scratching the printed surface of the label with your finger nails or metal objects, or touching the printed surface with hands dampened by water, sweat, or medicated cream, etc., can cause the colour to change or fade.
- Do not apply labels to any persons, animals, or plants. In addition, never apply labels to public or private property without permission.
- The last label in an RD Roll may not be printed correctly. For this reason, the roll contains more labels than that indicated on the package.
- When a label is removed after being applied to a surface, a portion of the label may remain.
- Some RD Rolls use permanent adhesive for their labels. These labels cannot be easily peeled off once attached.
- If the roll becomes unraveled, tighten the RD roll and realign both sides to restore the RD roll to its original form before installing into the printer.

### ■ CD-ROM and Software

- Be careful not to scratch the CD-ROM. Do not place the CD-ROM in any location exposed to high or low temperatures.
- Do not place heavy objects on the CD-ROM or bend it.
- The software on the CD-ROM is intended for use with this machine only. See the Licence on the CD for details. This software may be installed on multiple computers for use in an office, etc.



# 1 Unpacking the TD-4000/4100N

Check that the package contains the following before using the printer. If any item is missing or damaged, contact your Brother dealer.

## TD-4000/4100N

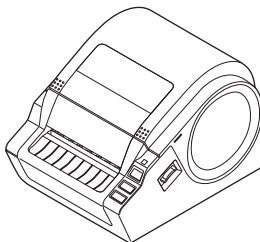

### USB cable

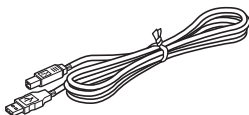

### User's Guide

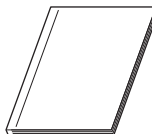

### CD-ROM



### AC Power cord



The plug may differ by countries.

### RD Roll (Starter roll)



The Brother TD-4000/4100N includes two starter rolls of labels:

- One starter roll of 102 mm Continuous length label 2 m
- One starter roll of 51 mm × 26 mm Die-Cut Labels (60 labels)

## 2 Parts Description

### ■Front

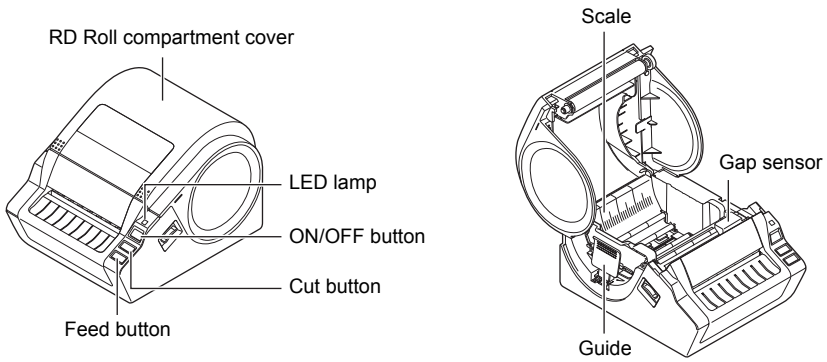

### ■Rear

<TD-4000>

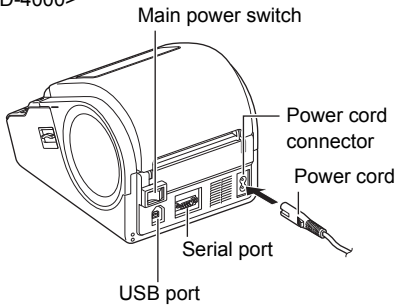

<TD-4100N>

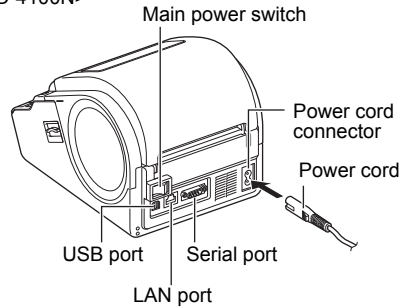

## 3 LED Lamp

The lamp on the Brother TD-4000/4100N indicates the current operating condition.

Lamp	Condition
Not lit ○	Power is OFF.
Green lamp is lit ●	Power is ON.
Green lamp is flashing ○●○●○●	Receiving data from PC.
Orange lamp is lit ●	The RD Roll compartment cover is opened. (Close the RD Roll compartment cover correctly).
Orange lamp is flashing ○●○●○●	Cooling (Wait for temperature of print head to lower, and printing will continue).
Red lamp is lit ●	Firmware upgrade error. (Please retry the firmware upgrade procedure).
Red lamp is flashing ○●○●○●	Indicates one of the following errors. <ul style="list-style-type: none"> <li>• Label sensor error (End of RD Roll or label jam)</li> <li>• Incorrect RD Roll installed</li> <li>• Transmission error</li> </ul>

## 4 Flow for Creating Labels

Labels can be created by using P-touch Editor. For details, see → the Software User's Guide on the CD-ROM.

Follow the procedure described below to prepare for making labels.

### 1 Connect the machine to the power source.

For details, see "Connecting the Power Supply" on page 11.

### 2 Install the software.

Install the printer driver to use the TD-4000/4100N as a printer with the PC and install the label design software.

For TD-4000, see "Installing the Software for TD-4000" on page 15.

For TD-4100N, see "Installing the Software for TD-4100N" on page 17.

### 3 Specify the paper or label size.

The label width and length, and the label spacing can be specified from the printer properties.

For details, see the Software User's Guide on the CD-ROM.

### 4 Print labels.

- Printing from the P-touch Editor  
Start the P-touch Editor to create labels.
- Printing from other applications  
Choose [File] - [Print]. (The printing procedure may differ depending on the application being used).

For details, see the Software User's Guide on the CD-ROM.

## 5 Additional Functions

### ESC/P commands

Fonts and several bar codes are embedded within this machine. You can send commands to print embedded characters and barcodes.

Commands available are Brother TD proprietary commands based on ESC/P.

The latest command tool can be downloaded from the following website.

[support.brother.com](http://support.brother.com)

Choose your region (eg. Europe), your country, your model and Downloads for your model.

### P-touch Transfer Express

By using P-touch Transfer Express, label templates can easily be transferred to the TD-4000/4100N via USB.

After the label template has been created by the administrator, it can be distributed to users together with P-touch Transfer Express.

The user can then use P-touch Transfer Express to transfer the label template to the TD-4000/4100N.

For details, see the "Software User's Guide" in the manuals folder of the included CD-ROM.

### P-touch Template

Sending the P-touch Template command to the TD-4000/4100N allows the selection and printing of transferred templates to be controlled from the host devices.

The types of host device are as below.

- Scale, Measurement device
- Medical measurement device
- Barcode reader

With a barcode reader connected to the printer, labels and barcodes can easily be printed by scanning barcodes.

The latest command tool can be downloaded from the following website.

[support.brother.com](http://support.brother.com)

Choose your region (eg. Europe), your country, your model and Downloads for your model.

### Distributed printing

When printing a large number of labels, printing can be distributed among multiple printers. Since printing is performed at the same time, the total printing time can be reduced.

For details, see the "Software User's Guide" in the manuals folder on the including CD-ROM.

## 6 Connecting the Power Supply

- ⚠ Check that the electrical outlet is 220V-240V AC before plugging in the power cord.
- Do not connect the TD-4000/4100N to the computer until directed to do so when installing the printer driver.
- Unplug the power cord from the electrical outlet after you have finished using the TD-4000/4100N.
- Do not pull the power cord when unplugging it from the electrical outlet. The wire in the power cord may become damaged.

- 1** Check that the main power switch is turned off.

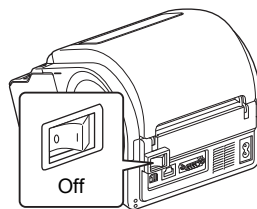

- 2** Connect the power cord to the TD-4000/4100N.

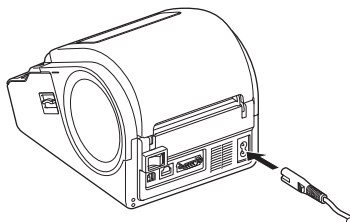

- 3** Plug the power cord into an electrical outlet.

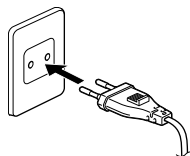

The plug may differ by country.

- 4** Turn the main power switch on.

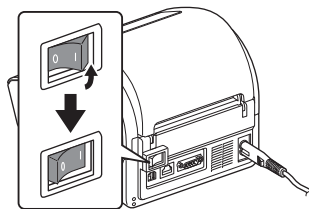

## 7 Setting the RD Roll

- 1** Press and hold the ON/OFF button (⏻) to turn the TD-4000/4100N off. Pull up the left and right levers on the TD-4000/4100N under the RD Roll compartment cover, and open the RD Roll compartment cover.

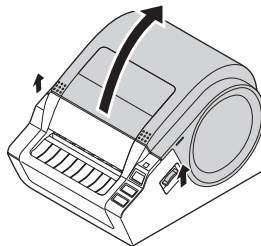

- 2** Squeeze the green lever and adjust the guide to the left most position.

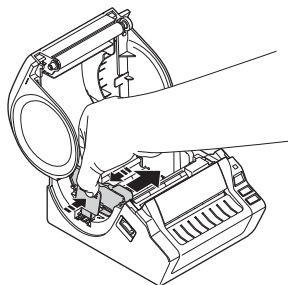

- 3** Take an RD Roll with the labels upside down and slide the end of the RD Roll under the gap (media) sensor.

⚠ If the end of the RD Roll has not been fed under the gap (media) sensor, the TD-4000/4100N may not be able to detect the media properly.

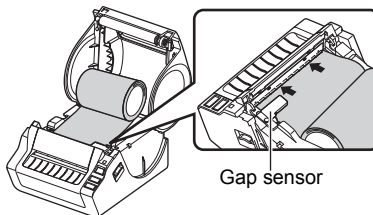

- 4** Insert the roll into the roll compartment and slide it to the right most position. Adjust the roll guide to fit the width of the RD Roll.

⚠ Incorrect insertion of the RD Roll will not print on the correct side of the label.

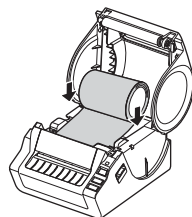

- 5** Position the end of the RD Roll to just below the black plastic cutter guard.

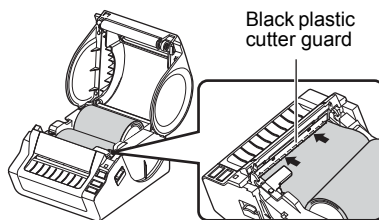

- 6** Close the RD Roll compartment cover.

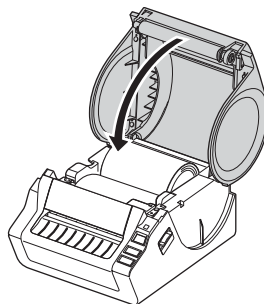

- 7** Press and hold the ON/OFF button (⏻) to turn the TD-4000/4100N on.

#### ■ Die-cut label

- 8** Press the Feed button.  
The printer will feed the label to the correct starting position.  
You are now ready to print.

#### ■ Continuous length label

- 8** Press the Feed button twice and then the Cut button.  
The printer will feed the label to the correct starting position.  
You are now ready to print.



If the media does not load correctly, trim off some of the media to produce a straight edge and repeat this loading procedure.



## 8 Using Interface Cables

RS-232C cable and Network cable are not standard accessories. Use an appropriate cable for the interface.

- USB cable  
Use the enclosed interface cable.
- RS-232C cable  
Do not use an interface cable that is longer than 2 metres.  
For details, see page 14.
- Network cable (TD-4100N)  
Use a straight-through Category 5 (or greater) twisted-pair cable for 10BASE-T or 100BASE-TX Fast Ethernet Networks.

### Important

For USB interface, the included USB interface cable should be used to ensure compliance with the limits for EMC (Electromagnetic compatibility). For serial and network interfaces, a shielded interface cable should be used to ensure compliance with the limits for EMC.

Changes or modifications not expressly approved by Brother Industries, Ltd. may affect the performance and print quality, and damage may not be covered under the limited warranty.

- ⚠ • Caution for LAN connection  
Connect this product to a LAN connection that is not subjected to overvoltages.
- Caution for RS-232C connection  
The RS-232C serial connector part of this equipment is not Limited Power Source.

### Serial Cable

The pin assignments for the serial cable (RS-232C cable) which can be used with this machine are shown in the table below. You can purchase the cable at an electronics store. Do not use an interface cable that is longer than 2 metres.

Brother TD side

D-sub female, lock screw #4-40 (UNC).

PC side

(D-Sub9P female)

Signal Name	Pin Number	Pin Assignments	Pin Number	Signal Name
DCD	1		1	DCD
RXD	2		2	RXD
TXD	3		3	TXD
DTR	4		4	DTR
GND	5		5	GND
DSR	6		6	DSR
RTS	7		7	RTS
CTS	8		8	CTS
RI	9		9	RI

- ⚠ • It is not possible to connect a RS-232C cable and USB cable to the printer at the same time.
- The RS-232C serial connector part of this equipment is not Limited Power Source.

# 1 Installing the Software for TD-4000

The procedure for installing the software varies depending on the OS of the computer. The installation procedure is subject to change without notice.

- ⚠ Please note: It is important you do not connect the printer to the computer until directed to do so.

This section explains how to install P-touch Editor 5.0, the Printer Driver and the Software User's Guide using the Standard Installation option.

The following is the screenshot for Windows Vista® or Windows® 7.

## 1 Start the computer and put the CD-ROM into the CD-ROM drive.

- 📄 If it does not start up automatically, open the files on the CD-ROM and double-click on "Setup.exe".

## 2 Click [Standard Installation].

📄 Installation items:

### 1 Standard Installation

P-touch Editor 5.0,  
Printer Driver, and  
Software User's Guide (PDF)

### 2 Custom Installation

P-touch Editor 5.0, printer driver,  
and the Software User's Guide  
(PDF) can all be installed  
separately.

### 3 Display User's Guide

Software User's Guide (PDF)  
(PDF reader software required)

### 4 Adobe Reader Download

A link to the download page for Adobe® Reader® will be displayed.



## 3 Read the licence agreement and click [Yes] if you agree with the terms and conditions.

## 4 Follow the on-screen instructions to complete the Standard Installation.

**5** Put a check mark in the box next to the Add-In programs you want to install, and click [Next].

With the Add-In feature you can easily use text from these applications in our label layouts.

ⓘ Make sure that you closed all Microsoft® Office applications.

📖 For details on the Add-In, see the "Software User's Guide (PDF)".

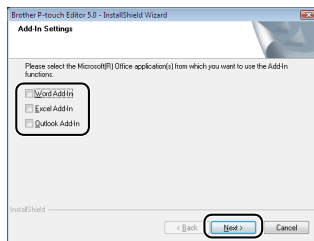

**6** Click [Next] and follow the on-screen instructions for installing the printer driver. When instructed, connect the printer to finish the printer driver installation.

- ⓘ
- For USB installation, it is important you do not connect the printer to the computer until directed to do so.
  - Before connecting the USB interface cable, remove the caution label affixed to the USB port of the machine.

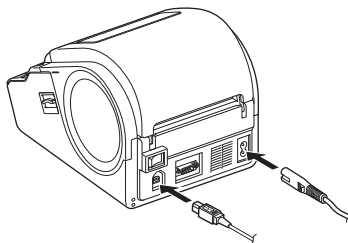

**7** Select a registration method and click [Next].

- If you choose "Yes, display the page", you will go to the online user registration page before finishing the installation (recommended).
- If you choose "No, do not display the page", you will continue the installation.

**8** When instructed to download the optional tools, select your choice and click [Next].

- If you choose "Yes, display the page", you will go to the Brother support website before finishing the installation (recommended). Choose your region (eg. Europe), your country, your model and Downloads for your model.
- If you choose "No, do not display the page", you will continue the installation.

📖 To download the optional tools later, you can find them on this website: [support.brother.com](http://support.brother.com)

Choose your region (eg. Europe), your country, your model and Downloads for your model.

**9** Click [Finish].  
The software installation is now complete.

📖 When you are asked to restart the computer, choose "Restart" and click [Finish].

**10** Start the software.

Click [Start] - [All Programs (Programs)] - [Brother P-touch] - [P-touch Editor 5.0] to start P-touch Editor.

📖 For details on software, see the "Software User's Guide" (PDF). You can find the Software User's Guide (PDF) by clicking [Start] - [All Programs (Programs)] - [Brother P-touch] - [Manuals] - [TD-4000] - [Software User's Guide].

## 2 Installing the Software for TD-4100N

The procedure for installing the software varies depending on the OS of the computer. The installation procedure is subject to change without notice.

- ⚠ Please note: When using the USB interface cable, it is important you do not connect the printer to the computer until directed to do so.

This section explains how to install P-touch Editor 5.0, the Printer Driver and the Software User's Guide and Network User's Guide using the Standard Installation option. The following is the screenshot for Windows Vista® or Windows® 7.

- 1** Start the computer and put the CD-ROM into the CD-ROM drive.  
 📁 If it does not start up automatically, open the files on the CD-ROM and double-click on "Setup.exe".

- 2** Click [Standard Installation].

📁 Installation items:

**1 Standard Installation**

P-touch Editor 5.0, Printer Driver, Software User's Guide (PDF), and Network User's Guide (PDF)

**2 Custom Installation**

P-touch Editor 5.0, printer driver, Software User's Guide (PDF) and Network User's Guide (PDF), can all be installed separately.

**3 Utility Installation**

BRAdmin Light

**4 User's Guide**

Software User's Guide (PDF), Network User's Guide (PDF), and link to the download page for Adobe® Reader®.



- 3** Read the licence agreement and click [Yes] if you agree with the terms and conditions.

- 4** Follow the on-screen instructions to complete the Standard Installation.

**5** Put a check mark in the box next to the Add-In programs you want to install, and click [Next].

With the Add-In feature you can easily use text from these applications in our label layouts.

⚠ Make sure that you closed all Microsoft® Office applications.

📄 For details on the Add-In, see the "Software User's Guide (PDF)".

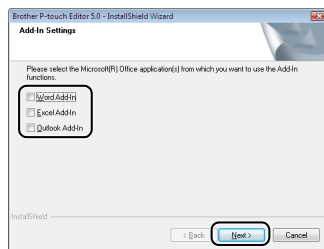

**6** Choose your connection method and click [Next].

📄 Connection method:

**1 Local Printer with USB cable**

See "For USB interface cable users" on page 19.

**2 Brother Peer-to-Peer Network Printer**

Check the LAN cable is connected to the printer.

See "For network interface cable users" on page 20.

**3 Network Shared Printer**

Check the LAN cable is connected to the printer.

See "For shared network printer users" on page 21.

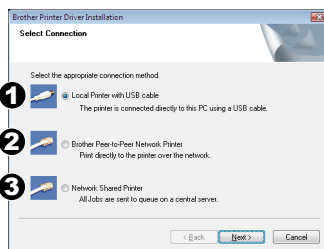

## ■ For USB interface cable users

**7** Follow the on-screen instructions for installing the printer driver. When this screen appears, confirm the printer is powered on. When instructed, connect the USB interface cable to your computer and then to the printer, to finish the printer driver installation.

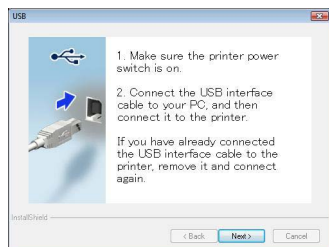

- ! • It is important you do not connect the printer to the computer until directed to do so.
- Before connecting the USB interface cable, remove the caution label affixed to the USB port of the machine.

**8** Select a registration method and click [Next].

- If you choose "Yes, display the page", you will go to the online user registration page before finishing the installation (recommended).
- If you choose "No, do not display the page", you will continue the installation.

**9** When instructed to download the optional tools, select your choice and click [Next].

- If you choose "Yes, display the page", you will go to the Brother support website before finishing the installation (recommended). Choose your region (eg. Europe), your country, your model and Downloads for your model.
- If you choose "No, do not display the page", you will continue the installation.



To download the optional tools later, you can find them on this website:  
[support.brother.com](http://support.brother.com)

Choose your region (eg. Europe), your country, your model and Downloads for your model.

**10** Click [Finish].

**11** Start the software.

Click [Start] - [All Programs (Programs)] - [Brother P-touch] - [P-touch Editor 5.0] to start P-touch Editor.



For details on software, see the "Software User's Guide" (PDF).

You can find the Software User's Guide (PDF) by clicking [Start] - [All Programs (Programs)] - [Brother P-touch] - [Manuals] - [TD-4100N] - [Software User's Guide].

## ■ For network interface cable users

**7** Choose "Search the network for devices and choose from a list of discovered devices (Recommended)." Or enter your machine's IP address or its node name. Click [Next].

 You can find your printer's IP address and the node name by printing out the printer settings page. See "Printing the printer settings" on page 26.

**8** Select your printer.

**9** Follow the on-screen instructions for installing the printer driver.

**10** Select a registration method and click [Next].

- If you choose "Yes, display the page", you will go to the online user registration page before finishing the installation (recommended).
- If you choose "No, do not display the page", you will continue the installation.

**11** When instructed to download the optional tools, select your choice and click [Next].

- If you choose "Yes, display the page", you will go to the Brother support website before finishing the installation (recommended).  
Choose your region (eg. Europe), your country, your model and Downloads for your model.
- If you choose "No, do not display the page", you will continue the installation.

 To download the optional tools later, you can find them on this website:  
[support.brother.com](http://support.brother.com)

Choose your region (eg. Europe), your country, your model and Downloads for your model.

**12** Click [Finish].

**13** Start the software.

Click [Start] - [All Programs (Programs)] - [Brother P-touch] - [P-touch Editor 5.0] to start P-touch Editor.

-  For details on software, see the "Software User's Guide" (PDF).  
You can find the Software User's Guide (PDF) by clicking [Start] - [All Programs (Programs)] - [Brother P-touch] - [Manuals] - [TD-4100N] - [Software User's Guide].
- For details on network, see the "Network User's Guide" (PDF).  
You can find the Network User's Guide (PDF) by clicking [Start] - [All Programs (Programs)] - [Brother P-touch] - [Manuals] - [TD-4100N] - [Network User's Guide].

## ■ For shared network printer users

**7** Choose your printer's queue, and then click [OK].

- ✎ Contact your administrator if you do not know the location or the name of the printer in the network.

**8** Follow the on-screen instructions for installing the printer driver.

**9** Select a registration method and click [Next].

- If you choose "Yes, display the page", you will go to the online user registration page before finishing the installation (recommended).
- If you choose "No, do not display the page", you will continue the installation.

**10** When instructed to download the optional tools, select your choice and click [Next].

- If you choose "Yes, display the page", you will go to the Brother support website before finishing the installation (recommended).  
Choose your region (eg. Europe), your country, your model and Downloads for your model.

- If you choose "No, do not display the page", you will continue the installation.

- ✎ To download the optional tools later, you can find them on this website:  
[support.brother.com](http://support.brother.com)

Choose your region (eg. Europe), your country, your model and Downloads for your model.

**11** Click [Finish].

**12** Start the software.

Click [Start] - [All Programs (Programs)] - [Brother P-touch] - [P-touch Editor 5.0] to start P-touch Editor.

- ✎ For details on software, see the "Software User's Guide" (PDF).  
You can find the Software User's Guide (PDF) by clicking [Start] - [All Programs (Programs)] - [Brother P-touch] - [Manuals] - [TD-4100N] - [Software User's Guide].
- For details on network, see the "Network User's Guide" (PDF).  
You can find the Network User's Guide (PDF) by clicking [Start] - [All Programs (Programs)] - [Brother P-touch] - [Manuals] - [TD-4100N] - [Network User's Guide].



## ■ Installing the BRAdmin Light configuration utility (TD-4100N only)

The BRAdmin Light is a utility for initial setup of Brother network connected devices. It can also search for Brother products on your network, view the status and configure basic network settings, such as IP address.

For more information on BRAdmin Light, visit us at [support.brother.com](http://support.brother.com)



- If you require more advanced printer management, use the latest Brother BRAdmin Professional utility version that is available as a download from [support.brother.com](http://support.brother.com)
- If you are using personal firewall software, BRAdmin Light may fail to detect the unconfigured device. In that case, disable your personal firewall software, try BRAdmin Light again. Re-start your personal firewall software after the address information is set.

### 1 Click [Utility Installation].



This screen is the same screen as you see when you insert the CD-ROM.



### 2 Click [BRAdmin Light] and follow the on-screen instructions.





If the Windows Firewall is enabled on your PC, the message "Do you wish to add this application to the list of exceptions?" appears. Check your PC environment and choose [Yes] or [No].

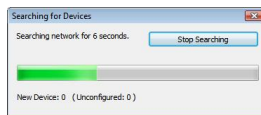

## ■ Setting your IP address, Subnet Mask and Gateway using BRAdmin Light

- 1** Click [Start]-[All Programs(Programs)]-[Brother]-[BRAdmin Light]. BRAdmin Light will search for new devices automatically.
-  If you have a DHCP/BOOTP/RARP server in your network, you don't have to do the following operation, as the print server will automatically obtain its IP address.



- 2** Double-click the unconfigured device.
-  The default password is "access".

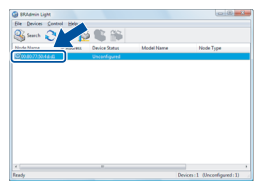

- 3** Choose STATIC for the Boot Method. Enter the IP Address, Subnet Mask and Gateway, and then click [OK].

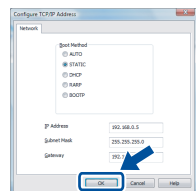

- 4** The address information will be saved to the printer.

## 3 Uninstalling Software and Printer Driver

This section describes how to uninstall the software and printer driver. In the following steps, you will see XX-XXXX. Read "XX-XXXX" as your printer name.

### Uninstalling P-touch Editor

#### 1 For Windows® XP

From [Control Panel], go to [Add or Remove Programs].  
The [Add or Remove Programs] dialog appears.

#### For Windows Vista®/Windows® 7

From the [Control Panel], go to [Programs] and open [Programs and Features].  
The [Uninstall or change a program] window appears.

#### 2 For Windows® XP

Choose "Brother P-touch Editor 5.0", and click [Remove].

#### For Windows Vista®/Windows® 7

Choose "Brother P-touch Editor 5.0", and click [Uninstall].

#### 3 Click [OK].

The uninstall operation starts. After the software is removed from your computer, the [Maintenance Complete] dialog box appears.

#### 4 Close the [Add or Remove Programs] (XP) / [Programs and Features] (Windows Vista®/Windows® 7) dialog.

P-touch Editor has been uninstalled.



The Software User's Guide (PDF) and Network User's Guide (PDF) (TD-4100N only) can also be uninstalled by following the same procedure.

### Uninstalling the Printer Driver

#### 1 Turn off the printer.

#### 2 For Windows® XP

From [Control Panel], go to [Printer and other hardware], open [Printer and Faxes] Window.

#### For Windows Vista®

From [Control Panel], go to [Hardware and Sound] and open [Printers].

#### For Windows® 7

Click the , go to [Devices and Printers].



For details, see Windows® Help.

**3** For Windows® XP

Choose "Brother XX-XXXX", and click [File]-[Delete].

**For Windows Vista®/Windows® 7**

Choose "Brother XX-XXXX", right click on the icon, and then click [Delete] (Windows Vista®)/ [Remove device] (Windows® 7).

**4** For Windows® XP

Go to [File]-[Server Properties].

**For Windows Vista®**

In the [Printers] window, right click and go to [Run as administrator]-[Server Properties...].

If the [Authorization confirmation] dialog appears, click [Continue]. If the [User Account Control] dialog appears, enter the password and click [OK].

**For Windows® 7**

Choose [Fax] or [Microsoft XPS Document Writer] in the [Devices and Printers] window, and then click [Print server properties], which appears in the menu bar.

**5** For Windows® XP

Click the [Drivers] tab and choose "Brother XX-XXXX". Then, click [Remove].

**For Windows Vista®**

Click the [Drivers] tab and choose "Brother XX-XXXX". Then, click [Remove...].

**For Windows® 7**

Click the [Drivers] tab, and then click [Change Driver Settings].

(If a User Account Control message appears, type in the password, and then click [OK]).

Choose "Brother XX-XXXX", and then click [Remove...].

**6** For Windows® XP

Go to step 7.

**For Windows Vista®/ Windows® 7**

Choose [Remove driver and driver package], and then click [OK].

**7** Close the [Print Server Properties] window.

The Printer Driver has been uninstalled.

## 4 Printing the printer settings

The printer settings page prints a report listing the network settings, etc. You can print the printer settings page using the Cut button of the printer.

 Node name: Node name appears in the printer settings page. The default Node name of the network card in the printer is "BRNxxxxxxxxxxxx" where "xxxxxxxxxxxx" is the Ethernet address.

**1** Make sure that the RD Roll set and the RD Roll compartment cover is closed.  
To print the printer settings page, we recommend to use 51 mm continuous length label.

**2** Turn on the printer.

**3** Press and hold the Cut button to print out the settings.  
You can check the IP address, etc.

## Printing the list of templates

The TD-4000/4100N is equipped with memory so label templates can be saved inside the printer. You can print a list of these label templates (maximum of 99) so that you can see which label templates are available.

**1** Install a roll of labels with a width of 51 mm or more.

**2** Press and hold the Feed button.  
The list of label templates is printed.

```
<Template List>
KEY  Name                Size   Date / Time   Connected Database Name
-----
  1  foodlabelus           588B  2010 Dec/01  12:29  foodlistus_Shee
  2  Cream                 488B  2010 Dec/01  12:29  -
  3  Milk                  484B  2010 Dec/01  12:29  -
  4  foodlabel4            506B  2010 Dec/01  12:29  foodlistus4_She

-----

<Database List>
KEY  Name                Size   Date / Time
-----
  1  foodlistus_Shee       254B  2010 Dec/24  05:03
  2  foodlistus4_She       196B  2010 Dec/24  05:03

-----

Available memory:2094252B
```

\*Labels are for illustrative purposes only.

# 1 Maintenance

Maintenance of the machine may be carried out as required. However, some environments require that maintenance must be done more frequently (e.g. in dusty conditions).

## ■ Print head maintenance

The RD Roll (thermal recording paper type) used with the machine is designed to clean the print head automatically. When the RD Roll passes the print head during printing and label feeding, the print head is cleaned. If the print head is not cleaned thoroughly use a cotton swab and wipe the head.

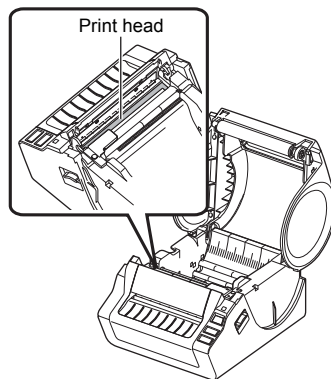

## ■ Roller maintenance

Cut the RD Roll and remove the backing paper of the label. Then, put the adhesive side of the label against the roller and remove the dirt.

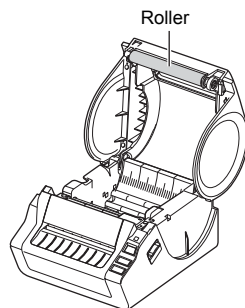

## ■ Label outlet maintenance

If glue accumulates on the label outlet and label jams occur, disconnect the power plug from the power outlet and clean the label outlet with a cloth dipped in isopropyl alcohol.

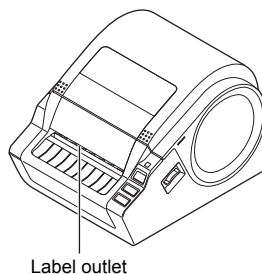

## 2 Troubleshooting

If a problem occurs while using this machine, the following may help you to solve the problems.

Problem	Solution
The Brother TD-4000/4100N machine printer does not print, or a printing error is received.	<ul style="list-style-type: none"> <li>• Is the cable loose? Check that the cable is connected securely.</li> <li>• Is the RD Roll installed correctly? If not, remove the RD Roll and reinstall it.</li> <li>• Is the RD Roll used up? Replace the RD Roll.</li> <li>• Is the RD Roll compartment cover open? Check that the RD Roll compartment cover is closed correctly.</li> <li>• Has a print error or transmission error occurred? Turn off the machine and switch on again. If the problem still occurs, contact Brother Customer Service.</li> <li>• Does the guide not touch the left side of the paper RD Roll? Move the guide against the side of the RD Roll.</li> <li>• Is the media on top of the gap sensor? Feed the media under the gap sensor.</li> </ul>
The LED lamp is not lit.	<ul style="list-style-type: none"> <li>• Is the power cord plugged in correctly? Check that the power cord is plugged in. If inserted, try plugging it into another electrical outlet.</li> <li>• Has the main power switch located on the back of the machine been turned on? Make sure the main power switch is turned on. * If the power button still does not light up, contact Brother Customer Service.</li> </ul>
The printed label contains streaks or poor quality characters, or the label did not feed correctly.	<ul style="list-style-type: none"> <li>• Is the print head or roller dirty? While the print head generally remains clean under normal use, lint or dirt from the roller may become stuck on the printer head. If this occurs, clean the roller. See → "Roller maintenance" on page 27.</li> </ul>
A data transmission error appears on the computer.	<ul style="list-style-type: none"> <li>• Is the correct port chosen? Check that the correct port is chosen from the "Print to the following port" list in the Printer Properties dialog box.</li> <li>• Is the machine in cooling mode (the LED lamp is flashing in orange)? Wait until the LED lamp stops flashing and then try printing again.</li> <li>• Is someone printing via network (TD-4100N only)? If you try to print while other users are printing large amounts of data, the printer is unable to accept your print job until the ongoing printing is finished. In such situations, execute the print job again after the other jobs are completed.</li> </ul>
Labels are jammed in the cutter or are not ejected correctly after printing.	<ul style="list-style-type: none"> <li>• Is there dirt or lint on the roller preventing it from rolling freely? For details, please see → "Roller maintenance" on page 27.</li> </ul>
The label is not ejected correctly after printing.	<ul style="list-style-type: none"> <li>• Check that the ejection path of the label is not blocked.</li> <li>• Check that the RD Roll is set correctly by removing the RD Roll and reinstalling.</li> <li>• Ensure that the RD Roll compartment cover is closed correctly.</li> </ul>
The print quality is poor	<ul style="list-style-type: none"> <li>• Is there dirt or lint on the roller preventing it from rolling freely? Clean the roller. For details, please see → "Roller maintenance" on page 27.</li> </ul>

Problem	Solution
After replacing the Roll while the Add-In feature was activated, the layout style was not updated.	<ul style="list-style-type: none"> <li>• Close the P-touch Editor to exit the Add-In, and reactivate the Add-In.</li> </ul>
The icon of Add-In feature is not displayed in Microsoft® Word.	<ul style="list-style-type: none"> <li>• Is Microsoft Word already running?</li> <li>• Is Microsoft Word selected as the default email editor for Microsoft Outlook? Due to program limitations, the Add-In feature for Microsoft Word is unavailable with these settings. Quit Microsoft Outlook and restart Microsoft Word to use the Add-In.</li> </ul>
Cutter error	<ul style="list-style-type: none"> <li>• If the cutter error occurs, keep the RD Roll compartment cover closed and press the ON/OFF button (⏻). This moves the cutter back to the normal position and turns the machine off. After the machine is OFF, inspect the cutter unit and remove the paper jam.</li> </ul>
The printed barcode cannot be read.	<ul style="list-style-type: none"> <li>• Set the label vertical to the print head as shown below.</li> </ul> <div data-bbox="482 571 986 770" style="text-align: center;"> <p>The diagram illustrates the correct orientation for printing a barcode. A horizontal label is shown with a 'Label exit slot' at the top. Below it, a 'Print head' is positioned to print a barcode. A large downward-pointing arrow indicates the 'Recommended print direction' is vertical. The barcode is oriented vertically on the label.</p> </div> <ul style="list-style-type: none"> <li>• Some types of scanner are not able to read the barcode. Try using another scanner.</li> <li>• We recommend printing the Barcode with Print Quality options set to "Give priority to print quality".</li> </ul> <p>Windows® XP: To change the Print Quality options, open the printer properties from [Control Panel]-[Printer and other hardware]-[Printer and Faxes], right-clicking the printer whose settings are to be changed, then selecting [Properties]. Then, in the [General] tab, click [Printing Preferences...].</p> <p>Windows Vista®: To change the Print Quality options, open the printer properties by going to [Control Panel]-[Hardware and Sound]-[Printers], right-clicking the printer whose settings are to be changed, then selecting [Properties]. Then, in the [General] tab, click [Printing Preferences...].</p> <p>Windows® 7: To change the Print Quality options, open the printer properties by going to  - [Devices and Printers], right-clicking the printer whose settings are to be changed, and selecting [Printer properties]. Then, in the [General] tab, click [Preferences...].</p>
I want to reset the printer/delete the data transferred from PC.	<ul style="list-style-type: none"> <li>• To reset the machine, press and hold the ON/OFF button (⏻) to switch the machine OFF. Then, hold down the ON/OFF button (⏻) for two seconds. Continue holding down the ON/OFF button (⏻), and press the Cut button six times. The machine will then reset. All the transferred data from PC will be deleted and all machine settings will be reset to the factory settings.</li> </ul>
I want to cancel the current printing job.	<ul style="list-style-type: none"> <li>• Make sure that the printer is ON, and press the ON/OFF button (⏻) once.</li> </ul>

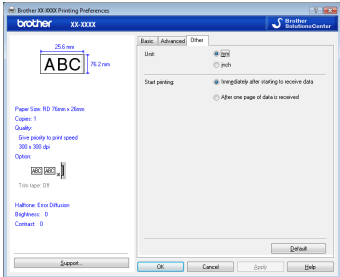

Problem	Solution
<p>When printing via the USB cable, the printer repeatedly pauses and then continues printing.</p>	<ul style="list-style-type: none"> <li>• Is the printer set for sequential printing?</li> </ul> <p>For Windows® XP: If so, set print mode to buffered printing. (Open the printer properties from [Control Panel] - [Printer and other hardware] - [Printer and Faxes] and click [Printing Preferences...] button in the [General] tab. Click the [Other] tab and choose the option "After one page of data is received".)</p> <p>For Windows Vista®: If so, set print mode to buffered printing. (Open printer properties from [Control Panel] - [Hardware and Sound] - [Printers] and click [Printing Preferences...] button in the [General] tab. Click the [Other] tab and choose the option "After one page of data is received".)</p> <p>For Windows® 7: If so, set print mode to buffered printing. (Open printer properties from  - [Devices and Printers], right-clicking the printer whose settings are to be changed, and selecting [Printing preferences]. Choose the option "After one page of data is received".)</p> <ul style="list-style-type: none"> <li>• An alternative solution is to disconnect the LAN cable until USB printing is completed.</li> </ul> 
<p>An error occurred because the roll could not be fed to the beginning of the label.</p>	<ul style="list-style-type: none"> <li>• The procedure for feeding to the beginning of the label is different for die-cut labels and continuous length label. See "Setting the RD Roll" on page 12.</li> <li>• When using die-cut labels with a length of 152 mm or more, an error may occur if the TD-4000/4100N cannot detect the beginning of the label after the first time that the roll is fed. To clear the error, press the Feed button again.</li> </ul>

## 3 Main Specifications

### ■ Product specifications

Items		Specifications
Display		LED lamp (green, red, orange)
Print	Printing method	Direct thermal printing via thermal head
	Speed of printing	Max. 110 mm/sec (when using the USB connection)
	Print head	300 dpi/1296 dot
	Max. printing width	98.6 mm
	Min. printing length	25.4 mm
Cutter		Durable automatic cutter
Button		ON/OFF button (⏻), Feed button, Cut button
Interface		USB, Serial (RS-232C), 10/100BASE-TX Wired Ethernet*1
Memory for transferred data		2048KB (Max 99 templates / 99 Databases)
Data base		Max 65,000 rows Max 100 columns
Power supply		220-240V AC, 50/60Hz, 1.1A
Size (W × D × H)		Approx. 173 mm × 229 mm × 158 mm
Weight		TD-4000: Approx. 4.0 lb (1.81 kg) (without RD Rolls) TD-4100N: Approx. 4.0 lb (1.83 kg) (without RD Rolls)

\*1 TD-4100N only

### ■ Operating environment

Items		Specifications
OS*1		Windows® XP/Windows Vista®/Windows® 7 Windows Server® 2003*2/Windows Server® 2008*2/2008 R2*2
Interface		Serial (RS-232C), USB port (USB Spec. 1.1 or 2.0 protocol), 10/100BASE-TX Wired Ethernet*2
Hard Disk		Disk space more than 70 MB*3
Memory		Windows® XP: More than 128 MB Windows Server® 2003*2: More than 256 MB Windows Vista®/Windows Server® 2008*2/2008 R2*2: More than 512 MB Windows® 7: More than 1 GB (32-bit) or 2GB (64-bit)
Monitor		SVGA, high colour or higher graphics card
Others		CD-ROM drive
Operating temperature		50°F to 95 °F (10°C to 35°C)
Operating humidity		20% to 80% (without condensation)

\*1 The computer should meet Microsoft® recommendations for the OS installed.

\*2 TD-4100N only

\*3 Required available space when installing the software with all of the options.

## ■ Paper specification

For best results, we recommend only using Brother thermal media.

Items	Specifications
Media type	Die-cut label, Continuous length label
Media width	19 mm - 105.6 mm
Label width	15 mm - 101.6 mm
Gap between labels	3 mm or more
Media thickness range	Without adhesive: 0.08 mm - 0.155 mm With adhesive: 0.08 mm - 0.170 mm
Outside diameter	101.6 mm
Core size	25.4 mm
Media sensor	Transmissive/Gap

## Accessories

Brother recommends the use of genuine Brother accessories with the Brother TD-4000/4100N.

The use of other products may affect the print quality or may damage the Brother TD-4000/4100N.

Call your Brother reseller to order the following supplies and accessories for the Brother TD-4000/4100N.

### ■ RD Rolls

Stock No.	Description
RD-S01E2	Continuous length paper label, 102 mm
RD-S02E1	Die-cut labels, 102 mm × 152 mm
RD-S03E1	Die-cut labels, 102 mm × 50 mm
RD-S04E1	Die-cut labels, 76 mm × 26 mm
RD-S05E1	Die-cut labels, 51 mm × 26 mm

**brother**