

brother

TZe
TAPE

USER'S GUIDE

P-touch
ELECTRONIC LABELING SYSTEM

PT-D450

Read this User's Guide before you start using your P-touch.
Keep this User's Guide in a handy place for future reference.
Please visit us at support.brother.com where you can get product support and answers to frequently asked questions (FAQs).



ENGLISH

www.brother.com

INTRODUCTION

Thank you for purchasing the P-touch labeler PT-D450.

Your new P-touch labeler is an easy to operate, feature packed labeling system that makes creating professional, high quality labels a breeze.

This manual contains various precautions and basic procedures for using this labeler. Read this manual carefully before using and keep in a handy place for future reference.

Federal Communications Commission (FCC) Declaration of Conformity (For USA Only)

Responsible Party : Brother International Corporation
200 Crossing Boulevard
Bridgewater, NJ 08807-0911, U.S.A.
TEL : (908) 704-1700

declares, that the products

Product Name : Brother P-touch Electronic Labeling System
Model Number : PT-D450

comply with Part 15 of the FCC Rules. Operation is subject to the following two conditions: (1) this device may not cause harmful interference, and (2) this device must accept any interference received, including interference that may cause undesired operation.

This equipment has been tested and found to comply with the limits for a Class B digital device, pursuant to Part 15 of the FCC Rules. These limits are designed to provide reasonable protection against harmful interference in a residential installation. This equipment generates, uses, and can radiate radio frequency energy and, if not installed and used in accordance with the instructions, may cause harmful interference to radio communications. However, there is no guarantee that interference will not occur in a particular installation. If this equipment does cause harmful interference to radio or television reception, which can be determined by turning the equipment off and on, the user is encouraged to try to correct the interference by one or more of the following measures:

- Reorient or relocate the receiving antenna.
- Increase the separation between the equipment and receiver.
- Connect the equipment into an outlet on a circuit different from that to which the receiver is connected.
- Consult the dealer or an experienced radio/TV technician for help.

Important

- The enclosed interface cable should be used in order to ensure compliance with the limits for a Class B digital device.
- Changes or modifications not expressly approved by Brother Industries, Ltd. could void the user's authority to operate the equipment.

International ENERGY STAR® Compliance Statement

The purpose of the International ENERGY STAR® Program is to promote the development and popularization of energy-efficient office equipment. As an ENERGY STAR® Partner, Brother Industries, Ltd. has determined that this product meets the ENERGY STAR® guidelines for energy efficiency.



Compilation and Publication Notice

Under the supervision of Brother Industries, Ltd., this manual has been compiled and published, covering the latest product's descriptions and specifications. The contents of this manual and the specifications of this product are subject to change without notice.

If new versions of the PT-D450 software become available, this manual may not reflect the updated features. Therefore, you may find that the software and the contents in this manual are different.

Any trade names and product names of companies appearing on Brother products, related documents and any other materials are all trademarks or registered trademarks of those respective companies. BROTHER is either a trademark or a registered trademark of Brother Industries, Ltd.

Contents

General Description	3
Safety Precautions.....	4
General Precautions	6
GETTING STARTED.....	7
Unpacking Your P-touch labeler	7
LCD Display & Keyboard	7
Power Supply and Tape cassette	9
When using AC adapter (AD-E001)	9
When using six new AA alkaline batteries (LR6) or fully charged Ni-MH batteries (HR6)	9
Insert a Tape Cassette	10
Turning Power On/Off.....	11
Setting Language and Unit	11
Language.....	11
Unit	11
Feeding Tape.....	11
Setting LCD Display.....	11
LCD Contrast.....	11
Back Light.....	12
How to use the P-touch labeler.....	12
Create a label with the P-touch labeler.....	12
Create a label by connecting your labeler to a PC	13
EDITING A LABEL	15
Entering and Editing Text	15
Entering Text from the Keyboard.....	15
Adding a New Line	15
Adding a New Block	15
Deleting Text	15
Inserting a Tab.....	16
Using Text Reminder.....	16
Deleting Text Reminder Memory.....	17
Changing Text Reminder Setting	17
Entering Symbols.....	17
Entering Symbols Using the Symbol Function	17
Setting Symbol History	17
Entering Accented Characters.....	18
Setting Character Attributes ([Font]/[Size]/[Width]/[Style]/[Line]/[Align])	19
Setting Character Attributes by Label.....	19
Setting Character Attributes by Each Line.....	19

Setting Auto Fit Style	22
Setting Frames	22
Setting Label Attributes ([Length]/[Cut Option]/[Tab Length])	23
Using Auto-Format Layouts	24
Using Templates	24
Using Block Layouts	27
Creating a Bar Code Label	29
Setting Bar Code Parameters and Entering Bar Code Data	29
Editing and Deleting a Bar Code	31

LABEL PRINTING32

Previewing Labels	32
Printing Labels	32
Single and Multiple Copy Printing	32
Numbering Printing	33
Mirror Printing	33
Setting Tape Cutting Options	33
[Large Margin]/[Small Margin]/[Chain]/[No Cut]/[Special tape]	33
Adjusting the Label Length	35
Printing from the Label Collection	36
Printing a label from the label collection stored in the P-touch labeler	36
Downloading a new Label Collection Category	37

USING THE FILE MEMORY38

Saving Label Files	38
Printing, Opening, Deleting a Saved Label	38
[Print]	38
[Open]	38
[Delete]	38

RESETTING & MAINTAINING YOUR P-TOUCH LABELER ..39

Resetting the P-touch Labeler	39
Resetting the Data Using the home key	39
Resetting the Data to Factory Settings Using the P-touch Labeler Keyboard	39
Maintenance	40
Cleaning the Unit	40
Cleaning the Print Head	41
Cleaning the Tape Cutter	41

INTRODUCTION

TROUBLESHOOTING42

What to do when..... 42

When an error message appears on the display 43

APPENDIX44

Specifications..... 44

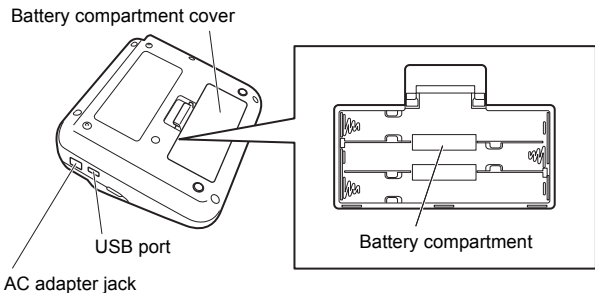
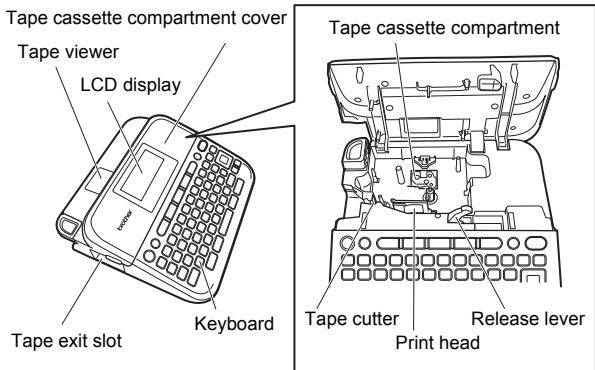

System Requirements 45

General Description









Safety Precautions

To prevent injury and damage, important notes are explained using various symbols. The symbols and their meanings are as follows:













 WARNING	Indicates a potentially hazardous situation which, if not avoided, could result in death or serious injuries.
 CAUTION	Indicates a potentially hazardous situation which, if not avoided, may result in minor or moderate injuries.

The symbols used in this manual are as follows:

	Action NOT allowed		DO NOT touch a given portion of the product.
	Mandatory action		Unplugging is required
	DO NOT disassemble the product.		Alerts to the possibility of electrical shock

WARNING

Follow these guidelines to avoid the risk of fire, burns, injury, electric shocks, rupture, overheating, abnormal odors or smoke.

- | | |
|---|--|
| <ul style="list-style-type: none">  Always use the specified voltage and the suggested AC adapter (AD-E001) for the P-touch labeler to prevent any damage or failure.  Do not touch the AC adapter and P-touch labeler during a thunder storm.  Do not use the P-touch labeler/AC adapter in places of high humidity such as bathrooms.  Do not place heavy objects on, or damage the power cord or plug. Do not forcibly bend or pull the power cord. Always hold the AC adapter when disconnecting from the power outlet.  Make sure that the plug is fully inserted to the power outlet. Do not use an outlet that is loose.  Do not allow the P-touch labeler/AC adapter/power plug/batteries to get wet, for example, by handling them with wet hands or spilling beverages on to them. | <ul style="list-style-type: none">  Since loss of eyesight may result when leaked fluid from batteries gets into your eyes, immediately rinse your eyes with a large amount of clean water, and then seek medical attention.  Do not disassemble or modify the P-touch labeler/AC adapter/ batteries.  Do not allow a metal object to contact both the plus and minus ends of a battery.  Do not use sharp objects, such as tweezers or a metallic pen, to change the batteries.  Do not throw the batteries into fire or expose to heat.  Disconnect the AC adapter and remove batteries immediately and stop using the P-touch labeler if you notice abnormal odor, heat, discoloration, deformation or anything unusual while using or storing it. |
|---|--|

⚠ WARNING

- ⊘ Do not use a damaged or leaking battery as the fluid may get on your hands.
- ⊘ Do not use a deformed or leaking battery or one whose label is damaged. There is a possibility of generating heat.
- ⊘ Do not touch metal parts around the print head immediately after printing.
- ⊘ When the P-touch labeler is not being used, store it out of the reach of children. In addition, do not allow children to put the P-touch labeler parts or labels in their mouths. If any object has been swallowed, seek medical attention.
- ❗ Do not use a damaged adapter cord or power plug.
- ❗ Do not use the P-touch labeler when a foreign object enters the P-touch labeler. If any foreign object enters the P-touch labeler, disconnect the AC adapter and remove the batteries, and contact Brother customer service.

⚠ CAUTION

Follow these guidelines to avoid personal injury, liquid leakage, burns or heat.

- ⊘ Do not touch the cutter blade.
- ❗ If leaked fluid from batteries gets on your skin or clothes, immediately rinse them with clean water.
- ❗ Remove the batteries and disconnect the AC adapter if you do not intend to use the P-touch labeler.
- ⊘ Do not use a battery other than that specified. Do not use combinations of old and new batteries or combinations of different types, different charging levels, different manufacturers or different models. Do not insert a battery with the polarity (+ and -) reversed.
- ⊘ Do not drop or hit the P-touch labeler/AC adapter.
- ⊘ Do not press on the LCD display.
- ⊘ Do not put your finger inside the P-touch labeler when you close the tape cassette compartment cover or battery compartment cover.
- ❗ Before using Ni-MH rechargeable batteries, carefully read the instructions for the batteries and battery charger, and be sure to use them correctly.
- ❗ When using Ni-MH rechargeable batteries, charge the batteries with a specialized battery charger before using the batteries.

General Precautions

- Depending on the location, material, and environmental conditions, the label may unpeel or become irremovable, the color of the label may change or be transferred to other objects. Before applying the label, check the environmental conditions and the material.
- Do not use the P-touch labeler in any way or for any purpose not described in this guide. Doing so may result in accidents or damage the P-touch labeler.
- Use only Brother TZe tapes with the P-touch labeler. Do not use tapes that do not have the **TZe** mark.
- Only use a soft, dry cloth to clean the labeler; never use alcohol or other organic solvents.
- Use a soft wipe to clean the print head; never touch the print head.
- Do not put any foreign objects into the tape exit slot, AC adapter connector or USB port, etc.
- Do not place the P-touch labeler/batteries/AC adapter in direct sunlight or rain, near heaters or other hot appliances, in any location exposed to extremely high or low temperatures (e.g., on the dashboard or in the back of your car) or high humidity, or in dusty locations.
- Do not apply excessive pressure to the cutter lever.
- Do not try to print if the cassette is empty; it will damage the print head.
- Do not pull the tape while printing or feeding; it will damage the tape and the P-touch labeler.
- It is recommended that you use the USB cable supplied with the P-touch labeler. Should another USB cable need to be used, ensure it is of high quality construction.
- Any data saved in memory will be lost due to failure or repair of the P-touch labeler, or if the battery expires.
- The P-touch labeler is not equipped with a charging feature for rechargeable batteries.
- The printed text may differ from the text that appears in the LCD.
- The length of the printed label may differ from the displayed label length.
- When power is disconnected for two minutes, all text, format settings and any text files saved in the memory will be cleared.
- You can also use Heat Shrink Tube in this model. Check the Brother website (www.brother.ca) for further information. You cannot print frames, pre-set P-touch templates, or use certain font settings when using Heat Shrink Tube. Printed characters may also be smaller than when using TZe tape.
- Be sure to read the instructions provided with Fabric Iron-On Tapes, Extra Strength Adhesive Tapes or other special tapes and observe all precautions noted in the instructions.
- **A protective clear plastic sticker is placed over the display during manufacturing and shipping. This sticker should be removed prior to use.**

GETTING STARTED

Unpacking Your P-touch labeler

Carton Contents

P-touch labeler

Starter Tape Cassette

AC adapter

USB Cable

User's Guide

LCD Display & Keyboard

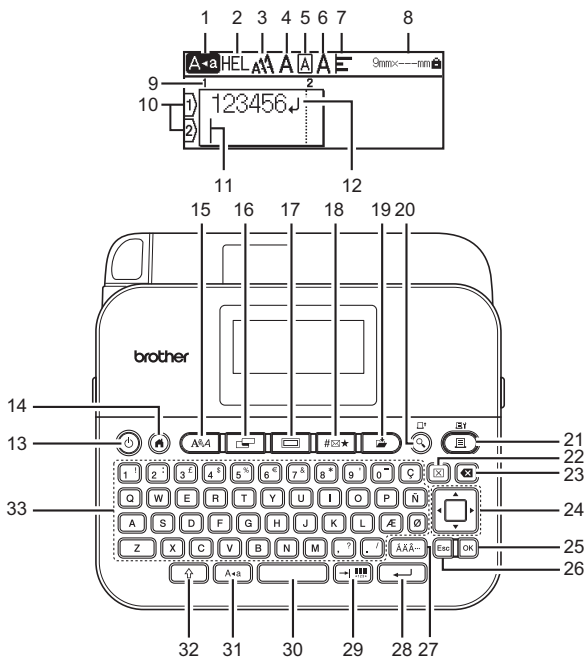

The default language is [English].

-
- | | |
|------------------------------|------------------|
| 1. Caps mode | 20. Preview |
| 2-7. Style guidance | 21. Print |
| 8. Tape width x Label length | 22. Clear |
| 9. Block number | 23. Backspace |
| 10. Line number | 24. Cursor |
| 11. Cursor | 25. OK |
| 12. Return mark | 26. Escape |
| 13. Power | 27. Accent |
| 14. Home | 28. Enter |
| 15. Font | 29. Tab/Bar Code |
| 16. Label | 30. Space |
| 17. Frame | 31. Caps |
| 18. Symbol | 32. Shift |
| 19. Save | 33. Letter |

NOTE

- When the caps mode is on, all characters you type will be in uppercase letters.
 - The text that you enter can be up to 280 characters in length.
 - Use (⇧) in combination with the letter and number keys to type uppercase letters or the symbols indicated on the upper-right corner of the keys.
 - Use ▲ or ▼ with (⇧) to go to the beginning of the previous or next block.
 - Use ◀ or ▶ with (⇧) to go to the beginning or end of the current line.
 - While selecting the settings, press () to go back to the default item.
 - Unless otherwise mentioned, press (Esc) to cancel any operation.
 - Press (⏪) to return to the home screen.
 - Label length shown on LCD may slightly differ from the actual label length when printed.
-

Power Supply and Tape cassette

■ When using AC adapter (AD-E001)

Insert the plug on the adapter cord into the AC adapter jack on the side of the machine. Insert the plug into the nearest standard electrical outlet.

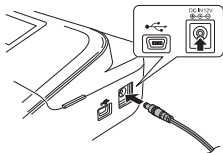

■ When using six new AA alkaline batteries (LR6) or fully charged Ni-MH batteries (HR6)

Make sure that their poles point in the correct directions. To remove the batteries, reverse the installation procedure.

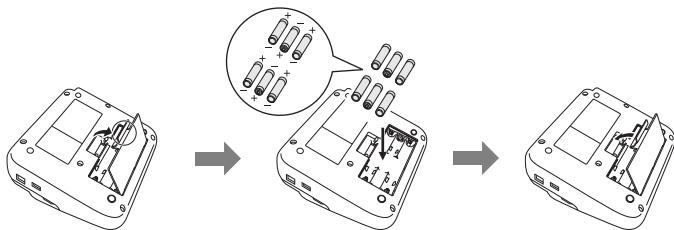

NOTE

- For memory back up, we recommend using AA alkaline batteries (LR6) or Ni-MH batteries (HR6) together when using the AC adapter.
- To safeguard and backup the P-touch labeler's memory, when the AC adapter is unplugged it is recommended to have AA alkaline batteries (LR6) or Ni-MH batteries (HR6) installed in the P-touch labeler.
- When power is disconnected for more than two minutes, all text and format settings will be cleared. Any text files saved in the memory will also be cleared.
- Remove the batteries if you do not intend to use the P-touch labeler for an extended period of time.

- Dispose of the battery at an appropriate collection point, not in the general waste stream. In addition, be sure to observe all applicable federal, state, and local regulations.
- When storing or discarding the battery, wrap it (for example with cellophane tape), to prevent it from short-circuiting.

(Battery insulation example)

1. Cellophane tape
2. Alkaline or Ni-MH battery

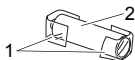

CAUTION

USING A COMBINATION OF DIFFERENT BATTERIES (SUCH AS NI-MH AND ALKALINE), MAY RESULT IN AN EXPLOSION. DISPOSE OF USED BATTERIES ACCORDING TO THE INSTRUCTIONS.

■ Insert a Tape Cassette

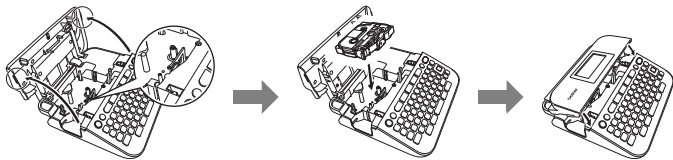

NOTE

- When inserting the tape cassette, make sure that the tape and ink ribbon do not catch on the print head.
- If you cannot close the tape cassette compartment cover, check to ensure the release lever is in the up position. If not, lift the lever, and then close the cover.

Turning Power On/Off

Press (⏻) to turn the P-touch labeler on.

Press (⏻) again to turn the P-touch labeler off.

NOTE

Your P-touch labeler has a power saving function that automatically turns itself off if no key is pressed within a certain time under certain operating conditions. Refer to “Specifications” on page 44.

Setting Language and Unit

■ Language

When you turn on the P-touch labeler for the first time, you are asked to set the default language. Select language using ◀ or ▶, and then press (OK) or (←).

(⏻) → ◀/▶ [Settings] → (OK) or (←) → ▲/▼ [Language] → (OK) or (←) → ▲/▼ [English/Español/Français/Hrvatski/Italiano/Magyar/Nederlands/Norsk/PolSKI/Português/Português(Brasil)/Română/Slovenski/Slovenský/Suomi/Svenska/Türkçe/Čeština/Dansk/Deutsch] → (OK) or (←).

■ Unit

The default setting is [mm].

(⏻) → ◀/▶ [Settings] → (OK) or (←) → ▲/▼ [Unit] → (OK) or (←) → ▲/▼ [mm/inch] → (OK) or (←).

Feeding Tape

To feed the tape, press the following keys:

(⏻) + (⏪).

Setting LCD Display













■ LCD Contrast

The default setting is [0].

(⏻) → ◀/▶ [Settings] → (OK) or (←) → ▲/▼ [Adjustment] → (OK) or (←) → ▲/▼ [LCD Contrast] → (OK) or (←) → ◀/▶ [-2 - +2] → (OK) or (←).

■ Back Light

The default setting is [On].

() → /  [Settings] → () or () → /  [Backlight] → () or () → /  [On/Off] → () or ()

NOTE

- Power can be saved when the back light is turned off.
- The back light is turned off automatically if there is no operation. It can be turned back on by pressing any key. The back light turns off when printing.

How to use the P-touch labeler

■ Create a label with the P-touch labeler

[GETTING STARTED]

Preparing the P-touch labeler **P. 7**



[CREATING A LABEL]

- Entering and Editing text **P. 15**
- Entering Symbols **P. 17**
- Entering Accented Characters **P. 18**
- Using Auto-Format Layouts **P. 24**

NOTE

In addition to entering text, the P-touch labeler has a large range of formatting options.

Examples of labels you can create using the P-touch labeler:



[LABEL PRINTING]

- Printing a label **P. 32**
- Setting Tape Cutting Options **P. 33**
- Printing from the Label Collection **P. 36**

NOTE

Before printing, you can check the layout of your label using the preview function.

Refer to “Previewing Labels” on page 32.

Example of the preview screen:

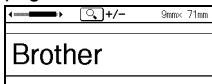

■ Create a label by connecting your labeler to a PC

[GETTING STARTED]

This labeler can be connected to a PC/Mac and used with the P-touch Editor software to create more elaborate labels.

To use your labeler connected to a computer, attach your labeler to a computer via the included USB cable and install the P-touch Editor software and drivers.

Features

P-touch Editor	Makes it easy for anyone to create a wide variety of custom labels in complex layouts by using fonts, templates, and clip art.
Printer Driver	Lets you print labels from the connected P-touch labeler when using P-touch Editor on your computer.
P-touch Update Software	Label collections can be downloaded and new label designs added to the P-touch labeler. In addition, the software can be upgraded to the latest version.

Installer download website

- A CD-ROM is not included with this product.
- To download and install printer drivers and software such as the P-touch Editor 5.1 on your computer, visit our installer download website (www.brother.com/inst/).

Printer drivers and software are also available to download individually from the list of available printer drivers and software on our support website below:

Brother support website

Please visit our support website at support.brother.com.

You can find following information:

- Software downloads
- Manuals/Documents
- Frequently Asked Questions (Troubleshooting, Useful tips on using printer)
- Consumable information
- Latest OS compatibility information

The contents of this website are subject to change without notice.



[CREATING A LABEL]

- Connect the P-touch labeler to your computer with the included USB cable.
- Launch the P-touch Editor Software.
- Enter the label text using P-touch Editor.
- Print the label.

Examples of labels you can create using the P-touch Editor:



EDITING A LABEL

Entering and Editing Text

■ Entering Text from the Keyboard

→ [Create Label] → or → Enter the character.

■ Adding a New Line

Move the cursor to end of the current line and press ().

Line 1

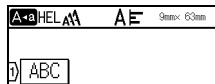

Line 2

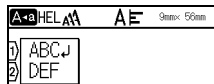

Label image

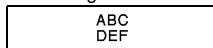

NOTE

- There is a maximum number of lines of text that can be entered for each tape width. A maximum of 5 lines for 18 mm tape, 3 lines for 12 mm tape, 2 lines for 9 mm and 6 mm tape, and 1 line for 3.5 mm tape.
- If you press () when seven lines already exist, [Too Many Lines!] is displayed. Press () or any other key to clear the error message.

■ Adding a New Block

To create a new block of text/lines to the right of your current text, press () and (). The cursor moves to the start of the new block.

NOTE

- A maximum of 5 blocks can be entered in one label.
- If you press () and () when five blocks already exist, [Too Many Blocks!] is displayed. Press () or any other key to clear the error message.

■ Deleting Text

By pressing () the letters will be deleted one by one.
To delete all text:

→ [Text Only] → or ().

To delete all text and format settings:

→ [Text&Format] → or ().

■ Inserting a Tab

To insert a tab, press the following key.

The symbol (**␣**) will then appear on the screen.



NOTE

To delete a tab from a label, position the cursor to the right of the tab mark on the text entry screen and press (**ⓧ**).

To change tab length:

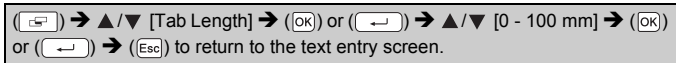

NOTE

You can also set the tab length by typing in the desired tab length. To apply the setting, after typing in the tab length, press (**OK**) or (**←**) and then (**OK**) or (**←**) again.

■ Using Text Reminder

When a character is entered, the P-touch labeler remembers character sequences beginning with the character entered from a history of all printed character sequences to date, and displays a list of options from which to select. The default setting is [On].

Example:















Enter "B" → (**OK**) → The P-touch labeler displays a list of words printed beginning with the letter "B" such as "Brother" → ▲/▼ Select the desired word → Press ► to display the entire word that is too long to display on the list of words. To return to the list of words, press ◀ → Press (**OK**) or (**←**), the selected character word will then appear on the text line.













NOTE

To close the list of words and return to the text entry screen, press (**Esc**).

■ Deleting Text Reminder Memory







() →  [Settings] → () or () →  [Text Reminder] → () or () →  [Clear Memory] → () or () → The message [Clear All Text Reminder Memory?] appears → () or ()

■ Changing Text Reminder Setting

() →  [Settings] → () or () →  [Text Reminder] → () or () →  [ON/OFF] → () or () →  [On/Off] → () or ()











Entering Symbols

■ Entering Symbols Using the Symbol Function

() →  Select Category → () or () →  /  Choose a symbol → () or ()

■ Setting Symbol History

Up to 30 recently used symbols are added to [History]. The default setting is [On].

() →  [Settings] → () or () →  [Symbol History] → () or () →  [On/Off] → () or ()

Symbol List

Category	Symbols
Punctuation	. , : ; " ' • ? ! ¿ ¡ - & ~ _ \ / * @ #
Bracket Arrow	() [] < > ≪ ≫ [] → ← ↑ ↓ ⇨ ⇩ ⤴ ⤵ ⤶ ⤷
Mathematics	+ - × ÷ ± = ≥ ≤ ≠ ∴ α β γ δ μ Ω φ Σ ^a ₂ ^b ₃ ² ₃ ¼ ½ ¾ I II III IV V VI VII VIII IX X
Currency Unit	% \$ € £ ¥ ¢ ° ft. in. m ² m ³ cc ℓ oz. lb. °F °C
(Number)	① - ⑨⑨
[Number]	1 - 99

Category	Symbols
Sign	
Electrical	
Datacom/AV	
Business	
Professional	
Event	
Vehicle	
Personal	
Nature/Earth	
Pictograph	

Entering Accented Characters

Enter the character → (ÄÄÄ) → ▲/▼ Select accented character → (OK) or (↶).

Accented Character List

Character	Accented Characters	Character	Accented Characters
a	á à â ã ä å æ ç è é	n	ñ ñ ñ ñ
A	Á Â Ã Ä Å Æ Æ Ā Ā Ā	N	Ñ Ñ Ñ Ñ
c	ç ċ ċ	o	ó ô õ ø ö œ ö
C	Ç Ć Ć	O	Ó Ô Õ Ø Ö Œ Ö
d	d' ð đ	r	ř ř r
D	Ď Ď	R	Ř Ř R
e	é ê ë ě ě ě ě	s	š š š š ß
E	É Ê Ë Ě Ě Ě Ě	S	Š Š Š Š ß
g	ğ ğ	t	ť ť t
G	Ğ Ğ	T	Ť Ť T
i	í î ï ï ï	u	ú û ü ü ú û ü
I	Í Î Ï Ï Ï	U	Ú Û Ü Ü Ú Û Ü
k	ķ	y	ý ŷ
K	Ķ	Y	Ÿ Ÿ
l	ł ł ł ł	z	ž ž ž
L	Ł Ł Ł Ł	Z	Ž Ž Ž

Setting Character Attributes ([Font]/[Size]/[Width]/[Style]/[Line]/[Align])

You can set character attributes by label or by each line both before and after entering text.

■ Setting Character Attributes by Label

(**A&A**) → ▲/▼ Select an attribute → (OK) or (←) → ▲/▼ Set a value for that attribute → (OK) or (←) → (Esc) to return to the text entry screen.

■ Setting Character Attributes by Each Line

1. Using ▲/▼, move the cursor to the line you wish to change the character attribute.
2. Press (⇩) and (**A&A**) to display the attributes.

NOTE

- (≡) displayed on the left side of the character attribute that appears when you press (↕) and (A@A) indicates that you are now applying the attribute for that specific line only.
- When different attribute values are set for each line, the value will be displayed as ***** when you press (A@A), select an attribute using ▲ or ▼, and then press (OK) or (←). When you change the setting on this screen by using ▲ or ▼, pressing (OK) or (←), and then pressing (Esc) to go back to the text entry screen, the same change will be applied to all lines of the label.
- The actual printed font size depends on the tape width, number of characters and number of input lines. Once characters reach a minimum size, the selected font will default to a custom font which is based on the Helsinki style. This allows labels to print using the smallest text possible on narrow or multi-line labels.
- The 6 point font only prints in Helsinki, no other font type.
- When [Size] is set to [Auto] and all the text is entered in uppercase, the text is automatically adjusted to print in the largest font size possible for each tape width. This font size is larger than the largest font size available in the font settings for each tape width.



Setting Options

Attribute	Value	Result	Attribute	Value	Result
Font	Helsinki	A1	Font	Belgium	A1
	Brussels	A1		Atlanta	A1
	US	A1		Adams	A1
	Los Angeles	A1		Brunei	A1
	San Diego	A1		Sofia	A1
	Florida	A1		Germany	A1
	Calgary	A1		Letter Gothic	A1

EDITING A LABEL



Attribute	Value	Result	Attribute	Value	Result
Size	Auto	When Auto is selected, the text is automatically adjusted to print in the largest size available in the font settings for each tape width.	Size	18 pt	A
	6 pt	A		24 pt	A
	9 pt	A		36 pt	A
	12 pt	A		42 pt	A
Width	x 1	A	Width	x 1/2	A
	x 3/2	A		x 2/3	A
	x 2	A			
Style	Normal	A	Style	Italic Bold	A
	Bold	A		Italic Outline	A
	Outline	A		Italic Shadow	A
	Shadow	A		Italic Solid	A
	Solid	A		Vertical	A
	Italic	A		Vertical Bold	A
Line	Off	A	Line	Strikeout	A
	Underline	A			
Align	Left	ABC	Align	Right	ABC
	Center	ABC		Justify	A B C

■ Setting Auto Fit Style

When [Size] is set to [Auto] and [Length] is set to a specific length, you can reduce the text size to fit within the label length. When [Text Size] is selected, the total text size is modified to fit within the label. When [Text Width] is selected, the text width will be reduced to the size of x1/2 setting.

() → /▶ [Settings] → () or () → ▲/▼ [Auto Fit Style] → () or () →  → ▲/▼ [Text Size/Text Width] → () or ()

























































Setting Frames

() → ▲/▼/▶/◀ Select a frame → () or ()

NOTE

You can also select a frame by typing in the frame number.

Frames

Frames			
1 	2 	3 	4 
5 	6 	7 	8 
9 	10 	11 	12 
13 	14 	15 	16 
17 	18 	19 	20 
21 	22 	23 	24 
25 	26 	27 	28 
29 	30 	31 	32 
33 	34 	35 	36 
37 	38 	39 	40 
41 	42 	43 	44 
45 	46 	47 	48 
49 	50 	51 	52 
53 	54 	55 	56 

Frames







57	58	59	60
61	62	63	64
65	66	67	68
69	70	71	72
73	74	75	76
77	78	79	80
81	82	83	84
85	86	87	88
89	90	91	92
93	94	95	96
97	98	99	

Setting Label Attributes ([Length]/[Cut Option]/[Tab Length])





Length : [Length] can be set within the range 30 mm - 300 mm.
When [Auto] is selected, the length of the label is automatically adjusted based on the amount of text entered.

Cut Option : Refer to “Setting Tape Cutting Options” on page 33.

Tab Length: Refer to “To change tab length.” on page 16.

() → ▲/▼ Select an attribute → () or () → ▲/▼ Set a value for that attribute → () or () → () to return to the text entry screen.

NOTE

You can also set the label and tab length by typing in the desired length. To apply the setting, after typing in the length, press () or () and then () or () again.

Using Auto-Format Layouts

NOTE

























Symbols, accented characters and bar codes can also be used in auto-format layouts.

■ Using Templates

Simply select a layout from the templates, enter the text and apply formatting as desired.

Example - Asset Tag:



() → /▶ [Auto Format] → () or () → ▲/▼ [Templates] → () or () → ▲/▼ [Asset Management] → () or () → ▲/▼ [Asset Tag] → () or () → Enter the text → () or () → Enter the text for the next field → () or () → ▲/▼ Select an attribute for bar code → /▶ Set a value for that attribute → () or () → Type in the bar code data → () or () → ▲/▼ [Print] → () or () → ▲/▼ Select the number of labels to be printed → () , () or (.

NOTE







- For details on bar codes, refer to “Creating a Bar Code Label” on page 29.
- On the print menu screen:
 - Select [Edit] to change the text data or the bar code setup.
 - Select [Save] to store the label to the file memory.
For the file memory, refer to “USING THE FILE MEMORY” on page 38.
 - Select [Menu] to change the font or style settings.
 - Select [Preview] to preview the label before printing.
 - Select [Print Options] to set the print settings. For details, refer to “Numbering Printing” on page 33 or “Mirror Printing” on page 33.
- If the width of the current tape cassette does not match the set width for the selected layout, an error message is displayed when you try to print the label. Press () or any other key to clear the error message, and insert a tape cassette of the correct width.

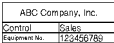
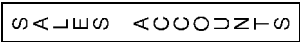

EDITING A LABEL

- If the number of characters entered exceeds the limit, [Text Too Long!] is displayed when (OK) or (↩) is pressed. Press (Esc) or any other key to clear the error message, and edit the text using fewer characters.































Templates

Category	Value	Details
Asset Management	Asset Tag	 (18 mm x 70 mm)
	Bin Box	 (18 mm x 76 mm)
	Equipment Label	 (18 mm x 58 mm)
File/Cabinet	Binder Spine	 (18 mm x 219 mm)
	File Folder Tab	 (12 mm x 82 mm)
	Divider Tab (Hanging Folder)	 (12 mm x 42 mm)
	Cabinet Label	 (18 mm x 111 mm)

Category	Value	Details
Address/ID	Address Label	<div style="border: 1px solid black; padding: 2px;"> ABC CORPORATION 1234 Main St. Anytown, USA 12345 Telephone (XXX) XXX-XXXX </div> (18 mm x 70 mm)
	Name Badge 1	<div style="border: 1px solid black; padding: 2px;"> Brother brother </div> (18 mm x 72 mm)
	Name Badge 2	<div style="border: 1px solid black; padding: 2px;"> Robert Becker ABC Company, Inc. </div> (18 mm x 72 mm)
Media	SD Card Label	<div style="border: 1px solid black; padding: 2px;"> Photos September'14 Trip </div> (12 mm x 25 mm)
	USB Flash Memory	<div style="border: 1px solid black; padding: 2px;"> Sales Meeting 1/15 </div> (9 mm x 25 mm)
	CD Case Spine 1	<div style="border: 1px solid black; padding: 2px; text-align: center;"> My Favorite Music </div> (6 mm x 113 mm)
	CD Case Spine 2	<div style="border: 1px solid black; padding: 2px; text-align: center;"> My Favorite Music </div> (3.5 mm x 113 mm)
Cable Labeling	Flag 1	<div style="border: 1px solid black; padding: 2px; display: flex; justify-content: space-between;"> ABC ABC </div> (12 mm x 90 mm)
	Flag 2	<div style="border: 1px solid black; padding: 2px; display: flex; justify-content: space-between;"> ABC DEF ABC DEF </div> (12 mm x 90 mm)
	Cable Wrap	<div style="border: 1px solid black; padding: 2px;"> 7A-B2-C3 7A-B2-C3 7A-B2-C3 7A-B2-C3 7A-B2-C3 7A-B2-C3 </div> (18 mm x 39 mm)
	Faceplate(VRT)	<div style="border: 1px solid black; padding: 2px; display: flex; justify-content: space-around;"> C-A11 C-A12 C-A13 </div> (12 mm x 70 mm)

■ Using Block Layouts

Simply select a layout from the block layouts, enter the text and apply formatting as desired.

() →  /  [Auto Format] → () or () →  /  [Block Layouts] → () or () →  /  Select a tape width → () or () →  /  Select a block layout → () or () → Enter the text → () or () → Repeat for each text field → () or () to display the print menu →  /  [Print] → () or () →  /  Select the number of labels to be printed → () , () or () .

NOTE



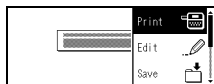







- On the print menu screen:
 - Select [Edit] to change the text data or the bar code setup.
 - Select [Save] to store the label to the file memory.

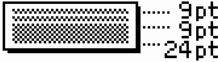



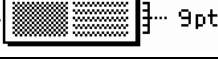

For the file memory, refer to “USING THE FILE MEMORY” on page 38.

- Select [Menu] to change the font, align or frame settings.
- Select [Preview] to preview the label before printing.
- Select [Print Options] to set the print settings. For details, refer to “Numbering Printing” on page 33 or “Mirror Printing” on page 33.
- If the width of the current tape cassette does not match the set width for the selected layout, an error message is displayed when you try to print the label. Press () or any other key to clear the error message, and insert a tape cassette of the correct width.

Block Layouts

Attribute	Value	Details
18mm	2LineA	 ... 12 pt ... 24 pt
	2LineB	 ... 24 pt ... 12 pt
	3Line	 9 pt 9 pt ... 24 pt
	1+2LineA	42 pt...  ... 18 pt ... 18 pt
	1+2LineB	42 pt...  ... 12 pt ... 24 pt
	1+3Line	42 pt...  } ... 12 pt
	1+4Line	42 pt...  } ... 9 pt
	1+5Line	42 pt...  } ... 9 pt
12mm	2LineA	 9 pt ... 12 pt
	2LineB	 ... 12 pt 9 pt
	3Line	 6 pt 6 pt ... 12 pt
	1+2Line	24 pt...  ... 12 pt ... 12 pt

Attribute	Value	Details
9mm	2LineA	 6pt 12pt
	2LineB	 12pt 6pt
	1+2Line	18pt...  9pt 9pt
6mm	1+2Line	12pt...  6pt 6pt

Creating a Bar Code Label

NOTE

- The P-touch labeler is not designed exclusively for creating bar code labels. Always check that bar code labels can be read by the bar code reader.
- For best results, print bar code labels in black ink on white tape. Some bar code readers may not be able to read bar code labels created using colored tape or ink.
- Use the [Large] setting for [Width] whenever possible. Some bar code readers may not be able to read bar code labels created using the [Small] setting.
- Continuously printing a large number of labels with bar codes can overheat the print head, which may affect printing quality.

■ Setting Bar Code Parameters and Entering Bar Code Data

+ → ▲/▼ Select an attribute → ◀/▶ Set a value for that attribute
 → or → Type in the bar code data → → ▲/▼ Select a character → or → or .

NOTE

Symbols are only available for the CODE39, CODE128, CODABAR or GS1-128 protocols. When not using symbols, after typing in the bar code data, press or to insert the bar code in the label.

Bar Code Settings

Attribute	Value
Protocol	CODE39 , CODE128, EAN-8, EAN-13, GS1-128 (UCC/EAN-128), UPC-A, UPC-E, I-2/5 (ITF), CODABAR
Width	Small
	Large
Under# (characters printed below bar code)	On
	Off
C.Digit (check digit)	Off
	On (only available for the CODE39, I-2/5 and CODABAR protocols)

Special Character List

CODE39

Special Character
-
.
(SPACE)
\$
/
+
%

CODABAR

Special Character
-
\$
:
/
.
+

CODE128, GS1-128 (UCC / EAN-128)

Special Character			
(SPACE)	!	"	#
\$	%	&	'
()	*	+
,	-	.	/
:	;	<	=
>	?	@	[
\]	^	_
NUL	`	SOH	STX
ETX	EOT	ENQ	ACK
BEL	BS	HT	LF
VT	FF	CR	SO
SI	DLE	DC1	DC2
DC3	DC4	NAK	SYN
ETB	CAN	EM	SUB
ESC	{	FS	
GS	}	RS	~
US	DEL	FNC3	FNC2
FNC4	FNC1		

■ Editing and Deleting a Bar Code

To edit bar code parameters and bar code data, position the cursor to the left of the bar code mark on the data entry screen and then open the Bar Code Setup screen by pressing (⏏) and (⏏).

To delete a bar code from a label, position the cursor to the right of the bar code mark on the data entry screen and press (⏏).

LABEL PRINTING

Previewing Labels

You can preview the text before printing.



Press ◀, ▶, ▲ or ▼ to scroll the preview to the left, right, top or bottom. Press (🔍) to change the magnification of the preview.

NOTE

To scroll the preview to the left, right, top or bottom end, press (↕) and ◀, ▶, ▲ or ▼.

Printing Labels

To cut off the label, press the tape cutter lever on the upper left corner of the machine.

NOTE

- To prevent damage to the tape, do not touch the cutter lever while the message [Printing...Copies] or [Feeding Tape...Please Wait] is displayed.
 - Do not pull the label coming out of the tape exit slot. Doing so will cause the ink ribbon to be discharged with the tape, making the tape no longer usable.
 - Do not block the tape exit slot during printing or when feeding tape. Doing so will cause the tape to jam.
-

■ Single and Multiple Copy Printing

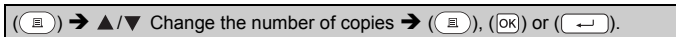











NOTE

- If you need only 1 copy of the label, press (☰), (OK) or (←) without selecting the number of copies.
 - The number of copies can also be specified by pressing a number key.
-

■ **Numbering Printing**









() + () → ▲/▼ [Number] → () or () → ◀/▶ Select start point → () or () → ◀/▶ Select end point → () or () → ▲/▼ Select the number of labels to be printed → () , () or () .

Select the highest number you wish to be printed when setting the number.

■ **Mirror Printing**





Use clear tape in [Mirror], so the labels can be read correctly from the opposite side when attached on glass, windows or other transparent surfaces.



() + () → ▲/▼ [Mirror] → () or () → () , () or () .

Setting Tape Cutting Options

■ [Large Margin]/[Small Margin]/[Chain]/[No Cut]/[Special tape]

() → ▲/▼ [Cut Option] → () or () → ▲/▼ [Large Margin/Small Margin/Chain/No Cut/Special tape] → () or () to apply the settings.

Tape Cutting Options

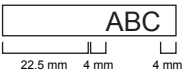
Setting	Description	Example
Large Margin	Each label is printed, leaving a margin of 23.9 mm on each end.	
Small Margin	A margin of 22.5 mm is printed first, and then each label is printed, leaving a margin of 4 mm before and after the text.	

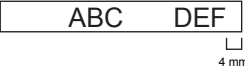
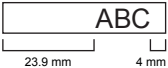
Setting	Description	Example
Chain	<ul style="list-style-type: none"> Select this setting when printing several labels with minimum margins. Feed the tape before using the cutter. Otherwise a part of the text may be cut off. Do not try to pull the tape since this may damage the tape cassette. A margin of 22.5 mm is printed first, and then each label is printed, leaving a margin of 4 mm before and after the text. 	
No Cut	<ul style="list-style-type: none"> Select this setting when printing multiple copies of a label or when using Fabric Iron-On Tapes or other special tapes that cannot be cut by the tape cutter of the P-touch labeler. Feed the tape before using the cutter. Otherwise a part of the text may be cut off. Do not try to pull the tape since this may damage the tape cassette. When using the special tapes that cannot be cut by the tape cutter of the P-touch labeler, remove the tape cassette from the P-touch labeler and use scissors to cut the tape. 	

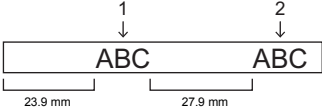
Setting	Description	Example
Special tape	<ul style="list-style-type: none"> Select this setting when using special tape. When using Fabric Iron-On Tapes or Heat Shrink Tube, set [Special tape] for [Cut Option] before printing. After printing, remove the tape cassette from the P-touch labeler and use scissors to cut the tape. 	<ul style="list-style-type: none"> When multiple copies are printed one time:  When a label is printed two times:  <ol style="list-style-type: none"> 1st print 2nd print

NOTE

- When the cut option is set to [No Cut] or [Chain], it stops in the middle of printing area after the last label is printed. After [OK to Feed?] is displayed, press (OK) or (←) to feed the tape. Press (Esc) to return to the text entry screen.
- When the cut option is set to [Large Margin], [Small Margin], [Chain], after printing the message [Cut tape or press Enter to continue.] is displayed and the P-touch labeler goes into the cut pause mode. By pressing the Tape cutter lever, you can cut the tape at the position you set in [Cut Option].

Adjusting the Label Length

When the tape cassette comes to the end, the printed length may be less accurate.

In this case, you can adjust the label length.





















(⏪) → ⏪/⏩ [Settings] → (OK) or (←) → ▲/▼ [Adjustment] → (OK) or (←) → ▲/▼ [Label Length] → (OK) or (←) → ⏪/⏩ [-5 - +5] → (OK) or (←).

NOTE

Approximately 1 % of the total label length will be adjusted by 1 level.

Printing from the Label Collection

















■ Printing a label from the label collection stored in the P-touch labeler









() → /  [Label Collection] → () or () → /  Select a category → () or () → /  Select a label → () or () → /  [Language] → () or () → /  [English (USA)/French (Canada)/Portuguese (Brazil)/Spanish (USA)] → () or () → Check the label image → () or () → / [Print] → () or () → / Select the number of copies → () , () or () .

NOTE

Only 12 mm or 18 mm tape can be used for Label Collection.

Label Collection List

Category	Label
Files	    
Office signage	    
Communication	     

Category	Label
Attention	    
Retail	   

* Labels are for illustrative purposes only.

■ Downloading a new Label Collection Category

Using the P-touch Update Software, additional label collection categories can be downloaded to your labeler.

To download the new label collection categories, please visit the Brother support website at: support.brother.com

USING THE FILE MEMORY







Saving Label Files

You can save up to 50 labels and recall them for printing at a later date. A maximum of 280 characters can be saved per file. You can also edit and overwrite the saved label.

Type text and format label → () → ▲/▼ Select a file → (OK) or ().

Printing, Opening, Deleting a Saved Label





■ [Print]

() → ◀/▶ [File] → (OK) or () → ▲/▼ Select a file → (OK) or () → ▲/▼ [Print] → (OK) or () → ▲/▼ Select the number of copies → (), (OK) or ().

NOTE

To print a saved label from the file select screen, select a label using ▲ or ▼ and then press ().





■ [Open]

() → ◀/▶ [File] → (OK) or () → ▲/▼ Select a file → (OK) or () → ▲/▼ [Open] → (OK) or ().

NOTE

If the message [Discard changes and open saved label?] appears, you have entered text on the text entry screen. Press (OK) or () to clear the entered text and open the saved label. Press (Esc) to cancel opening a saved label and return to the previous screen.

■ [Delete]

() → ◀/▶ [File] → (OK) or () → ▲/▼ Select a file → (OK) or () → ▲/▼ [Delete] → (OK) or () → The message appears → (OK) or ().

NOTE







To delete a saved label from the file select screen, select a label using ▲ or ▼ and then press ().

RESETTING & MAINTAINING YOUR P-TOUCH LABELER

Resetting the P-touch Labeler

You can reset the internal memory of your P-touch labeler when you want to clear all saved label files, or in the event the P-touch labeler is not operating correctly.

■ Resetting the Data Using the home key

() → /▶ [Settings] → (OK) or () → ▲/▼ [Reset] → (OK) or () → ▲/▼ Select the resetting method → (OK) or () → A confirmation message appears → (OK) or ()

NOTE

When selecting [Reset All Settings] or [Factory Default] for the resetting method, you are asked to set default language at the end of the resetting procedure.

Value	Details
Reset All Settings	Downloaded labels are NOT cleared. The contents in the file memory are also NOT cleared. Other data is cleared and all settings are reset to the factory settings.
Erase All Content	Downloaded labels are cleared. The contents in the file memory are also cleared. Other data is NOT cleared and settings are NOT reset.
Factory Default	All labels and customized settings are reset to the factory settings.

■ Resetting the Data to Factory Settings Using the P-touch Labeler Keyboard

NOTE

- All text, format settings, option settings and saved label files are cleared when you reset the P-touch labeler. Language and unit settings will also be cleared.
- You are asked to set the default language at the end of the resetting procedure. For details, refer to "Setting Language and Unit" on page 11.

To reset all the labels and customized settings:

Turn off the P-touch labeler. Press and hold down (⏏) and (⏏).

While holding down (⏏) and (⏏), press (⏏) once and then release (⏏) and (⏏).

NOTE

Release (⏏) before releasing the other keys.

To reset the customized settings:

(Downloaded label collections and the contents in the file memory are not reset.)

Turn off the P-touch labeler. Press and hold down (⏏) and (R). While holding down (⏏) and (R), press (⏏) once and then release (⏏) and (R).

NOTE

Release (⏏) before releasing the other keys.

Maintenance

NOTE

Always remove the batteries and disconnect the AC adapter before cleaning the P-touch labeler.

■ Cleaning the Unit

Wipe any dust and marks from the main unit using a soft, dry cloth. Use a slightly dampened cloth on difficult to remove marks.

NOTE

Do not use paint thinner, benzene, alcohol or any other organic solvent. These may deform the case or damage the appearance of your P-touch labeler.

■ Cleaning the Print Head

Streaks or poor quality characters on printed labels generally indicates that the print head is dirty. Clean the print head using a cotton swab or the optional print head cleaning cassette (TZe-CL4).

Print head

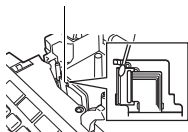

NOTE

- Do not touch the print head directly with your bare hands.
 - Refer to the instructions provided with the print head cleaning cassette for directions on how to use it.
-

■ Cleaning the Tape Cutter

Tape adhesive can build up on the cutter blade after repeated use, taking the edge off the blade which may result in the tape jamming in the cutter.

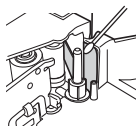

NOTE

- About once every year, wipe the cutter blade using a cotton swab moistened with Isopropyl alcohol (rubbing alcohol).
 - Do not touch the cutter blade directly with your bare hands.
-

TROUBLESHOOTING

What to do when...

Problem	Solution
The screen 'locks', or the P-touch labeler does not respond normally.	<ul style="list-style-type: none">Refer to "Resetting the P-touch Labeler" on page 39 and reset the internal memory to the initial settings. If resetting the P-touch labeler does not solve the problem, disconnect the AC adapter and remove the batteries for more than 10 minutes.
The display remains blank after turning on the power.	<ul style="list-style-type: none">Check that the batteries are correctly installed and that the AC adapter designed exclusively for your P-touch labeler is correctly connected. Check that the rechargeable battery is fully charged.
The LCD messages are displayed in a foreign language.	<ul style="list-style-type: none">Refer to "Setting Language and Unit" on page 11 to select your desired language.
The label is not printed after pressing the Print key.	<ul style="list-style-type: none">Check that text has been entered and that the tape cassette is installed correctly with sufficient tape remaining.If the tape is bent, cut off the bent section and thread the tape through the tape exit slot.If the tape is jammed, remove the tape cassette and then pull out the jammed tape and cut it. Check that the end of the tape passes through the tape guide before reinstalling the tape cassette.
The label is not printed correctly.	<ul style="list-style-type: none">Remove the tape cassette and reinstall it, pressing it firmly until it clicks into place.If the print head is dirty, clean it with a cotton swab or optional print head cleaning cassette (TZe-CL4).
The ink ribbon is separated from the ink roller.	<ul style="list-style-type: none">If the ink ribbon is broken, replace the tape cassette. If not, leave the tape uncut and remove the tape cassette, then wind the loose ink ribbon onto the spool as shown in the figure.
The P-touch labeler stops while printing a label.	<ul style="list-style-type: none">Replace the tape cassette if striped tape is visible, as this indicates that you have reached the end of the tape.Replace all batteries or connect the AC adapter directly to the P-touch labeler.
Label files saved previously are now empty.	<ul style="list-style-type: none">All files saved in the internal memory are deleted if the batteries are weak or the AC adapter was disconnected.

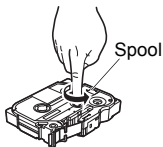

Problem	Solution
A tape jam which cannot be cleared keeps occurring.	<ul style="list-style-type: none"> Please contact Brother customer service.
I do not know the version number of the firmware for the P-touch labeler.	<ul style="list-style-type: none"> The version number and other information for the firmware can be confirmed by pressing the following keys: <ol style="list-style-type: none"> Press (⊙). Select [Settings] using ◀ or ▶, and then press (OK) or (↵). Select [Version information] using ▲ or ▼, and then press (OK) or (↵).

When an error message appears on the display

When an error message appears on the display, follow the directions provided below.

Message	Cause/Remedy
Check # of digits entered	The number of digits entered in the bar code data does not match the number of digits set in the bar code parameters. Enter the correct number of digits.
Cutter Malfunction!	The tape cutter has been closed when you tried to print or feed tape. Turn the P-touch labeler off and then on again before continuing. When tape is tangled in the cutter, remove the tape.
Label Too Long!	The length of the label to be printed using the text entered is longer than 1 m. Edit the text so that the length of the label is less than 1 m.
Text Too Long!	The length of the label to be printed using the text entered is longer than the length setting. Edit the text to fit within the set length or change the length setting.
Unable to use XX!	Please contact Brother customer service.

APPENDIX

Specifications

Item	Specification
Dimensions	Approx. 189 (W) x 177.5 (D) x 70.5 (H) mm
Weight	Approx. 740 g (without batteries and tape cassette)
Power supply	Six AA alkaline batteries (LR6), Six AA Ni-MH batteries (HR6) ^{*1} , AC adapter (AD-E001)
Character display	21 characters x 1 guidance and 3 lines text (320 dot x 120 dot)
Print height	15.8 mm max. (when using 18 mm tape) ^{*2}
Print speed	Maximum: Approx. 20 mm/sec. Actual print speed varies depending on the conditions.
Tape cassette	Standard TZe tape cassette (3.5 mm, 6 mm, 9 mm, 12 mm, 18 mm widths)
No. of lines	18 mm tape: 1 - 5 lines; 12 mm tape: 1 - 3 lines; 9 mm tape: 1 - 2 lines; 6 mm tape: 1 - 2 lines; 3.5 mm tape: 1 line
Memory buffer size	Maximum 2,800 characters
File storage	Maximum 50 files
Auto Power-off	Battery: 5 min. ^{*3} , AC adapter: 8 hours
Operation temperature/ humidity	10 °C - 35 °C (50 °F - 95 °F) / 20% - 80% humidity (without condensation) Maximum wet bulb temperature: 27 °C (80.6 °F)

*1 Visit us at support.brother.com for the latest information about the recommended batteries.

*2 Actual character size may be smaller than maximum print height.

*3 When using P-touch labeler only. When connected to a PC, 1 hour.

System Requirements

OS	Windows®	Windows Vista®/Windows® 7/ Windows® 8/ Windows® 8.1
	Macintosh	OS X v10.7.5/10.8.x/10.9.x
Hard disk	Windows®	Disk space: 70 MB or more
	Macintosh	Disk space: 500 MB or more
Memory	Windows®	Windows Vista®: 512 MB or more Windows® 7: 1 GB or more (32-bit) or 2 GB or more (64-bit) Windows® 8/Windows® 8.1: 1 GB or more (32-bit) or 2 GB or more (64-bit)
	Macintosh	OS X v10.7.5: 2 GB or more OS X v10.8.x: 2 GB or more OS X v10.9.x: 2 GB or more
Monitor	Windows®	SVGA, high color or higher graphics card
	Macintosh	256 colors or more

Please see the Brother support website (support.brother.com) for the latest compatible OS.

Contact Information

Website: www.brother.ca

brother

D01J8D001

