

Software Developer's Manual

ESC/P Command Reference

PT-P900/PT-P900W/P950NW

Version 1.03

The Brother logo is a registered trademark of Brother Industries, Ltd.

Brother is a registered trademark of Brother Industries, Ltd.

© 2016 Brother Industries, Ltd. All rights reserved.

BarStar Pro Encode Library (DataMatrix, MaxiCode, PDF417, RSS, CODE93, POSTNET, AztecCode)

Copyright (c) 2007 AINIX Corporation. All rights reserved.

QR Code is a registered trademark of DENSO WAVE INCORPORATED in Japan and other countries.

QR Code Generating Program Copyright © 2008 DENSO WAVE INCORPORATED

Each owner whose software title is mentioned in this document has a Software License Agreement specific to its proprietary programs.

Any trade names and product names of companies appearing on Brother products, related documents and any other materials are all trademarks or registered trademarks of those respective companies.

IMPORTANT - PLEASE READ CAREFULLY

Note

This documentation ("Documentation") provides information that will assist you in controlling your Printer PT-P9XX (where "P9XX" is the model name).

You may use the Documentation only if you first agree to the following conditions.

If you do not agree to the following conditions, you may not use the Documentation.

Condition of Use

You may use and reproduce the Documentation to the extent necessary for your own use of your Printer Model ("Purpose"). Unless expressly permitted in the Documentation, you may not;

- (i) copy or reproduce the Documentation for any purpose other than the Purpose,
- (ii) modify, translate or adapt the Documentation, and/or redistribute it to any third party,
- (iii) rent or lease the Documentation to any third party, or,
- (iv) remove or alter any copyright notices or proprietary rights legends included within the Documentation.

No Warranty

- a. Any updates, upgrades or alteration of the Documentation or Printer Model will be performed at the sole discretion of Brother. Brother may not respond to any request or inquiry about the Documentation.
- b. THIS DOCUMENTATION IS PROVIDED TO YOU "AS IS" WITHOUT WARRANTY OF ANY KIND, WHETHER EXPRESS OR IMPLIED, INCLUDING, BUT NOT LIMITED TO, THE IMPLIED WARRANTY OF FITNESS FOR A PARTICULAR PURPOSE. BROTHER DOES NOT REPRESENT OR WARRANT THAT THIS DOCUMENTATION IS FREE FROM ERRORS OR DEFECTS.
- c. IN NO EVENT SHALL BROTHER BE LIABLE FOR ANY DIRECT, INDIRECT, PUNITIVE, INCIDENTAL, SPECIAL OR CONSEQUENTIAL DAMAGES OR ANY DAMAGES WHATSOEVER, ARISING OUT OF THE USE, INABILITY TO USE, OR THE RESULTS OF USE OF THE DOCUMENTATION OR ANY SOFTWARE PROGRAM OR APPLICATION YOU DEVELOPED IN ACCORDANCE WITH THE DOCUMENTATION.

Contents

Introduction	1
What is ESC/P?	2
1. Using ESC/P Commands	3
2. Examples of Using ESC/P Commands	5
3. ESC/P Command Limitations	10
3.1 Print area	10
3.2 Characters	12
3.2.1 Character sizes	12
3.3 Print position	13
3.3.1 Characters	13
3.3.2 Bitmaps, barcodes and downloaded images	13
3.4 Line feed amount	14
4. Control Code List	15
5. Control Command Details	18
5.1 Character/style selection commands	18
ESC R Select international character set	18
ESC k Select font	19
ESC t Select character code table	20
5.2 Text printing commands	21
ESC 4 Apply italic style	21
ESC 5 Cancel italic style	21
ESC E Apply bold style	22
ESC F Cancel bold style	22
ESC G Apply double-strike printing	23
ESC H Cancel double-strike printing	23
ESC W Specify double-width characters	24
SI Specify compressed characters	25
ESC SI Specify compressed characters	25
DC2 Cancel compressed characters	25
ESC – Apply/cancel underlining	26
ESC ! Global formatting	27
ESC X Specify character size	28
ESC if Apply/cancel a frame	29
CAN Clear text	29
DEL Delete one character	30
ESC CR Not available	30
5.3 Line feed commands	31
ESC 0 Specify line feed of 1/8 inch	31
ESC 2 Specify line feed of 1/6 inch	31
ESC 3 Specify line feed of n/180 inch	32
ESC A Specify line feed of n/60 inch	32
5.4 Horizontal movement commands	33
CR Carriage return	33
ESC \$ Specify absolute horizontal position	34
ESC \ Specify relative horizontal position	34
ESC a Specify alignment	35
5.5 Vertical movement commands	36
LF Line feed	36
FF Page feed	36
ESC J Forward paper feed	37

5.6 Paper formatting commands	38
ESC il Specify label length	38
ESC im Specify margin width	38
5.7 Printer control commands	39
ESC @ Initialize	39
5.8 Graphics commands	41
ESC * Select bit image	41
ESC K 8-dot single-density bit image.....	47
ESC L 8-dot double-density bit image	49
ESC Y 8-dot double-speed double-density bit image	50
ESC Z 8-dot quadruple-density bit image	50
5.9 Advanced commands	52
ESC i B Barcode	52
ESC i Q 2D barcode (QR Code)	56
ESC i P Specify QR Code version	60
ESC i V 2D barcode (PDF417)	61
ESC i D 2D barcode (DataMatrix).....	64
ESC i M 2D barcode (MaxiCode).....	67
ESC i J 2D barcode (AztecCode).....	69
ESC i F Print transferred data.....	71
ESC i a Switch command mode	75
ESC i S Request printer status	76
ESC i L Apply/cancel rotated printing	82
ESC i C Specify cut setting	83
ESC i UB Specify baud rate.....	84
ESC i Ub Specify bit length	85
ESC i UP Specify parity setting	85
ESC i UC Specify busy control	86
5.10 Advanced static commands	87
ESC iXE2 Specify barcode margin setting	87
ESC iXE1 Retrieve barcode margin setting	87
Appendix A: Specifications	88
Appendix B: Character Code Tables	89
Character code tables	89
International character set table	92
Appendix C: Introducing the Brother Developer Center	93

Introduction

This material provides the necessary information for directly controlling PT-P9XX.

This information is provided assuming that the user has full understanding of the operating system being used and basic mastery of communication interfaces in a developer's environment.

Read the model names that appear in the screens in this manual as the name of your printer.

We accept no responsibility for any problems caused by programs that you develop using the information provided in this material, affecting software, data or hardware, including the PT-P9XX, and any problems resulting directly or indirectly from them. Use this material only if you accept these terms.

This material shall not be reproduced, in part or in full, without prior approval. In addition, this material shall not be used as evidence in a lawsuit or dispute in a way that is unfavorable towards our company.

These ESC/P commands have been adapted specifically for this company.

What is ESC/P?

ESC/P is one type of control codes used for printers. With the codes introduced in this document, various labels can be created and printed. In this document, ESC/P codes are provided as both ASCII and binary codes.

When sending codes to the printer, make sure that the binary codes are used, otherwise the printer cannot parse the codes.

1. Using ESC/P Commands

Below is a description of the flow for creating documents.

Also refer to "[2. Examples of Using ESC/P Commands](#)".

(1) Start ESC/P	
1. Switch the command mode. 2. Initialize	- Switch command mode (ESC i a 0) Note: ESC/P mode - Initialize (ESC @)



(2) Format settings	
1. Select the orientation.	- Apply/cancel rotated printing (ESC i L)
2. Specify the line feed amount.	- Specify line feed amount (ESC 0, ESC 2, ESC 3 and ESC A)



(3) Print operations	
1. Specify the print position.	- Specify vertical position (ESC J) - Specify horizontal position (ESC \$, ESC \ and ESC a)
2. Transfer the print data (one line).	- If necessary, transfer text processing codes (see (4)) - bit images, bar codes and downloaded data (see (5))
3. End of the line.	- Feed the paper (CR and LF)
4. Repeat 1–3 above.	
5. End of the page.	- Specify cut setting (ESC i C) - Page feed (FF)
6. Repeat 1–5 above.	
7. End of the document.	

(4) Text operations	
1. Specify the character set.	- Select font (ESC k) - Select character code (ESC t) - Select international character set (ESC R) - Specify character size (ESC X)
2. Specify the character style.	- Specify character style (ESC 4, ESC 5, ESC E, ESC F, ESC G, ESC H, ESC W, SI, ESC SI, DC2, ESC - and ESC !)
3. Specify character codes.	
* Repeat 1–3 above as necessary.	

(5) Bit images, barcodes, and image data	
1. Specify bit images.	- (ESC *, ESC K, ESC L, ESC Y and ESC Z)
2. Specify barcodes.	- (ESC i B)
3. Specify 2D barcodes.	- (ESC i Q, ESC i V, ESC i D, ESC i M and ESC i J)
4. Print the downloaded data	- (ESC i F) With transferred data, the image data must first be transferred and saved on the main unit.

2. Examples of Using ESC/P Commands

Set Basic setup first.

Basic setup

Specify ESC/P command mode.

Basic set up : Specify ESC/P command mode

ESC i a Switch command mode

ASCII:	ESC	i	a	n
Decimal:	27	105	97	n
Hexadecimal:	1B	69	61	n

Parameters

- n: Command mode
- 0=ESC/P
 - 1=Raster graphics
 - 3=P-touch Template

Description

- Sets the command mode to ESC/P, PTCBP (raster graphics) or P-touch Template.
- Dynamically switches between the three modes.

Entered Command

ESC ia 00h

This is the label that will be made.

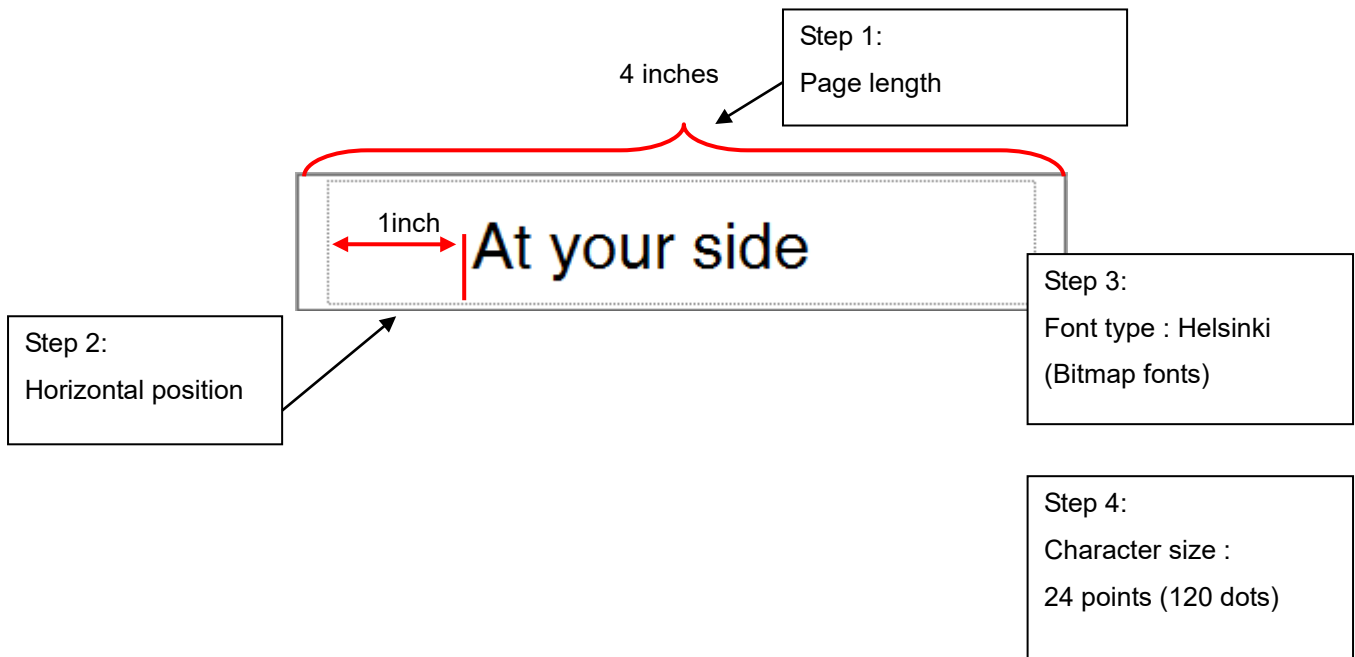

In order to make this label, the following four steps are required.

Step

1. Specify the tape length
2. Specify the horizontal position.
3. Select the font type.
4. Specify the character size.

Step 1: Specify the tape length

ESC il Specify label length

ASCII:	ESC	i	l	n1	n2
Decimal:	27	105	108	n1	n2
Hexadecimal:	1B	69	6C	n1	n2

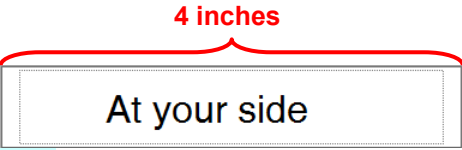

Parameters

len=n1+n2x256
 (len=0 or 36≤len≤7200)

Description

- Specifies the label length (len) in units of 1/180 inch.
- The range in which the label length can be set is 0.2 to 40 inches.
- len=0 specifies the AUTO setting.

4 inches = 720 dots

Tape length = n1 + n2 * 256 = 720

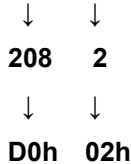

Step 2: Specify the horizontal position.

ESC \$ Specify absolute horizontal position

ASCII:	ESC	\$	n1	n2
Decimal:	27	36	n1	n2
Hexadecimal:	1B	24	n1	n2



Parameters

0≤n1≤255, 0≤n2≤255

Description

- Specifies an absolute print position (in units of 1/60 inch) for the next data.
- An absolute print position specifies the horizontal print position from the left margin.
- The next character is printed at a position (n1 + 256 * n2) / 60 inch from the left margin.
- The maximum number of dots can be specified by both n1 and n2 is 1023/60 inches.

1 inch = 60

Horizontal position = n1 + n2 * 256 = 60

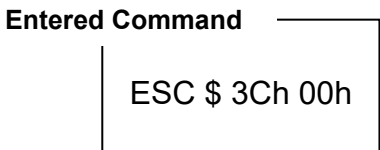
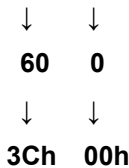

Step 3: Select the font type.

ESC k Select font

ASCII:	ESC	k	n	At your side
Decimal:	27	107	n	
Hexadecimal:	1B	6B	n	

Parameters

0 ≤ n ≤ 1

Font type : Helsinki
(Bitmap font)

Description

- Selects the font.

Bitmap fonts	
n=0	Helsinki
n=1	Letter Gothic

- The default value is n=0 (Helsinki).

Entered Command

ESC k 00h

Step 4: Specify the character size.

ESC X Specify character size

ASCII:	ESC	X	n	At your side
Decimal:	27	88	n	
Hexadecimal:	1B	58	n	

Parameters

0 ≤ n ≤ 6 or 30h ≤ n ≤ 36h

Character size :
24 points (120 dots)

Description

- Specifies the character size.
- The character size can be set to AUTO or a fixed size (six sizes).

- n=0 (or 30h): The AUTO size is applied.
- n=1 (or 31h): The 4-point size is applied. (21 dots)
- n=2 (or 32h) The 6-point size is applied. (28 dots)
- n=3 (or 33h) The 9-point size is applied. (44 dots)
- n=4 (or 34h) The 12-point size is applied. (56 dots)
- n=5 (or 35h) The 18-point size is applied. (88 dots)
- n=6 (or 36h) The 24-point size is applied. (120 dots)**

Entered Command

ESC X 36h

All commands together will make the example label shown below.

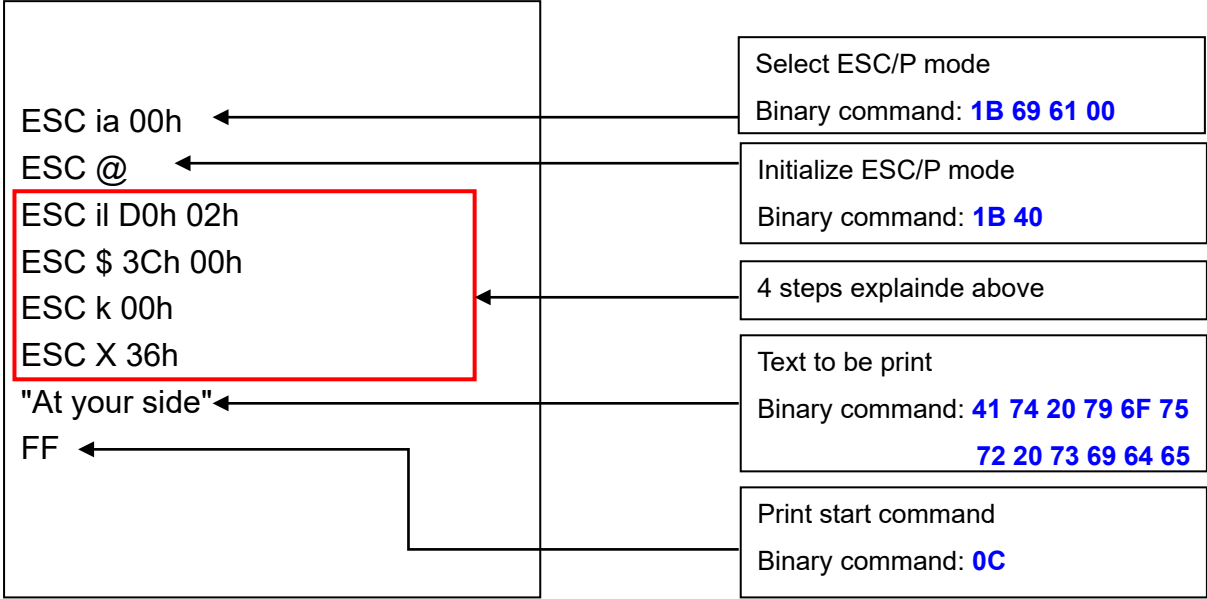

However, these commands should be converted to binary data before sent to the printer, as shown below.

Here is the captured converted binary data.

```

1B 69 61 00 1B 40 1B 69-6C D0 02 1B 24 3C 00 1B
6B 00 1B 58 36 41 74 20-79 6F 75 72 20 73 69 64
65 0C

```

When the printer receives above binary commands, the label shown below is printed.

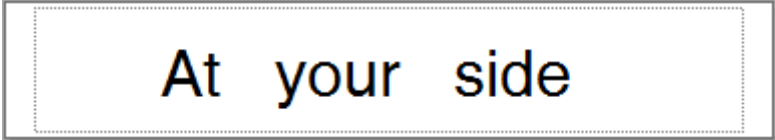

3. ESC/P Command Limitations

3.1 Print area

The print area for each tape width is listed below.



Type	Width (mm)	Printable area (vertical) (mm/dots)	Top/bottom margins (mm)	Length (mm)	Printable area (horizontal) mm/dots	Left/right margins (mm)	Dot position *1	Max. no. of printed lines
	①	②	③	④	⑤	⑥		
36	36	32.0/454	2.00	/	/	/	46~499	18
24	24	22.6/320	0.71	/	/	/	113~432	13
18	18	16.5/234	0.75	/	/	/	156~389	9
12	12	10.6/150	0.71	/	/	/	198~347	6
9	9	7.5/106	0.76	/	/	/	220~325	4
6	6	4.5/64	0.74	/	/	/	241~304	2
3.5	3.5	2.5/36	0.74	/	/	/	255~290	1
HS24	23.6	18.1/256	2.8	/	/	/	145~400	10
HS18	17.7	15.0/212	1.4	/	/	/	167~378	8
HS12	11.7	9.3/132	1.1	/	/	/	207~338	5
HS9	8.8	6.8/96	1.0	/	/	/	225~320	4
HS6	5.8	4.0/56	0.9	/	/	/	245~300	2
HSE36	31.0	25.4/360	2.8	/	/	/	93~452	15
HSE24	21.0	16.9/240	2.0	/	/	/	153~392	10
HSE12	11.2	7.1/100	2.1	/	/	/	223~322	4
HSE9	9.0	6.2/88	1.4	/	/	/	229~316	3
HSE6	5.2	2.8/40	1.2	/	/	/	253~292	1

*1 The dot position for the lowest dot is specified as 1. (1~560)

The maximum length (④) is 1 m, and the minimum left and right margins (⑥) are 1 mm.

File label is recognized as 24mm width label.

3.2 Characters

<Overseas>

- This system uses single-byte character codes and is installed with two bitmap fonts (Letter Gothic and Helsinki).
- Each font has six sizes: 21 dots, 28 dots, 44 dots, 56 dots, 88 dots and 120 dots.

3.2.1 Character sizes

<Overseas>

Each font is available in full size, compressed (half width) and double width.

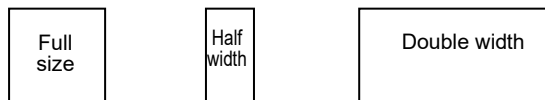

- Line-drawing characters (┌ └ ┘ ┐ ┆ ┇ ┈ ┉) and shaded characters appear with the width of the Letter Gothic font, regardless of the specified font setting.

3.3 Print position

The print position is the standard position for printing characters, bitmaps and bar codes.

With the print position, there is a horizontal print position, which is the reference point for vertical position movement.

3.3.1 Characters

Each character is arranged so that their top edge aligns with the print position.

The baseline of each character is the bottom edge of the character, regardless of size, font, etc.

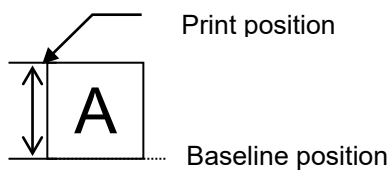

All characters on the same line are printed so that the baseline position is the same for each character.

If the text consists of characters with different heights, the characters are aligned on the baseline of the tallest character in the line of text.

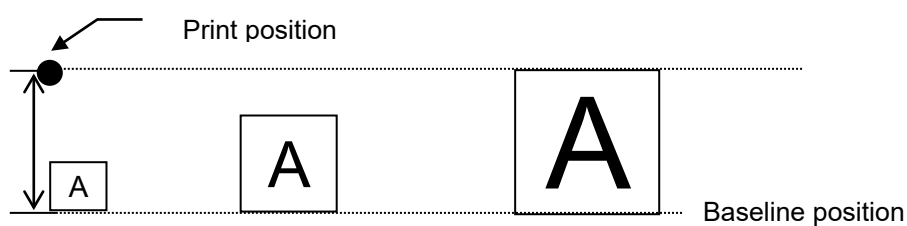

In addition, underlines are printed 4 dots below the baseline position.

3.3.2 Bitmaps, barcodes and downloaded images

These types of image data are treated in the same way as characters and are printed so that the bottom edge of the image aligns with the baseline.

3.4 Line feed amount

The line feed amount is the amount of vertical movement from the print position of one line to the print of the next line.

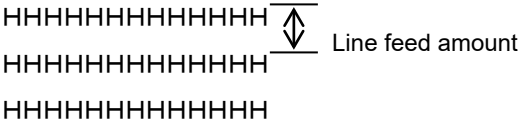

The line feed amount is specified using ESC 0, ESC 2, ESC A and ESC 3.

4. Control Code List

Character/style selection commands (Refer to section [5.1 Character/style selection commands.](#))

ASCII Code	Binary Code	Description
ESC R	1B 52	Select international character set
ESC k	1B 6B	Select font
ESC t	1B 74	Select character code table

Text printing commands (Refer to section [5.2 Text printing commands](#))

ASCII Code	Binary Code	Description
ESC 4	1B 34	Apply italic style
ESC 5	1B 35	Cancel italic style
ESC E	1B 45	Apply bold style
ESC F	1B 46	Cancel bold style
ESC G	1B 47	Apply double-strike printing
ESC H	1B 48	Cancel double-strike printing
ESC W	1B 57	Specify double-width characters
SI	0F	Specify compressed characters
ESC SI	1B 0F	Specify compressed characters
DC2	12	Cancel compressed characters
ESC -	1B 2D	Apply/cancel underlining
ESC !	1B 21	Global formatting
ESC X	1B 58	Specify character size
ESC if	1B 69 66	Apply/cancel a frame (global)
CAN	18	Clear text
DEL	7F	Delete one character
ESC CR	1B 0D	Not available

Line feed commands (Refer to section [5.3 Line feed commands.](#))

ASCII Code	Binary Code	Description
ESC 0	1B 30	Specify line feed of 1/8 inch
ESC 2	1B 32	Specify line feed of 1/6 inch
ESC 3	1B 33	Specify minimum line feed
ESC A	1B 41	Specify line feed of n/60 inch

Horizontal movement commands (Refer to section [5.4 Horizontal movement commands.](#))

ASCII Code	Binary Code	Description
CR	0D	Carriage return
ESC \$	1B 24	Specify absolute horizontal position
ESC \	1B 5C	Specify relative horizontal position
ESC a	1B 61	Specify alignment

Vertical movement commands (Refer to section [5.5 Vertical movement commands.](#))

ASCII Code	Binary Code	Description
LF	0A	Line feed
FF	0C	Page feed
ESC J	1B 4A	Forward paper feed

Paper formatting commands (Refer to section [5.6 Paper formatting commands.](#))

ASCII Code	Binary Code	Description
ESC i l	1B 69 6C	Specify label length
ESC i m	1B 69 6D	Specify margin width

Printer control commands (Refer to section [5.7 Printer control commands.](#))

ASCII Code	Binary Code	Description
ESC @	1B 40	Initialize

Graphics commands (Refer to section [5.8 Graphics commands.](#))

ASCII Code	Binary Code	Description
ESC *	1B 2A	Select bit image
ESC K	1B 4B	8-dot single-density bit image
ESC L	1B 4C	8-dot double-density bit image
ESC Y	1B 59	8-dot double-speed double-density bit image
ESC Z	1B 5A	8-dot quadruple-density bit image

Advanced commands (Refer to section [5.9 Advanced commands.](#))

ASCII Code	Binary Code	Description
ESC i B	1B 69 42	Barcode
ESC i Q	1B 69 51	2D bar code (QR Code)
ESC i P	1B 69 50	Specify QR Code version
ESC i V	1B 69 56	2D bar code (PDF417)
ESC i D	1B 69 44	2D bar code (DataMatrix)
ESC i M	1B 69 4D	2D bar code (MaxiCode)
ESC i J	1B 69 4A	2D barcode (AztecCode)
ESC i F	1B 69 46	Print transferred data
ESC i a	1B 69 61	Switch command mode
ESC i S	1B 69 53	Request printer status
ESC i L	1B 69 4C	Apply/cancel rotated printing
ESC i C	1B 69 43	Specify cut setting
ESC i UB	1B 69 55 42	Specify baud rate
ESC i Ub	1B 69 55 62	Specify bit length
ESC i UP	1B 69 55 50	Specify parity setting
ESC i UC	1B 69 55 43	Specify busy control

Advanced static commands (Refer to section [5.10 Advanced static commands.](#))

ASCII Code	Binary Code	Description
ESC iXE2	1B 69 58 45 32	Specify barcode margin setting
ESC iXE1	1B 69 58 45 31	Retrieve barcode margin setting

5. Control Command Details

5.1 Character/style selection commands

ESC R Select international character set

ASCII:	ESC	R	n
Decimal:	27	82	n
Hexadecimal:	1B	52	n

Parameters

$0 \leq n \leq 13, 64$

Description

- Selects the character set for the country, and switches some character codes in the code table according to the value of n.
 - n=0: U.S.A
 - n=1: France
 - n=2: Germany
 - n=3: UK
 - n=4: Denmark I
 - n=5: Sweden
 - n=6: Italy
 - n=7: Spain I
 - n=8: Japan
 - n=9: Norway
 - n=10: Denmark II
 - n=11: Spain II
 - n=12: Latin America
 - n=13: South Korea
 - n=64: Legal
- The following 12 codes are changed.
 - 23h, 24h, 40h, 5Bh, 5Ch, 5Dh, 5Eh, 60h, 7Bh, 7Ch, 7Dh, 7Eh
- The default setting is n=0 (USA) for overseas.
- When using the standard character code table, printing is performed according to the specified international character set.

Example

Code: 5Ch ESC R 08h 5Ch FF
 Print result: \¥

ESC k Select font

ASCII:	ESC	k	n
Decimal:	27	107	n
Hexadecimal:	1B	6B	n

Parameters
 $0 \leq n \leq 1$
Description

- Selects the font.

Bitmap fonts	
n=0	Helsinki
n=1	Letter Gothic

- The default value is n=0 (Helsinki).

ESC t Select character code table

ASCII:	ESC	t	n
Decimal:	27	116	n
Hexadecimal:	1B	74	n

Parameters

n=0, 1, 2

Description

- From the three built-in character code tables, select the character code table to be used.
 - n=0: Standard character code table
 - n=1: Eastern European character code table
 - n=2: Western European character code table
 - n=3: (Spare)
- The default setting is n=0.

5.2 Text printing commands

ESC 4 Apply italic style

ASCII:	ESC	4
Decimal:	27	52
Hexadecimal:	1B	34

Parameters

None

Description

- Applies the italic style to the following text.

ESC 5 Cancel italic style

ASCII:	ESC	5
Decimal:	27	53
Hexadecimal:	1B	35

Parameters

None

Description

- Cancels the italic style.

Example

Code:	ABC ESC 4 DEF ESC 5 GHI FF
Print result:	ABCDEFGHI

ESC E Apply bold style

ASCII:	ESC	E
Decimal:	27	69
Hexadecimal:	1B	45

Parameters

None

Description

- Prints the following text in bold.

ESC F Cancel bold style

ASCII:	ESC	F
Decimal:	27	70
Hexadecimal:	1B	46

Parameters

None

Description

- Cancels the bold style.

Example

Code:	ABC ESC E DEF ESC F GHI FF
Print result:	ABC DEF GHI

ESC G Apply double-strike printing

ASCII:	ESC	G
Decimal:	27	71
Hexadecimal:	1B	47

Parameters

None

Description

- Prints the following text in bold.

ESC H Cancel double-strike printing

ASCII:	ESC	H
Decimal:	27	72
Hexadecimal:	1B	48

Parameters

None

Description

- Cancels the bold style.

Example

Code:	ABC ESC E DEF ESC F GHI FF
Print result:	ABC DE FGHI

ESC W Specify double-width characters

ASCII:	ESC	W	n
Decimal:	27	87	n
Hexadecimal:	1B	57	n

Parameters

n=0 and 1 or 48 and 49

Description

- Specifies double-width characters.

n=1 or 49 ("1"): Double-width characters are specified.

n=0 or 48 ("0"): Double-width characters are cancelled.

Example

Code:	ABC ESC W 1 ABC ESC W 0 ABC FF
Print result:	ABC ABC ABC

SI Specify compressed characters

ASCII:	SI
Decimal:	15
Hexadecimal:	0F

Parameters

None

Description

- Prints the following text in half-width characters.

ESC SI Specify compressed characters

ASCII:	ESC	SI
Decimal:	27	15
Hexadecimal:	1B	0F

Parameters

None

Description

- Same as SI

DC2 Cancel compressed characters

ASCII:	DC2
Decimal:	18
Hexadecimal:	12

Parameters

None

Description

- Cancels compressed characters specified with SI.

ESC – Apply/cancel underlining

ASCII:	ESC	-	n
Decimal:	27	45	n
Hexadecimal:	1B	2D	n

Parameters

n=0 and 1 or 48 and 49

Description

- Applies or cancels underlining.
 - n=1: Underlining is applied.
 - n=0: Underlining is cancelled.
- The underlining specified by this code is a continuous line.
- Spaces between characters and words are also underlined.

Example

Code:	ABC ESC - 1 ABC ESC - 0 ABC FF
Print result:	ABC <u>ABC</u> ABC

ESC ! Global formatting

ASCII:	ESC	!	n
Decimal:	27	33	n
Hexadecimal:	1B	21	n

Parameters

$0 \leq n \leq 255$

Description

- Specifies a combination of the various print modes.
- Specifies modes according to the bit value of n.
- A combination of multiple print modes can be specified at one time.

Bit	7	6	5	4	3	2	1	0
1	Underline	Italics	Not used	Bold	Bold	Not used	Not used	Not used
0	Cancel	Cancel	Not used	Cancel	Cancel	Not used	Not used	Not used

Example

- To apply underlining and the italic style at one time

Code: ABC ESC ! C0h ABC ESC ! 00h ABC FF
 Print result: ABC*ABC*ABC

ESC X Specify character size

ASCII:	ESC	X	n
Decimal:	27	88	n
Hexadecimal:	1B	58	n

Parameters

$0 \leq n \leq 6$ or $30h \leq n \leq 36h$

Description

- Specifies the character size.
- The character size can be set to AUTO or a fixed size (six sizes).
 - n=0 (or 30h): The AUTO size is applied.
 - n=1 (or 31h): The 4-point size is applied. (21 dots)
 - n=2 (or 32h): The 6-point size is applied. (28 dots)
 - n=3 (or 33h): The 9-point size is applied. (44 dots)
 - n=4 (or 34h): The 12-point size is applied. (56 dots)
 - n=5 (or 35h): The 18-point size is applied. (88 dots)
 - n=6 (or 36h): The 24-point size is applied. (120 dots)

ESC if Apply/cancel a frame

ASCII:	ESC	i	f
Decimal:	27	105	102
Hexadecimal:	1B	69	66

Parameters

0≤n≤1 or 30h≤n≤31h

Description

- Applies a frame around the entire text.
 - n=0 (or 30h): The frame is cancelled.
 - n=1 (or 31h): A frame is applied.

CAN Clear text

ASCII:	CAN
Decimal:	24
Hexadecimal:	18

Parameters

None

Description

- Clears all text, image data and bar codes that were received.

DEL Delete one character

ASCII:	DEL
Decimal:	127
Hexadecimal:	7F

Parameters

None

Description

- The immediately preceding character within the same line is deleted.
- If the immediately preceding data is a bar code, the bar code is deleted.
- Image data is not deleted.

ESC CR Not available

ASCII:	ESC	CR	n
Decimal:	27	13	n
Hexadecimal:	1B	0D	n

Parameters $0 \leq n \leq 255$ **Description**

- Does nothing.

5.3 Line feed commands

ESC 0 Specify line feed of 1/8 inch

ASCII:	ESC	0
Decimal:	27	48
Hexadecimal:	1B	30

Parameters

None

Description

- Specifies a line feed of 1/8 inch (approximately 0.32 cm).

ESC 2 Specify line feed of 1/6 inch

ASCII:	ESC	2
Decimal:	27	50
Hexadecimal:	1B	32

Parameters

None

Description

- Specifies a line feed of 1/6 inch (approximately 0.42 cm).

ESC 3 Specify line feed of n/180 inch

ASCII:	ESC	3	n
Decimal:	27	51	n
Hexadecimal:	1B	33	n

Parameters
 $0 \leq n \leq 255$
Description

- Specifies a line feed of n/180 inch per text line.
- If n is less than 24, the line feed amount is set to 24/180 inch (approximately 0.34 cm).

ESC A Specify line feed of n/60 inch

ASCII:	ESC	A	n
Decimal:	27	65	n
Hexadecimal:	1B	41	n

Parameters
 $0 \leq n \leq 255$
Description

- Specifies a line feed of n/60 inch per text line.
- If n is less than 8, the line feed amount is set to 8/60 inch (approximately 0.34 cm).

5.4 Horizontal movement commands

CR **Carriage return**

ASCII:	CR
Decimal:	13
Hexadecimal:	0D

Parameters

None

Description

- Performs a line feed of the amount specified by a line feed command (ESC 0, ESC 2, ESC 3 and ESC A).
- If no line feed amount has been specified, it is automatically specified depending on the width of the tape.
- The next print position is the beginning of the next line.
- A line feed command immediately after a carriage return is ignored.

ESC \$ Specify absolute horizontal position

ASCII:	ESC	\$	n1	n2
Decimal:	27	36	n1	n2
Hexadecimal:	1B	24	n1	n2

Parameters

$0 \leq n1 \leq 255, 0 \leq n2 \leq 255$

Description

- Specifies an absolute print position (in units of 1/60 inch) for the next data.
- An absolute print position specifies the horizontal print position from the left margin.
- The next character is printed at a position $(n1 + 256 * n2) / 60$ inch from the left margin.
- The maximum number of dots can be specified by both n1 and n2 is 1023/60 inches.

ESC \ Specify relative horizontal position

ASCII:	ESC	\	n1	n2
Decimal:	27	92	n1	n2
Hexadecimal:	1B	5C	n1	n2

Parameters

$0 \leq n1 \leq 255, 0 \leq n2 \leq 255$

Description

- Specifies a relative print position (in units of 1/180 inch) for the next data.
- A relative print position specifies the horizontal print position based on the current position.
- The next character is printed at a position $(n1 + 256 * n2) / 180$ inch from the current position.
- A relative position cannot be specified to the left (in the negative direction).
- The maximum number of dots can be specified by both n1 and n2 is 16383/180 inches.
- This command is available only with left alignment.

ESC a Specify alignment

ASCII:	ESC	a	n
Decimal:	27	97	n
Hexadecimal:	1B	61	n

Parameters

0≤n≤3 or "0"≤n≤"3"

Description

- The following data is printed with the alignment described below, depending on the value of n.
 - n=0: specifies left alignment.
 - n=1: specifies center alignment.
 - n=2: specifies right alignment.
 - n=3: specifies justified alignment.
- The default setting is n=0.
- The last alignment setting received is applied to all of the print data.
- If an absolute horizontal position or a relative horizontal position is specified, the text must be aligned on the left when it is printed.

5.5 Vertical movement commands

LF **Line feed**

ASCII:	LF
Decimal:	10
Hexadecimal:	0A

Parameters

None

Description

- Performs the same line feed operation as CR.
- A carriage return command immediately after a line feed is ignored.

FF **Page feed**

ASCII:	FF
Decimal:	12
Hexadecimal:	0C

Parameters

None

Description

- Starts printing.
- Clears the text, image data and bar codes after printing.
- If the data does not fit within the printable height of the tape, the data is divided and printed onto multiple pages.
- If the length of the print data exceeds 1 meter, the LED lights up to indicate that an error has occurred.

ESC J Forward paper feed

ASCII:	ESC	J	n
Decimal:	27	74	n
Hexadecimal:	1B	4A	n

Parameters $0 \leq n \leq 255$ Description

- Finishes input of the current line, then moves the vertical print position forward by $n/180$ inch.
- If n is less than 24, the feed amount is $24/180$ inch (approximately 0.34 cm).

5.6 Paper formatting commands

ESC il Specify label length

ASCII:	ESC	i	l	n1	n2
Decimal:	27	105	108	n1	n2
Hexadecimal:	1B	69	6C	n1	n2

Parameters

$$\text{len} = n1 + n2 \times 256$$

$$(\text{len} = 0 \text{ or } 36 \leq \text{len} \leq 7200)$$
Description

- Specifies the label length (len) in units of 1/180 inch.
- The range in which the label length can be set is 0.2 to 40 inches.
- len=0 specifies the AUTO setting.

ESC im Specify margin width

ASCII:	ESC	i	m	n1	n2
Decimal:	27	105	109	n1	n2
Hexadecimal:	1B	69	6D	n1	n2

Parameters

$$\text{mgn} = n1 + n2 \times 256$$

$$(7 \leq \text{mgn} \leq 720)$$
Description

- Specifies the margin width (mgn) in units of 1/180 inch.
- The range in which the margin width can be set is 0.04 to 4 inches.

5.7 Printer control commands

ESC @ Initialize

ASCII:	ESC	@
Decimal:	27	64
Hexadecimal:	1B	40

Parameters

None

Description

- Resets all parameters to their default settings. (See below.)

Item	After Initialization
Command mode (ESC/P, Raster or P-touch Template)	No change
Communication settings (Baud rate, Parity, Bit length and Busy control)	No change
Received text and bar codes	Cleared
Received image data	Cleared
Line feed amount	AUTO
Relative position setting	Cleared
Absolute position setting	Cleared
Font	Helsinki
Character size	AUTO
Italics	OFF
Bold/double-strike printing	OFF
Underline	OFF
Character width	Normal (Half-width and double-width characters are cancelled.)
Character code table	Standard character code table
International character set	USA
Frame	None
Rotate	OFF
Text alignment	Left
Margins	2 mm
Label length setting	AUTO
Bar code protocol	CODE39

Item	After Initialization
Bar code width	Small
Bar code ratio	3:1
Bar code check digit	OFF
Characters below bar codes	ON
Full cut	ON
Half cut	ON
Chain printing	OFF

5.8 Graphics commands

ESC * Select bit image

ASCII:	ESC	*	m	n1	n2	data
Decimal:	27	42	m	n1	n2	data
Hexadecimal:	1B	2A	m	n1	n2	data

Parameters

m=0, 1, 2, 3, 4, 6, 32, 33, 38, 39, 40, 71, 72 or 73

$0 \leq n1 \leq 255$, $0 \leq n2 \leq 255$

The data contains image data that is $n1 + n2 * 256$ bytes when m=0, 1, 2, 3, 4 or 6,

$(n1 + n2 * 256) * 3$ bytes when m=32, 33, 38, 39 or 40,

or $(n1 + n2 * 256) * 6$ bytes when m=71, 72 or 73.

Description

- Selects and outputs a bit image according to the value of m.
- n1 and n2 indicate the number of dot positions.

n1: The remainder from dividing the number of dot positions by 256

n2: The quotient from dividing the number of dot positions by 256

m	Horizontal Dot Density	Vertical Dot Density	Horizontal Dot Resolution	Vertical Dot Resolution
0	60 dpi	60 dpi	6/360 inch	6/360 inch
1	120 dpi	60 dpi	3/360 inch	6/360 inch
2	120 dpi	60 dpi	3/360 inch	6/360 inch
3	240 dpi	60 dpi	2/360 inch	6/360 inch
4	80 dpi	60 dpi	4/360 inch	6/360 inch
6	90 dpi	60 dpi	4/360 inch	6/360 inch
32	60 dpi	180 dpi	6/360 inch	2/360 inch
33	120 dpi	180 dpi	3/360 inch	2/360 inch
38	90 dpi	180 dpi	4/360 inch	2/360 inch
39	180 dpi	180 dpi	2/360 inch	2/360 inch
40	360 dpi	180 dpi	1/360 inch	2/360 inch
71	180 dpi	360 dpi	2/360 inch	1/360 inch
72	360 dpi	360 dpi	1/360 inch	1/360 inch
73	360 dpi	360 dpi	1/360 inch	1/360 inch

When m=0, 1, 2, 3, 4 or 6

- n1 and n2 indicate the number of dot positions.
 - n1: The remainder from dividing the number of dot positions by 256
 - n2: The quotient from dividing the number of dot positions by 256

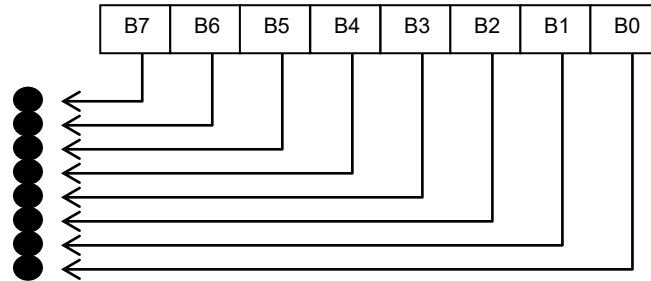

Relationship between the image data and the dots

- First, the data is lined up in one row as shown below.

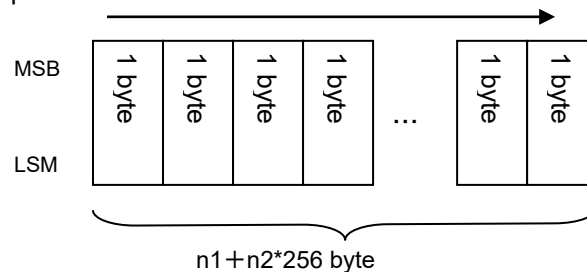

- One dot of the image data is enlarged according to the value of m, as shown below.

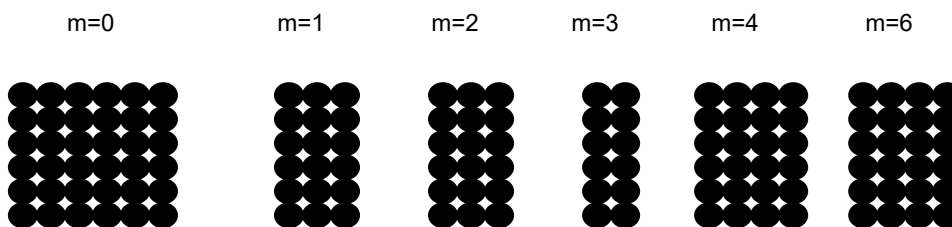

- As a result, the image is sized depending on the value of m, as shown below.

- m=0 48 dots vertically × (n1 + n2 * 256) * 6 dots horizontally
- m=1 48 dots vertically × (n1 + n2 * 256) * 3 dots horizontally
- m=2 48 dots vertically × (n1 + n2 * 256) * 3 dots horizontally
- m=3 48 dots vertically × (n1 + n2 * 256) * 2 dots horizontally
- m=4 48 dots vertically × (n1 + n2 * 256) * 4 dots horizontally
- m=6 48 dots vertically × (n1 + n2 * 256) * 4 dots horizontally

When m=32, 33, 38, 39 or 40

- n1 and n2 indicate the number of dot positions.
 - n1: The remainder from dividing the number of dot positions by 256
 - n2: The quotient from dividing the number of dot positions by 256

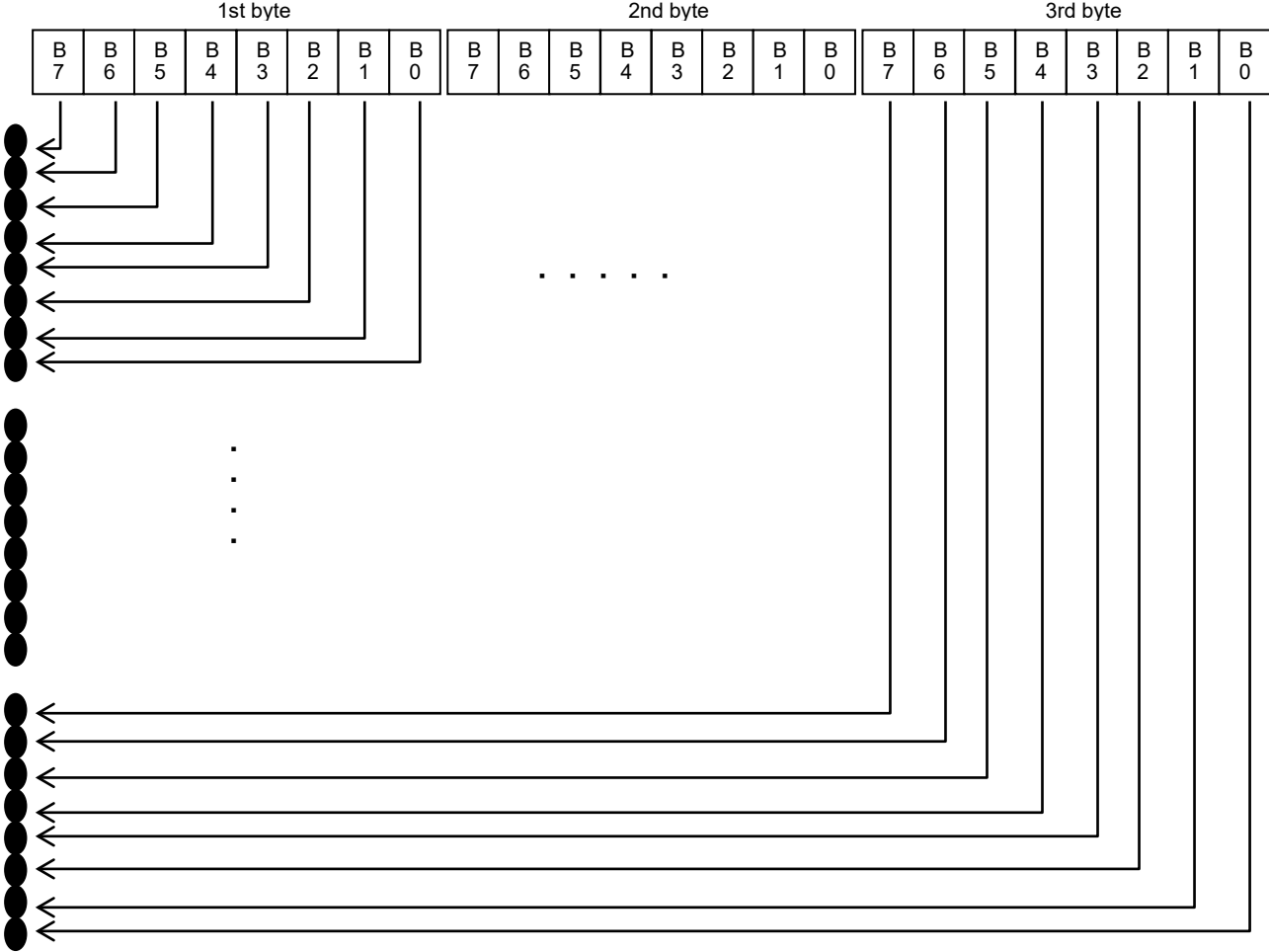

Relationship between the image data and the dots

- First, the data is lined up in three rows as shown below.

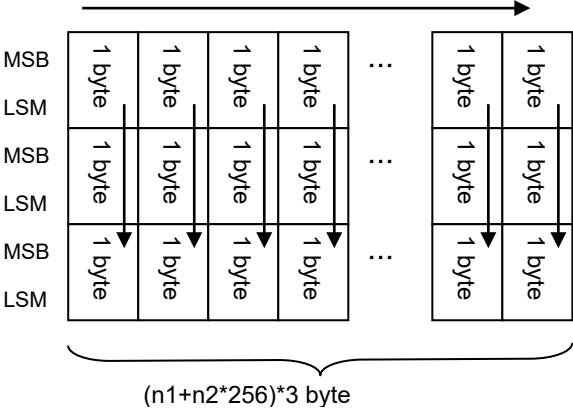

- One dot of the image data is enlarged according to the value of m, as shown below.

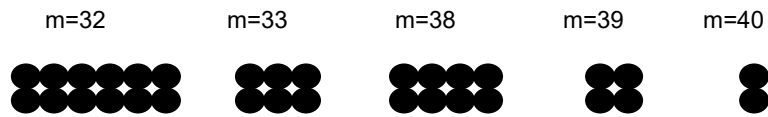

- As a result, the image is sized depending on the value of m, as shown below.

m=32	48 dots vertically × (n1 + n2 * 256) * 6 dots horizontally
m=33	48 dots vertically × (n1 + n2 * 256) * 3 dots horizontally
m=38	48 dots vertically × (n1 + n2 * 256) * 4 dots horizontally
m=39	48 dots vertically × (n1 + n2 * 256) * 2 dots horizontally
m=40	48 dots vertically × (n1 + n2 * 256) * 4 dots horizontally

When m=71, 72 or 73

- n1 and n2 indicate the number of dot positions. Specify their values as shown below.
n1: The remainder from dividing the number of dot positions by 256
n2: The quotient from dividing the number of dot positions by 256

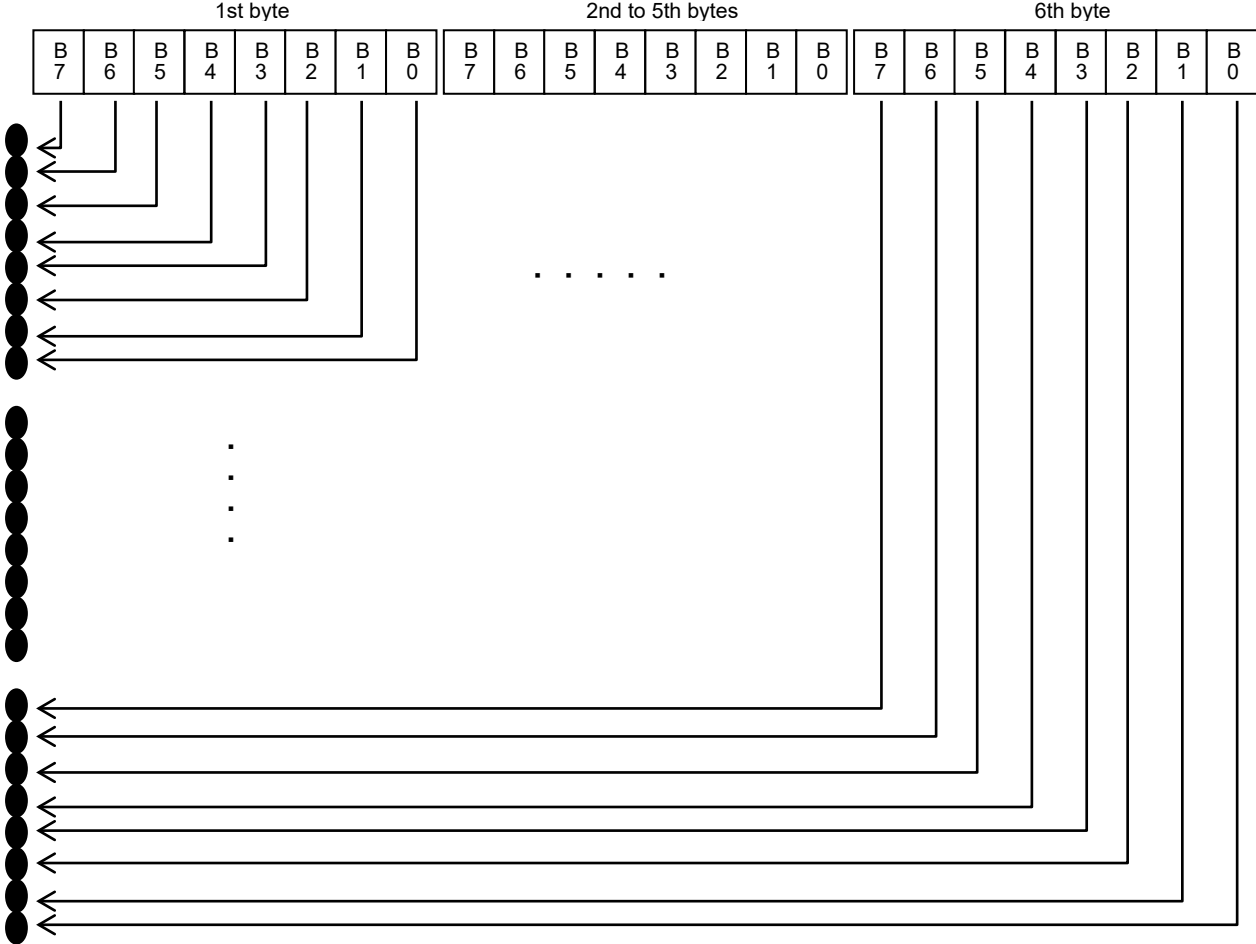

Relationship between the image data and the dots

- First, the data is lined up in six rows as shown below.

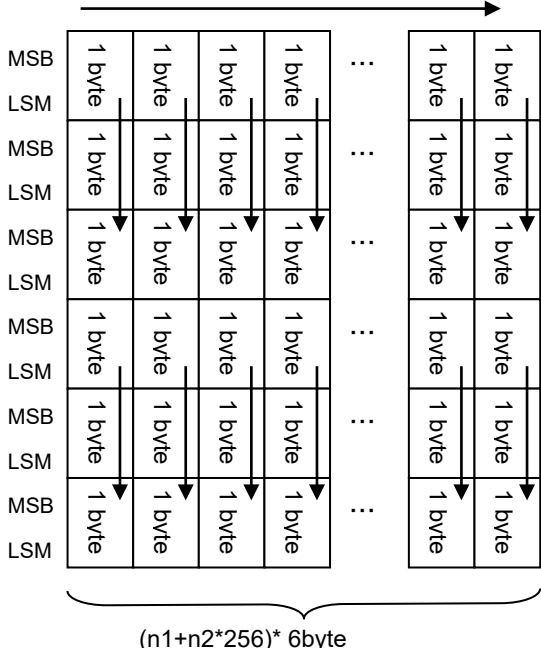

- One dot of the image data is enlarged according to the value of m, as shown below.

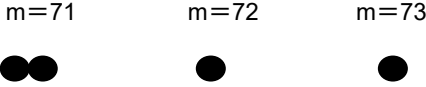

- As a result, the image is sized depending on the value of m, as shown below.

m=71 48 dots vertically × (n1 + n2 * 256) * 2 dots horizontally
 m=72 48 dots vertically × (n1 + n2 * 256) * 1 dot horizontally
 m=73 48 dots vertically × (n1 + n2 * 256) * 1 dot horizontally

ESC K 8-dot single-density bit image

ASCII:	ESC	K	n1	n2	data
Decimal:	27	75	n1	n2	data
Hexadecimal:	1B	4B	n1	n2	data

Parameters

$0 \leq n1 \leq 255, 0 \leq n2 \leq 255$

The data contains image data that is $n1 + n2 * 256$ bytes.

Description

Specifies that an 8-dot standard-density bit image will be printed with the number of dot positions defined by n1 and n2.

- n1 and n2 indicate the number of dot positions.
 - n1: The remainder from dividing the number of dot positions by 256
 - n2: The quotient from dividing the number of dot positions by 256

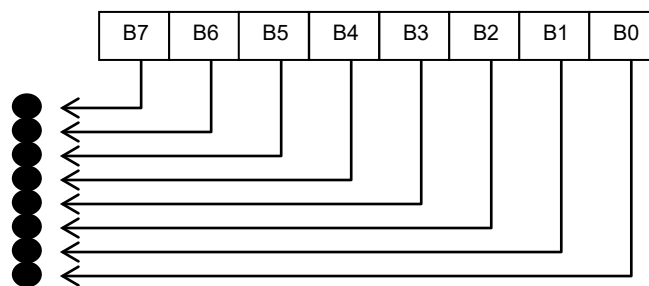

Relationship between the image data and the dots

- First, the data is lined up in one row as shown below.

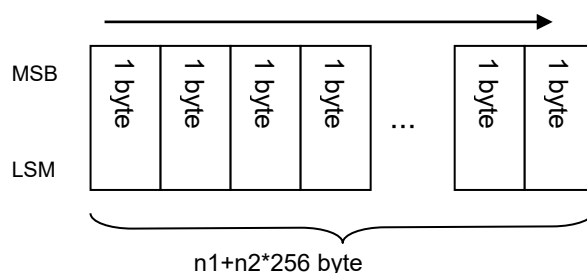

- One dot of the image data is enlarged to 6 dots vertically by 6 dots horizontally.

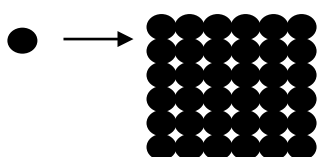

- As a result, the image becomes 48 dots vertically $\times (n1 + n2 * 256) * 6$ dots horizontally.

ESC L 8-dot double-density bit image

ASCII:	ESC	L	n1	n2	data
Decimal:	27	76	n1	n2	data
Hexadecimal:	1B	4C	n1	n2	data

Parameters

$0 \leq n1 \leq 255, 0 \leq n2 \leq 255$

The data contains image data that is $n1 + n2 * 256$ bytes.

Description

Specifies that an 8-dot double-density bit image will be printed with the number of dot positions defined by $n1$ and $n2$.

- Specify $n1$ and $n2$ in the same way as with ESC K.
- First, the data is lined up in one row as shown below.

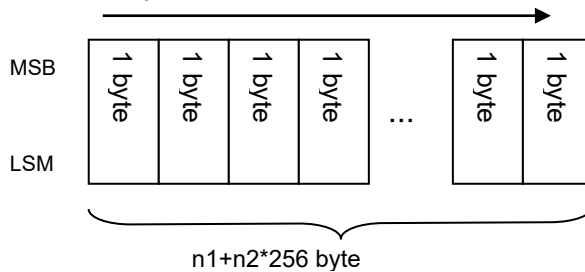

- One dot of the image data is enlarged to 6 dots vertically by 3 dots horizontally.

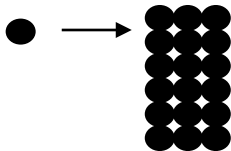

- As a result, the image becomes 48 dots vertically $\times (n1 + n2 * 256) * 3$ dots horizontally.

ESC Y 8-dot double-speed double-density bit image

ASCII:	ESC	Y	n1	n2	data
Decimal:	27	89	n1	n2	data
Hexadecimal:	1B	59	n1	n2	data

Parameters

$0 \leq n1 \leq 255, 0 \leq n2 \leq 255$

The data contains image data that is $n1 + n2 * 256$ bytes.

Description

- Specifies that an 8-dot double-speed double-density bit image will be printed with the number of dot positions defined by n1 and n2.
- Specify n1 and n2 in the same way as with ESC K.

ESC Z 8-dot quadruple-density bit image

ASCII:	ESC	Z	n1	n2	data
Decimal:	27	90	n1	n2	data
Hexadecimal:	1B	5A	n1	n2	data

Parameters

$0 \leq n1 \leq 255, 0 \leq n2 \leq 255$

The data contains image data that is $n1 + n2 * 256$ bytes.

Description

Specifies that an 8-dot double-density bit image will be printed with the number of dot positions defined by n1 and n2.

- Specify n1 and n2 in the same way as with ESC K.
- First, the data is lined up in one row as shown below.

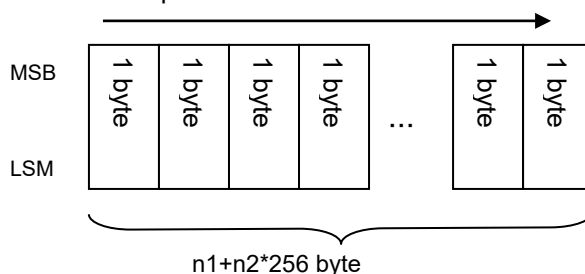

- One dot of the image data is enlarged to 6 dots vertically by 2 dots horizontally.

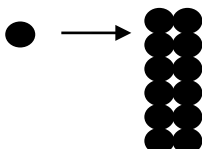

- As a result, the image becomes 48 dots vertically $\times (n1 + n2 * 256) * 2$ dots horizontally.

5.9 Advanced commands

ESC i B Barcode

ASCII:	ESC	i [Parameters]	B or b [Barcode data]	Backslash
Decimal:	27	105 [Parameters]	66 or 98 [Barcode data]	92
Hexadecimal:	1B	69 [Parameters]	42 or 62 [Barcode data]	5C
Format:	ESC	i [Parameters]	B or b [Barcode data]	Backslash
		(1)	(2) (3)	(4)

Parameters**(1) [Parameters] : Barcode parameters**

T or t (type)	t0: CODE39 t1: ITF (I-2/5) t2: EAN-13 t3: EAN-8 t4: UPC-A t5: EAN-8 (when the bar code data contains 7 characters) UPC-A (when the bar code data contains 11 characters) EAN-13 (when the bar code data contains 12 characters) * The check digit mark “?” is not included in the number of characters. t6: UPC-E t9: CODABAR ta: CODE128 tb: GS1-128 (UCC/EAN-128) tc: RSS symbols te: POSTNET
s (style)	Ignored
p (number of passes)	Ignored
R or r (characters below barcode)	r0: OFF r1: ON
u (units of measurement)	Ignored
x (horizontal position)	Ignored
y (vertical offset)	Ignored

h (height)	<p>h n1 n2 Height = $n1 + n2 * 256$ (dots) $48 \leq \text{height} \leq 454$ If height < 48, height = 48. If height > 454, height = 454.</p>
	<p>However, with tc, the height is as described below. $141 \leq \text{height} \leq 454$ (RSS-14 Standard) $81 \leq \text{height} \leq 454$ (RSS-14 Truncated) $81 \leq \text{height} \leq 454$ (RSS-14 Stacked) $249 \leq \text{height} \leq 454$ (RSS-14 Stacked Omni) $72 \leq \text{height} \leq 454$ (RSS Limited) $144 \leq \text{height} \leq 454$ (RSS Expanded) If height < min., height = min. If height > max., height = max.</p>
w (width)	<p>w0: small w1: medium w2: large</p>
E or e (parentheses removed)	<p>e0: ON e1: OFF</p>
o (RSS symbols model)	<p>o0: RSS-14 Standard o1: RSS-14 Truncated o2: RSS-14 Stacked o3: RSS-14 Stacked Omnidirectional o4: RSS Limited o5: RSS Expanded Standard o6: RSS Expanded Stacked</p>
c (number of horizontal characters for RSS Expanded Stacked)	<p>c: No. of horizontal characters This must be an even value where $2 \leq \text{no. of horizontal characters} \leq 20$.</p>
z (ratio between thick and thin bars)	<p>z0: (3:1) z1: (2.5:1) z2: (2:1)</p>

(A barcode with a large number of stacked rows may be considered out of specifications and unreadable by the reader.)

Note

- * Both 00H through 09H and 30H through 39H are recognized as the parameter numbers 0 through 9.
- * Parameter types a and b are recognized, even if they are uppercase letters.
- * The parameter "parentheses removed" is available only when GS1-128 (UCC/EAN-128) is selected.
- * The parameter "ratio between thick and thin bars" is available only when t0, t1 or t9 is selected.
- * If there is no type command or if an invalid type command has been specified, Code 39 is specified.
- * The number of characters that can be entered for each barcode protocol is listed below.
 - t0: 1 to 50 characters (not including "*" on both sides)
 - t1: 1 to 64 characters
 - t5: 7 characters (EAN-8)
12 characters (EAN-13)
11 characters (UPC-A)
 - t6: 6 characters
 - t9: 3 to 64 characters (with "A", "B", "C" or "D" at the beginning and end)
 - ta: 1 to 64 characters
 - tb: 1 to 64 characters
 - tc: 3 to 15 characters (begins with "01") (except with RSS Expanded)
1 to 64 numbers or 1 to 40 letters* (for RSS Expanded)
* ISO646 characters can be printed.
(numbers, letters, spaces, !, ", %, &, ', (,), *, +, ,, -, ., /, :, ;, <, =, >, ? and _)
 - te: 5 characters, 9 characters, 11 characters

(2) B or b: Beginning of barcode data**(3) [Barcode data]: Data for the barcode**

? (Generate check digit) :

Generates a check digit when "?" is in the bar code data

The position of "?" is irrelevant as long as it is within the barcode data.

With POSTNET, CODE128 and GS1-128 (UCC/EAN-128) , no check digit is generated.

If "?" is inserted, it is treated as barcode data.

(4) [Backslash]: End of barcode data

Barcode Type	Command
POSTNET, CODE39 , ITF(I-2/5) , EAN-8 , EAN-13 , UPC-A , UPC-E , CODABAR, RSS sybols	ESC i [Parameter] B or b [Barcode data] \
CODE128, GS1-128 (UCC/EAN-128)]	ESC i [Parameter] B or b [Barcode data] \\

Description

- Specifies a barcode image.
- Since the check digit is automatically generated from the barcode data, the check digit is not sent as barcode data. Since the length of the barcode data is also checked, the data would not be correctly recognized if check digit data is present.
- With protocols CODE39, ITF (I-2/5), CODABAR, CODE128, GS1-128 (UCC/EAN-128) or RSS Expanded, the buffer length for the barcode image is about 22 cm. A bar code longer than 22 cm will not be printed.
- The characters that can be entered with CODE128 and GS1-128 (UCC/EAN-128) are the full 128 ASCII characters and the special codes FNC1, FNC2, FNC3 and FNC4.

Codes assigned to the special codes

FNC1: 86h

FNC2: 81h

FNC3: 80h

FNC4: 84h

- The control codes and special codes appear as spaces when characters are printed below CODE128 and GS1-128 (UCC/EAN-128) barcodes.
- Special code FNC1 can also be printed with RSS Expanded. This special code also appears as a space when characters are printed below the barcode.

Code assigned to the special code

FNC1: 86h

Example

For data "123456789" with barcode type CODE39, with no characters printed below the barcode, a size of large (width) × 454 dots (height), without parentheses, a ratio between thick and thin bars of 3:1, and bar lengths not equalized, the command will be as shown below.

```
ESC i t0 r0 h C6h 01h w2 e1 z0 B 123456789 \
```

ESC i Q 2D barcode (QR Code)

ASCII:	ESC	i	Q or q	Data		
Decimal:	27	105	81 or 113	Data		
Hexadecimal:	1B	69	51 or 71	Data		
Format:	ESC	i	Q or q	[Parameters]	[Barcode data]	
				(1)	(2)	(3)

Parameters**(1) [Parameters]**

Unlike with 1D barcodes, all parameters must be specified in order, starting from the top.

If a value other than those listed is entered for a parameter, that parameter is set to its default value.

1. Cell size	[1-byte decimal]	4	Specifies the dot size per cell side. Prints 4 dots per cell side. (default value)
	[1-byte decimal]	6	Prints 6 dots per cell side.
	[1-byte decimal]	8	Prints 8 dots per cell side.
	[1-byte decimal]	10	Prints 10 dots per cell side.
	[1-byte decimal]	12	Prints 12 dots per cell side.
2. Symbol type	[1-byte decimal]	1	Model 1
	[1-byte decimal]	2	Model 2 (default value)
	[1-byte decimal]	3	Micro QR
3. Structured Append setting	[1-byte decimal]	0	Not partitioned. (default value)
	[1-byte decimal]	1	Partitioned (*1)
4. Code number	[1-byte decimal]	1–16	Indicates the number of the symbol in a partitioned QR Code.
5. Number of partitions	[1-byte decimal]	2–16	Indicates the total number of symbols in a partitioned QR Code.
6. Parity data	[1-byte hexadecimal]	00-FF	Value (in bytes) of exclusively OR'ing all the print data (print data before partition)
7. Error correction level	[1-byte decimal]	1	High-density level: L 7%
	[1-byte decimal]	2	Standard level: M 15% (default value)
	[1-byte decimal]	3	High-reliability level: Q 25%
	[1-byte decimal]	4	Ultra-high-reliability level: H 30% (*2)
8. Data input method	[1-byte decimal]	0	Auto input (default value)
	[1-byte decimal]	1	Manual input Selects whether numbers, English alphanumeric characters, kanji characters or binary characters are entered.

(*1) With Micro QR, the linkage setting is invalid, and the default setting is used.

(*2) With Micro QR, error correction level 4 is invalid, and the default setting is used.

What is the QR Code Structured Append setting?

QR Codes have a linkage setting.

A long character string can be divided into 2 to 16 partitions and printed.

With ESC/P commands, it is necessary to enter only the number of partitions.

For example, if the print data is partitioned into 3 partitions, the barcode data is as follows:

```
ESC i Q or q [parameters for 1st set] [1st set of barcode data] \\
ESC i Q or q [parameters for 2nd set] [2nd set of barcode data] \\
ESC i Q or q [parameters for 3rd set] [3rd set of barcode data] \\
```

Refer to the following for specifying settings for 3 through 6 in [Parameters].

3. Structured append setting: This determines whether or not the barcode data is partitioned. If the data is not partitioned, enter 0.
When not partitioning, the values of 4 (code number), 5 (number of partitions), and 6 (parity data) are ignored; therefore, enter 0 as a dummy value for these parameters.
4. Code number: This indicates which number the ESC/P command for that QR Code is.
For example, if it is for the second of four partitions, this is 2; for the fourth this is 4.
5. Number of partitions: This is the number of partitions.
6. Parity data: This is the value (in bytes) of exclusively OR'ing all the print data (print data before partition). Entering the same value as for the partitioned QR Code ESC/P command indicates that these codes are linked.

What is exclusive OR'ing in bytes?

The data is exclusively OR'ed (XOR'ed) in bytes and in order.

For example, putting a character string into hexadecimal gives 31h, 32h, 33h, 34h.

Character	OR'ed (XOR'ed) in bytes	Results
XOR of 0x31 and 0x32	0011 0001 ^= 0011 0010	0000 0011 (0x03)
XOR of 0x03 and 0x33	0000 0011 ^= 0011 0011	0011 0000 (0x30)
XOR of 0x30 and 0x34	0011 0000 ^= 0011 0100	0000 0100 (0x04) Therefore, the parity is 0x04.

Note

If this parity value is incorrect, the correct QR Code is not generated.

Summary

Printing the character string “123456789” with a cell size of 4 dots, Model 2, standard error correction level, and automatic data input

Without Structured Append	ESC i Q 0x04h 0x02h 0x00h 0x00h 0x00h 0x00h 0x02h 0x00h “123456789” \\\
With Structured Append [Three partitions]	ESC i Q 0x04 0x02 0x01 0x01 0x03 0x31 0x02 0x00 “123” \\ ESC i Q 0x04 0x02 0x01 0x02 0x03 0x31 0x02 0x00 “456” \\ ESC i Q 0x04 0x02 0x01 0x03 0x03 0x31 0x02 0x00 “789” \\ (The parity for the character string “123456789” is “0x31”.)

(2) [Barcode data]: Barcode data

When manual input is selected in 8 (data input method), the barcode data must be preceded with one of the following single-byte alphanumeric characters.

Barcode Type	Preceded Character	Example
Number input	N or n	-
Alphanumeric character input	A or a	ESC i Q [other parameters] 1 A012345678aBcDe \\\
Kanji character input	K or k	ESC i Q [other parameters] 1 K kanji character input \\\
Binary character input	B or b+4-digit number	ESC i Q [other parameters] 1 B0005##### \\ With the “4-digit number”, specify the number of binary characters to actually be entered. For example, if 12 binary characters are to be entered, specify: B 0012 (0x30, 0x30, 0x31, 0x32)

The number of barcode data characters that can be entered depends on the model type and the input method.

Model 1	707 English alphanumeric characters, 1167 numbers, 486 binary bytes, 299 kanji characters
Model 2	4296 English alphanumeric characters, 7089 numbers, 2953 binary bytes, 1817 kanji characters
Micro QR	21 English alphanumeric characters, 35 numbers, 15 binary bytes, 9 kanji characters

Note

The numbers listed above are for an error correction level at a high-density level (L 7%).

If the standard level or higher is set, the number of characters that can be entered may decrease. In addition, even if the characters are entered with the high-density level (L) specified, the number of characters that can be entered may decrease due to compression.

(3) \\\: End of barcode

There must be three backslashes to end 2D barcode.

Example

Refer to the section "[Summary](#)".

ESC i P Specify QR Code version

ASCII:	ESC	i	P	n
Decimal:	27	105	80	n
Hexadecimal:	1B	69	50	n

Parameters

$0 \leq n \leq 40$

Description

- The barcode size can be fixed.
- The default value is "0".
- The available versions differ depending on the symbol type used.
If a setting other than those listed is specified, the setting returns to its default.

The following settings are available for each symbol type.

MODEL1 (0 to 14), MODEL2 (0 to 40), Micro QR (0 to 4)

ESC i V 2D barcode (PDF417)

ASCII:	ESC	i	V or v	data		
Decimal:	27	105	86 or 118	data		
Hexadecimal:	1B	69	56 or 76	data		
Format:	ESC	i	V or v	[Parameters]	[Barcode data]	
				(1)	(2)	(3)

Parameters**(1) [Parameters]**

Unlike with 1D barcodes, all parameters must be specified in order, starting from the top.

If a value other than those listed is entered for a parameter, that parameter is specified with its default value.

1. Cell size	[1-byte decimal] 4 [1-byte decimal] 6 [1-byte decimal] 8 [1-byte decimal] 10 [1-byte decimal] 12	Specifies the dot size per cell side. Prints 4 dots per cell side. (default value) Prints 6 dots per cell side. Prints 8 dots per cell side. Prints 10 dots per cell side. Prints 12 dots per cell side.
2. Symbol type	[1-byte decimal] 0 [1-byte decimal] 1 [1-byte decimal] 2 [1-byte decimal] 3	Standard (default value) Truncated Micro PDF417 standard Micro PDF417 CODE128 emulation
3. Data input method	[1-byte decimal] 0 [1-byte decimal] 1	Auto input (default value) Binary input
4. Error correction capacity-type	[1-byte decimal] 0 [1-byte decimal] 1	Level input (default value) Percentage input
5. Error correction capacity-value		
- Level input	[2-byte decimal] 0–8	Level input (default value of 0)
- Percentage input	[2-byte decimal] 0–400	Percentage input (default value of 0)
6. Symbol size (X direction)	[1-byte decimal] 0 [1-byte decimal] 1–30	Auto setting (default value) Manual settings
* 0 and 1–4 with MicroPDF417		
7. Symbol size (Y direction)	[1-byte decimal] 0 [1-byte decimal] 3–90	Auto setting (default value) Manual settings
* 0 and 4–44 with MicroPDF417		

8. Aspect value	[2-byte decimal] 1–1000	Enter the aspect value. Actually, this is between 0.01 and 10.0. However, since a decimal point cannot be entered, a value multiplied by 100 is entered. The default is “50”. (The actual value is 0.5.)
-----------------	-------------------------	--

Note

- * The aspect value setting is ignored if the symbol size in the X direction or the symbol size in the Y direction is entered manually.
- * Depending on the conditions, the bar code may not be generated or a bar code that cannot be scanned may be generated if the symbol size in the X direction or the symbol size in the Y direction is entered manually.
- * When a large cell size is specified together with a high error correction capacity, printing may not be possible because the print buffer has become full.

[With symbol type MicroPDF417]

- * Since the error correction capacity is automatically determined from the symbol size in the X direction, the settings for “Error correction capacity–type” and “Error correction capacity–value” are ignored.
- * The aspect value setting is ignored.
- * The following table shows the values available for the symbol size (Y direction) according to the symbol size (X direction) setting. If an invalid setting is specified for the symbol size (Y direction), the default setting is specified.

Symbol Size (X Direction)	Symbol Size (Y Direction)												
AUTO	AUTO												
1	AUTO	11	14	17	20	24	28						
2	AUTO	8	11	14	17	20	23	26					
3	AUTO	6	8	10	12	15	20	26	32	38	44		
4	AUTO	4	6	8	10	12	15	20	26	32	38	44	

(2) [Barcode data]: Barcode data

The numbers of barcode data characters that can be entered are as follows.

1850 alphanumeric characters, 2710 numbers, 1108 binary bytes

Note

The numbers listed above are for an error correction level at a high-density level (L 7%). If the standard level or higher is set, the number of characters that can be entered may decrease. In addition, even if the characters are entered with the high-density level (L) specified, the number of characters that can be entered may decrease due to compression.

[With symbol type MicroPDF417]

Maximum of 250 alphanumeric characters, maximum of 366 numbers, maximum of 150 bytes of binary data

However, the following table shows the maximum amount of information allowed according to the settings for symbol size (X direction) and symbol size (Y direction).

X	Y	Maximum Amount of Information Allowed		
		Alphanumeric Characters	Numbers	Binary
1	11	6	8	3
1	14	12	17	7
1	17	18	26	10
1	20	22	32	13
1	24	30	44	18
1	28	38	55	22
2	8	14	20	8
2	11	24	35	14
2	14	36	52	21
2	17	46	67	27
2	20	56	82	33
2	23	64	93	38
2	26	72	105	43
3	6	10	14	6
3	8	18	26	10
3	10	26	38	15
3	12	34	49	20
3	15	46	67	27
3	20	66	96	39
3	26	90	132	54
3	32	114	167	68
3	38	138	202	82
3	44	162	237	97
4	4	14	20	8
4	6	22	32	13
4	8	34	49	20
4	10	46	67	27
4	12	58	85	34
4	15	76	111	45
4	20	106	155	63
4	26	142	208	85
4	32	178	261	106
4	38	214	313	128
4	44	250	366	150

(3) \\\: End of barcode

There must be three backslashes to end 2D barcodes.

ESC i D 2D barcode (DataMatrix)

ASCII:	ESC	i	D or d	data
Decimal::	27	105	68 or 100	data
Hexadecimal:	1B	69	44 or 64	data
Format:	ESC	i	D or d	<u>[Parameters]</u> <u>[Barcode data]</u> <u>\\</u>
				(1) (2) (3)

Parameters**(1) [Parameters]**

Unlike with 1D barcodes, all parameters must be specified in order, starting from the top.

If a value other than those listed is entered for a parameter, that parameter is specified with its default value.

1. Cell size	[1-byte decimal] 4 [1-byte decimal] 6 [1-byte decimal] 8 [1-byte decimal] 10 [1-byte decimal] 12	Specifies the dot size per cell side. Prints 4 dots per cell side. (default value) Prints 6 dots per cell side. Prints 8 dots per cell side. Prints 10 dots per cell side. Prints 12 dots per cell side.
2. Symbol type	[1-byte decimal] 0 [1-byte decimal] 1	ECC200 square (default value) ECC200 rectangular
3. Vertical size	[1-byte decimal] 0 [1-byte decimal] 10 [1-byte decimal] 12 [1-byte decimal] 14 [1-byte decimal] 16 [1-byte decimal] 18 [1-byte decimal] 20 [1-byte decimal] 22 [1-byte decimal] 24 [1-byte decimal] 26 [1-byte decimal] 32 [1-byte decimal] 36 [1-byte decimal] 40 [1-byte decimal] 44 [1-byte decimal] 48 [1-byte decimal] 52 [1-byte decimal] 64 [1-byte decimal] 72 [1-byte decimal] 80 [1-byte decimal] 88 [1-byte decimal] 96 (continued to the next page)	[ECC200 square] Vertical no. of cells: AUTO (default value) Vertical no. of cells: 10 cells Vertical no. of cells: 12 cells Vertical no. of cells: 14 cells Vertical no. of cells: 16 cells Vertical no. of cells: 18 cells Vertical no. of cells: 20 cells Vertical no. of cells: 22 cells Vertical no. of cells: 24 cells Vertical no. of cells: 26 cells Vertical no. of cells: 32 cells Vertical no. of cells: 36 cells Vertical no. of cells: 40 cells Vertical no. of cells: 44 cells Vertical no. of cells: 48 cells Vertical no. of cells: 52 cells Vertical no. of cells: 64 cells Vertical no. of cells: 72 cells Vertical no. of cells: 80 cells Vertical no. of cells: 88 cells Vertical no. of cells: 96 cells

3. Vertical size (continued)	(continued from the previous page)	
	[1-byte decimal] 104 [1-byte decimal] 120 [1-byte decimal] 132 [1-byte decimal] 144	Vertical no. of cells: 104 cells Vertical no. of cells: 120 cells Vertical no. of cells: 132 cells Vertical no. of cells: 144 cells
4. Horizontal size	[1-byte decimal] 0 [1-byte decimal] 8 [1-byte decimal] 12 [1-byte decimal] 16	[ECC200 rectangular] Vertical no. of cells: AUTO (default value) Vertical no. of cells: 8 cells Vertical no. of cells: 12 cells Vertical no. of cells: 16 cells
	[1-byte decimal] x	[ECC200 square] Horizontal no. of cells: Same value as vertical size (x)
	[1-byte decimal] 0	[ECC200 rectangular] (1) When the vertical size is AUTO Horizontal no. of cells: AUTO (default value)
	[1-byte decimal] 18 [1-byte decimal] 32	(2) When the vertical size is 8 cells Horizontal no. of cells: 18 cells Horizontal no. of cells: 32 cells
	[1-byte decimal] 26 [1-byte decimal] 36	(3) When the vertical size is 12 cells Horizontal no. of cells: 26 cells Horizontal no. of cells: 36 cells
[1-byte decimal] 36 [1-byte decimal] 48	(4) When the vertical size is 16 cells Horizontal no. of cells: 36 cells Horizontal no. of cells: 48 cells	
5. Reserved	[1-byte decimal]×5 0	5 bytes of dummy data (0) is sent.

Note

* If the vertical size is set to a value other than those listed for ECC200 square, the “AUTO” setting is selected. If the horizontal size is set to a value different from the vertical size, the setting is changed to the same value as the horizontal size.

* If the vertical or horizontal size for ECC200 rectangular is set to a value other than those listed, the “AUTO” setting is selected.

(2) [Barcode data]: Barcode data

The maximum number of barcode data characters that can be entered is listed below.

2335 alphanumeric characters, 3116 numbers, 1556 bytes of binary data

Note

The numbers of characters that can be entered (as listed above) are for the maximum vertical × horizontal cell settings (144 cells × 144 cells). The number of characters that can be entered may decrease, depending on the specified settings.

(3) \\\: End of barcode

There must be three backslashes to end 2D barcodes.

Example

For data “12345” with symbol type ECC square at 40 × 40 with a 4-dot cell size, the command will be as shown below.

```
ESC i D 04h 00h 28h (40d) 28h 00h 00h 00h 00h “12345” \\\
```

ESC i M 2D barcode (MaxiCode)

ASCII:	ESC	i	M or m	data
Decimal:	27	105	77 or 109	data
Hexadecimal:	1B	69	4D or 6D	data
Format:	ESC	i	M or m	<u>[Parameters]</u> \ <u>[Barcode data]</u> <u> </u>
				(1) (2) (3) (4)

Parameters**(1) [Parameters]**

If a value other than those listed is entered for a parameter, that parameter is specified with its default value.

1. Symbol type	[1-byte decimal]	0	Standard (default value)
	[1-byte decimal]	1	Full EEC
	[1-byte decimal]	2	Structured carrier message
2. Structured Append setting	[1-byte decimal]	0	With Structured Append (default value)
	[1-byte decimal]	1	Without Structured Append

(2) \ (backslash)

Separator between parameters and bar code data

(3) [Barcode data]: Barcode data

The number of barcode data characters that can be entered is listed below.

Symbol Type	Maximum Amount of Information Allowed	
	Alphanumeric Characters	Numbers
Standard	93	138
Full EEC	77	113
Structured carrier message	84	126

Note

The numbers of characters that can be entered (as listed above) are for when using only the common character set (code set A in the MaxiCode specifications). The number of characters that can be entered may decrease, depending on the characters that are used.

When the symbol type is the structured carrier message, the service class, country code and postal code can be specified separately from the normal data. Specify each value, separated by a backslash and comma (\,), immediately before the normal data.

```
<postal_code>\,<country_code>\,<service_class>\,<normal_barcode_data>
```

When “\,” is not used three times, the data is written as shown in the following example.

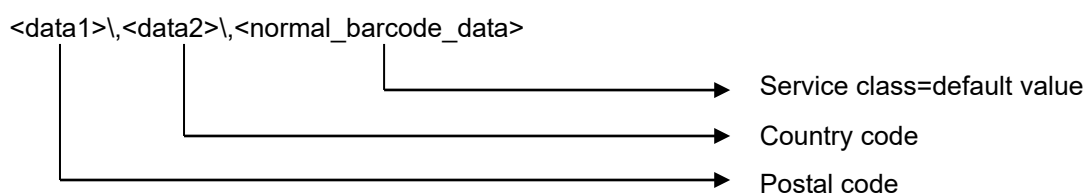

If a value other than those listed is entered for a parameter, that parameter is specified with its default value.

Postal code	9 or less numbers, or 6 or less alphanumeric characters	Ignored when not structured carrier message. Default value: 00000000
Country code	3 or less numbers	Ignored when not structured carrier message. Default value: 000
Service class	3 or less numbers	Ignored when not structured carrier message. Default value: 000

Note

If the postal code is specified as alphanumeric characters, characters other than those listed below are invalid.

A to Z “ # \$ % & ‘ () * + , - . / 0 to 9 :

However, lowercase letters (a to z) are converted to the valid uppercase letters (A to Z).

(4) \\\: End of barcode

There must be three backslashes to end 2D barcodes.

ESC i J 2D barcode (AztecCode)

ASCII:	ESC	i	J or j	data		
Decimal::	27	105	74 or 106	data		
Hexadecimal:	1B	69	4A or 6A	data		
Format:	ESC	i	J or j	<u>[Parameters]</u>	<u>[Barcode data]</u>	<u> </u>
				(1)	(2)	(3)

Parameters**(1) [Parameters]**

If a value other than those listed is entered for a parameter, that parameter is specified with its default value.

1. Cell size	[1-byte decimal]	4	Specifies the dot size per cell side. Prints 4 dots per cell side. (default value)
	[1-byte decimal]	6	Prints 6 dots per cell side.
	[1-byte decimal]	8	Prints 8 dots per cell side.
	[1-byte decimal]	10	Prints 10 dots per cell side.
	[1-byte decimal]	12	Prints 12 dots per cell side.
2. Symbol type	[1-byte decimal]	0	Full range (default value)
	[1-byte decimal]	1	Compact
	[1-byte decimal]	2	Auto setting
3. Error correction capacity	[1-byte decimal]	1–99	[Percentage (default value is 23)]
4. Symbol size	[Full range]		
	[1-byte decimal]	0	Auto setting (default value)
	[1-byte decimal]	4–32	Manual settings
	[Compact]		
	[1-byte decimal]	0	Auto setting (default value)
	[1-byte decimal]	1–4	Manual settings
Note: Symbol size is fixed as AUTO when Symbol type is specified as AUTO.			
5. Structured Append setting	[1-byte decimal]	0	Not partitioned. (default value)
	[1-byte decimal]	1	Partitioned
	[1-byte decimal]	2	Partitioned Specify the number of blocks
6. Number of blocks	[[1-byte decimal]	2–26	Partitioned Only valid when the number of blocks is specified (Default it 2)
7. Message ID	Character string	(Terminal value is 00h)	Invalid when append setting 0.

(2) [Barcode data]: Barcode data

The maximum number of barcode data characters that can be entered is listed below.

3067 alphanumeric characters, 3832 numbers, 1914 bytes of binary data

Note

The number of characters shown above is only for the Full-Range mode and varies depending on setting.

(3) \\\: End of barcode

There must be three backslashes to end 2D barcodes.

ESC i F Print transferred data

ASCII:	ESC	i	F	P	n
Decimal:	27	105	70	80	n
Hexadecimal:	1B	69	46	50	n

Parameters

n: File header index
0 ≤ n ≤ 98

Description

- Expands transferred data as image data in the print buffer.
- Expands transferred image data from the print position.
- Ignored if there is no image data.

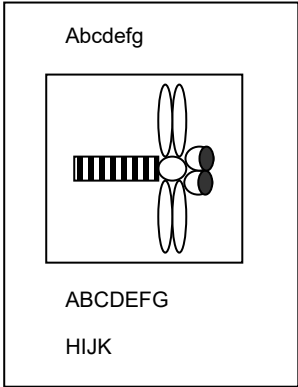
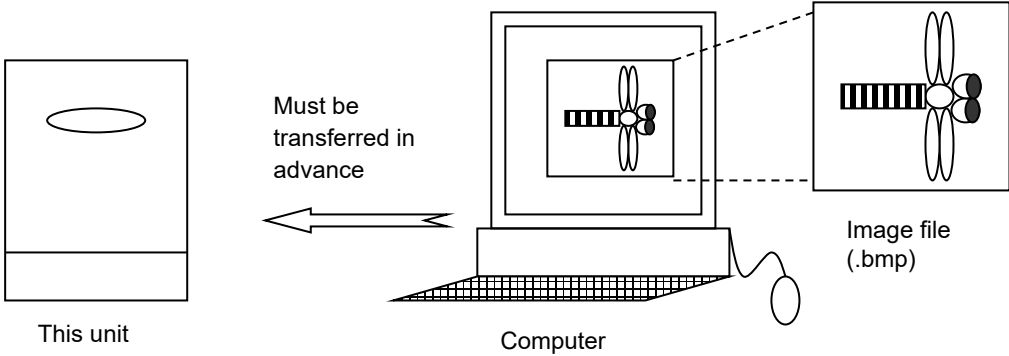

Example: Combination of text and transferred image

- As with text, if the image data does not all fit in the current line, an error occurs.

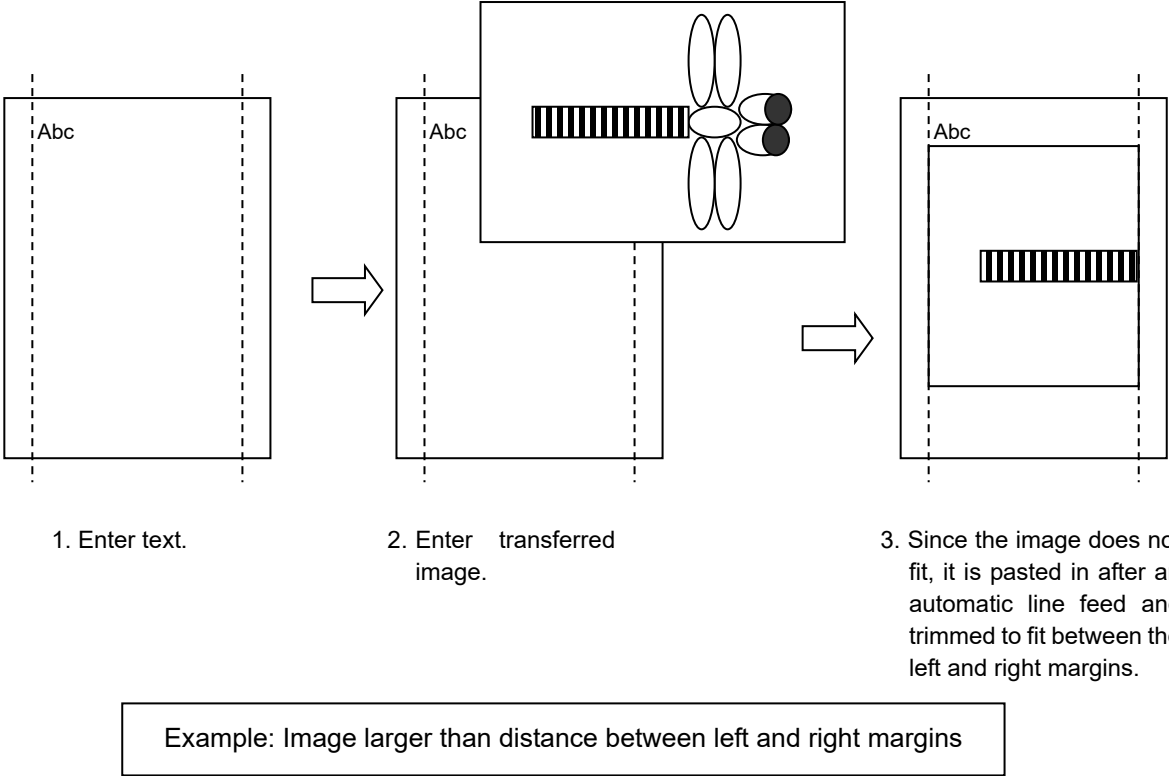
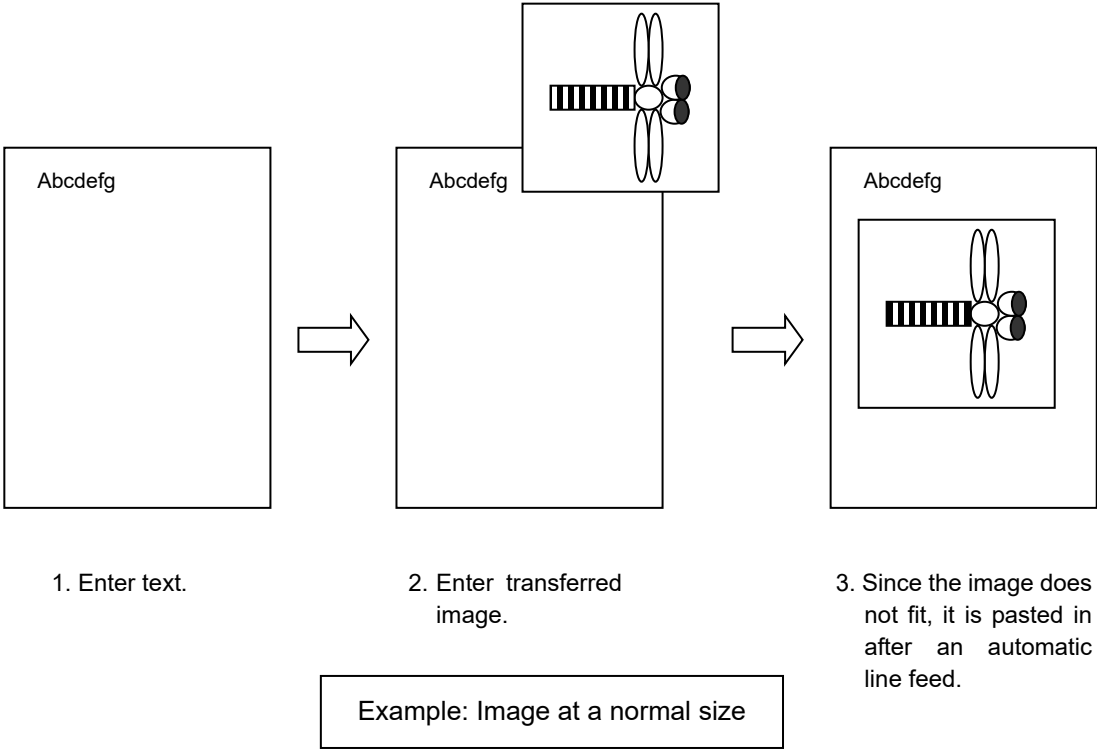

- If the result of pasting the transferred image exceeds the bottom margin position, the image is pasted in after a page feed. However, if the transferred image is larger than the entire area between the top and bottom margins, the entire image is ignored.

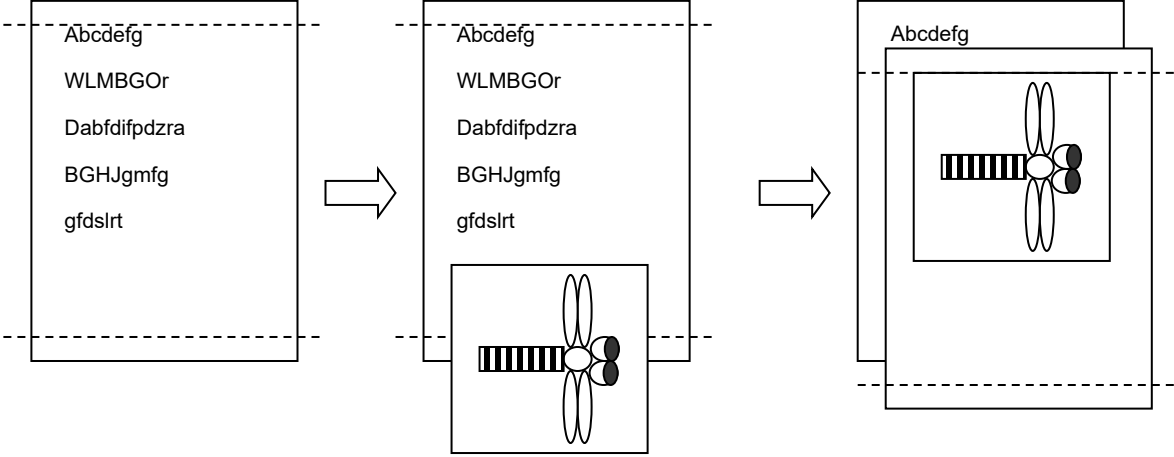

1. Enter text.

2. Enter transferred image.

3. Since the image does not fit, it is pasted in after an automatic page feed.

Example: Image smaller than distance between top and bottom margins

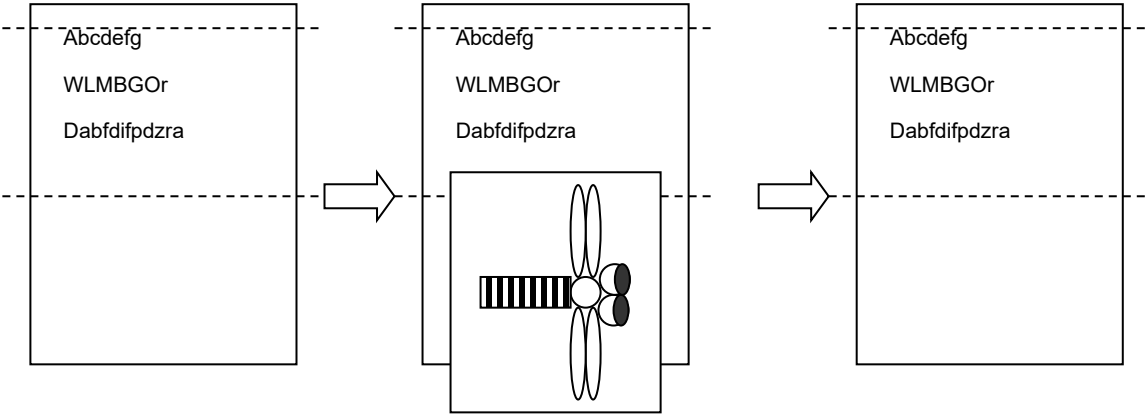

1. Enter text.

2. Enter transferred image.

3. The entire image is ignored.

Example: Image larger than distance between top and bottom margins

- There are limits on the amount of image data that can be stored on the main unit. The storage capacity is 7MB. However, bitmap data is not stored as is, but is converted into the printer storage format by Transfer Manager.
- Image data larger than the media size is handled by deleting the portion of the image that does not fit within the media. Even with the same image data, the portion that would be deleted differs depending on the media orientation at the time.

ESC i a Switch command mode

ASCII:	ESC	i	a	n
Decimal:	27	105	97	n
Hexadecimal:	1B	69	61	n

Parameters

n: Command mode
0=ESC/P
1=Raster graphics
3=P-touch Template

Description

- Sets the command mode to ESC/P, PTCBP (raster graphics) or P-touch Template.
- Dynamically switches between the three modes.

ESC i S Request printer status

ASCII:	ESC	i	S
Decimal:	27	105	83
Hexadecimal:	1B	69	53

Parameters

None

Description

- Requests the printer status.

The printer status consists of 32 bytes.

Number	Offset	Size	Name	Value/Reference
1	0	1	Print head mark	Fixed at 80h
2	1	1	Size	Fixed at 20h
3	2	1	Brother code	Fixed at "B" (42h)
4	3	1	Series code	Fixed at "0" (30h)
5	4	1	Model code	"o" (6Fh) : P900W "p" (70h) : P950NW "q" (71h) : P900
6	5	1	Country code	Fixed at "0" (30h)
7	6	1	Battery level information	Refer to table (11) below.
8	7	1	Extended error	Refer to table (10) below.
9	8	1	Error information 1	Refer to table (1) below.
10	9	1	Error information 2	Refer to table (2) below.
11	10	1	Media width	Refer to table (3) below.
12	11	1	Media type	Refer to table (4) below.
13	12	1	Number of colors	Fixed at 00h
14	13	1	Internal font information	Fixed at 00h
15	14	1	Internal Japanese font information	Fixed at 00h
16	15	1	Mode	Fixed at 00h
17	16	1	Density	Fixed at 00h
18	17	1	Media length	Refer to table (3) below.
19	18	1	Status type	Refer to table (5) below.
20	19	1	Phase type	Refer to table (6) below.
21	20	1	Phase number (higher order bytes)	Fixed at 00h
22	21	1	Phase number (lower order bytes)	Fixed at 00h
23	22	1	Notification number	Refer to table (7) below.
24	23	1	Expansion area (number of bytes)	Fixed at 00h

Number	Offset	Size	Name	Value/Reference
25	24	1	Media color information	Refer to table (8) below.
26	25	1	Ribbon color information	Refer to table (9) below.
27	26	6	Not used	Fixed at 00h

(1) Error information 1

Flag	Mask	Definition
Bit 0	01h	Not used
Bit 1	02h	Not used
Bit 2	04h	“Cutter jam” error
Bit 3	08h	Low battery
Bit 4	10h	Not used
Bit 5	20h	Not used
Bit 6	40h	Not used
Bit 7	80h	Not used

(2) Error information 2

Flag	Mask	Definition
Bit 0	01h	Not used
Bit 1	02h	Not used
Bit 2	04h	Not used
Bit 3	08h	Not used
Bit 4	10h	“Cover open” error
Bit 5	20h	High temperature error
Bit 6	40h	Feed error
Bit 7	80h	System error

(3) Media width, Media length

Media type	Media width	Media length
No tape	00h	00h
3.5-mm-wide tape	04h	00h
6-mm-wide tape	06h	00h
9-mm-wide tape	09h	00h
12-mm-wide tape	0Ch	00h
18-mm-wide tape	12h	00h
24-mm-wide tape	18h	00h
36-mm-wide tape	24h	00h
HS 5.8-mm-wide tape	06h	00h
HS 8.8-mm-wide tape	09h	00h
HS 11.7-mm-wide tape	0Ch	00h
HS 17.7-mm-wide tape	12h	00h
HS 23.6-mm-wide tape	18h	00h
HSE 5.2-mm-wide tape	05h	00h
HSE 9.0-mm-wide tape	09h	00h
HSE 11.2-mm-wide tape	0Bh	00h
HSE 21.0-mm-wide tape	15h	00h
HSE 31.0-mm-wide tape	1Fh	00h
FLe 21mm x 45mm-wide tape	15h	2Dh

(4) Media type

Media type	Value
No tape	00h
Laminated tape	01h
Non-laminated tape	03h
Fabric tape	04h
Heat-shrink Tube	11h
FLe tape	13h
Flexible ID tape	14h
Satin tape	15h
Heat-shrink Tube E	17h
Incompatible tape	FFh

(5) Status type

Status type	Value
Reply to status request	00h
Not use	01h
Error occurred	02h
Not use	03 h
Not use	04h
Notification	05h
Phase change	06h
(Not used)	07h to 20h
Usage prohibited	21h to FFh

(6) Phase type, number

Phase type	Value
(Reception possible) Edit	00h
Printing	01h

Edit

Phase	number (Dec)	higher order bytes	lower order bytes
(Reception possible)Edit	0	00h	00h
Feed	1	00h	01h

Printing

Phase	number (Dec)	higher order bytes	lower order bytes
Printing	0	00h	00h
Not use	10	00h	0Ah
Cover opened while receiving data	20	00h	14h
Not use	25	00h	19h

(7) Notification number

Notification	Value
(No notification)	00h
Cover open	01h
Cover close	02h
Cooling started	03h
Cooling finished	04h

(8) Media color information

Media color	Media color ID	Remarks
White	01h	
Other	02h	
Clear	03h	
Red	04h	
Blue	05h	
Yellow	06h	
Green	07h	
Black	08h	
Clear	09h	
Matte White	20h	
Matte Clear	21h	
Matte Silver	22h	
Satin Gold	23h	
Satin Silver	24h	
Blue	30h	TZe-535(12mm) TZe-545(18mm) TZe-555(24mm)
Red	31h	TZe-435(12mm)
Fluorescent Orange	40h	
Fluorescent Yellow	41h	
Berry Pink	50h	TZe-MQP35
Light Gray	51h	TZe-MQL35
Lime Green	52h	TZe-MQG35
Yellow	60h	
Pink	61h	
Blue	62h	
Heat-shrink Tube	70h	
Heat-shrink Tube E	71h	

Media color	Media color ID	Remarks
White(Flex. ID)	90h	
Yellow(Flex. ID)	91h	
Clearning	F0h	
Stencil	F1h	
Incompatible	FFh	

(9) Ribbon color information

Ribbon color	Ribbon color ID
White	01h
Red	04h
Blue	05h
Black	08h
Gold	0Ah
Blue	62h
Clearning	F0h
Stencil	F1h
Other	02h
Incompatible	FFh

(10) Extended error information

Error information	Value
High resolution/High- speed printing error	1Dh
Power switching error	1Eh
Battery error	1Fh
Incompatible media error	21h

(11) Battery level information

Battery level	Value
Full battery	00h
Half battery	01h
Low battery	02h
Changing required	03h
AC adapter in use	04h
Undetectable	FFh

ESC i L Apply/cancel rotated printing

ASCII:	ESC	i	L	n
Decimal:	27	105	76	n
Hexadecimal:	1B	69	4C	n

Parameters

n=0 and 1 or 48 and 49

Description

- Applies rotated printing to the text.
 - n=0 (or 30h): Rotated printing is cancelled.
 - n=1 (or 31h): Rotated printing is applied.

ESC i C Specify cut setting

ASCII:	ESC	i	C	n
Decimal:	27	105	67	n
Hexadecimal:	1B	69	43	n

Parameters
 $0 \leq n \leq 255$
Description

- Specifies full cut, half cut, chain printing or special tape.
- The n parameter (1 byte) specifies all settings in bit units, as shown below.

7	6	5	4	3	2	1	0
---	---	---	---	---	---	---	---

0:	Full cut
1:	Half cut
2:	Chain printing
3:	Special tape
4:	Not used
5:	Not used
6:	Not used
7:	Not used

- If bit 0 of parameter n is "1", full cut is specified. If it is "0", full cut is cancelled.
- If bit 1 of parameter n is "1", half cut is specified. If it is "0", half cut is cancelled.
- If bit 2 of parameter n is "1", chain printing is applied. If it is "0", chain printing is cancelled.
- If bit 3 of parameter n is "1", special tape is specified. If it is "0", special tape is cancelled.

When special tape is specified, full cut, half cut and chain printing are not available (same as being cancelled).

ESC i UB Specify baud rate

ASCII:	ESC	i	U	B	n
Decimal:	27	105	85	66	n
Hexadecimal:	1B	69	55	42	n

Parameters

$0 \leq n \leq 12$

Description

- As an RS-232C communication setting, the baud rate is specified as listed below.

n=0:	300 bps
n=1:	600 bps
n=2:	1200 bps
n=3:	2400 bps
n=4:	4800 bps
n=5:	9600 bps
n=6:	14400 bps
n=7:	19200 bps
n=8:	28800 bps
n=9:	31250 bps
n=10:	38400 bps
n=11:	57600 bps
n=12:	115200 bps

- The setting is applied the next time that the machine is turned on.

ESC i Ub Specify bit length

ASCII:	ESC	i	U	b	n
Decimal:	27	105	85	98	n
Hexadecimal:	1B	69	55	62	n

Parameters
 $0 \leq n \leq 1$
Description

- As an RS-232C communication setting, the bit length is specified as listed below.

n=0: 7 bit

n=1: 8 bit

- The setting is applied the next time that the machine is turned on.

ESC i UP Specify parity setting

ASCII:	ESC	i	U	P	n
Decimal:	27	105	85	80	n
Hexadecimal:	1B	69	55	50	n

Parameters
 $0 \leq n \leq 2$
Description

- As an RS-232C communication setting, the parity is specified as listed below.

n=0: None

n=1: ODD

n=2: EVEN

- The setting is applied the next time that the machine is turned on.

ESC i UC Specify busy control

ASCII:	ESC	i	U	C	n
Decimal:	27	105	85	67	n
Hexadecimal:	1B	69	55	43	n

Parameters
 $0 \leq n \leq 1$
Description

- As an RS-232C communication setting, the busy control is specified as listed below.
 - n=0: Hardware (DTR)
 - n=1: X-ON/X-OFF
- The setting is applied the next time that the machine is turned on.

5.10 Advanced static commands

ESC iXE2 Specify barcode margin setting

ASCII:	ESC	i	X	E	2	n1	n2	n3
Decimal:	27	105	88	69	50	n1	n2	n3
Hexadecimal:	1B	69	58	45	32	n1	n2	n3

Parameters

n1: 01h (Fixed)

n2: 00h (Fixed)

00h≤n3≤01h

Description

- Select an existence of barcode margin.
 - n3=00h: No margin
 - n3=01h: Add margin (*Manufacturer's default)
- This command is a static command.

Remarks

- Invalid if n3 is a value outside of the allowable range

ESC iXE1 Retrieve barcode margin setting

ASCII:	ESC	i	X	E	1	n1	n2
Decimal:	27	105	88	69	49	n1	n2
Hexadecimal:	1B	69	58	45	31	n1	n2

Parameters

n1: 00h (Fixed)

n2: 00h (Fixed)

Description

- Return a barcode margin setting as 3 Bytes data.

[1]	01h (Fixed)
[2]	00h (Fixed)
[3]	Setting 00h: No margin 01h: Add margin

- The retrieved value is a value specified by a static command.

Appendix A: Specifications

BROTHER PT-P900W/P950NW ESC/P specifications

Printing	Printing method	Raster printing (PCBP mode) ESC/P printing <u>P-touch Template printing</u>	
	Maximum print length	1 meter	
	Resolution (dpi)	360 dpi × 360 dpi	
	Text	Font	Bitmap fonts: Helsinki, Letter Gothic
		Size (dots)	Bitmap fonts: 21 × 21, 28 × 28, 44 × 44, 56 × 56, 88 × 88, 120 × 120 (dots)
		Character style	<u>None</u> , Bold, Italics
		Underline	<u>Off</u> , On
		Character width	Half-width, <u>Normal</u> , Double-width
		Horizontal alignment	<u>Left</u> , Center, Right, Justify
	Rotate	<u>Vertical</u> , Horizontal	
Bar-code	Protocols	<u>CODE39</u> , ITF (I-2/5), EAN-13, EAN-8, UPC-A, UPC-E, CODABAR, CODE128, GS1-128 (UCC/EAN-128), QR Code (Model 1, Model 2, micro QR), PDF417 (Standard, Truncate, Micro PDF417), DataMatrix (ECC200 Square, ECC200 Rectangular), MaxiCode, RSS-14 (Standard, Truncated, Stacked, Stacked Omni), RSS-Limited, RSS Expanded (Standard, Stacked)	
	Width	Large, Medium, <u>Small</u>	
Transmission	RS	Baud rate (bps)	115.2K, 57.6K, 38.4K, 31.25K, 28.8K, 19.2K, 14.4K, <u>9600</u> , 4800, 2400, 1200, 600, 300
		Busy	<u>DTR</u> , Xon/Xoff
		Bit length	<u>8</u> , 7
		Parity	<u>NONE</u> , ODD, EVEN
		Stop bit	1 bit

Settings that appear in **bold** and underlined are the default settings.

Appendix B: Character Code Tables

Character code tables

(1) Windows1252 (Western Europe)

	0	1	2	3	4	5	6	7	8	9	A	B	C	D	E	F
0			SP	0	@	P	·	p	€			°	À	Ð	à	ð
1			!	1	A	Q	a	q	~	'	i	±	Á	Ñ	á	ñ
2			"	2	B	R	b	r	,	'	ç	²	Â	Ò	â	ò
3			#	3	C	S	c	s	f	“	£	³	Ã	Ó	ã	ó
4			\$	4	D	T	d	t	„	”	¤	'	Ä	Ô	ä	ô
5			%	5	E	U	e	u	...	•	¥	µ	Å	Õ	å	õ
6			&	6	F	V	f	v	†	–		¶	Æ	Ö	æ	ö
7			'	7	G	W	g	w	‡	—	§	·	Ç	×	ç	÷
8			(8	H	X	h	x	^	~	¨	¸	È	Ø	è	ø
9)	9	I	Y	i	y	‰	™	©	¹	É	Ù	é	ù
A			*	:	J	Z	j	z	Š	š	ª	º	Ê	Ú	ê	ú
B			+	;	K	[k	{	<	>	«	»	Ë	Û	ë	û
C			,	<	L	\	l		Œ	œ	¬	¼	Ì	Ü	ì	ü
D			-	=	M]	m	}			-	½	Í	Ý	í	ý
E			.	>	N	^	n	~	Ž	ž	®	¾	Î	Þ	î	þ
F			/	?	0	_	o	DEL		ÿ	¯	¿	Ï	ß	ï	ÿ

Note

* " ■ " indicates that a space is printed.

* " ■ " indicates that the character will change if the international character set is switched.

(2) Windows1250 (Eastern Europe)

	0	1	2	3	4	5	6	7	8	9	A	B	C	D	E	F
0			SP	0	@	P	·	p	€	ť	■	°	Ř	Đ	ř	ď
1			!	1	A	Q	a	q	À	‘	ˇ	±	Á	Ń	á	ń
2			"	2	B	R	b	r	,	’	ˇ	˘	Â	Ň	â	ň
3			#	3	C	S	c	s	Ł	“	ł	ł	Ă	Ó	ă	ó
4			\$	4	D	T	d	t	„	”	¤	’	Ä	Ô	ä	ô
5			%	5	E	U	e	u	...	•	Ą	μ	Í	Ö	í	ö
6			&	6	F	V	f	v	†	–		¶	Ć	Ö	ć	ö
7			'	7	G	W	g	w	‡	—	§	·	Ç	×	ç	÷
8			(8	H	X	h	x	ł	■	¨	˘	Č	Ř	č	ř
9)	9	I	Y	i	y	‰	™	©	ą	É	Û	é	û
A			*	:	J	Z	j	z	Š	š	Ş	ş	Ę	Ú	ę	ú
B			+	;	K	[k	{	<	>	«	»	Ě	Ů	ě	ů
C			,	<	L	\	l		Ś	ś	¬	Ł	Ě	Ü	ę	ü
D			-	=	M]	m	}	ř	ť	–	“	Í	Ý	í	ý
E			.	>	N	^	n	~	Ž	ž	®	ł	Î	Ť	î	ť
F			/	?	O	_	o	DEL	Ž	ż	Ż	ż	Ď	ß	ď	·

Note

* " ■ " indicates that a space is printed.

* " ■ " indicates that the character will switch when the international character set is changed.

(3) Brother standard

	0	1	2	3	4	5	6	7	8	9	A	B	C	D	E	F
0			SP	0	@	P	·	p	Ç	É	á	☼	L		α	
1			!	1	A	Q	a	q	ü	æ	í	☼	⊥		β	±
2			"	2	B	R	b	r	é	Æ	ó	☼	⊥			
3			#	3	C	S	c	s	â	ô	ú		⊥			¾
4			\$	4	D	T	d	t	ä	ö	ñ	⊥	—			
5			%	5	E	U	e	u	à	ò	Ñ		⊥			§
6			&	6	F	V	f	v	å	û	ˆ				μ	÷
7			'	7	G	W	g	w	ç	ù	ˆ					
8			(8	H	X	h	x	ê	ÿ	¿	©	ℒ			°
9)	9	I	Y	i	y	ë	Ö	®	⊥	⊥	⊥		.
A			*	:	J	Z	j	z	è	Ü	€		⊥	⊥	Ω	
B			+	;	K	[k	{	ï	ø	½	⊥	⊥	✓	δ	
C			,	<	L	\	l		î	£	¼	⊥	⊥	☑		³
D			-	=	M]	m	}	ì	¥	ì	TEL	=		ø	²
E			.	>	N	^	n	~	Ä	Pts	«	FAX	⊥			
F			/	?	0	_	o	DEL	Å	f	»	⊥		□		

Note

* " ■ " indicates that a space is printed.

* " ■ " indicates that the character will change if the international character set is switched.

International character set table

Corresponding characters that switch in each language when the international character set is changed

n		23	24	40	5B	5C	5D	5E	60	7B	7C	7D	7E
0	United States	#	\$	@	[\]	^	`	{		}	~
1	France	#	\$	à	°	ç	§	^	`	é	ù	è	¨
2	Germany	#	\$	§	Ä	Ö	Ü	^	`	ä	ö	ü	ß
3	Britain	£	\$	@	[\]	^	`	{		}	~
4	Denmark I	#	\$	@	Æ	Ø	Å	^	`	æ	ø	å	~
5	Sweden	#	¤	É	Ä	Ö	Å	Ü	é	ä	ö	å	ü
6	Italy	#	\$	@	°	\	é	^	ù	à	ò	è	ì
7	Spain I	Pt	\$	@	ı	Ñ	ı	^	`	¨	ñ	}	~
8	Japan	#	\$	@	[¥]	^	`	{		}	~
9	Norway	#	¤	É	Æ	Ø	Å	Ü	é	æ	ø	å	ü
10	Denmark II	#	\$	É	Æ	Ø	Å	Ü	é	æ	ø	å	ü
11	Spain II	#	\$	á	ı	Ñ	ı	é	`	í	ñ	ó	ú
12	Latin America	#	\$	á	ı	Ñ	ı	é	ü	í	ñ	ó	ú
13	Korea	#	\$	@	[₩]	^	`	{		}	~
64	Legal	#	\$	§	°	'	"	¶	`	©	®	†	™

Appendix C: Introducing the Brother Developer Center

Useful information for developers, such as applications, tools, SDKs as well as FAQs, are provided in the Brother Developer Center.

<https://www.brother.com/product/dev/index.htm>

brother