

brother

TZe
TAPE

FLe
LABEL

HSe
TUBE

Product Safety Guide

P900W/P950NW

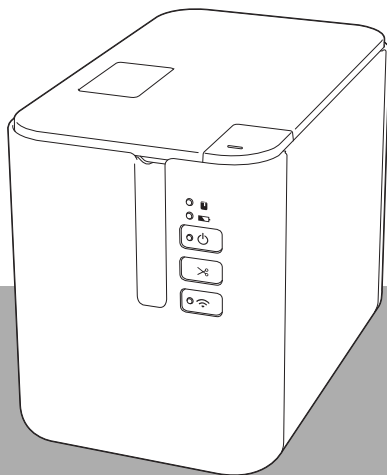

CE
Europe only

Read the whole guide before using your product and keep it for later reference.

Introduction

Thank you for purchasing the P900W/P950NW (hereafter referred to as “the P-touch labelling machine”).

The documentation included with the P-touch labelling machine, including the *Product Safety Guide* (this guide) and the *Quick Setup Guide* (printed) contains operating precautions and basic instructions.

For more information, and for information about software and using the machine on a network, see the *User's Guide*, which can be found on the Brother support website.

The latest version of your machine documentation is available from the Brother support website at support.brother.com

Save all documentation for later reference.

Important Notice



- The available options and supplies may vary depending on the country.
- The contents of this document are subject to change without notice.
- The contents of this document may not be duplicated or reproduced, partially or in full, without permission.
- We assume no responsibility for damages arising from earthquakes, fire, other disasters, actions of third parties, the user's intentional or negligent operation, misuse or operation under other special conditions.
- We assume no responsibility for damage (such as losses, loss of business profits, lost profits, business disruptions or a lost means of communication) that may result from the use or inability to use of the machine.
- If the machine should be defective due to faulty manufacturing, we shall replace or repair it during the warranty period.
- We assume no responsibility for any damages that may result from incorrect operation of the machine caused by connecting incompatible equipment or using incompatible software.











To use the machine safely

If the machine malfunctions, immediately stop using it, and then contact your Brother dealer.

Symbols used in this document

The following symbols are used throughout this document:

 DANGER	Indicates an imminently hazardous situation which, if the product is handled without following the warnings and instructions, will result in death or serious injuries.
 WARNING	Indicates a potentially hazardous situation which, if the product is handled without following the warnings and instructions, could result in death or serious injuries.
 CAUTION	Indicates a potentially hazardous situation which, if not avoided, may result in minor or moderate injuries.
IMPORTANT	Indicates a potentially hazardous situation which, if not avoided, may result in damage to property or loss of product functionality.

	Indicates a risk of fire under certain circumstances
	Indicates a risk of electrical shock under certain circumstances
	Indicates an action that must not be performed
	Indicates a risk of combustion if fire is nearby
	Indicates a risk of injury if the indicated part of the machine is touched
	Indicates a risk of injury, such as an electrical shock, if the indicated part of the machine is disassembled
	Indicates a risk of electrical shock if the operation is performed with wet hands
	Indicates a risk of electrical shock if the machine is exposed to water
	Indicates an action that must be performed
	Indicates that the AC power cord must be disconnected from the electrical socket
	Indicates a risk of injury if the cutter is touched

Important safety instructions

DANGER

Rechargeable Li-ion battery (Optional)



Carefully observe the following precautions for the rechargeable Li-ion battery (hereafter referred to as “rechargeable battery”). If these precautions are not followed, overheating, leaking, or cracks in the battery may result in an electrical short, explosion, smoke, fire, electrical shock, injury to yourself or others, or damage to the product or other property.

- Use the rechargeable battery only for its intended purpose. The machine and rechargeable battery are designed to be used together exclusively. DO NOT insert the rechargeable battery into a different machine, or a different rechargeable battery into your machine, otherwise a fire or damage may occur.
- To charge the rechargeable battery, insert it into the machine, and then use the AC adapter designed specifically for this machine.
- DO NOT charge the rechargeable battery near a fire or in direct sunlight. This could activate the protection circuitry, which is designed to prevent danger from high heat. Activation of the protection circuitry could cause charging to stop, charging to occur with excessive current/voltage if the protection circuitry fails, or an abnormal chemical reaction within the battery.
- When charging the rechargeable battery, use only the battery charger designed specifically for your rechargeable battery.
- DO NOT allow wires or other metal objects to come into contact with the terminals of the rechargeable battery. DO NOT carry or store the rechargeable battery with metal objects, such as necklaces or hairpins. This could cause an electrical short, and metal objects such as wires, necklaces, or hairpins to overheat.
- DO NOT use or leave the rechargeable battery near fire, heaters, or other high-temperature (above 80 °C) locations.
- DO NOT allow the rechargeable battery to come into contact with or to be immersed in water.
- DO NOT use the rechargeable battery in corrosive environments, such as areas where salty air, salt water, acids, alkalis, corrosive gases, chemicals, or any corrosive liquid is present.
- DO NOT use the rechargeable battery if it is damaged or leaking.
- DO NOT directly solder any connections to the rechargeable battery. This could cause internal insulation to melt, gas to be emitted, or safety mechanisms to fail.
- DO NOT use the rechargeable battery with the polarity (+) (-) reversed. Check the orientation of the rechargeable battery before inserting it, and do not try to force the rechargeable battery into the machine. Charging the rechargeable battery with the polarity reversed could cause an abnormal chemical reaction within the rechargeable battery or abnormal current flow during discharge.
- DO NOT directly connect the rechargeable battery to a household electrical supply.

DANGER

Rechargeable Li-ion battery (Optional)



- A liquid (electrolyte) leaking from the machine or rechargeable battery may indicate that the rechargeable battery is damaged. If the rechargeable battery leaks, immediately stop using the machine, unplug the AC adapter, and isolate the machine by placing it in a bag.

DO NOT touch the electrolyte. If the electrolyte gets in the eyes, do not rub them. Immediately rinse the eyes liberally with tap water or other clean water and seek the advice of a medical professional. If left unattended, the electrolyte could cause eye damage. If the electrolyte comes into contact with your skin or clothing, immediately rinse them with water.

- DO NOT put the rechargeable battery, or a machine with the rechargeable battery installed, into a microwave oven or high-pressure container.
- DO NOT disassemble, modify, or attempt to repair the rechargeable battery.
- DO NOT dispose of the rechargeable battery in fire or intentionally overheat. This could cause the internal insulation to melt, gas to be emitted, or safety mechanisms to fail. Additionally, the electrolyte solution could catch fire.
- DO NOT puncture the rechargeable battery with any objects, subject it to severe shocks or throw it. Damage to the rechargeable battery's protection circuit could cause the rechargeable battery to be recharged at an abnormal current/voltage or cause an abnormal chemical reaction within the rechargeable battery.



- DO NOT leave a drained rechargeable battery in the machine for a long period of time. This could shorten the life of the rechargeable battery or lead to an electrical short.
- DO NOT incinerate the rechargeable battery or dispose of it with household waste.
- Continuous use of the printer at a high altitude may cause the battery to overheat. If this occurs, stop using the printer and wait until it has cooled down.



If the machine can only be used for a short period of time, even though the rechargeable battery is fully charged, the rechargeable battery may have reached the end of its service life. Replace the rechargeable battery with a new one. When removing and replacing the rechargeable battery, cover the terminals of the old rechargeable battery with tape to avoid creating a short in the battery.

WARNING

Machine







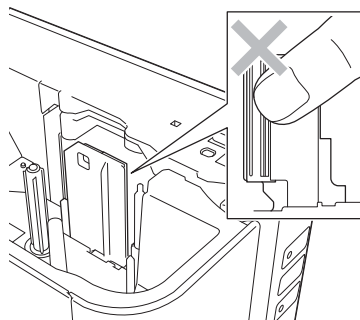









Follow these guidelines to avoid a fire, electrical shock, the risk of injury to yourself or others, and damage to the machine or other property.



DO NOT touch any metal parts near the print head. The print head becomes very hot during and immediately after use. DO NOT touch it directly with your hands.







! WARNING

	DO NOT operate, charge, or store the machine in the following locations (otherwise leaking, fire, electrical shock, or damage may occur):
	<ul style="list-style-type: none"> ■ Near water, such as in a bathroom or near a water heater, or in an extremely humid or cold location
	<ul style="list-style-type: none"> ■ In a location where it is exposed to rain or moisture
	<ul style="list-style-type: none"> ■ In an extremely dusty location
	<ul style="list-style-type: none"> ■ In an extremely hot location, such as near open flames, heaters, or in direct sunlight
	<ul style="list-style-type: none"> ■ In a closed car under a hot sun
	<ul style="list-style-type: none"> ■ In a location where condensation may form
	<ul style="list-style-type: none"> ■ At a high altitude
	DO NOT try to disassemble or alter the machine, otherwise a fire, electrical shock, or damage may occur. For servicing, adjustments or repairs, contact your Brother dealer. (The warranty does not cover repairs for damage resulting from disassembly or alterations performed by the user.)
	
	
	If the machine operates abnormally (for example, if it produces smoke, unusual odour, or noise), stop using it, otherwise a fire, electrical shock, or damage may occur. Immediately turn the machine off, disconnect the AC adapter from the electrical socket, and then contact your Brother dealer for repairs.
	
	
	
	To prevent damage, do not drop or hit the machine.
	DO NOT use the machine with a foreign object in it. If water, a metal object, or any other foreign object enters the machine, disconnect the AC adapter and remove the battery, and then contact your Brother dealer for repairs.
	DO NOT use the machine in special environments, such as near medical equipment. Electromagnetic waves may cause the medical equipment to malfunction.
	DO NOT allow babies and children to play with the plastic bag that contained the machine. Dispose of the bag or keep it away from babies and children. There is a risk of suffocation.
	Users with heart pacemakers must move away from the machine if they sense any abnormalities. Then, immediately seek the advice of a medical professional.
	When transporting the machine, be sure to carry it by its handle. Lifting the machine by any other part may damage the machine or result in the machine falling, which could cause injuries.



WARNING

AC adapter (AD9100ESA)

Follow these guidelines to avoid fire, damage, electrical shock, failure or the risk of injury.



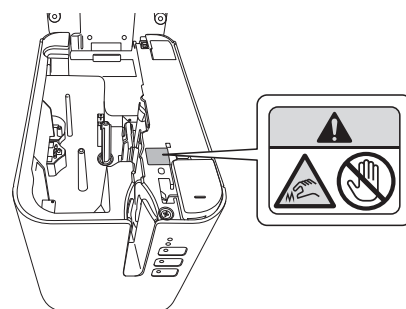
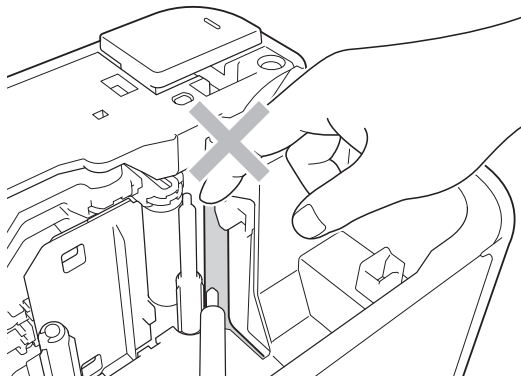

- | | |
|---|---|
|  | <ul style="list-style-type: none">■ Make sure you insert the plug fully into the electrical socket. DO NOT use a socket that is loose.■ Use only the AC adapter, power cord and USB cable designed exclusively for your machine. Failure to do so may result in an injury to yourself or others, or damage to the machine or other property. Brother does not assume any responsibility for any accident or damage resulting from not using the specified AC adapter, power cord and USB cable. |
|  | <ul style="list-style-type: none">■ DO NOT connect the enclosed AC adapter, power cord and USB cable to other products.■ DO NOT use the AC adapter in places with high humidity or moisture, such as bathrooms.■ DO NOT use a damaged power cord or plug.■ DO NOT place heavy objects on, damage, or modify the power cord or plug. DO NOT forcibly bend or pull the adapter cord.■ DO NOT drop, hit, or otherwise damage the AC adapter. |
|  | <p>DO NOT touch the AC adapter and the machine during a thunderstorm.</p> <p>There may be a remote risk of electrical shock from lightning when the machine is used during a thunderstorm.</p> |
| 
 | <p>DO NOT touch the AC adapter, power cord or plug with wet hands, otherwise an electrical shock may occur.</p> |

Cutter

- | | |
|---|--|
|  | <p>Hazardous Sharp blade</p> <p>Keep fingers and other body parts away</p> |
|  | <p>DO NOT touch the blade of the tape cutter unit, otherwise fingers and other body parts may be injured.</p> |



⚠ CAUTION

Machine	
	<ul style="list-style-type: none"> ■ Store the machine on a flat, stable surface, such as a desk or in a drawer. ■ Always use the suggested AC adapter (AD9100ESA) for the machine and plug it into a socket with the specified voltage. Failure to do so could result in damage or failure of the machine. ■ If you notice heat, an abnormal odour, discolouration of the machine, deformation, or anything else unusual while using or storing the machine, immediately discontinue the use of the machine, disconnect the AC adapter (AD9100ESA), and remove the battery.
	<ul style="list-style-type: none"> ■ DO NOT leave the machine or any tape within the reach of young children. ■ DO NOT place any heavy objects on top of the machine. ■ DO NOT use the machine in places with high humidity or moisture, such as bathrooms. ■ DO NOT allow the machine to get wet, for example, by handling it with wet hands or spilling beverages onto it. ■ DO NOT disassemble or modify the machine.
AC adapter (AD9100ESA)	
	<ul style="list-style-type: none"> ■ If you do not intend to use the machine for an extended period of time, disconnect the power cord from the electrical socket. ■ When disconnecting the power cord from the electrical socket, always hold the plug.
	<ul style="list-style-type: none"> ■ DO NOT overload an electrical circuit with the power cord. ■ DO NOT disassemble or modify the AC adapter. ■ DO NOT allow the AC adapter / power cord / plug to get wet, for example, by handling them with wet hands or spilling beverages onto them.
Cutter	
Follow these guidelines to avoid minor personal injury and damage to the machine.	
	<ul style="list-style-type: none"> ■ DO NOT open the tape compartment cover when operating the cutter unit. ■ DO NOT apply excessive pressure to the cutter unit.

General Precautions

Rechargeable Li-ion battery (Optional)	
<ul style="list-style-type: none"> ■ At the time of purchase, the rechargeable battery is slightly charged so that the operation of the machine can be verified; however, before you use the machine for the first time, you must fully charge the battery using the AC adapter. ■ If the machine will not be used for a long period of time, remove the rechargeable battery from the machine, and then store it in a location where it is not exposed to static electricity, high humidity, or high temperatures (temperatures between 15 and 25 °C and humidity between 40 and 60% are recommended). To maintain the efficiency and life of the rechargeable battery, charge it at least every six months. ■ If you notice anything unusual about the rechargeable battery the first time it is used, for example overheating or rust, STOP using the battery. Contact Brother customer service. 	

General Precautions

Machine

- DO NOT transport the machine while cables are connected to the AC connector and USB port. The connector and ports could be damaged.
- DO NOT install the machine near any device that will cause electromagnetic interference. The machine may malfunction if left near a device, such as a television, radio, or microwave oven.
- DO NOT use the machine in any way or for any purpose not described in this guide. Doing so may result in injury or damage to the machine.
- DO NOT put any foreign objects into the tape exit slot, AC adapter socket, or any other part of the machine.
- DO NOT touch the print head (see page 4) with your fingers. Use the optional print head cleaning cassette (TZe-CL6) or a soft wipe (e.g. a cotton swab) when cleaning the print head (see the *User's Guide*).
- DO NOT clean any part of the machine with alcohol or other organic solvents. Use only a soft, dry cloth.
- DO NOT place the machine in direct sunlight, near heaters or other hot appliances, or in any location exposed to extremely high or low temperatures, high humidity, or dust. The standard operating temperature range of the machine is between 10 and 35 °C for labels.
- DO NOT leave any rubber or vinyl, or products made of rubber or vinyl, on the machine for an extended period of time, otherwise the machine may become marked.
- Depending on the environmental conditions and the applied settings, some characters or symbols may be difficult to read.
- Use Brother TZe tapes, FLe labels and HSe tubes with the machine.
- DO NOT pull or apply pressure to the tape in the cassette to avoid damaging the machine.
- DO NOT try to print labels using an empty tape cassette or without a tape cassette in the machine. Doing so will damage the print head.
- DO NOT attempt to cut the tape while printing or feeding since this will damage the tape.
- Depending on the location, material, and environmental conditions, the label may unpeel or become irremovable, and the colour of the label may change or be transferred to other objects.
- DO NOT expose the tape cassettes to direct sunlight, high temperatures, high humidity, or dust. Store tape cassettes in a cool, dark place. Use the tape cassettes soon after opening the tape cassette package.
- Markings made with oil-based or water-based ink may be visible through a label affixed over them. To hide the markings, use two labels layered on top of each other or use a dark-coloured label.
- Any data stored in the P-touch labelling machine memory will be lost:
 - if the machine fails
 - if the battery expires
 - following a repair

General Precautions

Machine

- A protective clear plastic sticker is placed over the display during manufacturing and shipping. Remove this sticker prior to use.
- The length of the printed label may differ from the displayed label length.
- You can also use Heat Shrink Tube in this model.

Check the Brother website (www.brother.com) for further information. You cannot print frames or pre-set machine templates, or use certain font settings when using Heat Shrink Tube. Printed characters may also be smaller than when using TZe tape or FLe tape.

- The printed label may differ from the image that appears on the LCD (Optional: TDU).
- Note that Brother Industries, Ltd. does not assume responsibility for any damage or injury arising from the failure to follow the precautions listed in this guide.
- We strongly recommend reading this guide carefully before using your machine, and then keeping it nearby for future reference.

Warning label



The following warning labels appear on the machine. Fully understand the contents of each warning label and perform operations while observing the precautions that are described. In addition, be very careful that the warning labels do not peel off and are not scratched.

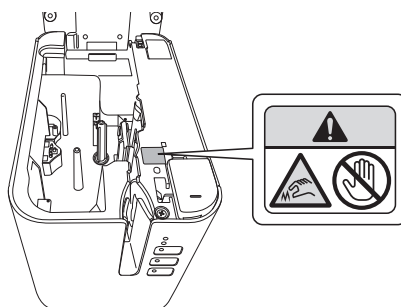

Rating label

- For information about your model's electrical rating, see the label attached to the base of your printer.
- Be careful that when the battery base (PA-BB-002) is installed on your printer, the rating label which is attached to the base is the battery base's one.

LAN Connection (For P950NW Only)

Caution: Connect this product to the LAN connection that is not subjected to overvoltages.

Compilation and Publication Notice

Under the supervision of Brother Industries, Ltd., this guide has been compiled and published covering the latest product's descriptions and specifications.

The contents of this guide and the specifications of this product are subject to change without notice.

If new versions of the machine operating system becomes available, this guide may not reflect the updated features.

Therefore, you may find that the operating system described in this guide may differ from new operating systems.

Brother reserves the right to make changes without notice in the specifications and materials contained herein and shall not be responsible for any damages (including consequential) caused by reliance on the materials presented, including but not limited to typographical and other errors relating to the publication.

Trademarks

Microsoft, Windows, Windows Vista and Windows Server are registered trademarks of Microsoft Corporation in the United States and other countries.

Apple, Macintosh, Mac OS, Safari, iPad, iPhone, iPod touch and OS X are trademarks of Apple Inc., registered in the United States and other countries.

Google Play is a trademark of Google Inc.

Wi-Fi and Wi-Fi Alliance are registered trademarks of the Wi-Fi Alliance.

WPA, WPA2, Wi-Fi Protected Setup, Wi-Fi Protected Setup logo and Wi-Fi Direct are trademarks of the Wi-Fi Alliance.

The Bluetooth word mark and logos are owned by the Bluetooth SIG, Inc. and any use of such marks by Brother Industries, Ltd. under licence.

Blue SDK

Copyright © 1995-2015 OpenSynergy GmbH.

All rights reserved. All unpublished rights reserved.

Android is a trademark of Google Inc.

Adobe and Reader are either registered trademarks of Adobe Systems Incorporated in the United States and/or other countries.

QR Code is a registered trademark of DENSO WAVE INCORPORATED in JAPAN and other countries. QR Code Generating Program Copyright © 2008 DENSO WAVE INCORPORATED.

BarStar Pro Encode Library (DataMatrix, MaxiCode, PDF417, POSTNET, AztecCode, GS1 DataBar Composite) Copyright © 2007 AINIX Corporation. All rights reserved.

Epson ESC/P is a registered trademark of Seiko Epson Corporation.

Each owner whose software title is mentioned in this document has a Software Licence Agreement specific to its proprietary programs.

Any trade names and product names of companies appearing on Brother products, related documents and any other materials are all trademarks or registered trademarks of those respective companies.

Open Source Licensing Remarks

This product includes open-source software.

To see the open source licensing remarks, please go to the manual download selection on your model's home page of Brother support website at support.brother.com

Regulation for P900W/P950NW

CAUTION

RISK OF EXPLOSION IF BATTERY IS REPLACED WITH AN INCORRECT TYPE.
DISPOSE OF USED BATTERIES ACCORDING TO THE INSTRUCTIONS.

Declaration of Conformity (Europe/Turkey only)

We, Brother Industries, Ltd.
15-1, Naeshiro-cho, Mizuho-ku,
Nagoya 467-8561 Japan

declare that this product and AC adapter are in conformity with the essential requirements of all relevant directives and regulations applied within the European Community.

The Declaration of Conformity (DoC) can be downloaded from the Brother support website.

Visit support.brother.com and:

- select "Europe"
- select your country
- select "Manuals"
- select your model
- select "Declaration of Conformity"
- click "Download"

Your Declaration will be downloaded as a PDF file.

Declaration of Conformity for RE Directive 2014/53/EU (Europe/Turkey only) (Applicable to models with radio interfaces)

We, Brother Industries, Ltd.
15-1, Naeshiro-cho, Mizuho-ku,
Nagoya 467-8561 Japan

declare that these products are in conformity with the provisions of the RE Directive 2014/53/EU. A copy of the Declaration of Conformity can be downloaded by following the instructions in the Declaration of Conformity section.

Rechargeable Li-ion Battery Specifications (Optional)

- Charging time: Approximately 3 hours when charged using an AC adapter (AD9100ESA)
- Nominal Voltage: DC 14.4 V
- Nominal Capacity: 1800 mAh

Rechargeable Li-ion Battery

Surrounding Temperature Range		
Charge		40 °C
Standard discharge current 0.9 A		60 °C
Maximum discharge current 5.0 A		40 °C
Shipped battery	Less than 1 month	between -20 and 50 °C
	Less than 3 months	between -20 and 40 °C
	Less than 1 year	between -20 and 20 °C

Charging Parameters	
Maximum charging voltage	DC 16.4 V
Maximum charging current	1260 mA

Machine

- Charging current: 1000 mA (Maximum)
- Charging voltage: DC 16.4 V (Maximum)



Information for compliance with Commission Regulation 801/2013

	P900W	P950NW
Power consumption*	1.4 W	2.0 W

* All network ports activated and connected

How to enable/disable Wireless LAN

To activate the wireless function:

Press and hold the  (Power) button to turn the machine on, and then press and hold the  (Wi-Fi) button for one second.

To deactivate the wireless function:

Press and hold the  (Wi-Fi) button again to turn the wireless function off.

Wireless LAN







This machine supports Wireless LAN.

Frequency bands: 2400 - 2483.5 MHz.

Maximum radio-frequency power transmitted in the frequency bands: Less than 20 dBm (EIRP).

How to enable/disable Bluetooth

To enable Bluetooth:

- 1 Connect the optional Bluetooth interface (PA-BI-002) to the machine.
- 2 Turn the Bluetooth interface on.
- 3 While pressing and holding the  (Wi-Fi) button on the machine, press and hold the  (Power) button until the  (Power) indicator lights in green and the  (Status) indicator lights in orange.
- 4 Press and hold the  (Feed&Cut) button for more than five seconds until the  (Status) indicator blinks in green.
- 5 If the machine was automatically turned off, turn it on again.
- 6 Confirm the indicator on the Bluetooth interface lights in green.

To disable Bluetooth:

- 1 Press and hold the  (Feed&Cut) button for more than five seconds.
- 2 Turn the Bluetooth interface off.

brother



D018KG001