



PT-E800W
Quick Setup Guide

English

Thank you for purchasing the P-touch labeling system model PT-E800W. Your new PT-E800W is an intuitive, easy to operate and feature-rich P-touch labeling system that produces professionally looking, high-quality labels. This manual contains basic procedures for using your P-touch labeling system. Read the whole guide before using your product and keep it for later reference. The available options and supplies may vary depending on the country.

To download and install printer drivers and software, visit our website.
www.brother.com/inst
For more information on installing the driver and software, see *Create a Label using a Computer*.

Available Manuals

- **Product Safety Guide**
This guide provides safety information; read it before you use your P-touch labeling system.
- **Quick Setup Guide (this guide)**
This guide provides basic information about using your P-touch labeling system along with detailed troubleshooting tips.
- **User's Guide**
When you download the installer from www.brother.com/inst and install it, the "Brother Manual" folder is created on your computer's desktop and this manual is stored in this folder. This guide provides additional information about your P-touch labeling system's settings and operations, troubleshooting tips, and maintenance instructions. In addition, you can download individual manuals that you need from the Brother support website. Visit the Brother support website at support.brother.com and click **Manuals** on your model page to download the other manuals.

Unpacking Your P-touch Labeling system

Before using your P-touch labeling system, check that the package contains the following:

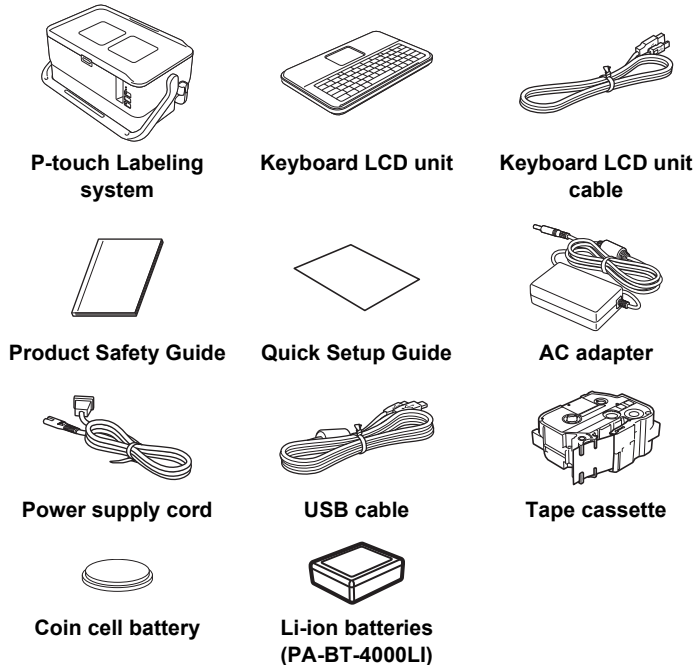

The components included in the box may differ depending on your country.

General Description

Front

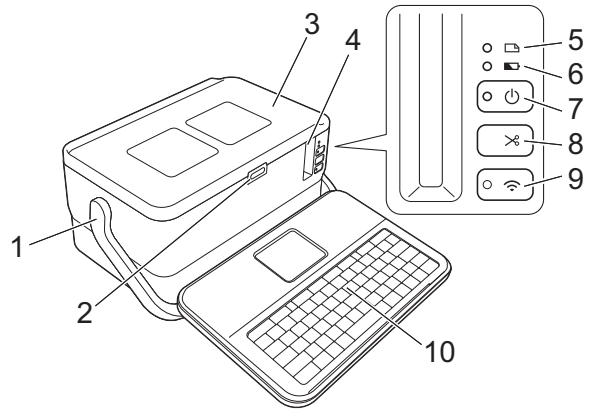

Back

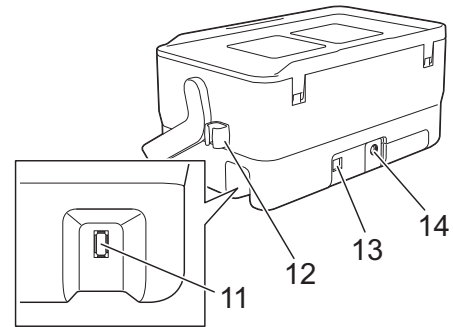

- | | |
|-------------------------|--|
| 1 Handle | 9 Wi-Fi (Wi-Fi) button |
| 2 Cover open button | 10 Keyboard LCD unit |
| 3 Top cover | 11 Keyboard LCD unit interface outlet |
| 4 Tape exit slot | 12 Cable holder (holder for the keyboard LCD unit cable) |
| 5 (Label) indicator | 13 USB port |
| 6 (Battery) indicator | 14 AC adapter outlet |
| 7 (Power) button | |
| 8 (Feed and Cut) button | |

Inside

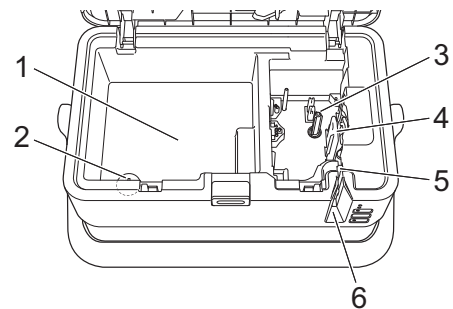

- | | |
|---|-----------------------------|
| 1 Accessory storage compartment
Use this space to store TZe tape cassettes and the AC adapter. | 2 Coin cell battery holder |
| | 3 Tape cassette compartment |
| | 4 Print head |
| | 5 Tape cutter unit |
| | 6 Tape exit slot |

Attaching the Keyboard LCD Unit

1. Slide the cover on the bottom of the keyboard LCD unit to remove it, and then connect the keyboard LCD unit cable. Install the cover.

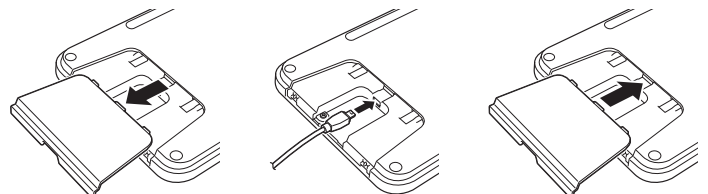

2. Connect the USB cable on the keyboard LCD unit to the outlet on the side of the P-touch labeling system.

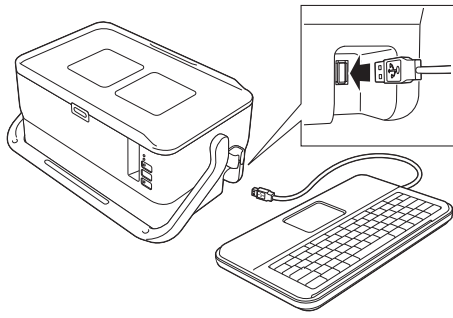

NOTE

- When you turn on the P-touch labeling system, the keyboard LCD unit is also turned on.
- The keyboard LCD unit can be installed on the P-touch labeling system by sliding it on the top cover. When storing the keyboard LCD unit, turn it upside down and install it to the top cover to prevent it from becoming dusty or dirty.
- You can place the excess cable in the cable holder.

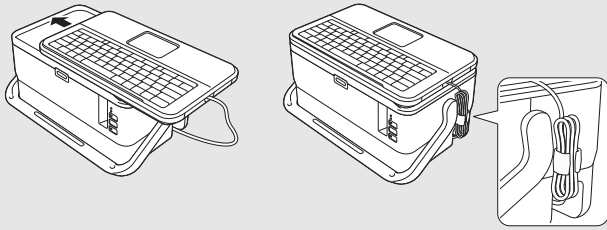

4. Install the battery.

IMPORTANT

Be sure to insert the new battery with the + and – sides facing the correct direction.

5. Return the coin cell battery cover to its original position. To install the coin cell battery cover, use a coin or similar object to slowly turn the coin cell battery cover in the opposite direction of the arrow on the battery cover until it stops.

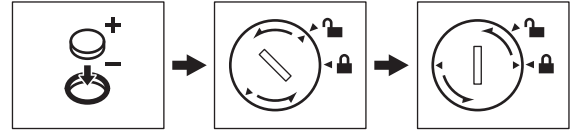

For more information, see the *User's Guide*.

Connecting the Power Supply

AC Adapter

Use the AD9100ESA (AC adapter) for this P-touch labeling system. Connect the AC adapter directly to the P-touch labeling system.

1. Insert the plug on the AC adapter cord into the AC adapter outlet marked DC IN 24 V on the P-touch labeling system.
2. Insert the plug on the power supply cord into the AC adapter.

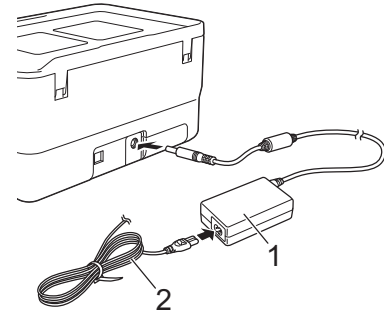

- 1 AC adapter
- 2 Power supply cord

3. Insert the power supply plug into a standard AC power outlet.

IMPORTANT

- Turn off the P-touch labeling system before disconnecting the AC adapter.
- Do not pull or bend the AC adapter cord and power supply cord.
- After the power supply plug is inserted into the AC power outlet, it may take a few seconds until the ⏻ (Power) button is enabled.

NOTE

To safeguard and back up the P-touch labeling system memory, when the power supply is unplugged it is recommended to leave the rechargeable Li-ion batteries (PA-BT-4000LI) installed in the P-touch labeling system.

Installing the Coin Cell Battery

A coin cell battery is used as a backup power supply to maintain the settings for the internal clock of the keyboard LCD unit. The battery will be consumed even if the P-touch labeling system is not used for a long period of time.

IMPORTANT

- When storing or discarding the battery, wrap it (for example with cellophane tape) to prevent it from short-circuiting.

(Battery insulation example)

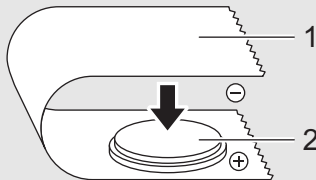

- 1 Cellophane tape
- 2 Coin cell battery

- We recommend replacing the battery every two years.
- Dispose of the batteries at an appropriate collection point, not in the general waste stream. In addition, be sure to observe all applicable federal, state, and local regulations.

1. Make sure your P-touch labeling system is turned off.
2. Press the cover open button to open the top cover.
3. Using a coin or similar object, slowly turn the coin cell battery cover in the direction of the arrow on the battery cover until it stops, and then remove the coin cell battery cover.

IMPORTANT

If the coin cell battery cover is forcibly turned past the stop position, it may become damaged.

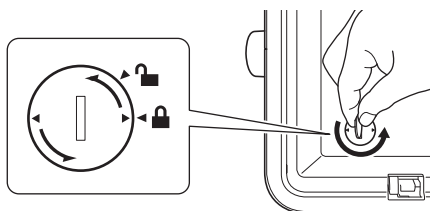

Using the Rechargeable Li-ion Battery

■ Installing the Rechargeable Li-ion Battery

1. Press and hold the ⏻ (Power) button to turn off your P-touch labeling system.
2. Open the battery cover on the bottom of the P-touch labeling system.
3. Insert the battery into the battery compartment.
4. Close the battery cover.

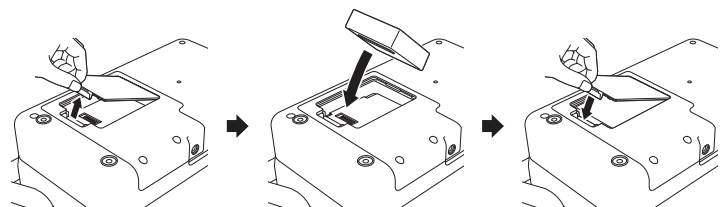



■ Removing the Rechargeable Li-ion Battery

Press and hold the  (Power) button to turn off the P-touch labeling system. Remove the battery cover and the battery, and then reattach the battery cover.

■ Charging the Rechargeable Li-ion Battery

NOTE

- Before use, fully charge the battery.
- Up to three hours may be needed to fully charge the battery.

1. Make sure the battery is installed in the P-touch labeling system.
2. Use the AC adapter and power supply cord to connect the P-touch labeling system to an AC power outlet.
Press the  (Power) button to turn on the P-touch labeling system if it is not on already.
The  (Battery) indicator lights in orange during charging, and it goes off when the battery is fully charged.

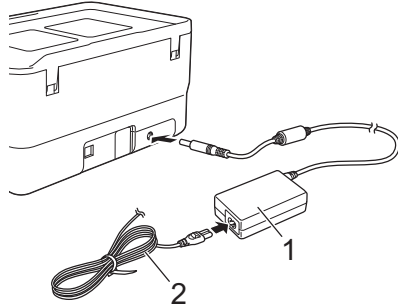

- 1 AC adapter
- 2 Power supply cord



NOTE

Although the charging stops if the P-touch labeling system is used to print, feed, or perform another operation, the charging will start again automatically after the operation is finished if the charging is not completed.

■ Stopping Rechargeable Li-ion Battery Charging

To stop the battery charging, disconnect the AC adapter.

Notes on Using the Rechargeable Li-ion Battery

- Before use, fully charge the battery. Do not use it before it is fully charged.
- The battery charging must take place in environments between 32°F and 104°F (0°C and 40°C), otherwise the battery will not charge, and the  (Battery) indicator will remain lit. If the charging stops because the environment temperature is too low or too high, place the P-touch labeling system with a temperature between 32°F and 104°F (0°C and 40°C) and try charging again.
- If the P-touch labeling system is used to print, feed, or perform another operation when both the battery is installed and the AC adapter is connected, the  (Battery) indicator may turn off and charging may stop even if the battery is not fully charged.

Rechargeable Li-ion Battery Characteristics

To ensure the highest performance and longest life from the battery:

- Do not use or store the battery in a location exposed to extreme high or low temperatures as it may discharge more quickly. This may happen when using a rechargeable Li-ion battery with a high charge (90% charged or more) in a location exposed to high temperatures.
- Remove the battery when storing the P-touch labeling system for long periods of time.
- Store a battery with less than a 50% charge in a cool dry place out of direct sunlight.
- Recharge the battery every six months if it is stored for long periods of time.
- If you touch a part of the P-touch labeling system while the Li-ion battery is charging, that part of the P-touch labeling system may feel warm. This is normal, and the P-touch labeling system may be used safely. However, if the P-touch labeling system becomes extremely hot, discontinue use.

Inserting a Tape Cassette

The TZe tape, FLe label, HGe tape and HSe tube cassettes can be used in your P-touch labeling system.

IMPORTANT

If the new tape cassette has a cardboard stopper, be sure to remove the stopper before inserting the cassette.

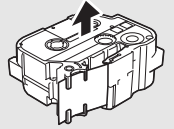

1. Check that the end of the tape is not bent and that it passes through the tape guides. If it does not, pass it through the tape guides as shown in the illustration.

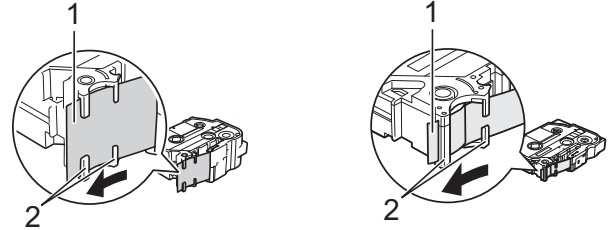

- 1 End of tape
- 2 Tape guides (The actual shape may be different depending on the tape width.)

2. Press the cover open button to open the top cover.
3. Carefully insert the tape cassette into the tape cassette compartment with the end of the tape facing the P-touch labeling system's tape exit slot, then push down evenly until the tape cassette is installed correctly.

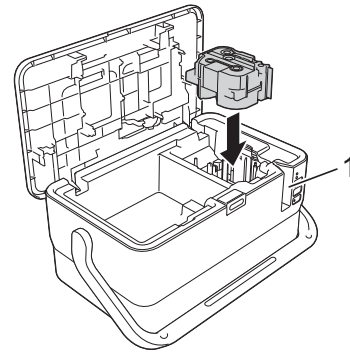

1 Tape exit slot

IMPORTANT

- When inserting the tape cassette, make sure that the tape and ink ribbon do not catch on the print head.
- Make sure that there is no slack in the tape. Otherwise the tape may catch on the protrusion (2) and become bent or wrinkled, causing the tape to jam.
To fix the slack in the tape, refer to the illustration in step 1 and pull the tape outside of the tape guide.
- When removing the tape cassette, make sure that the tape does not catch on the protrusion (2).

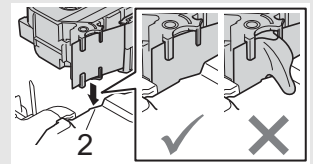



4. Close the top cover.



IMPORTANT



Store tape cassettes in a cool dark location, away from direct sunlight and high temperature, high humidity, or dusty locations. After opening the sealed package, use the tape cassette as quickly as possible.

Turning Power On/Off

On: Press the  (Power) button to turn on the P-touch labeling system. The  (Power) indicator lights in green.

NOTE

When the P-touch labeling system is turned on for the first time, the language selection screen appears. Select the language you want using the  or  key. The language setting can also be changed later. (See *Setting Language and Unit.*)

Off: Press and hold the  (Power) button again to turn off the P-touch labeling system. The  (Power) indicator may light in orange until the power is off.

IMPORTANT

When turning off the P-touch labeling system, do NOT remove the battery or disconnect the AC adapter until the  (Power) indicator turns off.

Keyboard LCD Unit Description

Key Names and Functions

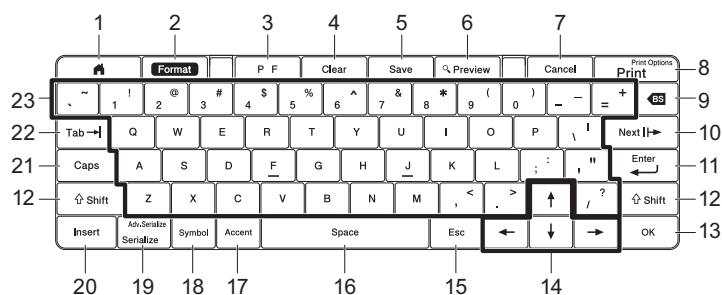

- 1 **Home**
Returns to the Home screen to select a menu.
- 2 **Format**
Sets characters and attributes.
- 3 **PF (Programmable Function)**
Select programmable function.
- 4 **Clear**
Clears all text entered, or all text and current settings.
- 5 **Save**
Saves the created data in the file memory.
- 6 **Preview**
Displays an image of the label that will be printed in the set layout.
- 7 **Cancel**
Deletes the print job.
- 8 **Print/Print Option**
 - Prints the current data onto the tape.
 - Prints multiple copies or changes the print settings when used in combination with the **Shift** key.
- 9 **BS (Backspace)**
Deletes the character to the left of the cursor.
- 10 **Next**
Creates the next page.
- 11 **Enter**
Adds a new line when entering text.
Selects the displayed option.
- 12 **Shift**
Enters upper-case letters or symbols when used in combination with the letter keys or number keys.
- 13 **OK**
Selects the displayed option.
- 14 **Cursor (↑ ↓ ← →)**
Moves the cursor in the direction of the arrow.
- 15 **Esc (Escape)**
Cancels the current command and returns the display to the data entry screen or the previous step.
- 16 **Space**
 - Inserts a blank space.
 - Returns a setting to the default value.
- 17 **Accent**
Selects and enters an accented character.
- 18 **Symbol**
Selects and enters a symbol from a list of available symbols.
- 19 **Serialize/Adv.Serialize**
Sets serialized numbers.
- 20 **Insert**
Inserts a time stamp, barcode, database, or transferred symbol.
- 21 **Caps**
Turns the Caps mode on and off.
- 22 **Tab**
Inserts a tab.

23 Letter



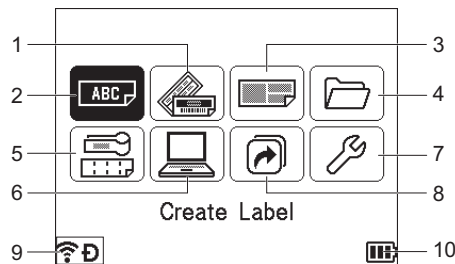

- Enters letters or numbers.
- Enters upper-case letters or symbols when used in combination with the **Caps** or **Shift** key.

LCD

■ Home Screen







- 1 **Auto Format (Templates)**
Specifies the label format from the preset templates.
- 2 **Create Label**
Displays the label creation screen.
- 3 **Auto Format (Block Layouts)**
Specifies the label format from the preset layouts.
- 4 **File**
Retrieves data that is saved in the file memory.
- 5 **Cable Label**
Specifies the label type from the following seven types: Faceplate/Cable Wrap/Cable Flag/Patch Panel/Punch-Down Block/Die-cut Flag/Inverted Label.
- 6 **Transferred Templates**
Retrieves data that was transferred from a computer.
- 7 **Settings**
Specifies various settings for the P-touch labeling system.
- 8 **Register Programmable Function**
Registers, deletes, and renames programs.
- 9 **Wireless Connection**
The left icon indicates the status of the Wi-Fi® connection and the right icon indicates the status of the Wireless Direct connection.

	Connected in Wi-Fi mode
	Disconnected in Wi-Fi mode
	Wireless direct mode ON
	Connecting using the Setup Wizard
(Off)	Wireless connection OFF

10 Battery Level

Indicates the remaining battery level. It appears only when using the Li-ion battery.

-  - Full
-  - Low
-  - Charging
-  - Half
-  - Empty

Label Creation Screen



- 1 Caps mode**
Indicates that the Caps mode is on.
- 2-8 Style Guidance**
Indicates the current font (2), character size (3), character width (4), character style (5), line (6), frame (7), and alignment (8) settings.
- 9 Layout Guidance**
Indicates the orientation, layout, separator, reverse, and repeated text settings. The displayed items vary according to the selected label type.
- 10 Block Number**
Indicates the block number.
- 11 Line Number**
Indicates the line number within the label layout.
- 12 Page Separator Line**
Indicates the end of one page and the beginning of the next page.
- 13 Block Separator Line**
Indicates the end of a block.
- 14 Enter/Return Symbol**
Indicates the end of a line of text.
- 15 Cursor**
Indicates the current data input position. Characters are entered to the left of the cursor.
- 16 Wireless Connection**
Indicates the current status of the wireless connection. See *Wireless Connection* in the Home Screen section.
- 17 Tab Length Setting**
Indicates the set tab length.
- 18 Tape Size**
Indicates the tape size as follows for the text entered: Tape width × Label length. If the label length has been specified, also appears on the right side of the tape size.
- 19 Battery Level**
Indicates the remaining battery level. It appears only when using the Li-ion battery. See *Battery Level* in the Home Screen section.

Feeding Tape

IMPORTANT

- Be sure to feed tape to remove any slack in the tape and ink ribbon after inserting the tape cassette.
- **Do not pull the label when the P-touch labeling system is ejecting it from the tape exit slot.** Doing so will cause the ink ribbon to be discharged with the tape. The tape may no longer be functional after the ink ribbon discharges.
- Do not block the tape exit slot during printing or when feeding tape. Doing so will cause the tape to jam.

Feed and Cut

The Feed and Cut function feeds approximately 22.3 mm of blank tape, and then cuts the tape.

1. Press the (Feed and Cut) button.
[Feed & Cut?] appears on the LCD.
2. Select [Feed & Cut] using the \uparrow or \downarrow key, and then press the **OK** or **Enter** key. The message [Feeding Tape... Please Wait] appears while the tape is fed, and then the tape is cut.

NOTE

To exit or cancel this function press the **Esc** key.

Feed Only

This function ejects the tape approximately 22.3 mm, resulting in a blank label sticking out of the tape cassette. This action is recommended when using Fabric tapes, which should be cut with scissors.

1. Press the (Feed Only) button.
[Feed & Cut?] appears on the LCD.
2. Select [Feed Only] using the \uparrow or \downarrow key, and then press the **OK** or **Enter** key. The message [Feeding Tape... Please Wait] appears while the tape is fed.

NOTE

To exit or cancel this function press the **Esc** key.

Setting Language and Unit

Language

1. Select [Settings] in the Home screen using the \uparrow , \downarrow , \leftarrow or \rightarrow key, and then press the **OK** or **Enter** key.
2. Select [\checkmark Language] using the \uparrow or \downarrow key, and then press the **OK** or **Enter** key.
3. Select a language for menu commands and messages shown on the LCD using the \uparrow or \downarrow key.

The following languages are available: [Čeština], [Dansk], [Deutsch], [English], [Español], [Français], [Hrvatski], [Italiano], [Magyar], [Nederlands], [Norsk], [Polski], [Português], [Português (Brasil)], [Română], [Slovenski], [Slovenský], [Suomi], [Svenska], and [Türkçe].

4. Press the **OK** or **Enter** key.

NOTE

To return to the previous step, press the **Esc** key.

Unit

1. Select [Settings] in the Home screen using the \uparrow , \downarrow , \leftarrow or \rightarrow key, and then press the **OK** or **Enter** key.
2. Select [Unit] using the \uparrow or \downarrow key, and then press the **OK** or **Enter** key.
3. Select a unit for dimensions shown on the LCD using the \uparrow or \downarrow key. Either [inch] or [mm] can be selected.
4. Press the **OK** or **Enter** key.

NOTE

The default setting is [inch].

To return to the previous step, press the **Esc** key.

Adjusting the LCD Settings

LCD Contrast

You can change the contrast setting of the LCD to one of five levels (+2, +1, 0, -1, or -2) to make the screen easier to read. The default setting is "0".

1. Select [Settings] in the Home screen using the \uparrow , \downarrow , \leftarrow or \rightarrow key, and then press the **OK** or **Enter** key.
2. Select [LCD Contrast] using the \uparrow or \downarrow key, and then press the **OK** or **Enter** key.
3. Set the value using the \uparrow or \downarrow key, and then press the **OK** or **Enter** key.

NOTE

- To return to the previous step, press the **Esc** key.
- Pressing the **Space** key on the contrast setting screen sets the contrast to the default value of "0".

Backlight

You can change the backlight setting either to "On" or "Off". The display is easier to see with the backlight on. The default setting is "On".

1. Select [Settings] in the Home screen using the \uparrow , \downarrow , \leftarrow or \rightarrow key, and then press the **OK** or **Enter** key.
2. Select [Backlight] using the \uparrow or \downarrow key, and then press the **OK** or **Enter** key.
3. Select [On] or [Off] using the \uparrow or \downarrow key, and then press the **OK** or **Enter** key.



NOTE

- Power can be saved when the backlight is turned off.
- The backlight automatically turns off. Press any key to turn the backlight on again.

During printing, the backlight is turned off. The backlight turns on during data transmissions.



















LED Indicators

The indicators light and flash to indicate the your P-touch labeling system's status. The symbols used in this section explain the meaning of the different indicator colors and patterns:













-  = Indicator is lit
 -  = Indicator is flashing
 -  = Indicator can be off, lit or flashing in any color
 - (Off) = Indicator is off
- G** = Green
O = Orange
R = Red

Example: **G**- = Indicator is flashing in green













Label, Power indicator

 (Label)	 (Power)	Condition
(Off)		Power is turning off Top cover open
(Off)	G -  (1 time in 1 second)	Transferring data
		Now cooling
R - 	R - 	System error 1 System error 2 System error 3
G - 		Reset mode (when the mode is starting)
G ●		Reset mode (when the button is pressed 2/4/6 times)
		When blinking alternately: Cutter error
		When blinking simultaneously: High temperature error
R -  (1 time in 1 second)		Wrong media error
R -  (2 times in 1.8 seconds)	G ●	No cassette error Media end error
	G ●	Top cover open error when printing

Battery indicator

 (Battery)	 (Power)	Condition
(Off)		Rechargeable battery power: full
		Charging
 (1 time in 4 seconds)		Rechargeable battery power: half
 (2 times in 4 seconds)		Rechargeable battery power: low
R - 	R ●	Rechargeable battery error
R - 	G ●	Rechargeable battery power: empty
		Adapter connection/disconnection error

Wi-Fi indicator

 (Wi-Fi)	 (Power)	Condition
R ●		No available WPS access point was found
R -  (1 time in 1 second)		WPS access point connection error
R -  (2 times in 1.8 seconds)		Incorrect security settings
 (2 times in 1.8 seconds)		WPS access point search error
G - 		Wi-Fi on, not connected
G ●		Wi-Fi on, connected
(Off)		Wi-Fi off

Product Specifications

Model Name	PT-E800W
Size	
Dimensions	approx. 13.78" (W) x 7.40" (D) x 6.81" (H) (350 mm (W) x 188 mm (D) x 173 mm (H)) (including keyboard LCD unit)
Weight	approx. 7.50 lb (3.4 kg) (including keyboard LCD unit)
Printing	
Method	Thermal Transfer
Cassette	<ul style="list-style-type: none"> Brother TZe tape cassette: 0.13" (3.5 mm), 0.23" (6 mm), 0.35" (9 mm), 0.47" (12 mm), 0.70" (18 mm), 0.94" (24 mm), 1.4" (36 mm) Brother FLe label cassette: 0.82" (21 mm) x 1.77" (45 mm) Brother HSe tube cassette: 0.23" (5.8 mm), 0.34" (8.8 mm), 0.46" (11.7 mm), 0.69" (17.7 mm), 0.93" (23.6 mm) Brother HGe tape cassette: 0.23" (6 mm), 0.35" (9 mm), 0.47" (12 mm), 0.70" (18 mm), 0.94" (24 mm), 1.4" (36 mm)
Interface	
USB	Version 2.0 Full Speed
Wi-Fi	<ul style="list-style-type: none"> Wireless Direct: IEEE802.11n Ad-Hoc mode: IEEE802.11b Infrastructure mode: IEEE802.11b/g/n WPS 2.0
Environment	
Operating temperature/humidity	When running: between 50°F and 95°F (10°C and 35°C) / between 20% and 80% max. wet bulb temperature: 80.6°F (27°C)

Brother support website

Please visit our support website at support.brother.com.
You can find following information:

- Software downloads
- Manuals/Documents
- Frequently Asked Questions (Troubleshooting, Useful tips on using printer)
- Consumable information
- Latest OS compatibility information

The contents of this website are subject to change without notice.

Create a Label

You can use the P-touch labeling system's keyboard LCD unit to create and print data for labels. Because the P-touch labeling system is portable, it can be used as a single unit without worrying about the strength of the wireless signal or connecting to other devices, and can be used anytime and anywhere.

1. GETTING STARTED	Reference
Preparing the P-touch labeling system.	<i>Quick Setup Guide</i> (this guide)
2. CREATING A LABEL	Reference
The labels are created using the label creation screen. To open the label creation screen, select [Create Label] in the Home screen.	
Selecting an auto format. Selecting a label type.	<i>User's Guide</i>
Editing labels: <ul style="list-style-type: none"> • Entering and editing text. • Entering symbols, accented characters, time stamps, and serialized text. • Creating a barcode label. 	Note: In addition to entering text, the P-touch labeling system has a large range of formatting options.
3. LABEL PRINTING	Reference
Setting cut options.	<i>User's Guide</i>
Adjusting the label length.	Note: Before printing, you can check the layout of your label using the preview function.
Printing the label.	

Create a Label using a Mobile Device

Your P-touch labeling system can be used as a stand-alone P-touch labeling system, or it can be connected to a mobile device and used with the Brother applications to create labels and print directly from your mobile device. To print labels from your mobile device, install the Brother applications to your mobile device, and then connect your P-touch labeling system to your mobile device.

For more information about the mobile applications available for your printer, visit support.brother.com/g/d/f5f9.



■ Connecting Your P-touch labeling system to a Mobile Device

1. Turn on your P-touch labeling system, and then press and hold the (Wi-Fi) button until the (Wi-Fi) indicator is lit in green.
2. Turn on the Wi-Fi function on your Apple iPhone/iPad/iPod touch or Android™ device.
3. Start the application on your Apple iPhone/iPad/iPod touch or Android™ device, and then select your P-touch labeling system as the printer in the application.
Select "PT-E800W" or "DIRECT-*****_PT-E800W".
"*****" is the last five digits of the product serial number.
You can find the serial number label on the bottom of the P-touch labeling system.
When the password (network key) is required, type "00000000".

Create a Label using a Computer

NOTE

You must install P-touch software and the printer driver to use your P-touch labeling system with your computer.
Download the installer from www.brother.com/inst.

Your P-touch labeling system can be connected to a computer and used with the P-touch Editor or Cable Label Tool software to create more complex labels.

For more information, see the *User's Guide*.

Available Applications	Features	Computer	Connection
Cable Label Tool 	Create and print labels for cables, patch panels, faceplates, electrical equipment and more.	Windows	Wi-Fi / USB
P-touch Editor 	Design and print custom labels with built in drawing tools, text using different fonts and styles, imported graphic images and barcodes.	Windows / Mac	

Installing the Software and Printer Driver to a Computer

To print from your Windows computer or Mac, install the printer driver, P-touch Editor and other applications to your computer.

1. Visit our website (www.brother.com/inst) and download the installer for the software and manuals.
2. Double-click the downloaded .exe file and follow the on-screen instructions to proceed with the installation.

NOTE

To connect the P-touch labeling system to a computer using a wireless connection:

- We recommend configuring the wireless network settings while installing the software. You can change the settings later using [Settings] in the Home screen or the Printer Setting Tool. For more information, see the *User's Guide*.
- We recommend installing the software on a computer wirelessly connected to your network and configuring the P-touch labeling system using a USB cable.
- We recommend preparing the SSID (network name) and password (network key) of the wireless network in advance.
- If your wireless access point/router supports WPS, you can use one-push WPS (Wi-Fi Protected Setup) to quickly configure the wireless network settings.

3. Close the dialog box when the installation is complete.



Connecting the P-touch Labeling System to a Computer

You can connect the P-touch labeling system to a Windows computer or Mac using a USB cable, or wireless LAN. For more information, see the *User's Guide*.

■ Connecting Using USB

1. Connect the P-touch labeling system end of the USB cable to the USB port on the back of the P-touch labeling system.
2. Connect the other end of the USB cable to the USB port on the computer.
3. Turn on the P-touch labeling system.

■ Connecting Using Wi-Fi



1. Turn on the P-touch labeling system.
2. Press and hold the  (Wi-Fi) button on your P-touch labeling system for one second to turn the Wi-Fi function on. The  (Wi-Fi) indicator starts flashing in green once every three seconds.
 - Ad-Hoc Mode
For Windows, after installing the printer driver and other applications to your computer, set the Ad-Hoc mode using the Printer Setting Tool installed on the computer. (See the *User's Guide*.)
For Mac, set the Ad-Hoc mode using the Wireless Device Setup Wizard.

Troubleshooting





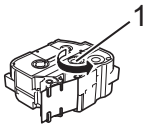

LCD Problems

Problem	Solution
The screen is locked, or the P-touch labeling system does not respond normally.	Reset the internal memory to the factory settings. For more information, see the <i>User's Guide</i> . If resetting the P-touch labeling system does not solve the problem, disconnect the AC adapter and remove the battery for more than 10 minutes.
The display remains blank after turning on the power. The POWER indicator does not light	The P-touch labeling system is receiving no power. If using AC power, connect the AC adapter correctly to the P-touch labeling system and an AC power outlet. If using a rechargeable Li-ion battery, make sure the rechargeable Li-ion battery is firmly installed in the P-touch labeling system and is fully charged. Check that the keyboard LCD unit cable is securely connected to the keyboard LCD unit and keyboard LCD unit interface of the P-touch labeling system.
The LCD messages are displayed in a foreign language.	See <i>Setting Language and Unit</i> in this guide to select the language you want.

Printing Problems

Problem	Solution
The label is not printed.	<ul style="list-style-type: none"> • Check that text has been entered and that the tape cassette is installed correctly with sufficient tape remaining. • If the tape is bent, cut off the bent section and thread the tape through the exit slot or tape guides. • When printing from a computer or mobile device, make sure the computer or mobile device is connected correctly to the P-touch labeling system.
The label is not printed correctly.	<ul style="list-style-type: none"> • Remove the tape cassette and reinstall it, pressing it firmly until it locks into place. • If the print head is dirty, clean it with a cotton swab or optional print head cleaning cassette (TZe-CL6).
The tape is jammed.	<ul style="list-style-type: none"> • If the tape is jammed, remove the tape cassette from the P-touch labeling system. • Check the tape cassette compartment and tape exit slot for tape scraps, jammed tape or debris that may prevent the tape from correctly exiting the machine. Remove if present. • Examine the tape cassette and cut away any damaged tape that is present past the tape guides on the tape cassette. • Check that the end of the tape is not bent and that it passes through the tape guides. For more information, see section <i>Inserting a Tape Cassette</i> of this guide. • Insert the tape cassette into the tape cassette compartment.
The ink ribbon is separated from the ink roller.	<p>If the ink ribbon is broken, replace the tape cassette. If not, leave the tape uncut and remove the tape cassette, then wind the loose ink ribbon onto the spool as shown in the figure.</p>  <p>1 Spool</p> <p>Note: Do not pull the label when the P-touch labeling system is ejecting it from the tape exit slot. Doing so will cause the ink ribbon to be pulled out with the tape. The tape may no longer be functional after the ink ribbon is pulled out.</p>
The P-touch labeling system stops while printing a label.	<ul style="list-style-type: none"> • Replace the tape cassette if striped tape is visible, as this indicates that you have reached the end of the tape. • Connect the AC adapter directly to the P-touch labeling system, or charge the rechargeable Li-ion battery.
The label is not cut automatically.	<p>Check the Cut Option setting. For more information, see the <i>User's Guide</i>.</p> <p>To cut labels manually, press the  (Feed and Cut) button to feed and cut the tape.</p>
A tape jam error cannot be cleared despite following the troubleshooting steps.	Contact Brother customer service.
I want to make fine adjustments to the print result.	The length and margins can be adjusted in the Printer Setting Tool. For more information, see <i>User's Guide</i> .

Version Information

Problem	Solution
I do not know the version number of the firmware of my P-touch labeling system.	<p>The version number and other information for the firmware can be confirmed using the following procedure:</p> <ol style="list-style-type: none"> 1. Select [Settings] in the Home screen using the , ,  or  key, and then press the OK or Enter key. 2. Select [Version Information] using the ,  key, and then press the OK or Enter key. <p>In addition, you can also use the following procedure.</p> <ol style="list-style-type: none"> 1. Turn on your P-touch labeling system. 2. Press and hold the  (Feed and Cut) button for more than 10 seconds to print the report. (Use 0.94" (24 mm) or 1.4" (36 mm) tape.) For more information, see the <i>User's Guide</i>.
I want to confirm whether I am using the latest version of the software.	Use the P-touch Update Software to confirm if you have the latest version. For more information, refer to the <i>User's Guide</i> .